



Full wwPDB X-ray Structure Validation Report ⓘ

Mar 20, 2024 – 04:24 PM EDT

PDB ID : 3KRD
Title : Crystal Structure of Mycobacterium Tuberculosis Proteasome in complex with Fellutamide B
Authors : Li, D.; Li, H.
Deposited on : 2009-11-18
Resolution : 2.50 Å (reported)

This is a Full wwPDB X-ray Structure Validation Report for a publicly released PDB entry.

We welcome your comments at validation@mail.wwpdb.org

A user guide is available at

<https://www.wwpdb.org/validation/2017/XrayValidationReportHelp>

with specific help available everywhere you see the ⓘ symbol.

The types of validation reports are described at

<http://www.wwpdb.org/validation/2017/FAQs#types>.

The following versions of software and data (see [references ⓘ](#)) were used in the production of this report:

MolProbity : 4.02b-467
Mogul : 1.8.5 (274361), CSD as541be (2020)
Xtriage (Phenix) : 1.13
EDS : 2.36
Percentile statistics : 20191225.v01 (using entries in the PDB archive December 25th 2019)
Refmac : 5.8.0158
CCP4 : 7.0.044 (Gargrove)
Ideal geometry (proteins) : Engh & Huber (2001)
Ideal geometry (DNA, RNA) : Parkinson et al. (1996)
Validation Pipeline (wwPDB-VP) : 2.36

1 Overall quality at a glance

The following experimental techniques were used to determine the structure:

X-RAY DIFFRACTION

The reported resolution of this entry is 2.50 Å.

Percentile scores (ranging between 0-100) for global validation metrics of the entry are shown in the following graphic. The table shows the number of entries on which the scores are based.

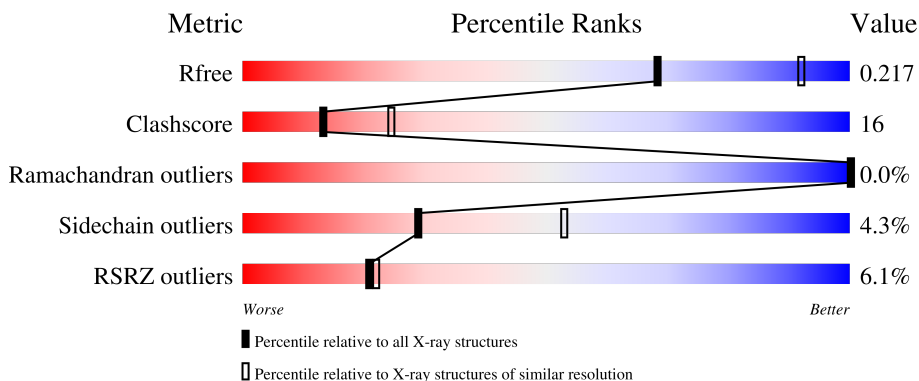

Metric	Whole archive (#Entries)	Similar resolution (#Entries, resolution range(Å))
R_{free}	130704	4661 (2.50-2.50)
Clashscore	141614	5346 (2.50-2.50)
Ramachandran outliers	138981	5231 (2.50-2.50)
Sidechain outliers	138945	5233 (2.50-2.50)
RSRZ outliers	127900	4559 (2.50-2.50)

The table below summarises the geometric issues observed across the polymeric chains and their fit to the electron density. The red, orange, yellow and green segments of the lower bar indicate the fraction of residues that contain outliers for ≥ 3 , 2, 1 and 0 types of geometric quality criteria respectively. A grey segment represents the fraction of residues that are not modelled. The numeric value for each fraction is indicated below the corresponding segment, with a dot representing fractions $\leq 5\%$. The upper red bar (where present) indicates the fraction of residues that have poor fit to the electron density. The numeric value is given above the bar.

Mol	Chain	Length	Quality of chain
1	1	248	
1	A	248	
1	B	248	
1	D	248	
1	F	248	

Continued on next page...

Continued from previous page...

Mol	Chain	Length	Quality of chain
1	I	248	8% 57% 28% 13%
1	K	248	7% 59% 26% 13%
1	M	248	8% 58% 26% 14%
1	O	248	9% 52% 30% 14%
1	Q	248	9% 48% 37% 14%
1	S	248	12% 50% 35% 13%
1	U	248	9% 57% 29% 14%
1	W	248	11% 48% 38% 13%
1	Y	248	15% 50% 35% 13%
2	2	240	0% 80% 12% 8%
2	C	240	2% 75% 18% 8%
2	E	240	0% 79% 13% 8%
2	G	240	0% 79% 13% 8%
2	H	240	0% 78% 14% 8%
2	J	240	0% 81% 11% 8%
2	L	240	0% 75% 16% 8%
2	N	240	2% 80% 12% 8%
2	P	240	0% 82% 10% 8%
2	R	240	0% 80% 14% 5%
2	T	240	0% 78% 13% 8%
2	V	240	0% 81% 14% 5%
2	X	240	2% 79% 13% 8%
2	Z	240	0% 78% 15% 8%
3	a	3	0% 67% 33%
3	b	3	0% 67% 33%

Continued on next page...

Continued from previous page...

Mol	Chain	Length	Quality of chain
3	c	3	 67% 33%
3	d	3	 67% 33%
3	e	3	 67% 33%
3	f	3	 67% 33%
3	g	3	 67% 33%
3	h	3	 67% 33%
3	i	3	 67% 33%
3	j	3	 67% 33%
3	k	3	 67% 33%
3	l	3	 67% 33%
3	m	3	 67% 33%
3	n	3	 67% 33%

2 Entry composition [i](#)

There are 5 unique types of molecules in this entry. The entry contains 48828 atoms, of which 0 are hydrogens and 0 are deuteriums.

In the tables below, the ZeroOcc column contains the number of atoms modelled with zero occupancy, the AltConf column contains the number of residues with at least one atom in alternate conformation and the Trace column contains the number of residues modelled with at most 2 atoms.

- Molecule 1 is a protein called Proteasome subunit alpha.

Mol	Chain	Residues	Atoms					ZeroOcc	AltConf	Trace
			Total	C	N	O	S			
1	A	214	Total 1650	C 1033	N 302	O 312	S 3	0	0	0
1	B	213	Total 1642	C 1027	N 301	O 311	S 3	0	0	0
1	D	213	Total 1646	C 1031	N 301	O 311	S 3	0	0	0
1	F	216	Total 1661	C 1040	N 304	O 314	S 3	0	0	0
1	I	215	Total 1654	C 1035	N 303	O 313	S 3	0	0	0
1	K	215	Total 1654	C 1035	N 303	O 313	S 3	0	0	0
1	M	214	Total 1650	C 1033	N 302	O 312	S 3	0	0	0
1	O	214	Total 1650	C 1033	N 302	O 312	S 3	0	0	0
1	Q	214	Total 1650	C 1033	N 302	O 312	S 3	0	0	0
1	S	215	Total 1657	C 1038	N 303	O 313	S 3	0	0	0
1	U	214	Total 1650	C 1033	N 302	O 312	S 3	0	0	0
1	W	215	Total 1654	C 1035	N 303	O 313	S 3	0	0	0
1	Y	216	Total 1661	C 1040	N 304	O 314	S 3	0	0	0
1	1	215	Total 1654	C 1035	N 303	O 313	S 3	0	0	0

- Molecule 2 is a protein called Proteasome subunit beta.

Mol	Chain	Residues	Atoms					ZeroOcc	AltConf	Trace
			Total	C	N	O	S			
2	C	222	1638	1027	282	324	5	0	0	0
2	E	222	1638	1027	282	324	5	0	0	0
2	G	222	1638	1027	282	324	5	0	0	0
2	H	222	1638	1027	282	324	5	0	0	0
2	J	222	1638	1027	282	324	5	0	0	0
2	L	222	1638	1027	282	324	5	0	0	0
2	N	222	1638	1027	282	324	5	0	0	0
2	P	222	1638	1027	282	324	5	0	0	0
2	R	229	1683	1054	289	335	5	0	0	0
2	T	222	1638	1027	282	324	5	0	0	0
2	V	229	1683	1054	289	335	5	0	0	0
2	X	222	1638	1027	282	324	5	0	0	0
2	Z	222	1638	1027	282	324	5	0	0	0
2	2	222	1638	1027	282	324	5	0	0	0

There are 84 discrepancies between the modelled and reference sequences:

Chain	Residue	Modelled	Actual	Comment	Reference
C	535	HIS	-	expression tag	UNP A5U4D6
C	536	HIS	-	expression tag	UNP A5U4D6
C	537	HIS	-	expression tag	UNP A5U4D6
C	538	HIS	-	expression tag	UNP A5U4D6
C	539	HIS	-	expression tag	UNP A5U4D6
C	540	HIS	-	expression tag	UNP A5U4D6
E	535	HIS	-	expression tag	UNP A5U4D6
E	536	HIS	-	expression tag	UNP A5U4D6
E	537	HIS	-	expression tag	UNP A5U4D6
E	538	HIS	-	expression tag	UNP A5U4D6
E	539	HIS	-	expression tag	UNP A5U4D6
E	540	HIS	-	expression tag	UNP A5U4D6

Continued on next page...

Continued from previous page...

Chain	Residue	Modelled	Actual	Comment	Reference
G	535	HIS	-	expression tag	UNP A5U4D6
G	536	HIS	-	expression tag	UNP A5U4D6
G	537	HIS	-	expression tag	UNP A5U4D6
G	538	HIS	-	expression tag	UNP A5U4D6
G	539	HIS	-	expression tag	UNP A5U4D6
G	540	HIS	-	expression tag	UNP A5U4D6
H	535	HIS	-	expression tag	UNP A5U4D6
H	536	HIS	-	expression tag	UNP A5U4D6
H	537	HIS	-	expression tag	UNP A5U4D6
H	538	HIS	-	expression tag	UNP A5U4D6
H	539	HIS	-	expression tag	UNP A5U4D6
H	540	HIS	-	expression tag	UNP A5U4D6
J	535	HIS	-	expression tag	UNP A5U4D6
J	536	HIS	-	expression tag	UNP A5U4D6
J	537	HIS	-	expression tag	UNP A5U4D6
J	538	HIS	-	expression tag	UNP A5U4D6
J	539	HIS	-	expression tag	UNP A5U4D6
J	540	HIS	-	expression tag	UNP A5U4D6
L	535	HIS	-	expression tag	UNP A5U4D6
L	536	HIS	-	expression tag	UNP A5U4D6
L	537	HIS	-	expression tag	UNP A5U4D6
L	538	HIS	-	expression tag	UNP A5U4D6
L	539	HIS	-	expression tag	UNP A5U4D6
L	540	HIS	-	expression tag	UNP A5U4D6
N	535	HIS	-	expression tag	UNP A5U4D6
N	536	HIS	-	expression tag	UNP A5U4D6
N	537	HIS	-	expression tag	UNP A5U4D6
N	538	HIS	-	expression tag	UNP A5U4D6
N	539	HIS	-	expression tag	UNP A5U4D6
N	540	HIS	-	expression tag	UNP A5U4D6
P	535	HIS	-	expression tag	UNP A5U4D6
P	536	HIS	-	expression tag	UNP A5U4D6
P	537	HIS	-	expression tag	UNP A5U4D6
P	538	HIS	-	expression tag	UNP A5U4D6
P	539	HIS	-	expression tag	UNP A5U4D6
P	540	HIS	-	expression tag	UNP A5U4D6
R	535	HIS	-	expression tag	UNP A5U4D6
R	536	HIS	-	expression tag	UNP A5U4D6
R	537	HIS	-	expression tag	UNP A5U4D6
R	538	HIS	-	expression tag	UNP A5U4D6
R	539	HIS	-	expression tag	UNP A5U4D6
R	540	HIS	-	expression tag	UNP A5U4D6

Continued on next page...

Continued from previous page...

Chain	Residue	Modelled	Actual	Comment	Reference
T	535	HIS	-	expression tag	UNP A5U4D6
T	536	HIS	-	expression tag	UNP A5U4D6
T	537	HIS	-	expression tag	UNP A5U4D6
T	538	HIS	-	expression tag	UNP A5U4D6
T	539	HIS	-	expression tag	UNP A5U4D6
T	540	HIS	-	expression tag	UNP A5U4D6
V	535	HIS	-	expression tag	UNP A5U4D6
V	536	HIS	-	expression tag	UNP A5U4D6
V	537	HIS	-	expression tag	UNP A5U4D6
V	538	HIS	-	expression tag	UNP A5U4D6
V	539	HIS	-	expression tag	UNP A5U4D6
V	540	HIS	-	expression tag	UNP A5U4D6
X	535	HIS	-	expression tag	UNP A5U4D6
X	536	HIS	-	expression tag	UNP A5U4D6
X	537	HIS	-	expression tag	UNP A5U4D6
X	538	HIS	-	expression tag	UNP A5U4D6
X	539	HIS	-	expression tag	UNP A5U4D6
X	540	HIS	-	expression tag	UNP A5U4D6
Z	535	HIS	-	expression tag	UNP A5U4D6
Z	536	HIS	-	expression tag	UNP A5U4D6
Z	537	HIS	-	expression tag	UNP A5U4D6
Z	538	HIS	-	expression tag	UNP A5U4D6
Z	539	HIS	-	expression tag	UNP A5U4D6
Z	540	HIS	-	expression tag	UNP A5U4D6
2	535	HIS	-	expression tag	UNP A5U4D6
2	536	HIS	-	expression tag	UNP A5U4D6
2	537	HIS	-	expression tag	UNP A5U4D6
2	538	HIS	-	expression tag	UNP A5U4D6
2	539	HIS	-	expression tag	UNP A5U4D6
2	540	HIS	-	expression tag	UNP A5U4D6

- Molecule 3 is a protein called Fellutamide B.

Mol	Chain	Residues	Atoms				ZeroOcc	AltConf	Trace
			Total	C	N	O			
3	a	3	25	15	5	5	0	0	0
3	b	3	25	15	5	5	0	0	0
3	c	3	25	15	5	5	0	0	0
3	d	3	25	15	5	5	0	0	0

Continued on next page...

Continued from previous page...

Mol	Chain	Residues	Atoms				ZeroOcc	AltConf	Trace
			Total	C	N	O			
3	e	3	Total 25	C 15	N 5	O 5	0	0	0
3	f	3	Total 25	C 15	N 5	O 5	0	0	0
3	g	3	Total 25	C 15	N 5	O 5	0	0	0
3	h	3	Total 25	C 15	N 5	O 5	0	0	0
3	i	3	Total 25	C 15	N 5	O 5	0	0	0
3	j	3	Total 25	C 15	N 5	O 5	0	0	0
3	k	3	Total 25	C 15	N 5	O 5	0	0	0
3	l	3	Total 25	C 15	N 5	O 5	0	0	0
3	m	3	Total 25	C 15	N 5	O 5	0	0	0
3	n	3	Total 25	C 15	N 5	O 5	0	0	0

- Molecule 4 is (3R)-3-HYDROXYDODECANOIC ACID (three-letter code: HXD) (formula: C₁₂H₂₄O₃).

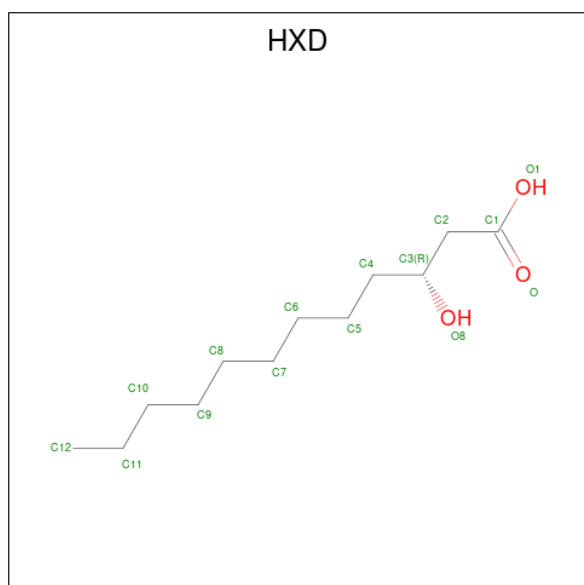

Mol	Chain	Residues	Atoms			ZeroOcc	AltConf
			Total	C	O		
4	a	1	Total 7	C 5	O 2	0	0

Continued on next page...

Continued from previous page...

Mol	Chain	Residues	Atoms	ZeroOcc	AltConf
4	b	1	Total C O 7 5 2	0	0
4	c	1	Total C O 7 5 2	0	0
4	d	1	Total C O 7 5 2	0	0
4	e	1	Total C O 7 5 2	0	0
4	f	1	Total C O 7 5 2	0	0
4	g	1	Total C O 7 5 2	0	0
4	h	1	Total C O 7 5 2	0	0
4	i	1	Total C O 7 5 2	0	0
4	j	1	Total C O 7 5 2	0	0
4	k	1	Total C O 7 5 2	0	0
4	l	1	Total C O 7 5 2	0	0
4	m	1	Total C O 7 5 2	0	0
4	n	1	Total C O 7 5 2	0	0

- Molecule 5 is water.

Mol	Chain	Residues	Atoms	ZeroOcc	AltConf
5	A	32	Total O 32 32	0	0
5	B	42	Total O 42 42	0	0
5	C	131	Total O 131 131	0	0
5	D	25	Total O 25 25	0	0
5	E	130	Total O 130 130	0	0
5	F	41	Total O 41 41	0	0

Continued on next page...

Continued from previous page...

Mol	Chain	Residues	Atoms		ZeroOcc	AltConf
5	G	113	Total 113	O 113	0	0
5	H	126	Total 126	O 126	0	0
5	I	38	Total 38	O 38	0	0
5	J	122	Total 122	O 122	0	0
5	K	33	Total 33	O 33	0	0
5	L	132	Total 132	O 132	0	0
5	M	42	Total 42	O 42	0	0
5	N	121	Total 121	O 121	0	0
5	O	39	Total 39	O 39	0	0
5	P	111	Total 111	O 111	0	0
5	Q	34	Total 34	O 34	0	0
5	R	143	Total 143	O 143	0	0
5	S	43	Total 43	O 43	0	0
5	T	103	Total 103	O 103	0	0
5	U	33	Total 33	O 33	0	0
5	V	149	Total 149	O 149	0	0
5	W	26	Total 26	O 26	0	0
5	X	115	Total 115	O 115	0	0
5	Y	22	Total 22	O 22	0	0
5	Z	106	Total 106	O 106	0	0
5	1	55	Total 55	O 55	0	0

Continued on next page...

Continued from previous page...

Mol	Chain	Residues	Atoms		ZeroOcc	AltConf
5	2	118	Total 118	O 118	0	0

3 Residue-property plots [i](#)

These plots are drawn for all protein, RNA, DNA and oligosaccharide chains in the entry. The first graphic for a chain summarises the proportions of the various outlier classes displayed in the second graphic. The second graphic shows the sequence view annotated by issues in geometry and electron density. Residues are color-coded according to the number of geometric quality criteria for which they contain at least one outlier: green = 0, yellow = 1, orange = 2 and red = 3 or more. A red dot above a residue indicates a poor fit to the electron density ($RSRZ > 2$). Stretches of 2 or more consecutive residues without any outlier are shown as a green connector. Residues present in the sample, but not in the model, are shown in grey.

- Molecule 1: Proteasome subunit alpha

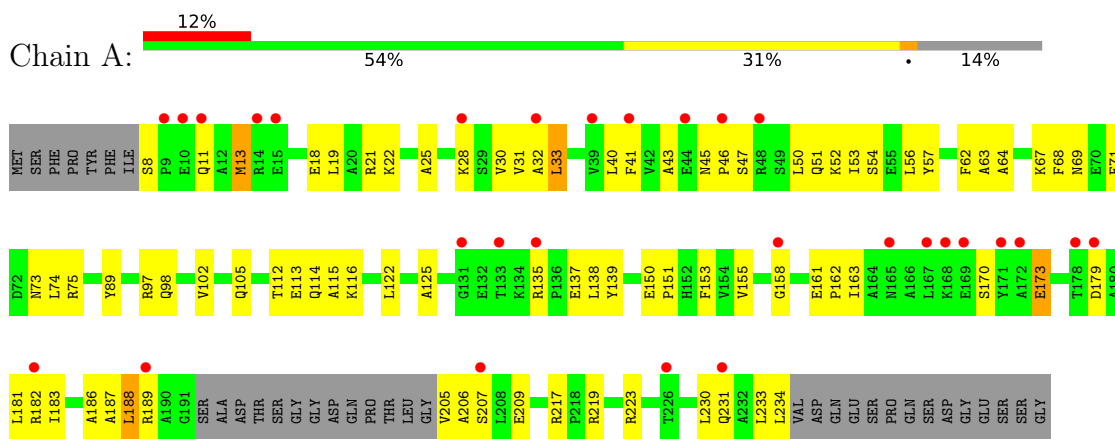

- Molecule 1: Proteasome subunit alpha

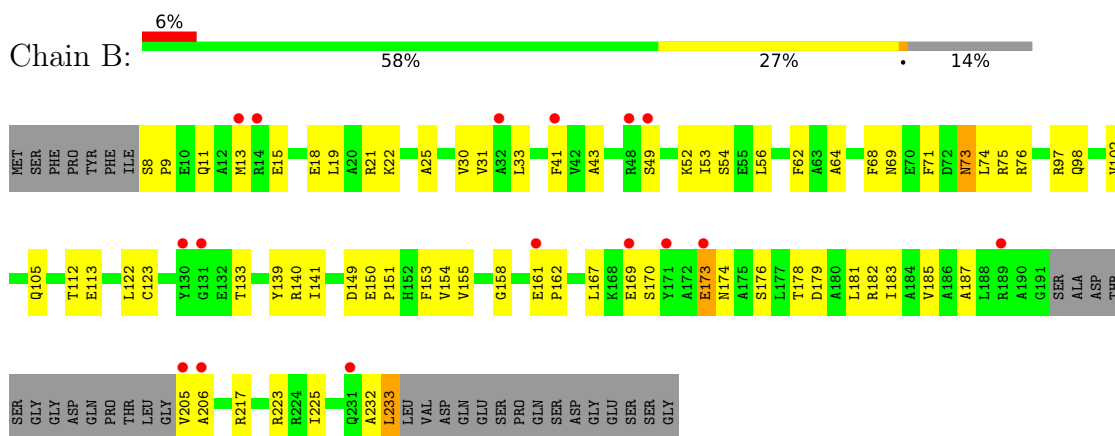

- Molecule 1: Proteasome subunit alpha

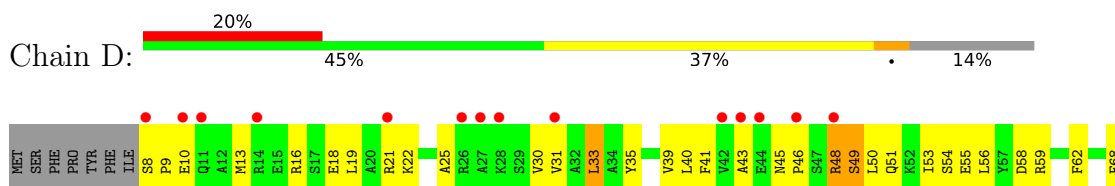

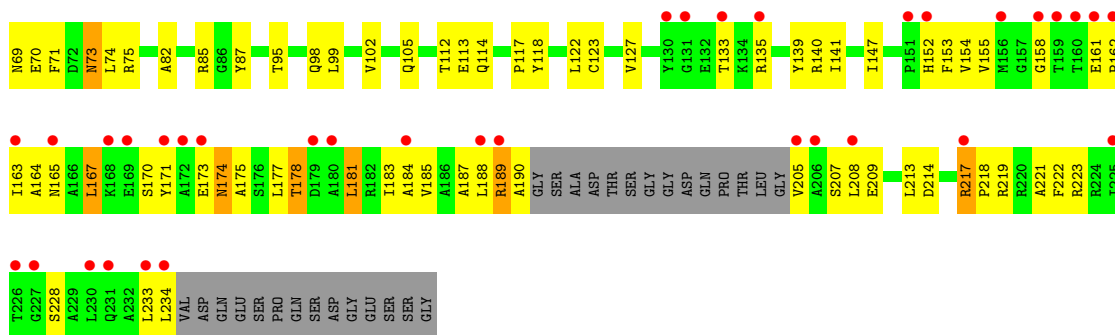

• Molecule 1: Proteasome subunit alpha

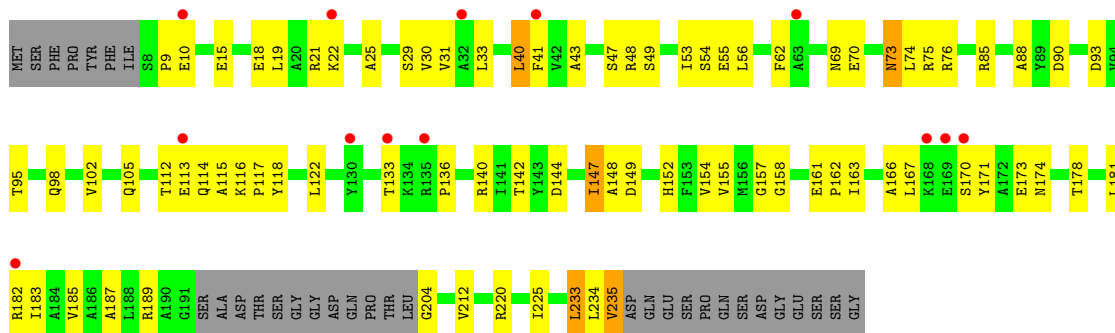

• Molecule 1: Proteasome subunit alpha

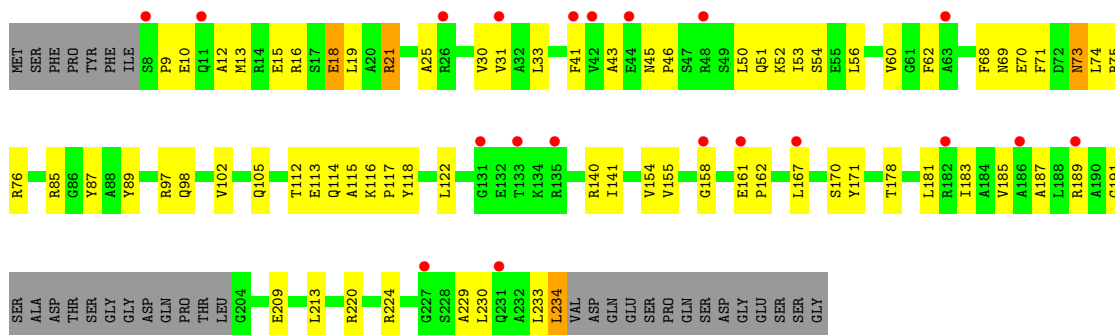

• Molecule 1: Proteasome subunit alpha

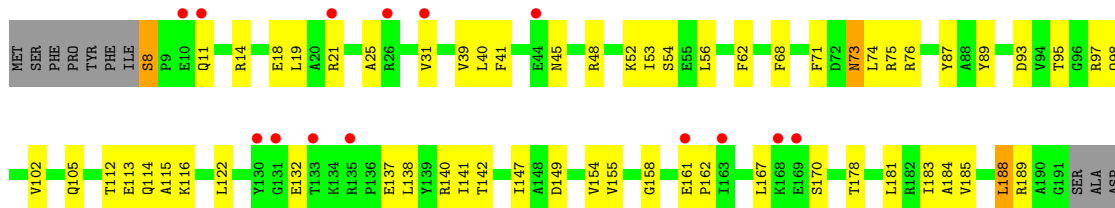



● Molecule 1: Proteasome subunit alpha

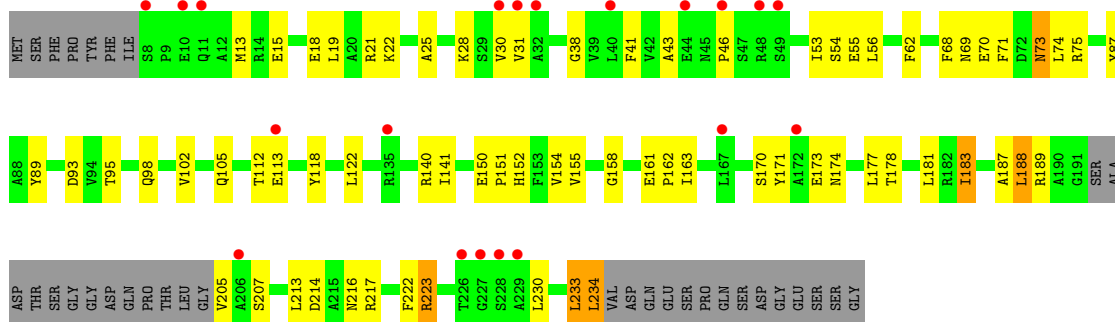

● Molecule 1: Proteasome subunit alpha

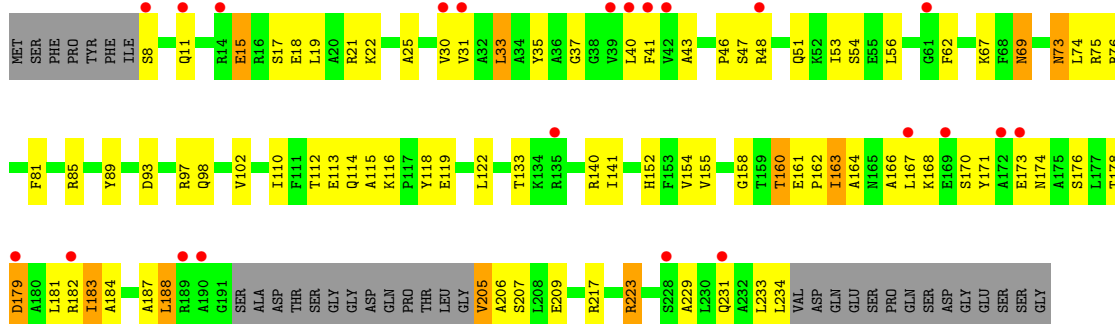

● Molecule 1: Proteasome subunit alpha

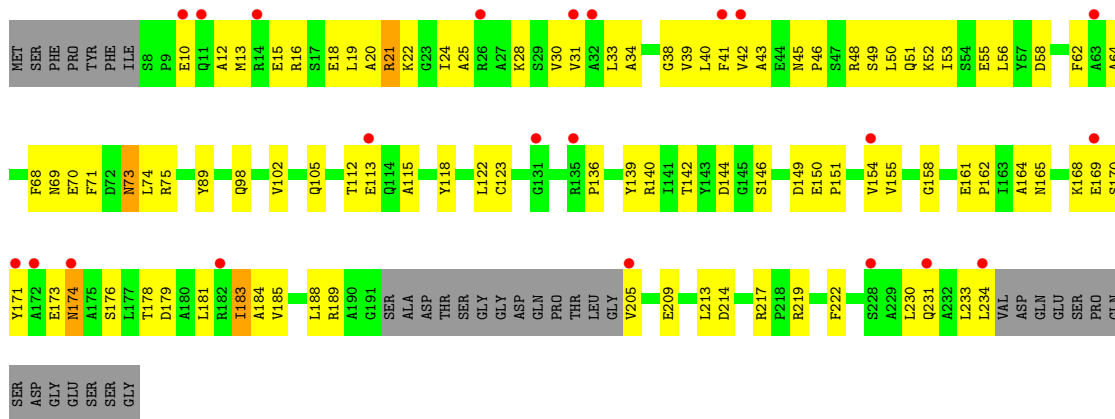

● Molecule 1: Proteasome subunit alpha

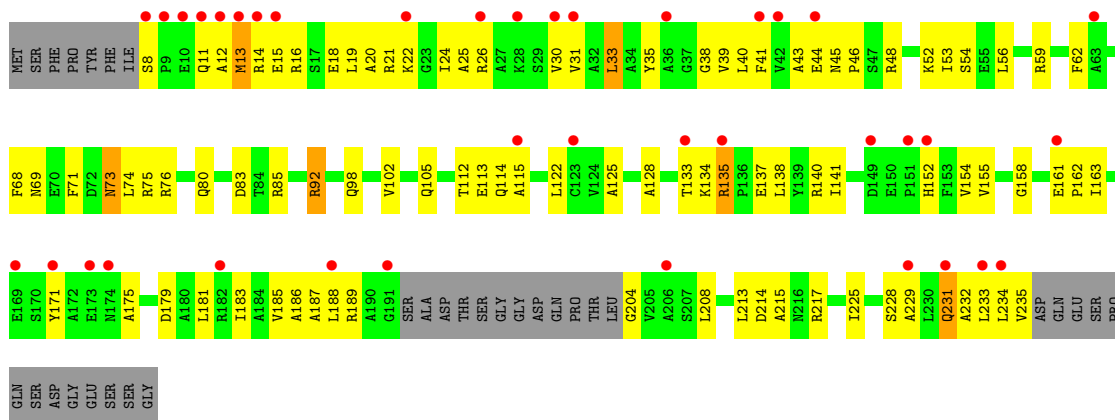

● Molecule 1: Proteasome subunit alpha

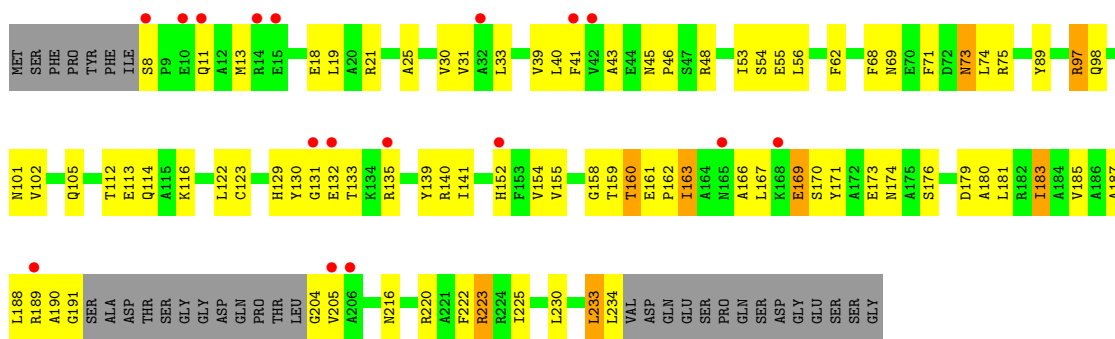

● Molecule 2: Proteasome subunit beta

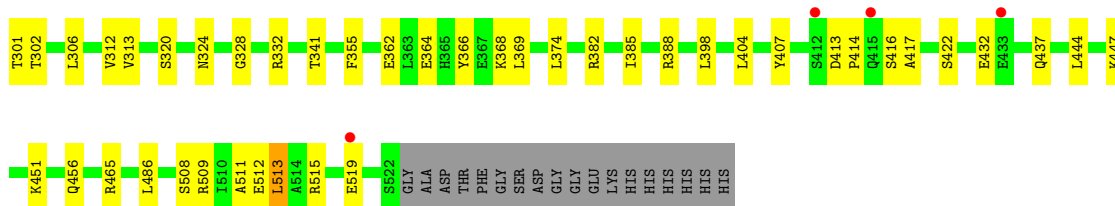
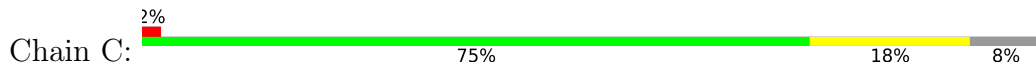

● Molecule 2: Proteasome subunit beta

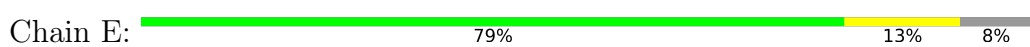

● Molecule 2: Proteasome subunit beta

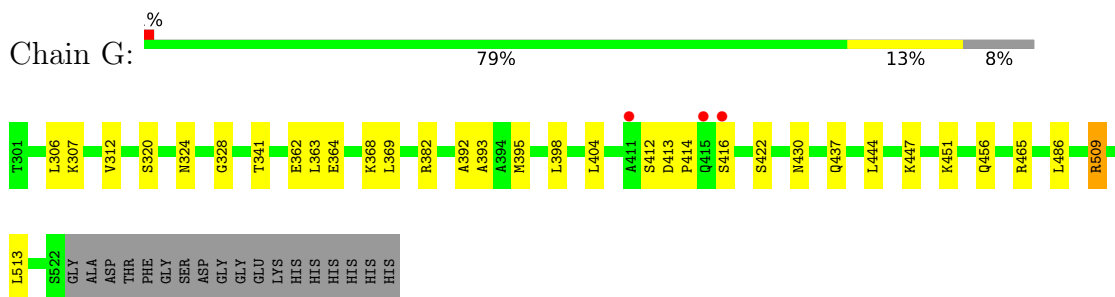

• Molecule 2: Proteasome subunit beta

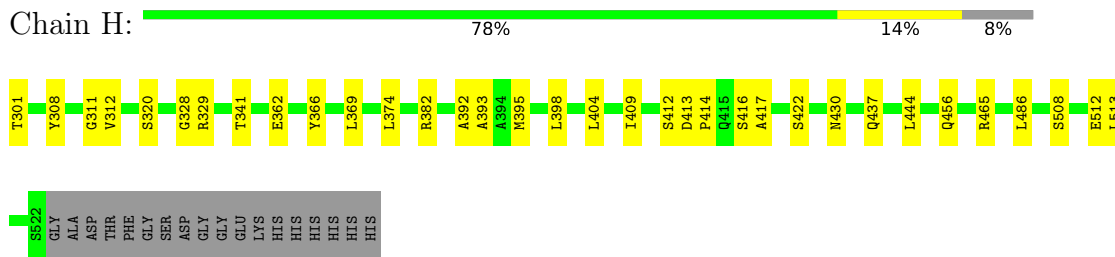

• Molecule 2: Proteasome subunit beta

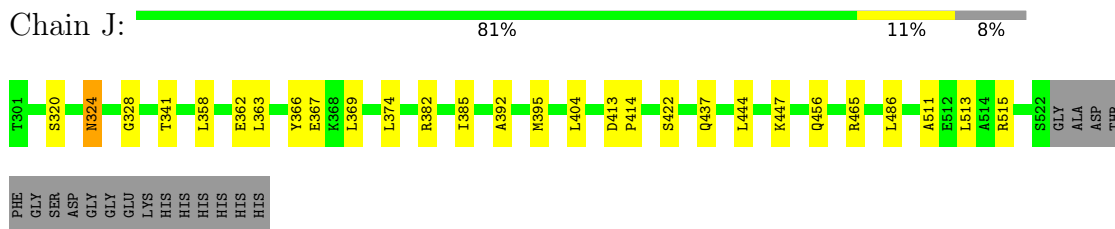

• Molecule 2: Proteasome subunit beta

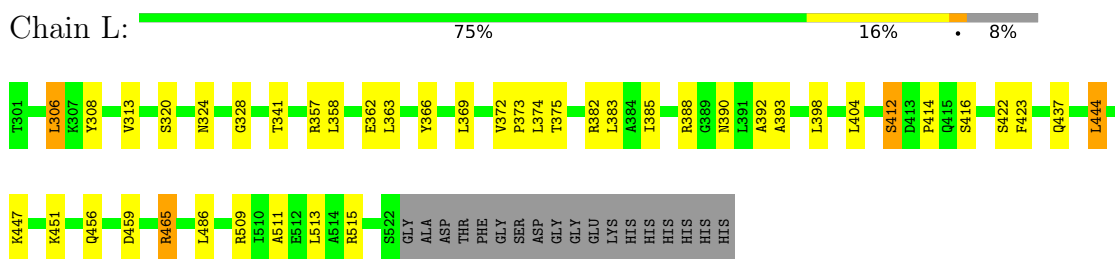

• Molecule 2: Proteasome subunit beta

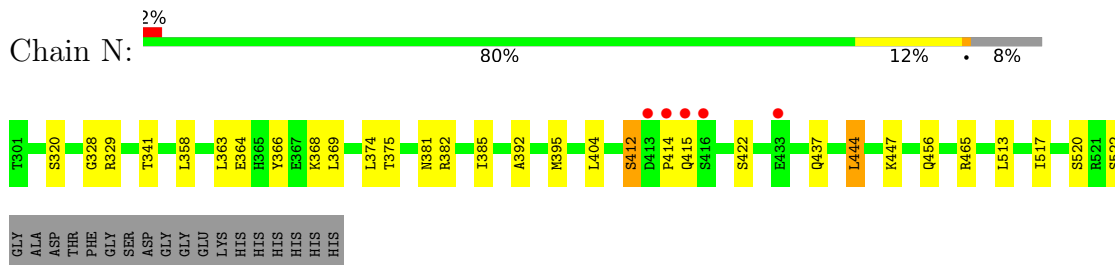

• Molecule 2: Proteasome subunit beta

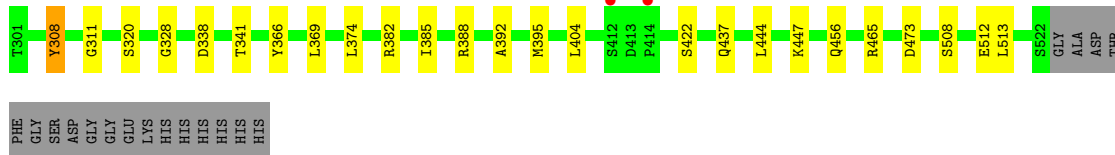
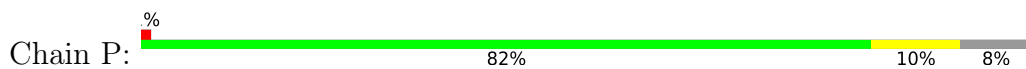

- Molecule 2: Proteasome subunit beta

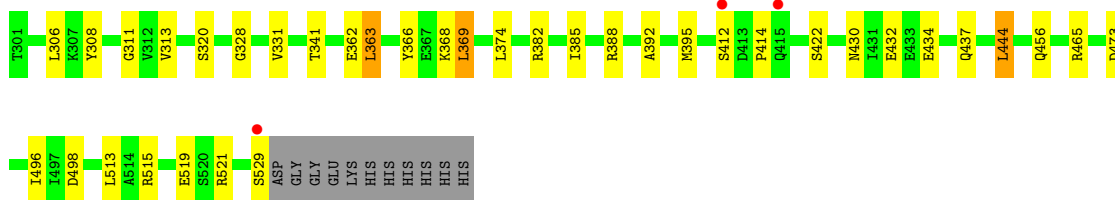
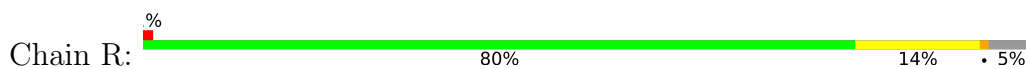

- Molecule 2: Proteasome subunit beta

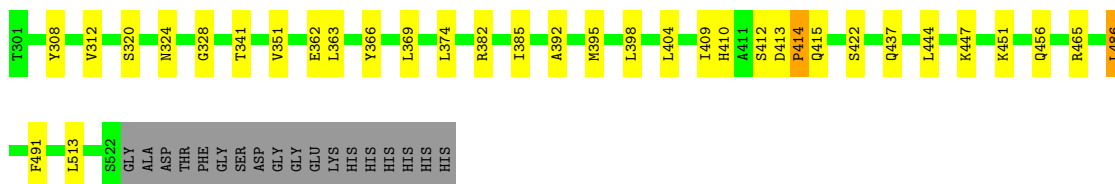
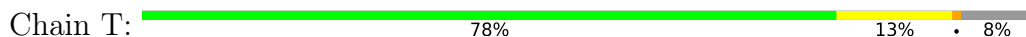

- Molecule 2: Proteasome subunit beta

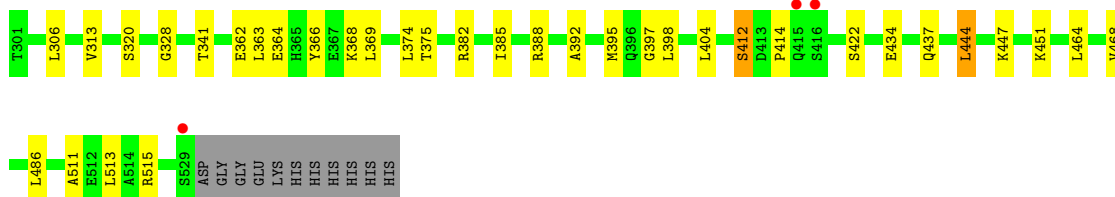
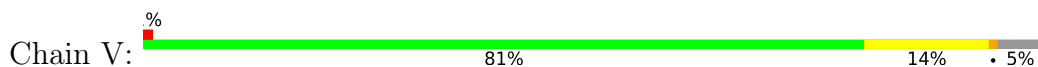

- Molecule 2: Proteasome subunit beta

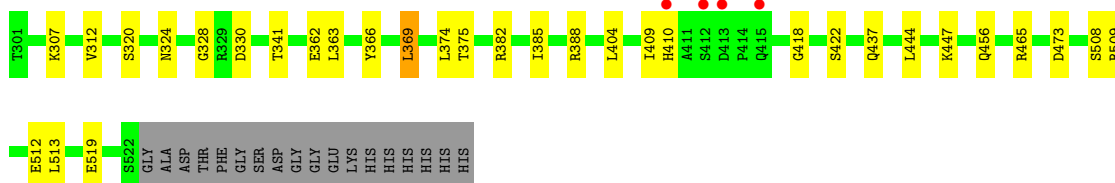
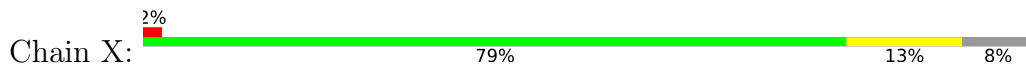

• Molecule 2: Proteasome subunit beta

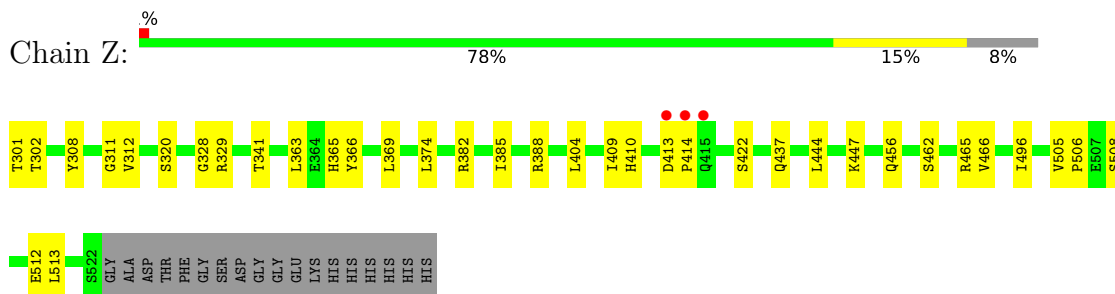

• Molecule 2: Proteasome subunit beta

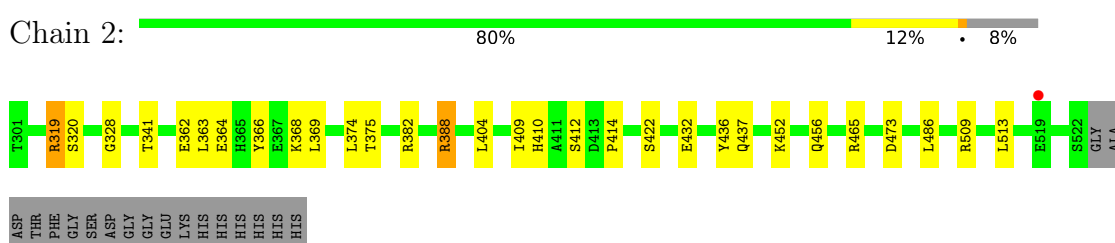

• Molecule 3: Fellutamide B

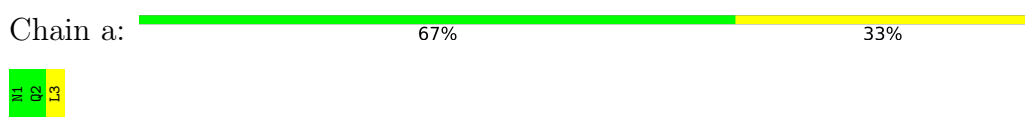

• Molecule 3: Fellutamide B



• Molecule 3: Fellutamide B



• Molecule 3: Fellutamide B

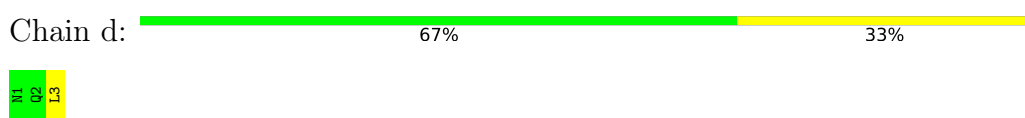

• Molecule 3: Fellutamide B



● Molecule 3: Fellutamide B

Chain f:  67% 33% M1
Q2
L3

● Molecule 3: Fellutamide B

Chain g:  67% 33% M1
Q2
L3

● Molecule 3: Fellutamide B

Chain h:  67% 33% M1
Q2
L3

● Molecule 3: Fellutamide B

Chain i:  67% 33% M1
Q2
L3

● Molecule 3: Fellutamide B

Chain j:  67% 33% M1
Q2
L3

● Molecule 3: Fellutamide B

Chain k:  67% 33% M1
Q2
L3

● Molecule 3: Fellutamide B

Chain l:  67% 33% M1
Q2
L3

● Molecule 3: Fellutamide B

Chain m:  67% 33% M1
Q2
L3

● Molecule 3: Fellutamide B

Chain n:  67% 33%

11
12
13

4 Data and refinement statistics

Property	Value	Source
Space group	P 1 21 1	Depositor
Cell constants a, b, c, α , β , γ	170.19Å 118.10Å 194.35Å 90.00° 112.62° 90.00°	Depositor
Resolution (Å)	25.00 – 2.50 25.00 – 2.50	Depositor EDS
% Data completeness (in resolution range)	96.5 (25.00-2.50) 96.6 (25.00-2.50)	Depositor EDS
R_{merge}	0.09	Depositor
R_{sym}	0.11	Depositor
$\langle I/\sigma(I) \rangle$ ¹	2.67 (at 2.50Å)	Xtrriage
Refinement program	CNS	Depositor
R, R_{free}	0.208 , 0.229 0.198 , 0.217	Depositor DCC
R_{free} test set	12081 reflections (4.99%)	wwPDB-VP
Wilson B-factor (Å ²)	30.7	Xtrriage
Anisotropy	0.279	Xtrriage
Bulk solvent k_{sol} (e/Å ³), B_{sol} (Å ²)	0.32 , 53.6	EDS
L-test for twinning ²	$\langle L \rangle = 0.49$, $\langle L^2 \rangle = 0.33$	Xtrriage
Estimated twinning fraction	No twinning to report.	Xtrriage
F_o, F_c correlation	0.93	EDS
Total number of atoms	48828	wwPDB-VP
Average B, all atoms (Å ²)	41.0	wwPDB-VP

Xtrriage's analysis on translational NCS is as follows: *The largest off-origin peak in the Patterson function is 4.82% of the height of the origin peak. No significant pseudotranslation is detected.*

¹Intensities estimated from amplitudes.

²Theoretical values of $\langle |L| \rangle$, $\langle L^2 \rangle$ for acentric reflections are 0.5, 0.333 respectively for untwinned datasets, and 0.375, 0.2 for perfectly twinned datasets.

5 Model quality i

5.1 Standard geometry i

Bond lengths and bond angles in the following residue types are not validated in this section: HXD

The Z score for a bond length (or angle) is the number of standard deviations the observed value is removed from the expected value. A bond length (or angle) with $|Z| > 5$ is considered an outlier worth inspection. RMSZ is the root-mean-square of all Z scores of the bond lengths (or angles).

Mol	Chain	Bond lengths		Bond angles	
		RMSZ	# Z >5	RMSZ	# Z >5
1	1	0.81	0/1679	0.76	0/2268
1	A	0.73	1/1675 (0.1%)	0.70	0/2263
1	B	0.62	0/1667	0.69	1/2252 (0.0%)
1	D	0.62	0/1671	0.79	1/2258 (0.0%)
1	F	0.70	0/1686	0.74	0/2278
1	I	0.67	0/1679	0.75	1/2268 (0.0%)
1	K	0.76	0/1679	0.77	0/2268
1	M	0.65	0/1675	0.71	0/2263
1	O	0.70	0/1675	0.76	0/2263
1	Q	0.69	0/1675	0.73	1/2263 (0.0%)
1	S	0.67	0/1682	0.73	2/2273 (0.1%)
1	U	0.66	0/1675	0.71	0/2263
1	W	0.56	0/1679	0.74	1/2268 (0.0%)
1	Y	0.73	0/1686	0.75	0/2278
2	2	0.77	0/1662	0.77	1/2254 (0.0%)
2	C	0.70	0/1662	0.78	2/2254 (0.1%)
2	E	0.76	0/1662	0.79	0/2254
2	G	0.70	0/1662	0.75	0/2254
2	H	0.73	0/1662	0.76	0/2254
2	J	0.75	0/1662	0.78	0/2254
2	L	0.74	1/1662 (0.1%)	0.77	1/2254 (0.0%)
2	N	0.66	0/1662	0.74	0/2254
2	P	0.76	1/1662 (0.1%)	0.76	2/2254 (0.1%)
2	R	0.82	0/1708	0.79	1/2316 (0.0%)
2	T	0.76	0/1662	0.82	0/2254
2	V	0.82	0/1708	0.75	0/2316
2	X	0.70	0/1662	0.78	1/2254 (0.0%)
2	Z	0.63	0/1662	0.76	1/2254 (0.0%)
3	a	2.68	1/24 (4.2%)	1.38	0/30
3	b	2.63	1/24 (4.2%)	1.26	0/30
3	c	2.56	1/24 (4.2%)	1.40	0/30
3	d	2.65	1/24 (4.2%)	1.32	0/30

Mol	Chain	Bond lengths		Bond angles	
		RMSZ	# Z >5	RMSZ	# Z >5
3	e	2.56	1/24 (4.2%)	1.42	0/30
3	f	2.69	1/24 (4.2%)	1.33	0/30
3	g	2.63	1/24 (4.2%)	1.30	0/30
3	h	2.61	1/24 (4.2%)	1.43	0/30
3	i	2.43	1/24 (4.2%)	1.35	0/30
3	j	2.60	1/24 (4.2%)	1.45	0/30
3	k	2.60	1/24 (4.2%)	1.30	0/30
3	l	2.57	1/24 (4.2%)	1.37	0/30
3	m	2.59	1/24 (4.2%)	1.35	0/30
3	n	2.61	1/24 (4.2%)	1.38	0/30
All	All	0.74	17/47179 (0.0%)	0.76	16/63826 (0.0%)

All (17) bond length outliers are listed below:

Mol	Chain	Res	Type	Atoms	Z	Observed(Å)	Ideal(Å)
3	a	3	LEU	C-OXT	11.73	1.45	1.23
3	b	3	LEU	C-OXT	11.41	1.45	1.23
3	d	3	LEU	C-OXT	11.33	1.44	1.23
3	m	3	LEU	C-OXT	11.28	1.44	1.23
3	f	3	LEU	C-OXT	11.28	1.44	1.23
3	n	3	LEU	C-OXT	11.16	1.44	1.23
3	g	3	LEU	C-OXT	11.16	1.44	1.23
3	l	3	LEU	C-OXT	11.09	1.44	1.23
3	h	3	LEU	C-OXT	10.88	1.44	1.23
3	j	3	LEU	C-OXT	10.83	1.44	1.23
3	c	3	LEU	C-OXT	10.74	1.43	1.23
3	k	3	LEU	C-OXT	10.54	1.43	1.23
3	e	3	LEU	C-OXT	10.49	1.43	1.23
3	i	3	LEU	C-OXT	10.18	1.42	1.23
2	L	308	TYR	CD1-CE1	-5.57	1.30	1.39
2	P	308	TYR	CD1-CE1	-5.11	1.31	1.39
1	A	57	TYR	CD1-CE1	-5.10	1.31	1.39

All (16) bond angle outliers are listed below:

Mol	Chain	Res	Type	Atoms	Z	Observed(°)	Ideal(°)
1	S	183	ILE	CB-CA-C	-5.96	99.67	111.60
1	Q	183	ILE	CB-CA-C	-5.70	100.20	111.60
2	C	413	ASP	C-N-CD	-5.67	108.12	120.60
2	Z	388	ARG	NE-CZ-NH2	-5.42	117.59	120.30
2	2	388	ARG	NE-CZ-NH2	-5.37	117.61	120.30
2	L	465	ARG	NE-CZ-NH2	-5.22	117.69	120.30

Continued on next page...

Continued from previous page...

Mol	Chain	Res	Type	Atoms	Z	Observed(°)	Ideal(°)
2	P	338	ASP	CB-CG-OD1	5.21	122.99	118.30
2	R	388	ARG	NE-CZ-NH2	-5.19	117.70	120.30
2	X	388	ARG	NE-CZ-NH2	-5.19	117.70	120.30
2	P	388	ARG	NE-CZ-NH2	-5.17	117.71	120.30
1	S	213	LEU	N-CA-C	-5.15	97.09	111.00
1	B	233	LEU	CA-CB-CG	5.13	127.09	115.30
1	W	213	LEU	N-CA-C	-5.11	97.19	111.00
1	D	213	LEU	N-CA-C	-5.10	97.22	111.00
2	C	388	ARG	NE-CZ-NH2	-5.03	117.78	120.30
1	I	213	LEU	N-CA-C	-5.02	97.46	111.00

There are no chirality outliers.

There are no planarity outliers.

5.2 Too-close contacts [i](#)

In the following table, the Non-H and H(model) columns list the number of non-hydrogen atoms and hydrogen atoms in the chain respectively. The H(added) column lists the number of hydrogen atoms added and optimized by MolProbity. The Clashes column lists the number of clashes within the asymmetric unit, whereas Symm-Clashes lists symmetry-related clashes.

Mol	Chain	Non-H	H(model)	H(added)	Clashes	Symm-Clashes
1	1	1654	0	1651	93	0
1	A	1650	0	1648	74	0
1	B	1642	0	1637	64	0
1	D	1646	0	1645	144	0
1	F	1661	0	1660	68	0
1	I	1654	0	1651	62	0
1	K	1654	0	1651	82	0
1	M	1650	0	1648	69	0
1	O	1650	0	1648	96	0
1	Q	1650	0	1648	89	0
1	S	1657	0	1657	98	0
1	U	1650	0	1648	64	0
1	W	1654	0	1651	90	0
1	Y	1661	0	1660	120	0
2	2	1638	0	1629	25	0
2	C	1638	0	1629	35	0
2	E	1638	0	1629	29	0
2	G	1638	0	1629	30	0
2	H	1638	0	1629	21	0

Continued on next page...

Continued from previous page...

Mol	Chain	Non-H	H(model)	H(added)	Clashes	Symm-Clashes
2	J	1638	0	1629	29	0
2	L	1638	0	1629	47	0
2	N	1638	0	1629	22	0
2	P	1638	0	1629	18	0
2	R	1683	0	1665	35	0
2	T	1638	0	1629	34	0
2	V	1683	0	1665	29	0
2	X	1638	0	1629	25	0
2	Z	1638	0	1629	22	0
3	a	25	0	24	0	0
3	b	25	0	24	0	0
3	c	25	0	24	0	0
3	d	25	0	24	0	0
3	e	25	0	24	0	0
3	f	25	0	24	0	0
3	g	25	0	24	0	0
3	h	25	0	24	0	0
3	i	25	0	24	0	0
3	j	25	0	24	0	0
3	k	25	0	24	0	0
3	l	25	0	24	0	0
3	m	25	0	24	0	0
3	n	25	0	24	0	0
4	a	7	0	6	0	0
4	b	7	0	6	0	0
4	c	7	0	6	0	0
4	d	7	0	6	0	0
4	e	7	0	6	0	0
4	f	7	0	6	0	0
4	g	7	0	6	0	0
4	h	7	0	6	0	0
4	i	7	0	6	0	0
4	j	7	0	6	0	0
4	k	7	0	6	0	0
4	l	7	0	6	0	0
4	m	7	0	6	0	0
4	n	7	0	6	0	0
5	1	55	0	0	2	0
5	2	118	0	0	6	0
5	A	32	0	0	3	0
5	B	42	0	0	3	0
5	C	131	0	0	9	0

Continued on next page...

Continued from previous page...

Mol	Chain	Non-H	H(model)	H(added)	Clashes	Symm-Clashes
5	D	25	0	0	3	0
5	E	130	0	0	7	0
5	F	41	0	0	6	0
5	G	113	0	0	8	0
5	H	126	0	0	5	0
5	I	38	0	0	6	0
5	J	122	0	0	3	0
5	K	33	0	0	6	0
5	L	132	0	0	9	0
5	M	42	0	0	0	0
5	N	121	0	0	3	0
5	O	39	0	0	6	0
5	P	111	0	0	2	0
5	Q	34	0	0	0	0
5	R	143	0	0	8	0
5	S	43	0	0	19	0
5	T	103	0	0	3	0
5	U	33	0	0	2	0
5	V	149	0	0	5	0
5	W	26	0	0	3	0
5	X	115	0	0	4	0
5	Y	22	0	0	3	0
5	Z	106	0	0	1	0
All	All	48828	0	46401	1486	0

The all-atom clashscore is defined as the number of clashes found per 1000 atoms (including hydrogen atoms). The all-atom clashscore for this structure is 16.

All (1486) close contacts within the same asymmetric unit are listed below, sorted by their clash magnitude.

Atom-1	Atom-2	Interatomic distance (Å)	Clash overlap (Å)
1:D:217:ARG:HB2	1:D:217:ARG:NH1	1.41	1.30
1:A:13:MET:CE	1:O:116:LYS:HD3	1.62	1.27
1:M:217:ARG:HD3	1:M:223:ARG:NH2	1.53	1.24
1:B:170:SER:OG	1:B:183:ILE:HG23	1.39	1.23
1:Y:229:ALA:O	1:Y:233:LEU:HD13	1.41	1.20
1:W:176:SER:HB3	1:W:179:ASP:OD2	1.42	1.19
1:Q:10:GLU:HG3	1:Y:15:GLU:OE1	1.41	1.18
1:1:155:VAL:CG1	1:1:160:THR:HG23	1.71	1.18
1:F:166:ALA:O	1:F:170:SER:HB2	1.43	1.17
1:1:179:ASP:O	1:1:183:ILE:HG22	1.42	1.16

Continued on next page...

Continued from previous page...

Atom-1	Atom-2	Interatomic distance (Å)	Clash overlap (Å)
1:D:49:SER:C	1:D:50:LEU:HD23	1.65	1.15
1:D:152:HIS:HB3	1:D:171:TYR:CZ	1.82	1.13
1:M:205:VAL:HG12	1:M:234:LEU:HD23	1.29	1.13
2:L:451:LYS:HE3	5:L:3067:HOH:O	1.44	1.13
2:L:456:GLN:NE2	2:L:465:ARG:HH22	1.45	1.13
1:O:178:THR:CG2	1:O:182:ARG:HH12	1.63	1.12
1:B:232:ALA:O	1:B:233:LEU:HB2	1.41	1.11
1:S:170:SER:OG	1:S:183:ILE:HG12	1.52	1.10
1:Y:92:ARG:HH11	1:Y:92:ARG:CG	1.60	1.10
1:1:152:HIS:HB3	1:1:171:TYR:CE2	1.86	1.10
1:D:214:ASP:HB3	1:D:217:ARG:NH1	1.66	1.10
1:O:152:HIS:HB3	1:O:171:TYR:CE2	1.87	1.09
1:M:205:VAL:HG12	1:M:234:LEU:CD2	1.83	1.08
2:R:529:SER:HB3	5:R:1999:HOH:O	1.53	1.08
2:Z:456:GLN:NE2	2:Z:465:ARG:HH12	1.51	1.07
1:D:217:ARG:HH11	1:D:217:ARG:CB	1.67	1.07
1:1:155:VAL:HG12	1:1:160:THR:HG23	1.17	1.07
2:T:409:ILE:HD11	2:T:410:HIS:HE1	1.20	1.06
1:U:231:GLN:HA	1:U:234:LEU:HD12	1.11	1.06
1:A:51:GLN:HG2	1:A:209:GLU:OE2	1.56	1.05
1:A:13:MET:HE2	1:O:116:LYS:HD3	1.08	1.05
1:D:214:ASP:HB3	1:D:217:ARG:HH12	0.94	1.05
2:G:465:ARG:HD2	5:G:2889:HOH:O	1.52	1.05
1:Y:92:ARG:HH11	1:Y:92:ARG:HG2	1.13	1.05
1:D:13:MET:HE1	1:Q:19:LEU:HD21	1.33	1.05
2:T:491:PHE:HB2	5:T:3058:HOH:O	1.55	1.04
1:Y:22:LYS:HG2	1:Y:26:ARG:HH21	1.23	1.03
1:D:173:GLU:HB3	1:D:174:ASN:OD1	1.59	1.02
1:Q:171:TYR:HE2	1:Q:173:GLU:HG3	1.25	1.02
1:S:150:GLU:HA	1:S:150:GLU:OE1	1.58	1.01
1:Y:8:SER:CB	1:Y:11:GLN:HB3	1.89	1.01
1:W:181:LEU:O	1:W:185:VAL:HG23	1.58	1.01
1:D:177:LEU:HD23	1:D:233:LEU:HD21	1.43	1.00
1:K:217:ARG:HH11	1:K:217:ARG:CG	1.72	1.00
2:E:465:ARG:HD2	5:E:2886:HOH:O	1.62	1.00
1:K:217:ARG:HH11	1:K:217:ARG:HG3	0.85	0.99
1:M:170:SER:OG	1:M:183:ILE:HG12	1.62	0.99
1:O:178:THR:CG2	1:O:182:ARG:NH1	2.26	0.99
2:2:388:ARG:HD2	5:2:3066:HOH:O	1.60	0.98
1:D:13:MET:CE	1:Q:19:LEU:HD21	1.93	0.98
1:M:217:ARG:CD	1:M:223:ARG:NH2	2.27	0.98

Continued on next page...

Continued from previous page...

Atom-1	Atom-2	Interatomic distance (Å)	Clash overlap (Å)
2:T:409:ILE:HG13	2:T:410:HIS:ND1	1.77	0.98
2:L:456:GLN:HE22	2:L:465:ARG:NH2	1.62	0.98
1:U:166:ALA:O	1:U:170:SER:HB2	1.63	0.98
1:Y:152:HIS:CD2	1:Y:171:TYR:HE2	1.82	0.97
1:Y:8:SER:OG	1:Y:11:GLN:HB3	1.65	0.96
1:D:49:SER:O	1:D:50:LEU:HD23	1.65	0.96
2:T:409:ILE:HD11	2:T:410:HIS:CE1	2.01	0.96
1:Y:152:HIS:HB3	1:Y:171:TYR:CZ	2.01	0.95
1:K:217:ARG:HG3	1:K:217:ARG:NH1	1.57	0.95
1:A:170:SER:OG	1:A:183:ILE:HG23	1.65	0.95
1:1:169:GLU:HA	1:1:169:GLU:OE1	1.63	0.95
1:D:234:LEU:HD23	1:D:234:LEU:O	1.67	0.94
1:F:167:LEU:HA	1:F:170:SER:HB3	1.49	0.94
1:F:18:GLU:CD	1:F:21:ARG:HH12	1.70	0.94
1:1:152:HIS:CD2	1:1:171:TYR:HE2	1.87	0.94
1:Y:152:HIS:CD2	1:Y:171:TYR:CE2	2.56	0.93
2:Z:456:GLN:HE22	2:Z:465:ARG:HH12	1.05	0.93
1:M:205:VAL:CG1	1:M:234:LEU:HD23	1.97	0.93
2:R:456:GLN:NE2	2:R:465:ARG:HH21	1.66	0.93
2:X:444:LEU:HB2	5:X:2899:HOH:O	1.67	0.93
2:R:456:GLN:HE21	2:R:465:ARG:HH21	1.05	0.93
1:1:155:VAL:HG12	1:1:160:THR:CG2	1.99	0.93
1:A:13:MET:CE	1:O:116:LYS:CD	2.47	0.92
1:M:217:ARG:HD3	1:M:223:ARG:CZ	1.98	0.92
1:Q:20:ALA:O	1:Q:24:ILE:HG13	1.69	0.92
2:T:409:ILE:HG13	2:T:410:HIS:CE1	2.04	0.92
1:1:31:VAL:HG22	1:1:155:VAL:HG22	1.51	0.92
2:H:456:GLN:NE2	2:H:465:ARG:HH21	1.68	0.91
1:S:152:HIS:CD2	1:S:171:TYR:HE2	1.87	0.91
1:Y:8:SER:HB2	1:Y:11:GLN:HB3	1.50	0.91
1:A:219:ARG:HB3	5:A:1319:HOH:O	1.68	0.91
1:D:48:ARG:HH12	1:K:137:GLU:HB3	1.34	0.91
1:Q:164:ALA:O	1:Q:168:LYS:HG3	1.70	0.91
1:U:231:GLN:CA	1:U:234:LEU:HD12	2.00	0.91
2:R:456:GLN:HE21	2:R:465:ARG:NH2	1.69	0.90
1:M:41:PHE:HB3	1:M:53:ILE:HD13	1.51	0.90
1:K:142:THR:HA	5:K:2919:HOH:O	1.70	0.90
1:S:182:ARG:NH2	1:S:235:VAL:HB	1.85	0.90
2:P:456:GLN:HE21	2:P:465:ARG:NH2	1.68	0.90
1:O:76:ARG:HD3	5:O:1070:HOH:O	1.70	0.90
1:D:48:ARG:CG	1:K:149:ASP:OD1	2.20	0.89

Continued on next page...

Continued from previous page...

Atom-1	Atom-2	Interatomic distance (Å)	Clash overlap (Å)
1:D:181:LEU:HD12	1:D:181:LEU:O	1.72	0.89
1:D:10:GLU:HG3	1:Q:15:GLU:HG3	1.54	0.89
2:J:456:GLN:NE2	2:J:465:ARG:HH21	1.70	0.89
1:O:18:GLU:O	1:O:22:LYS:HG3	1.71	0.89
1:Q:18:GLU:HG3	1:Q:22:LYS:HE3	1.52	0.89
1:A:13:MET:HE2	1:O:116:LYS:CD	2.00	0.89
2:J:456:GLN:NE2	2:J:465:ARG:NH2	2.20	0.89
1:M:170:SER:HG	1:M:183:ILE:HG12	1.38	0.88
2:H:456:GLN:HE21	2:H:465:ARG:NH2	1.69	0.88
1:U:231:GLN:HA	1:U:234:LEU:CD1	2.03	0.88
2:C:355:PHE:HE1	5:C:2910:HOH:O	1.57	0.88
2:H:456:GLN:HE21	2:H:465:ARG:HH21	1.17	0.87
5:S:2958:HOH:O	1:I:112:THR:CG2	2.22	0.87
1:U:231:GLN:O	1:U:234:LEU:HB2	1.74	0.87
2:T:409:ILE:CD1	2:T:410:HIS:CE1	2.58	0.87
1:S:152:HIS:CD2	1:S:171:TYR:CE2	2.63	0.87
2:T:409:ILE:CG1	2:T:410:HIS:ND1	2.37	0.87
1:I:155:VAL:CG1	1:I:160:THR:CG2	2.50	0.86
1:Y:92:ARG:HG2	1:Y:92:ARG:NH1	1.86	0.86
1:I:152:HIS:CG	1:I:171:TYR:HE2	1.93	0.86
2:T:409:ILE:CG1	2:T:410:HIS:CE1	2.58	0.86
2:L:372:VAL:CG2	2:L:373:PRO:HD2	2.05	0.86
2:L:372:VAL:CG2	2:L:373:PRO:CD	2.53	0.85
1:B:8:SER:N	1:B:11:GLN:H	1.73	0.85
1:I:170:SER:OG	1:I:183:ILE:HG23	1.76	0.85
2:V:388:ARG:HD2	5:V:2903:HOH:O	1.76	0.85
1:O:178:THR:HG23	1:O:182:ARG:HH12	1.39	0.85
1:Q:174:ASN:N	1:Q:174:ASN:HD22	1.74	0.85
1:M:163:ILE:HG23	1:M:187:ALA:O	1.76	0.85
2:P:456:GLN:HE21	2:P:465:ARG:HH21	1.25	0.85
1:F:18:GLU:HG3	1:F:22:LYS:HE2	1.59	0.84
1:Y:92:ARG:CG	1:Y:92:ARG:NH1	2.31	0.84
2:G:509:ARG:HD3	5:G:3043:HOH:O	1.75	0.84
1:D:217:ARG:NH1	1:D:217:ARG:CB	2.30	0.84
1:I:163:ILE:HG23	1:I:187:ALA:O	1.77	0.83
2:P:456:GLN:NE2	2:P:465:ARG:HH21	1.75	0.83
1:K:140:ARG:HG2	1:K:140:ARG:HH11	1.42	0.83
1:Y:152:HIS:CG	1:Y:171:TYR:CE2	2.67	0.83
1:Y:25:ALA:O	1:Y:158:GLY:HA2	1.79	0.83
1:Q:31:VAL:HG22	1:Q:155:VAL:HG22	1.58	0.82
1:B:31:VAL:HG22	1:B:155:VAL:HG22	1.61	0.82

Continued on next page...

Continued from previous page...

Atom-1	Atom-2	Interatomic distance (Å)	Clash overlap (Å)
1:1:152:HIS:CB	1:1:171:TYR:CE2	2.62	0.82
1:K:31:VAL:HG22	1:K:155:VAL:HG22	1.61	0.82
1:W:31:VAL:HG22	1:W:155:VAL:HG22	1.60	0.82
1:M:31:VAL:HG22	1:M:155:VAL:HG22	1.61	0.82
1:O:178:THR:HG22	1:O:182:ARG:NH1	1.92	0.82
1:D:217:ARG:HH21	1:D:223:ARG:HB3	1.45	0.82
1:W:8:SER:N	1:W:12:ALA:H	1.78	0.82
1:A:230:LEU:O	1:A:234:LEU:HD13	1.80	0.82
1:O:182:ARG:HD3	1:O:234:LEU:HA	1.62	0.81
1:B:170:SER:HG	1:B:183:ILE:HG23	1.41	0.81
2:L:372:VAL:HG22	2:L:373:PRO:HD2	1.62	0.81
2:N:456:GLN:NE2	2:N:465:ARG:HH21	1.78	0.81
1:D:31:VAL:HG22	1:D:155:VAL:HG22	1.61	0.81
1:S:28:LYS:HE3	1:S:46:PRO:HG2	1.61	0.81
1:S:170:SER:O	1:S:183:ILE:HD11	1.80	0.81
1:B:205:VAL:HG23	1:B:206:ALA:H	1.46	0.80
2:C:355:PHE:CE1	5:C:2910:HOH:O	2.31	0.80
1:S:31:VAL:HG22	1:S:155:VAL:HG22	1.63	0.80
1:U:31:VAL:HG22	1:U:155:VAL:HG22	1.63	0.80
1:I:31:VAL:HG22	1:I:155:VAL:HG22	1.60	0.80
2:N:456:GLN:HE21	2:N:465:ARG:HH21	1.25	0.80
1:Q:171:TYR:CE2	1:Q:173:GLU:HG3	2.14	0.80
1:Y:8:SER:OG	1:Y:11:GLN:CG	2.30	0.80
2:J:382:ARG:NH2	2:J:385:ILE:HD13	1.97	0.80
1:S:150:GLU:OE1	1:S:150:GLU:CA	2.30	0.80
1:Y:8:SER:OG	1:Y:11:GLN:CB	2.30	0.80
2:L:509:ARG:HD3	5:L:2882:HOH:O	1.81	0.80
1:D:152:HIS:HB3	1:D:171:TYR:CE1	2.17	0.79
1:S:170:SER:OG	1:S:183:ILE:CG1	2.29	0.79
1:Y:31:VAL:HG22	1:Y:155:VAL:HG22	1.64	0.79
1:O:179:ASP:O	1:O:183:ILE:CG2	2.30	0.79
1:W:179:ASP:O	1:W:183:ILE:HG13	1.82	0.79
1:Q:112:THR:CG2	1:Y:115:ALA:HB3	2.12	0.79
1:I:185:VAL:O	1:I:189:ARG:HG3	1.82	0.79
1:A:31:VAL:HG22	1:A:155:VAL:HG22	1.63	0.79
1:D:234:LEU:O	1:D:234:LEU:CD2	2.30	0.79
1:U:135:ARG:HD3	1:I:48:ARG:HH12	1.48	0.79
1:M:152:HIS:HB3	1:M:171:TYR:CE2	2.17	0.79
2:J:392:ALA:HA	2:J:395:MET:CE	2.11	0.78
1:K:18:GLU:CD	1:K:21:ARG:HH12	1.86	0.78
2:V:306:LEU:HD12	2:V:313:VAL:HG12	1.65	0.78

Continued on next page...

Continued from previous page...

Atom-1	Atom-2	Interatomic distance (Å)	Clash overlap (Å)
1:Y:20:ALA:O	1:Y:24:ILE:HG13	1.83	0.78
2:2:409:ILE:HG23	5:2:2949:HOH:O	1.83	0.78
1:W:25:ALA:O	1:W:158:GLY:HA2	1.83	0.78
1:1:155:VAL:HG11	1:1:160:THR:HG23	1.65	0.78
1:S:121:GLU:HG3	5:S:3022:HOH:O	1.81	0.78
2:L:372:VAL:HG22	2:L:373:PRO:CD	2.12	0.78
1:Q:25:ALA:O	1:Q:158:GLY:HA2	1.83	0.78
1:K:45:ASN:HD22	1:K:52:LYS:HG3	1.47	0.78
1:A:25:ALA:O	1:A:158:GLY:HA2	1.84	0.78
1:D:50:LEU:CD2	5:D:2921:HOH:O	2.31	0.78
2:L:306:LEU:HD12	2:L:313:VAL:CG1	2.14	0.78
1:I:30:VAL:HG13	1:I:43:ALA:HB2	1.65	0.78
1:Y:19:LEU:C	1:Y:19:LEU:HD23	2.04	0.78
2:L:456:GLN:HE22	2:L:465:ARG:HH22	0.82	0.78
1:O:31:VAL:HG22	1:O:155:VAL:HG22	1.64	0.77
1:O:166:ALA:O	1:O:170:SER:CB	2.32	0.77
1:D:39:VAL:HG23	1:D:127:VAL:CG1	2.15	0.77
1:M:163:ILE:HG23	1:M:187:ALA:C	2.04	0.77
1:S:25:ALA:O	1:S:158:GLY:HA2	1.84	0.77
1:D:25:ALA:O	1:D:158:GLY:HA2	1.84	0.77
1:O:173:GLU:CG	1:O:174:ASN:OD1	2.32	0.76
1:U:25:ALA:O	1:U:158:GLY:HA2	1.85	0.76
1:M:25:ALA:O	1:M:158:GLY:HA2	1.85	0.76
1:W:180:ALA:HA	1:W:183:ILE:HD12	1.65	0.76
1:1:205:VAL:HG12	1:1:230:LEU:HG	1.66	0.76
1:D:177:LEU:CD2	1:D:233:LEU:HD21	2.15	0.76
1:F:31:VAL:HG22	1:F:155:VAL:HG22	1.66	0.76
1:D:152:HIS:CD2	1:D:171:TYR:CE2	2.73	0.76
1:Q:105:GLN:HG3	1:Y:73:ASN:HD21	1.49	0.76
1:O:173:GLU:HG2	1:O:174:ASN:OD1	1.84	0.76
1:U:163:ILE:HG23	1:U:187:ALA:O	1.86	0.76
1:W:48:ARG:NH2	1:Y:137:GLU:HG2	2.01	0.76
1:Q:112:THR:HG23	1:Y:115:ALA:HB3	1.67	0.76
1:S:182:ARG:HH21	1:S:235:VAL:HB	1.51	0.75
1:Y:229:ALA:O	1:Y:233:LEU:CD1	2.29	0.75
1:D:217:ARG:HB2	1:D:217:ARG:HH11	0.72	0.75
2:2:319:ARG:HD3	5:2:877:HOH:O	1.86	0.75
1:S:176:SER:HB3	5:S:2939:HOH:O	1.85	0.75
1:1:179:ASP:O	1:1:183:ILE:CG2	2.30	0.75
1:D:48:ARG:HG3	1:K:149:ASP:OD1	1.85	0.75
2:C:515:ARG:HD2	5:C:1980:HOH:O	1.87	0.75

Continued on next page...

Continued from previous page...

Atom-1	Atom-2	Interatomic distance (Å)	Clash overlap (Å)
2:L:306:LEU:CD1	2:L:313:VAL:CG1	2.64	0.75
1:W:30:VAL:HG13	1:W:43:ALA:HB2	1.69	0.75
2:X:456:GLN:HE21	2:X:465:ARG:HH21	1.33	0.74
1:1:152:HIS:CG	1:1:171:TYR:CE2	2.75	0.74
1:Y:92:ARG:HH11	1:Y:92:ARG:HG3	1.52	0.74
1:D:30:VAL:HG13	1:D:43:ALA:HB2	1.68	0.74
2:E:456:GLN:HE21	2:E:465:ARG:NH2	1.85	0.74
1:O:152:HIS:CB	1:O:171:TYR:CE2	2.68	0.74
1:U:230:LEU:O	1:U:234:LEU:HG	1.86	0.74
1:B:25:ALA:O	1:B:158:GLY:HA2	1.86	0.74
1:B:41:PHE:HB3	1:B:53:ILE:HD13	1.67	0.74
1:Y:41:PHE:HB3	1:Y:53:ILE:HD13	1.70	0.74
1:B:15:GLU:OE1	1:I:9:PRO:HD2	1.88	0.73
1:D:184:ALA:O	1:D:188:LEU:HD13	1.87	0.73
2:L:372:VAL:HG23	2:L:373:PRO:CD	2.19	0.73
1:Q:10:GLU:HG3	1:Y:15:GLU:CD	2.08	0.73
2:C:456:GLN:HE21	2:C:465:ARG:HH21	1.36	0.73
1:O:178:THR:HG22	1:O:182:ARG:CZ	2.18	0.73
1:D:152:HIS:CB	1:D:171:TYR:CZ	2.70	0.73
1:D:48:ARG:HH12	1:K:137:GLU:CB	2.02	0.73
1:F:85:ARG:HB3	5:F:3030:HOH:O	1.89	0.73
2:2:456:GLN:NE2	2:2:465:ARG:HH21	1.87	0.73
1:1:161:GLU:HB2	1:1:162:PRO:CD	2.19	0.73
1:Y:30:VAL:HG13	1:Y:43:ALA:HB2	1.71	0.72
2:2:412:SER:O	2:2:414:PRO:HD3	1.89	0.72
2:V:451:LYS:HE3	5:V:1254:HOH:O	1.87	0.72
1:W:189:ARG:C	1:W:191:GLY:N	2.39	0.72
1:S:49:SER:C	1:S:50:LEU:HD23	2.10	0.72
1:D:48:ARG:CD	1:K:149:ASP:OD1	2.37	0.72
2:H:409:ILE:HG12	5:H:2877:HOH:O	1.88	0.72
1:D:178:THR:CG2	1:D:233:LEU:O	2.38	0.72
1:1:97:ARG:NH2	1:1:101:ASN:HD22	1.87	0.72
1:I:56:LEU:HG	1:I:62:PHE:HB2	1.71	0.72
2:J:362:GLU:OE2	2:J:382:ARG:HD3	1.89	0.72
1:F:19:LEU:HD21	1:W:13:MET:HE1	1.72	0.72
1:S:152:HIS:HB3	1:S:171:TYR:CE2	2.25	0.72
1:B:30:VAL:HG13	1:B:43:ALA:HB2	1.72	0.71
1:F:15:GLU:HB3	1:W:10:GLU:HG3	1.72	0.71
2:H:329:ARG:HD3	5:H:3008:HOH:O	1.89	0.71
1:Q:205:VAL:HG11	1:Q:231:GLN:HE22	1.55	0.71
1:Y:85:ARG:HD2	5:Y:1301:HOH:O	1.89	0.71

Continued on next page...

Continued from previous page...

Atom-1	Atom-2	Interatomic distance (Å)	Clash overlap (Å)
1:Y:233:LEU:N	1:Y:233:LEU:HD12	2.04	0.71
1:W:41:PHE:HB3	1:W:53:ILE:HD13	1.72	0.71
1:F:167:LEU:HA	1:F:170:SER:CB	2.20	0.71
1:O:163:ILE:HD13	1:O:188:LEU:HA	1.72	0.71
1:M:170:SER:OG	1:M:183:ILE:CG1	2.36	0.71
2:G:456:GLN:HE21	2:G:465:ARG:HH21	1.38	0.71
1:D:217:ARG:HG3	1:D:218:PRO:HD2	1.72	0.71
1:S:30:VAL:HG13	1:S:43:ALA:HB2	1.73	0.71
2:T:456:GLN:NE2	2:T:465:ARG:HH21	1.88	0.71
1:1:135:ARG:NH2	1:1:173:GLU:OE2	2.24	0.71
1:1:180:ALA:HA	1:1:183:ILE:CG2	2.21	0.70
2:J:456:GLN:HE22	2:J:465:ARG:HH21	1.36	0.70
1:O:41:PHE:HB3	1:O:53:ILE:HD13	1.73	0.70
1:D:177:LEU:HD23	1:D:233:LEU:CD2	2.20	0.70
1:I:16:ARG:HB3	1:I:117:PRO:HG2	1.72	0.70
1:Y:152:HIS:HB3	1:Y:171:TYR:CE2	2.25	0.70
1:O:30:VAL:HG13	1:O:43:ALA:HB2	1.74	0.70
1:D:51:GLN:HG2	1:D:209:GLU:OE2	1.91	0.70
1:D:173:GLU:C	1:D:174:ASN:OD1	2.29	0.70
1:F:170:SER:OG	1:F:183:ILE:HD12	1.92	0.70
5:S:2958:HOH:O	1:1:112:THR:HG21	1.90	0.70
1:D:177:LEU:CD2	1:D:233:LEU:CD2	2.69	0.70
1:M:18:GLU:HG3	1:M:22:LYS:HE3	1.74	0.70
1:O:166:ALA:O	1:O:170:SER:HB2	1.92	0.70
1:Q:41:PHE:HB3	1:Q:53:ILE:HD13	1.73	0.70
1:A:30:VAL:HG13	1:A:43:ALA:HB2	1.74	0.70
2:L:456:GLN:NE2	2:L:465:ARG:NH2	2.30	0.70
1:W:45:ASN:OD1	1:W:46:PRO:HD2	1.90	0.70
1:D:8:SER:HA	1:Q:15:GLU:OE2	1.92	0.69
1:S:28:LYS:HE3	1:S:46:PRO:CG	2.22	0.69
1:S:230:LEU:HG	1:S:234:LEU:HD11	1.74	0.69
1:U:30:VAL:HG13	1:U:43:ALA:HB2	1.75	0.69
1:S:231:GLN:HA	1:S:234:LEU:HD12	1.73	0.69
1:Y:18:GLU:CD	1:Y:21:ARG:HH12	1.96	0.69
1:I:25:ALA:O	1:I:158:GLY:HA2	1.92	0.69
1:M:177:LEU:HD21	1:M:233:LEU:HD21	1.74	0.69
2:N:465:ARG:HD2	5:N:2586:HOH:O	1.93	0.69
5:S:2958:HOH:O	1:1:112:THR:HG22	1.89	0.69
2:V:306:LEU:CD1	2:V:313:VAL:HG12	2.23	0.69
1:Y:45:ASN:ND2	1:Y:52:LYS:HG3	2.08	0.69
1:Y:231:GLN:O	1:Y:235:VAL:HG23	1.92	0.69

Continued on next page...

Continued from previous page...

Atom-1	Atom-2	Interatomic distance (Å)	Clash overlap (Å)
2:Z:456:GLN:HE22	2:Z:465:ARG:NH1	1.85	0.69
2:Z:508:SER:O	2:Z:512:GLU:HG3	1.93	0.69
1:A:13:MET:HE3	1:O:116:LYS:CD	2.21	0.69
1:F:18:GLU:O	1:F:22:LYS:HG3	1.93	0.69
2:G:324:ASN:HB2	5:G:2032:HOH:O	1.93	0.69
1:A:41:PHE:HB3	1:A:53:ILE:HD13	1.75	0.69
1:M:161:GLU:HB2	1:M:162:PRO:CD	2.23	0.69
1:U:41:PHE:HB3	1:U:53:ILE:HD13	1.73	0.68
1:D:177:LEU:O	1:D:181:LEU:CB	2.40	0.68
1:U:205:VAL:HG12	1:U:234:LEU:HD13	1.75	0.68
1:D:41:PHE:HB3	1:D:53:ILE:HD13	1.75	0.68
1:K:230:LEU:O	1:K:234:LEU:HD13	1.94	0.68
1:S:41:PHE:HB3	1:S:53:ILE:HD13	1.76	0.68
1:F:140:ARG:HD3	1:F:154:VAL:HG13	1.76	0.68
2:X:375:THR:HG21	1:Y:92:ARG:HB3	1.74	0.68
1:D:177:LEU:HG	1:D:233:LEU:HD23	1.73	0.68
1:M:140:ARG:HD3	1:M:154:VAL:HG13	1.76	0.68
1:O:152:HIS:CG	1:O:171:TYR:HE2	2.11	0.68
1:Q:140:ARG:HD3	1:Q:154:VAL:HG13	1.75	0.68
1:S:121:GLU:HA	5:S:3022:HOH:O	1.92	0.68
1:S:132:GLU:HG3	1:S:133:THR:H	1.59	0.68
1:D:177:LEU:O	1:D:181:LEU:HB3	1.94	0.68
1:F:21:ARG:HG2	5:F:1785:HOH:O	1.92	0.68
1:I:41:PHE:HB3	1:I:53:ILE:HD13	1.75	0.68
1:K:142:THR:CA	5:K:2919:HOH:O	2.32	0.68
1:Q:181:LEU:HD23	1:Q:233:LEU:HB3	1.76	0.68
2:J:392:ALA:HA	2:J:395:MET:HE2	1.74	0.68
1:K:41:PHE:HB3	1:K:53:ILE:HD13	1.75	0.68
1:Q:181:LEU:O	1:Q:185:VAL:HG23	1.93	0.68
1:S:140:ARG:HD3	1:S:154:VAL:HG13	1.76	0.68
1:K:116:LYS:HD2	1:M:13:MET:HE1	1.77	0.67
2:J:382:ARG:NH2	2:J:385:ILE:CD1	2.57	0.67
1:Y:140:ARG:HD3	1:Y:154:VAL:HG13	1.76	0.67
1:O:140:ARG:HD3	1:O:154:VAL:HG13	1.77	0.67
1:F:136:PRO:HG3	5:F:2981:HOH:O	1.94	0.67
2:J:382:ARG:HH21	2:J:385:ILE:CD1	2.08	0.67
1:S:76:ARG:HD3	5:S:1506:HOH:O	1.95	0.67
1:S:183:ILE:HG22	1:S:184:ALA:N	2.07	0.67
1:D:181:LEU:O	1:D:185:VAL:HG23	1.95	0.67
1:I:140:ARG:HD3	1:I:154:VAL:HG13	1.76	0.67
2:2:409:ILE:HG12	5:2:2949:HOH:O	1.95	0.67

Continued on next page...

Continued from previous page...

Atom-1	Atom-2	Interatomic distance (Å)	Clash overlap (Å)
1:U:140:ARG:HD3	1:U:154:VAL:HG13	1.75	0.67
2:T:413:ASP:OD2	2:T:413:ASP:C	2.30	0.67
1:W:8:SER:N	1:W:11:GLN:N	2.43	0.67
1:Y:12:ALA:O	1:Y:16:ARG:HG3	1.95	0.66
1:W:228:SER:O	1:W:232:ALA:CB	2.43	0.66
1:1:152:HIS:CD2	1:1:171:TYR:CE2	2.78	0.66
1:B:18:GLU:HG3	1:B:22:LYS:HE3	1.77	0.66
1:D:170:SER:O	1:D:183:ILE:HD11	1.96	0.66
1:I:19:LEU:HD23	1:I:19:LEU:C	2.15	0.66
1:F:73:ASN:HD21	1:W:105:GLN:HG3	1.60	0.66
1:F:170:SER:OG	1:F:183:ILE:CD1	2.43	0.66
1:I:12:ALA:O	1:I:16:ARG:HG3	1.95	0.66
1:K:25:ALA:O	1:K:158:GLY:HA2	1.96	0.66
1:Q:30:VAL:HG13	1:Q:43:ALA:HB2	1.75	0.66
1:S:50:LEU:HD23	1:S:50:LEU:N	2.09	0.66
1:S:132:GLU:CG	1:S:133:THR:N	2.59	0.66
1:W:48:ARG:HH22	1:Y:137:GLU:HG2	1.60	0.66
2:P:456:GLN:NE2	2:P:465:ARG:NH2	2.37	0.66
1:M:30:VAL:HG13	1:M:43:ALA:HB2	1.76	0.66
1:O:152:HIS:CD2	1:O:171:TYR:HE2	2.13	0.66
2:Z:366:TYR:CD2	2:Z:374:LEU:HD13	2.31	0.66
1:1:31:VAL:CG2	1:1:155:VAL:HG22	2.24	0.66
1:1:190:ALA:O	1:1:191:GLY:C	2.34	0.66
1:B:18:GLU:CD	1:B:21:ARG:HH12	1.98	0.65
1:M:28:LYS:HE3	1:M:46:PRO:CG	2.26	0.65
1:Q:161:GLU:HB2	1:Q:162:PRO:HD3	1.78	0.65
2:X:456:GLN:NE2	2:X:465:ARG:HH21	1.94	0.65
2:G:456:GLN:NE2	2:G:465:ARG:HH21	1.94	0.65
1:B:140:ARG:HD3	1:B:154:VAL:HG13	1.77	0.65
1:M:18:GLU:CD	1:M:21:ARG:HH12	2.00	0.65
1:O:19:LEU:C	1:O:19:LEU:HD23	2.17	0.65
1:O:179:ASP:O	1:O:183:ILE:HG22	1.96	0.65
2:T:456:GLN:HE21	2:T:465:ARG:HH21	1.41	0.65
1:U:18:GLU:HG3	1:U:22:LYS:HE3	1.78	0.65
1:1:167:LEU:O	1:1:171:TYR:N	2.30	0.65
1:A:73:ASN:ND2	1:B:105:GLN:OE1	2.30	0.65
1:D:50:LEU:HD23	1:D:50:LEU:N	1.95	0.65
1:D:140:ARG:HD3	1:D:154:VAL:HG13	1.77	0.65
1:K:18:GLU:OE2	1:K:21:ARG:NH1	2.30	0.65
1:F:235:VAL:HA	5:F:778:HOH:O	1.96	0.65
2:J:392:ALA:HA	2:J:395:MET:HE3	1.77	0.65

Continued on next page...

Continued from previous page...

Atom-1	Atom-2	Interatomic distance (Å)	Clash overlap (Å)
1:O:178:THR:HG23	1:O:182:ARG:NH1	2.03	0.65
1:W:8:SER:N	1:W:11:GLN:H	1.95	0.65
1:S:18:GLU:CD	1:S:21:ARG:HH12	1.99	0.65
1:S:52:LYS:NZ	5:S:2897:HOH:O	2.30	0.65
2:R:430:ASN:ND2	5:R:2917:HOH:O	2.30	0.64
1:U:229:ALA:O	1:U:233:LEU:HD13	1.97	0.64
1:Y:45:ASN:HD22	1:Y:52:LYS:HG3	1.62	0.64
1:W:140:ARG:HD3	1:W:154:VAL:HG13	1.78	0.64
1:Y:18:GLU:OE1	1:Y:21:ARG:NH1	2.30	0.64
1:1:18:GLU:OE2	1:1:21:ARG:NH1	2.30	0.64
1:F:173:GLU:O	1:F:174:ASN:HB2	1.97	0.64
1:K:18:GLU:OE1	1:K:21:ARG:NH1	2.30	0.64
1:F:40:LEU:HD12	1:F:212:VAL:HG12	1.77	0.64
1:S:73:ASN:HD21	1:1:105:GLN:HG3	1.63	0.64
1:W:18:GLU:HG3	1:W:22:LYS:HE3	1.79	0.64
1:Y:18:GLU:OE2	1:Y:21:ARG:NH1	2.30	0.64
1:Y:161:GLU:HB2	1:Y:162:PRO:HD3	1.80	0.64
1:W:176:SER:CB	1:W:179:ASP:OD2	2.34	0.64
1:W:181:LEU:CD2	1:W:234:LEU:HD21	2.28	0.64
1:Y:33:LEU:HD11	1:Y:40:LEU:HD23	1.80	0.64
1:1:31:VAL:HG22	1:1:155:VAL:CG2	2.24	0.64
1:1:140:ARG:HD3	1:1:154:VAL:HG13	1.79	0.64
2:E:456:GLN:HE21	2:E:465:ARG:HH21	1.44	0.64
1:F:161:GLU:HB2	1:F:162:PRO:HD3	1.80	0.64
1:K:18:GLU:OE2	1:K:21:ARG:NH2	2.30	0.64
1:O:173:GLU:HG3	1:O:174:ASN:OD1	1.98	0.64
1:Q:174:ASN:N	1:Q:174:ASN:ND2	2.46	0.64
1:Q:181:LEU:HD23	1:Q:233:LEU:CB	2.28	0.64
2:R:432:GLU:OE2	2:R:434:GLU:N	2.29	0.64
1:F:234:LEU:O	1:F:235:VAL:C	2.35	0.64
1:O:155:VAL:HG12	1:O:160:THR:HG22	1.80	0.64
1:S:18:GLU:HG3	1:S:22:LYS:HE3	1.78	0.64
1:S:152:HIS:NE2	1:S:173:GLU:OE2	2.23	0.64
1:K:76:ARG:HD3	5:K:2440:HOH:O	1.96	0.64
1:O:33:LEU:HD21	1:O:184:ALA:HB2	1.80	0.64
2:C:456:GLN:NE2	2:C:465:ARG:HH21	1.96	0.63
1:A:205:VAL:CG1	1:A:206:ALA:N	2.61	0.63
1:D:152:HIS:CG	1:D:171:TYR:CE2	2.87	0.63
1:M:177:LEU:CD2	1:M:233:LEU:HD21	2.28	0.63
1:O:18:GLU:OE2	1:O:21:ARG:NH1	2.30	0.63
1:S:161:GLU:HB2	1:S:162:PRO:HD3	1.78	0.63

Continued on next page...

Continued from previous page...

Atom-1	Atom-2	Interatomic distance (Å)	Clash overlap (Å)
1:D:161:GLU:HB2	1:D:162:PRO:HD3	1.81	0.63
1:F:41:PHE:HB3	1:F:53:ILE:HD13	1.78	0.63
1:Q:230:LEU:O	1:Q:234:LEU:HD13	1.98	0.63
1:W:189:ARG:C	1:W:191:GLY:H	1.98	0.63
1:O:167:LEU:HD13	1:O:187:ALA:CB	2.27	0.63
1:U:161:GLU:HB2	1:U:162:PRO:HD3	1.79	0.63
1:F:40:LEU:HD12	1:F:212:VAL:CG1	2.28	0.63
1:Q:10:GLU:CG	1:Y:15:GLU:OE1	2.33	0.63
1:Y:22:LYS:HG2	1:Y:26:ARG:NH2	2.07	0.63
2:C:511:ALA:O	2:C:515:ARG:HG3	1.99	0.63
1:D:18:GLU:HG3	1:D:22:LYS:HE3	1.81	0.63
2:H:301:THR:N	5:H:3024:HOH:O	2.31	0.63
1:K:11:GLN:OE1	1:K:14:ARG:NH1	2.31	0.63
1:W:161:GLU:HB2	1:W:162:PRO:HD3	1.81	0.63
1:Y:233:LEU:CD1	1:Y:233:LEU:N	2.60	0.63
2:Z:456:GLN:NE2	2:Z:465:ARG:NH1	2.36	0.63
1:A:186:ALA:O	1:A:189:ARG:HB2	1.98	0.63
1:D:10:GLU:HG3	1:Q:15:GLU:CG	2.27	0.63
1:I:97:ARG:NH2	5:I:1244:HOH:O	2.32	0.63
1:I:155:VAL:HG11	1:I:160:THR:CG2	2.21	0.63
1:D:167:LEU:HA	1:D:170:SER:OG	1.99	0.63
1:D:174:ASN:OD1	1:D:174:ASN:N	2.31	0.63
1:I:76:ARG:HD3	5:I:252:HOH:O	1.98	0.63
2:L:372:VAL:HG23	2:L:373:PRO:HD2	1.75	0.63
1:O:115:ALA:HB3	5:O:2956:HOH:O	1.99	0.63
1:D:234:LEU:HD23	1:D:234:LEU:C	2.19	0.62
2:E:456:GLN:NE2	2:E:465:ARG:NH2	2.47	0.62
2:T:366:TYR:CD2	2:T:374:LEU:HD13	2.34	0.62
1:A:18:GLU:CD	1:A:21:ARG:HH12	2.01	0.62
1:K:45:ASN:ND2	1:K:52:LYS:HG3	2.11	0.62
2:L:383:LEU:HD23	2:L:423:PHE:CZ	2.34	0.62
1:O:97:ARG:HD2	1:U:49:SER:HB2	1.82	0.62
2:X:366:TYR:CD2	2:X:374:LEU:HD13	2.33	0.62
1:A:47:SER:OG	1:A:50:LEU:N	2.30	0.62
1:A:161:GLU:HB2	1:A:162:PRO:HD3	1.81	0.62
2:L:306:LEU:HD12	2:L:313:VAL:HG12	1.82	0.62
1:A:18:GLU:HG3	1:A:22:LYS:HE3	1.80	0.62
1:I:180:ALA:O	1:I:183:ILE:HG23	1.99	0.62
1:D:18:GLU:CD	1:D:21:ARG:HH12	2.03	0.62
1:U:205:VAL:HG12	1:U:234:LEU:CD1	2.29	0.62
1:W:18:GLU:CD	1:W:21:ARG:HH12	2.03	0.62

Continued on next page...

Continued from previous page...

Atom-1	Atom-2	Interatomic distance (Å)	Clash overlap (Å)
2:J:413:ASP:OD1	2:J:414:PRO:HD2	1.99	0.62
2:V:366:TYR:CD2	2:V:374:LEU:HD13	2.34	0.62
1:B:161:GLU:HB2	1:B:162:PRO:HD3	1.82	0.62
1:B:178:THR:HG22	1:B:182:ARG:NE	2.15	0.62
1:M:217:ARG:CD	1:M:223:ARG:HH22	2.11	0.62
1:O:166:ALA:O	1:O:170:SER:HB3	1.98	0.62
1:1:204:GLY:N	5:1:2895:HOH:O	2.31	0.62
1:U:13:MET:CE	1:1:116:LYS:HD2	2.30	0.61
1:B:178:THR:HG23	1:B:233:LEU:HA	1.81	0.61
1:O:115:ALA:CB	5:O:2956:HOH:O	2.47	0.61
1:U:18:GLU:CD	1:U:21:ARG:HH12	2.02	0.61
1:A:205:VAL:HG12	1:A:206:ALA:N	2.13	0.61
1:I:16:ARG:HB3	1:I:117:PRO:CG	2.30	0.61
1:I:73:ASN:ND2	1:S:105:GLN:HE21	1.98	0.61
1:M:214:ASP:OD2	1:M:223:ARG:NH2	2.30	0.61
1:M:95:THR:OG1	1:M:98:GLN:HG3	2.01	0.61
2:H:456:GLN:NE2	2:H:465:ARG:NH2	2.35	0.61
1:I:51:GLN:HA	1:I:209:GLU:OE1	2.01	0.61
1:I:161:GLU:HB2	1:I:162:PRO:HD3	1.82	0.61
1:K:116:LYS:HD2	1:M:13:MET:CE	2.30	0.61
1:Y:33:LEU:HD12	1:Y:40:LEU:HB3	1.81	0.61
1:K:8:SER:OG	1:K:11:GLN:HB3	1.99	0.61
1:U:205:VAL:CG1	1:U:234:LEU:HD13	2.30	0.61
1:D:13:MET:HE1	1:Q:19:LEU:CD2	2.21	0.61
1:B:33:LEU:HB3	1:B:153:PHE:HB3	1.82	0.61
1:D:147:ILE:HD13	1:Q:50:LEU:HD21	1.82	0.61
1:U:97:ARG:NH2	5:U:1015:HOH:O	2.33	0.61
1:U:135:ARG:HD3	1:1:48:ARG:NH1	2.14	0.61
1:1:170:SER:O	1:1:183:ILE:HD12	2.00	0.61
1:D:205:VAL:N	1:D:208:LEU:HD13	2.16	0.61
1:F:18:GLU:OE2	1:F:21:ARG:NH1	2.30	0.61
2:L:372:VAL:HG22	2:L:373:PRO:N	2.16	0.61
1:K:161:GLU:HB2	1:K:162:PRO:HD3	1.83	0.60
1:S:181:LEU:HD23	1:S:233:LEU:HB3	1.82	0.60
1:U:181:LEU:O	1:U:185:VAL:HG23	2.01	0.60
1:D:163:ILE:HG23	1:D:187:ALA:C	2.21	0.60
2:J:366:TYR:CD2	2:J:374:LEU:HD13	2.37	0.60
2:L:412:SER:O	2:L:414:PRO:HD3	2.01	0.60
2:G:451:LYS:NZ	2:2:473:ASP:OD1	2.34	0.60
1:Y:18:GLU:CD	1:Y:21:ARG:NH1	2.54	0.60
1:D:181:LEU:HD12	1:D:181:LEU:C	2.18	0.60

Continued on next page...

Continued from previous page...

Atom-1	Atom-2	Interatomic distance (Å)	Clash overlap (Å)
1:I:220:ARG:HH22	2:J:367:GLU:CD	2.05	0.60
2:T:486:LEU:HB2	5:T:1332:HOH:O	2.01	0.60
1:W:163:ILE:HG23	1:W:187:ALA:O	2.02	0.60
1:D:163:ILE:HG23	1:D:187:ALA:O	2.01	0.60
1:Q:58:ASP:OD1	1:Q:219:ARG:NH1	2.35	0.60
2:J:413:ASP:OD1	2:J:413:ASP:C	2.40	0.60
1:K:73:ASN:HD21	1:M:105:GLN:HG3	1.66	0.60
1:Q:165:ASN:HA	1:Q:168:LYS:HD2	1.82	0.60
1:K:167:LEU:CD1	1:K:183:ILE:HG22	2.32	0.60
2:N:456:GLN:HE21	2:N:465:ARG:NH2	1.96	0.60
1:U:13:MET:HE1	1:1:116:LYS:HD2	1.84	0.60
2:2:319:ARG:HG3	2:2:320:SER:N	2.15	0.59
1:A:32:ALA:HA	1:A:40:LEU:O	2.01	0.59
1:K:140:ARG:HG2	1:K:140:ARG:NH1	2.08	0.59
2:2:366:TYR:CD2	2:2:374:LEU:HD13	2.37	0.59
2:L:451:LYS:NZ	2:P:473:ASP:OD1	2.30	0.59
1:S:152:HIS:CG	1:S:171:TYR:CE2	2.91	0.59
1:D:184:ALA:O	1:D:188:LEU:CD1	2.50	0.59
1:Y:152:HIS:CB	1:Y:171:TYR:CE2	2.85	0.59
1:1:97:ARG:NH2	1:1:101:ASN:ND2	2.50	0.59
1:D:48:ARG:NH1	1:K:137:GLU:HG2	2.18	0.59
1:D:152:HIS:HB3	1:D:171:TYR:CE2	2.36	0.59
2:T:392:ALA:HA	2:T:395:MET:CE	2.32	0.59
1:O:33:LEU:HD11	1:O:40:LEU:HD23	1.83	0.59
2:T:444:LEU:HB3	2:X:444:LEU:HD21	1.84	0.59
2:V:306:LEU:CD1	2:V:313:VAL:CG1	2.80	0.59
1:Y:214:ASP:HB3	1:Y:217:ARG:HG2	1.84	0.59
1:A:67:LYS:HG2	1:A:69:ASN:ND2	2.18	0.59
1:B:217:ARG:HH12	1:B:223:ARG:HB3	1.67	0.59
1:F:170:SER:OG	1:F:183:ILE:HG23	2.03	0.59
1:B:181:LEU:O	1:B:185:VAL:HG23	2.03	0.59
1:Y:225:ILE:HG21	1:Y:233:LEU:HD22	1.84	0.59
1:D:164:ALA:O	1:D:167:LEU:N	2.35	0.59
1:M:98:GLN:O	1:M:102:VAL:HG23	2.03	0.58
2:X:456:GLN:HE21	2:X:465:ARG:NH2	2.00	0.58
2:H:417:ALA:HA	5:H:3049:HOH:O	2.02	0.58
1:K:181:LEU:HD21	1:K:234:LEU:CD1	2.33	0.58
1:Y:232:ALA:HA	1:Y:235:VAL:CG2	2.33	0.58
1:D:161:GLU:C	1:D:165:ASN:HD22	2.03	0.58
2:2:456:GLN:HE21	2:2:465:ARG:NH2	2.00	0.58
1:D:39:VAL:HG23	1:D:127:VAL:HG12	1.85	0.58

Continued on next page...

Continued from previous page...

Atom-1	Atom-2	Interatomic distance (Å)	Clash overlap (Å)
1:O:178:THR:HG22	1:O:182:ARG:NH2	2.17	0.58
1:Q:12:ALA:O	1:Q:16:ARG:HG3	2.02	0.58
1:Y:19:LEU:HD23	1:Y:19:LEU:O	2.03	0.58
1:I:220:ARG:NH2	2:J:367:GLU:OE2	2.36	0.58
2:L:382:ARG:NH2	2:L:385:ILE:HD13	2.19	0.58
1:S:152:HIS:HD2	1:S:171:TYR:CE2	2.20	0.58
1:B:178:THR:O	1:B:182:ARG:HD2	2.04	0.58
1:F:115:ALA:HB3	1:W:112:THR:CG2	2.33	0.58
1:K:87:TYR:O	2:L:357:ARG:NH2	2.35	0.58
1:K:115:ALA:HB3	1:M:112:THR:HG23	1.86	0.58
2:R:430:ASN:ND2	5:R:548:HOH:O	2.30	0.58
1:S:19:LEU:HD21	1:I:13:MET:HE2	1.85	0.58
1:S:170:SER:OG	1:S:183:ILE:CD1	2.52	0.58
1:D:105:GLN:HE21	1:Q:73:ASN:ND2	2.01	0.58
1:I:73:ASN:HD21	1:S:105:GLN:HG3	1.67	0.58
1:D:189:ARG:O	1:D:190:ALA:C	2.42	0.58
2:E:320:SER:HB3	2:E:328:GLY:HA3	1.86	0.58
1:I:130:TYR:C	1:I:132:GLU:H	2.08	0.58
1:I:161:GLU:HB2	1:I:162:PRO:HD3	1.86	0.58
1:F:25:ALA:O	1:F:158:GLY:HA2	2.04	0.57
1:F:166:ALA:O	1:F:170:SER:CB	2.36	0.57
2:L:306:LEU:CD1	2:L:313:VAL:HG13	2.33	0.57
1:Q:105:GLN:HG3	1:Y:73:ASN:ND2	2.19	0.57
1:U:167:LEU:HA	1:U:170:SER:HB3	1.85	0.57
1:Y:76:ARG:NH2	5:Y:2938:HOH:O	2.37	0.57
1:Y:128:ALA:HB2	1:Y:134:LYS:HB3	1.85	0.57
1:A:33:LEU:HB3	1:A:153:PHE:HB3	1.85	0.57
1:A:170:SER:OG	1:A:183:ILE:CG2	2.49	0.57
2:C:324:ASN:HB2	5:C:2066:HOH:O	2.03	0.57
1:O:205:VAL:C	1:O:207:SER:H	2.08	0.57
2:V:306:LEU:HD11	2:V:313:VAL:CG1	2.34	0.57
2:L:511:ALA:O	2:L:515:ARG:HG3	2.04	0.57
1:O:11:GLN:O	1:O:15:GLU:CG	2.52	0.57
1:U:105:GLN:HG3	1:I:73:ASN:HD21	1.68	0.57
1:K:167:LEU:HD12	1:K:183:ILE:HG22	1.84	0.57
2:V:362:GLU:OE2	2:V:382:ARG:HD3	2.05	0.57
1:Y:135:ARG:NH1	1:Y:135:ARG:HG3	2.18	0.57
1:Y:141:ILE:N	1:Y:141:ILE:HD12	2.19	0.57
1:K:140:ARG:HD3	1:K:154:VAL:HG13	1.87	0.57
1:O:164:ALA:O	1:O:168:LYS:N	2.30	0.57
2:T:413:ASP:OD2	2:T:414:PRO:N	2.37	0.57

Continued on next page...

Continued from previous page...

Atom-1	Atom-2	Interatomic distance (Å)	Clash overlap (Å)
1:B:217:ARG:NH1	1:B:217:ARG:HG3	2.19	0.57
2:C:515:ARG:NH2	5:C:1432:HOH:O	2.37	0.57
1:D:49:SER:O	1:D:50:LEU:CD2	2.48	0.57
1:W:228:SER:O	1:W:232:ALA:N	2.33	0.57
1:Y:232:ALA:HA	1:Y:235:VAL:HG23	1.86	0.57
1:A:105:GLN:HG3	1:O:73:ASN:HD21	1.70	0.57
1:B:217:ARG:HG3	1:B:217:ARG:HH11	1.69	0.57
1:M:161:GLU:HB2	1:M:162:PRO:HD2	1.86	0.57
1:O:110:ILE:HA	1:O:114:GLN:HG3	1.87	0.57
1:B:182:ARG:NE	1:B:233:LEU:O	2.33	0.57
1:D:152:HIS:CD2	1:D:171:TYR:HE2	2.19	0.57
2:C:508:SER:O	2:C:512:GLU:HG3	2.05	0.56
2:N:366:TYR:CD2	2:N:374:LEU:HD13	2.40	0.56
2:R:366:TYR:CD2	2:R:374:LEU:HD13	2.40	0.56
2:V:362:GLU:OE2	2:V:382:ARG:CD	2.53	0.56
1:W:181:LEU:HD21	1:W:234:LEU:HD21	1.86	0.56
1:I:129:HIS:O	1:I:132:GLU:HB3	2.05	0.56
1:D:161:GLU:O	1:D:162:PRO:C	2.42	0.56
2:L:306:LEU:HD11	2:L:313:VAL:CG1	2.35	0.56
1:Y:135:ARG:HG3	1:Y:135:ARG:HH11	1.69	0.56
1:D:48:ARG:HG3	1:D:49:SER:H	1.70	0.56
1:I:185:VAL:O	1:I:189:ARG:N	2.30	0.56
1:O:179:ASP:O	1:O:183:ILE:HG23	2.03	0.56
2:T:451:LYS:NZ	2:X:473:ASP:OD1	2.30	0.56
1:A:205:VAL:O	1:A:206:ALA:HB3	2.05	0.56
1:D:161:GLU:O	1:D:165:ASN:ND2	2.27	0.56
1:D:178:THR:HG23	1:D:233:LEU:O	2.04	0.56
1:F:115:ALA:HB3	1:W:112:THR:HG23	1.88	0.56
1:I:230:LEU:O	1:I:234:LEU:HD22	2.05	0.56
1:I:114:GLN:NE2	5:I:1024:HOH:O	2.39	0.56
2:P:366:TYR:CD2	2:P:374:LEU:HD13	2.40	0.56
1:Q:179:ASP:O	1:Q:183:ILE:HG13	2.06	0.56
1:B:179:ASP:O	1:B:183:ILE:HG13	2.05	0.56
2:G:307:LYS:HG3	2:G:312:VAL:HG12	1.88	0.56
1:D:170:SER:O	1:D:183:ILE:CD1	2.53	0.56
1:Q:233:LEU:HD12	1:Q:233:LEU:N	2.21	0.56
1:A:116:LYS:HD2	1:B:13:MET:HE1	1.88	0.56
2:C:509:ARG:O	2:C:513:LEU:HD22	2.06	0.56
2:L:306:LEU:HD12	2:L:313:VAL:HG13	1.86	0.56
2:J:511:ALA:O	2:J:515:ARG:HG3	2.06	0.56
1:B:141:ILE:N	1:B:141:ILE:HD12	2.20	0.55

Continued on next page...

Continued from previous page...

Atom-1	Atom-2	Interatomic distance (Å)	Clash overlap (Å)
1:D:73:ASN:HD21	1:K:105:GLN:HG3	1.71	0.55
1:I:115:ALA:HB3	1:S:112:THR:CG2	2.37	0.55
1:S:132:GLU:HG3	1:S:133:THR:N	2.18	0.55
1:Y:19:LEU:C	1:Y:19:LEU:CD2	2.75	0.55
1:M:141:ILE:N	1:M:141:ILE:HD12	2.21	0.55
1:A:179:ASP:O	1:A:183:ILE:HG13	2.06	0.55
2:G:509:ARG:NH1	2:G:509:ARG:HG3	2.22	0.55
1:1:25:ALA:O	1:1:158:GLY:HA2	2.05	0.55
1:1:180:ALA:HA	1:1:183:ILE:HG23	1.88	0.55
1:O:51:GLN:HG2	1:O:209:GLU:OE2	2.07	0.55
1:F:185:VAL:O	1:F:189:ARG:N	2.28	0.55
1:Q:136:PRO:O	1:Y:48:ARG:NH2	2.32	0.55
2:V:515:ARG:HD3	5:V:2326:HOH:O	2.06	0.55
1:B:49:SER:HB2	1:I:97:ARG:HD2	1.89	0.55
1:O:19:LEU:HD23	1:O:19:LEU:O	2.07	0.55
2:C:432:GLU:HB2	5:C:135:HOH:O	2.06	0.55
1:W:189:ARG:O	1:W:191:GLY:N	2.40	0.55
1:Y:22:LYS:CG	1:Y:26:ARG:HH21	2.08	0.55
1:D:163:ILE:O	1:D:187:ALA:HB1	2.07	0.55
1:D:217:ARG:NH2	1:D:223:ARG:HB3	2.19	0.55
1:K:19:LEU:HD21	1:M:13:MET:HE2	1.89	0.55
1:B:8:SER:HB3	1:B:11:GLN:HB3	1.89	0.55
2:C:366:TYR:CD2	2:C:374:LEU:HD13	2.42	0.55
1:I:19:LEU:HD23	1:I:19:LEU:O	2.07	0.55
2:T:392:ALA:HA	2:T:395:MET:HE2	1.88	0.55
2:V:392:ALA:HA	2:V:395:MET:CE	2.36	0.55
2:Z:437:GLN:OE1	2:Z:447:LYS:HD3	2.07	0.55
1:1:141:ILE:N	1:1:141:ILE:HD12	2.22	0.55
2:C:451:LYS:NZ	2:R:473:ASP:OD1	2.39	0.55
1:I:45:ASN:ND2	1:I:50:LEU:O	2.38	0.55
2:P:508:SER:O	2:P:512:GLU:HG3	2.07	0.55
1:U:129:HIS:HE1	5:U:2960:HOH:O	1.89	0.55
1:D:58:ASP:OD2	1:D:219:ARG:HD2	2.08	0.54
1:O:97:ARG:NH2	5:O:1513:HOH:O	2.40	0.54
2:P:341:THR:CG2	2:P:404:LEU:HD11	2.37	0.54
1:1:8:SER:OG	1:1:11:GLN:HB3	2.07	0.54
1:B:76:ARG:HD3	5:B:341:HOH:O	2.07	0.54
1:I:15:GLU:HG2	1:S:10:GLU:HG3	1.89	0.54
1:U:141:ILE:HD12	1:U:141:ILE:N	2.21	0.54
2:V:444:LEU:HB2	5:V:855:HOH:O	2.06	0.54
2:H:422:SER:HB3	2:H:437:GLN:HG2	1.90	0.54

Continued on next page...

Continued from previous page...

Atom-1	Atom-2	Interatomic distance (Å)	Clash overlap (Å)
1:O:183:ILE:HG12	1:O:184:ALA:N	2.21	0.54
2:T:382:ARG:NH2	2:T:385:ILE:HD13	2.22	0.54
1:U:205:VAL:CG1	1:U:234:LEU:CD1	2.86	0.54
1:Y:234:LEU:O	1:Y:235:VAL:C	2.46	0.54
1:D:178:THR:HG22	1:D:233:LEU:O	2.05	0.54
1:1:130:TYR:O	1:1:132:GLU:N	2.40	0.54
2:2:456:GLN:NE2	2:2:465:ARG:NH2	2.56	0.54
1:B:173:GLU:O	1:B:174:ASN:HB2	2.06	0.54
2:R:308:TYR:CZ	2:R:311:GLY:HA3	2.42	0.54
1:Y:8:SER:HB2	1:Y:11:GLN:CB	2.32	0.54
1:1:166:ALA:O	1:1:170:SER:N	2.38	0.54
1:K:98:GLN:O	1:K:102:VAL:HG23	2.07	0.54
2:C:407:TYR:CE1	2:C:417:ALA:HB3	2.43	0.54
1:F:30:VAL:HG13	1:F:43:ALA:HB2	1.90	0.54
1:I:170:SER:OG	1:I:183:ILE:CG2	2.53	0.54
1:K:18:GLU:CD	1:K:21:ARG:NH1	2.58	0.54
1:O:205:VAL:HG21	1:O:231:GLN:HE22	1.71	0.54
1:O:11:GLN:O	1:O:15:GLU:HG3	2.08	0.54
1:Y:12:ALA:C	1:Y:14:ARG:H	2.12	0.54
1:Y:13:MET:O	1:Y:13:MET:HG3	2.07	0.54
2:J:456:GLN:HE21	2:J:465:ARG:NH2	2.00	0.54
1:K:181:LEU:CD2	1:K:234:LEU:HD12	2.38	0.54
2:V:382:ARG:NH2	2:V:385:ILE:HD13	2.22	0.54
1:Y:80:GLN:HG2	5:Y:1507:HOH:O	2.06	0.54
1:1:205:VAL:HG13	1:1:234:LEU:HD12	1.90	0.54
1:D:74:LEU:HD13	1:D:122:LEU:HD11	1.90	0.53
2:X:341:THR:CG2	2:X:404:LEU:HD11	2.39	0.53
1:D:173:GLU:CB	1:D:174:ASN:OD1	2.46	0.53
1:O:152:HIS:HB3	1:O:171:TYR:CZ	2.42	0.53
1:S:205:VAL:CG2	5:S:2979:HOH:O	2.56	0.53
1:W:226:THR:OG1	1:W:227:GLY:N	2.40	0.53
1:F:90:ASP:HB3	1:F:93:ASP:OD2	2.08	0.53
1:W:228:SER:O	1:W:232:ALA:HB2	2.08	0.53
2:Z:366:TYR:CE2	2:Z:374:LEU:HD13	2.42	0.53
2:E:366:TYR:CD2	2:E:374:LEU:HD13	2.43	0.53
1:F:142:THR:OG1	1:F:144:ASP:OD1	2.26	0.53
1:Q:164:ALA:HB1	1:Q:168:LYS:HE3	1.89	0.53
1:S:231:GLN:CA	1:S:234:LEU:HD12	2.37	0.53
2:X:366:TYR:CG	2:X:374:LEU:HD13	2.43	0.53
2:E:452:LYS:NZ	5:E:814:HOH:O	2.33	0.53
1:M:181:LEU:CD2	1:M:233:LEU:HB3	2.39	0.53

Continued on next page...

Continued from previous page...

Atom-1	Atom-2	Interatomic distance (Å)	Clash overlap (Å)
1:O:74:LEU:HD13	1:O:122:LEU:HD11	1.90	0.53
1:W:141:ILE:HD12	1:W:141:ILE:N	2.24	0.53
1:M:152:HIS:CD2	1:M:171:TYR:HE2	2.27	0.53
2:2:320:SER:HB3	2:2:328:GLY:HA3	1.90	0.53
1:S:8:SER:OG	1:S:11:GLN:HB3	2.09	0.53
1:S:74:LEU:HD13	1:S:122:LEU:HD11	1.91	0.53
1:U:171:TYR:C	1:U:171:TYR:CD2	2.81	0.53
1:W:28:LYS:HB2	1:W:52:LYS:NZ	2.24	0.53
1:B:19:LEU:HD23	1:B:19:LEU:O	2.08	0.53
1:O:152:HIS:CG	1:O:171:TYR:CE2	2.93	0.53
1:U:166:ALA:O	1:U:170:SER:CB	2.49	0.53
1:Y:125:ALA:HB2	1:Y:138:LEU:HD23	1.91	0.53
1:K:181:LEU:HD21	1:K:234:LEU:HD11	1.90	0.52
1:Y:152:HIS:CB	1:Y:171:TYR:CZ	2.86	0.52
2:C:416:SER:HA	5:C:2935:HOH:O	2.08	0.52
1:Q:205:VAL:HG21	1:Q:231:GLN:HE21	1.75	0.52
2:2:456:GLN:HE21	2:2:465:ARG:HH21	1.53	0.52
2:G:456:GLN:HE21	2:G:465:ARG:NH2	2.04	0.52
1:I:74:LEU:HD13	1:I:122:LEU:HD11	1.92	0.52
2:V:366:TYR:CG	2:V:374:LEU:HD13	2.44	0.52
1:B:22:LYS:HD2	1:I:10:GLU:OE1	2.09	0.52
2:E:515:ARG:NE	5:E:1107:HOH:O	2.38	0.52
1:F:55:GLU:CD	1:F:220:ARG:HH21	2.13	0.52
1:S:115:ALA:HB3	5:S:2958:HOH:O	2.09	0.52
1:B:74:LEU:HD13	1:B:122:LEU:HD11	1.92	0.52
1:D:50:LEU:HD22	5:D:2921:HOH:O	2.01	0.52
2:L:374:LEU:HD11	1:M:89:TYR:CD1	2.45	0.52
2:T:456:GLN:HE21	2:T:465:ARG:NH2	2.06	0.52
1:W:170:SER:OG	1:W:183:ILE:HG23	2.09	0.52
1:A:8:SER:OG	1:A:11:GLN:CB	2.58	0.52
1:O:53:ILE:HD12	1:O:209:GLU:HG2	1.92	0.52
1:Q:205:VAL:HG21	1:Q:231:GLN:NE2	2.24	0.52
1:Q:214:ASP:HB3	1:Q:217:ARG:HG2	1.92	0.52
1:S:141:ILE:HD12	1:S:141:ILE:N	2.24	0.52
2:V:341:THR:CG2	2:V:404:LEU:HD11	2.39	0.52
1:1:30:VAL:HG13	1:1:43:ALA:HB2	1.90	0.52
1:A:19:LEU:HD21	1:B:13:MET:HE2	1.91	0.52
1:M:161:GLU:CB	1:M:162:PRO:CD	2.87	0.52
1:S:121:GLU:CB	5:S:3022:HOH:O	2.57	0.52
2:T:320:SER:HB3	2:T:328:GLY:HA3	1.92	0.52
1:Y:163:ILE:HG23	1:Y:187:ALA:O	2.09	0.52

Continued on next page...

Continued from previous page...

Atom-1	Atom-2	Interatomic distance (Å)	Clash overlap (Å)
2:G:341:THR:CG2	2:G:404:LEU:HD11	2.40	0.52
2:N:392:ALA:HA	2:N:395:MET:CE	2.39	0.52
1:U:205:VAL:HG23	1:U:206:ALA:N	2.24	0.52
1:Y:56:LEU:HG	1:Y:62:PHE:HB2	1.92	0.52
1:A:182:ARG:NH2	5:A:2141:HOH:O	2.41	0.52
1:I:52:LYS:NZ	5:I:1197:HOH:O	2.32	0.52
1:U:13:MET:HE2	1:1:19:LEU:HD21	1.91	0.52
2:Z:366:TYR:CG	2:Z:374:LEU:HD13	2.45	0.52
2:C:422:SER:HB3	2:C:437:GLN:HG2	1.92	0.52
1:D:40:LEU:HD13	1:D:177:LEU:HD11	1.92	0.52
2:J:320:SER:HB3	2:J:328:GLY:HA3	1.92	0.52
1:M:163:ILE:HG23	1:M:188:LEU:HA	1.93	0.52
1:1:173:GLU:O	1:1:174:ASN:HB2	2.09	0.52
2:N:437:GLN:OE1	2:N:447:LYS:HD3	2.10	0.51
2:T:409:ILE:HG12	2:T:410:HIS:ND1	2.24	0.51
1:Y:233:LEU:CD1	1:Y:233:LEU:H	2.21	0.51
2:T:422:SER:HB3	2:T:437:GLN:HG2	1.91	0.51
2:X:362:GLU:HG3	5:X:2197:HOH:O	2.10	0.51
1:A:98:GLN:O	1:A:102:VAL:HG23	2.10	0.51
2:R:456:GLN:NE2	2:R:465:ARG:NH2	2.39	0.51
1:A:8:SER:OG	1:A:11:GLN:HB2	2.09	0.51
1:K:170:SER:OG	1:K:183:ILE:HG23	2.10	0.51
1:Q:233:LEU:C	1:Q:234:LEU:HD12	2.30	0.51
1:W:74:LEU:HD13	1:W:122:LEU:HD11	1.93	0.51
1:D:48:ARG:NH1	1:K:137:GLU:CG	2.74	0.51
1:D:177:LEU:O	1:D:181:LEU:HB2	2.09	0.51
1:D:217:ARG:NH2	1:D:221:ALA:O	2.44	0.51
1:F:18:GLU:OE1	1:F:21:ARG:NH1	2.43	0.51
2:G:320:SER:HB3	2:G:328:GLY:HA3	1.92	0.51
1:I:98:GLN:O	1:I:102:VAL:HG23	2.11	0.51
1:W:163:ILE:HG23	1:W:187:ALA:C	2.31	0.51
1:O:183:ILE:CG1	1:O:184:ALA:N	2.73	0.51
1:D:45:ASN:OD1	1:D:46:PRO:HD2	2.10	0.51
1:W:40:LEU:HD12	1:W:212:VAL:HG12	1.93	0.51
1:Y:11:GLN:O	1:Y:14:ARG:CB	2.59	0.51
1:D:82:ALA:HB2	1:D:99:LEU:HD11	1.92	0.51
1:F:19:LEU:C	1:F:19:LEU:HD23	2.31	0.51
2:L:509:ARG:HH11	2:L:509:ARG:HA	1.74	0.51
1:B:19:LEU:HD23	1:B:19:LEU:C	2.32	0.51
1:A:181:LEU:HD21	1:A:234:LEU:HD11	1.92	0.51
2:C:320:SER:HB3	2:C:328:GLY:HA3	1.93	0.51

Continued on next page...

Continued from previous page...

Atom-1	Atom-2	Interatomic distance (Å)	Clash overlap (Å)
2:H:366:TYR:CD2	2:H:374:LEU:HD13	2.46	0.51
1:Q:52:LYS:HE3	1:Q:64:ALA:O	2.11	0.51
1:Y:8:SER:CB	1:Y:11:GLN:CB	2.76	0.51
1:B:178:THR:HG23	1:B:233:LEU:CA	2.40	0.50
1:D:48:ARG:NE	1:K:149:ASP:OD1	2.44	0.50
1:F:56:LEU:HG	1:F:62:PHE:HB2	1.92	0.50
2:L:324:ASN:ND2	5:L:654:HOH:O	2.44	0.50
2:R:320:SER:HB3	2:R:328:GLY:HA3	1.93	0.50
1:U:95:THR:OG1	1:U:98:GLN:HG3	2.10	0.50
1:A:51:GLN:CG	1:A:209:GLU:OE2	2.45	0.50
1:B:205:VAL:HG23	1:B:206:ALA:N	2.22	0.50
1:I:181:LEU:HD23	1:I:233:LEU:HB3	1.93	0.50
1:K:18:GLU:OE2	1:K:21:ARG:CZ	2.59	0.50
2:L:341:THR:CG2	2:L:404:LEU:HD11	2.41	0.50
2:L:357:ARG:NH1	5:L:1225:HOH:O	2.30	0.50
1:O:217:ARG:NH2	1:O:223:ARG:HH11	2.08	0.50
2:V:412:SER:O	2:V:414:PRO:HD3	2.11	0.50
2:C:444:LEU:HB2	5:C:1970:HOH:O	2.10	0.50
1:D:48:ARG:HG3	1:D:49:SER:N	2.27	0.50
1:D:95:THR:O	1:D:98:GLN:HB2	2.11	0.50
2:E:324:ASN:HB2	5:E:543:HOH:O	2.11	0.50
1:I:141:ILE:HD12	1:I:141:ILE:N	2.26	0.50
1:S:28:LYS:HE3	1:S:46:PRO:CD	2.42	0.50
1:U:33:LEU:HB3	1:U:153:PHE:HB3	1.93	0.50
1:F:152:HIS:HB3	1:F:171:TYR:CE2	2.46	0.50
1:D:161:GLU:C	1:D:165:ASN:ND2	2.63	0.50
1:D:181:LEU:HD23	1:D:233:LEU:HB3	1.92	0.50
1:Q:18:GLU:O	1:Q:22:LYS:HG3	2.12	0.50
1:Q:142:THR:OG1	1:Q:144:ASP:OD1	2.30	0.50
1:B:33:LEU:HB3	1:B:153:PHE:CB	2.41	0.50
1:M:38:GLY:HA3	1:M:213:LEU:O	2.11	0.50
1:1:167:LEU:HA	1:1:170:SER:OG	2.11	0.50
1:A:234:LEU:HD12	1:A:234:LEU:N	2.27	0.50
2:C:515:ARG:O	2:C:519:GLU:HG3	2.12	0.50
1:Q:42:VAL:HG12	1:Q:188:LEU:CD2	2.41	0.50
1:U:81:PHE:CZ	1:U:102:VAL:HG21	2.47	0.50
1:Y:135:ARG:HH11	1:Y:135:ARG:CG	2.24	0.50
2:T:362:GLU:OE2	2:T:382:ARG:HD3	2.11	0.50
1:Y:179:ASP:O	1:Y:183:ILE:HG13	2.12	0.50
2:2:452:LYS:HD3	5:2:2578:HOH:O	2.10	0.50
1:A:135:ARG:NH2	1:A:173:GLU:OE2	2.37	0.49

Continued on next page...

Continued from previous page...

Atom-1	Atom-2	Interatomic distance (Å)	Clash overlap (Å)
2:E:409:ILE:HG23	5:E:2808:HOH:O	2.11	0.49
2:P:382:ARG:NH2	2:P:385:ILE:HD13	2.27	0.49
1:Q:144:ASP:OD1	1:Q:146:SER:OG	2.30	0.49
1:D:112:THR:CG2	1:Q:115:ALA:HB3	2.43	0.49
1:Q:21:ARG:CZ	1:Q:21:ARG:HB3	2.38	0.49
2:Z:382:ARG:NH2	2:Z:385:ILE:HD13	2.27	0.49
2:L:437:GLN:OE1	2:L:447:LYS:HD3	2.12	0.49
1:O:116:LYS:NZ	1:O:119:GLU:OE2	2.40	0.49
1:O:205:VAL:HG23	1:O:206:ALA:H	1.77	0.49
1:Q:56:LEU:HG	1:Q:62:PHE:HB2	1.93	0.49
1:A:181:LEU:HD23	1:A:233:LEU:HB3	1.95	0.49
2:H:366:TYR:CG	2:H:374:LEU:HD13	2.47	0.49
1:1:39:VAL:CG1	1:1:40:LEU:N	2.76	0.49
1:B:21:ARG:HB3	1:B:21:ARG:CZ	2.42	0.49
2:E:374:LEU:HD11	1:K:89:TYR:CD1	2.47	0.49
2:N:341:THR:CG2	2:N:404:LEU:HD11	2.43	0.49
2:N:444:LEU:HB2	5:N:793:HOH:O	2.12	0.49
1:A:56:LEU:HG	1:A:62:PHE:HB2	1.93	0.49
1:O:8:SER:OG	1:O:11:GLN:HB3	2.13	0.49
1:Q:140:ARG:HD3	1:Q:154:VAL:CG1	2.42	0.49
2:R:529:SER:C	5:R:3074:HOH:O	2.51	0.49
1:S:56:LEU:HG	1:S:62:PHE:HB2	1.93	0.49
1:S:181:LEU:CD2	1:S:233:LEU:HB3	2.43	0.49
2:T:366:TYR:CG	2:T:374:LEU:HD13	2.47	0.49
1:W:152:HIS:HB3	1:W:171:TYR:CZ	2.48	0.49
1:1:169:GLU:OE1	1:1:169:GLU:CA	2.48	0.49
1:F:73:ASN:ND2	1:W:105:GLN:HE21	2.11	0.49
2:G:509:ARG:CD	5:G:3043:HOH:O	2.46	0.49
1:K:181:LEU:HD23	1:K:234:LEU:HD12	1.95	0.49
2:Z:320:SER:HB3	2:Z:328:GLY:HA3	1.95	0.49
1:D:48:ARG:HH22	1:K:138:LEU:H	1.59	0.49
1:F:105:GLN:HG3	1:M:73:ASN:HD21	1.78	0.49
1:I:18:GLU:OE2	1:I:21:ARG:NH1	2.45	0.49
1:K:142:THR:CB	5:K:2919:HOH:O	2.58	0.49
1:O:11:GLN:O	1:O:15:GLU:HG2	2.12	0.49
2:R:422:SER:HB3	2:R:437:GLN:HG2	1.93	0.49
1:S:142:THR:HA	5:S:3022:HOH:O	2.13	0.49
1:U:171:TYR:CD2	1:U:172:ALA:N	2.81	0.49
1:D:87:TYR:CZ	2:E:358:LEU:HD13	2.48	0.49
1:K:97:ARG:NH2	5:K:1202:HOH:O	2.45	0.49
1:O:56:LEU:HG	1:O:62:PHE:HB2	1.94	0.49

Continued on next page...

Continued from previous page...

Atom-1	Atom-2	Interatomic distance (Å)	Clash overlap (Å)
1:U:167:LEU:O	1:U:171:TYR:N	2.34	0.49
1:Y:13:MET:O	1:Y:13:MET:CG	2.61	0.49
1:Y:83:ASP:OD2	2:Z:365:HIS:ND1	2.37	0.49
1:1:39:VAL:HG12	1:1:40:LEU:N	2.27	0.49
1:D:85:ARG:HB3	5:D:797:HOH:O	2.13	0.49
1:D:141:ILE:HD12	1:D:141:ILE:N	2.28	0.49
1:Q:39:VAL:CG1	1:Q:40:LEU:N	2.76	0.49
1:W:73:ASN:HD21	1:Y:105:GLN:HG3	1.78	0.49
1:W:98:GLN:O	1:W:102:VAL:HG23	2.12	0.49
2:L:393:ALA:HB1	2:L:398:LEU:HD12	1.93	0.48
1:K:87:TYR:CZ	2:L:358:LEU:HD13	2.49	0.48
2:V:397:GLY:O	2:V:398:LEU:HD23	2.13	0.48
1:D:56:LEU:HG	1:D:62:PHE:HB2	1.95	0.48
2:H:413:ASP:HA	2:H:414:PRO:HD2	1.65	0.48
1:K:39:VAL:CG1	1:K:40:LEU:N	2.77	0.48
1:K:132:GLU:HB2	5:K:2964:HOH:O	2.14	0.48
1:O:140:ARG:HD3	1:O:154:VAL:CG1	2.42	0.48
1:S:121:GLU:CA	5:S:3022:HOH:O	2.59	0.48
2:V:392:ALA:HA	2:V:395:MET:HE2	1.94	0.48
1:W:58:ASP:OD1	1:W:91:ARG:NH2	2.35	0.48
1:W:205:VAL:HG12	1:W:230:LEU:HG	1.95	0.48
1:F:140:ARG:HD3	1:F:154:VAL:CG1	2.43	0.48
2:H:320:SER:HB3	2:H:328:GLY:HA3	1.94	0.48
1:K:39:VAL:HG12	1:K:40:LEU:N	2.28	0.48
2:L:324:ASN:HB2	5:L:1305:HOH:O	2.13	0.48
1:M:56:LEU:HG	1:M:62:PHE:HB2	1.95	0.48
1:Q:98:GLN:O	1:Q:102:VAL:HG23	2.12	0.48
1:Q:173:GLU:C	1:Q:174:ASN:HD22	2.17	0.48
2:R:382:ARG:NH2	2:R:385:ILE:HD13	2.28	0.48
1:S:8:SER:O	1:S:11:GLN:N	2.46	0.48
1:S:205:VAL:CG1	5:S:2979:HOH:O	2.62	0.48
1:U:225:ILE:HG21	1:U:233:LEU:HD22	1.94	0.48
1:1:74:LEU:HD13	1:1:122:LEU:HD11	1.94	0.48
2:J:366:TYR:CG	2:J:374:LEU:HD13	2.49	0.48
1:M:140:ARG:HD3	1:M:154:VAL:CG1	2.42	0.48
1:O:181:LEU:HD23	1:O:233:LEU:HB3	1.95	0.48
1:S:140:ARG:HD3	1:S:154:VAL:CG1	2.41	0.48
1:U:140:ARG:HD3	1:U:154:VAL:CG1	2.41	0.48
1:Y:140:ARG:HD3	1:Y:154:VAL:CG1	2.42	0.48
1:1:112:THR:HG22	1:1:113:GLU:HG3	1.96	0.48
1:K:8:SER:CB	1:K:11:GLN:HB3	2.43	0.48

Continued on next page...

Continued from previous page...

Atom-1	Atom-2	Interatomic distance (Å)	Clash overlap (Å)
1:K:74:LEU:HD13	1:K:122:LEU:HD11	1.94	0.48
1:M:74:LEU:HD13	1:M:122:LEU:HD11	1.94	0.48
1:Y:38:GLY:HA3	1:Y:213:LEU:O	2.14	0.48
1:I:140:ARG:HD3	1:I:154:VAL:CG1	2.42	0.48
2:L:366:TYR:CD2	2:L:374:LEU:HD13	2.49	0.48
2:P:374:LEU:HB2	5:P:208:HOH:O	2.13	0.48
1:S:19:LEU:C	1:S:19:LEU:HD23	2.34	0.48
1:U:19:LEU:HD23	1:U:19:LEU:O	2.13	0.48
1:W:56:LEU:HG	1:W:62:PHE:HB2	1.95	0.48
1:W:189:ARG:O	1:W:190:ALA:C	2.51	0.48
1:D:147:ILE:CD1	1:Q:50:LEU:HD21	2.44	0.48
1:K:53:ILE:HB	1:K:209:GLU:OE2	2.14	0.48
1:O:229:ALA:O	1:O:233:LEU:HD13	2.14	0.48
1:Y:59:ARG:NH2	1:Y:215:ALA:O	2.47	0.48
1:A:74:LEU:HD13	1:A:122:LEU:HD11	1.96	0.48
1:Y:11:GLN:NE2	1:Y:15:GLU:HG3	2.29	0.48
2:Z:422:SER:HB3	2:Z:437:GLN:HG2	1.94	0.48
1:A:19:LEU:C	1:A:19:LEU:HD23	2.34	0.48
2:L:372:VAL:HG23	2:L:373:PRO:HD3	1.96	0.48
2:V:511:ALA:O	2:V:515:ARG:HG3	2.14	0.48
1:K:115:ALA:HB3	1:M:112:THR:CG2	2.44	0.47
2:R:366:TYR:CG	2:R:374:LEU:HD13	2.49	0.47
2:C:416:SER:O	2:C:416:SER:OG	2.30	0.47
2:P:392:ALA:HA	2:P:395:MET:HE2	1.96	0.47
1:S:231:GLN:HA	1:S:231:GLN:OE1	2.14	0.47
1:U:19:LEU:HD23	1:U:19:LEU:C	2.34	0.47
2:V:320:SER:HB3	2:V:328:GLY:HA3	1.95	0.47
1:W:8:SER:N	1:W:9:PRO:C	2.68	0.47
1:A:116:LYS:HD2	1:B:13:MET:CE	2.43	0.47
1:D:73:ASN:ND2	1:K:105:GLN:HG3	2.30	0.47
2:E:456:GLN:NE2	2:E:465:ARG:HH21	2.11	0.47
2:N:415:GLN:OE1	2:N:415:GLN:HA	2.15	0.47
2:P:437:GLN:OE1	2:P:447:LYS:HD3	2.14	0.47
1:Y:228:SER:O	1:Y:231:GLN:HB3	2.14	0.47
2:2:366:TYR:CG	2:2:374:LEU:HD13	2.50	0.47
1:F:74:LEU:HD13	1:F:122:LEU:HD11	1.96	0.47
1:I:73:ASN:ND2	1:S:105:GLN:HG3	2.29	0.47
2:J:444:LEU:HB2	5:J:543:HOH:O	2.14	0.47
2:N:320:SER:HB3	2:N:328:GLY:HA3	1.95	0.47
1:W:223:ARG:NH1	5:W:1623:HOH:O	2.45	0.47
2:X:437:GLN:OE1	2:X:447:LYS:HD3	2.15	0.47

Continued on next page...

Continued from previous page...

Atom-1	Atom-2	Interatomic distance (Å)	Clash overlap (Å)
1:Y:152:HIS:CD2	1:Y:171:TYR:CZ	3.01	0.47
1:1:41:PHE:HB3	1:1:53:ILE:HD13	1.97	0.47
1:B:140:ARG:HD3	1:B:154:VAL:CG1	2.44	0.47
1:D:167:LEU:HA	1:D:170:SER:HG	1.80	0.47
1:I:56:LEU:HB2	1:I:60:VAL:HG12	1.96	0.47
1:I:85:ARG:HB3	5:I:791:HOH:O	2.13	0.47
2:L:422:SER:HB3	2:L:437:GLN:HG2	1.96	0.47
1:Q:105:GLN:HE21	1:Y:73:ASN:ND2	2.12	0.47
1:Y:12:ALA:C	1:Y:14:ARG:N	2.67	0.47
2:C:366:TYR:CG	2:C:374:LEU:HD13	2.49	0.47
1:F:204:GLY:N	5:F:2909:HOH:O	2.47	0.47
2:H:362:GLU:OE2	2:H:382:ARG:CD	2.63	0.47
2:H:392:ALA:HA	2:H:395:MET:HE2	1.96	0.47
2:L:375:THR:HG23	1:M:93:ASP:OD1	2.14	0.47
1:Q:74:LEU:HD13	1:Q:122:LEU:HD11	1.97	0.47
1:Q:112:THR:HG22	1:Y:115:ALA:HB3	1.94	0.47
1:Q:112:THR:HG22	1:Q:113:GLU:HG3	1.97	0.47
1:S:19:LEU:HD23	1:S:19:LEU:O	2.14	0.47
1:S:115:ALA:HB3	1:1:112:THR:CG2	2.44	0.47
1:Y:11:GLN:O	1:Y:14:ARG:HB3	2.14	0.47
1:Y:163:ILE:HD13	1:Y:188:LEU:HD12	1.97	0.47
1:Y:232:ALA:O	1:Y:235:VAL:HB	2.15	0.47
1:K:56:LEU:HG	1:K:62:PHE:HB2	1.96	0.47
1:W:46:PRO:CD	1:W:47:SER:H	2.28	0.47
1:1:140:ARG:HD3	1:1:154:VAL:CG1	2.45	0.47
1:B:56:LEU:HG	1:B:62:PHE:HB2	1.96	0.47
1:F:73:ASN:ND2	1:W:105:GLN:HG3	2.29	0.47
1:M:28:LYS:HE3	1:M:46:PRO:HG3	1.97	0.47
2:N:329:ARG:HD3	5:N:930:HOH:O	2.14	0.47
1:S:152:HIS:HB3	1:S:171:TYR:CZ	2.50	0.47
1:W:40:LEU:HG	1:W:41:PHE:N	2.30	0.47
1:W:181:LEU:CD2	1:W:234:LEU:CD2	2.93	0.47
1:Y:92:ARG:NH1	1:Y:92:ARG:HG3	2.18	0.47
1:Y:231:GLN:O	1:Y:231:GLN:OE1	2.32	0.47
1:A:233:LEU:C	1:A:234:LEU:HD12	2.35	0.47
1:D:48:ARG:HH12	1:K:137:GLU:CG	2.27	0.47
1:K:140:ARG:NH1	1:K:140:ARG:CG	2.76	0.47
2:R:306:LEU:HD12	2:R:313:VAL:HG12	1.97	0.47
1:S:98:GLN:O	1:S:102:VAL:HG23	2.15	0.47
1:U:74:LEU:HD13	1:U:122:LEU:HD11	1.97	0.47
1:D:140:ARG:HD3	1:D:154:VAL:CG1	2.42	0.46

Continued on next page...

Continued from previous page...

Atom-1	Atom-2	Interatomic distance (Å)	Clash overlap (Å)
1:F:55:GLU:OE1	1:F:220:ARG:NH2	2.39	0.46
2:L:382:ARG:NH2	2:L:385:ILE:CD1	2.78	0.46
2:N:366:TYR:CG	2:N:374:LEU:HD13	2.50	0.46
1:O:98:GLN:O	1:O:102:VAL:HG23	2.15	0.46
1:F:170:SER:OG	1:F:183:ILE:HD13	2.15	0.46
1:O:11:GLN:HG3	1:O:15:GLU:OE1	2.15	0.46
1:S:97:ARG:NH2	5:S:683:HOH:O	2.47	0.46
1:W:40:LEU:HD21	1:W:42:VAL:CG2	2.46	0.46
1:W:112:THR:HG22	1:W:113:GLU:HG3	1.98	0.46
1:W:230:LEU:HD12	1:W:230:LEU:O	2.15	0.46
2:Z:409:ILE:HG13	2:Z:410:HIS:ND1	2.31	0.46
2:2:364:GLU:HG2	2:2:368:LYS:HD3	1.98	0.46
1:I:114:GLN:HE21	1:I:114:GLN:HB3	1.52	0.46
5:I:1024:HOH:O	1:S:112:THR:HG21	2.14	0.46
2:J:324:ASN:ND2	5:J:541:HOH:O	2.48	0.46
1:K:181:LEU:O	1:K:185:VAL:HG23	2.14	0.46
1:S:55:GLU:OE1	1:S:220:ARG:NH2	2.39	0.46
2:V:362:GLU:OE2	2:V:382:ARG:HD2	2.16	0.46
1:F:29:SER:OG	1:F:157:GLY:O	2.29	0.46
2:G:509:ARG:HH11	2:G:509:ARG:CG	2.28	0.46
1:B:97:ARG:NH2	5:B:1763:HOH:O	2.47	0.46
1:M:54:SER:CB	1:M:75:ARG:HD2	2.46	0.46
1:M:161:GLU:HB2	1:M:162:PRO:HD3	1.98	0.46
1:M:163:ILE:O	1:M:187:ALA:HB1	2.14	0.46
1:Q:52:LYS:HG2	1:Q:71:PHE:CZ	2.51	0.46
1:S:152:HIS:CB	1:S:171:TYR:CE2	2.96	0.46
1:W:79:ILE:HG21	2:X:369:LEU:HD13	1.97	0.46
1:W:152:HIS:HB3	1:W:171:TYR:CE2	2.51	0.46
1:1:97:ARG:HH22	1:1:101:ASN:ND2	2.11	0.46
2:C:362:GLU:OE2	2:C:382:ARG:CD	2.64	0.46
2:C:437:GLN:OE1	2:C:447:LYS:HD3	2.15	0.46
2:E:388:ARG:HD3	2:E:426:ALA:O	2.14	0.46
1:I:54:SER:CB	1:I:75:ARG:HD2	2.45	0.46
1:K:112:THR:HG22	1:K:113:GLU:HG3	1.98	0.46
1:O:33:LEU:O	1:O:33:LEU:HD12	2.16	0.46
1:O:205:VAL:HG21	1:O:231:GLN:NE2	2.30	0.46
1:A:45:ASN:OD1	1:A:47:SER:N	2.48	0.46
1:D:68:PHE:HA	1:D:71:PHE:CE2	2.51	0.46
1:D:161:GLU:CA	1:D:165:ASN:ND2	2.79	0.46
1:F:114:GLN:HE21	1:F:114:GLN:HB3	1.54	0.46
1:1:54:SER:CB	1:1:75:ARG:HD2	2.45	0.46

Continued on next page...

Continued from previous page...

Atom-1	Atom-2	Interatomic distance (Å)	Clash overlap (Å)
1:1:163:ILE:CG2	1:1:187:ALA:O	2.55	0.46
1:K:184:ALA:O	1:K:188:LEU:HB2	2.15	0.46
2:P:320:SER:HB3	2:P:328:GLY:HA3	1.97	0.46
1:A:112:THR:HG22	1:A:113:GLU:HG3	1.98	0.46
1:A:125:ALA:HB2	1:A:138:LEU:HD23	1.98	0.46
1:D:19:LEU:HD23	1:D:19:LEU:C	2.36	0.46
1:D:217:ARG:NH2	1:D:223:ARG:HD3	2.30	0.46
1:I:181:LEU:HD23	1:I:233:LEU:CB	2.46	0.46
1:O:17:SER:O	1:O:21:ARG:HB2	2.16	0.46
1:O:112:THR:HG22	1:O:113:GLU:HG3	1.98	0.46
1:W:51:GLN:HG2	1:W:224:ARG:NH2	2.31	0.46
1:Y:74:LEU:HD13	1:Y:122:LEU:HD11	1.98	0.46
1:Y:98:GLN:O	1:Y:102:VAL:HG23	2.15	0.46
1:A:188:LEU:HD12	1:A:188:LEU:HA	1.79	0.46
1:M:173:GLU:O	1:M:174:ASN:HB2	2.15	0.46
1:1:56:LEU:HG	1:1:62:PHE:HB2	1.97	0.46
1:A:234:LEU:N	1:A:234:LEU:CD1	2.79	0.45
1:O:54:SER:CB	1:O:75:ARG:HD2	2.46	0.45
1:S:68:PHE:HA	1:S:71:PHE:CE2	2.51	0.45
1:1:130:TYR:C	1:1:132:GLU:N	2.69	0.45
1:B:68:PHE:HA	1:B:71:PHE:CE2	2.51	0.45
1:F:98:GLN:O	1:F:102:VAL:HG23	2.16	0.45
1:F:116:LYS:HD2	1:W:13:MET:CE	2.46	0.45
1:M:112:THR:HG22	1:M:113:GLU:HG3	1.98	0.45
1:S:205:VAL:HG21	5:S:2979:HOH:O	2.14	0.45
1:1:205:VAL:CG1	1:1:234:LEU:HD12	2.45	0.45
2:N:364:GLU:HG2	2:N:368:LYS:HD3	1.98	0.45
1:S:112:THR:HG22	1:S:113:GLU:HG3	1.98	0.45
1:S:114:GLN:HE21	1:S:114:GLN:HB3	1.53	0.45
1:U:8:SER:HB2	1:U:11:GLN:HB2	1.98	0.45
1:D:167:LEU:CD1	1:D:183:ILE:CG2	2.95	0.45
1:W:140:ARG:HD3	1:W:154:VAL:CG1	2.44	0.45
2:E:382:ARG:NH2	2:E:385:ILE:HD13	2.32	0.45
1:F:70:GLU:HB3	1:F:118:TYR:CD2	2.52	0.45
1:F:112:THR:HG22	1:F:113:GLU:HG3	1.98	0.45
2:H:362:GLU:OE2	2:H:382:ARG:HD3	2.17	0.45
1:I:56:LEU:CG	1:I:62:PHE:HB2	2.44	0.45
2:R:529:SER:CB	5:R:1999:HOH:O	2.34	0.45
1:W:19:LEU:C	1:W:19:LEU:HD23	2.37	0.45
2:2:422:SER:HB3	2:2:437:GLN:HG2	1.98	0.45
1:A:52:LYS:HE2	1:A:64:ALA:O	2.16	0.45

Continued on next page...

Continued from previous page...

Atom-1	Atom-2	Interatomic distance (Å)	Clash overlap (Å)
1:Q:185:VAL:O	1:Q:189:ARG:N	2.42	0.45
1:S:165:ASN:O	1:S:169:GLU:OE2	2.34	0.45
1:Y:8:SER:OG	1:Y:11:GLN:HG2	2.14	0.45
1:Y:128:ALA:HB2	1:Y:134:LYS:CB	2.45	0.45
1:1:33:LEU:HD12	1:1:33:LEU:O	2.17	0.45
1:1:97:ARG:HH22	1:1:101:ASN:HD22	1.60	0.45
1:A:97:ARG:NH2	5:A:1568:HOH:O	2.42	0.45
1:B:112:THR:HG22	1:B:113:GLU:HG3	1.99	0.45
1:D:233:LEU:O	1:D:234:LEU:C	2.53	0.45
2:E:422:SER:HB3	2:E:437:GLN:HG2	1.98	0.45
2:H:308:TYR:CZ	2:H:311:GLY:HA3	2.52	0.45
1:K:54:SER:CB	1:K:75:ARG:HD2	2.47	0.45
1:M:41:PHE:CB	1:M:53:ILE:HD13	2.36	0.45
1:O:182:ARG:NH1	1:O:233:LEU:O	2.36	0.45
2:P:366:TYR:CG	2:P:374:LEU:HD13	2.51	0.45
2:R:392:ALA:HA	2:R:395:MET:CE	2.46	0.45
1:S:152:HIS:HD2	1:S:171:TYR:OH	1.99	0.45
2:E:375:THR:HG23	1:K:93:ASP:OD1	2.17	0.45
1:I:45:ASN:OD1	1:I:46:PRO:HD2	2.17	0.45
1:I:73:ASN:HD21	1:S:105:GLN:HE21	1.65	0.45
1:U:112:THR:HG22	1:U:113:GLU:HG3	1.99	0.45
1:W:114:GLN:HE21	1:W:114:GLN:HB3	1.52	0.45
1:W:152:HIS:CD2	1:W:171:TYR:CE2	3.05	0.45
1:W:207:SER:O	1:W:208:LEU:HD23	2.17	0.45
1:B:54:SER:CB	1:B:75:ARG:HD2	2.46	0.45
1:S:85:ARG:HB3	5:S:786:HOH:O	2.16	0.45
2:T:444:LEU:HD23	2:X:444:LEU:HD22	1.97	0.45
1:Q:188:LEU:HA	1:Q:188:LEU:HD12	1.80	0.45
1:W:54:SER:CB	1:W:75:ARG:HD2	2.47	0.45
2:C:456:GLN:HE21	2:C:465:ARG:NH2	2.09	0.44
2:C:509:ARG:HA	2:C:509:ARG:HD2	1.79	0.44
2:G:422:SER:HB3	2:G:437:GLN:HG2	1.97	0.44
1:M:19:LEU:C	1:M:19:LEU:HD23	2.37	0.44
1:Q:33:LEU:HD12	1:Q:33:LEU:O	2.16	0.44
2:R:465:ARG:HD3	5:R:712:HOH:O	2.17	0.44
1:U:45:ASN:ND2	1:U:209:GLU:OE1	2.48	0.44
2:V:392:ALA:HA	2:V:395:MET:HE3	1.99	0.44
1:W:33:LEU:HD12	1:W:33:LEU:O	2.17	0.44
1:A:114:GLN:HE21	1:A:114:GLN:HB3	1.51	0.44
2:R:392:ALA:HA	2:R:395:MET:HE3	2.00	0.44
1:U:56:LEU:HG	1:U:62:PHE:HB2	1.99	0.44

Continued on next page...

Continued from previous page...

Atom-1	Atom-2	Interatomic distance (Å)	Clash overlap (Å)
1:Y:232:ALA:CA	1:Y:235:VAL:HG23	2.48	0.44
1:D:207:SER:C	1:D:208:LEU:HD12	2.38	0.44
2:G:324:ASN:ND2	5:G:1829:HOH:O	2.50	0.44
1:I:229:ALA:O	1:I:233:LEU:HD13	2.17	0.44
1:K:114:GLN:HE21	1:K:114:GLN:HB3	1.52	0.44
2:L:320:SER:HB3	2:L:328:GLY:HA3	1.99	0.44
2:N:422:SER:HB3	2:N:437:GLN:HG2	1.99	0.44
2:R:515:ARG:O	2:R:519:GLU:HG3	2.17	0.44
1:Y:45:ASN:HA	1:Y:46:PRO:HD2	1.68	0.44
1:1:223:ARG:O	1:1:223:ARG:HG3	2.16	0.44
1:1:225:ILE:HG21	1:1:233:LEU:CD2	2.46	0.44
2:2:432:GLU:HG2	2:2:436:TYR:O	2.18	0.44
2:2:509:ARG:HG2	5:2:2188:HOH:O	2.16	0.44
1:D:105:GLN:HG3	1:Q:73:ASN:HD21	1.82	0.44
2:J:437:GLN:OE1	2:J:447:LYS:HD3	2.16	0.44
1:O:167:LEU:HA	1:O:167:LEU:HD12	1.67	0.44
2:T:341:THR:CG2	2:T:404:LEU:HD11	2.48	0.44
1:W:76:ARG:HD3	5:W:2805:HOH:O	2.18	0.44
1:A:54:SER:CB	1:A:75:ARG:HD2	2.47	0.44
1:A:233:LEU:N	1:A:233:LEU:HD12	2.32	0.44
1:B:133:THR:HG23	1:B:133:THR:O	2.17	0.44
1:M:230:LEU:HD12	1:M:230:LEU:O	2.16	0.44
2:P:422:SER:HB3	2:P:437:GLN:HG2	1.99	0.44
1:W:73:ASN:ND2	1:Y:105:GLN:HE21	2.15	0.44
1:Y:181:LEU:O	1:Y:185:VAL:HG23	2.18	0.44
1:Y:186:ALA:O	1:Y:189:ARG:N	2.51	0.44
1:A:67:LYS:HG2	1:A:69:ASN:HD21	1.82	0.44
1:A:217:ARG:NH1	1:A:223:ARG:HB3	2.33	0.44
2:C:301:THR:CG2	2:C:302:THR:N	2.80	0.44
1:D:45:ASN:HA	1:D:46:PRO:HD3	1.85	0.44
2:E:325:MET:SD	2:R:444:LEU:HD21	2.58	0.44
1:I:62:PHE:CZ	1:I:122:LEU:HD22	2.53	0.44
1:I:112:THR:HG22	1:I:113:GLU:HG3	2.00	0.44
1:O:141:ILE:N	1:O:141:ILE:HD12	2.32	0.44
1:S:54:SER:CB	1:S:75:ARG:HD2	2.48	0.44
1:S:59:ARG:NH1	1:S:217:ARG:O	2.47	0.44
1:S:73:ASN:ND2	1:1:105:GLN:HG3	2.30	0.44
1:U:93:ASP:OD1	2:2:375:THR:HG23	2.17	0.44
2:Z:308:TYR:CZ	2:Z:311:GLY:HA3	2.52	0.44
2:C:414:PRO:C	2:C:416:SER:N	2.69	0.44
1:D:152:HIS:CB	1:D:171:TYR:CE2	3.00	0.44

Continued on next page...

Continued from previous page...

Atom-1	Atom-2	Interatomic distance (Å)	Clash overlap (Å)
1:O:85:ARG:NH2	5:O:2922:HOH:O	2.39	0.44
1:Q:45:ASN:ND2	1:Q:209:GLU:OE1	2.51	0.44
1:Y:112:THR:HG22	1:Y:113:GLU:HG3	1.98	0.44
1:A:89:TYR:CD1	2:P:374:LEU:HD11	2.53	0.44
1:D:33:LEU:HB3	1:D:153:PHE:HB3	1.99	0.44
2:G:392:ALA:HA	2:G:395:MET:HE2	1.99	0.44
1:I:171:TYR:CD2	1:I:171:TYR:C	2.91	0.44
1:K:183:ILE:HD13	1:K:183:ILE:HG21	1.66	0.44
1:Q:48:ARG:H	1:Q:48:ARG:HG2	1.39	0.44
1:U:179:ASP:O	1:U:183:ILE:HG13	2.18	0.44
1:D:152:HIS:CD2	1:D:171:TYR:CZ	3.05	0.44
1:I:189:ARG:O	1:I:191:GLY:N	2.49	0.44
1:K:167:LEU:HD12	1:K:183:ILE:CG2	2.48	0.44
2:T:308:TYR:CD1	2:T:308:TYR:C	2.91	0.44
2:T:444:LEU:HB2	5:T:2189:HOH:O	2.18	0.44
1:1:181:LEU:HD23	1:1:233:LEU:HB3	1.98	0.44
1:O:8:SER:HG	1:O:11:GLN:HB3	1.83	0.43
1:Q:181:LEU:HD23	1:Q:233:LEU:HB2	1.99	0.43
1:Q:184:ALA:O	1:Q:188:LEU:HB2	2.18	0.43
1:S:121:GLU:CG	5:S:3022:HOH:O	2.50	0.43
1:U:114:GLN:HE21	1:U:114:GLN:HB3	1.53	0.43
1:1:55:GLU:OE1	1:1:220:ARG:NH2	2.43	0.43
1:F:163:ILE:HG23	1:F:187:ALA:O	2.18	0.43
2:G:364:GLU:HG2	2:G:368:LYS:HD3	1.99	0.43
2:G:509:ARG:HG3	2:G:509:ARG:HH11	1.80	0.43
1:I:70:GLU:HB3	1:I:118:TYR:CD2	2.54	0.43
1:Q:38:GLY:HA3	1:Q:213:LEU:O	2.17	0.43
2:R:515:ARG:NE	5:R:1326:HOH:O	2.42	0.43
1:A:21:ARG:CZ	1:A:21:ARG:HB3	2.49	0.43
1:A:45:ASN:HA	1:A:46:PRO:HD2	1.82	0.43
1:B:149:ASP:OD2	1:B:149:ASP:N	2.49	0.43
1:D:54:SER:CB	1:D:75:ARG:HD2	2.48	0.43
1:I:51:GLN:OE1	1:I:224:ARG:NH2	2.51	0.43
2:J:374:LEU:HB2	5:J:182:HOH:O	2.18	0.43
2:J:422:SER:HB3	2:J:437:GLN:HG2	2.00	0.43
1:M:55:GLU:HB2	1:M:222:PHE:CG	2.53	0.43
2:P:444:LEU:HB2	5:P:88:HOH:O	2.18	0.43
1:S:48:ARG:H	1:S:48:ARG:HG2	1.57	0.43
2:X:307:LYS:HE3	2:X:418:GLY:O	2.18	0.43
1:Y:228:SER:O	1:Y:232:ALA:N	2.41	0.43
2:C:332:ARG:NH2	5:C:550:HOH:O	2.40	0.43

Continued on next page...

Continued from previous page...

Atom-1	Atom-2	Interatomic distance (Å)	Clash overlap (Å)
2:E:437:GLN:OE1	2:E:447:LYS:HD3	2.18	0.43
1:K:141:ILE:HD12	1:K:141:ILE:N	2.33	0.43
2:L:366:TYR:CG	2:L:374:LEU:HD13	2.53	0.43
1:M:18:GLU:CG	1:M:22:LYS:HE3	2.45	0.43
1:S:123:CYS:HA	1:S:139:TYR:O	2.19	0.43
2:T:437:GLN:OE1	2:T:447:LYS:HD3	2.17	0.43
2:V:422:SER:HB3	2:V:437:GLN:HG2	1.99	0.43
1:W:21:ARG:CZ	1:W:21:ARG:HB3	2.49	0.43
1:W:46:PRO:HD2	1:W:47:SER:H	1.83	0.43
1:Y:54:SER:CB	1:Y:75:ARG:HD2	2.48	0.43
2:Z:341:THR:CG2	2:Z:404:LEU:HD11	2.49	0.43
1:1:133:THR:HG23	1:1:133:THR:O	2.18	0.43
1:A:205:VAL:C	1:A:207:SER:H	2.21	0.43
1:D:21:ARG:CZ	1:D:21:ARG:HB3	2.48	0.43
1:F:54:SER:CB	1:F:75:ARG:HD2	2.49	0.43
1:F:167:LEU:CA	1:F:170:SER:HB3	2.35	0.43
2:J:320:SER:HB3	2:J:328:GLY:CA	2.48	0.43
2:L:362:GLU:OE2	2:L:382:ARG:HD2	2.19	0.43
1:M:87:TYR:CZ	2:N:358:LEU:HD13	2.54	0.43
1:O:161:GLU:HB3	1:O:162:PRO:CD	2.48	0.43
1:Q:149:ASP:OD2	1:Q:149:ASP:N	2.51	0.43
1:S:116:LYS:HD2	1:1:13:MET:HE1	2.00	0.43
1:W:227:GLY:O	1:W:231:GLN:N	2.29	0.43
1:Y:13:MET:HA	1:Y:16:ARG:HD3	2.00	0.43
1:Y:135:ARG:NH1	1:Y:135:ARG:CG	2.82	0.43
1:1:129:HIS:O	1:1:132:GLU:CB	2.65	0.43
1:D:16:ARG:HB3	1:D:117:PRO:HG2	1.99	0.43
2:E:320:SER:HB3	2:E:328:GLY:CA	2.48	0.43
2:N:412:SER:O	2:N:414:PRO:HD3	2.18	0.43
1:Q:150:GLU:HA	1:Q:151:PRO:HD3	1.89	0.43
2:R:412:SER:O	2:R:414:PRO:HD3	2.18	0.43
1:W:68:PHE:HA	1:W:71:PHE:CE2	2.53	0.43
1:A:28:LYS:HE3	1:A:46:PRO:HG2	2.00	0.43
1:B:73:ASN:HD21	1:I:105:GLN:HG3	1.83	0.43
1:D:35:TYR:HB2	1:D:175:ALA:O	2.19	0.43
1:M:68:PHE:HA	1:M:71:PHE:CE2	2.54	0.43
2:X:324:ASN:HD22	2:X:324:ASN:HA	1.61	0.43
1:A:115:ALA:HB3	1:B:112:THR:CG2	2.48	0.43
1:A:137:GLU:OE1	1:A:139:TYR:OH	2.30	0.43
1:D:8:SER:CA	1:Q:15:GLU:OE2	2.64	0.43
2:E:341:THR:CG2	2:E:404:LEU:HD11	2.49	0.43

Continued on next page...

Continued from previous page...

Atom-1	Atom-2	Interatomic distance (Å)	Clash overlap (Å)
2:G:306:LEU:HD12	2:G:306:LEU:O	2.18	0.43
1:1:98:GLN:O	1:1:102:VAL:HG23	2.19	0.43
2:C:306:LEU:HD12	2:C:313:VAL:HG12	2.00	0.43
1:I:19:LEU:C	1:I:19:LEU:CD2	2.86	0.43
1:K:140:ARG:HD3	1:K:154:VAL:CG1	2.48	0.43
1:K:229:ALA:O	1:K:233:LEU:HD13	2.19	0.43
1:Q:170:SER:O	1:Q:170:SER:OG	2.37	0.43
2:R:362:GLU:OE2	2:R:382:ARG:HD3	2.19	0.43
1:W:19:LEU:HD23	1:W:19:LEU:O	2.19	0.43
1:A:150:GLU:HA	1:A:151:PRO:HD3	1.87	0.43
2:H:430:ASN:ND2	5:H:2966:HOH:O	2.52	0.43
1:Q:123:CYS:HA	1:Q:139:TYR:O	2.19	0.43
1:U:21:ARG:CZ	1:U:21:ARG:HB3	2.49	0.43
1:U:133:THR:HG23	1:U:133:THR:O	2.18	0.43
1:Y:204:GLY:O	1:Y:208:LEU:HG	2.18	0.43
1:B:150:GLU:HA	1:B:151:PRO:HD3	1.89	0.42
1:D:123:CYS:HA	1:D:139:TYR:O	2.19	0.42
2:G:393:ALA:HB1	2:G:398:LEU:HD12	2.01	0.42
2:H:341:THR:CG2	2:H:404:LEU:HD11	2.49	0.42
1:I:68:PHE:HA	1:I:71:PHE:CE2	2.54	0.42
1:M:28:LYS:HE3	1:M:46:PRO:HG2	2.01	0.42
1:M:163:ILE:HG23	1:M:188:LEU:CA	2.48	0.42
2:N:382:ARG:NH2	2:N:385:ILE:HD13	2.34	0.42
2:R:521:ARG:HD3	2:R:521:ARG:HA	1.87	0.42
1:Y:181:LEU:HD21	1:Y:234:LEU:CD1	2.49	0.42
1:A:163:ILE:HG23	1:A:187:ALA:O	2.19	0.42
1:D:70:GLU:HB3	1:D:118:TYR:CD2	2.54	0.42
1:D:112:THR:HG22	1:D:113:GLU:HG3	2.00	0.42
1:D:133:THR:HG23	1:D:133:THR:O	2.20	0.42
1:F:88:ALA:O	2:N:381:ASN:ND2	2.51	0.42
2:G:393:ALA:O	2:G:398:LEU:HB2	2.18	0.42
1:O:35:TYR:CZ	1:O:37:GLY:HA3	2.53	0.42
1:Q:56:LEU:O	2:R:368:LYS:HE3	2.19	0.42
1:W:179:ASP:O	1:W:183:ILE:CG1	2.61	0.42
1:W:204:GLY:O	1:W:208:LEU:HG	2.19	0.42
1:1:8:SER:N	5:1:1515:HOH:O	2.52	0.42
1:A:19:LEU:HD23	1:A:19:LEU:O	2.19	0.42
2:C:362:GLU:OE2	2:C:382:ARG:HD3	2.18	0.42
2:E:324:ASN:HD22	2:E:324:ASN:HA	1.62	0.42
1:F:116:LYS:HG2	1:F:117:PRO:O	2.19	0.42
2:L:362:GLU:OE2	2:L:382:ARG:CD	2.66	0.42

Continued on next page...

Continued from previous page...

Atom-1	Atom-2	Interatomic distance (Å)	Clash overlap (Å)
2:L:509:ARG:CD	5:L:2882:HOH:O	2.53	0.42
2:N:392:ALA:HA	2:N:395:MET:HE2	2.00	0.42
2:T:351:VAL:HG21	2:T:398:LEU:HB3	2.00	0.42
2:X:508:SER:O	2:X:512:GLU:HG3	2.20	0.42
1:D:105:GLN:HE21	1:Q:73:ASN:HD21	1.65	0.42
2:E:366:TYR:CG	2:E:374:LEU:HD13	2.54	0.42
2:E:412:SER:O	2:E:414:PRO:HD3	2.19	0.42
2:G:306:LEU:HD12	2:G:306:LEU:C	2.40	0.42
1:O:25:ALA:O	1:O:158:GLY:HA2	2.20	0.42
1:U:54:SER:CB	1:U:75:ARG:HD2	2.49	0.42
1:U:68:PHE:HA	1:U:71:PHE:CE2	2.54	0.42
1:Y:152:HIS:HD2	1:Y:171:TYR:OH	2.02	0.42
2:C:398:LEU:HD23	2:C:398:LEU:HA	1.75	0.42
1:D:40:LEU:HD13	1:D:177:LEU:CD1	2.49	0.42
1:F:19:LEU:HD23	1:F:19:LEU:O	2.20	0.42
2:G:509:ARG:NE	5:G:3043:HOH:O	2.52	0.42
1:K:149:ASP:OD2	1:K:149:ASP:N	2.53	0.42
1:Q:28:LYS:HE3	1:Q:46:PRO:HG3	2.01	0.42
1:Q:34:ALA:O	1:Q:171:TYR:OH	2.34	0.42
1:S:21:ARG:HB3	1:S:21:ARG:CZ	2.49	0.42
2:T:374:LEU:HD11	1:I:89:TYR:CD1	2.55	0.42
1:W:181:LEU:HD23	1:W:234:LEU:CD2	2.48	0.42
1:W:205:VAL:HG11	1:W:231:GLN:HB2	2.00	0.42
1:I:45:ASN:HA	1:I:46:PRO:HD2	1.87	0.42
2:2:362:GLU:OE2	2:2:382:ARG:CD	2.67	0.42
1:D:19:LEU:HD23	1:D:19:LEU:O	2.20	0.42
1:D:73:ASN:ND2	1:K:105:GLN:HE21	2.17	0.42
2:E:324:ASN:ND2	5:E:893:HOH:O	2.51	0.42
1:K:68:PHE:HA	1:K:71:PHE:CE2	2.54	0.42
1:O:89:TYR:CD1	2:V:374:LEU:HD11	2.55	0.42
1:Q:75:ARG:NH2	2:R:369:LEU:O	2.36	0.42
1:Q:144:ASP:CG	1:Q:146:SER:HG	2.22	0.42
1:Q:214:ASP:HB3	1:Q:217:ARG:CG	2.49	0.42
2:R:320:SER:HB2	2:R:331:VAL:HG21	2.01	0.42
2:T:324:ASN:HD22	2:T:324:ASN:HA	1.64	0.42
1:Y:8:SER:OG	1:Y:11:GLN:HG3	2.18	0.42
2:2:409:ILE:HG13	2:2:410:HIS:ND1	2.33	0.42
2:C:364:GLU:HG2	2:C:368:LYS:HD3	2.02	0.42
2:E:366:TYR:CE2	2:E:374:LEU:HD13	2.54	0.42
2:G:444:LEU:HB2	5:G:869:HOH:O	2.18	0.42
2:J:341:THR:CG2	2:J:404:LEU:HD11	2.49	0.42

Continued on next page...

Continued from previous page...

Atom-1	Atom-2	Interatomic distance (Å)	Clash overlap (Å)
1:M:205:VAL:C	1:M:207:SER:H	2.21	0.42
1:Q:171:TYR:HE2	1:Q:173:GLU:CG	2.13	0.42
2:V:437:GLN:OE1	2:V:447:LYS:HD3	2.19	0.42
1:W:214:ASP:HB3	1:W:217:ARG:HG2	2.02	0.42
2:X:382:ARG:NH2	2:X:385:ILE:HD13	2.35	0.42
2:X:409:ILE:HG13	2:X:410:HIS:ND1	2.34	0.42
2:2:366:TYR:CE2	2:2:374:LEU:HD13	2.55	0.42
1:F:9:PRO:HD2	1:M:15:GLU:CD	2.40	0.42
1:F:147:ILE:CG1	1:F:148:ALA:N	2.83	0.42
2:G:437:GLN:OE1	2:G:447:LYS:HD3	2.20	0.42
1:I:9:PRO:O	1:I:13:MET:HB2	2.20	0.42
2:J:374:LEU:HD11	1:S:89:TYR:CD1	2.55	0.42
1:K:181:LEU:CD2	1:K:234:LEU:CD1	2.97	0.42
1:O:67:LYS:HD3	1:O:69:ASN:HD21	1.84	0.42
1:O:110:ILE:HG21	1:O:118:TYR:CD1	2.55	0.42
1:Y:137:GLU:C	1:Y:138:LEU:HG	2.38	0.42
1:A:231:GLN:HA	1:A:231:GLN:NE2	2.35	0.42
1:B:123:CYS:HA	1:B:139:TYR:O	2.20	0.42
2:G:413:ASP:OD2	2:G:416:SER:HB2	2.19	0.42
2:H:508:SER:O	2:H:512:GLU:HG3	2.20	0.42
1:Q:55:GLU:HB2	1:Q:222:PHE:CG	2.55	0.42
1:S:170:SER:C	1:S:183:ILE:HD11	2.37	0.42
1:U:8:SER:OG	1:U:11:GLN:HB3	2.20	0.42
1:U:33:LEU:HB3	1:U:153:PHE:CB	2.49	0.42
2:X:320:SER:HB3	2:X:328:GLY:HA3	2.02	0.42
1:Y:114:GLN:HE21	1:Y:114:GLN:HB3	1.54	0.42
1:F:149:ASP:OD2	1:F:149:ASP:N	2.52	0.42
1:O:8:SER:N	5:O:986:HOH:O	2.53	0.42
1:O:19:LEU:C	1:O:19:LEU:CD2	2.87	0.42
1:W:136:PRO:HG3	5:W:2971:HOH:O	2.19	0.42
1:1:55:GLU:CD	1:1:220:ARG:HH21	2.22	0.42
1:A:18:GLU:CG	1:A:22:LYS:HE3	2.49	0.41
1:D:55:GLU:HB2	1:D:222:PHE:CG	2.55	0.41
1:F:76:ARG:HD3	5:F:990:HOH:O	2.19	0.41
1:F:133:THR:HG23	1:F:133:THR:O	2.20	0.41
1:M:21:ARG:CZ	1:M:21:ARG:HB3	2.49	0.41
1:M:163:ILE:CG2	1:M:188:LEU:HA	2.50	0.41
2:X:444:LEU:CB	5:X:2899:HOH:O	2.46	0.41
2:Z:301:THR:CG2	2:Z:302:THR:N	2.83	0.41
2:G:392:ALA:HA	2:G:395:MET:CE	2.50	0.41
1:I:167:LEU:HD13	1:I:187:ALA:CB	2.50	0.41

Continued on next page...

Continued from previous page...

Atom-1	Atom-2	Interatomic distance (Å)	Clash overlap (Å)
1:O:81:PHE:CZ	1:O:102:VAL:HG21	2.55	0.41
1:S:233:LEU:HD12	1:S:233:LEU:N	2.35	0.41
2:T:392:ALA:HA	2:T:395:MET:HE3	1.99	0.41
1:1:123:CYS:HA	1:1:139:TYR:O	2.20	0.41
1:A:68:PHE:HA	1:A:71:PHE:CE2	2.55	0.41
1:B:232:ALA:O	1:B:233:LEU:CB	2.30	0.41
1:D:164:ALA:O	1:D:167:LEU:CB	2.67	0.41
1:I:87:TYR:CZ	2:J:358:LEU:HD13	2.55	0.41
1:O:133:THR:O	1:O:133:THR:HG23	2.20	0.41
2:Z:413:ASP:HA	2:Z:414:PRO:HD3	1.89	0.41
1:1:55:GLU:HB2	1:1:222:PHE:CG	2.55	0.41
1:A:45:ASN:OD1	1:A:45:ASN:C	2.59	0.41
1:B:8:SER:HA	1:B:9:PRO:C	2.40	0.41
1:B:21:ARG:HB3	1:B:21:ARG:NH1	2.35	0.41
1:D:48:ARG:HG2	1:K:149:ASP:OD1	2.17	0.41
1:D:98:GLN:O	1:D:102:VAL:HG23	2.20	0.41
1:D:152:HIS:CG	1:D:171:TYR:CZ	3.07	0.41
2:G:430:ASN:ND2	5:G:1095:HOH:O	2.53	0.41
2:J:324:ASN:HD22	2:J:324:ASN:HA	1.63	0.41
2:L:390:ASN:HA	5:L:963:HOH:O	2.20	0.41
1:O:182:ARG:HG2	1:O:234:LEU:HD23	2.02	0.41
1:S:110:ILE:HG21	1:S:118:TYR:CD1	2.55	0.41
1:S:229:ALA:O	1:S:232:ALA:HB3	2.20	0.41
1:W:16:ARG:HB3	1:W:117:PRO:HG2	2.02	0.41
1:W:55:GLU:HB2	1:W:222:PHE:CG	2.56	0.41
1:Y:68:PHE:HA	1:Y:71:PHE:CE2	2.54	0.41
1:A:163:ILE:HD13	1:A:188:LEU:HD12	2.03	0.41
1:F:49:SER:HB3	1:W:97:ARG:HD2	2.03	0.41
2:H:393:ALA:HB1	2:H:398:LEU:HD12	2.03	0.41
1:M:150:GLU:HA	1:M:151:PRO:HD3	1.86	0.41
1:O:56:LEU:HD23	1:O:56:LEU:HA	1.86	0.41
1:S:70:GLU:HB3	1:S:118:TYR:CD2	2.55	0.41
1:S:90:ASP:HB3	1:S:93:ASP:OD2	2.19	0.41
2:Z:329:ARG:HD3	5:Z:924:HOH:O	2.20	0.41
1:D:114:GLN:HE21	1:D:114:GLN:HB3	1.52	0.41
1:F:93:ASP:OD1	2:N:375:THR:HG23	2.20	0.41
1:M:70:GLU:HB3	1:M:118:TYR:CD2	2.55	0.41
1:Q:89:TYR:CD1	2:Z:374:LEU:HD11	2.56	0.41
2:V:486:LEU:HB2	5:V:1158:HOH:O	2.21	0.41
1:W:18:GLU:CG	1:W:22:LYS:HE3	2.48	0.41
1:W:228:SER:O	1:W:232:ALA:HB3	2.21	0.41

Continued on next page...

Continued from previous page...

Atom-1	Atom-2	Interatomic distance (Å)	Clash overlap (Å)
2:X:422:SER:HB3	2:X:437:GLN:HG2	2.02	0.41
2:2:341:THR:CG2	2:2:404:LEU:HD11	2.51	0.41
1:A:56:LEU:HD23	1:A:56:LEU:HA	1.90	0.41
1:B:18:GLU:CG	1:B:22:LYS:HE3	2.49	0.41
2:E:509:ARG:NE	5:E:1528:HOH:O	2.43	0.41
1:O:233:LEU:N	1:O:233:LEU:HD12	2.36	0.41
1:W:123:CYS:HA	1:W:139:TYR:O	2.20	0.41
2:Z:462:SER:O	2:Z:466:VAL:HG23	2.20	0.41
2:C:374:LEU:HD11	1:I:89:TYR:CD1	2.56	0.41
2:G:362:GLU:OE2	2:G:382:ARG:CD	2.69	0.41
2:P:308:TYR:CZ	2:P:311:GLY:HA3	2.54	0.41
1:U:230:LEU:O	1:U:234:LEU:CG	2.62	0.41
2:V:364:GLU:HG2	2:V:368:LYS:HD3	2.03	0.41
1:W:170:SER:OG	1:W:170:SER:O	2.34	0.41
1:W:177:LEU:HG	1:W:233:LEU:HD21	2.03	0.41
1:B:56:LEU:HD23	1:B:56:LEU:HA	1.80	0.41
1:D:58:ASP:OD2	1:D:219:ARG:CG	2.69	0.41
1:K:95:THR:OG1	1:K:98:GLN:HG3	2.21	0.41
1:K:147:ILE:HG21	1:K:147:ILE:HD13	1.84	0.41
2:L:444:LEU:HB2	5:L:2568:HOH:O	2.20	0.41
2:N:517:ILE:O	2:N:520:SER:HB3	2.21	0.41
2:R:306:LEU:CD1	2:R:313:VAL:CG1	2.99	0.41
2:R:363:LEU:HD12	2:R:363:LEU:HA	1.87	0.41
1:S:16:ARG:HB3	1:S:117:PRO:HG2	2.03	0.41
2:X:366:TYR:CE2	2:X:374:LEU:HD13	2.56	0.41
1:B:21:ARG:HG2	5:B:1479:HOH:O	2.19	0.41
1:F:181:LEU:O	1:F:185:VAL:HG23	2.21	0.41
2:L:392:ALA:HB3	5:L:813:HOH:O	2.21	0.41
1:O:46:PRO:HG2	1:O:47:SER:N	2.36	0.41
1:Q:68:PHE:HA	1:Q:71:PHE:CE2	2.55	0.41
1:U:40:LEU:HD12	1:U:212:VAL:HG12	2.03	0.41
1:B:167:LEU:HD13	1:B:187:ALA:CB	2.51	0.40
1:B:176:SER:HB3	1:B:179:ASP:OD2	2.21	0.40
2:C:341:THR:CG2	2:C:404:LEU:HD11	2.51	0.40
1:O:40:LEU:HD21	1:O:181:LEU:HA	2.03	0.40
1:O:93:ASP:OD1	2:V:375:THR:HG23	2.20	0.40
2:R:320:SER:HB3	2:R:328:GLY:CA	2.51	0.40
2:R:498:ASP:HB2	5:R:144:HOH:O	2.20	0.40
1:U:231:GLN:O	1:U:234:LEU:CB	2.56	0.40
1:Y:15:GLU:O	1:Y:16:ARG:C	2.57	0.40
1:Y:152:HIS:CD2	1:Y:171:TYR:OH	2.75	0.40

Continued on next page...

Continued from previous page...

Atom-1	Atom-2	Interatomic distance (Å)	Clash overlap (Å)
1:B:33:LEU:HD23	1:B:167:LEU:HD21	2.03	0.40
1:B:52:LYS:HE2	1:B:64:ALA:O	2.21	0.40
1:B:98:GLN:O	1:B:102:VAL:HG23	2.21	0.40
1:D:9:PRO:HD2	1:Q:15:GLU:HG2	2.02	0.40
2:E:301:THR:CG2	2:E:302:THR:N	2.85	0.40
1:I:115:ALA:HB3	1:S:112:THR:HG22	2.03	0.40
1:M:163:ILE:HG23	1:M:188:LEU:N	2.36	0.40
1:S:205:VAL:HG11	5:S:2979:HOH:O	2.20	0.40
1:Y:35:TYR:HB2	1:Y:175:ALA:O	2.21	0.40
2:Z:505:VAL:HA	2:Z:506:PRO:HD3	1.97	0.40
1:A:41:PHE:CD1	1:A:63:ALA:HB2	2.56	0.40
1:A:163:ILE:HG23	1:A:187:ALA:C	2.41	0.40
2:C:382:ARG:NH2	2:C:385:ILE:HD13	2.37	0.40
1:D:33:LEU:HD12	1:D:40:LEU:HB3	2.03	0.40
1:D:135:ARG:HH22	1:D:173:GLU:CD	2.24	0.40
1:K:231:GLN:O	1:K:234:LEU:HB2	2.21	0.40
1:O:217:ARG:NH2	1:O:223:ARG:HD3	2.36	0.40
2:V:464:LEU:O	2:V:468:VAL:HG23	2.21	0.40
2:X:509:ARG:HA	2:X:509:ARG:HD2	1.87	0.40
1:1:68:PHE:HA	1:1:71:PHE:CE2	2.56	0.40
1:1:129:HIS:O	1:1:130:TYR:C	2.59	0.40
1:D:56:LEU:HD23	1:D:56:LEU:HA	1.85	0.40
2:G:412:SER:O	2:G:414:PRO:HD3	2.22	0.40
1:M:71:PHE:C	1:M:71:PHE:CD1	2.95	0.40
1:Q:70:GLU:HB3	1:Q:118:TYR:CD2	2.57	0.40
1:U:8:SER:O	1:U:11:GLN:N	2.55	0.40
1:U:105:GLN:HG3	1:1:73:ASN:ND2	2.36	0.40
1:W:28:LYS:HB2	1:W:52:LYS:HZ1	1.84	0.40
2:X:444:LEU:HD12	5:X:2899:HOH:O	2.21	0.40
1:Y:39:VAL:HG12	1:Y:40:LEU:N	2.36	0.40
1:D:58:ASP:O	1:D:59:ARG:HD2	2.21	0.40
2:E:403:LEU:HD12	2:E:403:LEU:HA	1.90	0.40
1:F:95:THR:OG1	1:F:98:GLN:HG3	2.21	0.40
1:F:225:ILE:HG21	1:F:233:LEU:HD23	2.03	0.40
1:I:116:LYS:HD2	1:S:13:MET:HE1	2.02	0.40
2:R:362:GLU:OE2	2:R:382:ARG:CD	2.69	0.40
1:S:217:ARG:HA	1:S:218:PRO:HD3	1.98	0.40
1:U:70:GLU:HB3	1:U:118:TYR:CD2	2.57	0.40
1:1:114:GLN:HE21	1:1:114:GLN:HB3	1.52	0.40
1:1:225:ILE:HG21	1:1:233:LEU:HD22	2.03	0.40
2:2:320:SER:HB3	2:2:328:GLY:CA	2.51	0.40

There are no symmetry-related clashes.

5.3 Torsion angles [i](#)

5.3.1 Protein backbone [i](#)

In the following table, the Percentiles column shows the percent Ramachandran outliers of the chain as a percentile score with respect to all X-ray entries followed by that with respect to entries of similar resolution.

The Analysed column shows the number of residues for which the backbone conformation was analysed, and the total number of residues.

Mol	Chain	Analysed	Favoured	Allowed	Outliers	Percentiles	
1	1	211/248 (85%)	199 (94%)	11 (5%)	1 (0%)	29	48
1	A	210/248 (85%)	203 (97%)	7 (3%)	0	100	100
1	B	209/248 (84%)	203 (97%)	6 (3%)	0	100	100
1	D	209/248 (84%)	203 (97%)	6 (3%)	0	100	100
1	F	212/248 (86%)	208 (98%)	4 (2%)	0	100	100
1	I	211/248 (85%)	208 (99%)	3 (1%)	0	100	100
1	K	211/248 (85%)	204 (97%)	7 (3%)	0	100	100
1	M	210/248 (85%)	204 (97%)	6 (3%)	0	100	100
1	O	210/248 (85%)	203 (97%)	7 (3%)	0	100	100
1	Q	210/248 (85%)	202 (96%)	8 (4%)	0	100	100
1	S	211/248 (85%)	204 (97%)	7 (3%)	0	100	100
1	U	210/248 (85%)	206 (98%)	4 (2%)	0	100	100
1	W	211/248 (85%)	205 (97%)	6 (3%)	0	100	100
1	Y	212/248 (86%)	206 (97%)	6 (3%)	0	100	100
2	2	220/240 (92%)	220 (100%)	0	0	100	100
2	C	220/240 (92%)	220 (100%)	0	0	100	100
2	E	220/240 (92%)	218 (99%)	2 (1%)	0	100	100
2	G	220/240 (92%)	218 (99%)	2 (1%)	0	100	100
2	H	220/240 (92%)	217 (99%)	3 (1%)	0	100	100
2	J	220/240 (92%)	218 (99%)	2 (1%)	0	100	100
2	L	220/240 (92%)	218 (99%)	2 (1%)	0	100	100
2	N	220/240 (92%)	218 (99%)	2 (1%)	0	100	100

Continued on next page...

Continued from previous page...

Mol	Chain	Analysed	Favoured	Allowed	Outliers	Percentiles	
2	P	220/240 (92%)	218 (99%)	2 (1%)	0	100	100
2	R	227/240 (95%)	224 (99%)	3 (1%)	0	100	100
2	T	220/240 (92%)	219 (100%)	1 (0%)	0	100	100
2	V	227/240 (95%)	226 (100%)	1 (0%)	0	100	100
2	X	220/240 (92%)	219 (100%)	1 (0%)	0	100	100
2	Z	220/240 (92%)	217 (99%)	3 (1%)	0	100	100
3	a	1/3 (33%)	1 (100%)	0	0	100	100
3	b	1/3 (33%)	1 (100%)	0	0	100	100
3	c	1/3 (33%)	1 (100%)	0	0	100	100
3	d	1/3 (33%)	1 (100%)	0	0	100	100
3	e	1/3 (33%)	1 (100%)	0	0	100	100
3	f	1/3 (33%)	1 (100%)	0	0	100	100
3	g	1/3 (33%)	1 (100%)	0	0	100	100
3	h	1/3 (33%)	1 (100%)	0	0	100	100
3	i	1/3 (33%)	1 (100%)	0	0	100	100
3	j	1/3 (33%)	1 (100%)	0	0	100	100
3	k	1/3 (33%)	1 (100%)	0	0	100	100
3	l	1/3 (33%)	1 (100%)	0	0	100	100
3	m	1/3 (33%)	1 (100%)	0	0	100	100
3	n	1/3 (33%)	1 (100%)	0	0	100	100
All	All	6055/6874 (88%)	5942 (98%)	112 (2%)	1 (0%)	100	100

All (1) Ramachandran outliers are listed below:

Mol	Chain	Res	Type
1	1	131	GLY

5.3.2 Protein sidechains [i](#)

In the following table, the Percentiles column shows the percent sidechain outliers of the chain as a percentile score with respect to all X-ray entries followed by that with respect to entries of similar resolution.

The Analysed column shows the number of residues for which the sidechain conformation was analysed, and the total number of residues.

Mol	Chain	Analysed	Rotameric	Outliers	Percentiles	
1	1	164/192 (85%)	151 (92%)	13 (8%)	12	24
1	A	164/192 (85%)	160 (98%)	4 (2%)	49	74
1	B	163/192 (85%)	158 (97%)	5 (3%)	40	67
1	D	164/192 (85%)	152 (93%)	12 (7%)	14	27
1	F	165/192 (86%)	153 (93%)	12 (7%)	14	27
1	I	164/192 (85%)	157 (96%)	7 (4%)	29	53
1	K	164/192 (85%)	156 (95%)	8 (5%)	25	47
1	M	164/192 (85%)	154 (94%)	10 (6%)	18	36
1	O	164/192 (85%)	151 (92%)	13 (8%)	12	24
1	Q	164/192 (85%)	154 (94%)	10 (6%)	18	36
1	S	165/192 (86%)	158 (96%)	7 (4%)	30	54
1	U	164/192 (85%)	159 (97%)	5 (3%)	41	68
1	W	164/192 (85%)	159 (97%)	5 (3%)	41	68
1	Y	165/192 (86%)	156 (94%)	9 (6%)	21	41
2	2	165/178 (93%)	160 (97%)	5 (3%)	41	68
2	C	165/178 (93%)	161 (98%)	4 (2%)	49	74
2	E	165/178 (93%)	161 (98%)	4 (2%)	49	74
2	G	165/178 (93%)	160 (97%)	5 (3%)	41	68
2	H	165/178 (93%)	158 (96%)	7 (4%)	30	54
2	J	165/178 (93%)	160 (97%)	5 (3%)	41	68
2	L	165/178 (93%)	155 (94%)	10 (6%)	18	36
2	N	165/178 (93%)	159 (96%)	6 (4%)	35	61
2	P	165/178 (93%)	163 (99%)	2 (1%)	71	88
2	R	169/178 (95%)	163 (96%)	6 (4%)	35	61
2	T	165/178 (93%)	157 (95%)	8 (5%)	25	48
2	V	169/178 (95%)	163 (96%)	6 (4%)	35	61
2	X	165/178 (93%)	159 (96%)	6 (4%)	35	61
2	Z	165/178 (93%)	159 (96%)	6 (4%)	35	61
3	a	3/3 (100%)	3 (100%)	0	100	100
3	b	3/3 (100%)	3 (100%)	0	100	100
3	c	3/3 (100%)	3 (100%)	0	100	100
3	d	3/3 (100%)	3 (100%)	0	100	100

Continued on next page...

Continued from previous page...

Mol	Chain	Analysed	Rotameric	Outliers	Percentiles	
3	e	3/3 (100%)	3 (100%)	0	100	100
3	f	3/3 (100%)	3 (100%)	0	100	100
3	g	3/3 (100%)	3 (100%)	0	100	100
3	h	3/3 (100%)	3 (100%)	0	100	100
3	i	3/3 (100%)	3 (100%)	0	100	100
3	j	3/3 (100%)	3 (100%)	0	100	100
3	k	3/3 (100%)	3 (100%)	0	100	100
3	l	3/3 (100%)	3 (100%)	0	100	100
3	m	3/3 (100%)	3 (100%)	0	100	100
3	n	3/3 (100%)	3 (100%)	0	100	100
All	All	4658/5222 (89%)	4458 (96%)	200 (4%)	29	53

All (200) residues with a non-rotameric sidechain are listed below:

Mol	Chain	Res	Type
1	A	13	MET
1	A	33	LEU
1	A	173	GLU
1	A	188	LEU
1	B	69	ASN
1	B	73	ASN
1	B	169	GLU
1	B	173	GLU
1	B	225	ILE
2	C	312	VAL
2	C	369	LEU
2	C	486	LEU
2	C	513	LEU
1	D	33	LEU
1	D	48	ARG
1	D	49	SER
1	D	69	ASN
1	D	73	ASN
1	D	167	LEU
1	D	174	ASN
1	D	178	THR
1	D	181	LEU
1	D	189	ARG

Continued on next page...

Continued from previous page...

Mol	Chain	Res	Type
1	D	217	ARG
1	D	228	SER
2	E	312	VAL
2	E	369	LEU
2	E	416	SER
2	E	513	LEU
1	F	10	GLU
1	F	33	LEU
1	F	40	LEU
1	F	47	SER
1	F	48	ARG
1	F	69	ASN
1	F	73	ASN
1	F	147	ILE
1	F	178	THR
1	F	182	ARG
1	F	233	LEU
1	F	235	VAL
2	G	363	LEU
2	G	369	LEU
2	G	486	LEU
2	G	509	ARG
2	G	513	LEU
2	H	312	VAL
2	H	369	LEU
2	H	412	SER
2	H	416	SER
2	H	444	LEU
2	H	486	LEU
2	H	513	LEU
1	I	18	GLU
1	I	21	ARG
1	I	33	LEU
1	I	69	ASN
1	I	73	ASN
1	I	178	THR
1	I	234	LEU
2	J	324	ASN
2	J	363	LEU
2	J	369	LEU
2	J	486	LEU
2	J	513	LEU

Continued on next page...

Continued from previous page...

Mol	Chain	Res	Type
1	K	8	SER
1	K	48	ARG
1	K	73	ASN
1	K	178	THR
1	K	188	LEU
1	K	189	ARG
1	K	216	ASN
1	K	217	ARG
2	L	306	LEU
2	L	363	LEU
2	L	369	LEU
2	L	388	ARG
2	L	412	SER
2	L	416	SER
2	L	444	LEU
2	L	459	ASP
2	L	486	LEU
2	L	513	LEU
1	M	69	ASN
1	M	73	ASN
1	M	178	THR
1	M	183	ILE
1	M	188	LEU
1	M	189	ARG
1	M	216	ASN
1	M	223	ARG
1	M	233	LEU
1	M	234	LEU
2	N	363	LEU
2	N	369	LEU
2	N	412	SER
2	N	444	LEU
2	N	513	LEU
2	N	522	SER
1	O	15	GLU
1	O	33	LEU
1	O	48	ARG
1	O	69	ASN
1	O	73	ASN
1	O	160	THR
1	O	163	ILE
1	O	176	SER

Continued on next page...

Continued from previous page...

Mol	Chain	Res	Type
1	O	179	ASP
1	O	183	ILE
1	O	188	LEU
1	O	205	VAL
1	O	223	ARG
2	P	369	LEU
2	P	513	LEU
1	Q	13	MET
1	Q	21	ARG
1	Q	49	SER
1	Q	51	GLN
1	Q	69	ASN
1	Q	73	ASN
1	Q	169	GLU
1	Q	174	ASN
1	Q	176	SER
1	Q	178	THR
2	R	341	THR
2	R	363	LEU
2	R	369	LEU
2	R	444	LEU
2	R	496	ILE
2	R	513	LEU
1	S	33	LEU
1	S	51	GLN
1	S	69	ASN
1	S	73	ASN
1	S	176	SER
1	S	183	ILE
1	S	188	LEU
2	T	312	VAL
2	T	363	LEU
2	T	369	LEU
2	T	412	SER
2	T	414	PRO
2	T	415	GLN
2	T	486	LEU
2	T	513	LEU
1	U	33	LEU
1	U	69	ASN
1	U	73	ASN
1	U	178	THR

Continued on next page...

Continued from previous page...

Mol	Chain	Res	Type
1	U	226	THR
2	V	363	LEU
2	V	369	LEU
2	V	412	SER
2	V	434	GLU
2	V	444	LEU
2	V	513	LEU
1	W	73	ASN
1	W	178	THR
1	W	188	LEU
1	W	216	ASN
1	W	226	THR
2	X	312	VAL
2	X	330	ASP
2	X	363	LEU
2	X	369	LEU
2	X	513	LEU
2	X	519	GLU
1	Y	13	MET
1	Y	33	LEU
1	Y	44	GLU
1	Y	69	ASN
1	Y	73	ASN
1	Y	92	ARG
1	Y	133	THR
1	Y	135	ARG
1	Y	231	GLN
2	Z	312	VAL
2	Z	363	LEU
2	Z	369	LEU
2	Z	444	LEU
2	Z	496	ILE
2	Z	513	LEU
1	1	69	ASN
1	1	73	ASN
1	1	97	ARG
1	1	159	THR
1	1	160	THR
1	1	163	ILE
1	1	169	GLU
1	1	176	SER
1	1	183	ILE

Continued on next page...

Continued from previous page...

Mol	Chain	Res	Type
1	1	188	LEU
1	1	216	ASN
1	1	223	ARG
1	1	233	LEU
2	2	319	ARG
2	2	363	LEU
2	2	369	LEU
2	2	486	LEU
2	2	513	LEU

Sometimes sidechains can be flipped to improve hydrogen bonding and reduce clashes. All (116) such sidechains are listed below:

Mol	Chain	Res	Type
1	A	11	GLN
1	A	69	ASN
1	A	105	GLN
1	A	114	GLN
1	A	129	HIS
1	A	165	ASN
1	A	231	GLN
1	B	11	GLN
1	B	69	ASN
1	B	73	ASN
1	B	114	GLN
1	B	165	ASN
2	C	324	ASN
2	C	456	GLN
1	D	11	GLN
1	D	69	ASN
1	D	73	ASN
1	D	114	GLN
1	D	152	HIS
1	D	165	ASN
2	E	324	ASN
2	E	456	GLN
1	F	69	ASN
1	F	73	ASN
1	F	114	GLN
1	F	165	ASN
2	G	324	ASN
2	G	430	ASN
2	G	456	GLN

Continued on next page...

Continued from previous page...

Mol	Chain	Res	Type
2	H	324	ASN
2	H	456	GLN
1	I	69	ASN
1	I	73	ASN
1	I	114	GLN
1	I	129	HIS
2	J	324	ASN
2	J	456	GLN
1	K	69	ASN
1	K	73	ASN
1	K	105	GLN
1	K	114	GLN
1	K	165	ASN
2	L	324	ASN
2	L	396	GLN
2	L	456	GLN
1	M	11	GLN
1	M	69	ASN
1	M	73	ASN
1	M	114	GLN
2	N	324	ASN
2	N	456	GLN
1	O	69	ASN
1	O	73	ASN
1	O	105	GLN
1	O	114	GLN
1	O	129	HIS
1	O	231	GLN
2	P	324	ASN
2	P	456	GLN
1	Q	69	ASN
1	Q	73	ASN
1	Q	105	GLN
1	Q	114	GLN
1	Q	174	ASN
1	Q	231	GLN
2	R	322	GLN
2	R	324	ASN
2	R	456	GLN
1	S	11	GLN
1	S	51	GLN
1	S	69	ASN

Continued on next page...

Continued from previous page...

Mol	Chain	Res	Type
1	S	73	ASN
1	S	105	GLN
1	S	114	GLN
1	S	165	ASN
2	T	324	ASN
2	T	430	ASN
2	T	456	GLN
1	U	11	GLN
1	U	69	ASN
1	U	73	ASN
1	U	105	GLN
1	U	114	GLN
1	U	165	ASN
2	V	324	ASN
2	V	456	GLN
1	W	11	GLN
1	W	69	ASN
1	W	101	ASN
1	W	105	GLN
1	W	114	GLN
1	W	152	HIS
1	W	165	ASN
1	W	231	GLN
2	X	322	GLN
2	X	324	ASN
2	X	456	GLN
1	Y	11	GLN
1	Y	69	ASN
1	Y	73	ASN
1	Y	105	GLN
1	Y	114	GLN
1	Y	152	HIS
1	Y	165	ASN
2	Z	324	ASN
2	Z	456	GLN
1	1	11	GLN
1	1	69	ASN
1	1	73	ASN
1	1	101	ASN
1	1	105	GLN
1	1	114	GLN
1	1	129	HIS

Continued on next page...

Continued from previous page...

Mol	Chain	Res	Type
1	1	231	GLN
2	2	324	ASN
2	2	456	GLN

5.3.3 RNA [i](#)

There are no RNA molecules in this entry.

5.4 Non-standard residues in protein, DNA, RNA chains [i](#)

There are no non-standard protein/DNA/RNA residues in this entry.

5.5 Carbohydrates [i](#)

There are no monosaccharides in this entry.

5.6 Ligand geometry [i](#)

14 ligands are modelled in this entry.

In the following table, the Counts columns list the number of bonds (or angles) for which Mogul statistics could be retrieved, the number of bonds (or angles) that are observed in the model and the number of bonds (or angles) that are defined in the Chemical Component Dictionary. The Link column lists molecule types, if any, to which the group is linked. The Z score for a bond length (or angle) is the number of standard deviations the observed value is removed from the expected value. A bond length (or angle) with $|Z| > 2$ is considered an outlier worth inspection. RMSZ is the root-mean-square of all Z scores of the bond lengths (or angles).

Mol	Type	Chain	Res	Link	Bond lengths			Bond angles		
					Counts	RMSZ	# Z > 2	Counts	RMSZ	# Z > 2
4	HXD	d	4	3	6,6,14	1.87	2 (33%)	6,6,15	1.30	1 (16%)
4	HXD	g	4	3	6,6,14	1.06	0	6,6,15	1.32	1 (16%)
4	HXD	k	4	3	6,6,14	1.09	0	6,6,15	1.15	1 (16%)
4	HXD	f	4	3	6,6,14	1.18	0	6,6,15	1.26	0
4	HXD	l	4	3	6,6,14	1.32	1 (16%)	6,6,15	1.30	1 (16%)
4	HXD	h	4	3	6,6,14	1.48	1 (16%)	6,6,15	1.37	1 (16%)
4	HXD	a	4	3	6,6,14	1.24	0	6,6,15	1.18	1 (16%)
4	HXD	c	4	3	6,6,14	1.15	1 (16%)	6,6,15	1.19	0
4	HXD	i	4	3	6,6,14	1.37	1 (16%)	6,6,15	1.07	0

Mol	Type	Chain	Res	Link	Bond lengths			Bond angles		
					Counts	RMSZ	# Z > 2	Counts	RMSZ	# Z > 2
4	HXD	n	4	3	6,6,14	1.12	0	6,6,15	1.22	0
4	HXD	j	4	3	6,6,14	1.31	1 (16%)	6,6,15	1.21	0
4	HXD	b	4	3	6,6,14	1.36	1 (16%)	6,6,15	1.11	0
4	HXD	m	4	3	6,6,14	1.08	0	6,6,15	1.12	1 (16%)
4	HXD	e	4	3	6,6,14	1.15	0	6,6,15	1.18	1 (16%)

In the following table, the Chirals column lists the number of chiral outliers, the number of chiral centers analysed, the number of these observed in the model and the number defined in the Chemical Component Dictionary. Similar counts are reported in the Torsion and Rings columns. '-' means no outliers of that kind were identified.

Mol	Type	Chain	Res	Link	Chirals	Torsions	Rings
4	HXD	d	4	3	-	0/5/5/13	-
4	HXD	g	4	3	-	0/5/5/13	-
4	HXD	k	4	3	-	0/5/5/13	-
4	HXD	f	4	3	-	0/5/5/13	-
4	HXD	l	4	3	-	0/5/5/13	-
4	HXD	h	4	3	-	0/5/5/13	-
4	HXD	a	4	3	-	0/5/5/13	-
4	HXD	c	4	3	-	0/5/5/13	-
4	HXD	i	4	3	-	0/5/5/13	-
4	HXD	n	4	3	-	0/5/5/13	-
4	HXD	j	4	3	-	0/5/5/13	-
4	HXD	b	4	3	-	0/5/5/13	-
4	HXD	m	4	3	-	0/5/5/13	-
4	HXD	e	4	3	-	0/5/5/13	-

All (8) bond length outliers are listed below:

Mol	Chain	Res	Type	Atoms	Z	Observed(Å)	Ideal(Å)
4	d	4	HXD	C2-C1	2.96	1.57	1.49
4	d	4	HXD	C2-C3	2.95	1.57	1.53
4	h	4	HXD	C2-C1	2.52	1.56	1.49
4	l	4	HXD	C2-C1	2.26	1.55	1.49
4	c	4	HXD	C2-C1	2.18	1.55	1.49
4	i	4	HXD	C2-C1	2.16	1.55	1.49
4	j	4	HXD	C2-C1	2.12	1.55	1.49
4	b	4	HXD	C2-C1	2.01	1.55	1.49

All (8) bond angle outliers are listed below:

Mol	Chain	Res	Type	Atoms	Z	Observed($^{\circ}$)	Ideal($^{\circ}$)
4	g	4	HXD	O8-C3-C2	-2.49	102.81	109.47
4	a	4	HXD	C3-C2-C1	2.36	116.90	112.75
4	d	4	HXD	C3-C2-C1	2.30	116.79	112.75
4	h	4	HXD	C3-C2-C1	2.30	116.79	112.75
4	l	4	HXD	C3-C2-C1	2.28	116.75	112.75
4	m	4	HXD	O8-C3-C2	-2.19	103.63	109.47
4	e	4	HXD	C3-C2-C1	2.11	116.46	112.75
4	k	4	HXD	O8-C3-C2	-2.02	104.06	109.47

There are no chirality outliers.

There are no torsion outliers.

There are no ring outliers.

No monomer is involved in short contacts.

5.7 Other polymers [i](#)

There are no such residues in this entry.

5.8 Polymer linkage issues [i](#)

There are no chain breaks in this entry.

6 Fit of model and data [i](#)

6.1 Protein, DNA and RNA chains [i](#)

In the following table, the column labelled ‘#RSRZ> 2’ contains the number (and percentage) of RSRZ outliers, followed by percent RSRZ outliers for the chain as percentile scores relative to all X-ray entries and entries of similar resolution. The OWAB column contains the minimum, median, 95th percentile and maximum values of the occupancy-weighted average B-factor per residue. The column labelled ‘Q< 0.9’ lists the number of (and percentage) of residues with an average occupancy less than 0.9.

Mol	Chain	Analysed	<RSRZ>	#RSRZ>2	OWAB(Å ²)	Q<0.9
1	1	215/248 (86%)	0.47	17 (7%) 12 12	23, 51, 86, 94	0
1	A	214/248 (86%)	0.62	29 (13%) 3 2	24, 53, 88, 100	0
1	B	213/248 (85%)	0.54	16 (7%) 14 14	24, 52, 87, 94	0
1	D	213/248 (85%)	0.97	49 (23%) 0 0	25, 55, 93, 112	0
1	F	216/248 (87%)	0.46	13 (6%) 21 22	23, 53, 86, 93	0
1	I	215/248 (86%)	0.53	20 (9%) 8 8	24, 52, 87, 95	0
1	K	215/248 (86%)	0.43	17 (7%) 12 12	24, 53, 87, 95	0
1	M	214/248 (86%)	0.57	20 (9%) 8 8	23, 54, 88, 96	0
1	O	214/248 (86%)	0.56	22 (10%) 6 6	22, 53, 88, 95	0
1	Q	214/248 (86%)	0.63	22 (10%) 6 6	26, 52, 87, 95	0
1	S	215/248 (86%)	0.69	31 (14%) 2 2	24, 53, 89, 99	0
1	U	214/248 (86%)	0.59	23 (10%) 6 5	23, 53, 87, 95	0
1	W	215/248 (86%)	0.68	28 (13%) 3 3	24, 54, 93, 98	0
1	Y	216/248 (87%)	0.76	38 (17%) 1 1	26, 55, 90, 98	0
2	2	222/240 (92%)	-0.36	1 (0%) 91 91	12, 23, 41, 66	0
2	C	222/240 (92%)	-0.35	4 (1%) 68 71	12, 24, 41, 68	0
2	E	222/240 (92%)	-0.38	1 (0%) 91 91	13, 24, 41, 65	0
2	G	222/240 (92%)	-0.33	3 (1%) 75 77	14, 24, 43, 68	0
2	H	222/240 (92%)	-0.37	0 100 100	11, 24, 42, 66	0
2	J	222/240 (92%)	-0.35	0 100 100	12, 24, 43, 65	0
2	L	222/240 (92%)	-0.38	0 100 100	13, 24, 42, 65	0
2	N	222/240 (92%)	-0.29	5 (2%) 60 63	13, 24, 43, 67	0
2	P	222/240 (92%)	-0.37	2 (0%) 84 86	14, 24, 42, 67	0
2	R	229/240 (95%)	-0.39	3 (1%) 77 79	13, 24, 46, 67	0

Continued on next page...

Continued from previous page...

Mol	Chain	Analysed	<RSRZ>	#RSRZ>2	OWAB(Å ²)	Q<0.9
2	T	222/240 (92%)	-0.35	0 100 100	15, 25, 43, 67	0
2	V	229/240 (95%)	-0.39	3 (1%) 77 79	12, 23, 44, 67	0
2	X	222/240 (92%)	-0.38	4 (1%) 68 71	13, 25, 43, 67	0
2	Z	222/240 (92%)	-0.33	3 (1%) 75 77	13, 25, 43, 67	0
3	a	3/3 (100%)	-0.61	0 100 100	24, 24, 24, 26	0
3	b	3/3 (100%)	-0.62	0 100 100	20, 20, 22, 23	0
3	c	3/3 (100%)	-0.52	0 100 100	23, 23, 24, 28	0
3	d	3/3 (100%)	-0.68	0 100 100	22, 22, 25, 27	0
3	e	3/3 (100%)	-0.78	0 100 100	21, 21, 23, 24	0
3	f	3/3 (100%)	-0.50	0 100 100	21, 21, 24, 28	0
3	g	3/3 (100%)	-0.63	0 100 100	21, 21, 22, 28	0
3	h	3/3 (100%)	-0.59	0 100 100	23, 23, 28, 28	0
3	i	3/3 (100%)	-0.43	0 100 100	25, 25, 26, 27	0
3	j	3/3 (100%)	-0.60	0 100 100	26, 26, 27, 30	0
3	k	3/3 (100%)	-0.88	0 100 100	22, 22, 25, 28	0
3	l	3/3 (100%)	-0.40	0 100 100	23, 23, 27, 27	0
3	m	3/3 (100%)	-0.50	0 100 100	30, 30, 30, 31	0
3	n	3/3 (100%)	-0.59	0 100 100	25, 25, 27, 28	0
All	All	6167/6874 (89%)	0.11	374 (6%) 21 22	11, 35, 84, 112	0

All (374) RSRZ outliers are listed below:

Mol	Chain	Res	Type	RSRZ
1	D	233	LEU	7.0
1	B	205	VAL	6.5
1	Y	12	ALA	6.4
1	Y	10	GLU	6.3
1	S	235	VAL	5.0
1	I	182	ARG	4.9
1	Y	11	GLN	4.9
1	M	10	GLU	4.8
2	Z	414	PRO	4.7
1	W	14	ARG	4.4
1	D	11	GLN	4.4
1	D	226	THR	4.3
1	Y	9	PRO	4.3

Continued on next page...

Continued from previous page...

Mol	Chain	Res	Type	RSRZ
1	S	191	GLY	4.1
1	U	205	VAL	4.1
1	1	11	GLN	4.1
1	F	169	GLU	4.1
1	Y	22	LYS	4.1
1	D	159	THR	4.1
1	U	131	GLY	4.1
1	D	169	GLU	4.1
1	Q	205	VAL	4.1
2	G	411	ALA	4.0
1	Q	14	ARG	4.0
1	W	11	GLN	4.0
1	I	8	SER	3.9
1	K	131	GLY	3.9
1	D	26	ARG	3.9
1	U	232	ALA	3.9
1	D	10	GLU	3.9
1	U	206	ALA	3.8
2	P	412	SER	3.8
1	W	233	LEU	3.8
1	D	160	THR	3.8
1	W	182	ARG	3.8
1	D	205	VAL	3.8
1	D	165	ASN	3.7
1	D	227	GLY	3.7
1	Y	26	ARG	3.7
1	1	205	VAL	3.7
1	O	172	ALA	3.7
1	D	135	ARG	3.6
1	Q	169	GLU	3.6
1	K	11	GLN	3.6
1	A	28	LYS	3.6
1	D	171	TYR	3.6
1	W	135	ARG	3.5
1	Q	131	GLY	3.5
1	B	48	ARG	3.5
1	M	8	SER	3.5
1	D	234	LEU	3.5
1	Q	26	ARG	3.5
1	U	48	ARG	3.5
1	A	48	ARG	3.5
1	Y	14	ARG	3.5

Continued on next page...

Continued from previous page...

Mol	Chain	Res	Type	RSRZ
1	D	14	ARG	3.4
1	D	21	ARG	3.4
1	M	46	PRO	3.4
1	D	27	ALA	3.4
1	M	227	GLY	3.4
1	Y	31	VAL	3.4
1	B	206	ALA	3.4
1	M	172	ALA	3.4
1	O	231	GLN	3.4
1	A	171	TYR	3.3
1	D	180	ALA	3.3
1	D	44	GLU	3.3
1	F	133	THR	3.3
2	P	414	PRO	3.3
1	O	189	ARG	3.3
2	Z	415	GLN	3.3
1	K	161	GLU	3.3
1	S	161	GLU	3.3
1	A	11	GLN	3.3
1	D	179	ASP	3.3
1	1	8	SER	3.3
1	A	231	GLN	3.3
2	G	415	GLN	3.3
1	D	188	LEU	3.2
1	A	165	ASN	3.2
1	W	228	SER	3.2
1	D	42	VAL	3.2
1	D	48	ARG	3.2
1	A	172	ALA	3.2
2	R	529	SER	3.2
1	M	31	VAL	3.2
1	W	8	SER	3.2
1	M	48	ARG	3.2
1	A	133	THR	3.1
1	B	173	GLU	3.1
1	W	133	THR	3.1
1	D	131	GLY	3.1
2	N	416	SER	3.1
1	D	163	ILE	3.1
1	W	48	ARG	3.1
1	O	8	SER	3.1
2	N	415	GLN	3.1

Continued on next page...

Continued from previous page...

Mol	Chain	Res	Type	RSRZ
1	1	10	GLU	3.0
1	O	182	ARG	3.0
1	Y	8	SER	3.0
1	S	162	PRO	3.0
1	A	131	GLY	3.0
1	W	231	GLN	3.0
1	D	206	ALA	3.0
1	A	158	GLY	3.0
1	W	131	GLY	3.0
1	W	204	GLY	3.0
1	W	12	ALA	3.0
1	D	31	VAL	3.0
1	S	42	VAL	3.0
1	A	135	ARG	3.0
1	A	207	SER	3.0
1	A	10	GLU	3.0
1	D	231	GLN	3.0
1	U	182	ARG	3.0
1	Q	154	VAL	2.9
1	D	161	GLU	2.9
1	U	8	SER	2.9
1	Y	133	THR	2.9
1	I	42	VAL	2.9
1	Y	231	GLN	2.9
1	O	41	PHE	2.9
1	A	167	LEU	2.9
1	W	26	ARG	2.9
1	M	49	SER	2.9
2	C	415	GLN	2.9
1	B	14	ARG	2.9
1	W	15	GLU	2.9
1	S	228	SER	2.9
1	K	229	ALA	2.9
1	Q	41	PHE	2.8
1	D	184	ALA	2.8
1	K	234	LEU	2.8
1	S	165	ASN	2.8
1	F	113	GLU	2.8
1	F	130	TYR	2.8
1	Q	171	TYR	2.8
1	W	179	ASP	2.8
1	S	41	PHE	2.8

Continued on next page...

Continued from previous page...

Mol	Chain	Res	Type	RSRZ
1	F	135	ARG	2.8
1	S	31	VAL	2.8
1	Y	191	GLY	2.8
1	O	173	GLU	2.7
1	B	131	GLY	2.7
1	D	158	GLY	2.7
1	W	163	ILE	2.7
1	1	206	ALA	2.7
1	I	161	GLU	2.7
1	O	31	VAL	2.7
1	O	39	VAL	2.7
1	O	42	VAL	2.7
1	S	205	VAL	2.7
1	1	14	ARG	2.7
1	D	46	PRO	2.7
1	A	44	GLU	2.7
1	Y	36	ALA	2.7
1	U	228	SER	2.7
1	Y	15	GLU	2.7
1	B	171	TYR	2.7
1	A	189	ARG	2.7
1	O	135	ARG	2.7
1	D	8	SER	2.7
1	D	133	THR	2.7
1	S	32	ALA	2.7
1	F	168	LYS	2.7
1	U	171	TYR	2.7
2	N	414	PRO	2.7
1	Q	10	GLU	2.6
1	W	21	ARG	2.6
2	V	529	SER	2.6
1	Q	174	ASN	2.6
1	Y	152	HIS	2.6
1	I	131	GLY	2.6
1	O	167	LEU	2.6
1	Q	11	GLN	2.6
1	B	169	GLU	2.6
1	M	113	GLU	2.6
2	X	412	SER	2.6
1	I	11	GLN	2.6
1	K	10	GLU	2.6
1	M	226	THR	2.6

Continued on next page...

Continued from previous page...

Mol	Chain	Res	Type	RSRZ
1	M	229	ALA	2.6
1	U	216	ASN	2.6
1	I	63	ALA	2.6
1	D	173	GLU	2.6
1	I	135	ARG	2.6
1	1	152	HIS	2.6
1	K	169	GLU	2.6
1	Y	161	GLU	2.6
1	I	48	ARG	2.5
1	S	28	LYS	2.5
1	D	217	ARG	2.5
1	I	189	ARG	2.5
1	O	14	ARG	2.5
1	D	172	ALA	2.5
1	M	11	GLN	2.5
1	A	46	PRO	2.5
1	I	31	VAL	2.5
1	U	227	GLY	2.5
1	U	189	ARG	2.5
1	W	113	GLU	2.5
2	N	433	GLU	2.5
1	W	205	VAL	2.5
1	Y	234	LEU	2.5
1	B	231	GLN	2.5
1	W	44	GLU	2.5
1	U	133	THR	2.5
2	N	413	ASP	2.5
1	I	167	LEU	2.5
1	A	15	GLU	2.5
1	U	173	GLU	2.5
1	W	189	ARG	2.5
1	B	32	ALA	2.5
1	Q	63	ALA	2.5
1	Y	63	ALA	2.5
1	Q	231	GLN	2.5
1	B	49	SER	2.5
1	Y	135	ARG	2.5
2	C	412	SER	2.5
1	Y	149	ASP	2.5
1	Y	151	PRO	2.5
1	1	32	ALA	2.5
1	1	15	GLU	2.5

Continued on next page...

Continued from previous page...

Mol	Chain	Res	Type	RSRZ
1	U	154	VAL	2.4
2	X	413	ASP	2.4
1	S	113	GLU	2.4
1	S	172	ALA	2.4
1	I	41	PHE	2.4
1	Y	174	ASN	2.4
1	A	14	ARG	2.4
1	O	190	ALA	2.4
1	Q	172	ALA	2.4
1	Y	30	VAL	2.4
1	Y	169	GLU	2.4
2	E	412	SER	2.4
1	S	227	GLY	2.4
1	S	125	ALA	2.4
1	Y	42	VAL	2.4
1	I	44	GLU	2.4
1	Q	113	GLU	2.4
1	D	230	LEU	2.4
1	S	135	ARG	2.4
1	Q	31	VAL	2.4
1	U	25	ALA	2.4
1	M	228	SER	2.4
1	1	135	ARG	2.4
1	S	40	LEU	2.4
1	1	165	ASN	2.4
1	D	130	TYR	2.4
1	U	13	MET	2.4
1	F	182	ARG	2.4
1	Q	32	ALA	2.4
1	Q	135	ARG	2.4
1	Y	123	CYS	2.4
1	Y	171	TYR	2.3
1	S	39	VAL	2.3
1	O	11	GLN	2.3
1	S	229	ALA	2.3
1	I	227	GLY	2.3
1	O	48	ARG	2.3
2	C	433	GLU	2.3
1	K	231	GLN	2.3
1	B	41	PHE	2.3
1	O	228	SER	2.3
1	Y	229	ALA	2.3

Continued on next page...

Continued from previous page...

Mol	Chain	Res	Type	RSRZ
1	K	44	GLU	2.3
1	I	186	ALA	2.3
1	S	158	GLY	2.3
2	R	412	SER	2.3
1	O	40	LEU	2.3
1	D	152	HIS	2.3
2	2	519	GLU	2.3
1	A	32	ALA	2.3
1	S	11	GLN	2.3
1	Y	182	ARG	2.3
1	S	131	GLY	2.3
1	D	225	ILE	2.3
1	F	32	ALA	2.3
2	C	519	GLU	2.3
1	1	168	LYS	2.2
2	V	415	GLN	2.2
1	M	32	ALA	2.2
1	U	32	ALA	2.2
1	I	133	THR	2.2
1	Y	41	PHE	2.2
1	1	132	GLU	2.2
1	A	168	LYS	2.2
1	D	168	LYS	2.2
1	S	233	LEU	2.2
1	O	30	VAL	2.2
1	A	169	GLU	2.2
1	B	161	GLU	2.2
1	O	169	GLU	2.2
1	Q	228	SER	2.2
2	G	416	SER	2.2
1	1	41	PHE	2.2
1	F	170	SER	2.2
1	W	207	SER	2.2
1	Y	28	LYS	2.2
1	K	21	ARG	2.2
1	M	135	ARG	2.2
1	Q	182	ARG	2.2
1	S	63	ALA	2.2
1	F	41	PHE	2.2
1	K	133	THR	2.2
1	D	151	PRO	2.2
1	M	44	GLU	2.2

Continued on next page...

Continued from previous page...

Mol	Chain	Res	Type	RSRZ
1	A	179	ASP	2.2
1	D	189	ARG	2.2
1	A	226	THR	2.2
1	U	11	GLN	2.2
1	M	167	LEU	2.2
1	S	179	ASP	2.2
1	Y	188	LEU	2.2
1	1	131	GLY	2.2
1	D	43	ALA	2.2
1	M	206	ALA	2.2
1	Y	206	ALA	2.2
1	I	158	GLY	2.2
1	U	234	LEU	2.2
1	Y	233	LEU	2.2
1	A	178	THR	2.1
1	K	26	ARG	2.1
1	K	135	ARG	2.1
2	R	415	GLN	2.1
2	V	416	SER	2.1
1	B	13	MET	2.1
1	U	31	VAL	2.1
1	F	10	GLU	2.1
2	X	410	HIS	2.1
1	U	123	CYS	2.1
1	I	231	GLN	2.1
1	S	123	CYS	2.1
1	A	41	PHE	2.1
1	S	169	GLU	2.1
1	U	41	PHE	2.1
1	W	161	GLU	2.1
1	D	28	LYS	2.1
1	Q	42	VAL	2.1
1	B	130	TYR	2.1
1	S	133	THR	2.1
1	S	171	TYR	2.1
1	W	46	PRO	2.1
1	I	26	ARG	2.1
1	1	189	ARG	2.1
1	Y	13	MET	2.1
1	B	189	ARG	2.1
1	Y	115	ALA	2.1
1	A	39	VAL	2.1

Continued on next page...

Continued from previous page...

Mol	Chain	Res	Type	RSRZ
1	1	42	VAL	2.1
1	A	182	ARG	2.1
1	S	217	ARG	2.1
1	O	179	ASP	2.0
1	W	171	TYR	2.0
1	A	9	PRO	2.0
1	F	63	ALA	2.0
1	K	31	VAL	2.0
1	Y	173	GLU	2.0
2	X	415	GLN	2.0
1	D	208	LEU	2.0
1	O	61	GLY	2.0
1	Q	234	LEU	2.0
1	D	162	PRO	2.0
1	W	152	HIS	2.0
1	M	30	VAL	2.0
1	K	163	ILE	2.0
1	M	40	LEU	2.0
1	K	130	TYR	2.0
1	Y	44	GLU	2.0
2	Z	413	ASP	2.0
1	F	22	LYS	2.0
1	K	168	LYS	2.0
1	D	156	MET	2.0
1	W	13	MET	2.0

6.2 Non-standard residues in protein, DNA, RNA chains [i](#)

There are no non-standard protein/DNA/RNA residues in this entry.

6.3 Carbohydrates [i](#)

There are no monosaccharides in this entry.

6.4 Ligands [i](#)

In the following table, the Atoms column lists the number of modelled atoms in the group and the number defined in the chemical component dictionary. The B-factors column lists the minimum, median, 95th percentile and maximum values of B factors of atoms in the group. The column labelled 'Q < 0.9' lists the number of atoms with occupancy less than 0.9.

Mol	Type	Chain	Res	Atoms	RSCC	RSR	B-factors(\AA^2)	Q<0.9
4	HXD	d	4	7/15	0.89	0.16	23,30,34,38	0
4	HXD	e	4	7/15	0.90	0.15	18,28,37,38	0
4	HXD	i	4	7/15	0.90	0.18	25,31,38,40	0
4	HXD	l	4	7/15	0.91	0.15	26,28,30,32	0
4	HXD	m	4	7/15	0.91	0.19	28,33,37,37	0
4	HXD	n	4	7/15	0.91	0.15	24,28,29,30	0
4	HXD	j	4	7/15	0.92	0.16	25,30,33,37	0
4	HXD	g	4	7/15	0.92	0.15	28,29,32,33	0
4	HXD	k	4	7/15	0.93	0.13	30,33,36,37	0
4	HXD	c	4	7/15	0.93	0.14	29,29,33,34	0
4	HXD	f	4	7/15	0.94	0.14	23,29,32,35	0
4	HXD	b	4	7/15	0.94	0.20	22,28,36,37	0
4	HXD	h	4	7/15	0.94	0.14	32,34,37,37	0
4	HXD	a	4	7/15	0.95	0.16	23,26,33,35	0

6.5 Other polymers [i](#)

There are no such residues in this entry.