



Full wwPDB X-ray Structure Validation Report ⓘ

Nov 6, 2023 – 07:17 PM EST

PDB ID : 4LAJ
Title : Crystal structure of HIV-1 YU2 envelope gp120 glycoprotein in complex with CD4-mimetic miniprotein, M48U1, and llama single-domain, broadly neutralizing, co-receptor binding site antibody, JM4
Authors : Acharya, P.; Luongo, T.S.; Kwong, P.D.
Deposited on : 2013-06-20
Resolution : 2.14 Å(reported)

This is a Full wwPDB X-ray Structure Validation Report for a publicly released PDB entry.

We welcome your comments at validation@mail.wwpdb.org

A user guide is available at

<https://www.wwpdb.org/validation/2017/XrayValidationReportHelp>

with specific help available everywhere you see the ⓘ symbol.

The types of validation reports are described at

<http://www.wwpdb.org/validation/2017/FAQs#types>.

The following versions of software and data (see [references ⓘ](#)) were used in the production of this report:

MolProbity : 4.02b-467
Mogul : 1.8.5 (274361), CSD as541be (2020)
Xtriage (Phenix) : 1.13
EDS : 2.36
Percentile statistics : 20191225.v01 (using entries in the PDB archive December 25th 2019)
Refmac : 5.8.0158
CCP4 : 7.0.044 (Gargrove)
Ideal geometry (proteins) : Engh & Huber (2001)
Ideal geometry (DNA, RNA) : Parkinson et al. (1996)
Validation Pipeline (wwPDB-VP) : 2.36

1 Overall quality at a glance i

The following experimental techniques were used to determine the structure:

X-RAY DIFFRACTION

The reported resolution of this entry is 2.14 Å.

Percentile scores (ranging between 0-100) for global validation metrics of the entry are shown in the following graphic. The table shows the number of entries on which the scores are based.

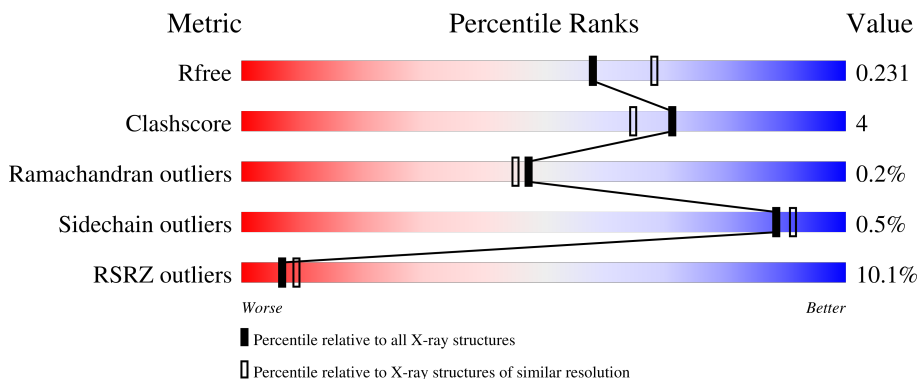

Metric	Whole archive (#Entries)	Similar resolution (#Entries, resolution range(Å))
R_{free}	130704	2523 (2.16-2.12)
Clashscore	141614	2653 (2.16-2.12)
Ramachandran outliers	138981	2618 (2.16-2.12)
Sidechain outliers	138945	2617 (2.16-2.12)
RSRZ outliers	127900	2485 (2.16-2.12)

The table below summarises the geometric issues observed across the polymeric chains and their fit to the electron density. The red, orange, yellow and green segments of the lower bar indicate the fraction of residues that contain outliers for ≥ 3 , 2, 1 and 0 types of geometric quality criteria respectively. A grey segment represents the fraction of residues that are not modelled. The numeric value for each fraction is indicated below the corresponding segment, with a dot representing fractions $\leq 5\%$. The upper red bar (where present) indicates the fraction of residues that have poor fit to the electron density. The numeric value is given above the bar.

Mol	Chain	Length	Quality of chain
1	A	376	 10% 86% 5% 9%
1	B	376	 8% 83% 7% 9%
1	F	376	 8% 85% 11% 9%
1	J	376	 9% 85% 5% 10%
2	C	28	 4% 82% 14% 9%

Continued on next page...

Continued from previous page...

Mol	Chain	Length	Quality of chain
2	D	28	
2	G	28	
2	K	28	
3	H	129	
3	I	129	
3	L	129	
3	M	129	

The following table lists non-polymeric compounds, carbohydrate monomers and non-standard residues in protein, DNA, RNA chains that are outliers for geometric or electron-density-fit criteria:

Mol	Type	Chain	Res	Chirality	Geometry	Clashes	Electron density
4	NAG	F	503	-	-	-	X
5	EDO	J	510	-	-	-	X

2 Entry composition [i](#)

There are 7 unique types of molecules in this entry. The entry contains 16384 atoms, of which 0 are hydrogens and 0 are deuteriums.

In the tables below, the ZeroOcc column contains the number of atoms modelled with zero occupancy, the AltConf column contains the number of residues with at least one atom in alternate conformation and the Trace column contains the number of residues modelled with at most 2 atoms.

- Molecule 1 is a protein called HIV-1 YU2 gp120 envelope glycoprotein.

Mol	Chain	Residues	Atoms					ZeroOcc	AltConf	Trace
			Total	C	N	O	S			
1	J	337	Total 2660	C 1669	N 465	O 506	S 20	0	6	0
1	F	334	Total 2633	C 1654	N 461	O 498	S 20	0	5	0
1	A	343	Total 2702	C 1693	N 474	O 515	S 20	0	4	0
1	B	341	Total 2680	C 1681	N 470	O 509	S 20	0	3	0

- Molecule 2 is a protein called CD4-mimetic miniprotein M48U1.

Mol	Chain	Residues	Atoms					ZeroOcc	AltConf	Trace
			Total	C	N	O	S			
2	K	28	Total 214	C 136	N 39	O 33	S 6	0	1	1
2	D	28	Total 209	C 133	N 38	O 32	S 6	0	0	1
2	G	28	Total 209	C 133	N 38	O 32	S 6	0	0	1
2	C	28	Total 209	C 133	N 38	O 32	S 6	0	0	1

- Molecule 3 is a protein called Llama single domain antibody, JM4.

Mol	Chain	Residues	Atoms					ZeroOcc	AltConf	Trace
			Total	C	N	O	S			
3	H	124	Total 944	C 589	N 156	O 193	S 6	0	0	0
3	M	123	Total 939	C 586	N 155	O 192	S 6	0	0	0
3	L	123	Total 939	C 586	N 155	O 192	S 6	0	0	0
3	I	125	Total 949	C 592	N 157	O 194	S 6	0	0	0

- Molecule 4 is 2-acetamido-2-deoxy-beta-D-glucopyranose (three-letter code: NAG) (formula: $C_8H_{15}NO_6$).

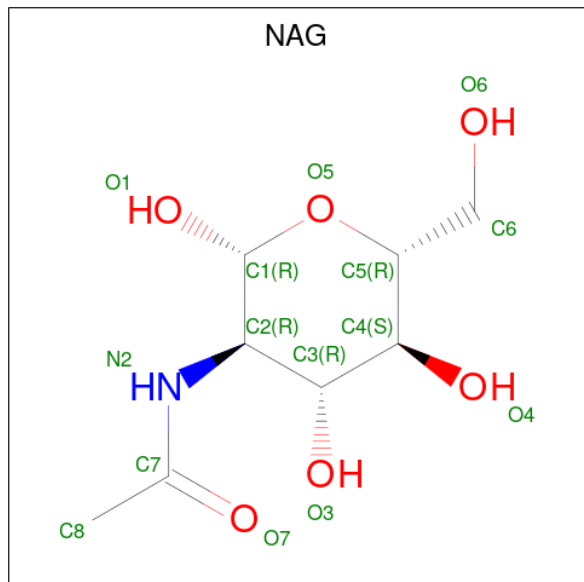

Mol	Chain	Residues	Atoms				ZeroOcc	AltConf
			Total	C	N	O		
4	J	1	Total	C	N	O	0	0
			14	8	1	5		
4	J	1	Total	C	N	O	0	0
			14	8	1	5		
4	J	1	Total	C	N	O	0	0
			14	8	1	5		
4	J	1	Total	C	N	O	0	0
			14	8	1	5		
4	J	1	Total	C	N	O	0	0
			14	8	1	5		
4	J	1	Total	C	N	O	0	0
			14	8	1	5		
4	J	1	Total	C	N	O	0	0
			14	8	1	5		
4	J	1	Total	C	N	O	0	0
			14	8	1	5		
4	F	1	Total	C	N	O	0	0
			14	8	1	5		
4	F	1	Total	C	N	O	0	0
			14	8	1	5		
4	F	1	Total	C	N	O	0	0
			14	8	1	5		

Continued on next page...

Continued from previous page...

Mol	Chain	Residues	Atoms				ZeroOcc	AltConf
4	F	1	Total	C	N	O	0	0
			14	8	1	5		
4	F	1	Total	C	N	O	0	0
			14	8	1	5		
4	F	1	Total	C	N	O	0	0
			14	8	1	5		
4	F	1	Total	C	N	O	0	0
			14	8	1	5		
4	F	1	Total	C	N	O	0	0
			14	8	1	5		
4	F	1	Total	C	N	O	0	0
			14	8	1	5		
4	A	1	Total	C	N	O	0	0
			14	8	1	5		
4	A	1	Total	C	N	O	0	0
			14	8	1	5		
4	A	1	Total	C	N	O	0	0
			14	8	1	5		
4	A	1	Total	C	N	O	0	0
			14	8	1	5		
4	A	1	Total	C	N	O	0	0
			14	8	1	5		
4	A	1	Total	C	N	O	0	0
			14	8	1	5		
4	A	1	Total	C	N	O	0	0
			14	8	1	5		
4	A	1	Total	C	N	O	0	0
			14	8	1	5		
4	A	1	Total	C	N	O	0	0
			14	8	1	5		
4	B	1	Total	C	N	O	0	0
			14	8	1	5		
4	B	1	Total	C	N	O	0	0
			14	8	1	5		
4	B	1	Total	C	N	O	0	0
			14	8	1	5		
4	B	1	Total	C	N	O	0	0
			14	8	1	5		
4	B	1	Total	C	N	O	0	0
			14	8	1	5		

Continued on next page...

Continued from previous page...

Mol	Chain	Residues	Atoms				ZeroOcc	AltConf
4	B	1	Total	C	N	O	0	0
			14	8	1	5		
4	B	1	Total	C	N	O	0	0
			14	8	1	5		

- Molecule 5 is 1,2-ETHANEDIOL (three-letter code: EDO) (formula: C₂H₆O₂).

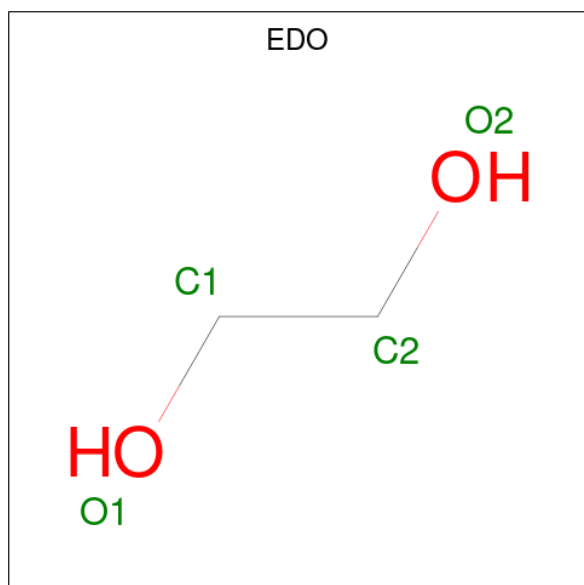

Mol	Chain	Residues	Atoms			ZeroOcc	AltConf
5	J	1	Total	C	O	0	0
			4	2	2		
5	A	1	Total	C	O	0	0
			4	2	2		
5	A	1	Total	C	O	0	0
			4	2	2		
5	A	1	Total	C	O	0	0
			4	2	2		
5	B	1	Total	C	O	0	0
			4	2	2		
5	B	1	Total	C	O	0	0
			4	2	2		
5	B	1	Total	C	O	0	0
			4	2	2		

- Molecule 6 is 6-AMINOHEXANOIC ACID (three-letter code: ACA) (formula: C₆H₁₃NO₂).

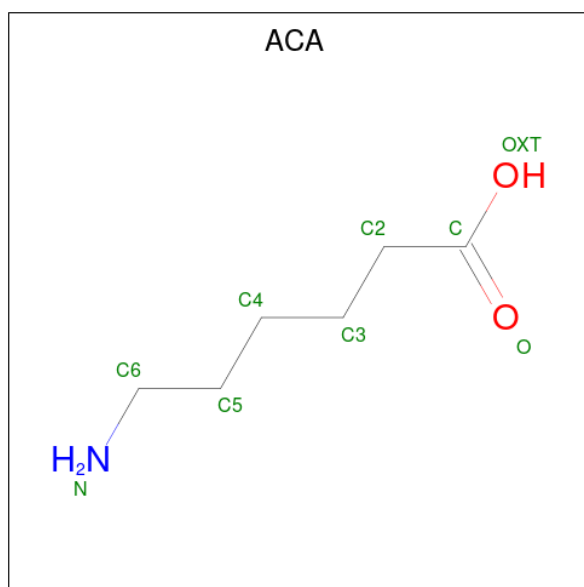

Mol	Chain	Residues	Atoms				ZeroOcc	AltConf
6	B	1	Total	C	N	O	0	0
			9	6	1	2		

- Molecule 7 is water.

Mol	Chain	Residues	Atoms		ZeroOcc	AltConf
7	J	73	Total	O	0	0
			73	73		
7	F	111	Total	O	0	0
			111	111		
7	A	114	Total	O	0	0
			114	114		
7	B	139	Total	O	0	0
			139	139		
7	K	4	Total	O	0	0
			4	4		
7	D	10	Total	O	0	0
			10	10		
7	G	3	Total	O	0	0
			3	3		
7	C	10	Total	O	0	0
			10	10		
7	H	37	Total	O	0	0
			37	37		
7	M	9	Total	O	0	0
			9	9		
7	L	25	Total	O	0	0
			25	25		

Continued on next page...

Continued from previous page...

Mol	Chain	Residues	Atoms		ZeroOcc	AltConf
7	I	35	Total	O	0	0
			35	35		

3 Residue-property plots [i](#)

These plots are drawn for all protein, RNA, DNA and oligosaccharide chains in the entry. The first graphic for a chain summarises the proportions of the various outlier classes displayed in the second graphic. The second graphic shows the sequence view annotated by issues in geometry and electron density. Residues are color-coded according to the number of geometric quality criteria for which they contain at least one outlier: green = 0, yellow = 1, orange = 2 and red = 3 or more. A red dot above a residue indicates a poor fit to the electron density ($RSRZ > 2$). Stretches of 2 or more consecutive residues without any outlier are shown as a green connector. Residues present in the sample, but not in the model, are shown in grey.

- Molecule 1: HIV-1 YU2 gp120 envelope glycoprotein

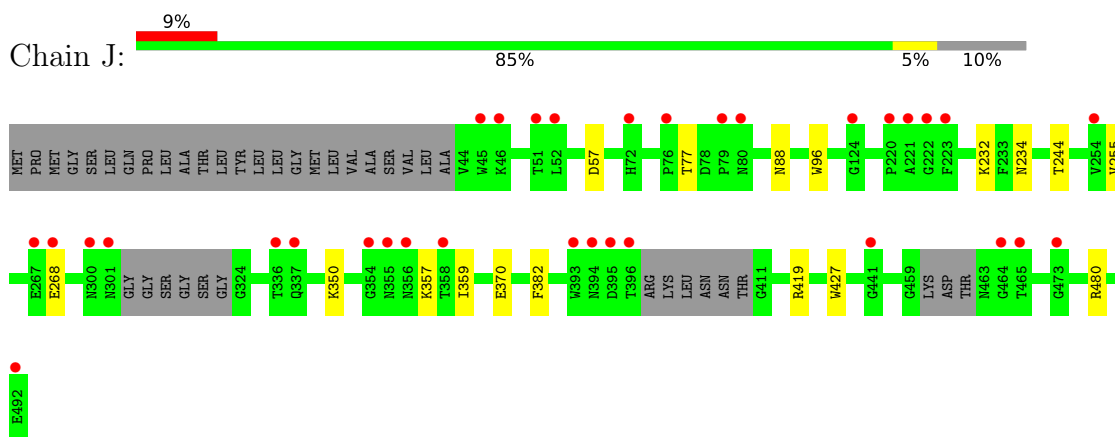

- Molecule 1: HIV-1 YU2 gp120 envelope glycoprotein

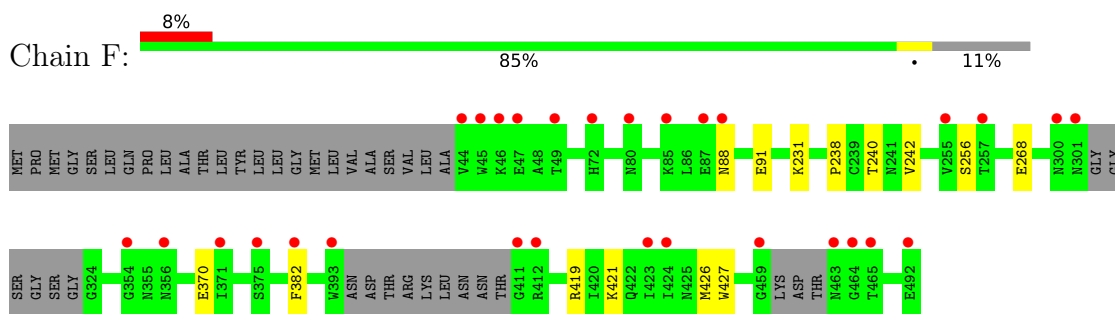

- Molecule 1: HIV-1 YU2 gp120 envelope glycoprotein

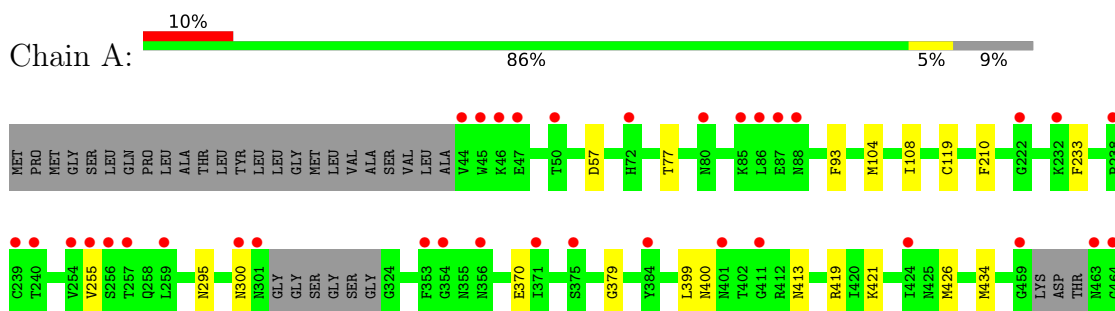



- Molecule 1: HIV-1 YU2 gp120 envelope glycoprotein

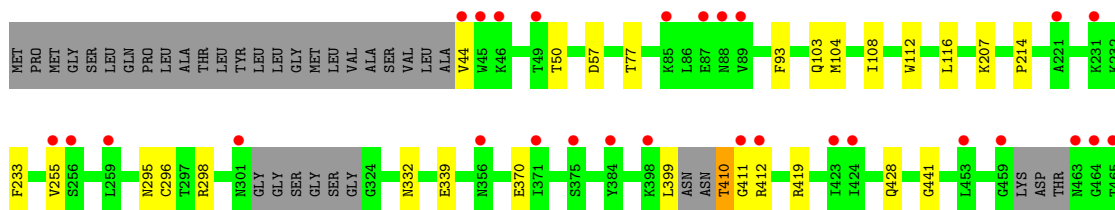
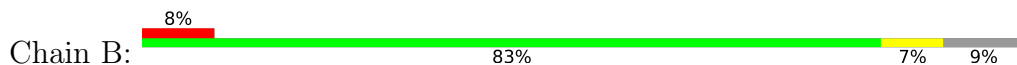

- Molecule 2: CD4-mimetic miniprotein M48U1

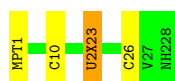
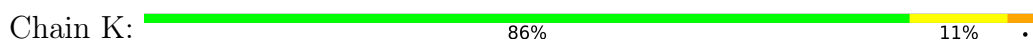

- Molecule 2: CD4-mimetic miniprotein M48U1

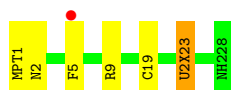
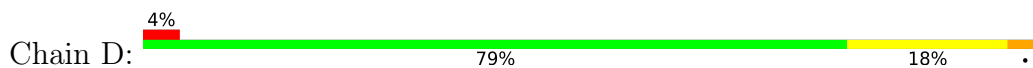

- Molecule 2: CD4-mimetic miniprotein M48U1

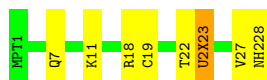

- Molecule 2: CD4-mimetic miniprotein M48U1

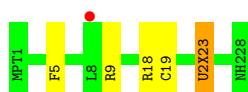
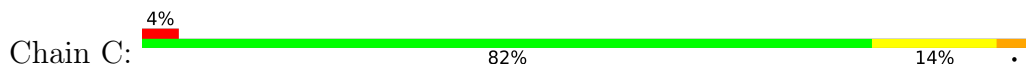

- Molecule 3: Llama single domain antibody, JM4

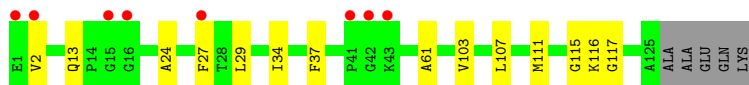
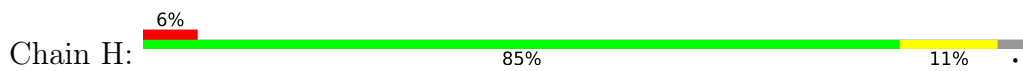

- Molecule 3: Llama single domain antibody, JM4

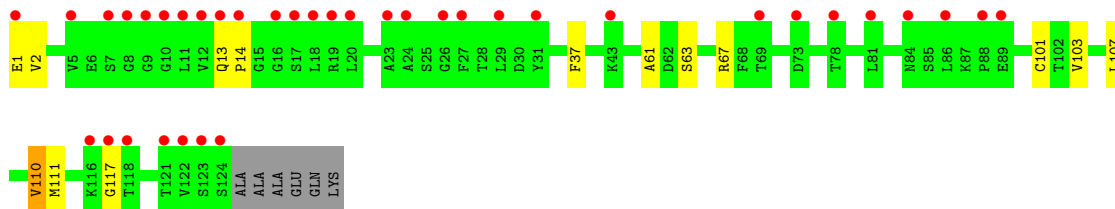
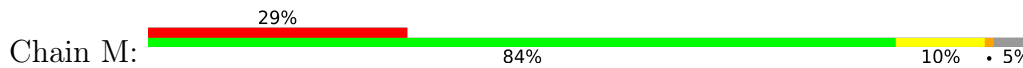

- Molecule 3: Llama single domain antibody, JM4

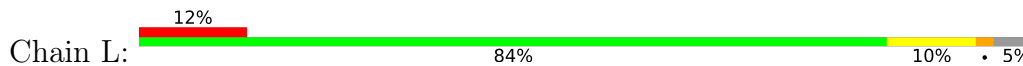

- Molecule 3: Llama single domain antibody, JM4

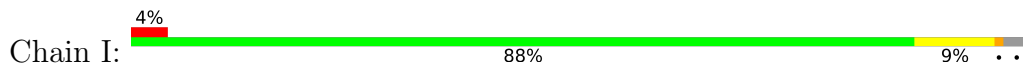

4 Data and refinement statistics

Property	Value	Source
Space group	P 1 21 1	Depositor
Cell constants a, b, c, α , β , γ	96.77Å 86.22Å 144.85Å 90.00° 102.88° 90.00°	Depositor
Resolution (Å)	38.80 – 2.14 38.80 – 2.13	Depositor EDS
% Data completeness (in resolution range)	76.7 (38.80-2.14) 71.7 (38.80-2.13)	Depositor EDS
R_{merge}	(Not available)	Depositor
R_{sym}	0.11	Depositor
$\langle I/\sigma(I) \rangle$ ¹	1.84 (at 2.14Å)	Xtrriage
Refinement program	PHENIX (phenix.refine: 1.8.2_1309)	Depositor
R, R_{free}	0.185 , 0.227 0.192 , 0.231	Depositor DCC
R_{free} test set	4979 reflections (5.03%)	wwPDB-VP
Wilson B-factor (Å ²)	29.5	Xtrriage
Anisotropy	0.350	Xtrriage
Bulk solvent k_{sol} (e/Å ³), B_{sol} (Å ²)	0.33 , 43.8	EDS
L-test for twinning ²	$\langle L \rangle = 0.49$, $\langle L^2 \rangle = 0.32$	Xtrriage
Estimated twinning fraction	No twinning to report.	Xtrriage
F_o, F_c correlation	0.95	EDS
Total number of atoms	16384	wwPDB-VP
Average B, all atoms (Å ²)	60.0	wwPDB-VP

Xtrriage's analysis on translational NCS is as follows: *The largest off-origin peak in the Patterson function is 8.68% of the height of the origin peak. No significant pseudotranslation is detected.*

¹Intensities estimated from amplitudes.

²Theoretical values of $\langle |L| \rangle$, $\langle L^2 \rangle$ for acentric reflections are 0.5, 0.333 respectively for untwinned datasets, and 0.375, 0.2 for perfectly twinned datasets.

5 Model quality [i](#)

5.1 Standard geometry [i](#)

Bond lengths and bond angles in the following residue types are not validated in this section: DPR, U2X, MPT, NAG, NH2, EDO, ACA

The Z score for a bond length (or angle) is the number of standard deviations the observed value is removed from the expected value. A bond length (or angle) with $|Z| > 5$ is considered an outlier worth inspection. RMSZ is the root-mean-square of all Z scores of the bond lengths (or angles).

Mol	Chain	Bond lengths		Bond angles	
		RMSZ	# Z >5	RMSZ	# Z >5
1	A	0.28	0/2783	0.50	0/3775
1	B	0.28	0/2754	0.49	0/3734
1	F	0.27	0/2706	0.47	0/3670
1	J	0.28	0/2746	0.49	0/3724
2	C	0.53	1/176 (0.6%)	0.71	1/231 (0.4%)
2	D	0.55	1/176 (0.6%)	0.59	0/231
2	G	0.52	1/176 (0.6%)	0.46	0/231
2	K	0.35	0/184	0.58	0/242
3	H	0.30	0/962	0.56	0/1304
3	I	0.28	0/967	0.53	0/1311
3	L	0.30	0/957	0.56	0/1297
3	M	0.27	0/957	0.51	0/1297
All	All	0.29	3/15544 (0.0%)	0.51	1/21047 (0.0%)

Chiral center outliers are detected by calculating the chiral volume of a chiral center and verifying if the center is modelled as a planar moiety or with the opposite hand. A planarity outlier is detected by checking planarity of atoms in a peptide group, atoms in a mainchain group or atoms of a sidechain that are expected to be planar.

Mol	Chain	#Chirality outliers	#Planarity outliers
2	D	0	1
2	K	0	2
3	H	0	1
3	I	0	1
3	L	0	1
3	M	0	1
All	All	0	7

All (3) bond length outliers are listed below:

Mol	Chain	Res	Type	Atoms	Z	Observed(Å)	Ideal(Å)
2	D	19	CYS	C-N	6.18	1.48	1.34
2	G	19	CYS	C-N	5.92	1.47	1.34
2	C	19	CYS	C-N	5.88	1.47	1.34

All (1) bond angle outliers are listed below:

Mol	Chain	Res	Type	Atoms	Z	Observed(°)	Ideal(°)
2	C	19	CYS	C-N-CA	5.82	136.24	121.70

There are no chirality outliers.

All (7) planarity outliers are listed below:

Mol	Chain	Res	Type	Group
2	D	1	MPT	Mainchain
3	H	117	GLY	Peptide
3	I	117	GLY	Peptide
2	K	1	MPT	Peptide
3	L	117	GLY	Peptide
3	M	117	GLY	Peptide

5.2 Too-close contacts [i](#)

In the following table, the Non-H and H(model) columns list the number of non-hydrogen atoms and hydrogen atoms in the chain respectively. The H(added) column lists the number of hydrogen atoms added and optimized by MolProbity. The Clashes column lists the number of clashes within the asymmetric unit, whereas Symm-Clashes lists symmetry-related clashes.

Mol	Chain	Non-H	H(model)	H(added)	Clashes	Symm-Clashes
1	A	2702	0	2627	17	0
1	B	2680	0	2605	22	0
1	F	2633	0	2557	14	0
1	J	2660	0	2584	13	0
2	C	209	0	212	5	0
2	D	209	0	212	3	0
2	G	209	0	212	10	0
2	K	214	0	220	7	0
3	H	944	0	901	8	0
3	I	949	0	906	10	0
3	L	939	0	896	9	0
3	M	939	0	896	8	0
4	A	126	0	117	2	0
4	B	112	0	104	2	0

Continued on next page...

Continued from previous page...

Mol	Chain	Non-H	H(model)	H(added)	Clashes	Symm-Clashes
4	F	126	0	117	3	0
4	J	126	0	117	4	0
5	A	12	0	18	4	0
5	B	12	0	18	3	0
5	J	4	0	6	1	0
6	B	9	0	6	1	0
7	A	114	0	0	0	0
7	B	139	0	0	2	0
7	C	10	0	0	1	0
7	D	10	0	0	0	0
7	F	111	0	0	1	0
7	G	3	0	0	0	0
7	H	37	0	0	0	0
7	I	35	0	0	3	0
7	J	73	0	0	0	0
7	K	4	0	0	0	0
7	L	25	0	0	0	0
7	M	9	0	0	0	0
All	All	16384	0	15331	109	0

The all-atom clashscore is defined as the number of clashes found per 1000 atoms (including hydrogen atoms). The all-atom clashscore for this structure is 4.

All (109) close contacts within the same asymmetric unit are listed below, sorted by their clash magnitude.

Atom-1	Atom-2	Interatomic distance (Å)	Clash overlap (Å)
2:K:10:CYS:CB	2:K:26:CYS:SG	2.24	1.25
2:K:10:CYS:SG	2:K:26:CYS:SG	1.05	0.96
2:K:10:CYS:SG	2:K:26:CYS:CB	2.63	0.86
1:B:296:CYS:SG	7:B:717:HOH:O	2.33	0.85
1:J:370:GLU:HG2	2:K:23:U2X:H71	1.59	0.85
1:F:370:GLU:HG2	2:G:23:U2X:H71	1.62	0.82
1:B:480:ARG:NH2	7:B:651:HOH:O	2.19	0.76
1:B:370:GLU:HG2	2:C:23:U2X:H71	1.69	0.74
1:A:295:ASN:ND2	4:A:502:NAG:O7	2.21	0.73
1:F:382:PHE:HD1	2:G:23:U2X:H11	1.56	0.70
4:F:509:NAG:O5	1:A:400:ASN:ND2	2.26	0.69
1:B:295:ASN:HD22	4:B:502:NAG:H81	1.57	0.69
1:A:370:GLU:HG2	2:D:23:U2X:H71	1.77	0.67
3:I:24:ALA:O	7:I:232:HOH:O	2.13	0.66
1:J:350:LYS:NZ	1:J:357:LYS:O	2.24	0.66

Continued on next page...

Continued from previous page...

Atom-1	Atom-2	Interatomic distance (Å)	Clash overlap (Å)
3:I:115:GLY:O	7:I:225:HOH:O	2.14	0.64
1:B:57:ASP:OD1	1:B:77:THR:OG1	2.11	0.63
1:A:210:PHE:H	5:A:512:EDO:H11	1.66	0.60
4:J:503:NAG:H83	4:J:503:NAG:H3	1.83	0.59
2:G:7:GLN:O	2:G:11:LYS:HB2	2.03	0.59
1:F:231:LYS:HD3	1:F:268:GLU:HG3	1.86	0.58
2:D:5:PHE:CE2	2:D:9:ARG:HD2	2.38	0.58
3:L:55:ASP:OD2	3:L:57:ARG:NH2	2.37	0.57
2:G:18:ARG:CZ	2:G:27:VAL:HG21	2.35	0.57
2:C:18:ARG:NH2	7:C:609:HOH:O	2.38	0.56
1:F:240:THR:O	7:F:663:HOH:O	2.18	0.55
2:G:27:VAL:CG1	2:G:28:NH2:N	2.70	0.55
2:G:27:VAL:HG12	2:G:28:NH2:N	2.21	0.55
3:I:23:ALA:HA	3:I:24:ALA:HB2	1.89	0.54
2:K:10:CYS:CA	2:K:26:CYS:SG	2.94	0.53
1:J:234:ASN:HD22	4:J:502:NAG:H83	1.74	0.53
3:M:63:SER:O	3:M:67:ARG:NH2	2.40	0.53
1:B:428:GLN:OE1	5:B:509:EDO:O1	2.24	0.53
1:F:421:LYS:HD3	3:M:110:VAL:HG13	1.91	0.53
3:I:77:ASN:ND2	7:I:232:HOH:O	2.35	0.53
1:B:214:PRO:HG2	6:B:512:ACA:H52	1.92	0.52
3:I:23:ALA:CA	3:I:24:ALA:HB2	2.39	0.52
1:J:382:PHE:HD1	2:K:23:U2X:H11	1.74	0.52
1:A:104:MET:HE2	1:A:108:ILE:HD11	1.93	0.51
1:A:421:LYS:HD3	3:L:110:VAL:HG13	1.91	0.51
1:B:339:GLU:HB3	1:B:399:LEU:HD22	1.94	0.50
1:J:88:ASN:HD21	4:J:505:NAG:C2	2.24	0.50
3:H:61:ALA:N	3:H:103:VAL:HG21	2.27	0.50
1:A:419:ARG:HG2	3:L:107:LEU:HD13	1.94	0.50
1:F:427:TRP:HA	2:G:22:THR:OG1	2.11	0.49
1:B:255:VAL:HG12	2:C:23:U2X:H61	1.94	0.49
1:F:382:PHE:CD1	2:G:23:U2X:H11	2.42	0.49
1:A:379:GLY:CA	5:A:512:EDO:H12	2.43	0.49
3:M:61:ALA:N	3:M:103:VAL:HG21	2.28	0.49
1:J:419:ARG:HG2	3:H:107:LEU:HD13	1.94	0.48
3:M:37:PHE:HD1	3:M:111:MET:HE2	1.78	0.48
1:J:382:PHE:CD1	2:K:23:U2X:H11	2.49	0.48
1:A:379:GLY:HA2	5:A:512:EDO:H12	1.95	0.48
1:A:426:MET:HA	5:A:510:EDO:H22	1.95	0.48
3:I:37:PHE:HD2	3:I:111:MET:HE1	1.79	0.48
1:F:240:THR:OG1	4:F:509:NAG:H81	2.13	0.48

Continued on next page...

Continued from previous page...

Atom-1	Atom-2	Interatomic distance (Å)	Clash overlap (Å)
1:B:419:ARG:HG2	3:I:107:LEU:HD13	1.95	0.48
1:B:116:LEU:HD22	5:B:510:EDO:O1	2.13	0.47
3:L:37:PHE:HD2	3:L:111:MET:HE1	1.79	0.47
3:L:37:PHE:HA	3:L:48:VAL:HG13	1.97	0.47
1:B:332:ASN:HD22	4:B:502:NAG:H2	1.80	0.47
4:F:509:NAG:H83	1:A:399:LEU:HD12	1.97	0.47
1:B:410:THR:CB	1:B:411:GLY:HA3	2.44	0.47
2:C:5:PHE:CE2	2:C:9:ARG:HD2	2.50	0.47
1:F:419:ARG:HG2	3:M:107:LEU:HD13	1.95	0.47
1:A:57:ASP:OD1	1:A:77:THR:OG1	2.22	0.46
3:H:37:PHE:HD2	3:H:111:MET:HE1	1.79	0.46
3:L:48:VAL:HG22	3:L:49:SER:N	2.31	0.46
4:J:503:NAG:H82	4:J:503:NAG:C1	2.46	0.46
3:I:23:ALA:HB1	3:I:24:ALA:HB2	1.97	0.46
3:H:29:LEU:HD22	3:H:34:ILE:HG13	1.98	0.46
1:J:350:LYS:HG3	1:J:359:ILE:CG1	2.46	0.46
3:I:11:LEU:HG	3:I:126:ALA:HB2	1.97	0.46
3:H:2:VAL:HG11	3:H:27:PHE:CZ	2.51	0.45
3:L:61:ALA:N	3:L:103:VAL:HG21	2.31	0.45
3:H:115:GLY:O	3:H:116:LYS:HG2	2.17	0.45
1:J:57:ASP:OD1	1:J:77:THR:OG1	2.26	0.45
1:J:96:TRP:CE3	1:J:480:ARG:HD3	2.51	0.45
1:A:255:VAL:HG12	2:D:23:U2X:H61	1.99	0.45
1:J:255:VAL:HG11	1:J:427:TRP:CD1	2.52	0.45
1:J:427:TRP:CD1	5:J:510:EDO:O2	2.72	0.43
1:F:238:PRO:HB2	1:A:399:LEU:HD13	2.01	0.43
3:H:24:ALA:HB3	3:H:29:LEU:HD21	2.00	0.43
3:M:101:CYS:HA	3:M:111:MET:HE3	2.00	0.43
3:L:29:LEU:HD22	3:L:34:ILE:HG13	2.00	0.43
1:F:231:LYS:HD3	1:F:268:GLU:CG	2.48	0.42
1:B:93:PHE:HB2	1:B:233:PHE:HZ	1.83	0.42
1:B:410:THR:HB	1:B:411:GLY:HA3	2.00	0.42
3:M:13:GLN:HG3	3:M:14:PRO:HD2	2.02	0.42
1:F:256:SER:HA	2:G:23:U2X:H52	2.02	0.42
3:L:24:ALA:O	3:L:77:ASN:ND2	2.53	0.42
1:J:232:LYS:HE3	1:J:268:GLU:HB2	2.02	0.41
1:F:91:GLU:HB3	1:F:242:VAL:HG21	2.03	0.41
1:A:93:PHE:HB2	1:A:233:PHE:HZ	1.86	0.41
1:A:119:CYS:N	1:A:434:MET:O	2.54	0.41
4:A:502:NAG:C1	4:A:502:NAG:H83	2.50	0.41
1:B:50:THR:O	1:B:103:GLN:NE2	2.50	0.41

Continued on next page...

Continued from previous page...

Atom-1	Atom-2	Interatomic distance (Å)	Clash overlap (Å)
1:A:300:ASN:O	1:A:300:ASN:ND2	2.47	0.41
1:B:44:VAL:HA	1:B:492:GLU:H	1.86	0.41
1:B:207:LYS:HD3	5:B:510:EDO:H22	2.03	0.41
3:I:23:ALA:CB	3:I:24:ALA:HB2	2.51	0.41
3:H:37:PHE:CD2	3:H:111:MET:HE1	2.55	0.40
1:B:112:TRP:CE3	1:B:116:LEU:HD12	2.56	0.40
1:B:298:ARG:NH2	1:B:441:GLY:O	2.45	0.40
3:M:1:GLU:HG2	3:M:2:VAL:N	2.37	0.40
1:F:426:MET:O	2:G:22:THR:OG1	2.27	0.40
1:B:104:MET:CE	1:B:108:ILE:HD11	2.51	0.40
1:B:411:GLY:HA3	1:B:412:ARG:HA	1.79	0.40
2:C:23:U2X:H71	2:C:23:U2X:HE11	1.85	0.40

There are no symmetry-related clashes.

5.3 Torsion angles [i](#)

5.3.1 Protein backbone [i](#)

In the following table, the Percentiles column shows the percent Ramachandran outliers of the chain as a percentile score with respect to all X-ray entries followed by that with respect to entries of similar resolution.

The Analysed column shows the number of residues for which the backbone conformation was analysed, and the total number of residues.

Mol	Chain	Analysed	Favoured	Allowed	Outliers	Percentiles	
1	A	342/376 (91%)	326 (95%)	15 (4%)	1 (0%)	41	36
1	B	336/376 (89%)	323 (96%)	13 (4%)	0	100	100
1	F	330/376 (88%)	317 (96%)	12 (4%)	1 (0%)	41	36
1	J	336/376 (89%)	322 (96%)	14 (4%)	0	100	100
2	C	24/28 (86%)	24 (100%)	0	0	100	100
2	D	24/28 (86%)	24 (100%)	0	0	100	100
2	G	24/28 (86%)	24 (100%)	0	0	100	100
2	K	25/28 (89%)	23 (92%)	2 (8%)	0	100	100
3	H	122/129 (95%)	118 (97%)	4 (3%)	0	100	100
3	I	123/129 (95%)	118 (96%)	4 (3%)	1 (1%)	19	11

Continued on next page...

Continued from previous page...

Mol	Chain	Analysed	Favoured	Allowed	Outliers	Percentiles	
3	L	121/129 (94%)	116 (96%)	4 (3%)	1 (1%)	19	11
3	M	121/129 (94%)	117 (97%)	4 (3%)	0	100	100
All	All	1928/2132 (90%)	1852 (96%)	72 (4%)	4 (0%)	47	45

All (4) Ramachandran outliers are listed below:

Mol	Chain	Res	Type
1	F	88	ASN
1	A	413	ASN
3	I	24	ALA
3	L	29	LEU

5.3.2 Protein sidechains [i](#)

In the following table, the Percentiles column shows the percent sidechain outliers of the chain as a percentile score with respect to all X-ray entries followed by that with respect to entries of similar resolution.

The Analysed column shows the number of residues for which the sidechain conformation was analysed, and the total number of residues.

Mol	Chain	Analysed	Rotameric	Outliers	Percentiles	
1	A	307/328 (94%)	307 (100%)	0	100	100
1	B	303/328 (92%)	302 (100%)	1 (0%)	92	94
1	F	297/328 (90%)	297 (100%)	0	100	100
1	J	302/328 (92%)	301 (100%)	1 (0%)	92	94
2	C	20/20 (100%)	20 (100%)	0	100	100
2	D	20/20 (100%)	19 (95%)	1 (5%)	24	20
2	G	20/20 (100%)	20 (100%)	0	100	100
2	K	21/20 (105%)	21 (100%)	0	100	100
3	H	103/106 (97%)	102 (99%)	1 (1%)	76	79
3	I	103/106 (97%)	101 (98%)	2 (2%)	57	59
3	L	103/106 (97%)	102 (99%)	1 (1%)	76	79
3	M	103/106 (97%)	102 (99%)	1 (1%)	76	79
All	All	1702/1816 (94%)	1694 (100%)	8 (0%)	88	91

All (8) residues with a non-rotameric sidechain are listed below:

Mol	Chain	Res	Type
1	J	244	THR
1	B	410	THR
2	D	2	ASN
3	H	13	GLN
3	M	110	VAL
3	L	110	VAL
3	I	48	VAL
3	I	124	SER

Sometimes sidechains can be flipped to improve hydrogen bonding and reduce clashes. All (1) such sidechains are listed below:

Mol	Chain	Res	Type
2	C	2	ASN

5.3.3 RNA [i](#)

There are no RNA molecules in this entry.

5.4 Non-standard residues in protein, DNA, RNA chains [i](#)

8 non-standard protein/DNA/RNA residues are modelled in this entry.

In the following table, the Counts columns list the number of bonds (or angles) for which Mogul statistics could be retrieved, the number of bonds (or angles) that are observed in the model and the number of bonds (or angles) that are defined in the Chemical Component Dictionary. The Link column lists molecule types, if any, to which the group is linked. The Z score for a bond length (or angle) is the number of standard deviations the observed value is removed from the expected value. A bond length (or angle) with $|Z| > 2$ is considered an outlier worth inspection. RMSZ is the root-mean-square of all Z scores of the bond lengths (or angles).

Mol	Type	Chain	Res	Link	Bond lengths			Bond angles		
					Counts	RMSZ	# Z > 2	Counts	RMSZ	# Z > 2
2	U2X	C	23	2	19,20,21	2.35	5 (26%)	22,25,27	1.63	4 (18%)
2	U2X	G	23	2	19,20,21	2.38	4 (21%)	22,25,27	1.64	5 (22%)
2	U2X	K	23	2	19,20,21	2.41	4 (21%)	22,25,27	1.52	5 (22%)
2	U2X	D	23	2	19,20,21	2.32	4 (21%)	22,25,27	1.59	5 (22%)

In the following table, the Chirals column lists the number of chiral outliers, the number of chiral centers analysed, the number of these observed in the model and the number defined in the Chemical Component Dictionary. Similar counts are reported in the Torsion and Rings columns. '-' means no outliers of that kind were identified.

Mol	Type	Chain	Res	Link	Chirals	Torsions	Rings
2	U2X	C	23	2	-	3/10/19/21	0/2/2/2
2	U2X	G	23	2	-	3/10/19/21	0/2/2/2
2	U2X	K	23	2	-	5/10/19/21	0/2/2/2
2	U2X	D	23	2	-	3/10/19/21	0/2/2/2

All (17) bond length outliers are listed below:

Mol	Chain	Res	Type	Atoms	Z	Observed(Å)	Ideal(Å)
2	K	23	U2X	CE2-CD2	7.62	1.52	1.38
2	G	23	U2X	CE2-CD2	7.48	1.52	1.38
2	C	23	U2X	CE2-CD2	7.38	1.52	1.38
2	D	23	U2X	CE2-CD2	7.26	1.52	1.38
2	K	23	U2X	CE1-CD1	4.60	1.47	1.38
2	G	23	U2X	CE1-CD1	4.57	1.47	1.38
2	D	23	U2X	CE1-CD1	4.38	1.46	1.38
2	C	23	U2X	CE1-CD1	4.37	1.46	1.38
2	K	23	U2X	CE1-CZ	2.91	1.44	1.38
2	G	23	U2X	CE1-CZ	2.84	1.44	1.38
2	C	23	U2X	CE1-CZ	2.81	1.44	1.38
2	D	23	U2X	CE1-CZ	2.79	1.44	1.38
2	K	23	U2X	C4-C3	2.39	1.59	1.52
2	G	23	U2X	C4-C3	2.35	1.59	1.52
2	D	23	U2X	C4-C3	2.35	1.59	1.52
2	C	23	U2X	C4-C3	2.33	1.59	1.52
2	C	23	U2X	CB-CA	-2.03	1.49	1.53

All (19) bond angle outliers are listed below:

Mol	Chain	Res	Type	Atoms	Z	Observed(°)	Ideal(°)
2	G	23	U2X	OH-C7-C3	3.50	117.35	108.21
2	K	23	U2X	OH-C7-C3	3.40	117.09	108.21
2	C	23	U2X	OH-C7-C3	3.38	117.04	108.21
2	D	23	U2X	C2-C3-C7	3.23	119.39	111.28
2	G	23	U2X	C2-C3-C7	3.22	119.37	111.28
2	K	23	U2X	C2-C3-C7	3.09	119.04	111.28
2	G	23	U2X	CG-CB-CA	3.06	120.30	114.10
2	C	23	U2X	C2-C3-C7	3.02	118.87	111.28
2	D	23	U2X	OH-C7-C3	2.89	115.75	108.21
2	D	23	U2X	C4-C3-C7	2.77	118.24	111.28
2	C	23	U2X	C4-C3-C7	2.76	118.21	111.28
2	C	23	U2X	CG-CB-CA	2.73	119.62	114.10
2	G	23	U2X	C4-C3-C7	2.67	117.99	111.28

Continued on next page...

Continued from previous page...

Mol	Chain	Res	Type	Atoms	Z	Observed(°)	Ideal(°)
2	K	23	U2X	C4-C3-C7	2.54	117.66	111.28
2	G	23	U2X	C1-C2-C3	-2.48	107.47	112.15
2	D	23	U2X	C1-C2-C3	-2.44	107.55	112.15
2	K	23	U2X	CG-CB-CA	2.38	118.92	114.10
2	D	23	U2X	CG-CB-CA	2.36	118.88	114.10
2	K	23	U2X	C1-C2-C3	-2.24	107.92	112.15

There are no chirality outliers.

All (14) torsion outliers are listed below:

Mol	Chain	Res	Type	Atoms
2	K	23	U2X	C2-C3-C7-OH
2	D	23	U2X	C2-C3-C7-OH
2	G	23	U2X	C2-C3-C7-OH
2	G	23	U2X	C4-C3-C7-OH
2	C	23	U2X	C2-C3-C7-OH
2	K	23	U2X	C4-C3-C7-OH
2	K	23	U2X	C3-C7-OH-CZ
2	D	23	U2X	C4-C3-C7-OH
2	C	23	U2X	C4-C3-C7-OH
2	G	23	U2X	C3-C7-OH-CZ
2	D	23	U2X	C3-C7-OH-CZ
2	K	23	U2X	CE2-CZ-OH-C7
2	K	23	U2X	CE1-CZ-OH-C7
2	C	23	U2X	C3-C7-OH-CZ

There are no ring outliers.

4 monomers are involved in 12 short contacts:

Mol	Chain	Res	Type	Clashes	Symm-Clashes
2	C	23	U2X	3	0
2	G	23	U2X	4	0
2	K	23	U2X	3	0
2	D	23	U2X	2	0

5.5 Carbohydrates [i](#)

There are no monosaccharides in this entry.

5.6 Ligand geometry

43 ligands are modelled in this entry.

In the following table, the Counts columns list the number of bonds (or angles) for which Mogul statistics could be retrieved, the number of bonds (or angles) that are observed in the model and the number of bonds (or angles) that are defined in the Chemical Component Dictionary. The Link column lists molecule types, if any, to which the group is linked. The Z score for a bond length (or angle) is the number of standard deviations the observed value is removed from the expected value. A bond length (or angle) with $|Z| > 2$ is considered an outlier worth inspection. RMSZ is the root-mean-square of all Z scores of the bond lengths (or angles).

Mol	Type	Chain	Res	Link	Bond lengths			Bond angles		
					Counts	RMSZ	# Z > 2	Counts	RMSZ	# Z > 2
4	NAG	A	505	1	14,14,15	0.19	0	17,19,21	0.46	0
4	NAG	B	506	1	14,14,15	0.55	0	17,19,21	0.39	0
4	NAG	B	502	-	14,14,15	0.34	0	17,19,21	0.62	0
4	NAG	B	505	1	14,14,15	0.30	0	17,19,21	0.43	0
4	NAG	J	507	1	14,14,15	0.30	0	17,19,21	0.40	0
4	NAG	A	506	1	14,14,15	0.39	0	17,19,21	0.47	0
4	NAG	F	502	1	14,14,15	0.29	0	17,19,21	0.60	0
4	NAG	J	508	1	14,14,15	0.30	0	17,19,21	0.39	0
4	NAG	B	507	1	14,14,15	0.48	0	17,19,21	0.41	0
5	EDO	A	510	-	3,3,3	0.42	0	2,2,2	0.28	0
4	NAG	F	504	1	14,14,15	0.28	0	17,19,21	0.65	0
4	NAG	F	501	1	14,14,15	0.25	0	17,19,21	0.54	0
4	NAG	B	508	1	14,14,15	0.41	0	17,19,21	0.71	0
4	NAG	J	501	1	14,14,15	0.38	0	17,19,21	0.45	0
5	EDO	J	510	-	3,3,3	0.46	0	2,2,2	0.33	0
4	NAG	F	509	-	14,14,15	0.95	1 (7%)	17,19,21	0.65	0
4	NAG	A	508	1	14,14,15	0.48	0	17,19,21	0.93	1 (5%)
5	EDO	A	512	-	3,3,3	0.39	0	2,2,2	0.21	0
6	ACA	B	512	-	8,8,8	0.69	0	8,8,8	0.95	0
5	EDO	A	511	-	3,3,3	0.32	0	2,2,2	0.53	0
4	NAG	J	504	1	14,14,15	0.19	0	17,19,21	0.53	0
4	NAG	F	506	1	14,14,15	0.48	0	17,19,21	0.74	1 (5%)
4	NAG	A	503	1	14,14,15	0.22	0	17,19,21	0.52	0
4	NAG	F	507	1	14,14,15	0.19	0	17,19,21	0.50	0
4	NAG	J	509	1	14,14,15	0.24	0	17,19,21	0.46	0
4	NAG	J	502	1	14,14,15	0.13	0	17,19,21	0.61	0
4	NAG	J	503	1	14,14,15	0.24	0	17,19,21	1.02	1 (5%)
5	EDO	B	511	-	3,3,3	0.46	0	2,2,2	0.33	0
4	NAG	A	504	1	14,14,15	0.26	0	17,19,21	0.63	0
4	NAG	F	508	1	14,14,15	0.16	0	17,19,21	0.44	0
4	NAG	F	505	1	14,14,15	0.34	0	17,19,21	0.45	0

Mol	Type	Chain	Res	Link	Bond lengths			Bond angles		
					Counts	RMSZ	# Z > 2	Counts	RMSZ	# Z > 2
4	NAG	B	504	1	14,14,15	0.20	0	17,19,21	0.58	0
4	NAG	J	505	-	14,14,15	0.25	0	17,19,21	0.34	0
4	NAG	B	503	1	14,14,15	0.36	0	17,19,21	0.52	0
4	NAG	A	509	1	14,14,15	0.26	0	17,19,21	0.36	0
4	NAG	F	503	1	14,14,15	0.33	0	17,19,21	0.50	0
5	EDO	B	510	-	3,3,3	0.46	0	2,2,2	0.33	0
5	EDO	B	509	-	3,3,3	0.46	0	2,2,2	0.33	0
4	NAG	A	501	1	14,14,15	0.14	0	17,19,21	0.56	0
4	NAG	J	506	1	14,14,15	0.24	0	17,19,21	0.41	0
4	NAG	B	501	1	14,14,15	0.18	0	17,19,21	0.65	0
4	NAG	A	502	-	14,14,15	0.30	0	17,19,21	0.55	0
4	NAG	A	507	1	14,14,15	0.29	0	17,19,21	0.41	0

In the following table, the Chirals column lists the number of chiral outliers, the number of chiral centers analysed, the number of these observed in the model and the number defined in the Chemical Component Dictionary. Similar counts are reported in the Torsion and Rings columns. '-' means no outliers of that kind were identified.

Mol	Type	Chain	Res	Link	Chirals	Torsions	Rings
4	NAG	A	505	1	-	0/6/23/26	0/1/1/1
4	NAG	B	506	1	-	0/6/23/26	0/1/1/1
4	NAG	B	502	-	-	2/6/23/26	0/1/1/1
4	NAG	B	505	1	-	1/6/23/26	0/1/1/1
4	NAG	J	507	1	-	1/6/23/26	0/1/1/1
4	NAG	A	506	1	-	1/6/23/26	0/1/1/1
4	NAG	F	502	1	-	2/6/23/26	0/1/1/1
4	NAG	J	508	1	-	2/6/23/26	0/1/1/1
4	NAG	B	507	1	-	0/6/23/26	0/1/1/1
5	EDO	A	510	-	-	1/1/1/1	-
4	NAG	F	504	1	-	0/6/23/26	0/1/1/1
4	NAG	F	501	1	-	2/6/23/26	0/1/1/1
4	NAG	B	508	1	-	2/6/23/26	0/1/1/1
4	NAG	J	501	1	-	2/6/23/26	0/1/1/1
5	EDO	J	510	-	-	0/1/1/1	-
4	NAG	F	509	-	-	0/6/23/26	0/1/1/1
4	NAG	A	508	1	-	4/6/23/26	0/1/1/1
5	EDO	A	512	-	-	1/1/1/1	-
6	ACA	B	512	-	-	0/6/6/6	-
5	EDO	A	511	-	-	1/1/1/1	-
4	NAG	J	504	1	-	0/6/23/26	0/1/1/1
4	NAG	F	506	1	-	0/6/23/26	0/1/1/1

Continued on next page...

Continued from previous page...

Mol	Type	Chain	Res	Link	Chirals	Torsions	Rings
4	NAG	A	503	1	-	3/6/23/26	0/1/1/1
4	NAG	F	507	1	-	0/6/23/26	0/1/1/1
4	NAG	J	509	1	-	2/6/23/26	0/1/1/1
4	NAG	J	502	1	-	2/6/23/26	0/1/1/1
4	NAG	J	503	1	-	5/6/23/26	0/1/1/1
5	EDO	B	511	-	-	0/1/1/1	-
4	NAG	A	504	1	-	0/6/23/26	0/1/1/1
4	NAG	F	508	1	-	2/6/23/26	0/1/1/1
4	NAG	F	505	1	-	0/6/23/26	0/1/1/1
4	NAG	B	504	1	-	0/6/23/26	0/1/1/1
4	NAG	J	505	-	-	2/6/23/26	0/1/1/1
4	NAG	B	503	1	-	2/6/23/26	0/1/1/1
4	NAG	A	509	1	-	2/6/23/26	0/1/1/1
4	NAG	F	503	1	-	1/6/23/26	0/1/1/1
5	EDO	B	510	-	-	0/1/1/1	-
5	EDO	B	509	-	-	0/1/1/1	-
4	NAG	A	501	1	-	2/6/23/26	0/1/1/1
4	NAG	J	506	1	-	2/6/23/26	0/1/1/1
4	NAG	B	501	1	-	2/6/23/26	0/1/1/1
4	NAG	A	502	-	-	3/6/23/26	0/1/1/1
4	NAG	A	507	1	-	0/6/23/26	0/1/1/1

All (1) bond length outliers are listed below:

Mol	Chain	Res	Type	Atoms	Z	Observed(Å)	Ideal(Å)
4	F	509	NAG	O5-C1	-3.03	1.38	1.43

All (3) bond angle outliers are listed below:

Mol	Chain	Res	Type	Atoms	Z	Observed(°)	Ideal(°)
4	A	508	NAG	C1-O5-C5	2.87	116.08	112.19
4	J	503	NAG	C2-N2-C7	2.83	126.94	122.90
4	F	506	NAG	C1-O5-C5	2.78	115.96	112.19

There are no chirality outliers.

All (52) torsion outliers are listed below:

Mol	Chain	Res	Type	Atoms
4	A	508	NAG	C4-C5-C6-O6
4	A	508	NAG	O5-C5-C6-O6
4	J	501	NAG	C4-C5-C6-O6
4	A	509	NAG	O5-C5-C6-O6
4	B	508	NAG	O5-C5-C6-O6
4	J	506	NAG	O5-C5-C6-O6
4	A	509	NAG	C4-C5-C6-O6
4	B	508	NAG	C4-C5-C6-O6
4	J	506	NAG	C4-C5-C6-O6
4	J	502	NAG	C8-C7-N2-C2
4	J	502	NAG	O7-C7-N2-C2
4	J	503	NAG	C8-C7-N2-C2
4	J	503	NAG	O7-C7-N2-C2
4	F	501	NAG	C8-C7-N2-C2
4	F	501	NAG	O7-C7-N2-C2
4	F	502	NAG	C8-C7-N2-C2
4	F	502	NAG	O7-C7-N2-C2
4	A	501	NAG	C8-C7-N2-C2
4	A	501	NAG	O7-C7-N2-C2
4	A	502	NAG	C8-C7-N2-C2
4	A	502	NAG	O7-C7-N2-C2
4	A	503	NAG	C8-C7-N2-C2
4	A	503	NAG	O7-C7-N2-C2
4	A	508	NAG	C8-C7-N2-C2
4	A	508	NAG	O7-C7-N2-C2
4	B	501	NAG	C8-C7-N2-C2
4	B	501	NAG	O7-C7-N2-C2
4	B	502	NAG	C8-C7-N2-C2
4	B	502	NAG	O7-C7-N2-C2
4	B	503	NAG	C8-C7-N2-C2
4	B	503	NAG	O7-C7-N2-C2
4	J	501	NAG	O5-C5-C6-O6
5	A	510	EDO	O1-C1-C2-O2
4	F	508	NAG	O5-C5-C6-O6
4	J	509	NAG	O5-C5-C6-O6
4	J	509	NAG	C4-C5-C6-O6
4	F	503	NAG	O5-C5-C6-O6
5	A	511	EDO	O1-C1-C2-O2
4	J	508	NAG	C4-C5-C6-O6
4	J	508	NAG	O5-C5-C6-O6
4	J	507	NAG	O5-C5-C6-O6
4	B	505	NAG	O5-C5-C6-O6
5	A	512	EDO	O1-C1-C2-O2

Continued on next page...

Continued from previous page...

Mol	Chain	Res	Type	Atoms
4	J	505	NAG	C4-C5-C6-O6
4	A	503	NAG	O5-C5-C6-O6
4	A	506	NAG	O5-C5-C6-O6
4	F	508	NAG	C4-C5-C6-O6
4	J	505	NAG	O5-C5-C6-O6
4	J	503	NAG	C1-C2-N2-C7
4	J	503	NAG	C4-C5-C6-O6
4	A	502	NAG	O5-C5-C6-O6
4	J	503	NAG	C3-C2-N2-C7

There are no ring outliers.

12 monomers are involved in 20 short contacts:

Mol	Chain	Res	Type	Clashes	Symm-Clashes
4	B	502	NAG	2	0
5	A	510	EDO	1	0
5	J	510	EDO	1	0
4	F	509	NAG	3	0
5	A	512	EDO	3	0
6	B	512	ACA	1	0
4	J	502	NAG	1	0
4	J	503	NAG	2	0
4	J	505	NAG	1	0
5	B	510	EDO	2	0
5	B	509	EDO	1	0
4	A	502	NAG	2	0

5.7 Other polymers [i](#)

There are no such residues in this entry.

5.8 Polymer linkage issues [i](#)

There are no chain breaks in this entry.

6 Fit of model and data [i](#)

6.1 Protein, DNA and RNA chains [i](#)

In the following table, the column labelled ‘#RSRZ > 2’ contains the number (and percentage) of RSRZ outliers, followed by percent RSRZ outliers for the chain as percentile scores relative to all X-ray entries and entries of similar resolution. The OWAB column contains the minimum, median, 95th percentile and maximum values of the occupancy-weighted average B-factor per residue. The column labelled ‘Q < 0.9’ lists the number of (and percentage) of residues with an average occupancy less than 0.9.

Mol	Chain	Analysed	<RSRZ>	#RSRZ>2	OWAB(Å ²)	Q<0.9
1	A	343/376 (91%)	0.70	38 (11%) 5 6	33, 50, 99, 160	0
1	B	341/376 (90%)	0.54	29 (8%) 10 14	29, 45, 88, 140	0
1	F	334/376 (88%)	0.56	29 (8%) 10 13	36, 53, 97, 135	0
1	J	337/376 (89%)	0.68	33 (9%) 7 10	36, 60, 102, 133	0
2	C	24/28 (85%)	0.40	1 (4%) 36 44	21, 49, 70, 72	0
2	D	24/28 (85%)	0.27	1 (4%) 36 44	21, 51, 70, 76	0
2	G	24/28 (85%)	0.43	0 100 100	21, 66, 81, 88	0
2	K	24/28 (85%)	0.32	0 100 100	21, 60, 79, 86	0
3	H	124/129 (96%)	0.39	8 (6%) 18 23	35, 53, 83, 131	0
3	I	125/129 (96%)	0.51	5 (4%) 38 46	34, 54, 83, 117	0
3	L	123/129 (95%)	0.66	15 (12%) 4 5	38, 63, 87, 113	0
3	M	123/129 (95%)	1.54	37 (30%) 0 0	47, 92, 134, 156	0
All	All	1946/2132 (91%)	0.65	196 (10%) 7 9	21, 55, 103, 160	0

All (196) RSRZ outliers are listed below:

Mol	Chain	Res	Type	RSRZ
1	B	44	VAL	15.4
3	M	123	SER	8.3
1	B	45	TRP	7.8
3	M	124	SER	7.2
1	A	44	VAL	7.2
1	A	45	TRP	7.2
1	A	492	GLU	7.0
1	F	44	VAL	6.8
1	A	301	ASN	6.8
3	M	18	LEU	6.4
1	F	492	GLU	6.2

Continued on next page...

Continued from previous page...

Mol	Chain	Res	Type	RSRZ
1	B	46	LYS	6.0
1	A	87	GLU	5.7
3	M	10	GLY	5.7
3	M	12	VAL	5.6
3	M	88	PRO	5.4
1	A	491[A]	ILE	5.4
3	M	1	GLU	5.3
1	J	221	ALA	5.3
1	J	355	ASN	5.2
1	B	87	GLU	5.1
3	M	121	THR	4.8
1	J	356	ASN	4.8
3	M	11	LEU	4.7
1	J	46	LYS	4.7
1	A	463	ASN	4.7
3	M	13	GLN	4.6
3	I	125	ALA	4.6
3	M	122	VAL	4.5
1	A	88	ASN	4.5
1	B	492	GLU	4.5
3	H	27	PHE	4.5
3	M	17	SER	4.3
1	F	301	ASN	4.3
1	F	464	GLY	4.2
1	A	401	ASN	4.2
1	J	45	TRP	4.2
1	J	492	GLU	4.1
3	M	69	THR	4.1
3	M	27	PHE	4.1
1	F	87	GLU	4.0
3	M	9	GLY	4.0
1	J	358[A]	THR	4.0
3	M	20	LEU	4.0
1	B	88	ASN	3.9
1	A	356	ASN	3.9
3	M	7	SER	3.8
1	J	222	GLY	3.8
1	J	354	GLY	3.7
1	F	371	ILE	3.7
1	F	412	ARG	3.7
1	J	80	ASN	3.7
1	F	88	ASN	3.6

Continued on next page...

Continued from previous page...

Mol	Chain	Res	Type	RSRZ
3	M	86	LEU	3.6
3	L	41	PRO	3.6
3	H	43	LYS	3.6
1	J	79	PRO	3.6
1	F	356	ASN	3.5
1	B	411	GLY	3.5
3	M	8	GLY	3.5
1	J	301	ASN	3.5
3	M	89	GLU	3.4
1	A	464	GLY	3.4
1	F	46	LYS	3.4
1	F	72	HIS	3.4
1	F	463	ASN	3.4
1	J	76	PRO	3.3
1	A	255	VAL	3.3
1	J	395	ASP	3.3
1	J	465	THR	3.3
3	I	27	PHE	3.3
1	B	459	GLY	3.2
3	M	16	GLY	3.2
3	L	116	LYS	3.1
1	F	45	TRP	3.1
3	I	1	GLU	3.1
1	J	124	GLY	3.1
3	H	42	GLY	3.1
1	F	459	GLY	3.0
1	J	394	ASN	3.0
3	M	24	ALA	3.0
3	M	19	ARG	3.0
3	L	42	GLY	2.9
1	J	268	GLU	2.9
3	L	87	LYS	2.9
1	A	411	GLY	2.9
1	B	398	LYS	2.9
1	F	80	ASN	2.9
3	L	40	ALA	2.9
1	B	412	ARG	2.8
3	M	14	PRO	2.8
1	A	459	GLY	2.8
1	J	396	THR	2.8
1	A	257	THR	2.8
1	A	371	ILE	2.8

Continued on next page...

Continued from previous page...

Mol	Chain	Res	Type	RSRZ
1	A	46	LYS	2.8
3	H	2	VAL	2.8
1	J	336	THR	2.8
1	J	300	ASN	2.8
1	B	259	LEU	2.8
3	L	5	VAL	2.7
1	J	223	PHE	2.7
3	H	15	GLY	2.7
1	F	85	LYS	2.7
3	M	84	ASN	2.7
3	I	115	GLY	2.7
3	M	117	GLY	2.7
1	J	220	PRO	2.7
3	M	26	GLY	2.6
3	M	116	LYS	2.6
1	A	424	ILE	2.6
3	H	41	PRO	2.6
1	J	72	HIS	2.5
1	B	465	THR	2.5
1	A	375	SER	2.5
1	B	424	ILE	2.5
1	A	256	SER	2.5
3	I	126	ALA	2.5
3	L	1	GLU	2.5
1	A	232	LYS	2.5
1	B	85	LYS	2.5
3	M	5	VAL	2.5
1	B	356	ASN	2.5
1	B	463	ASN	2.5
1	J	267	GLU	2.4
3	L	9	GLY	2.4
3	L	117	GLY	2.4
3	M	23	ALA	2.4
2	D	5	PHE	2.4
1	J	52	LEU	2.4
1	F	424	ILE	2.4
3	L	13	GLN	2.4
1	J	254	VAL	2.4
1	F	300	ASN	2.4
1	J	51	THR	2.4
1	B	453	LEU	2.4
3	L	29	LEU	2.4

Continued on next page...

Continued from previous page...

Mol	Chain	Res	Type	RSRZ
1	B	255	VAL	2.4
1	A	354	GLY	2.4
3	M	43	LYS	2.4
1	F	382	PHE	2.4
1	A	86	LEU	2.4
1	A	240	THR	2.4
1	A	239	CYS	2.3
1	A	85	LYS	2.3
1	F	375	SER	2.3
3	M	78	THR	2.3
1	B	371	ILE	2.3
1	J	393	TRP	2.3
2	C	8	LEU	2.3
1	F	255	VAL	2.3
1	J	464	GLY	2.3
1	F	465	THR	2.3
1	A	353	PHE	2.3
1	J	473	GLY	2.3
1	B	301	ASN	2.3
1	A	259	LEU	2.3
1	A	47	GLU	2.3
1	F	393	TRP	2.2
1	A	490[A]	LYS	2.2
1	A	80	ASN	2.2
3	L	7	SER	2.2
1	F	47	GLU	2.2
1	B	221	ALA	2.2
1	F	49	THR	2.2
1	A	72	HIS	2.2
1	A	300	ASN	2.2
1	F	354	GLY	2.2
3	L	122	VAL	2.2
1	A	238	PRO	2.2
1	B	89	VAL	2.1
3	M	118	THR	2.1
3	H	1	GLU	2.1
3	M	81	LEU	2.1
1	B	384	TYR	2.1
3	M	31	TYR	2.1
1	A	50	THR	2.1
3	M	29	LEU	2.1
1	A	254	VAL	2.1

Continued on next page...

Continued from previous page...

Mol	Chain	Res	Type	RSRZ
1	A	384	TYR	2.1
3	L	31	TYR	2.1
1	B	231	LYS	2.1
1	F	411	GLY	2.1
1	B	464	GLY	2.1
3	H	16	GLY	2.1
1	J	441	GLY	2.1
1	B	375	SER	2.1
1	B	256	SER	2.0
1	J	337	GLN	2.0
3	L	3	GLN	2.0
1	B	49	THR	2.0
3	M	73	ASP	2.0
1	F	257	THR	2.0
1	F	423	ILE	2.0
1	B	423	ILE	2.0
1	A	222	GLY	2.0

6.2 Non-standard residues in protein, DNA, RNA chains [i](#)

In the following table, the Atoms column lists the number of modelled atoms in the group and the number defined in the chemical component dictionary. The B-factors column lists the minimum, median, 95th percentile and maximum values of B factors of atoms in the group. The column labelled 'Q< 0.9' lists the number of atoms with occupancy less than 0.9.

Mol	Type	Chain	Res	Atoms	RSCC	RSR	B-factors(Å ²)	Q<0.9
2	DPR	D	21	7/8	0.92	0.11	19,19,24,25	0
2	DPR	C	21	7/8	0.92	0.14	19,19,24,25	0
2	DPR	G	21	7/8	0.93	0.14	19,19,24,25	0
2	DPR	K	21	7/8	0.93	0.14	19,19,24,25	0
2	U2X	K	23	19/20	0.94	0.22	35,46,57,59	0
2	U2X	C	23	19/20	0.95	0.20	25,38,46,50	0
2	U2X	G	23	19/20	0.96	0.18	35,41,50,58	0
2	U2X	D	23	19/20	0.96	0.23	32,39,47,47	0

6.3 Carbohydrates [i](#)

There are no monosaccharides in this entry.

6.4 Ligands i

In the following table, the Atoms column lists the number of modelled atoms in the group and the number defined in the chemical component dictionary. The B-factors column lists the minimum, median, 95th percentile and maximum values of B factors of atoms in the group. The column labelled 'Q< 0.9' lists the number of atoms with occupancy less than 0.9.

Mol	Type	Chain	Res	Atoms	RSCC	RSR	B-factors(Å ²)	Q<0.9
4	NAG	F	503	14/15	0.61	0.44	115,130,142,143	0
4	NAG	B	502	14/15	0.61	0.32	47,79,94,94	0
5	EDO	J	510	4/4	0.68	0.43	78,79,79,83	0
5	EDO	B	510	4/4	0.68	0.36	80,81,81,84	0
4	NAG	J	505	14/15	0.71	0.29	98,109,122,128	0
4	NAG	A	508	14/15	0.73	0.23	72,81,90,92	0
5	EDO	B	509	4/4	0.78	0.29	58,59,61,61	0
4	NAG	A	502	14/15	0.79	0.29	57,75,97,100	0
4	NAG	F	506	14/15	0.79	0.32	84,89,93,94	0
4	NAG	J	509	14/15	0.80	0.33	84,93,103,104	0
4	NAG	J	503	14/15	0.81	0.38	97,104,107,107	0
4	NAG	F	508	14/15	0.81	0.20	57,74,84,87	0
4	NAG	J	501	14/15	0.82	0.27	90,98,103,104	0
4	NAG	J	502	14/15	0.82	0.19	91,95,98,103	0
6	ACA	B	512	9/9	0.84	0.31	52,59,69,70	0
5	EDO	A	510	4/4	0.85	0.36	62,63,64,66	0
4	NAG	B	503	14/15	0.86	0.16	73,84,89,91	0
4	NAG	A	501	14/15	0.86	0.27	66,75,80,86	0
4	NAG	F	509	14/15	0.86	0.20	56,67,90,95	0
4	NAG	A	509	14/15	0.88	0.22	50,62,82,84	0
4	NAG	B	501	14/15	0.88	0.20	61,69,76,80	0
5	EDO	A	512	4/4	0.88	0.21	55,55,57,59	0
4	NAG	A	506	14/15	0.88	0.22	52,62,72,76	0
4	NAG	A	503	14/15	0.88	0.21	82,85,94,94	0
4	NAG	B	508	14/15	0.88	0.16	50,72,78,83	0
4	NAG	F	505	14/15	0.89	0.24	67,71,80,83	0
4	NAG	J	507	14/15	0.90	0.29	81,85,96,98	0
4	NAG	B	506	14/15	0.90	0.16	49,60,68,69	0
5	EDO	B	511	4/4	0.90	0.16	53,59,63,70	0
4	NAG	F	507	14/15	0.90	0.14	52,58,65,68	0
4	NAG	A	507	14/15	0.91	0.14	36,45,52,52	0
4	NAG	A	505	14/15	0.91	0.18	62,67,76,79	0
4	NAG	B	505	14/15	0.91	0.12	47,52,70,70	0
5	EDO	A	511	4/4	0.92	0.16	49,50,50,52	0
4	NAG	J	506	14/15	0.93	0.26	90,94,104,106	0
4	NAG	J	508	14/15	0.94	0.08	45,50,59,61	0
4	NAG	B	504	14/15	0.95	0.13	29,40,44,45	0

Continued on next page...

Continued from previous page...

Mol	Type	Chain	Res	Atoms	RSCC	RSR	B-factors(\AA^2)	Q<0.9
4	NAG	F	502	14/15	0.95	0.12	52,62,71,74	0
4	NAG	F	501	14/15	0.95	0.18	62,70,79,87	0
4	NAG	B	507	14/15	0.96	0.11	34,44,48,50	0
4	NAG	J	504	14/15	0.96	0.13	52,55,64,64	0
4	NAG	A	504	14/15	0.97	0.12	30,40,46,47	0
4	NAG	F	504	14/15	0.97	0.15	34,43,55,58	0

6.5 Other polymers [i](#)

There are no such residues in this entry.