



Full wwPDB EM Validation Report ⓘ

Oct 21, 2024 – 11:38 AM JST

PDB ID : 6LRR
EMDB ID : EMD-0959
Title : Cryo-EM structure of RuBisCO-Raf1 from Anabaena sp. PCC 7120
Authors : Xia, L.Y.; Jiang, Y.L.; Kong, W.W.; Chen, Y.; Zhou, C.Z.
Deposited on : 2020-01-16
Resolution : 3.37 Å (reported)
Based on initial model : 6KKM

This is a Full wwPDB EM Validation Report for a publicly released PDB entry.

We welcome your comments at validation@mail.wwpdb.org

A user guide is available at

<https://www.wwpdb.org/validation/2017/EMValidationReportHelp>

with specific help available everywhere you see the ⓘ symbol.

The types of validation reports are described at

<http://www.wwpdb.org/validation/2017/FAQs#types>.

The following versions of software and data (see [references ⓘ](#)) were used in the production of this report:

EMDB validation analysis : 0.0.1.dev113
MolProbity : 4.02b-467
Percentile statistics : 20231227.v01 (using entries in the PDB archive December 27th 2023)
MapQ : 1.9.13
Ideal geometry (proteins) : Engh & Huber (2001)
Ideal geometry (DNA, RNA) : Parkinson et al. (1996)
Validation Pipeline (wwPDB-VP) : 2.39

1 Overall quality at a glance

The following experimental techniques were used to determine the structure:
ELECTRON MICROSCOPY

The reported resolution of this entry is 3.37 Å.

Percentile scores (ranging between 0-100) for global validation metrics of the entry are shown in the following graphic. The table shows the number of entries on which the scores are based.

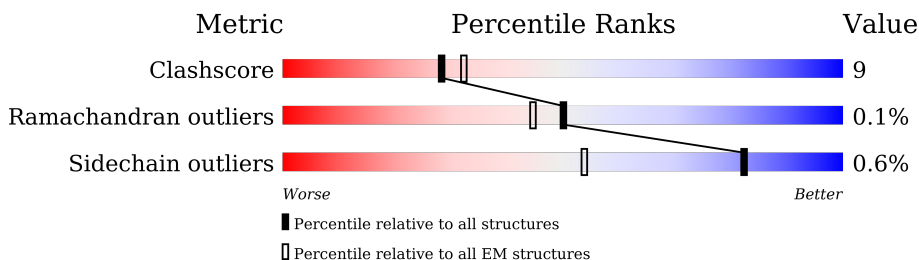

Metric	Whole archive (#Entries)	EM structures (#Entries)
Clashscore	210492	15764
Ramachandran outliers	207382	16835
Sidechain outliers	206894	16415

The table below summarises the geometric issues observed across the polymeric chains and their fit to the map. The red, orange, yellow and green segments of the bar indicate the fraction of residues that contain outliers for ≥ 3 , 2, 1 and 0 types of geometric quality criteria respectively. A grey segment represents the fraction of residues that are not modelled. The numeric value for each fraction is indicated below the corresponding segment, with a dot representing fractions $\leq 5\%$. The upper red bar (where present) indicates the fraction of residues that have poor fit to the EM map (all-atom inclusion $< 40\%$). The numeric value is given above the bar.

Mol	Chain	Length	Quality of chain
1	I	159	
1	J	159	
1	K	159	
1	L	159	
1	M	159	
1	N	159	
1	O	159	
1	P	159	

Continued on next page...

Continued from previous page...

Mol	Chain	Length	Quality of chain
2	Q	109	
2	R	109	
2	T	109	
2	U	109	
2	V	109	
2	W	109	
2	X	109	
2	Y	109	
3	A	476	
3	B	476	
3	C	476	
3	D	476	
3	E	476	
3	F	476	
3	G	476	
3	H	476	

2 Entry composition [i](#)

There are 3 unique types of molecules in this entry. The entry contains 43706 atoms, of which 0 are hydrogens and 0 are deuteriums.

In the tables below, the AltConf column contains the number of residues with at least one atom in alternate conformation and the Trace column contains the number of residues modelled with at most 2 atoms.

- Molecule 1 is a protein called All5250 protein.

Mol	Chain	Residues	Atoms				AltConf	Trace
			Total	C	N	O		
1	O	141	Total	C	N	O	0	0
			1151	756	189	206		
1	P	157	Total	C	N	O	0	0
			1284	839	209	236		
1	M	141	Total	C	N	O	0	0
			1151	756	189	206		
1	N	157	Total	C	N	O	0	0
			1284	839	209	236		
1	K	141	Total	C	N	O	0	0
			1151	756	189	206		
1	L	157	Total	C	N	O	0	0
			1284	839	209	236		
1	I	141	Total	C	N	O	0	0
			1151	756	189	206		
1	J	157	Total	C	N	O	0	0
			1284	839	209	236		

- Molecule 2 is a protein called Ribulose biphosphate carboxylase small chain.

Mol	Chain	Residues	Atoms					AltConf	Trace
			Total	C	N	O	S		
2	T	106	Total	C	N	O	S	0	0
			877	571	144	159	3		
2	W	105	Total	C	N	O	S	0	0
			869	566	143	158	2		
2	U	106	Total	C	N	O	S	0	0
			877	571	144	159	3		
2	V	105	Total	C	N	O	S	0	0
			869	566	143	158	2		
2	X	106	Total	C	N	O	S	0	0
			877	571	144	159	3		
2	Y	105	Total	C	N	O	S	0	0
			869	566	143	158	2		
2	R	105	Total	C	N	O	S	0	0
			869	566	143	158	2		

Continued on next page...

Continued from previous page...

Mol	Chain	Residues	Atoms					AltConf	Trace
			Total	C	N	O	S		
2	Q	106	877	571	144	159	3	0	0

- Molecule 3 is a protein called Ribulose biphosphate carboxylase large chain.

Mol	Chain	Residues	Atoms					AltConf	Trace
			Total	C	N	O	S		
3	G	430	3356	2128	597	618	13	0	0
3	H	434	3386	2148	601	624	13	0	0
3	E	430	3356	2128	597	618	13	0	0
3	F	434	3386	2148	601	624	13	0	0
3	C	432	3370	2136	599	622	13	0	0
3	D	434	3386	2148	601	624	13	0	0
3	A	430	3356	2128	597	618	13	0	0
3	B	434	3386	2148	601	624	13	0	0

3 Residue-property plots

These plots are drawn for all protein, RNA, DNA and oligosaccharide chains in the entry. The first graphic for a chain summarises the proportions of the various outlier classes displayed in the second graphic. The second graphic shows the sequence view annotated by issues in geometry and atom inclusion in map density. Residues are color-coded according to the number of geometric quality criteria for which they contain at least one outlier: green = 0, yellow = 1, orange = 2 and red = 3 or more. A red diamond above a residue indicates a poor fit to the EM map for this residue (all-atom inclusion < 40%). Stretches of 2 or more consecutive residues without any outlier are shown as a green connector. Residues present in the sample, but not in the model, are shown in grey.

- Molecule 1: All5250 protein

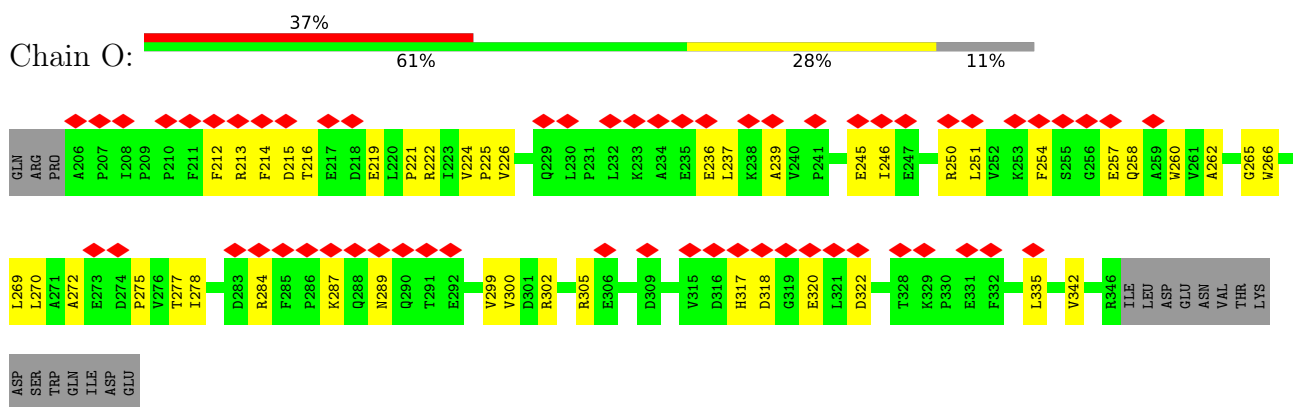

- Molecule 1: All5250 protein

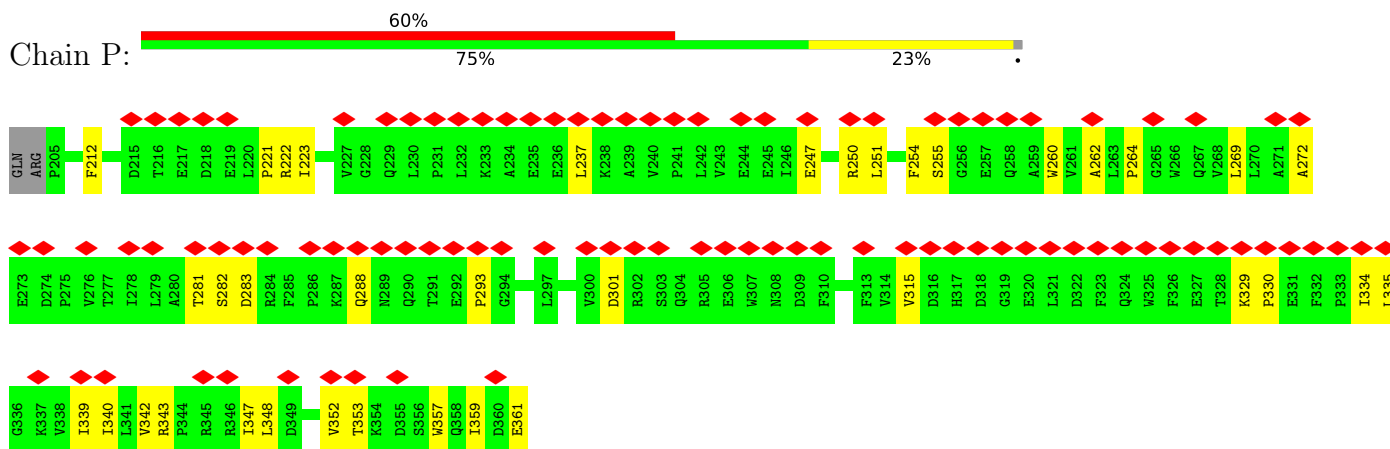

- Molecule 1: All5250 protein

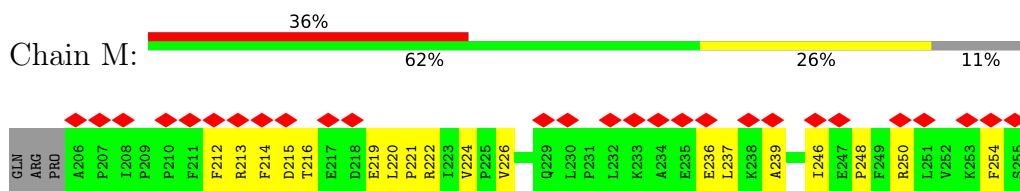

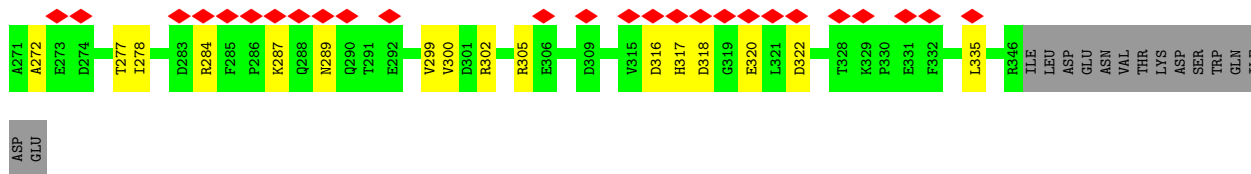

• Molecule 1: All5250 protein

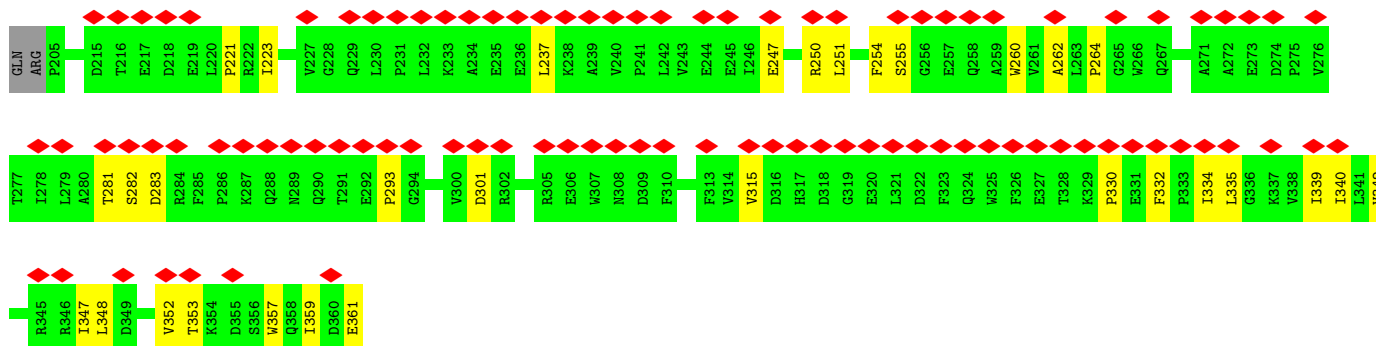
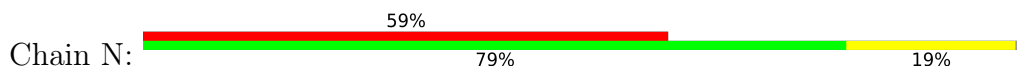

• Molecule 1: All5250 protein

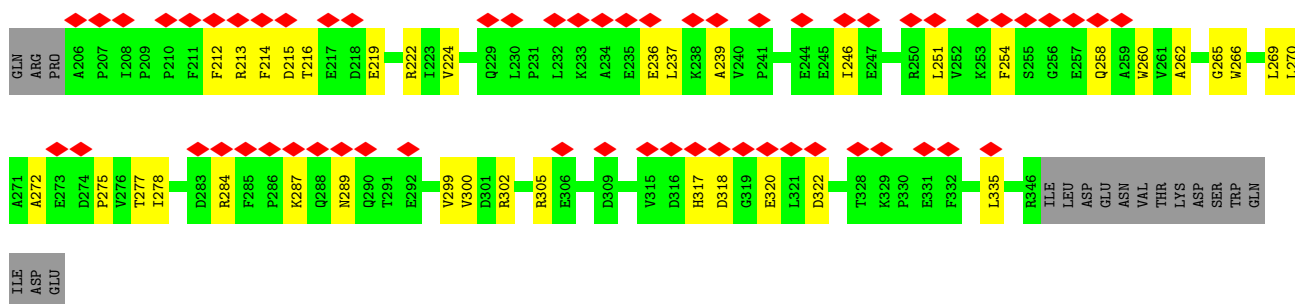

• Molecule 1: All5250 protein

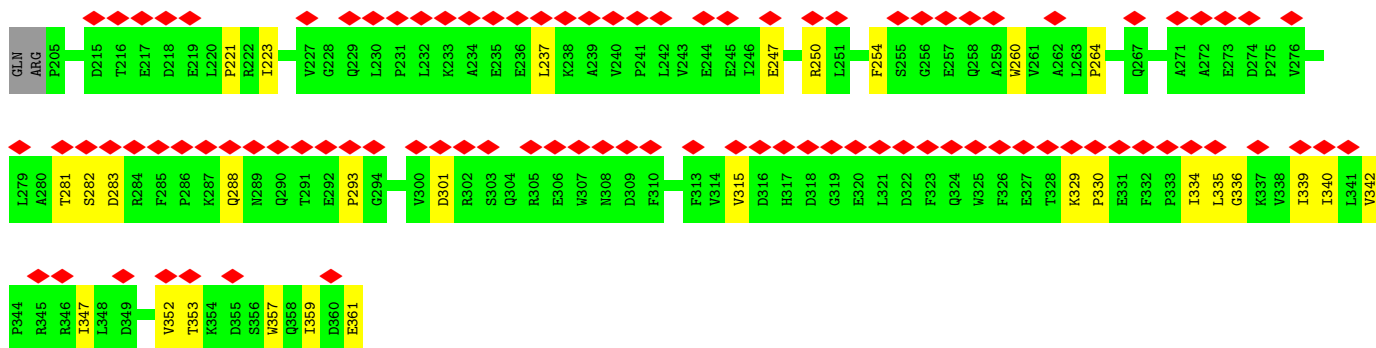
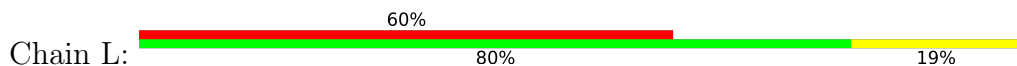

• Molecule 1: All5250 protein

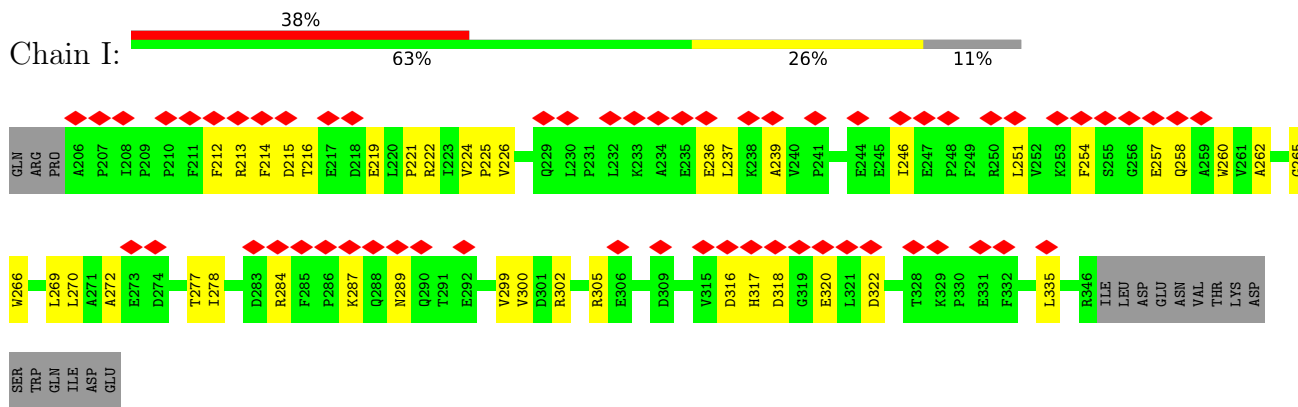

• Molecule 1: All5250 protein

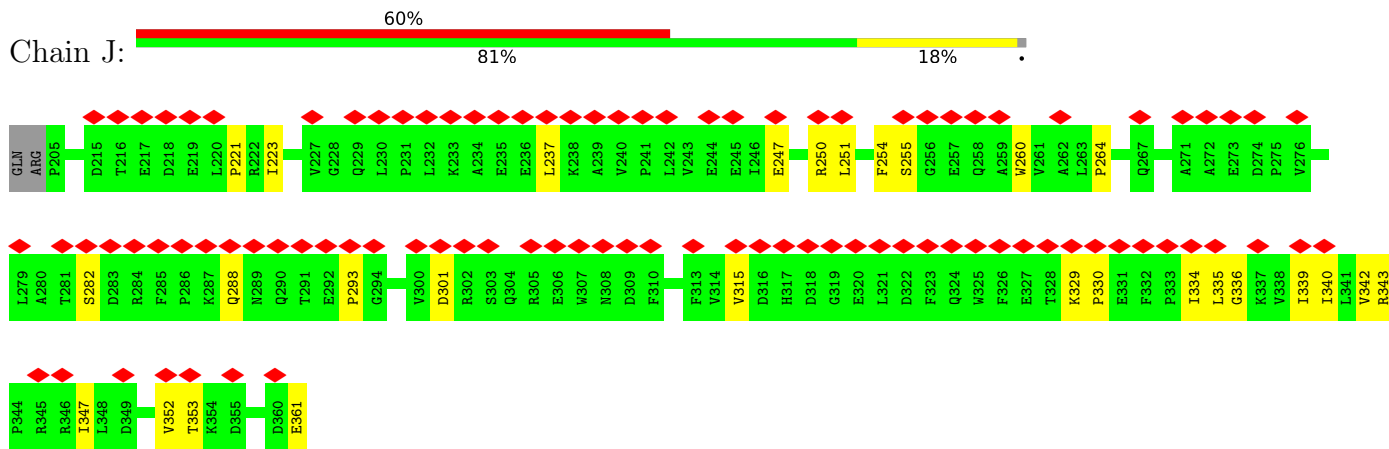

• Molecule 2: Ribulose biphosphate carboxylase small chain

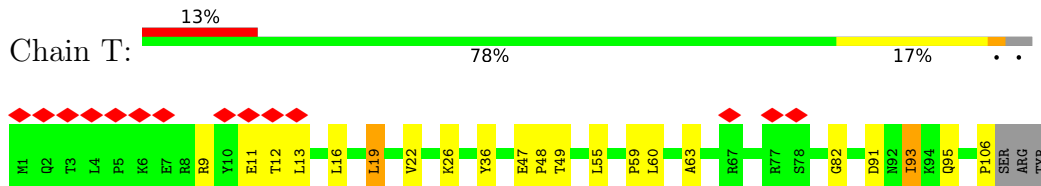

• Molecule 2: Ribulose biphosphate carboxylase small chain

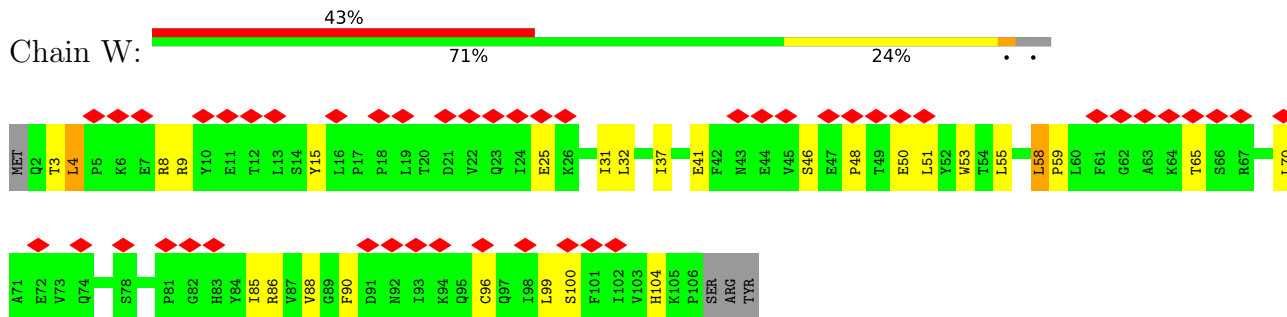

• Molecule 2: Ribulose biphosphate carboxylase small chain

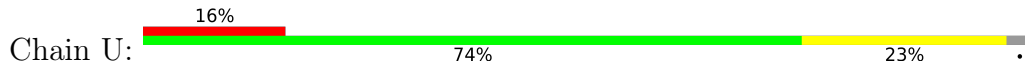



TYR

• Molecule 2: Ribulose biphosphate carboxylase small chain

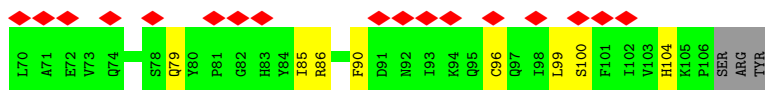
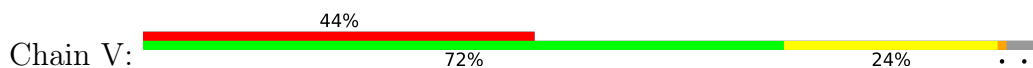

• Molecule 2: Ribulose biphosphate carboxylase small chain

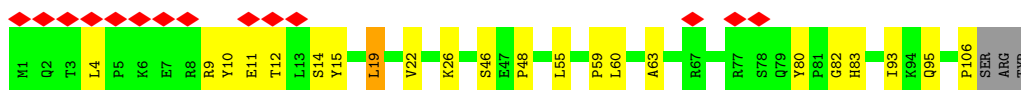
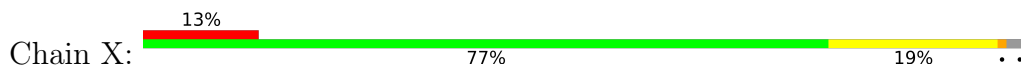

• Molecule 2: Ribulose biphosphate carboxylase small chain

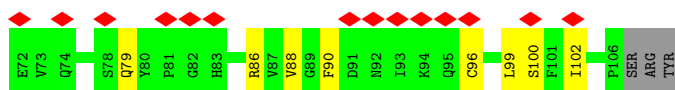
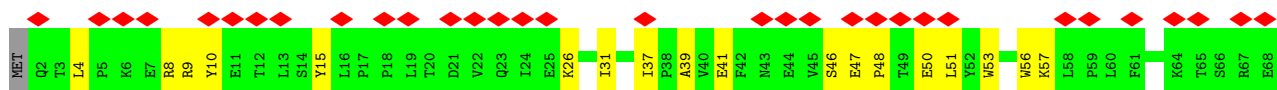
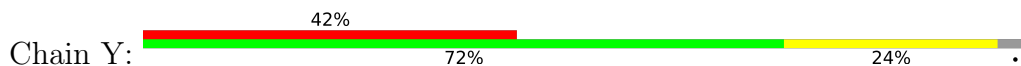

• Molecule 2: Ribulose biphosphate carboxylase small chain

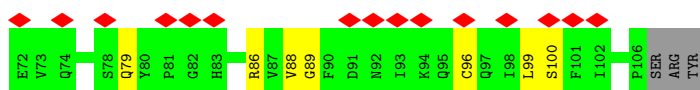
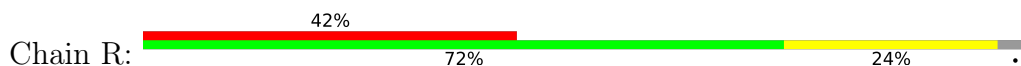

• Molecule 2: Ribulose biphosphate carboxylase small chain

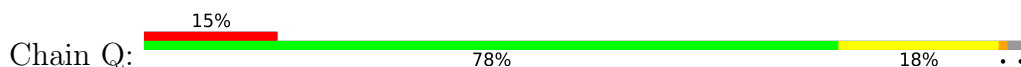

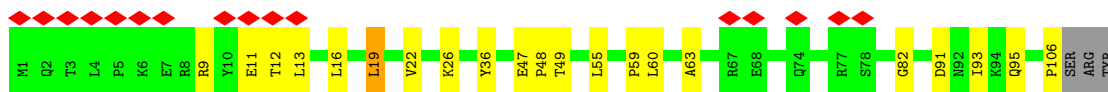

• Molecule 3: Ribulose biphosphate carboxylase large chain

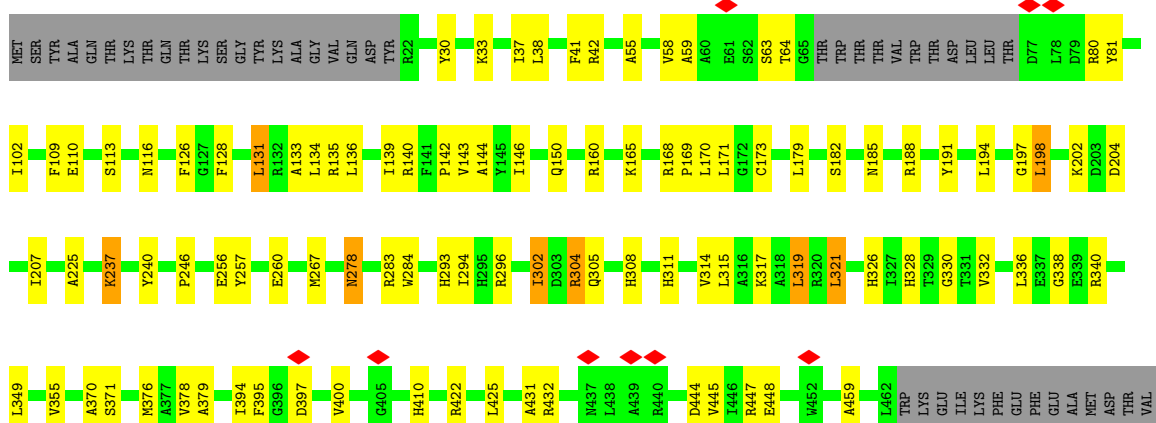

• Molecule 3: Ribulose biphosphate carboxylase large chain

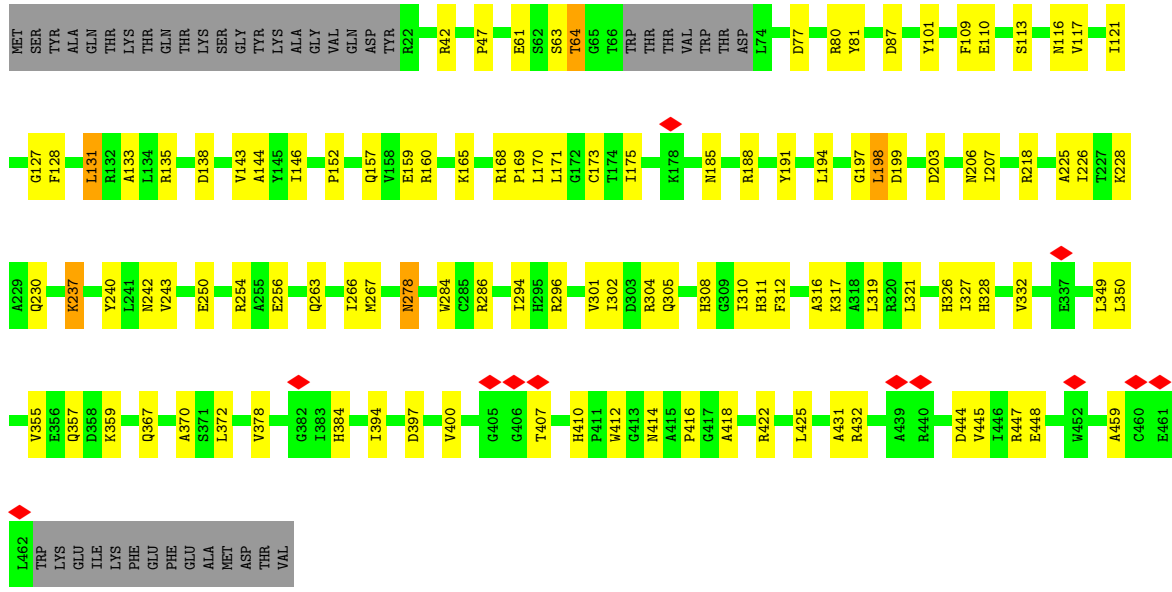

• Molecule 3: Ribulose biphosphate carboxylase large chain



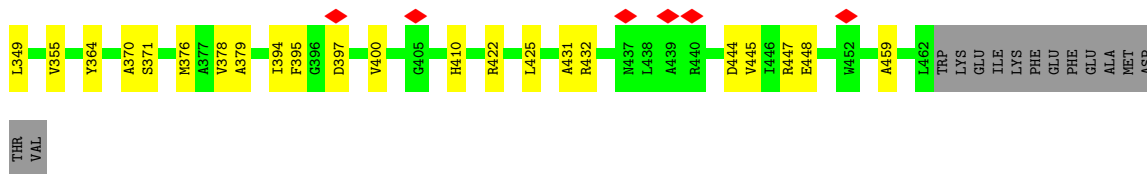

• Molecule 3: Ribulose biphosphate carboxylase large chain

Chain D: 69% 21% 9%

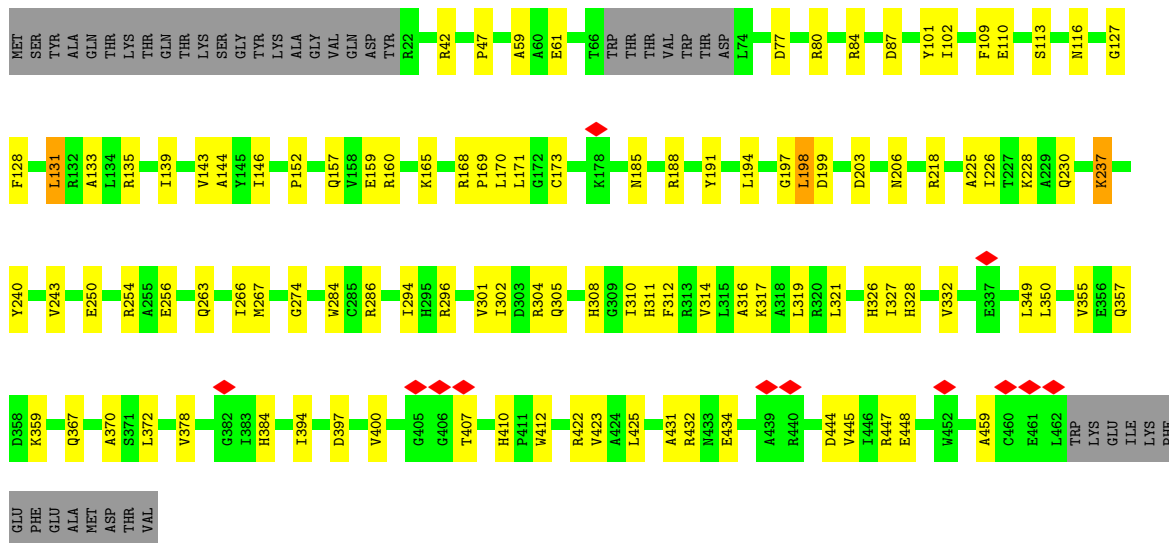

• Molecule 3: Ribulose biphosphate carboxylase large chain

Chain A: 68% 20% 10%

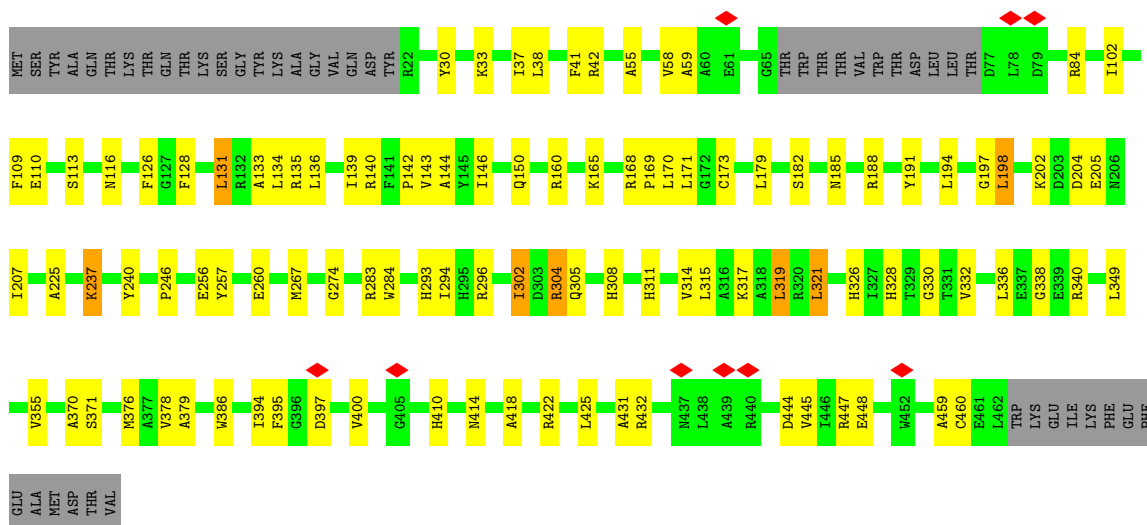

• Molecule 3: Ribulose biphosphate carboxylase large chain

Chain B: 69% 22% 9%

4 Experimental information

Property	Value	Source
EM reconstruction method	SINGLE PARTICLE	Depositor
Imposed symmetry	POINT, C4	Depositor
Number of particles used	149382	Depositor
Resolution determination method	FSC 0.143 CUT-OFF	Depositor
CTF correction method	NONE	Depositor
Microscope	FEI TITAN KRIOS	Depositor
Voltage (kV)	300	Depositor
Electron dose ($e^-/\text{\AA}^2$)	50	Depositor
Minimum defocus (nm)	Not provided	
Maximum defocus (nm)	Not provided	
Magnification	Not provided	
Image detector	GATAN K2 SUMMIT (4k x 4k)	Depositor
Maximum map value	0.207	Depositor
Minimum map value	-0.120	Depositor
Average map value	0.000	Depositor
Map value standard deviation	0.009	Depositor
Recommended contour level	0.0209	Depositor
Map size (\AA)	249.59999, 249.59999, 249.59999	wwPDB
Map dimensions	240, 240, 240	wwPDB
Map angles ($^\circ$)	90.0, 90.0, 90.0	wwPDB
Pixel spacing (\AA)	1.04, 1.04, 1.04	Depositor

5 Model quality [i](#)

5.1 Standard geometry [i](#)

The Z score for a bond length (or angle) is the number of standard deviations the observed value is removed from the expected value. A bond length (or angle) with $|Z| > 5$ is considered an outlier worth inspection. RMSZ is the root-mean-square of all Z scores of the bond lengths (or angles).

Mol	Chain	Bond lengths		Bond angles	
		RMSZ	# Z >5	RMSZ	# Z >5
1	I	0.41	0/1187	0.63	1/1624 (0.1%)
1	J	0.36	0/1323	0.62	0/1810
1	K	0.41	0/1187	0.63	1/1624 (0.1%)
1	L	0.36	0/1323	0.62	0/1810
1	M	0.42	0/1187	0.63	1/1624 (0.1%)
1	N	0.35	0/1323	0.62	0/1810
1	O	0.41	0/1187	0.64	1/1624 (0.1%)
1	P	0.35	0/1323	0.62	0/1810
2	Q	0.52	0/901	0.67	0/1226
2	R	0.42	0/893	0.69	3/1216 (0.2%)
2	T	0.52	0/901	0.67	0/1226
2	U	0.52	0/901	0.67	0/1226
2	V	0.43	0/893	0.66	2/1216 (0.2%)
2	W	0.43	0/893	0.69	3/1216 (0.2%)
2	X	0.52	0/901	0.66	0/1226
2	Y	0.42	0/893	0.69	2/1216 (0.2%)
3	A	0.77	0/3434	0.71	4/4658 (0.1%)
3	B	0.75	0/3464	0.70	3/4700 (0.1%)
3	C	0.77	0/3448	0.72	4/4678 (0.1%)
3	D	0.75	0/3464	0.71	3/4700 (0.1%)
3	E	0.77	0/3434	0.72	4/4658 (0.1%)
3	F	0.75	0/3464	0.70	3/4700 (0.1%)
3	G	0.77	0/3434	0.72	4/4658 (0.1%)
3	H	0.75	0/3464	0.70	3/4700 (0.1%)
All	All	0.65	0/44822	0.69	42/60956 (0.1%)

Chiral center outliers are detected by calculating the chiral volume of a chiral center and verifying if the center is modelled as a planar moiety or with the opposite hand. A planarity outlier is detected by checking planarity of atoms in a peptide group, atoms in a mainchain group or atoms of a sidechain that are expected to be planar.

Mol	Chain	#Chirality outliers	#Planarity outliers
1	N	0	1

Continued on next page...

Continued from previous page...

Mol	Chain	#Chirality outliers	#Planarity outliers
1	P	0	1
2	Q	0	1
2	T	0	2
2	U	0	1
2	W	0	1
3	E	0	1
3	F	0	1
3	G	0	1
3	H	0	1
All	All	0	11

There are no bond length outliers.

All (42) bond angle outliers are listed below:

Mol	Chain	Res	Type	Atoms	Z	Observed(°)	Ideal(°)
3	H	198	LEU	CB-CG-CD2	-7.67	97.96	111.00
3	D	198	LEU	CB-CG-CD2	-7.65	97.99	111.00
3	F	198	LEU	CB-CG-CD2	-7.61	98.07	111.00
3	B	198	LEU	CB-CG-CD2	-7.45	98.33	111.00
3	C	198	LEU	CB-CG-CD2	-7.34	98.52	111.00
3	E	198	LEU	CB-CG-CD2	-7.31	98.57	111.00
3	A	198	LEU	CB-CG-CD2	-7.27	98.63	111.00
3	G	198	LEU	CB-CG-CD2	-7.27	98.65	111.00
3	G	131	LEU	CB-CG-CD2	-6.57	99.83	111.00
3	E	131	LEU	CB-CG-CD2	-6.52	99.91	111.00
3	A	131	LEU	CB-CG-CD2	-6.50	99.94	111.00
3	C	131	LEU	CB-CG-CD2	-6.49	99.96	111.00
3	G	302	ILE	CG1-CB-CG2	-6.07	98.04	111.40
3	A	302	ILE	CG1-CB-CG2	-6.05	98.09	111.40
3	C	302	ILE	CG1-CB-CG2	-6.03	98.14	111.40
3	E	302	ILE	CG1-CB-CG2	-6.02	98.15	111.40
1	O	318	ASP	CB-CG-OD1	5.53	123.27	118.30
3	B	131	LEU	CB-CG-CD2	-5.52	101.62	111.00
3	F	109	PHE	CB-CG-CD1	5.46	124.62	120.80
3	B	109	PHE	CB-CG-CD1	5.43	124.60	120.80
3	D	109	PHE	CB-CG-CD1	5.42	124.60	120.80
2	R	4	LEU	CA-CB-CG	5.41	127.75	115.30
3	A	321	LEU	CB-CG-CD1	-5.38	101.85	111.00
3	C	321	LEU	CB-CG-CD1	-5.37	101.86	111.00
1	K	318	ASP	CB-CG-OD1	5.34	123.11	118.30
1	I	318	ASP	CB-CG-OD1	5.33	123.09	118.30
1	M	318	ASP	CB-CG-OD1	5.33	123.09	118.30

Continued on next page...

Continued from previous page...

Mol	Chain	Res	Type	Atoms	Z	Observed(°)	Ideal(°)
3	G	321	LEU	CB-CG-CD1	-5.32	101.96	111.00
2	W	58	LEU	CA-CB-CG	5.31	127.52	115.30
3	H	109	PHE	CB-CG-CD1	5.31	124.52	120.80
3	E	321	LEU	CB-CG-CD1	-5.26	102.06	111.00
2	Y	51	LEU	CA-CB-CG	5.26	127.40	115.30
2	Y	4	LEU	CA-CB-CG	5.23	127.33	115.30
2	W	51	LEU	CA-CB-CG	5.22	127.30	115.30
2	R	51	LEU	CA-CB-CG	5.20	127.25	115.30
3	F	131	LEU	CB-CG-CD2	-5.17	102.21	111.00
2	V	4	LEU	CA-CB-CG	5.16	127.17	115.30
3	H	131	LEU	CB-CG-CD2	-5.09	102.34	111.00
2	R	58	LEU	CA-CB-CG	5.09	127.01	115.30
3	D	131	LEU	CB-CG-CD2	-5.09	102.35	111.00
2	V	51	LEU	CA-CB-CG	5.05	126.92	115.30
2	W	4	LEU	CA-CB-CG	5.00	126.81	115.30

There are no chirality outliers.

All (11) planarity outliers are listed below:

Mol	Chain	Res	Type	Group
3	E	63	SER	Peptide
3	F	63	SER	Peptide
3	G	63	SER	Peptide
3	H	63	SER	Peptide
1	N	348	LEU	Peptide
1	P	348	LEU	Peptide
2	Q	9	ARG	Peptide
2	T	9	ARG	Peptide
2	T	93	ILE	Peptide
2	U	9	ARG	Peptide
2	W	58	LEU	Peptide

5.2 Too-close contacts [i](#)

In the following table, the Non-H and H(model) columns list the number of non-hydrogen atoms and hydrogen atoms in the chain respectively. The H(added) column lists the number of hydrogen atoms added and optimized by MolProbity. The Clashes column lists the number of clashes within the asymmetric unit, whereas Symm-Clashes lists symmetry-related clashes.

Mol	Chain	Non-H	H(model)	H(added)	Clashes	Symm-Clashes
1	I	1151	0	1146	30	0

Continued on next page...

Continued from previous page...

Mol	Chain	Non-H	H(model)	H(added)	Clashes	Symm-Clashes
1	J	1284	0	1269	22	0
1	K	1151	0	1146	26	0
1	L	1284	0	1269	23	0
1	M	1151	0	1146	29	0
1	N	1284	0	1269	24	0
1	O	1151	0	1146	31	0
1	P	1284	0	1269	30	0
2	Q	877	0	882	12	0
2	R	869	0	870	18	0
2	T	877	0	882	12	0
2	U	877	0	882	13	0
2	V	869	0	870	19	0
2	W	869	0	870	17	0
2	X	877	0	882	16	0
2	Y	869	0	870	19	0
3	A	3356	0	3294	71	0
3	B	3386	0	3330	74	0
3	C	3370	0	3308	71	0
3	D	3386	0	3330	71	0
3	E	3356	0	3294	80	0
3	F	3386	0	3330	78	0
3	G	3356	0	3294	67	0
3	H	3386	0	3330	75	0
All	All	43706	0	43178	810	0

The all-atom clashscore is defined as the number of clashes found per 1000 atoms (including hydrogen atoms). The all-atom clashscore for this structure is 9.

All (810) close contacts within the same asymmetric unit are listed below, sorted by their clash magnitude.

Atom-1	Atom-2	Interatomic distance (Å)	Clash overlap (Å)
2:T:11:GLU:HG2	2:T:48:PRO:HG3	1.65	0.78
2:U:11:GLU:HG2	2:U:48:PRO:HG3	1.64	0.78
2:Q:11:GLU:HG2	2:Q:48:PRO:HG3	1.65	0.77
1:K:214:PHE:HB2	1:K:219:GLU:HB3	1.75	0.69
1:M:214:PHE:HB2	1:M:219:GLU:HB3	1.75	0.69
1:O:214:PHE:HB2	1:O:219:GLU:HB3	1.75	0.68
1:I:214:PHE:HB2	1:I:219:GLU:HB3	1.75	0.68
1:P:222:ARG:HH22	1:P:272:ALA:HB3	1.60	0.67
2:Y:96:CYS:HB2	3:D:157:GLN:HG3	1.76	0.65
3:C:37:ILE:HD12	3:C:109:PHE:HD2	1.61	0.65

Continued on next page...

Continued from previous page...

Atom-1	Atom-2	Interatomic distance (Å)	Clash overlap (Å)
3:E:37:ILE:HD12	3:E:109:PHE:HD2	1.62	0.64
3:A:37:ILE:HD12	3:A:109:PHE:HD2	1.62	0.64
1:M:237:LEU:O	1:M:302:ARG:NH1	2.31	0.64
2:W:50:GLU:OE2	3:B:228:LYS:NZ	2.31	0.64
3:F:228:LYS:NZ	2:Y:50:GLU:OE2	2.31	0.63
3:H:228:LYS:NZ	2:V:50:GLU:OE2	2.31	0.63
2:Y:48:PRO:HB2	3:D:230:GLN:HE21	1.64	0.63
3:H:160:ARG:NH2	3:H:397:ASP:O	2.32	0.63
3:C:185:ASN:OD1	3:C:188:ARG:NH2	2.32	0.63
1:O:237:LEU:O	1:O:302:ARG:NH1	2.31	0.63
2:V:48:PRO:HB2	3:F:230:GLN:HE21	1.64	0.63
1:K:237:LEU:O	1:K:302:ARG:NH1	2.32	0.63
1:P:359:ILE:HD11	3:H:61:GLU:HG2	1.80	0.63
3:E:185:ASN:OD1	3:E:188:ARG:NH2	2.31	0.63
3:D:160:ARG:NH2	3:D:397:ASP:O	2.31	0.63
2:T:93:ILE:HG23	3:F:77:ASP:HB3	1.81	0.63
2:X:93:ILE:HG23	3:B:77:ASP:HB3	1.81	0.63
1:I:237:LEU:O	1:I:302:ARG:NH1	2.31	0.63
3:B:160:ARG:NH2	3:B:397:ASP:O	2.32	0.62
2:W:48:PRO:HB2	3:H:230:GLN:HE21	1.64	0.62
1:N:359:ILE:HD11	3:F:61:GLU:HG2	1.80	0.62
1:K:246:ILE:HB	1:K:251:LEU:HB2	1.81	0.62
3:C:160:ARG:NH2	3:C:397:ASP:O	2.32	0.62
3:E:160:ARG:NH2	3:E:397:ASP:O	2.32	0.62
3:G:160:ARG:NH2	3:G:397:ASP:O	2.32	0.62
3:E:349:LEU:HD23	3:E:355:VAL:HG21	1.82	0.62
3:D:228:LYS:NZ	2:R:50:GLU:OE2	2.31	0.62
3:A:185:ASN:OD1	3:A:188:ARG:NH2	2.33	0.62
3:F:160:ARG:NH2	3:F:397:ASP:O	2.32	0.62
3:A:160:ARG:NH2	3:A:397:ASP:O	2.32	0.62
1:K:212:PHE:HB2	1:L:340:ILE:HD11	1.81	0.62
3:C:144:ALA:HA	3:B:144:ALA:HA	1.82	0.62
1:I:212:PHE:HB2	1:J:340:ILE:HD11	1.82	0.62
1:I:246:ILE:HB	1:I:251:LEU:HB2	1.82	0.62
2:R:48:PRO:HB2	3:B:230:GLN:HE21	1.64	0.62
1:O:216:THR:H	1:O:219:GLU:HG3	1.65	0.61
3:G:185:ASN:OD1	3:G:188:ARG:NH2	2.32	0.61
1:M:258:GLN:HE21	1:N:254:PHE:HB3	1.65	0.61
3:H:144:ALA:HA	3:A:144:ALA:HA	1.82	0.61
1:L:359:ILE:HD11	3:D:61:GLU:HG2	1.81	0.61
3:G:349:LEU:HD23	3:G:355:VAL:HG21	1.82	0.61

Continued on next page...

Continued from previous page...

Atom-1	Atom-2	Interatomic distance (Å)	Clash overlap (Å)
3:C:349:LEU:HD23	3:C:355:VAL:HG21	1.82	0.61
3:G:37:ILE:HD12	3:G:109:PHE:HD2	1.66	0.61
1:O:258:GLN:HE21	1:P:254:PHE:HB3	1.65	0.61
3:G:144:ALA:HA	3:F:144:ALA:HA	1.82	0.61
1:M:212:PHE:HB2	1:N:340:ILE:HD11	1.82	0.61
2:U:93:ILE:HG23	3:D:77:ASP:HB3	1.82	0.61
3:F:194:LEU:O	3:F:237:LYS:NZ	2.34	0.61
1:I:216:THR:H	1:I:219:GLU:HG3	1.65	0.61
3:A:349:LEU:HD23	3:A:355:VAL:HG21	1.82	0.61
1:O:212:PHE:HB2	1:P:340:ILE:HD11	1.83	0.61
3:E:144:ALA:HA	3:D:144:ALA:HA	1.82	0.60
2:R:86:ARG:NH1	2:R:100:SER:OG	2.34	0.60
2:Y:86:ARG:NH1	2:Y:100:SER:OG	2.33	0.60
3:D:135:ARG:NH2	3:D:305:GLN:O	2.34	0.60
2:R:41:GLU:OE1	2:R:86:ARG:NH2	2.34	0.60
1:M:216:THR:H	1:M:219:GLU:HG3	1.65	0.60
1:M:287:LYS:HE2	1:M:289:ASN:HB2	1.83	0.60
1:K:287:LYS:HE2	1:K:289:ASN:HB2	1.83	0.60
3:D:194:LEU:O	3:D:237:LYS:NZ	2.34	0.60
3:C:135:ARG:HH11	3:C:311:HIS:HD2	1.50	0.60
3:H:194:LEU:O	3:H:237:LYS:NZ	2.34	0.60
2:V:86:ARG:NH1	2:V:100:SER:OG	2.32	0.60
3:F:135:ARG:NH2	3:F:305:GLN:O	2.34	0.60
3:C:194:LEU:O	3:C:237:LYS:NZ	2.35	0.60
1:I:287:LYS:HE2	1:I:289:ASN:HB2	1.83	0.60
1:O:287:LYS:HE2	1:O:289:ASN:HB2	1.84	0.60
3:G:135:ARG:HH11	3:G:311:HIS:HD2	1.50	0.60
3:G:160:ARG:NH1	3:G:165:LYS:O	2.35	0.60
3:G:194:LEU:O	3:G:237:LYS:NZ	2.35	0.60
3:E:160:ARG:NH1	3:E:165:LYS:O	2.35	0.60
1:K:216:THR:H	1:K:219:GLU:HG3	1.65	0.60
2:W:86:ARG:NH1	2:W:100:SER:OG	2.32	0.59
3:H:168:ARG:NH1	3:H:199:ASP:OD2	2.35	0.59
3:E:135:ARG:HH11	3:E:311:HIS:HD2	1.50	0.59
3:H:77:ASP:HB3	2:Q:93:ILE:HG23	1.82	0.59
3:C:59:ALA:HB2	3:C:102:ILE:HD12	1.85	0.59
3:B:135:ARG:NH2	3:B:305:GLN:O	2.34	0.59
3:B:194:LEU:O	3:B:237:LYS:NZ	2.34	0.59
3:H:349:LEU:HD23	3:H:355:VAL:HG21	1.84	0.59
3:F:349:LEU:HD23	3:F:355:VAL:HG21	1.84	0.59
3:H:135:ARG:NH2	3:H:305:GLN:O	2.34	0.59

Continued on next page...

Continued from previous page...

Atom-1	Atom-2	Interatomic distance (Å)	Clash overlap (Å)
3:E:80:ARG:NH1	3:E:81:TYR:OH	2.36	0.59
3:A:135:ARG:HH11	3:A:311:HIS:HD2	1.50	0.59
3:G:59:ALA:HB2	3:G:102:ILE:HD12	1.84	0.59
3:F:296:ARG:HG2	3:F:328:HIS:HB2	1.85	0.59
1:I:258:GLN:HE21	1:J:254:PHE:HB3	1.68	0.59
3:A:194:LEU:O	3:A:237:LYS:NZ	2.35	0.59
2:V:55:LEU:HD21	2:V:59:PRO:HD3	1.85	0.59
3:E:194:LEU:O	3:E:237:LYS:NZ	2.35	0.59
3:E:197:GLY:O	3:E:422:ARG:NH1	2.35	0.59
3:G:197:GLY:O	3:G:422:ARG:NH1	2.34	0.58
3:G:332:VAL:HG11	3:G:394:ILE:HG21	1.85	0.58
3:H:296:ARG:HG2	3:H:328:HIS:HB2	1.85	0.58
3:D:168:ARG:NH1	3:D:199:ASP:OD2	2.35	0.58
3:D:173:CYS:H	3:D:198:LEU:HD21	1.68	0.58
3:E:296:ARG:HG2	3:E:328:HIS:HB2	1.85	0.58
3:C:160:ARG:NH1	3:C:165:LYS:O	2.35	0.58
3:D:160:ARG:NH1	3:D:165:LYS:O	2.36	0.58
3:H:169:PRO:HG2	3:H:425:LEU:HD11	1.86	0.58
2:V:41:GLU:OE1	2:V:86:ARG:NH2	2.36	0.58
3:E:332:VAL:HG11	3:E:394:ILE:HG21	1.86	0.58
2:X:9:ARG:NH1	2:X:14:SER:O	2.37	0.58
3:B:349:LEU:HD23	3:B:355:VAL:HG21	1.84	0.58
3:D:349:LEU:HD23	3:D:355:VAL:HG21	1.84	0.58
3:A:296:ARG:HG2	3:A:328:HIS:HB2	1.85	0.58
3:B:168:ARG:NH1	3:B:199:ASP:OD2	2.35	0.58
1:O:246:ILE:HB	1:O:251:LEU:HB2	1.84	0.58
2:Y:37:ILE:HB	2:Y:90:PHE:HB2	1.85	0.58
3:A:59:ALA:HB2	3:A:102:ILE:HD12	1.86	0.58
3:B:160:ARG:NH1	3:B:165:LYS:O	2.36	0.58
3:G:296:ARG:HG2	3:G:328:HIS:HB2	1.86	0.58
1:P:361:GLU:HA	3:G:330:GLY:HA2	1.86	0.58
1:M:220:LEU:HD12	1:M:250:ARG:HH21	1.68	0.58
3:D:431:ALA:HB2	3:D:445:VAL:HG21	1.86	0.58
3:A:160:ARG:NH1	3:A:165:LYS:O	2.35	0.58
3:B:296:ARG:HG2	3:B:328:HIS:HB2	1.85	0.58
3:F:160:ARG:NH1	3:F:165:LYS:O	2.36	0.57
3:C:296:ARG:HG2	3:C:328:HIS:HB2	1.85	0.57
2:W:55:LEU:HD21	2:W:59:PRO:HD3	1.86	0.57
3:E:59:ALA:HB2	3:E:102:ILE:HD12	1.85	0.57
3:C:332:VAL:HG11	3:C:394:ILE:HG21	1.85	0.57
1:P:247:GLU:OE2	1:P:250:ARG:NH2	2.37	0.57

Continued on next page...

Continued from previous page...

Atom-1	Atom-2	Interatomic distance (Å)	Clash overlap (Å)
3:F:431:ALA:HB2	3:F:445:VAL:HG21	1.86	0.57
3:D:296:ARG:HG2	3:D:328:HIS:HB2	1.85	0.57
3:A:332:VAL:HG11	3:A:394:ILE:HG21	1.86	0.57
3:B:169:PRO:HG2	3:B:425:LEU:HD11	1.85	0.57
3:H:431:ALA:HB2	3:H:445:VAL:HG21	1.86	0.57
3:D:169:PRO:HG2	3:D:425:LEU:HD11	1.85	0.57
3:B:397:ASP:OD1	3:B:432:ARG:NH2	2.38	0.57
1:N:361:GLU:HA	3:E:330:GLY:HA2	1.86	0.57
3:F:169:PRO:HG2	3:F:425:LEU:HD11	1.86	0.57
3:D:397:ASP:OD1	3:D:432:ARG:NH2	2.38	0.57
3:B:378:VAL:HG22	3:B:400:VAL:HB	1.86	0.57
3:F:378:VAL:HG22	3:F:400:VAL:HB	1.87	0.57
3:B:42:ARG:HB3	3:B:135:ARG:HB3	1.87	0.57
3:B:431:ALA:HB2	3:B:445:VAL:HG21	1.86	0.57
3:H:185:ASN:OD1	3:H:188:ARG:NH2	2.37	0.57
3:E:135:ARG:NH2	3:E:305:GLN:O	2.38	0.57
3:F:397:ASP:OD1	3:F:432:ARG:NH2	2.38	0.57
1:J:361:GLU:HA	3:A:330:GLY:HA2	1.86	0.57
2:Y:41:GLU:OE1	2:Y:86:ARG:NH2	2.37	0.57
1:N:247:GLU:OE2	1:N:250:ARG:NH2	2.38	0.56
3:D:42:ARG:HB3	3:D:135:ARG:HB3	1.87	0.56
3:H:397:ASP:OD1	3:H:432:ARG:NH2	2.38	0.56
2:W:41:GLU:OE1	2:W:86:ARG:NH2	2.38	0.56
3:F:168:ARG:NH1	3:F:199:ASP:OD2	2.35	0.56
3:F:173:CYS:H	3:F:198:LEU:HD21	1.70	0.56
1:K:258:GLN:HE21	1:L:254:PHE:HB3	1.68	0.56
1:L:361:GLU:HA	3:C:330:GLY:HA2	1.86	0.56
3:A:197:GLY:O	3:A:422:ARG:NH1	2.34	0.56
3:C:135:ARG:NH2	3:C:305:GLN:O	2.39	0.56
3:D:378:VAL:HG22	3:D:400:VAL:HB	1.87	0.56
3:H:173:CYS:H	3:H:198:LEU:HD21	1.69	0.56
3:A:135:ARG:NH2	3:A:305:GLN:O	2.39	0.56
3:B:445:VAL:HA	3:B:448:GLU:HG2	1.88	0.56
3:E:431:ALA:HB2	3:E:445:VAL:HG21	1.88	0.56
1:J:247:GLU:OE2	1:J:250:ARG:NH2	2.39	0.56
2:Q:22:VAL:HG12	2:Q:26:LYS:HE2	1.88	0.56
3:H:42:ARG:HB3	3:H:135:ARG:HB3	1.87	0.56
1:L:247:GLU:OE2	1:L:250:ARG:NH2	2.39	0.56
1:L:282:SER:HB2	1:L:293:PRO:HA	1.88	0.56
3:H:378:VAL:HG22	3:H:400:VAL:HB	1.87	0.56
3:B:173:CYS:H	3:B:198:LEU:HD21	1.70	0.56

Continued on next page...

Continued from previous page...

Atom-1	Atom-2	Interatomic distance (Å)	Clash overlap (Å)
3:C:80:ARG:NH2	3:C:81:TYR:OH	2.39	0.55
3:D:357:GLN:HE21	3:D:359:LYS:HE3	1.71	0.55
3:D:445:VAL:HA	3:D:448:GLU:HG2	1.88	0.55
3:H:445:VAL:HA	3:H:448:GLU:HG2	1.88	0.55
3:G:135:ARG:NH2	3:G:305:GLN:O	2.39	0.55
3:F:357:GLN:HE21	3:F:359:LYS:HE3	1.72	0.55
3:A:431:ALA:HB2	3:A:445:VAL:HG21	1.88	0.55
3:F:445:VAL:HA	3:F:448:GLU:HG2	1.88	0.55
3:H:160:ARG:NH1	3:H:165:LYS:O	2.36	0.55
3:F:42:ARG:HB3	3:F:135:ARG:HB3	1.87	0.55
1:I:284:ARG:NH1	1:I:322:ASP:OD1	2.40	0.55
3:G:256:GLU:OE2	3:G:284:TRP:NE1	2.32	0.55
1:K:284:ARG:NH1	1:K:322:ASP:OD1	2.40	0.55
2:X:22:VAL:HG12	2:X:26:LYS:HE2	1.89	0.55
3:G:431:ALA:HB2	3:G:445:VAL:HG21	1.88	0.55
2:U:22:VAL:HG12	2:U:26:LYS:HE2	1.88	0.55
3:C:431:ALA:HB2	3:C:445:VAL:HG21	1.88	0.55
1:J:282:SER:HB2	1:J:293:PRO:HA	1.88	0.55
3:A:256:GLU:OE2	3:A:284:TRP:NE1	2.32	0.55
3:B:159:GLU:OE2	3:B:326:HIS:NE2	2.41	0.55
3:C:169:PRO:HG2	3:C:425:LEU:HD11	1.89	0.54
3:H:159:GLU:OE2	3:H:326:HIS:NE2	2.41	0.54
3:H:357:GLN:HE21	3:H:359:LYS:HE3	1.72	0.54
1:M:246:ILE:HG22	1:M:248:PRO:HD2	1.89	0.54
1:M:284:ARG:NH1	1:M:322:ASP:OD1	2.40	0.54
3:G:179:LEU:HD23	3:H:64:THR:H	1.71	0.54
2:R:8:ARG:NH2	2:R:46:SER:O	2.41	0.54
3:A:169:PRO:HG2	3:A:425:LEU:HD11	1.90	0.54
2:T:22:VAL:HG12	2:T:26:LYS:HE2	1.89	0.54
3:F:197:GLY:O	3:F:422:ARG:NH1	2.35	0.54
3:B:357:GLN:HE21	3:B:359:LYS:HE3	1.71	0.54
3:G:169:PRO:HG2	3:G:425:LEU:HD11	1.90	0.54
3:H:250:GLU:OE2	3:H:254:ARG:NH2	2.40	0.54
3:F:159:GLU:OE2	3:F:326:HIS:NE2	2.41	0.54
3:B:250:GLU:OE2	3:B:254:ARG:NH2	2.40	0.54
1:O:284:ARG:NH1	1:O:322:ASP:OD1	2.40	0.54
3:F:185:ASN:OD1	3:F:188:ARG:NH2	2.37	0.54
3:G:240:TYR:HB3	3:G:267:MET:HB3	1.90	0.54
3:D:159:GLU:OE2	3:D:326:HIS:NE2	2.40	0.54
1:O:213:ARG:HA	1:P:342:VAL:HG23	1.90	0.53
1:I:224:VAL:HG11	1:I:269:LEU:HD11	1.90	0.53

Continued on next page...

Continued from previous page...

Atom-1	Atom-2	Interatomic distance (Å)	Clash overlap (Å)
1:P:347:ILE:HG22	3:G:336:LEU:HA	1.90	0.53
3:D:250:GLU:OE2	3:D:254:ARG:NH2	2.40	0.53
3:A:240:TYR:HB3	3:A:267:MET:HB3	1.90	0.53
3:B:185:ASN:OD1	3:B:188:ARG:NH2	2.37	0.53
1:K:222:ARG:NH1	1:K:272:ALA:O	2.40	0.53
2:R:31:ILE:HG12	2:R:99:LEU:HD13	1.90	0.53
1:O:224:VAL:HG11	1:O:269:LEU:HD11	1.90	0.53
3:E:169:PRO:HG2	3:E:425:LEU:HD11	1.90	0.53
2:W:8:ARG:NH2	2:W:46:SER:O	2.41	0.53
2:Y:8:ARG:NH2	2:Y:46:SER:O	2.41	0.53
3:A:135:ARG:HH11	3:A:311:HIS:CD2	2.27	0.53
1:M:222:ARG:NH1	1:M:272:ALA:O	2.40	0.53
1:I:213:ARG:HA	1:J:342:VAL:HG23	1.90	0.53
1:M:224:VAL:HG11	1:M:269:LEU:HD11	1.90	0.53
3:D:185:ASN:OD1	3:D:188:ARG:NH2	2.37	0.53
2:R:39:ALA:HB3	2:R:88:VAL:HG23	1.91	0.53
2:V:56:TRP:HH2	2:V:79:GLN:HG2	1.74	0.53
1:K:224:VAL:HG11	1:K:269:LEU:HD11	1.90	0.53
3:C:37:ILE:HD12	3:C:109:PHE:CD2	2.44	0.53
2:W:25:GLU:HG2	2:W:70:LEU:HD13	1.91	0.53
3:A:110:GLU:HB3	3:A:113:SER:HB3	1.91	0.53
1:P:222:ARG:NH2	1:P:269:LEU:O	2.42	0.52
2:V:8:ARG:NH2	2:V:46:SER:O	2.42	0.52
2:X:60:LEU:HB3	2:X:63:ALA:HB2	1.91	0.52
3:C:240:TYR:HB3	3:C:267:MET:HB3	1.90	0.52
3:G:110:GLU:HB3	3:G:113:SER:HB3	1.91	0.52
3:E:240:TYR:HB3	3:E:267:MET:HB3	1.91	0.52
1:K:277:THR:HG22	1:K:299:VAL:HG22	1.92	0.52
1:O:277:THR:HG22	1:O:299:VAL:HG22	1.91	0.52
3:E:274:GLY:O	3:E:278:ASN:ND2	2.42	0.52
3:E:445:VAL:HA	3:E:448:GLU:HG2	1.92	0.52
1:K:213:ARG:HA	1:L:342:VAL:HG23	1.90	0.52
3:D:206:ASN:OD1	3:D:206:ASN:N	2.38	0.52
3:C:197:GLY:O	3:C:422:ARG:NH1	2.35	0.52
2:R:55:LEU:HD21	2:R:59:PRO:HD3	1.91	0.52
3:A:444:ASP:OD1	3:A:447:ARG:NH2	2.42	0.52
3:G:37:ILE:HD12	3:G:109:PHE:CD2	2.45	0.52
1:M:277:THR:HG22	1:M:299:VAL:HG22	1.91	0.52
1:N:347:ILE:HG22	3:E:336:LEU:HA	1.91	0.52
3:C:135:ARG:HH11	3:C:311:HIS:CD2	2.27	0.52
3:B:317:LYS:HE3	3:B:349:LEU:HD13	1.92	0.52

Continued on next page...

Continued from previous page...

Atom-1	Atom-2	Interatomic distance (Å)	Clash overlap (Å)
3:G:444:ASP:OD1	3:G:447:ARG:NH2	2.42	0.52
2:U:60:LEU:HB3	2:U:63:ALA:HB2	1.92	0.52
2:Y:53:TRP:HB2	2:Y:86:ARG:HH21	1.75	0.52
1:O:222:ARG:NH1	1:O:272:ALA:O	2.40	0.52
3:H:317:LYS:HE3	3:H:349:LEU:HD13	1.92	0.52
1:M:213:ARG:HA	1:N:342:VAL:HG23	1.92	0.52
3:E:444:ASP:OD1	3:E:447:ARG:NH2	2.42	0.52
3:C:110:GLU:HB3	3:C:113:SER:HB3	1.91	0.52
3:D:197:GLY:O	3:D:422:ARG:NH1	2.35	0.52
3:B:146:ILE:HG12	3:B:321:LEU:HD21	1.92	0.51
2:T:60:LEU:HB3	2:T:63:ALA:HB2	1.91	0.51
1:I:277:THR:HG22	1:I:299:VAL:HG22	1.92	0.51
3:E:110:GLU:HB3	3:E:113:SER:HB3	1.91	0.51
3:C:445:VAL:HA	3:C:448:GLU:HG2	1.91	0.51
3:F:250:GLU:OE2	3:F:254:ARG:NH2	2.41	0.51
1:L:221:PRO:HB3	1:L:264:PRO:HA	1.92	0.51
3:E:37:ILE:HD12	3:E:109:PHE:CD2	2.44	0.51
3:E:179:LEU:HD23	3:F:64:THR:H	1.75	0.51
3:F:317:LYS:HE3	3:F:349:LEU:HD13	1.92	0.51
3:C:444:ASP:OD1	3:C:447:ARG:NH2	2.43	0.51
3:D:317:LYS:HE3	3:D:349:LEU:HD13	1.92	0.51
3:C:378:VAL:HG22	3:C:400:VAL:HB	1.93	0.51
3:D:444:ASP:OD1	3:D:447:ARG:NH2	2.40	0.51
1:J:221:PRO:HB3	1:J:264:PRO:HA	1.92	0.51
3:A:378:VAL:HG22	3:A:400:VAL:HB	1.93	0.51
3:C:139:ILE:O	3:C:317:LYS:NZ	2.38	0.51
1:J:347:ILE:HG22	3:A:336:LEU:HA	1.93	0.51
2:Q:60:LEU:HB3	2:Q:63:ALA:HB2	1.91	0.51
2:W:31:ILE:HG12	2:W:99:LEU:HD13	1.93	0.51
3:H:110:GLU:HB3	3:H:113:SER:HB3	1.93	0.51
3:D:146:ILE:HG12	3:D:321:LEU:HD21	1.92	0.51
3:A:445:VAL:HA	3:A:448:GLU:HG2	1.92	0.51
3:B:110:GLU:HB3	3:B:113:SER:HB3	1.93	0.51
2:R:53:TRP:HB2	2:R:86:ARG:HH21	1.76	0.51
1:O:317:HIS:N	1:O:320:GLU:O	2.43	0.50
2:W:53:TRP:HB2	2:W:86:ARG:HH21	1.76	0.50
3:D:110:GLU:HB3	3:D:113:SER:HB3	1.93	0.50
3:F:110:GLU:HB3	3:F:113:SER:HB3	1.93	0.50
3:G:378:VAL:HG22	3:G:400:VAL:HB	1.93	0.50
3:A:139:ILE:O	3:A:317:LYS:NZ	2.38	0.50
3:H:146:ILE:HG12	3:H:321:LEU:HD21	1.93	0.50

Continued on next page...

Continued from previous page...

Atom-1	Atom-2	Interatomic distance (Å)	Clash overlap (Å)
3:H:197:GLY:O	3:H:422:ARG:NH1	2.35	0.50
1:N:347:ILE:HB	1:N:352:VAL:HG21	1.94	0.50
3:A:37:ILE:HD12	3:A:109:PHE:CD2	2.44	0.50
3:G:445:VAL:HA	3:G:448:GLU:HG2	1.92	0.50
3:E:135:ARG:HH11	3:E:311:HIS:CD2	2.28	0.50
3:F:146:ILE:HG12	3:F:321:LEU:HD21	1.92	0.50
3:A:173:CYS:H	3:A:198:LEU:HD21	1.77	0.50
1:P:282:SER:HB2	1:P:293:PRO:HA	1.94	0.50
3:E:256:GLU:OE2	3:E:284:TRP:NE1	2.32	0.50
3:G:135:ARG:HH11	3:G:311:HIS:CD2	2.27	0.50
3:G:304:ARG:HG3	3:H:127:GLY:HA2	1.94	0.50
2:V:31:ILE:HG12	2:V:99:LEU:HD13	1.94	0.50
3:E:173:CYS:H	3:E:198:LEU:HD21	1.77	0.50
2:X:12:THR:HG23	3:C:168:ARG:HD3	1.93	0.50
3:D:170:LEU:HB2	3:D:400:VAL:HG22	1.94	0.50
3:H:170:LEU:HB2	3:H:400:VAL:HG22	1.93	0.49
3:B:135:ARG:HH11	3:B:311:HIS:CD2	2.29	0.49
3:F:135:ARG:HH11	3:F:311:HIS:CD2	2.29	0.49
1:P:347:ILE:HB	1:P:352:VAL:HG21	1.94	0.49
3:E:378:VAL:HG22	3:E:400:VAL:HB	1.94	0.49
3:F:170:LEU:HB2	3:F:400:VAL:HG22	1.94	0.49
3:F:240:TYR:HB3	3:F:267:MET:HB3	1.95	0.49
3:F:444:ASP:OD1	3:F:447:ARG:NH2	2.40	0.49
3:D:135:ARG:HH11	3:D:311:HIS:CD2	2.29	0.49
3:F:312:PHE:O	3:F:316:ALA:N	2.45	0.49
1:L:347:ILE:HG22	3:C:336:LEU:HA	1.92	0.49
3:H:135:ARG:HH11	3:H:311:HIS:CD2	2.29	0.49
3:F:161:ASP:OD1	3:F:166:TYR:OH	2.28	0.49
1:L:347:ILE:HB	1:L:352:VAL:HG21	1.94	0.49
3:C:256:GLU:OE2	3:C:284:TRP:NE1	2.32	0.49
3:D:312:PHE:O	3:D:316:ALA:N	2.46	0.49
1:I:236:GLU:HA	1:I:239:ALA:HB3	1.95	0.49
3:B:171:LEU:HD21	3:B:425:LEU:HD22	1.95	0.49
3:B:384:HIS:HB3	3:B:407:THR:HG21	1.95	0.49
2:Y:31:ILE:HG12	2:Y:99:LEU:HD13	1.94	0.49
3:D:240:TYR:HB3	3:D:267:MET:HB3	1.94	0.49
3:H:191:TYR:HB2	3:H:225:ALA:HB1	1.94	0.49
3:E:139:ILE:O	3:E:317:LYS:NZ	2.38	0.49
2:Y:88:VAL:HG12	2:Y:100:SER:HA	1.95	0.49
3:D:384:HIS:HB3	3:D:407:THR:HG21	1.95	0.49
3:B:170:LEU:HB2	3:B:400:VAL:HG22	1.93	0.49

Continued on next page...

Continued from previous page...

Atom-1	Atom-2	Interatomic distance (Å)	Clash overlap (Å)
1:O:236:GLU:HA	1:O:239:ALA:HB3	1.95	0.48
1:P:315:VAL:HG12	1:P:334:ILE:HA	1.95	0.48
2:R:26:LYS:HE2	3:B:434:GLU:HB3	1.95	0.48
3:B:312:PHE:O	3:B:316:ALA:N	2.45	0.48
1:M:262:ALA:HB2	1:N:223:ILE:HG13	1.93	0.48
3:B:197:GLY:O	3:B:422:ARG:NH1	2.35	0.48
1:O:262:ALA:HB2	1:P:223:ILE:HG13	1.95	0.48
1:O:265:GLY:HA2	1:O:269:LEU:HD23	1.96	0.48
2:W:37:ILE:HG13	2:W:90:PHE:HB2	1.94	0.48
3:E:268:HIS:ND1	3:E:278:ASN:OD1	2.45	0.48
2:Y:26:LYS:HE2	3:D:434:GLU:HB3	1.95	0.48
3:D:171:LEU:HD21	3:D:425:LEU:HD22	1.95	0.48
3:B:240:TYR:HB3	3:B:267:MET:HB3	1.95	0.48
2:V:4:LEU:HB2	3:F:416:PRO:HG3	1.95	0.48
3:F:384:HIS:HB3	3:F:407:THR:HG21	1.95	0.48
1:L:315:VAL:HG12	1:L:334:ILE:HA	1.96	0.48
1:I:317:HIS:N	1:I:320:GLU:O	2.47	0.48
3:H:171:LEU:HD21	3:H:425:LEU:HD22	1.95	0.48
1:M:215:ASP:HB3	3:E:338:GLY:HA3	1.96	0.48
2:V:53:TRP:HB2	2:V:86:ARG:HH21	1.78	0.48
3:F:316:ALA:HB1	3:F:350:LEU:HD23	1.95	0.48
1:M:265:GLY:HA2	1:M:269:LEU:HD23	1.96	0.48
1:K:236:GLU:HA	1:K:239:ALA:HB3	1.95	0.48
2:Y:39:ALA:N	2:Y:88:VAL:O	2.46	0.48
1:I:222:ARG:NH1	1:I:272:ALA:O	2.40	0.48
3:F:191:TYR:HB2	3:F:225:ALA:HB1	1.94	0.48
3:F:226:ILE:HD12	3:F:263:GLN:HE22	1.79	0.48
2:X:48:PRO:HB2	3:C:235:GLU:HA	1.95	0.48
1:J:347:ILE:HB	1:J:352:VAL:HG21	1.95	0.48
2:R:88:VAL:HG12	2:R:100:SER:HA	1.96	0.48
2:T:95:GLN:NE2	3:E:182:SER:H	2.12	0.48
3:G:42:ARG:N	3:G:135:ARG:O	2.46	0.48
3:E:128:PHE:HD2	3:E:131:LEU:HD13	1.79	0.48
3:D:191:TYR:HB2	3:D:225:ALA:HB1	1.95	0.48
3:A:42:ARG:N	3:A:135:ARG:O	2.47	0.48
3:G:30:TYR:OH	3:G:33:LYS:NZ	2.41	0.47
3:F:171:LEU:HD21	3:F:425:LEU:HD22	1.95	0.47
3:C:128:PHE:HD2	3:C:131:LEU:HD13	1.79	0.47
3:G:128:PHE:HD2	3:G:131:LEU:HD13	1.79	0.47
3:C:30:TYR:OH	3:C:33:LYS:NZ	2.41	0.47
3:C:42:ARG:N	3:C:135:ARG:O	2.47	0.47

Continued on next page...

Continued from previous page...

Atom-1	Atom-2	Interatomic distance (Å)	Clash overlap (Å)
3:D:226:ILE:HD12	3:D:263:GLN:HE22	1.79	0.47
1:I:215:ASP:HB3	3:A:338:GLY:HA3	1.97	0.47
1:J:315:VAL:HG12	1:J:334:ILE:HA	1.96	0.47
3:B:191:TYR:HB2	3:B:225:ALA:HB1	1.96	0.47
3:B:444:ASP:OD1	3:B:447:ARG:NH2	2.40	0.47
3:G:173:CYS:H	3:G:198:LEU:HD21	1.78	0.47
2:U:82:GLY:HA2	2:U:106:PRO:HB3	1.96	0.47
3:E:38:LEU:HD12	3:E:140:ARG:HE	1.80	0.47
2:W:4:LEU:HB2	3:H:416:PRO:HG3	1.96	0.47
3:G:38:LEU:HD12	3:G:140:ARG:HE	1.80	0.47
3:H:316:ALA:HB1	3:H:350:LEU:HD23	1.96	0.47
3:C:170:LEU:HB2	3:C:400:VAL:HG22	1.96	0.47
3:B:316:ALA:HB1	3:B:350:LEU:HD23	1.96	0.47
1:M:317:HIS:N	1:M:320:GLU:O	2.46	0.47
1:K:215:ASP:HB3	3:C:338:GLY:HA3	1.97	0.47
1:K:265:GLY:HA2	1:K:269:LEU:HD23	1.96	0.47
3:C:173:CYS:N	3:C:198:LEU:HD21	2.30	0.47
3:A:170:LEU:HB2	3:A:400:VAL:HG22	1.97	0.47
2:T:82:GLY:HA2	2:T:106:PRO:HB3	1.96	0.47
3:E:170:LEU:HB2	3:E:400:VAL:HG22	1.97	0.47
2:R:38:PRO:HA	2:R:89:GLY:HA2	1.95	0.47
1:O:215:ASP:HB3	3:G:338:GLY:HA3	1.95	0.47
3:G:37:ILE:HG12	3:G:142:PRO:HD3	1.97	0.47
1:M:236:GLU:HA	1:M:239:ALA:HB3	1.96	0.47
1:N:315:VAL:HG12	1:N:334:ILE:HA	1.97	0.47
3:E:133:ALA:HB1	3:E:308:HIS:HB2	1.96	0.47
3:C:38:LEU:HD12	3:C:140:ARG:HE	1.80	0.47
3:C:133:ALA:HB1	3:C:308:HIS:HB2	1.97	0.47
3:A:128:PHE:HD2	3:A:131:LEU:HD13	1.79	0.47
3:C:371:SER:OG	3:B:80:ARG:NH2	2.46	0.47
1:I:265:GLY:HA2	1:I:269:LEU:HD23	1.96	0.47
2:Q:82:GLY:HA2	2:Q:106:PRO:HB3	1.96	0.47
3:H:240:TYR:HB3	3:H:267:MET:HB3	1.95	0.47
1:K:317:HIS:N	1:K:320:GLU:O	2.46	0.47
3:E:302:ILE:HD11	3:E:315:LEU:HD11	1.96	0.47
3:B:226:ILE:HD12	3:B:263:GLN:HE22	1.79	0.47
3:G:110:GLU:HB2	3:G:116:ASN:HD22	1.80	0.46
3:G:170:LEU:HB2	3:G:400:VAL:HG22	1.97	0.46
3:E:173:CYS:N	3:E:198:LEU:HD21	2.30	0.46
3:H:226:ILE:HD12	3:H:263:GLN:HE22	1.79	0.46
2:U:55:LEU:HD21	2:U:59:PRO:HD3	1.97	0.46

Continued on next page...

Continued from previous page...

Atom-1	Atom-2	Interatomic distance (Å)	Clash overlap (Å)
3:A:37:ILE:HG12	3:A:142:PRO:HD3	1.96	0.46
3:A:38:LEU:HD12	3:A:140:ARG:HE	1.81	0.46
1:P:221:PRO:HB3	1:P:264:PRO:HA	1.97	0.46
3:G:173:CYS:N	3:G:198:LEU:HD21	2.30	0.46
3:D:316:ALA:HB1	3:D:350:LEU:HD23	1.96	0.46
3:A:30:TYR:OH	3:A:33:LYS:NZ	2.41	0.46
3:G:80:ARG:NH1	3:G:81:TYR:OH	2.49	0.46
3:G:133:ALA:HB1	3:G:308:HIS:HB2	1.96	0.46
3:H:312:PHE:O	3:H:316:ALA:N	2.45	0.46
3:E:42:ARG:N	3:E:135:ARG:O	2.46	0.46
3:D:256:GLU:OE2	3:D:284:TRP:NE1	2.45	0.46
3:A:304:ARG:HG3	3:B:127:GLY:HA2	1.97	0.46
3:C:304:ARG:HG3	3:D:127:GLY:HA2	1.96	0.46
3:A:173:CYS:N	3:A:198:LEU:HD21	2.30	0.46
3:A:332:VAL:HG13	3:A:340:ARG:HB2	1.97	0.46
3:G:146:ILE:HG12	3:G:321:LEU:HD21	1.97	0.46
3:C:37:ILE:HG12	3:C:142:PRO:HD3	1.96	0.46
3:B:256:GLU:OE2	3:B:284:TRP:NE1	2.45	0.46
3:G:139:ILE:O	3:G:317:LYS:NZ	2.38	0.46
3:H:206:ASN:OD1	3:H:206:ASN:N	2.38	0.46
2:U:13:LEU:HD13	2:U:16:LEU:HD21	1.98	0.46
3:E:30:TYR:OH	3:E:33:LYS:NZ	2.41	0.46
3:E:332:VAL:HG13	3:E:340:ARG:HB2	1.97	0.46
3:D:133:ALA:HB1	3:D:308:HIS:HB2	1.98	0.46
3:C:332:VAL:HG13	3:C:340:ARG:HB2	1.97	0.46
1:N:357:TRP:HE3	3:F:128:PHE:HZ	1.64	0.46
3:E:37:ILE:HG12	3:E:142:PRO:HD3	1.96	0.46
3:C:146:ILE:HG12	3:C:321:LEU:HD21	1.97	0.46
3:H:133:ALA:HB1	3:H:308:HIS:HB2	1.98	0.46
3:H:152:PRO:O	3:H:286:ARG:NH1	2.46	0.46
3:H:444:ASP:OD1	3:H:447:ARG:NH2	2.40	0.46
2:U:95:GLN:NE2	3:C:182:SER:H	2.14	0.46
2:V:32:LEU:HD13	2:V:65:THR:HA	1.98	0.46
3:E:386:TRP:NE1	3:E:460:CYS:O	2.43	0.46
3:B:133:ALA:HB1	3:B:308:HIS:HB2	1.98	0.46
3:E:78:LEU:HG	3:E:82:LYS:HD3	1.98	0.45
2:Q:55:LEU:HD21	2:Q:59:PRO:HD3	1.98	0.45
3:A:146:ILE:HG12	3:A:321:LEU:HD21	1.97	0.45
3:G:332:VAL:HG13	3:G:340:ARG:HB2	1.97	0.45
3:H:278:ASN:HD21	3:H:294:ILE:HD11	1.82	0.45
1:M:254:PHE:HD2	1:M:260:TRP:HZ3	1.63	0.45

Continued on next page...

Continued from previous page...

Atom-1	Atom-2	Interatomic distance (Å)	Clash overlap (Å)
1:N:282:SER:HB2	1:N:293:PRO:HA	1.97	0.45
3:F:133:ALA:HB1	3:F:308:HIS:HB2	1.98	0.45
2:R:96:CYS:HB3	3:B:157:GLN:HG3	1.98	0.45
3:B:173:CYS:N	3:B:198:LEU:HD21	2.32	0.45
3:G:371:SER:OG	3:F:80:ARG:NH2	2.47	0.45
3:F:173:CYS:N	3:F:198:LEU:HD21	2.32	0.45
3:A:133:ALA:HB1	3:A:308:HIS:HB2	1.97	0.45
1:P:301:ASP:HB3	1:P:339:ILE:HD11	1.98	0.45
2:T:47:GLU:HG2	2:T:49:THR:H	1.81	0.45
3:G:150:GLN:HE22	3:G:283:ARG:HA	1.81	0.45
3:H:128:PHE:HD2	3:H:131:LEU:HD13	1.81	0.45
3:E:397:ASP:OD1	3:E:432:ARG:NH2	2.49	0.45
1:K:262:ALA:HB2	1:L:223:ILE:HG13	1.98	0.45
3:C:397:ASP:OD1	3:C:432:ARG:NH2	2.50	0.45
3:D:59:ALA:HB2	3:D:102:ILE:HD12	1.99	0.45
3:H:191:TYR:CZ	3:H:228:LYS:HE3	2.51	0.45
1:M:237:LEU:HD23	1:M:335:LEU:HG	1.99	0.45
1:M:270:LEU:HB3	1:N:353:THR:HB	1.99	0.45
3:C:150:GLN:HE22	3:C:283:ARG:HA	1.81	0.45
2:R:46:SER:O	2:R:46:SER:OG	2.32	0.45
2:Q:13:LEU:HD13	2:Q:16:LEU:HD21	1.99	0.45
3:A:150:GLN:HE22	3:A:283:ARG:HA	1.81	0.45
1:O:270:LEU:HB3	1:P:353:THR:HB	1.99	0.45
2:X:55:LEU:HD21	2:X:59:PRO:HD3	1.98	0.45
3:G:182:SER:H	2:Q:95:GLN:NE2	2.14	0.45
2:X:10:TYR:O	2:X:14:SER:OG	2.33	0.45
1:O:245:GLU:HG2	1:O:250:ARG:HG3	1.98	0.45
1:O:257:GLU:HA	1:P:255:SER:HA	1.98	0.45
3:H:173:CYS:N	3:H:198:LEU:HD21	2.32	0.45
3:E:146:ILE:HG12	3:E:321:LEU:HD21	1.98	0.45
1:L:357:TRP:HE3	3:D:128:PHE:HZ	1.65	0.45
1:I:254:PHE:HD2	1:I:260:TRP:HZ3	1.64	0.45
1:I:270:LEU:HB3	1:J:353:THR:HB	1.99	0.45
3:A:110:GLU:HB2	3:A:116:ASN:HD22	1.82	0.45
2:W:32:LEU:HD13	2:W:65:THR:HA	1.99	0.45
3:E:110:GLU:HB2	3:E:116:ASN:HD22	1.81	0.45
3:F:332:VAL:HG21	3:F:394:ILE:HG21	1.98	0.45
3:C:302:ILE:HD11	3:C:315:LEU:HD11	1.99	0.45
3:A:397:ASP:OD1	3:A:432:ARG:NH2	2.50	0.45
3:B:80:ARG:NH1	3:B:81:TYR:OH	2.50	0.45
3:B:152:PRO:O	3:B:286:ARG:NH1	2.46	0.45

Continued on next page...

Continued from previous page...

Atom-1	Atom-2	Interatomic distance (Å)	Clash overlap (Å)
3:D:332:VAL:HG21	3:D:394:ILE:HG21	1.99	0.44
3:A:171:LEU:HD21	3:A:425:LEU:HD22	1.99	0.44
3:G:58:VAL:HG12	3:G:131:LEU:HD21	1.99	0.44
3:E:58:VAL:HG12	3:E:131:LEU:HD21	2.00	0.44
1:L:281:THR:OG1	1:L:283:ASP:OD1	2.30	0.44
3:B:332:VAL:HG21	3:B:394:ILE:HG21	1.99	0.44
2:T:13:LEU:HD13	2:T:16:LEU:HD21	1.99	0.44
2:T:55:LEU:HD21	2:T:59:PRO:HD3	1.98	0.44
2:W:3:THR:HB	2:V:57:LYS:HG2	1.99	0.44
3:G:397:ASP:OD1	3:G:432:ARG:NH2	2.50	0.44
1:M:257:GLU:HA	1:N:255:SER:HA	2.00	0.44
1:N:301:ASP:HB3	1:N:339:ILE:HD11	2.00	0.44
3:F:191:TYR:CZ	3:F:228:LYS:HE3	2.52	0.44
3:F:256:GLU:OE2	3:F:284:TRP:NE1	2.45	0.44
2:X:11:GLU:HG2	2:X:48:PRO:HG3	1.99	0.44
2:Q:47:GLU:HG2	2:Q:49:THR:H	1.82	0.44
1:O:254:PHE:HD2	1:O:260:TRP:HZ3	1.64	0.44
3:E:143:VAL:HG13	3:E:370:ALA:HB2	2.00	0.44
3:E:257:TYR:HA	3:E:260:GLU:HG2	1.99	0.44
3:E:304:ARG:HD3	3:F:127:GLY:HA2	1.99	0.44
1:K:270:LEU:HB3	1:L:353:THR:HB	1.99	0.44
2:Y:56:TRP:HH2	2:Y:79:GLN:HG2	1.81	0.44
3:A:58:VAL:HG12	3:A:131:LEU:HD21	1.99	0.44
3:B:206:ASN:OD1	3:B:206:ASN:N	2.38	0.44
1:P:357:TRP:HE3	3:H:128:PHE:HZ	1.66	0.44
3:G:293:HIS:HA	3:G:326:HIS:HB2	2.00	0.44
3:H:80:ARG:NH1	3:H:81:TYR:OH	2.51	0.44
3:C:173:CYS:H	3:C:198:LEU:HD21	1.82	0.44
1:I:262:ALA:HB2	1:J:223:ILE:HG13	1.98	0.44
3:G:278:ASN:HD21	3:G:294:ILE:HD11	1.83	0.44
3:H:302:ILE:O	3:H:310:ILE:N	2.49	0.44
3:H:384:HIS:HB3	3:H:407:THR:HG21	1.99	0.44
2:U:47:GLU:HG2	2:U:49:THR:H	1.82	0.44
3:A:257:TYR:HA	3:A:260:GLU:HG2	1.99	0.44
1:P:223:ILE:HA	1:P:262:ALA:HA	2.00	0.44
1:P:237:LEU:HD23	1:P:335:LEU:HD13	1.99	0.44
3:E:150:GLN:HE22	3:E:283:ARG:HA	1.82	0.44
3:F:128:PHE:HD2	3:F:131:LEU:HD13	1.81	0.44
1:L:334:ILE:HG22	1:L:336:GLY:H	1.83	0.44
2:X:95:GLN:NE2	3:A:182:SER:H	2.16	0.44
3:C:58:VAL:HG12	3:C:131:LEU:HD21	2.00	0.44

Continued on next page...

Continued from previous page...

Atom-1	Atom-2	Interatomic distance (Å)	Clash overlap (Å)
3:D:146:ILE:HG23	3:D:372:LEU:HD22	2.00	0.44
3:A:246:PRO:HB3	3:B:113:SER:HA	2.00	0.44
3:E:246:PRO:HB3	3:F:113:SER:HA	2.00	0.44
2:W:96:CYS:HB3	3:H:157:GLN:HG3	2.00	0.44
3:G:136:LEU:HG	3:G:314:VAL:HG21	2.00	0.44
3:G:143:VAL:HG13	3:G:370:ALA:HB2	2.00	0.44
3:G:171:LEU:HD21	3:G:425:LEU:HD22	2.00	0.44
3:G:246:PRO:HB3	3:H:113:SER:HA	2.00	0.44
3:E:136:LEU:HG	3:E:314:VAL:HG21	1.98	0.44
3:A:293:HIS:HA	3:A:326:HIS:HB2	2.00	0.44
3:G:257:TYR:HA	3:G:260:GLU:HG2	1.99	0.43
3:H:332:VAL:HG21	3:H:394:ILE:HG21	1.99	0.43
2:V:26:LYS:HE2	3:F:434:GLU:HB3	2.00	0.43
3:E:410:HIS:CE1	3:E:459:ALA:HB2	2.53	0.43
3:C:246:PRO:HB3	3:D:113:SER:HA	2.00	0.43
3:C:257:TYR:HA	3:C:260:GLU:HG2	2.00	0.43
3:D:128:PHE:HD2	3:D:131:LEU:HD13	1.82	0.43
3:B:146:ILE:HG23	3:B:372:LEU:HD22	2.00	0.43
3:B:355:VAL:HG23	3:B:367:GLN:HB3	2.00	0.43
3:H:146:ILE:HG23	3:H:372:LEU:HD22	2.00	0.43
1:M:221:PRO:HD3	1:N:264:PRO:HG3	2.00	0.43
1:N:237:LEU:HD23	1:N:335:LEU:HD13	2.01	0.43
3:C:110:GLU:HB2	3:C:116:ASN:HD22	1.82	0.43
3:D:173:CYS:N	3:D:198:LEU:HD21	2.32	0.43
2:V:96:CYS:HB3	3:F:157:GLN:HG3	1.99	0.43
1:L:237:LEU:HD23	1:L:335:LEU:HD13	2.00	0.43
2:R:40:VAL:HB	2:R:56:TRP:HB3	1.99	0.43
2:Y:46:SER:O	2:Y:46:SER:OG	2.32	0.43
3:C:410:HIS:CE1	3:C:459:ALA:HB2	2.53	0.43
3:D:355:VAL:HG23	3:D:367:GLN:HB3	2.00	0.43
1:I:237:LEU:HD23	1:I:335:LEU:HG	2.00	0.43
3:B:191:TYR:CZ	3:B:228:LYS:HE3	2.54	0.43
2:W:88:VAL:HG12	2:W:100:SER:HA	2.00	0.43
3:G:302:ILE:HD11	3:G:315:LEU:HD11	1.99	0.43
3:G:410:HIS:CE1	3:G:459:ALA:HB2	2.53	0.43
3:E:294:ILE:HG21	3:E:319:LEU:HD13	1.99	0.43
3:F:146:ILE:HG23	3:F:372:LEU:HD22	2.00	0.43
1:K:254:PHE:HD2	1:K:260:TRP:HZ3	1.65	0.43
3:D:203:ASP:OD2	3:D:218:ARG:NE	2.52	0.43
1:I:305:ARG:HH12	1:I:335:LEU:HD12	1.84	0.43
3:A:326:HIS:HA	3:A:376:MET:HB2	2.00	0.43

Continued on next page...

Continued from previous page...

Atom-1	Atom-2	Interatomic distance (Å)	Clash overlap (Å)
3:H:143:VAL:HG13	3:H:370:ALA:HB2	2.01	0.43
3:E:171:LEU:HD21	3:E:425:LEU:HD22	2.00	0.43
3:C:171:LEU:HD21	3:C:425:LEU:HD22	2.00	0.43
1:O:237:LEU:HD23	1:O:335:LEU:HG	1.99	0.43
2:V:85:ILE:HB	2:V:104:HIS:HB3	2.00	0.43
2:Y:47:GLU:HB3	2:Y:50:GLU:HB3	2.00	0.43
3:A:179:LEU:HD23	3:B:64:THR:HG22	2.01	0.43
1:P:222:ARG:NH1	1:P:272:ALA:O	2.46	0.43
3:H:355:VAL:HG23	3:H:367:GLN:HB3	2.00	0.43
1:N:223:ILE:HA	1:N:262:ALA:HA	1.99	0.43
1:K:260:TRP:HZ2	1:L:260:TRP:HB2	1.83	0.43
2:X:80:TYR:HB3	2:X:83:HIS:HB2	2.00	0.43
3:C:302:ILE:HG21	3:C:302:ILE:HD13	1.78	0.43
3:D:191:TYR:CZ	3:D:228:LYS:HE3	2.54	0.43
2:Q:19:LEU:H	2:Q:19:LEU:HG	1.64	0.43
3:B:88:ILE:HD13	3:B:88:ILE:HA	1.89	0.43
2:V:46:SER:O	2:V:46:SER:OG	2.32	0.43
3:F:203:ASP:OD2	3:F:218:ARG:NE	2.52	0.43
3:C:82:LYS:HE2	3:C:84:ARG:HH11	1.83	0.43
3:D:143:VAL:HG13	3:D:370:ALA:HB2	2.01	0.43
1:J:237:LEU:HD23	1:J:335:LEU:HD13	2.00	0.43
3:A:302:ILE:HD11	3:A:315:LEU:HD11	1.99	0.43
3:A:410:HIS:CE1	3:A:459:ALA:HB2	2.53	0.43
3:B:203:ASP:OD2	3:B:218:ARG:NE	2.52	0.43
2:T:12:THR:HG23	3:G:168:ARG:HD3	2.01	0.43
2:V:47:GLU:HB3	2:V:50:GLU:HB3	2.01	0.43
3:E:293:HIS:HA	3:E:326:HIS:HB2	2.01	0.43
3:E:312:PHE:O	3:E:316:ALA:N	2.51	0.43
3:F:410:HIS:CE1	3:F:459:ALA:HB2	2.54	0.43
3:C:41:PHE:HB3	3:C:134:LEU:HD11	2.01	0.43
3:C:136:LEU:HG	3:C:314:VAL:HG21	2.01	0.43
3:C:293:HIS:HA	3:C:326:HIS:HB2	2.01	0.43
1:J:334:ILE:HG22	1:J:336:GLY:H	1.84	0.43
3:A:294:ILE:HG21	3:A:319:LEU:HD13	2.00	0.43
3:H:410:HIS:CE1	3:H:459:ALA:HB2	2.54	0.42
2:X:9:ARG:HB3	2:X:15:TYR:CE1	2.54	0.42
3:D:110:GLU:HB2	3:D:116:ASN:HD22	1.84	0.42
3:D:152:PRO:O	3:D:286:ARG:NH1	2.45	0.42
1:I:260:TRP:HZ2	1:J:260:TRP:HB2	1.83	0.42
3:B:207:ILE:O	3:B:242:ASN:ND2	2.50	0.42
3:A:143:VAL:HG13	3:A:370:ALA:HB2	2.00	0.42

Continued on next page...

Continued from previous page...

Atom-1	Atom-2	Interatomic distance (Å)	Clash overlap (Å)
1:O:260:TRP:HZ2	1:P:260:TRP:HB2	1.84	0.42
3:H:203:ASP:OD2	3:H:218:ARG:NE	2.52	0.42
3:E:191:TYR:HB2	3:E:225:ALA:HB1	2.02	0.42
3:E:326:HIS:HA	3:E:376:MET:HB2	2.00	0.42
3:F:143:VAL:HG13	3:F:370:ALA:HB2	2.01	0.42
1:L:254:PHE:HB2	1:L:260:TRP:CH2	2.55	0.42
2:X:46:SER:O	2:X:46:SER:OG	2.31	0.42
3:C:143:VAL:HG13	3:C:370:ALA:HB2	2.00	0.42
3:F:110:GLU:HB2	3:F:116:ASN:HD22	1.84	0.42
1:L:329:LYS:HD2	1:L:330:PRO:HD2	2.01	0.42
1:L:340:ILE:HD12	1:L:340:ILE:HA	1.94	0.42
3:D:410:HIS:CE1	3:D:459:ALA:HB2	2.54	0.42
3:B:110:GLU:HB2	3:B:116:ASN:HD22	1.84	0.42
3:G:41:PHE:HB3	3:G:134:LEU:HD11	2.02	0.42
3:F:206:ASN:N	3:F:206:ASN:OD1	2.38	0.42
1:J:254:PHE:HB2	1:J:260:TRP:CH2	2.55	0.42
2:R:56:TRP:HH2	2:R:79:GLN:HG2	1.85	0.42
3:A:302:ILE:HD13	3:A:302:ILE:HG21	1.78	0.42
3:C:326:HIS:HA	3:C:376:MET:HB2	2.00	0.42
2:R:9:ARG:HG3	2:R:15:TYR:CZ	2.55	0.42
3:B:143:VAL:HG13	3:B:370:ALA:HB2	2.02	0.42
1:O:221:PRO:HD3	1:P:264:PRO:HG3	2.01	0.42
3:G:326:HIS:HA	3:G:376:MET:HB2	2.00	0.42
3:H:80:ARG:NH2	3:A:371:SER:OG	2.50	0.42
3:H:207:ILE:O	3:H:242:ASN:ND2	2.49	0.42
2:R:15:TYR:HB3	3:B:423:VAL:HG22	2.00	0.42
2:Q:36:TYR:HD1	2:Q:91:ASP:HA	1.83	0.42
3:G:294:ILE:HG21	3:G:319:LEU:HD13	2.01	0.42
3:F:355:VAL:HG23	3:F:367:GLN:HB3	2.01	0.42
1:K:237:LEU:HD23	1:K:335:LEU:HG	2.00	0.42
2:X:82:GLY:HA2	2:X:106:PRO:HB3	2.02	0.42
2:Q:12:THR:HG23	3:A:168:ARG:HD3	2.01	0.42
3:G:191:TYR:HB2	3:G:225:ALA:HB1	2.02	0.42
3:H:197:GLY:HA3	3:H:422:ARG:HG2	2.02	0.42
3:E:204:ASP:HB2	3:E:207:ILE:HG12	2.02	0.42
1:K:278:ILE:HD12	1:K:300:VAL:HG21	2.02	0.42
1:L:301:ASP:HB3	1:L:339:ILE:HD11	2.02	0.42
3:B:294:ILE:HG22	3:B:327:ILE:HD13	2.02	0.42
1:O:266:TRP:CE2	3:H:47:PRO:HG2	2.55	0.42
1:P:281:THR:OG1	1:P:283:ASP:OD1	2.29	0.42
3:G:204:ASP:HB2	3:G:207:ILE:HG12	2.02	0.42

Continued on next page...

Continued from previous page...

Atom-1	Atom-2	Interatomic distance (Å)	Clash overlap (Å)
3:H:138:ASP:OD1	3:H:317:LYS:NZ	2.36	0.42
3:H:256:GLU:OE2	3:H:284:TRP:NE1	2.45	0.42
1:M:305:ARG:HH12	1:M:335:LEU:HD12	1.85	0.42
3:E:205:GLU:HB3	3:F:119:THR:HG22	2.01	0.42
2:Y:9:ARG:HG3	2:Y:15:TYR:CZ	2.55	0.42
3:C:138:ASP:HB3	3:C:364:TYR:HB2	2.02	0.42
3:D:294:ILE:HG22	3:D:327:ILE:HD13	2.02	0.42
3:D:302:ILE:O	3:D:310:ILE:N	2.49	0.42
1:J:301:ASP:HB3	1:J:339:ILE:HD11	2.02	0.42
3:B:117:VAL:HG13	3:B:121:ILE:HD12	2.02	0.42
3:B:197:GLY:HA3	3:B:422:ARG:HG2	2.01	0.42
3:H:110:GLU:HB2	3:H:116:ASN:HD22	1.85	0.41
2:U:12:THR:HG23	3:E:168:ARG:HD3	2.02	0.41
3:F:197:GLY:HA3	3:F:422:ARG:HG2	2.02	0.41
3:C:294:ILE:HG21	3:C:319:LEU:HD13	2.01	0.41
1:I:237:LEU:HD12	1:I:237:LEU:HA	1.92	0.41
3:B:77:ASP:OD1	3:B:77:ASP:N	2.44	0.41
3:B:410:HIS:CE1	3:B:459:ALA:HB2	2.54	0.41
1:O:305:ARG:HH12	1:O:335:LEU:HD12	1.85	0.41
1:P:329:LYS:HD2	1:P:330:PRO:HD2	2.01	0.41
1:M:260:TRP:HZ2	1:N:260:TRP:HB2	1.85	0.41
3:E:107:ASP:N	3:E:107:ASP:OD1	2.54	0.41
3:E:177:PRO:HD2	3:E:181:LEU:HD11	2.02	0.41
3:F:117:VAL:HG13	3:F:121:ILE:HD12	2.02	0.41
2:Y:15:TYR:HB3	3:D:423:VAL:HG22	2.02	0.41
3:A:136:LEU:HG	3:A:314:VAL:HG21	2.01	0.41
3:B:302:ILE:O	3:B:310:ILE:N	2.49	0.41
3:H:117:VAL:HG13	3:H:121:ILE:HD12	2.03	0.41
1:N:330:PRO:HB2	1:N:332:PHE:HD2	1.86	0.41
3:H:175:ILE:HD13	3:H:175:ILE:HA	1.88	0.41
3:B:302:ILE:HD13	3:B:302:ILE:HG21	1.80	0.41
1:M:316:ASP:N	1:M:316:ASP:OD1	2.54	0.41
1:N:221:PRO:HB3	1:N:264:PRO:HA	2.02	0.41
3:E:371:SER:OG	3:D:80:ARG:NH2	2.53	0.41
3:F:42:ARG:N	3:F:135:ARG:O	2.54	0.41
1:K:224:VAL:HG12	1:K:275:PRO:HG2	2.02	0.41
3:C:191:TYR:HB2	3:C:225:ALA:HB1	2.02	0.41
1:I:266:TRP:CE2	3:B:47:PRO:HG2	2.56	0.41
3:A:41:PHE:HB3	3:A:134:LEU:HD11	2.01	0.41
3:A:294:ILE:HD13	3:A:294:ILE:HA	1.87	0.41
1:O:225:PRO:O	1:O:277:THR:N	2.54	0.41

Continued on next page...

Continued from previous page...

Atom-1	Atom-2	Interatomic distance (Å)	Clash overlap (Å)
3:E:138:ASP:HB3	3:E:364:TYR:HB2	2.02	0.41
3:E:302:ILE:HD13	3:E:302:ILE:HG21	1.77	0.41
3:F:243:VAL:HG21	3:F:266:ILE:HD12	2.02	0.41
1:J:329:LYS:HD2	1:J:330:PRO:HD2	2.02	0.41
3:B:243:VAL:HG21	3:B:266:ILE:HD12	2.02	0.41
1:O:342:VAL:HG12	1:P:212:PHE:HD2	1.85	0.41
3:H:319:LEU:HD21	3:H:327:ILE:HG12	2.03	0.41
3:H:410:HIS:CD2	3:H:412:TRP:H	2.39	0.41
3:E:379:ALA:HB2	3:E:395:PHE:CE2	2.56	0.41
3:F:152:PRO:O	3:F:286:ARG:NH1	2.46	0.41
3:F:207:ILE:O	3:F:242:ASN:ND2	2.50	0.41
3:F:294:ILE:HG22	3:F:327:ILE:HD13	2.02	0.41
2:Y:56:TRP:CD1	2:Y:57:LYS:HG3	2.55	0.41
3:C:204:ASP:HB2	3:C:207:ILE:HG12	2.03	0.41
3:D:197:GLY:HA3	3:D:422:ARG:HG2	2.01	0.41
1:I:278:ILE:HD12	1:I:300:VAL:HG21	2.02	0.41
3:A:126:PHE:CD2	3:B:301:VAL:HG22	2.55	0.41
3:A:379:ALA:HB2	3:A:395:PHE:CE2	2.55	0.41
3:A:386:TRP:NE1	3:A:460:CYS:O	2.43	0.41
3:A:414:ASN:O	3:A:418:ALA:N	2.53	0.41
3:B:319:LEU:HD21	3:B:327:ILE:HG12	2.03	0.41
1:M:266:TRP:CE2	3:F:47:PRO:HG2	2.55	0.41
1:M:278:ILE:HD12	1:M:300:VAL:HG21	2.02	0.41
3:E:321:LEU:HD23	3:E:321:LEU:HA	1.92	0.41
3:F:319:LEU:HD21	3:F:327:ILE:HG12	2.03	0.41
1:L:288:GLN:NE2	1:L:343:ARG:HH22	2.19	0.41
1:I:221:PRO:HD3	1:J:264:PRO:HG3	2.02	0.41
1:O:278:ILE:HD12	1:O:300:VAL:HG21	2.02	0.41
2:T:19:LEU:H	2:T:19:LEU:HG	1.65	0.41
2:T:36:TYR:HD1	2:T:91:ASP:HA	1.86	0.41
2:W:9:ARG:HG3	2:W:15:TYR:CZ	2.56	0.41
2:W:85:ILE:HB	2:W:104:HIS:HB3	2.03	0.41
3:G:202:LYS:HG3	3:G:240:TYR:HD2	1.86	0.41
3:H:42:ARG:N	3:H:135:ARG:O	2.54	0.41
3:H:243:VAL:HG21	3:H:266:ILE:HD12	2.02	0.41
3:H:414:ASN:O	3:H:418:ALA:N	2.53	0.41
1:M:226:VAL:HG21	1:N:251:LEU:HD11	2.03	0.41
1:N:254:PHE:HB2	1:N:260:TRP:CH2	2.55	0.41
1:N:281:THR:OG1	1:N:283:ASP:OD1	2.29	0.41
2:U:31:ILE:HG12	2:U:99:LEU:HD13	2.03	0.41
3:E:126:PHE:CD2	3:F:301:VAL:HG22	2.55	0.41

Continued on next page...

Continued from previous page...

Atom-1	Atom-2	Interatomic distance (Å)	Clash overlap (Å)
3:F:302:ILE:O	3:F:310:ILE:N	2.49	0.41
1:K:237:LEU:HD12	1:K:237:LEU:HA	1.92	0.41
1:K:305:ARG:HH12	1:K:335:LEU:HD12	1.85	0.41
2:X:19:LEU:H	2:X:19:LEU:HG	1.64	0.41
3:C:42:ARG:HB3	3:C:135:ARG:HB3	2.03	0.41
3:C:88:ILE:HD13	3:C:88:ILE:HA	1.92	0.41
3:C:126:PHE:CD2	3:D:301:VAL:HG22	2.55	0.41
3:D:87:ASP:HB3	3:D:101:TYR:HD2	1.85	0.41
3:D:139:ILE:HG22	3:D:314:VAL:HG22	2.03	0.41
3:D:243:VAL:HG21	3:D:266:ILE:HD12	2.02	0.41
1:I:226:VAL:HG21	1:J:251:LEU:HD11	2.02	0.41
1:I:257:GLU:HA	1:J:255:SER:HA	2.03	0.41
1:J:288:GLN:NE2	1:J:343:ARG:HH22	2.19	0.41
3:A:55:ALA:HA	3:A:58:VAL:HG22	2.03	0.41
3:A:191:TYR:HB2	3:A:225:ALA:HB1	2.02	0.41
3:A:205:GLU:HB3	3:B:119:THR:HG22	2.03	0.41
3:B:410:HIS:CD2	3:B:412:TRP:H	2.39	0.41
3:B:414:ASN:O	3:B:418:ALA:N	2.53	0.41
1:P:254:PHE:HB2	1:P:260:TRP:CH2	2.55	0.41
1:P:288:GLN:NE2	1:P:343:ARG:HH22	2.19	0.41
2:U:36:TYR:HD1	2:U:91:ASP:HA	1.85	0.41
2:V:37:ILE:O	2:V:90:PHE:N	2.54	0.41
3:E:270:TYR:HB3	3:E:294:ILE:HG23	2.02	0.41
3:F:410:HIS:CD2	3:F:412:TRP:H	2.39	0.41
2:Y:10:TYR:HB3	2:Y:102:ILE:HD12	2.03	0.41
3:B:42:ARG:N	3:B:135:ARG:O	2.54	0.41
1:O:224:VAL:HG12	1:O:275:PRO:HG2	2.02	0.40
3:E:41:PHE:HB3	3:E:134:LEU:HD11	2.02	0.40
3:E:42:ARG:HB3	3:E:135:ARG:HB3	2.03	0.40
3:F:139:ILE:HG22	3:F:314:VAL:HG22	2.03	0.40
3:F:302:ILE:HD13	3:F:302:ILE:HG21	1.80	0.40
3:D:42:ARG:N	3:D:135:ARG:O	2.54	0.40
3:G:55:ALA:HA	3:G:58:VAL:HG22	2.04	0.40
3:E:202:LYS:HG3	3:E:240:TYR:HD2	1.86	0.40
3:E:243:VAL:HG21	3:E:266:ILE:HD12	2.03	0.40
3:C:379:ALA:HB2	3:C:395:PHE:CE2	2.55	0.40
1:P:340:ILE:HD12	1:P:340:ILE:HA	1.96	0.40
3:G:42:ARG:HB3	3:G:135:ARG:HB3	2.03	0.40
3:G:126:PHE:CD2	3:H:301:VAL:HG22	2.55	0.40
3:E:141:PHE:O	3:E:367:GLN:NE2	2.52	0.40
3:F:41:PHE:HB3	3:F:134:LEU:HD11	2.04	0.40

Continued on next page...

Continued from previous page...

Atom-1	Atom-2	Interatomic distance (Å)	Clash overlap (Å)
3:F:80:ARG:NH1	3:F:81:TYR:OH	2.54	0.40
1:K:266:TRP:CE2	3:D:47:PRO:HG2	2.56	0.40
3:D:319:LEU:HD21	3:D:327:ILE:HG12	2.03	0.40
1:I:225:PRO:O	1:I:277:THR:N	2.54	0.40
3:A:274:GLY:HA3	3:B:274:GLY:HA3	2.02	0.40
3:H:87:ASP:HB3	3:H:101:TYR:HD2	1.86	0.40
2:U:17:PRO:HA	2:U:18:PRO:HD3	1.94	0.40
2:X:4:LEU:O	3:C:195:ARG:NH2	2.52	0.40
3:C:77:ASP:OD1	3:C:77:ASP:N	2.54	0.40
3:C:274:GLY:HA3	3:D:274:GLY:HA3	2.02	0.40
3:D:410:HIS:CD2	3:D:412:TRP:H	2.39	0.40
3:A:204:ASP:HB2	3:A:207:ILE:HG12	2.02	0.40
1:O:226:VAL:HG21	1:P:251:LEU:HD11	2.02	0.40
3:G:379:ALA:HB2	3:G:395:PHE:CE2	2.56	0.40
3:H:77:ASP:OD1	3:H:77:ASP:N	2.46	0.40
2:V:15:TYR:HB3	3:F:423:VAL:HG22	2.03	0.40
3:E:206:ASN:OD1	3:E:206:ASN:N	2.53	0.40
3:F:293:HIS:HE2	3:F:328:HIS:HE2	1.70	0.40
1:I:316:ASP:N	1:I:316:ASP:OD1	2.54	0.40
3:A:58:VAL:HG23	3:A:102:ILE:HD11	2.03	0.40
3:A:202:LYS:HG3	3:A:240:TYR:HD2	1.86	0.40

There are no symmetry-related clashes.

5.3 Torsion angles [\(i\)](#)

5.3.1 Protein backbone [\(i\)](#)

In the following table, the Percentiles column shows the percent Ramachandran outliers of the chain as a percentile score with respect to all PDB entries followed by that with respect to all EM entries.

The Analysed column shows the number of residues for which the backbone conformation was analysed, and the total number of residues.

Mol	Chain	Analysed	Favoured	Allowed	Outliers	Percentiles	
1	I	139/159 (87%)	129 (93%)	10 (7%)	0	100	100
1	J	155/159 (98%)	146 (94%)	9 (6%)	0	100	100
1	K	139/159 (87%)	129 (93%)	10 (7%)	0	100	100
1	L	155/159 (98%)	146 (94%)	9 (6%)	0	100	100

Continued on next page...

Continued from previous page...

Mol	Chain	Analysed	Favoured	Allowed	Outliers	Percentiles	
1	M	139/159 (87%)	129 (93%)	10 (7%)	0	100	100
1	N	155/159 (98%)	146 (94%)	9 (6%)	0	100	100
1	O	139/159 (87%)	129 (93%)	10 (7%)	0	100	100
1	P	155/159 (98%)	144 (93%)	11 (7%)	0	100	100
2	Q	104/109 (95%)	89 (86%)	15 (14%)	0	100	100
2	R	103/109 (94%)	93 (90%)	10 (10%)	0	100	100
2	T	104/109 (95%)	89 (86%)	15 (14%)	0	100	100
2	U	104/109 (95%)	88 (85%)	16 (15%)	0	100	100
2	V	103/109 (94%)	92 (89%)	11 (11%)	0	100	100
2	W	103/109 (94%)	93 (90%)	10 (10%)	0	100	100
2	X	104/109 (95%)	89 (86%)	15 (14%)	0	100	100
2	Y	103/109 (94%)	95 (92%)	8 (8%)	0	100	100
3	A	426/476 (90%)	396 (93%)	30 (7%)	0	100	100
3	B	430/476 (90%)	401 (93%)	29 (7%)	0	100	100
3	C	428/476 (90%)	399 (93%)	29 (7%)	0	100	100
3	D	430/476 (90%)	398 (93%)	32 (7%)	0	100	100
3	E	426/476 (90%)	397 (93%)	28 (7%)	1 (0%)	44	72
3	F	430/476 (90%)	401 (93%)	28 (6%)	1 (0%)	44	72
3	G	426/476 (90%)	396 (93%)	29 (7%)	1 (0%)	44	72
3	H	430/476 (90%)	400 (93%)	29 (7%)	1 (0%)	44	72
All	All	5430/5952 (91%)	5014 (92%)	412 (8%)	4 (0%)	50	77

All (4) Ramachandran outliers are listed below:

Mol	Chain	Res	Type
3	G	64	THR
3	H	64	THR
3	E	64	THR
3	F	64	THR

5.3.2 Protein sidechains [i](#)

In the following table, the Percentiles column shows the percent sidechain outliers of the chain as a percentile score with respect to all PDB entries followed by that with respect to all EM entries.

The Analysed column shows the number of residues for which the sidechain conformation was analysed, and the total number of residues.

Mol	Chain	Analysed	Rotameric	Outliers	Percentiles	
1	I	127/145 (88%)	127 (100%)	0	100	100
1	J	143/145 (99%)	143 (100%)	0	100	100
1	K	127/145 (88%)	127 (100%)	0	100	100
1	L	143/145 (99%)	143 (100%)	0	100	100
1	M	127/145 (88%)	127 (100%)	0	100	100
1	N	143/145 (99%)	143 (100%)	0	100	100
1	O	127/145 (88%)	127 (100%)	0	100	100
1	P	143/145 (99%)	143 (100%)	0	100	100
2	Q	99/102 (97%)	98 (99%)	1 (1%)	73	84
2	R	98/102 (96%)	98 (100%)	0	100	100
2	T	99/102 (97%)	98 (99%)	1 (1%)	73	84
2	U	99/102 (97%)	98 (99%)	1 (1%)	73	84
2	V	98/102 (96%)	98 (100%)	0	100	100
2	W	98/102 (96%)	98 (100%)	0	100	100
2	X	99/102 (97%)	98 (99%)	1 (1%)	73	84
2	Y	98/102 (96%)	98 (100%)	0	100	100
3	A	344/386 (89%)	340 (99%)	4 (1%)	67	80
3	B	348/386 (90%)	346 (99%)	2 (1%)	84	91
3	C	346/386 (90%)	343 (99%)	3 (1%)	75	86
3	D	348/386 (90%)	345 (99%)	3 (1%)	75	86
3	E	344/386 (89%)	342 (99%)	2 (1%)	84	91
3	F	348/386 (90%)	346 (99%)	2 (1%)	84	91
3	G	344/386 (89%)	340 (99%)	4 (1%)	67	80
3	H	348/386 (90%)	345 (99%)	3 (1%)	75	86
All	All	4638/5064 (92%)	4611 (99%)	27 (1%)	82	91

All (27) residues with a non-rotameric sidechain are listed below:

Mol	Chain	Res	Type
2	T	19	LEU
3	G	237	LYS
3	G	278	ASN

Continued on next page...

Continued from previous page...

Mol	Chain	Res	Type
3	G	304	ARG
3	G	319	LEU
3	H	237	LYS
3	H	278	ASN
3	H	304	ARG
2	U	19	LEU
3	E	237	LYS
3	E	319	LEU
3	F	237	LYS
3	F	304	ARG
2	X	19	LEU
3	C	237	LYS
3	C	304	ARG
3	C	319	LEU
3	D	84	ARG
3	D	237	LYS
3	D	304	ARG
2	Q	19	LEU
3	A	84	ARG
3	A	237	LYS
3	A	304	ARG
3	A	319	LEU
3	B	237	LYS
3	B	304	ARG

Sometimes sidechains can be flipped to improve hydrogen bonding and reduce clashes. All (46) such sidechains are listed below:

Mol	Chain	Res	Type
1	P	351	ASN
2	T	29	GLN
2	T	95	GLN
3	G	150	GLN
3	G	278	ASN
3	G	308	HIS
3	G	421	ASN
3	H	230	GLN
3	H	263	GLN
3	H	278	ASN
3	H	308	HIS
3	H	357	GLN
3	H	410	HIS
1	N	351	ASN

Continued on next page...

Continued from previous page...

Mol	Chain	Res	Type
2	U	29	GLN
2	U	95	GLN
3	E	150	GLN
3	E	308	HIS
3	E	421	ASN
3	F	230	GLN
3	F	263	GLN
3	F	308	HIS
3	F	357	GLN
3	F	410	HIS
1	L	351	ASN
2	X	29	GLN
2	X	95	GLN
3	C	150	GLN
3	C	308	HIS
3	C	421	ASN
3	D	230	GLN
3	D	263	GLN
3	D	308	HIS
3	D	357	GLN
3	D	410	HIS
1	J	351	ASN
2	Q	29	GLN
2	Q	95	GLN
3	A	150	GLN
3	A	308	HIS
3	A	421	ASN
3	B	230	GLN
3	B	263	GLN
3	B	308	HIS
3	B	357	GLN
3	B	410	HIS

5.3.3 RNA [i](#)

There are no RNA molecules in this entry.

5.4 Non-standard residues in protein, DNA, RNA chains [i](#)

There are no non-standard protein/DNA/RNA residues in this entry.

5.5 Carbohydrates [i](#)

There are no oligosaccharides in this entry.

5.6 Ligand geometry [i](#)

There are no ligands in this entry.

5.7 Other polymers [i](#)

There are no such residues in this entry.

5.8 Polymer linkage issues [i](#)

There are no chain breaks in this entry.

6 Map visualisation [i](#)

This section contains visualisations of the EMDB entry EMD-0959. These allow visual inspection of the internal detail of the map and identification of artifacts.

No raw map or half-maps were deposited for this entry and therefore no images, graphs, etc. pertaining to the raw map can be shown.

6.1 Orthogonal projections [i](#)

6.1.1 Primary map

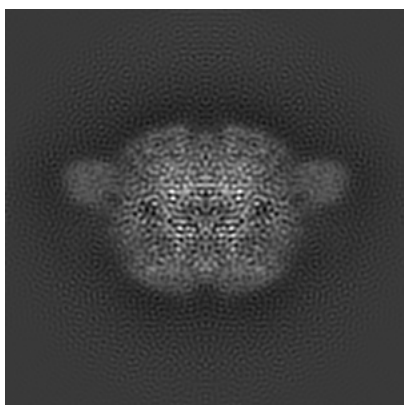

X

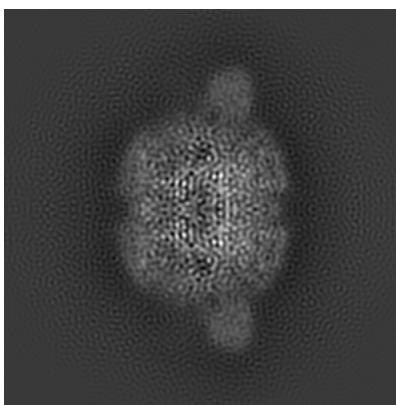

Y

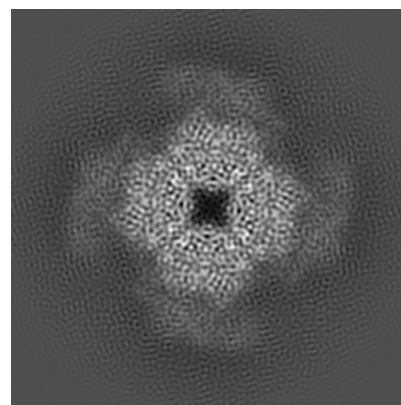

Z

The images above show the map projected in three orthogonal directions.

6.2 Central slices [i](#)

6.2.1 Primary map

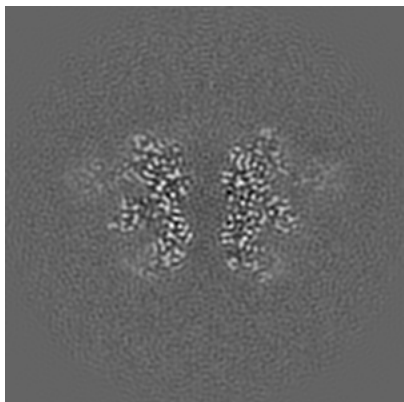

X Index: 120

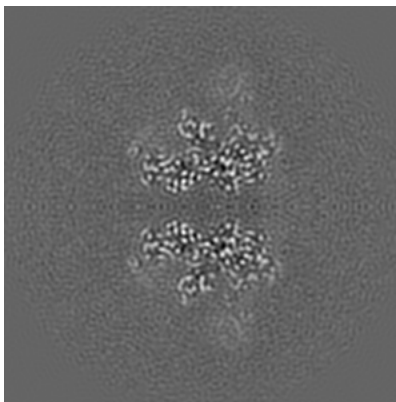

Y Index: 120

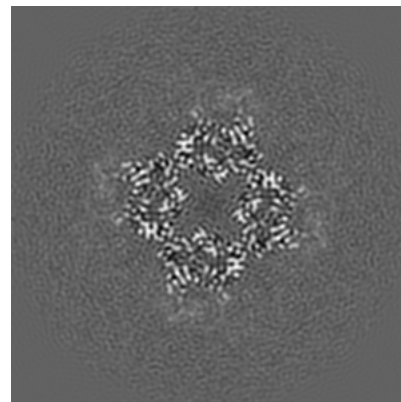

Z Index: 120

The images above show central slices of the map in three orthogonal directions.

6.3 Largest variance slices [i](#)

6.3.1 Primary map

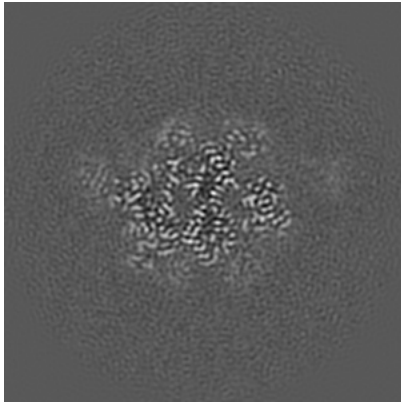

X Index: 102

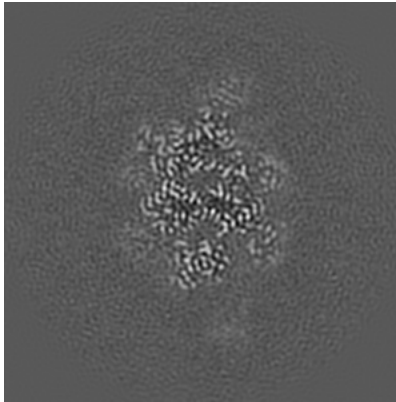

Y Index: 103

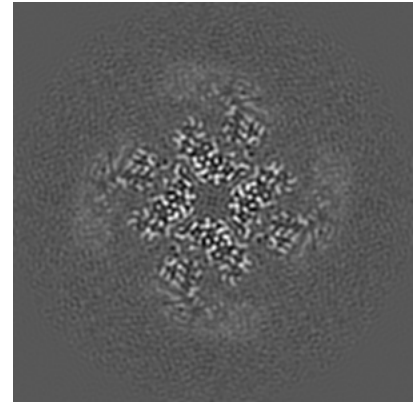

Z Index: 130

The images above show the largest variance slices of the map in three orthogonal directions.

6.4 Orthogonal standard-deviation projections (False-color) [i](#)

6.4.1 Primary map

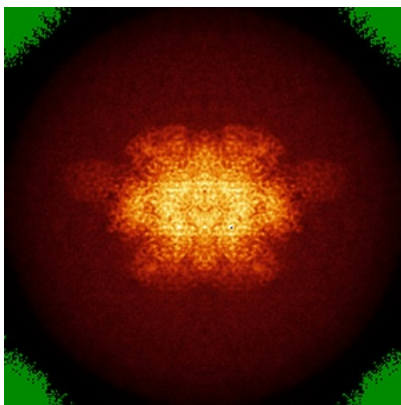

X

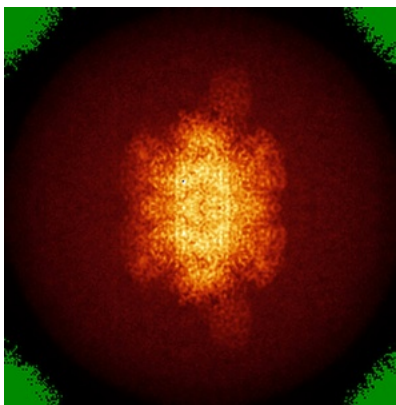

Y

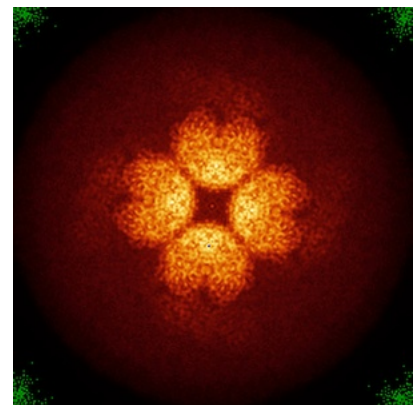

Z

The images above show the map standard deviation projections with false color in three orthogonal directions. Minimum values are shown in green, max in blue, and dark to light orange shades represent small to large values respectively.

6.5 Orthogonal surface views [i](#)

6.5.1 Primary map

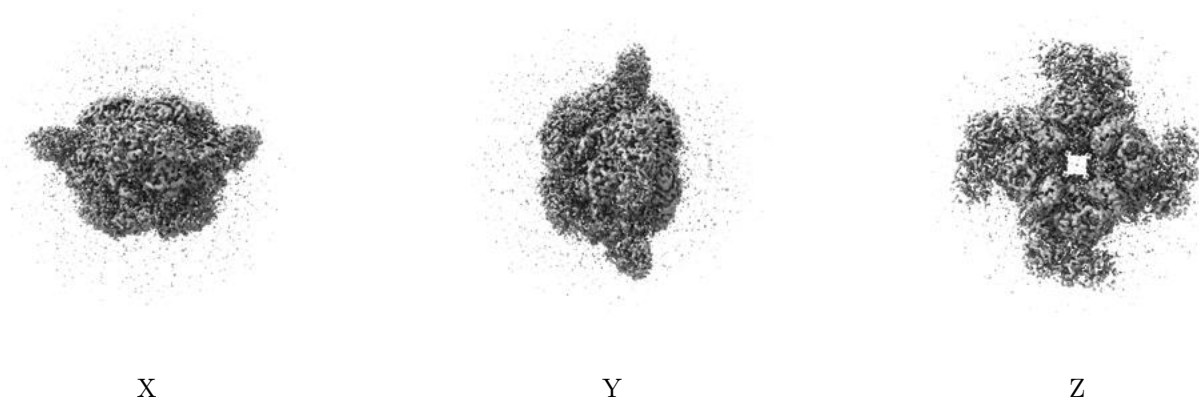

The images above show the 3D surface view of the map at the recommended contour level 0.0209. These images, in conjunction with the slice images, may facilitate assessment of whether an appropriate contour level has been provided.

6.6 Mask visualisation [i](#)

This section was not generated. No masks/segmentation were deposited.

7 Map analysis [i](#)

This section contains the results of statistical analysis of the map.

7.1 Map-value distribution [i](#)

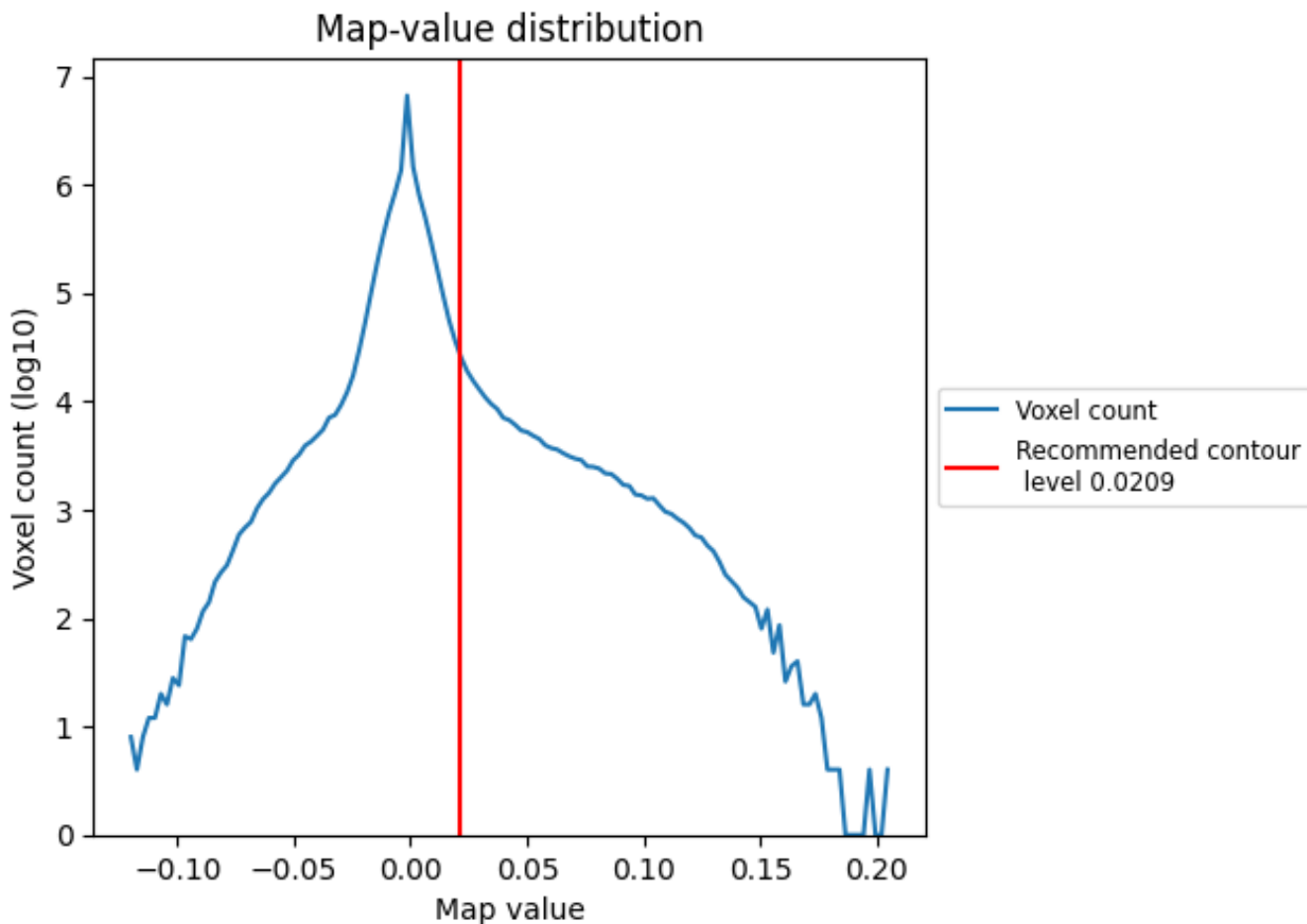

The map-value distribution is plotted in 128 intervals along the x-axis. The y-axis is logarithmic. A spike in this graph at zero usually indicates that the volume has been masked.

7.2 Volume estimate [i](#)

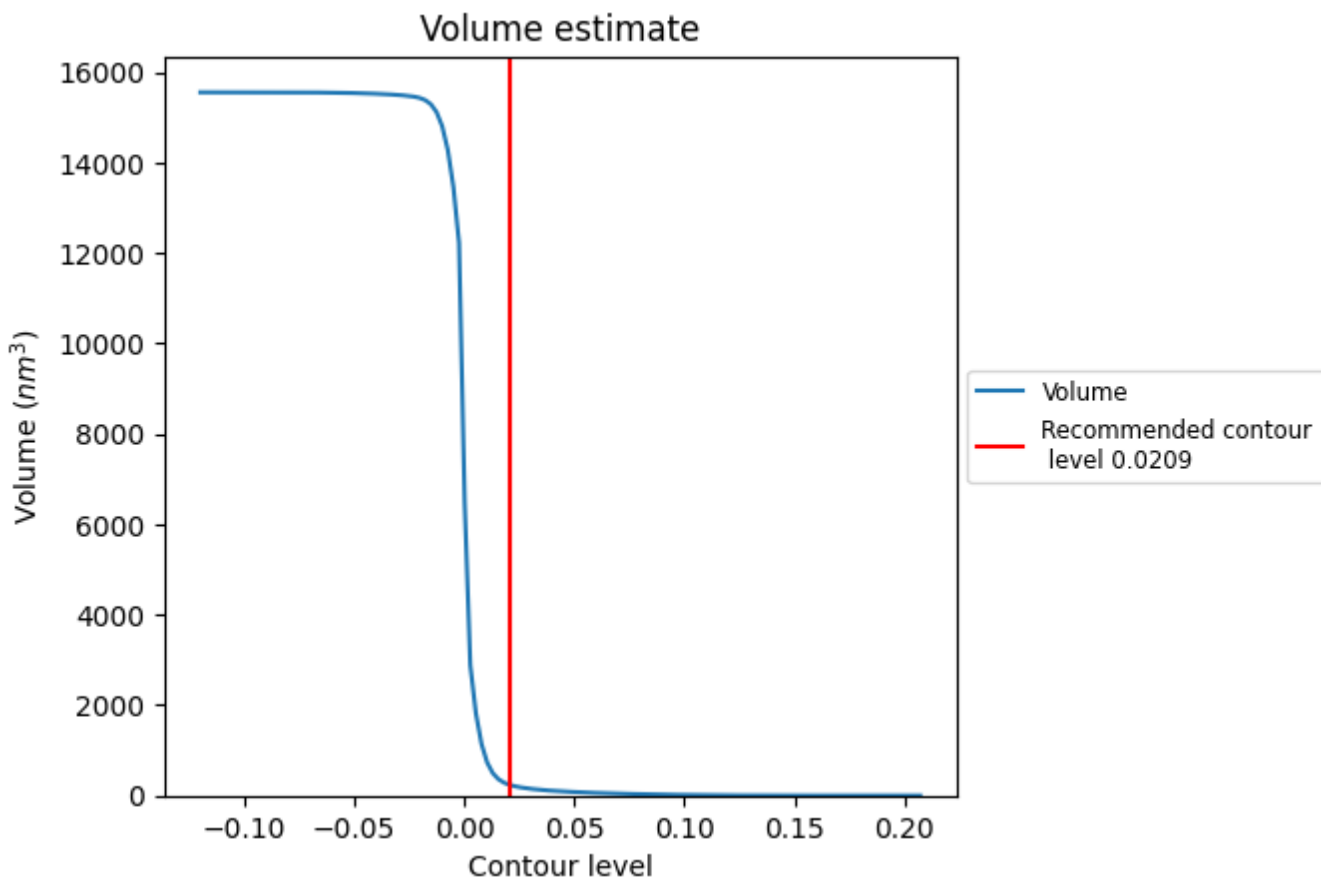

The volume at the recommended contour level is 233 nm³; this corresponds to an approximate mass of 211 kDa.

The volume estimate graph shows how the enclosed volume varies with the contour level. The recommended contour level is shown as a vertical line and the intersection between the line and the curve gives the volume of the enclosed surface at the given level.

7.3 Rotationally averaged power spectrum [\(i\)](#)

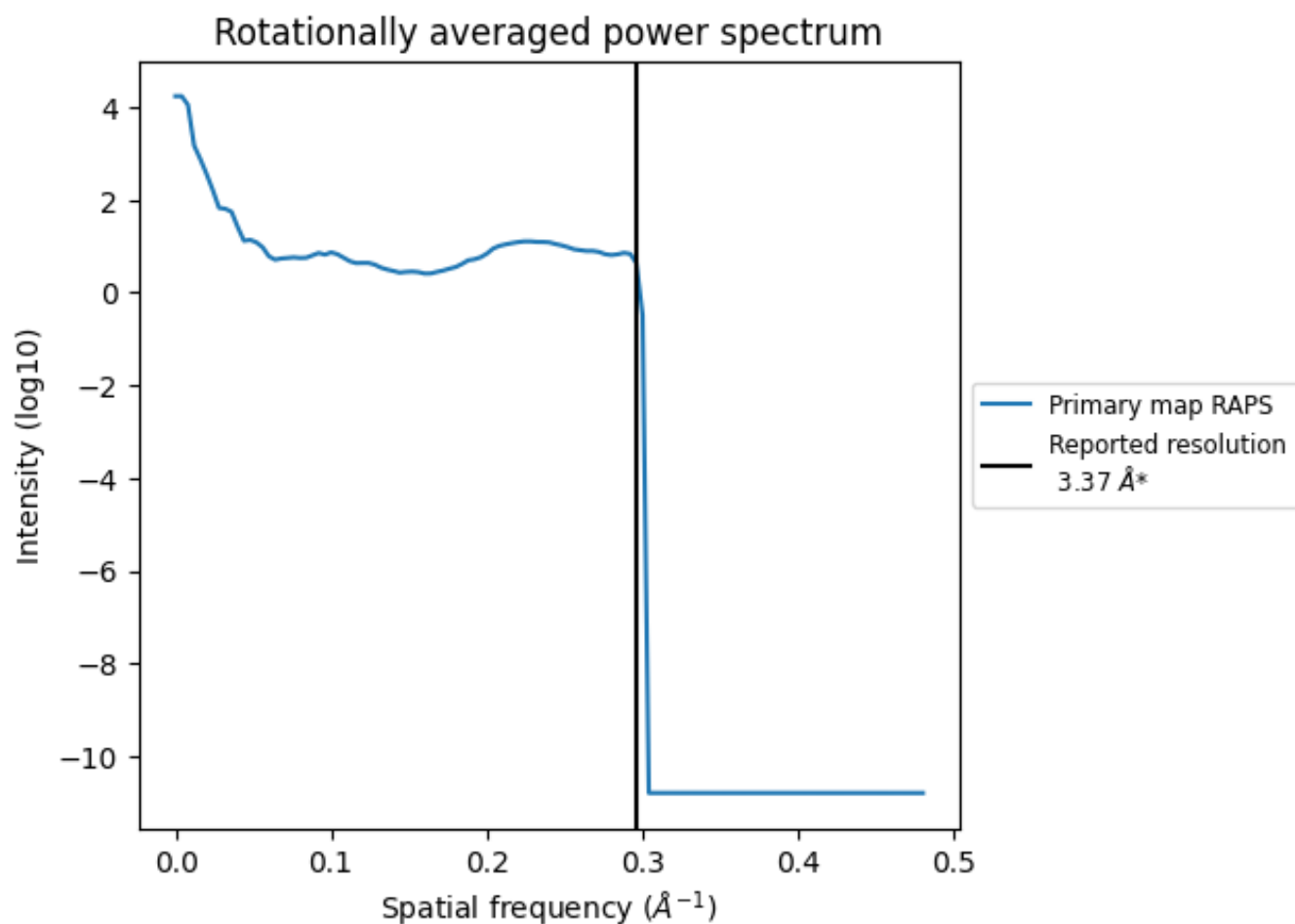

*Reported resolution corresponds to spatial frequency of 0.297 Å⁻¹

8 Fourier-Shell correlation

This section was not generated. No FSC curve or half-maps provided.

9 Map-model fit [i](#)

This section contains information regarding the fit between EMDB map EMD-0959 and PDB model 6LRR. Per-residue inclusion information can be found in section 3 on page 6.

9.1 Map-model overlay [i](#)

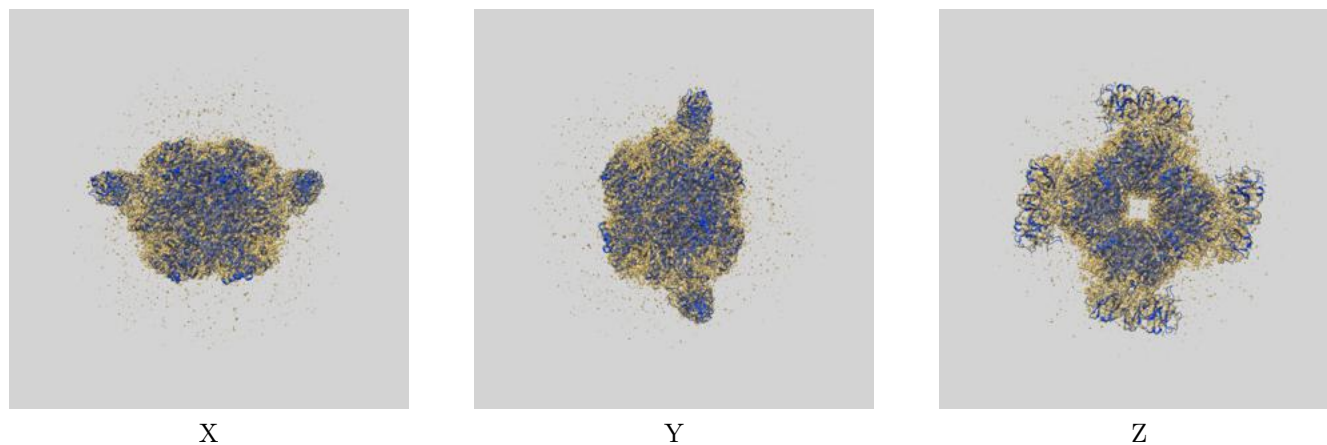

The images above show the 3D surface view of the map at the recommended contour level 0.0209 at 50% transparency in yellow overlaid with a ribbon representation of the model coloured in blue. These images allow for the visual assessment of the quality of fit between the atomic model and the map.

9.2 Q-score mapped to coordinate model [i](#)

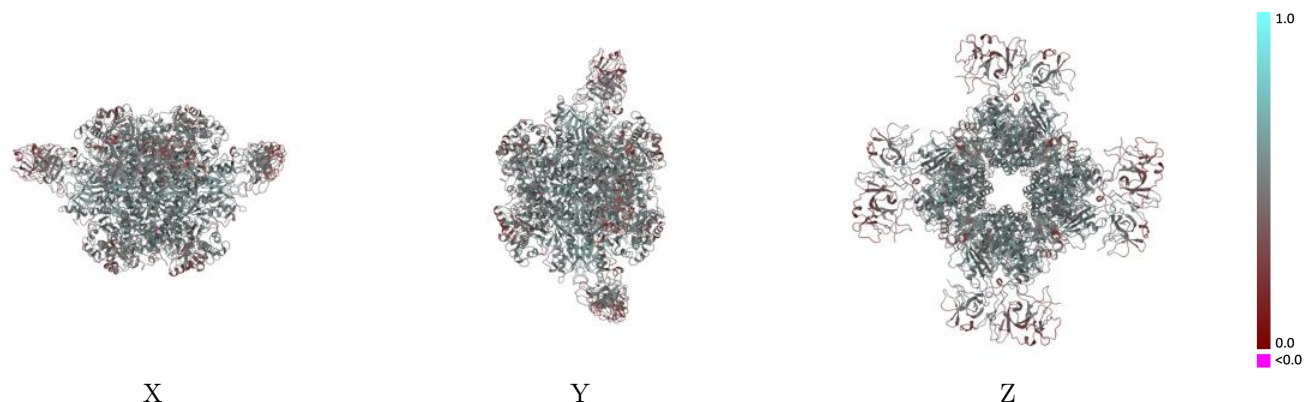

The images above show the model with each residue coloured according to its Q-score. This shows their resolvability in the map with higher Q-score values reflecting better resolvability. Please note: Q-score is calculating the resolvability of atoms, and thus high values are only expected at resolutions at which atoms can be resolved. Low Q-score values may therefore be expected for many entries.

9.3 Atom inclusion mapped to coordinate model [i](#)

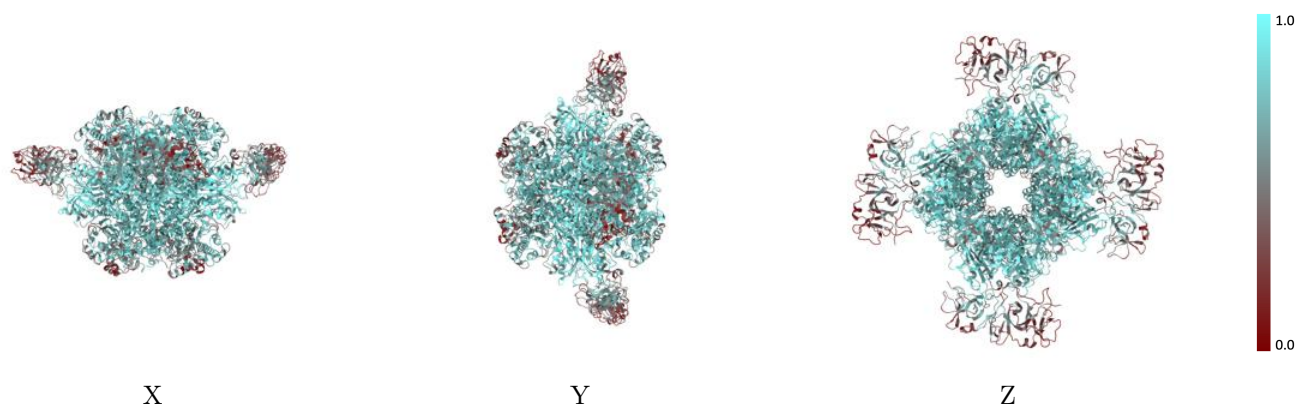

The images above show the model with each residue coloured according to its atom inclusion. This shows to what extent they are inside the map at the recommended contour level (0.0209).



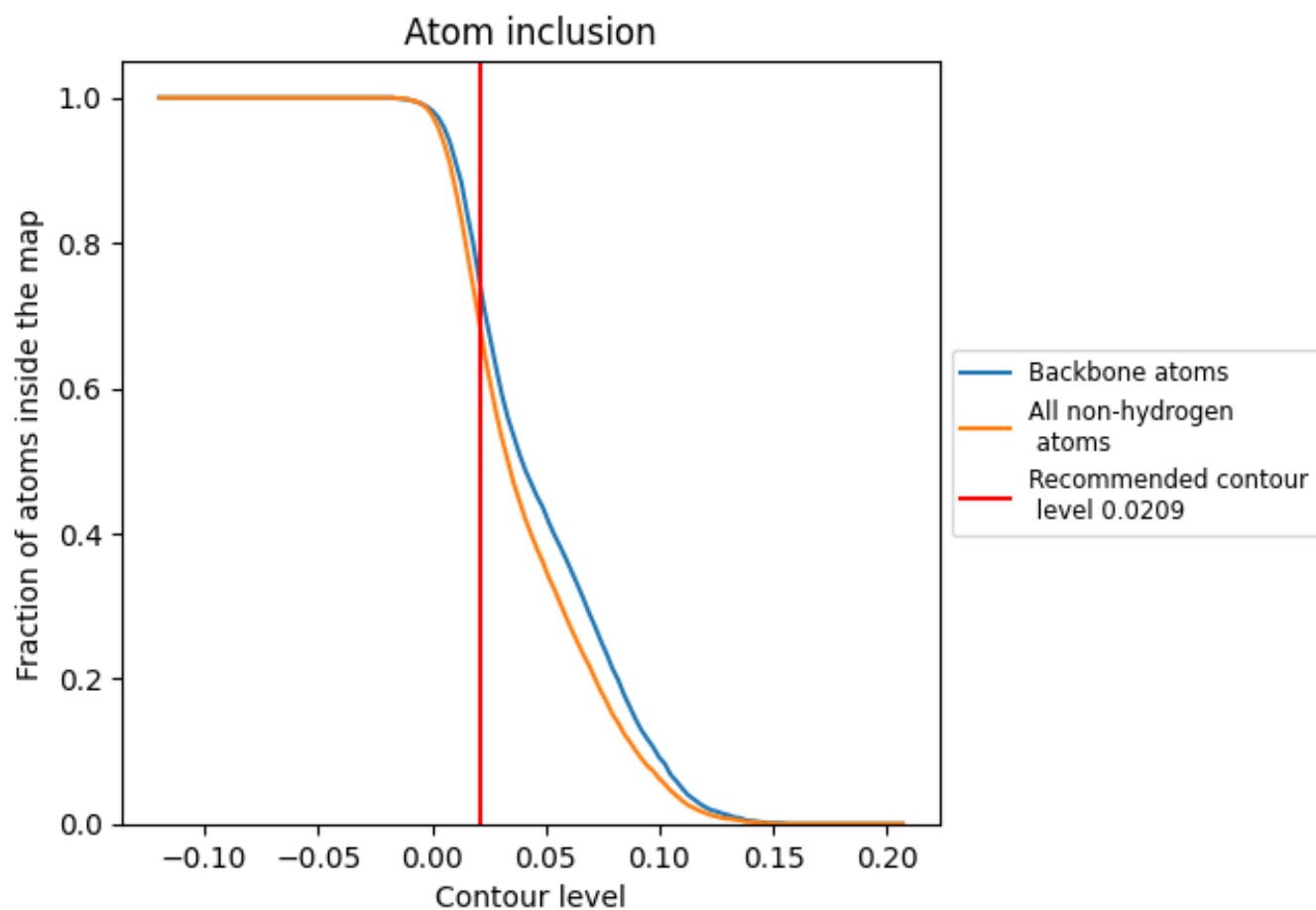















































9.4 Atom inclusion [i](#)



At the recommended contour level, 75% of all backbone atoms, 69% of all non-hydrogen atoms, are inside the map.

9.5 Map-model fit summary

The table lists the average atom inclusion at the recommended contour level (0.0209) and Q-score for the entire model and for each chain.

Chain	Atom inclusion	Q-score
All	 0.6900	 0.4880
A	 0.8400	 0.5420
B	 0.8230	 0.5330
C	 0.8380	 0.5420
D	 0.8250	 0.5340
E	 0.8400	 0.5410
F	 0.8240	 0.5360
G	 0.8400	 0.5430
H	 0.8250	 0.5330
I	 0.4570	 0.4180
J	 0.3330	 0.3620
K	 0.4620	 0.4170
L	 0.3340	 0.3610
M	 0.4610	 0.4210
N	 0.3410	 0.3660
O	 0.4600	 0.4170
P	 0.3370	 0.3650
Q	 0.6540	 0.4390
R	 0.4620	 0.4170
T	 0.6580	 0.4410
U	 0.6530	 0.4400
V	 0.4570	 0.4170
W	 0.4540	 0.4160
X	 0.6600	 0.4440
Y	 0.4510	 0.4170

