



wwPDB EM Validation Summary Report ⓘ

Nov 10, 2024 – 08:16 AM EST

PDB ID : 7LWU
EMDB ID : EMD-23557
Title : UK (B.1.1.7) SARS-CoV-2 spike protein variant (S-GSAS-B.1.1.7) in the 1-RBD-up conformation
Authors : Gobeil, S.; Acharya, P.
Deposited on : 2021-03-01
Resolution : 3.22 Å(reported)

This is a wwPDB EM Validation Summary Report for a publicly released PDB entry.

We welcome your comments at validation@mail.wwpdb.org

A user guide is available at

<https://www.wwpdb.org/validation/2017/EMValidationReportHelp>

with specific help available everywhere you see the ⓘ symbol.

The types of validation reports are described at

<http://www.wwpdb.org/validation/2017/FAQs#types>.

The following versions of software and data (see [references ⓘ](#)) were used in the production of this report:

EMDB validation analysis : 0.0.1.dev113
Mogul : 2022.3.0, CSD as543be (2022)
MolProbity : 4.02b-467
Percentile statistics : 20231227.v01 (using entries in the PDB archive December 27th 2023)
MapQ : 1.9.13
Ideal geometry (proteins) : Engh & Huber (2001)
Ideal geometry (DNA, RNA) : Parkinson et al. (1996)
Validation Pipeline (wwPDB-VP) : 2.39

1 Overall quality at a glance

The following experimental techniques were used to determine the structure:

ELECTRON MICROSCOPY

The reported resolution of this entry is 3.22 Å.

Percentile scores (ranging between 0-100) for global validation metrics of the entry are shown in the following graphic. The table shows the number of entries on which the scores are based.

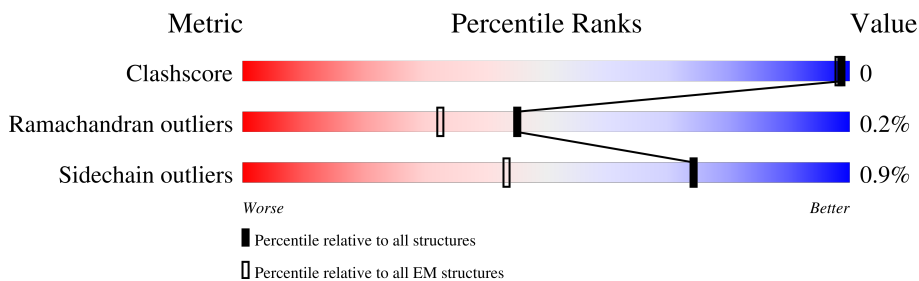

Metric	Whole archive (#Entries)	EM structures (#Entries)
Clashscore	210492	15764
Ramachandran outliers	207382	16835
Sidechain outliers	206894	16415

The table below summarises the geometric issues observed across the polymeric chains and their fit to the map. The red, orange, yellow and green segments of the bar indicate the fraction of residues that contain outliers for ≥ 3 , 2, 1 and 0 types of geometric quality criteria respectively. A grey segment represents the fraction of residues that are not modelled. The numeric value for each fraction is indicated below the corresponding segment, with a dot representing fractions $\leq 5\%$. The upper red bar (where present) indicates the fraction of residues that have poor fit to the EM map (all-atom inclusion $< 40\%$). The numeric value is given above the bar.

Mol	Chain	Length	Quality of chain
1	A	1285	
1	B	1285	
1	C	1285	

2 Entry composition i

There are 2 unique types of molecules in this entry. The entry contains 23576 atoms, of which 0 are hydrogens and 0 are deuteriums.

In the tables below, the AltConf column contains the number of residues with at least one atom in alternate conformation and the Trace column contains the number of residues modelled with at most 2 atoms.

- Molecule 1 is a protein called Spike glycoprotein.

Mol	Chain	Residues	Atoms					AltConf	Trace
			Total	C	N	O	S		
1	A	993	7696	4929	1283	1450	34	0	0
1	B	995	7708	4935	1281	1459	33	0	0
1	C	992	7682	4919	1281	1447	35	0	0

There are 279 discrepancies between the modelled and reference sequences:

Chain	Residue	Modelled	Actual	Comment	Reference
A	?	-	HIS	deletion	UNP P0DTC2
A	?	-	VAL	deletion	UNP P0DTC2
A	?	-	TYR	deletion	UNP P0DTC2
A	501	TYR	ASN	engineered mutation	UNP P0DTC2
A	570	ASP	ALA	engineered mutation	UNP P0DTC2
A	614	GLY	ASP	engineered mutation	UNP P0DTC2
A	681	HIS	PRO	engineered mutation	UNP P0DTC2
A	682	GLY	ARG	engineered mutation	UNP P0DTC2
A	683	SER	ARG	engineered mutation	UNP P0DTC2
A	685	SER	ARG	engineered mutation	UNP P0DTC2
A	716	ILE	THR	engineered mutation	UNP P0DTC2
A	982	ALA	SER	engineered mutation	UNP P0DTC2
A	1118	HIS	ASP	engineered mutation	UNP P0DTC2
A	1209	GLY	-	expression tag	UNP P0DTC2
A	1210	SER	-	expression tag	UNP P0DTC2
A	1211	GLY	-	expression tag	UNP P0DTC2
A	1212	TYR	-	expression tag	UNP P0DTC2
A	1213	ILE	-	expression tag	UNP P0DTC2
A	1214	PRO	-	expression tag	UNP P0DTC2
A	1215	GLU	-	expression tag	UNP P0DTC2
A	1216	ALA	-	expression tag	UNP P0DTC2
A	1217	PRO	-	expression tag	UNP P0DTC2
A	1218	ARG	-	expression tag	UNP P0DTC2
A	1219	ASP	-	expression tag	UNP P0DTC2

Continued on next page...

Continued from previous page...

Chain	Residue	Modelled	Actual	Comment	Reference
A	1220	GLY	-	expression tag	UNP P0DTC2
A	1221	GLN	-	expression tag	UNP P0DTC2
A	1222	ALA	-	expression tag	UNP P0DTC2
A	1223	TYR	-	expression tag	UNP P0DTC2
A	1224	VAL	-	expression tag	UNP P0DTC2
A	1225	ARG	-	expression tag	UNP P0DTC2
A	1226	LYS	-	expression tag	UNP P0DTC2
A	1227	ASP	-	expression tag	UNP P0DTC2
A	1228	GLY	-	expression tag	UNP P0DTC2
A	1229	GLU	-	expression tag	UNP P0DTC2
A	1230	TRP	-	expression tag	UNP P0DTC2
A	1231	VAL	-	expression tag	UNP P0DTC2
A	1232	LEU	-	expression tag	UNP P0DTC2
A	1233	LEU	-	expression tag	UNP P0DTC2
A	1234	SER	-	expression tag	UNP P0DTC2
A	1235	THR	-	expression tag	UNP P0DTC2
A	1236	PHE	-	expression tag	UNP P0DTC2
A	1237	LEU	-	expression tag	UNP P0DTC2
A	1238	GLY	-	expression tag	UNP P0DTC2
A	1239	ARG	-	expression tag	UNP P0DTC2
A	1240	SER	-	expression tag	UNP P0DTC2
A	1241	LEU	-	expression tag	UNP P0DTC2
A	1242	GLU	-	expression tag	UNP P0DTC2
A	1243	VAL	-	expression tag	UNP P0DTC2
A	1244	LEU	-	expression tag	UNP P0DTC2
A	1245	PHE	-	expression tag	UNP P0DTC2
A	1246	GLN	-	expression tag	UNP P0DTC2
A	1247	GLY	-	expression tag	UNP P0DTC2
A	1248	PRO	-	expression tag	UNP P0DTC2
A	1249	GLY	-	expression tag	UNP P0DTC2
A	1250	HIS	-	expression tag	UNP P0DTC2
A	1251	HIS	-	expression tag	UNP P0DTC2
A	1252	HIS	-	expression tag	UNP P0DTC2
A	1253	HIS	-	expression tag	UNP P0DTC2
A	1254	HIS	-	expression tag	UNP P0DTC2
A	1255	HIS	-	expression tag	UNP P0DTC2
A	1256	HIS	-	expression tag	UNP P0DTC2
A	1257	HIS	-	expression tag	UNP P0DTC2
A	1258	SER	-	expression tag	UNP P0DTC2
A	1259	ALA	-	expression tag	UNP P0DTC2
A	1260	TRP	-	expression tag	UNP P0DTC2
A	1261	SER	-	expression tag	UNP P0DTC2

Continued on next page...

Continued from previous page...

Chain	Residue	Modelled	Actual	Comment	Reference
A	1262	HIS	-	expression tag	UNP P0DTC2
A	1263	PRO	-	expression tag	UNP P0DTC2
A	1264	GLN	-	expression tag	UNP P0DTC2
A	1265	PHE	-	expression tag	UNP P0DTC2
A	1266	GLU	-	expression tag	UNP P0DTC2
A	1267	LYS	-	expression tag	UNP P0DTC2
A	1268	GLY	-	expression tag	UNP P0DTC2
A	1269	GLY	-	expression tag	UNP P0DTC2
A	1270	GLY	-	expression tag	UNP P0DTC2
A	1271	SER	-	expression tag	UNP P0DTC2
A	1272	GLY	-	expression tag	UNP P0DTC2
A	1273	GLY	-	expression tag	UNP P0DTC2
A	1274	GLY	-	expression tag	UNP P0DTC2
A	1275	GLY	-	expression tag	UNP P0DTC2
A	1276	SER	-	expression tag	UNP P0DTC2
A	1277	GLY	-	expression tag	UNP P0DTC2
A	1278	GLY	-	expression tag	UNP P0DTC2
A	1279	SER	-	expression tag	UNP P0DTC2
A	1280	ALA	-	expression tag	UNP P0DTC2
A	1281	TRP	-	expression tag	UNP P0DTC2
A	1282	SER	-	expression tag	UNP P0DTC2
A	1283	HIS	-	expression tag	UNP P0DTC2
A	1284	PRO	-	expression tag	UNP P0DTC2
A	1285	GLN	-	expression tag	UNP P0DTC2
A	1286	PHE	-	expression tag	UNP P0DTC2
A	1287	GLU	-	expression tag	UNP P0DTC2
A	1288	LYS	-	expression tag	UNP P0DTC2
B	?	-	HIS	deletion	UNP P0DTC2
B	?	-	VAL	deletion	UNP P0DTC2
B	?	-	TYR	deletion	UNP P0DTC2
B	501	TYR	ASN	engineered mutation	UNP P0DTC2
B	570	ASP	ALA	engineered mutation	UNP P0DTC2
B	614	GLY	ASP	engineered mutation	UNP P0DTC2
B	681	HIS	PRO	engineered mutation	UNP P0DTC2
B	682	GLY	ARG	engineered mutation	UNP P0DTC2
B	683	SER	ARG	engineered mutation	UNP P0DTC2
B	685	SER	ARG	engineered mutation	UNP P0DTC2
B	716	ILE	THR	engineered mutation	UNP P0DTC2
B	982	ALA	SER	engineered mutation	UNP P0DTC2
B	1118	HIS	ASP	engineered mutation	UNP P0DTC2
B	1209	GLY	-	expression tag	UNP P0DTC2
B	1210	SER	-	expression tag	UNP P0DTC2

Continued on next page...

Continued from previous page...

Chain	Residue	Modelled	Actual	Comment	Reference
B	1211	GLY	-	expression tag	UNP P0DTC2
B	1212	TYR	-	expression tag	UNP P0DTC2
B	1213	ILE	-	expression tag	UNP P0DTC2
B	1214	PRO	-	expression tag	UNP P0DTC2
B	1215	GLU	-	expression tag	UNP P0DTC2
B	1216	ALA	-	expression tag	UNP P0DTC2
B	1217	PRO	-	expression tag	UNP P0DTC2
B	1218	ARG	-	expression tag	UNP P0DTC2
B	1219	ASP	-	expression tag	UNP P0DTC2
B	1220	GLY	-	expression tag	UNP P0DTC2
B	1221	GLN	-	expression tag	UNP P0DTC2
B	1222	ALA	-	expression tag	UNP P0DTC2
B	1223	TYR	-	expression tag	UNP P0DTC2
B	1224	VAL	-	expression tag	UNP P0DTC2
B	1225	ARG	-	expression tag	UNP P0DTC2
B	1226	LYS	-	expression tag	UNP P0DTC2
B	1227	ASP	-	expression tag	UNP P0DTC2
B	1228	GLY	-	expression tag	UNP P0DTC2
B	1229	GLU	-	expression tag	UNP P0DTC2
B	1230	TRP	-	expression tag	UNP P0DTC2
B	1231	VAL	-	expression tag	UNP P0DTC2
B	1232	LEU	-	expression tag	UNP P0DTC2
B	1233	LEU	-	expression tag	UNP P0DTC2
B	1234	SER	-	expression tag	UNP P0DTC2
B	1235	THR	-	expression tag	UNP P0DTC2
B	1236	PHE	-	expression tag	UNP P0DTC2
B	1237	LEU	-	expression tag	UNP P0DTC2
B	1238	GLY	-	expression tag	UNP P0DTC2
B	1239	ARG	-	expression tag	UNP P0DTC2
B	1240	SER	-	expression tag	UNP P0DTC2
B	1241	LEU	-	expression tag	UNP P0DTC2
B	1242	GLU	-	expression tag	UNP P0DTC2
B	1243	VAL	-	expression tag	UNP P0DTC2
B	1244	LEU	-	expression tag	UNP P0DTC2
B	1245	PHE	-	expression tag	UNP P0DTC2
B	1246	GLN	-	expression tag	UNP P0DTC2
B	1247	GLY	-	expression tag	UNP P0DTC2
B	1248	PRO	-	expression tag	UNP P0DTC2
B	1249	GLY	-	expression tag	UNP P0DTC2
B	1250	HIS	-	expression tag	UNP P0DTC2
B	1251	HIS	-	expression tag	UNP P0DTC2
B	1252	HIS	-	expression tag	UNP P0DTC2

Continued on next page...

Continued from previous page...

Chain	Residue	Modelled	Actual	Comment	Reference
B	1253	HIS	-	expression tag	UNP P0DTC2
B	1254	HIS	-	expression tag	UNP P0DTC2
B	1255	HIS	-	expression tag	UNP P0DTC2
B	1256	HIS	-	expression tag	UNP P0DTC2
B	1257	HIS	-	expression tag	UNP P0DTC2
B	1258	SER	-	expression tag	UNP P0DTC2
B	1259	ALA	-	expression tag	UNP P0DTC2
B	1260	TRP	-	expression tag	UNP P0DTC2
B	1261	SER	-	expression tag	UNP P0DTC2
B	1262	HIS	-	expression tag	UNP P0DTC2
B	1263	PRO	-	expression tag	UNP P0DTC2
B	1264	GLN	-	expression tag	UNP P0DTC2
B	1265	PHE	-	expression tag	UNP P0DTC2
B	1266	GLU	-	expression tag	UNP P0DTC2
B	1267	LYS	-	expression tag	UNP P0DTC2
B	1268	GLY	-	expression tag	UNP P0DTC2
B	1269	GLY	-	expression tag	UNP P0DTC2
B	1270	GLY	-	expression tag	UNP P0DTC2
B	1271	SER	-	expression tag	UNP P0DTC2
B	1272	GLY	-	expression tag	UNP P0DTC2
B	1273	GLY	-	expression tag	UNP P0DTC2
B	1274	GLY	-	expression tag	UNP P0DTC2
B	1275	GLY	-	expression tag	UNP P0DTC2
B	1276	SER	-	expression tag	UNP P0DTC2
B	1277	GLY	-	expression tag	UNP P0DTC2
B	1278	GLY	-	expression tag	UNP P0DTC2
B	1279	SER	-	expression tag	UNP P0DTC2
B	1280	ALA	-	expression tag	UNP P0DTC2
B	1281	TRP	-	expression tag	UNP P0DTC2
B	1282	SER	-	expression tag	UNP P0DTC2
B	1283	HIS	-	expression tag	UNP P0DTC2
B	1284	PRO	-	expression tag	UNP P0DTC2
B	1285	GLN	-	expression tag	UNP P0DTC2
B	1286	PHE	-	expression tag	UNP P0DTC2
B	1287	GLU	-	expression tag	UNP P0DTC2
B	1288	LYS	-	expression tag	UNP P0DTC2
C	?	-	HIS	deletion	UNP P0DTC2
C	?	-	VAL	deletion	UNP P0DTC2
C	?	-	TYR	deletion	UNP P0DTC2
C	501	TYR	ASN	engineered mutation	UNP P0DTC2
C	570	ASP	ALA	engineered mutation	UNP P0DTC2
C	614	GLY	ASP	engineered mutation	UNP P0DTC2

Continued on next page...

Continued from previous page...

Chain	Residue	Modelled	Actual	Comment	Reference
C	681	HIS	PRO	engineered mutation	UNP P0DTC2
C	682	GLY	ARG	engineered mutation	UNP P0DTC2
C	683	SER	ARG	engineered mutation	UNP P0DTC2
C	685	SER	ARG	engineered mutation	UNP P0DTC2
C	716	ILE	THR	engineered mutation	UNP P0DTC2
C	982	ALA	SER	engineered mutation	UNP P0DTC2
C	1118	HIS	ASP	engineered mutation	UNP P0DTC2
C	1209	GLY	-	expression tag	UNP P0DTC2
C	1210	SER	-	expression tag	UNP P0DTC2
C	1211	GLY	-	expression tag	UNP P0DTC2
C	1212	TYR	-	expression tag	UNP P0DTC2
C	1213	ILE	-	expression tag	UNP P0DTC2
C	1214	PRO	-	expression tag	UNP P0DTC2
C	1215	GLU	-	expression tag	UNP P0DTC2
C	1216	ALA	-	expression tag	UNP P0DTC2
C	1217	PRO	-	expression tag	UNP P0DTC2
C	1218	ARG	-	expression tag	UNP P0DTC2
C	1219	ASP	-	expression tag	UNP P0DTC2
C	1220	GLY	-	expression tag	UNP P0DTC2
C	1221	GLN	-	expression tag	UNP P0DTC2
C	1222	ALA	-	expression tag	UNP P0DTC2
C	1223	TYR	-	expression tag	UNP P0DTC2
C	1224	VAL	-	expression tag	UNP P0DTC2
C	1225	ARG	-	expression tag	UNP P0DTC2
C	1226	LYS	-	expression tag	UNP P0DTC2
C	1227	ASP	-	expression tag	UNP P0DTC2
C	1228	GLY	-	expression tag	UNP P0DTC2
C	1229	GLU	-	expression tag	UNP P0DTC2
C	1230	TRP	-	expression tag	UNP P0DTC2
C	1231	VAL	-	expression tag	UNP P0DTC2
C	1232	LEU	-	expression tag	UNP P0DTC2
C	1233	LEU	-	expression tag	UNP P0DTC2
C	1234	SER	-	expression tag	UNP P0DTC2
C	1235	THR	-	expression tag	UNP P0DTC2
C	1236	PHE	-	expression tag	UNP P0DTC2
C	1237	LEU	-	expression tag	UNP P0DTC2
C	1238	GLY	-	expression tag	UNP P0DTC2
C	1239	ARG	-	expression tag	UNP P0DTC2
C	1240	SER	-	expression tag	UNP P0DTC2
C	1241	LEU	-	expression tag	UNP P0DTC2
C	1242	GLU	-	expression tag	UNP P0DTC2
C	1243	VAL	-	expression tag	UNP P0DTC2

Continued on next page...

Continued from previous page...

Chain	Residue	Modelled	Actual	Comment	Reference
C	1244	LEU	-	expression tag	UNP P0DTC2
C	1245	PHE	-	expression tag	UNP P0DTC2
C	1246	GLN	-	expression tag	UNP P0DTC2
C	1247	GLY	-	expression tag	UNP P0DTC2
C	1248	PRO	-	expression tag	UNP P0DTC2
C	1249	GLY	-	expression tag	UNP P0DTC2
C	1250	HIS	-	expression tag	UNP P0DTC2
C	1251	HIS	-	expression tag	UNP P0DTC2
C	1252	HIS	-	expression tag	UNP P0DTC2
C	1253	HIS	-	expression tag	UNP P0DTC2
C	1254	HIS	-	expression tag	UNP P0DTC2
C	1255	HIS	-	expression tag	UNP P0DTC2
C	1256	HIS	-	expression tag	UNP P0DTC2
C	1257	HIS	-	expression tag	UNP P0DTC2
C	1258	SER	-	expression tag	UNP P0DTC2
C	1259	ALA	-	expression tag	UNP P0DTC2
C	1260	TRP	-	expression tag	UNP P0DTC2
C	1261	SER	-	expression tag	UNP P0DTC2
C	1262	HIS	-	expression tag	UNP P0DTC2
C	1263	PRO	-	expression tag	UNP P0DTC2
C	1264	GLN	-	expression tag	UNP P0DTC2
C	1265	PHE	-	expression tag	UNP P0DTC2
C	1266	GLU	-	expression tag	UNP P0DTC2
C	1267	LYS	-	expression tag	UNP P0DTC2
C	1268	GLY	-	expression tag	UNP P0DTC2
C	1269	GLY	-	expression tag	UNP P0DTC2
C	1270	GLY	-	expression tag	UNP P0DTC2
C	1271	SER	-	expression tag	UNP P0DTC2
C	1272	GLY	-	expression tag	UNP P0DTC2
C	1273	GLY	-	expression tag	UNP P0DTC2
C	1274	GLY	-	expression tag	UNP P0DTC2
C	1275	GLY	-	expression tag	UNP P0DTC2
C	1276	SER	-	expression tag	UNP P0DTC2
C	1277	GLY	-	expression tag	UNP P0DTC2
C	1278	GLY	-	expression tag	UNP P0DTC2
C	1279	SER	-	expression tag	UNP P0DTC2
C	1280	ALA	-	expression tag	UNP P0DTC2
C	1281	TRP	-	expression tag	UNP P0DTC2
C	1282	SER	-	expression tag	UNP P0DTC2
C	1283	HIS	-	expression tag	UNP P0DTC2
C	1284	PRO	-	expression tag	UNP P0DTC2
C	1285	GLN	-	expression tag	UNP P0DTC2

Continued on next page...

Continued from previous page...

Chain	Residue	Modelled	Actual	Comment	Reference
C	1286	PHE	-	expression tag	UNP P0DTC2
C	1287	GLU	-	expression tag	UNP P0DTC2
C	1288	LYS	-	expression tag	UNP P0DTC2

- Molecule 2 is 2-acetamido-2-deoxy-beta-D-glucopyranose (three-letter code: NAG) (formula: $C_8H_{15}NO_6$).

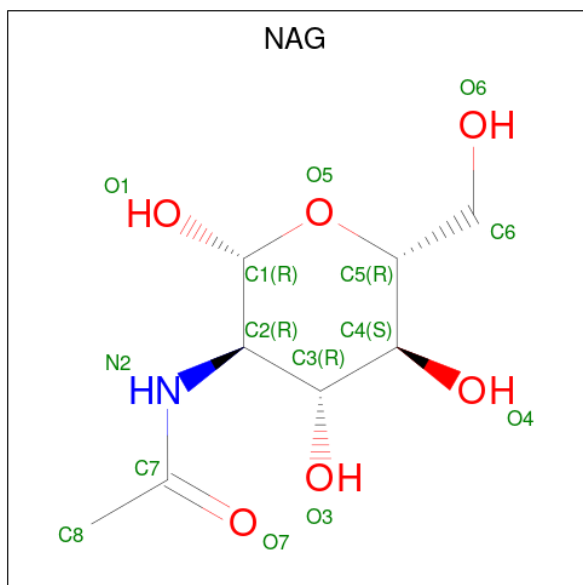

Mol	Chain	Residues	Atoms				AltConf
			Total	C	N	O	
2	A	1	Total	C	N	O	0
			14	8	1	5	
2	A	1	Total	C	N	O	0
			14	8	1	5	
2	A	1	Total	C	N	O	0
			14	8	1	5	
2	A	1	Total	C	N	O	0
			14	8	1	5	
2	A	1	Total	C	N	O	0
			14	8	1	5	
2	A	1	Total	C	N	O	0
			14	8	1	5	
2	A	1	Total	C	N	O	0
			14	8	1	5	
2	A	1	Total	C	N	O	0
			14	8	1	5	

Continued on next page...

Continued from previous page...

Mol	Chain	Residues	Atoms				AltConf
			Total	C	N	O	
2	A	1	Total 14	8	1	5	0
2	A	1	Total 14	8	1	5	0
2	A	1	Total 14	8	1	5	0
2	B	1	Total 14	8	1	5	0
2	B	1	Total 14	8	1	5	0
2	B	1	Total 14	8	1	5	0
2	B	1	Total 14	8	1	5	0
2	B	1	Total 14	8	1	5	0
2	B	1	Total 14	8	1	5	0
2	B	1	Total 14	8	1	5	0
2	B	1	Total 14	8	1	5	0
2	B	1	Total 14	8	1	5	0
2	B	1	Total 14	8	1	5	0
2	B	1	Total 14	8	1	5	0
2	B	1	Total 14	8	1	5	0
2	C	1	Total 14	8	1	5	0
2	C	1	Total 14	8	1	5	0
2	C	1	Total 14	8	1	5	0
2	C	1	Total 14	8	1	5	0
2	C	1	Total 14	8	1	5	0
2	C	1	Total 14	8	1	5	0
2	C	1	Total 14	8	1	5	0

Continued on next page...

Continued from previous page...

Mol	Chain	Residues	Atoms				AltConf
2	C	1	Total	C	N	O	0
			14	8	1	5	
2	C	1	Total	C	N	O	0
			14	8	1	5	
2	C	1	Total	C	N	O	0
			14	8	1	5	
2	C	1	Total	C	N	O	0
			14	8	1	5	
2	C	1	Total	C	N	O	0
			14	8	1	5	

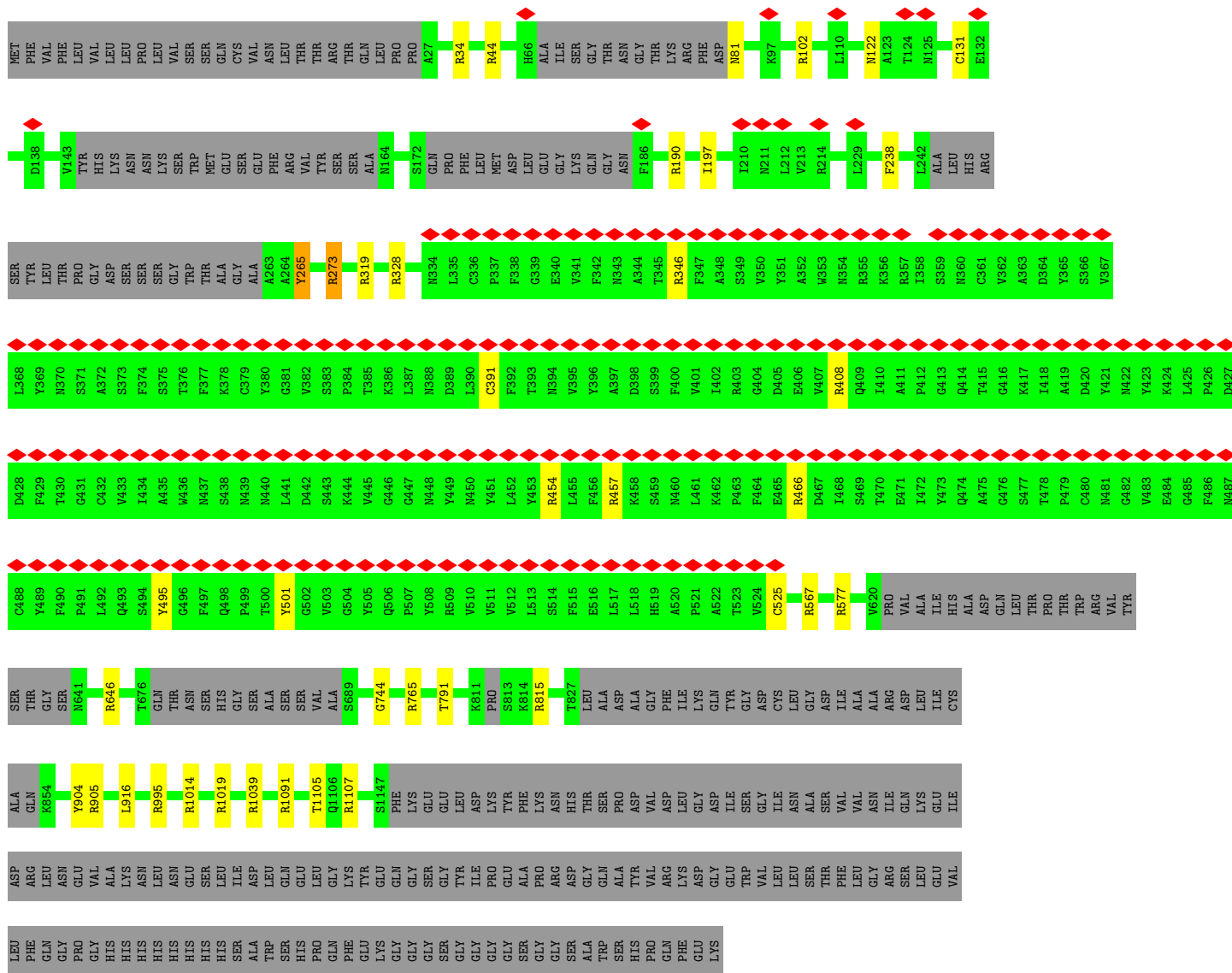

• Molecule 1: Spike glycoprotein

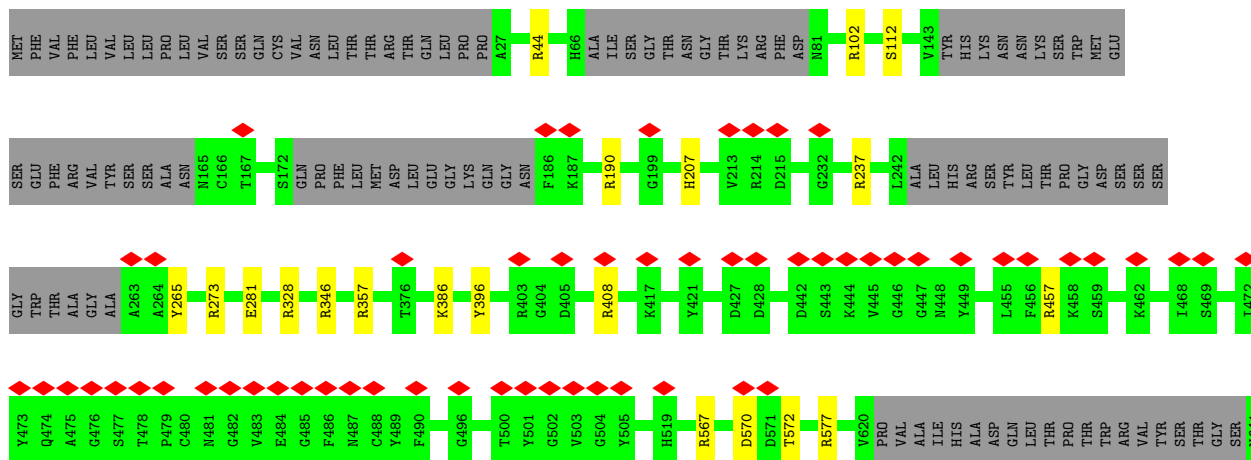
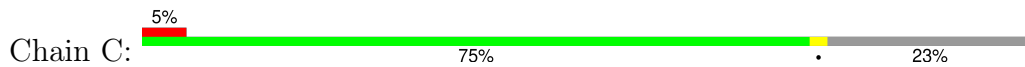

4 Experimental information

Property	Value	Source
EM reconstruction method	SINGLE PARTICLE	Depositor
Imposed symmetry	POINT, Not provided	
Number of particles used	125383	Depositor
Resolution determination method	FSC 0.143 CUT-OFF	Depositor
CTF correction method	PHASE FLIPPING AND AMPLITUDE CORRECTION	Depositor
Microscope	FEI TITAN KRIOS	Depositor
Voltage (kV)	300	Depositor
Electron dose ($e^-/\text{\AA}^2$)	52.65	Depositor
Minimum defocus (nm)	Not provided	
Maximum defocus (nm)	Not provided	
Magnification	Not provided	
Image detector	GATAN K3 (6k x 4k)	Depositor
Maximum map value	3.455	Depositor
Minimum map value	-2.020	Depositor
Average map value	-0.001	Depositor
Map value standard deviation	0.081	Depositor
Recommended contour level	0.28	Depositor
Map size (Å)	320.7, 320.7, 320.7	wwPDB
Map dimensions	300, 300, 300	wwPDB
Map angles (°)	90.0, 90.0, 90.0	wwPDB
Pixel spacing (Å)	1.069, 1.069, 1.069	Depositor

5 Model quality i

5.1 Standard geometry i

Bond lengths and bond angles in the following residue types are not validated in this section: NAG

The Z score for a bond length (or angle) is the number of standard deviations the observed value is removed from the expected value. A bond length (or angle) with $|Z| > 5$ is considered an outlier worth inspection. RMSZ is the root-mean-square of all Z scores of the bond lengths (or angles).

Mol	Chain	Bond lengths		Bond angles	
		RMSZ	# Z >5	RMSZ	# Z >5
1	A	0.66	0/7866	0.94	19/10702 (0.2%)
1	B	0.66	0/7880	0.94	27/10725 (0.3%)
1	C	0.66	0/7854	0.95	20/10691 (0.2%)
All	All	0.66	0/23600	0.94	66/32118 (0.2%)

Chiral center outliers are detected by calculating the chiral volume of a chiral center and verifying if the center is modelled as a planar moiety or with the opposite hand. A planarity outlier is detected by checking planarity of atoms in a peptide group, atoms in a mainchain group or atoms of a sidechain that are expected to be planar.

Mol	Chain	#Chirality outliers	#Planarity outliers
1	A	0	1
1	B	0	3
1	C	0	3
All	All	0	7

There are no bond length outliers.

The worst 5 of 66 bond angle outliers are listed below:

Mol	Chain	Res	Type	Atoms	Z	Observed(°)	Ideal(°)
1	C	995	ARG	NE-CZ-NH1	8.71	124.66	120.30
1	A	904	TYR	CB-CG-CD2	-7.92	116.25	121.00
1	C	273	ARG	NE-CZ-NH1	7.81	124.20	120.30
1	C	577	ARG	NE-CZ-NH1	7.58	124.09	120.30
1	C	1019	ARG	NE-CZ-NH1	7.34	123.97	120.30

There are no chirality outliers.

5 of 7 planarity outliers are listed below:

Mol	Chain	Res	Type	Group
1	A	34	ARG	Sidechain
1	B	265	TYR	Sidechain
1	B	273	ARG	Sidechain
1	B	495	TYR	Sidechain
1	C	265	TYR	Sidechain

5.2 Too-close contacts [i](#)

In the following table, the Non-H and H(model) columns list the number of non-hydrogen atoms and hydrogen atoms in the chain respectively. The H(added) column lists the number of hydrogen atoms added and optimized by MolProbity. The Clashes column lists the number of clashes within the asymmetric unit, whereas Symm-Clashes lists symmetry-related clashes.

Mol	Chain	Non-H	H(model)	H(added)	Clashes	Symm-Clashes
1	A	7696	0	7500	4	0
1	B	7708	0	7483	1	0
1	C	7682	0	7462	1	0
2	A	168	0	156	3	0
2	B	154	0	143	0	0
2	C	168	0	156	1	0
All	All	23576	0	22900	6	0

The all-atom clashscore is defined as the number of clashes found per 1000 atoms (including hydrogen atoms). The all-atom clashscore for this structure is 0.

The worst 5 of 6 close contacts within the same asymmetric unit are listed below, sorted by their clash magnitude.

Atom-1	Atom-2	Interatomic distance (Å)	Clash overlap (Å)
1:A:1103:PHE:CD2	2:A:1311:NAG:H83	2.26	0.70
1:B:81:ASN:N	1:B:265:TYR:HH	2.08	0.51
1:A:1097:SER:HA	2:A:1311:NAG:H81	1.95	0.47
1:A:1103:PHE:CE2	2:A:1311:NAG:H83	2.49	0.47
1:C:281:GLU:CB	2:C:1302:NAG:H82	2.46	0.46

There are no symmetry-related clashes.

5.3 Torsion angles [i](#)

5.3.1 Protein backbone [i](#)

In the following table, the Percentiles column shows the percent Ramachandran outliers of the chain as a percentile score with respect to all PDB entries followed by that with respect to all EM entries.

The Analysed column shows the number of residues for which the backbone conformation was analysed, and the total number of residues.

Mol	Chain	Analysed	Favoured	Allowed	Outliers	Percentiles	
1	A	973/1285 (76%)	922 (95%)	49 (5%)	2 (0%)	44	74
1	B	977/1285 (76%)	913 (93%)	62 (6%)	2 (0%)	44	74
1	C	974/1285 (76%)	923 (95%)	49 (5%)	2 (0%)	44	74
All	All	2924/3855 (76%)	2758 (94%)	160 (6%)	6 (0%)	45	74

5 of 6 Ramachandran outliers are listed below:

Mol	Chain	Res	Type
1	C	112	SER
1	A	97	LYS
1	A	112	SER
1	C	706	ALA
1	B	744	GLY

5.3.2 Protein sidechains [i](#)

In the following table, the Percentiles column shows the percent sidechain outliers of the chain as a percentile score with respect to all PDB entries followed by that with respect to all EM entries.

The Analysed column shows the number of residues for which the sidechain conformation was analysed, and the total number of residues.

Mol	Chain	Analysed	Rotameric	Outliers	Percentiles	
1	A	849/1109 (77%)	840 (99%)	9 (1%)	70	84
1	B	849/1109 (77%)	841 (99%)	8 (1%)	75	87
1	C	846/1109 (76%)	840 (99%)	6 (1%)	81	90
All	All	2544/3327 (76%)	2521 (99%)	23 (1%)	74	87

5 of 23 residues with a non-rotameric sidechain are listed below:

Mol	Chain	Res	Type
1	B	791	THR
1	C	207	HIS
1	B	1105	THR
1	C	386	LYS
1	A	760	CYS

Sometimes sidechains can be flipped to improve hydrogen bonding and reduce clashes. There are no such sidechains identified.

5.3.3 RNA [i](#)

There are no RNA molecules in this entry.

5.4 Non-standard residues in protein, DNA, RNA chains [i](#)

There are no non-standard protein/DNA/RNA residues in this entry.

5.5 Carbohydrates [i](#)

There are no oligosaccharides in this entry.

5.6 Ligand geometry [i](#)

35 ligands are modelled in this entry.

In the following table, the Counts columns list the number of bonds (or angles) for which Mogul statistics could be retrieved, the number of bonds (or angles) that are observed in the model and the number of bonds (or angles) that are defined in the Chemical Component Dictionary. The Link column lists molecule types, if any, to which the group is linked. The Z score for a bond length (or angle) is the number of standard deviations the observed value is removed from the expected value. A bond length (or angle) with $|Z| > 2$ is considered an outlier worth inspection. RMSZ is the root-mean-square of all Z scores of the bond lengths (or angles).

Mol	Type	Chain	Res	Link	Bond lengths			Bond angles		
					Counts	RMSZ	# Z > 2	Counts	RMSZ	# Z > 2
2	NAG	B	1303	1	14,14,15	1.36	3 (21%)	17,19,21	0.80	0
2	NAG	A	1304	1	14,14,15	1.43	3 (21%)	17,19,21	0.82	0
2	NAG	A	1302	1	14,14,15	1.31	1 (7%)	17,19,21	0.93	1 (5%)
2	NAG	C	1302	1	14,14,15	1.41	3 (21%)	17,19,21	0.76	0
2	NAG	A	1303	1	14,14,15	1.29	1 (7%)	17,19,21	0.73	0

Mol	Type	Chain	Res	Link	Bond lengths			Bond angles		
					Counts	RMSZ	# Z > 2	Counts	RMSZ	# Z > 2
2	NAG	B	1310	1	14,14,15	1.18	1 (7%)	17,19,21	1.09	1 (5%)
2	NAG	B	1306	1	14,14,15	1.13	1 (7%)	17,19,21	0.73	0
2	NAG	A	1310	1	14,14,15	1.25	3 (21%)	17,19,21	1.01	1 (5%)
2	NAG	B	1308	1	14,14,15	1.31	3 (21%)	17,19,21	0.96	1 (5%)
2	NAG	C	1310	1	14,14,15	1.25	1 (7%)	17,19,21	1.28	2 (11%)
2	NAG	C	1306	1	14,14,15	1.38	2 (14%)	17,19,21	0.80	0
2	NAG	A	1305	1	14,14,15	1.25	2 (14%)	17,19,21	0.81	0
2	NAG	B	1302	1	14,14,15	1.34	2 (14%)	17,19,21	1.01	0
2	NAG	C	1304	1	14,14,15	1.29	2 (14%)	17,19,21	1.15	1 (5%)
2	NAG	C	1305	1	14,14,15	1.28	1 (7%)	17,19,21	0.60	0
2	NAG	B	1301	1	14,14,15	1.33	3 (21%)	17,19,21	0.96	0
2	NAG	A	1306	1	14,14,15	1.30	2 (14%)	17,19,21	0.69	0
2	NAG	C	1308	1	14,14,15	1.18	2 (14%)	17,19,21	0.69	0
2	NAG	A	1307	1	14,14,15	1.27	3 (21%)	17,19,21	0.73	1 (5%)
2	NAG	C	1311	1	14,14,15	1.25	2 (14%)	17,19,21	0.86	1 (5%)
2	NAG	C	1307	1	14,14,15	1.17	1 (7%)	17,19,21	0.82	1 (5%)
2	NAG	A	1309	1	14,14,15	1.24	2 (14%)	17,19,21	0.92	1 (5%)
2	NAG	B	1305	1	14,14,15	1.35	2 (14%)	17,19,21	1.12	1 (5%)
2	NAG	A	1311	1	14,14,15	1.22	2 (14%)	17,19,21	1.67	3 (17%)
2	NAG	C	1303	1	14,14,15	1.34	3 (21%)	17,19,21	0.86	1 (5%)
2	NAG	C	1301	1	14,14,15	1.39	2 (14%)	17,19,21	0.91	0
2	NAG	A	1312	1	14,14,15	1.28	2 (14%)	17,19,21	0.88	1 (5%)
2	NAG	C	1309	1	14,14,15	1.33	3 (21%)	17,19,21	1.12	1 (5%)
2	NAG	A	1301	1	14,14,15	1.28	2 (14%)	17,19,21	0.78	1 (5%)
2	NAG	C	1312	1	14,14,15	1.37	2 (14%)	17,19,21	1.00	1 (5%)
2	NAG	B	1304	1	14,14,15	1.23	2 (14%)	17,19,21	0.89	1 (5%)
2	NAG	B	1309	1	14,14,15	1.24	1 (7%)	17,19,21	0.89	1 (5%)
2	NAG	A	1308	1	14,14,15	1.19	1 (7%)	17,19,21	0.71	1 (5%)
2	NAG	B	1307	1	14,14,15	1.17	2 (14%)	17,19,21	0.73	0
2	NAG	B	1311	1	14,14,15	1.21	1 (7%)	17,19,21	0.71	0

In the following table, the Chirals column lists the number of chiral outliers, the number of chiral centers analysed, the number of these observed in the model and the number defined in the Chemical Component Dictionary. Similar counts are reported in the Torsion and Rings columns. '-' means no outliers of that kind were identified.

Mol	Type	Chain	Res	Link	Chirals	Torsions	Rings
2	NAG	B	1303	1	-	0/6/23/26	0/1/1/1
2	NAG	A	1304	1	-	3/6/23/26	0/1/1/1
2	NAG	A	1302	1	-	0/6/23/26	0/1/1/1
2	NAG	C	1302	1	-	0/6/23/26	0/1/1/1
2	NAG	A	1303	1	-	0/6/23/26	0/1/1/1
2	NAG	B	1310	1	-	2/6/23/26	0/1/1/1
2	NAG	B	1306	1	-	0/6/23/26	0/1/1/1
2	NAG	A	1310	1	-	1/6/23/26	0/1/1/1
2	NAG	B	1308	1	-	0/6/23/26	0/1/1/1
2	NAG	C	1310	1	-	2/6/23/26	0/1/1/1
2	NAG	C	1306	1	-	2/6/23/26	0/1/1/1
2	NAG	A	1305	1	-	0/6/23/26	0/1/1/1
2	NAG	B	1302	1	-	2/6/23/26	0/1/1/1
2	NAG	C	1304	1	-	3/6/23/26	0/1/1/1
2	NAG	C	1305	1	-	2/6/23/26	0/1/1/1
2	NAG	B	1301	1	-	2/6/23/26	0/1/1/1
2	NAG	A	1306	1	-	1/6/23/26	0/1/1/1
2	NAG	C	1308	1	-	1/6/23/26	0/1/1/1
2	NAG	A	1307	1	-	0/6/23/26	0/1/1/1
2	NAG	C	1311	1	-	0/6/23/26	0/1/1/1
2	NAG	C	1307	1	-	0/6/23/26	0/1/1/1
2	NAG	A	1309	1	-	0/6/23/26	0/1/1/1
2	NAG	B	1305	1	-	2/6/23/26	0/1/1/1
2	NAG	A	1311	1	-	0/6/23/26	0/1/1/1
2	NAG	C	1303	1	-	2/6/23/26	0/1/1/1
2	NAG	C	1301	1	-	3/6/23/26	0/1/1/1
2	NAG	A	1312	1	-	1/6/23/26	0/1/1/1
2	NAG	C	1309	1	-	2/6/23/26	0/1/1/1
2	NAG	A	1301	1	-	2/6/23/26	0/1/1/1
2	NAG	C	1312	1	-	0/6/23/26	0/1/1/1
2	NAG	B	1304	1	-	0/6/23/26	0/1/1/1
2	NAG	B	1309	1	-	0/6/23/26	0/1/1/1
2	NAG	A	1308	1	-	0/6/23/26	0/1/1/1
2	NAG	B	1307	1	-	2/6/23/26	0/1/1/1
2	NAG	B	1311	1	-	2/6/23/26	0/1/1/1

The worst 5 of 69 bond length outliers are listed below:

Mol	Chain	Res	Type	Atoms	Z	Observed(Å)	Ideal(Å)
2	B	1305	NAG	O5-C5	3.09	1.49	1.43

Continued on next page...

Continued from previous page...

Mol	Chain	Res	Type	Atoms	Z	Observed(Å)	Ideal(Å)
2	A	1302	NAG	O5-C5	3.05	1.49	1.43
2	B	1301	NAG	O5-C5	2.99	1.49	1.43
2	C	1302	NAG	O5-C5	2.97	1.49	1.43
2	B	1302	NAG	O5-C5	2.96	1.49	1.43

The worst 5 of 23 bond angle outliers are listed below:

Mol	Chain	Res	Type	Atoms	Z	Observed(°)	Ideal(°)
2	A	1311	NAG	O5-C1-C2	5.07	119.13	111.29
2	C	1309	NAG	C1-O5-C5	3.67	117.11	112.19
2	A	1310	NAG	C1-O5-C5	3.40	116.75	112.19
2	B	1308	NAG	C1-O5-C5	3.34	116.66	112.19
2	C	1304	NAG	C1-O5-C5	3.33	116.65	112.19

There are no chirality outliers.

5 of 37 torsion outliers are listed below:

Mol	Chain	Res	Type	Atoms
2	B	1301	NAG	C1-C2-N2-C7
2	B	1305	NAG	C1-C2-N2-C7
2	B	1310	NAG	C1-C2-N2-C7
2	B	1311	NAG	C1-C2-N2-C7
2	C	1301	NAG	C1-C2-N2-C7

There are no ring outliers.

2 monomers are involved in 4 short contacts:

Mol	Chain	Res	Type	Clashes	Symm-Clashes
2	C	1302	NAG	1	0
2	A	1311	NAG	3	0

5.7 Other polymers [i](#)

There are no such residues in this entry.

5.8 Polymer linkage issues [i](#)

There are no chain breaks in this entry.

6 Map visualisation [i](#)

This section contains visualisations of the EMDB entry EMD-23557. These allow visual inspection of the internal detail of the map and identification of artifacts.

No raw map or half-maps were deposited for this entry and therefore no images, graphs, etc. pertaining to the raw map can be shown.

6.1 Orthogonal projections [i](#)

6.1.1 Primary map

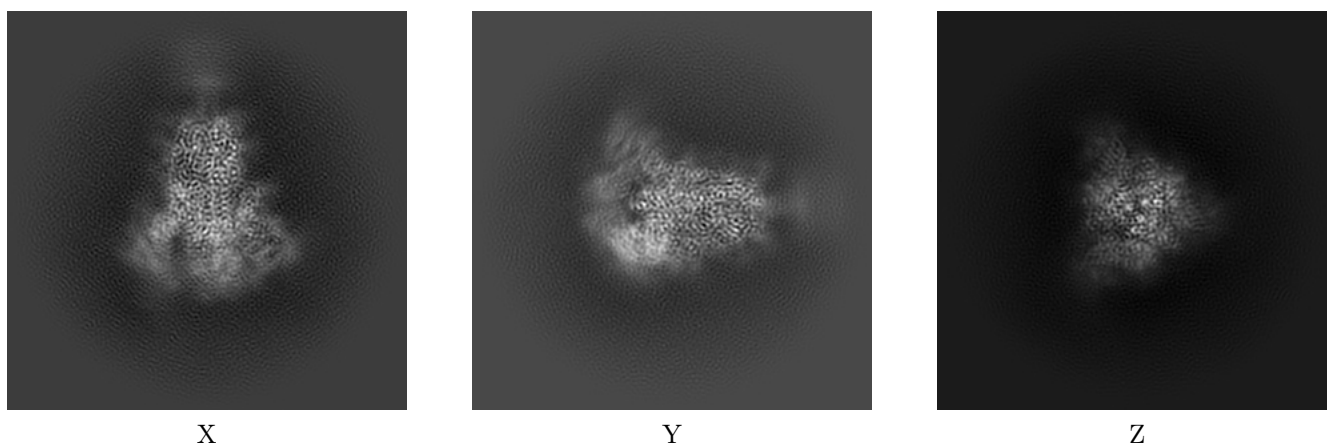

The images above show the map projected in three orthogonal directions.

6.2 Central slices [i](#)

6.2.1 Primary map

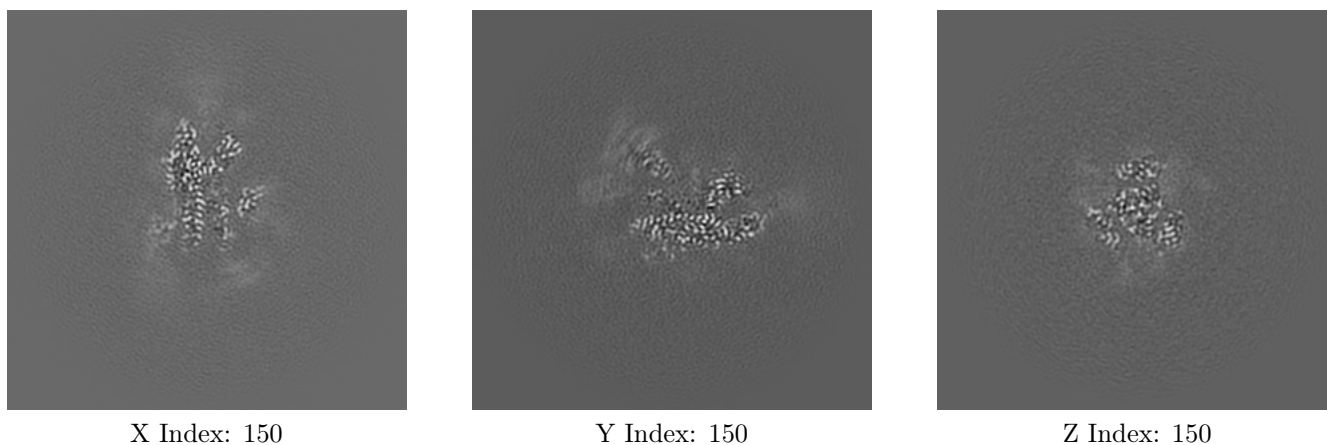

The images above show central slices of the map in three orthogonal directions.

6.3 Largest variance slices [i](#)

6.3.1 Primary map

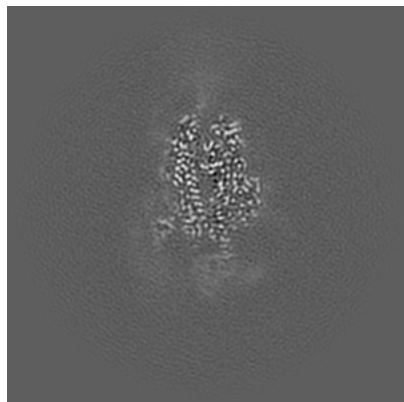

X Index: 160

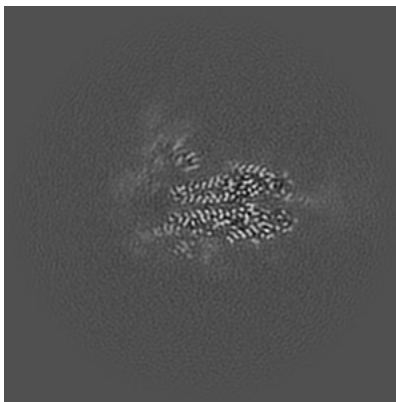

Y Index: 154

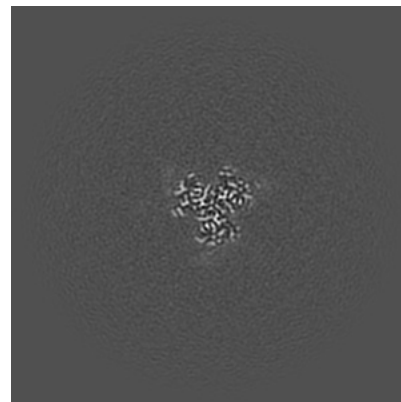

Z Index: 181

The images above show the largest variance slices of the map in three orthogonal directions.

6.4 Orthogonal standard-deviation projections (False-color) [i](#)

6.4.1 Primary map

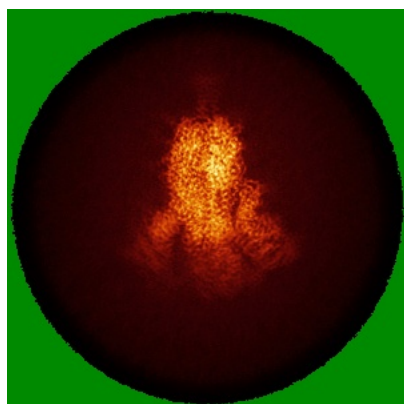

X

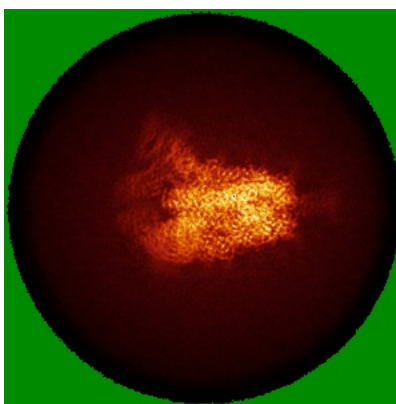

Y

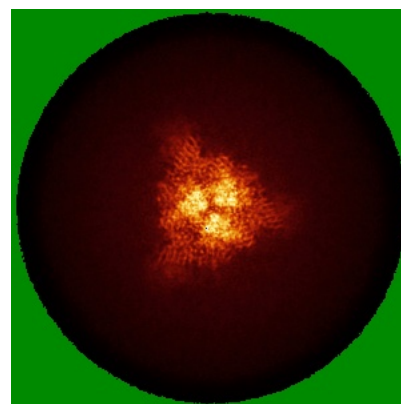

Z

The images above show the map standard deviation projections with false color in three orthogonal directions. Minimum values are shown in green, max in blue, and dark to light orange shades represent small to large values respectively.

6.5 Orthogonal surface views [i](#)

6.5.1 Primary map



The images above show the 3D surface view of the map at the recommended contour level 0.28. These images, in conjunction with the slice images, may facilitate assessment of whether an appropriate contour level has been provided.

6.6 Mask visualisation [i](#)

This section was not generated. No masks/segmentation were deposited.

7 Map analysis [i](#)

This section contains the results of statistical analysis of the map.

7.1 Map-value distribution [i](#)

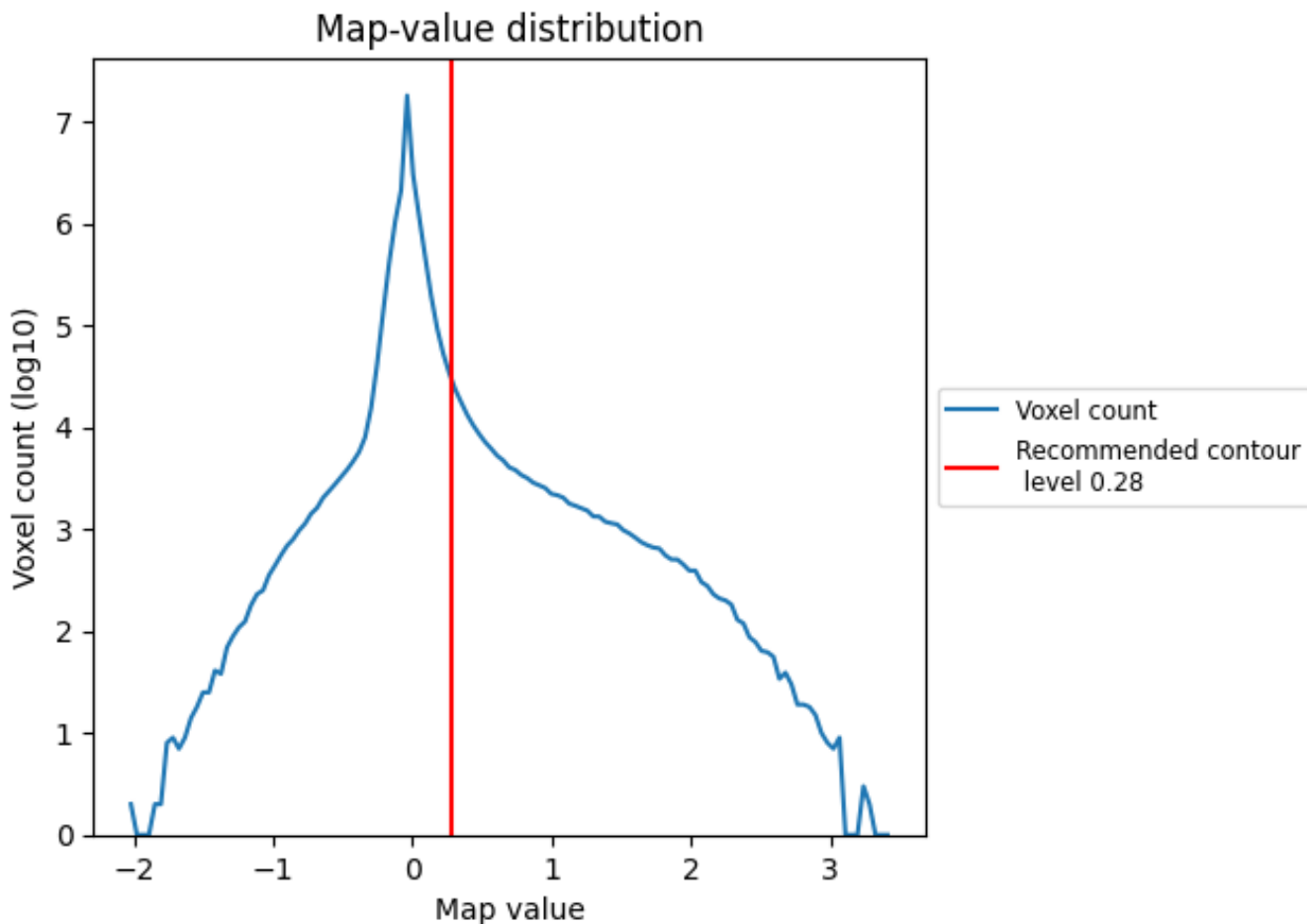

The map-value distribution is plotted in 128 intervals along the x-axis. The y-axis is logarithmic. A spike in this graph at zero usually indicates that the volume has been masked.

7.2 Volume estimate [i](#)

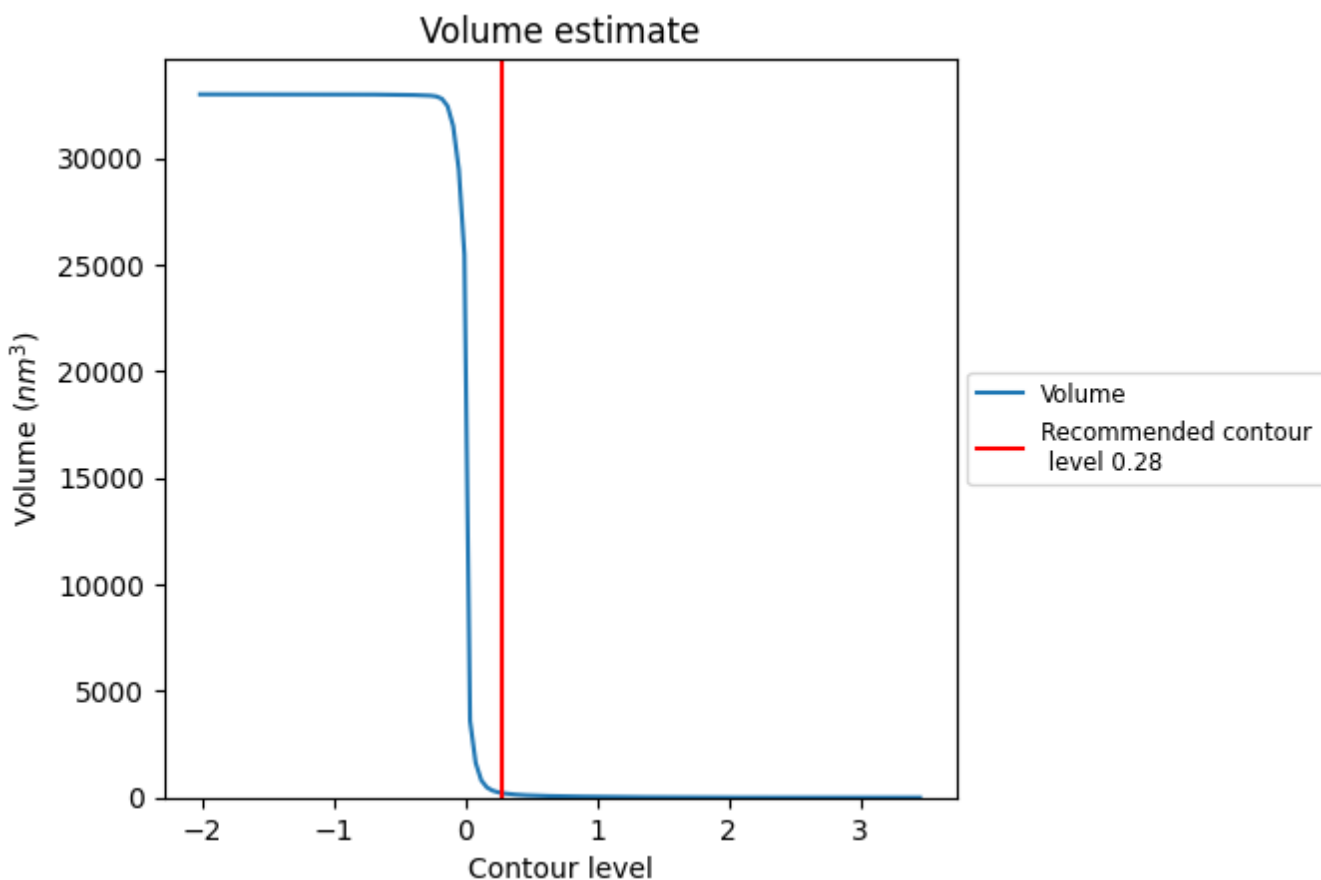

The volume at the recommended contour level is 209 nm³; this corresponds to an approximate mass of 188 kDa.

The volume estimate graph shows how the enclosed volume varies with the contour level. The recommended contour level is shown as a vertical line and the intersection between the line and the curve gives the volume of the enclosed surface at the given level.

7.3 Rotationally averaged power spectrum [i](#)

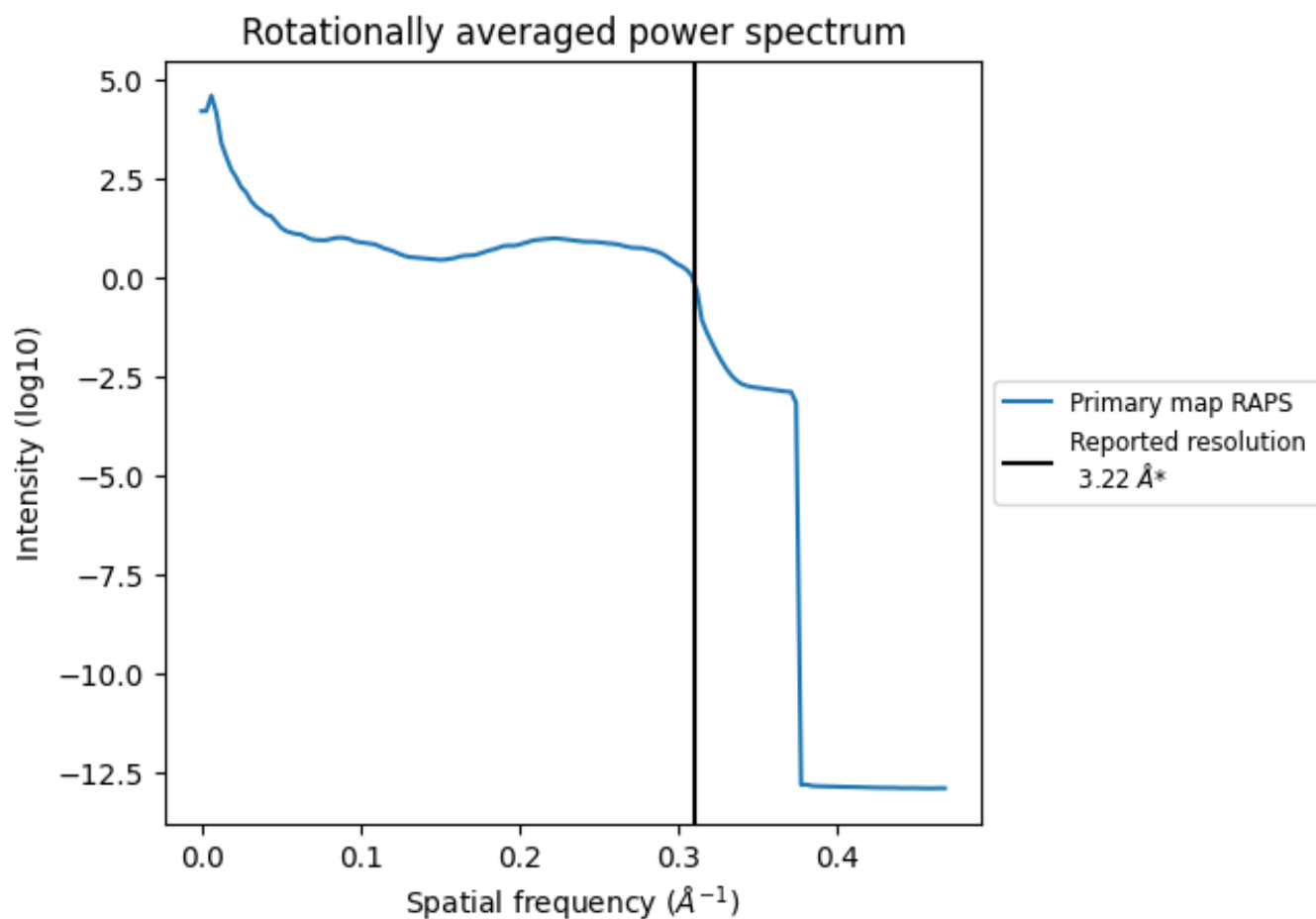

*Reported resolution corresponds to spatial frequency of 0.311 Å⁻¹

8 Fourier-Shell correlation

This section was not generated. No FSC curve or half-maps provided.

9 Map-model fit [i](#)

This section contains information regarding the fit between EMDB map EMD-23557 and PDB model 7LWU. Per-residue inclusion information can be found in section [3](#) on page [13](#).

9.1 Map-model overlay [i](#)

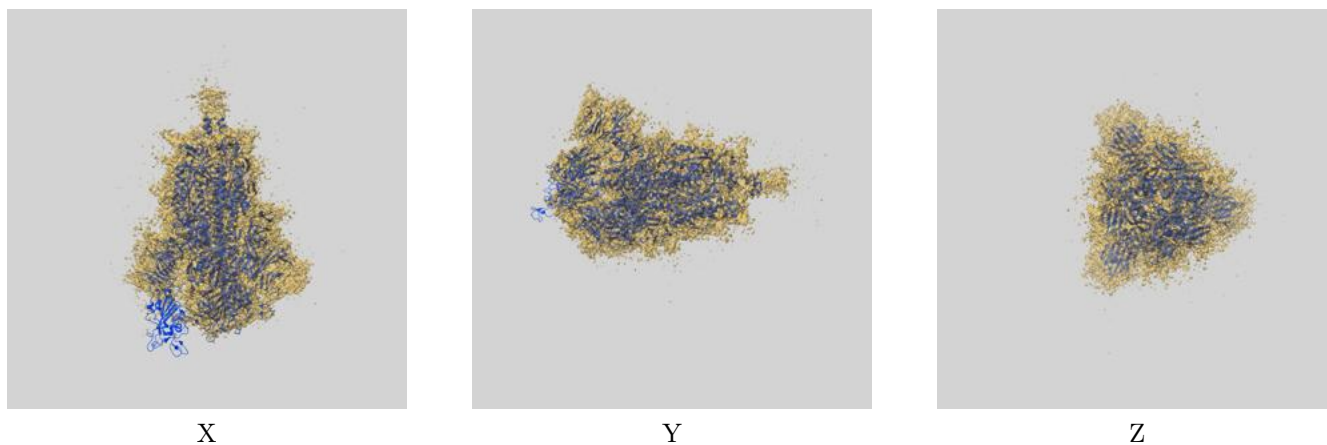

The images above show the 3D surface view of the map at the recommended contour level 0.28 at 50% transparency in yellow overlaid with a ribbon representation of the model coloured in blue. These images allow for the visual assessment of the quality of fit between the atomic model and the map.

9.2 Q-score mapped to coordinate model [\(i\)](#)

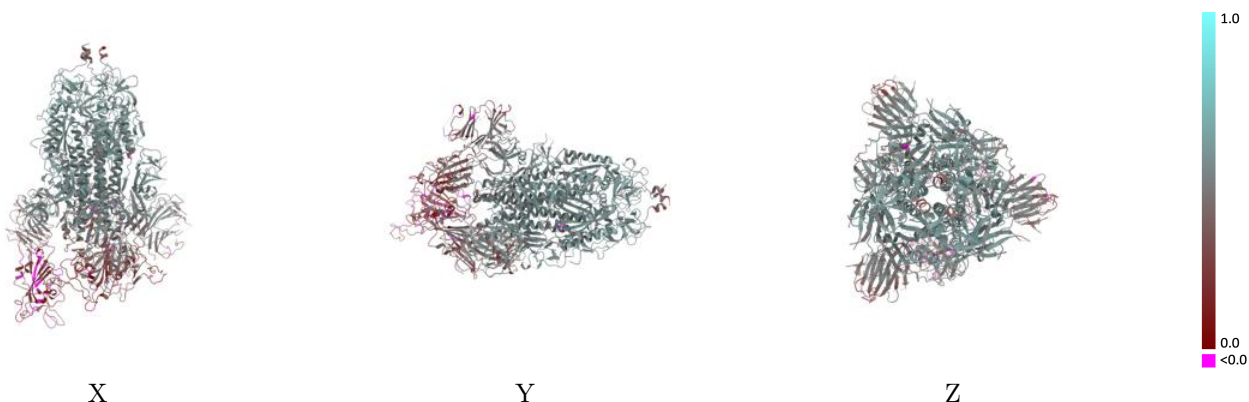

The images above show the model with each residue coloured according to its Q-score. This shows their resolvability in the map with higher Q-score values reflecting better resolvability. Please note: Q-score is calculating the resolvability of atoms, and thus high values are only expected at resolutions at which atoms can be resolved. Low Q-score values may therefore be expected for many entries.

9.3 Atom inclusion mapped to coordinate model [\(i\)](#)

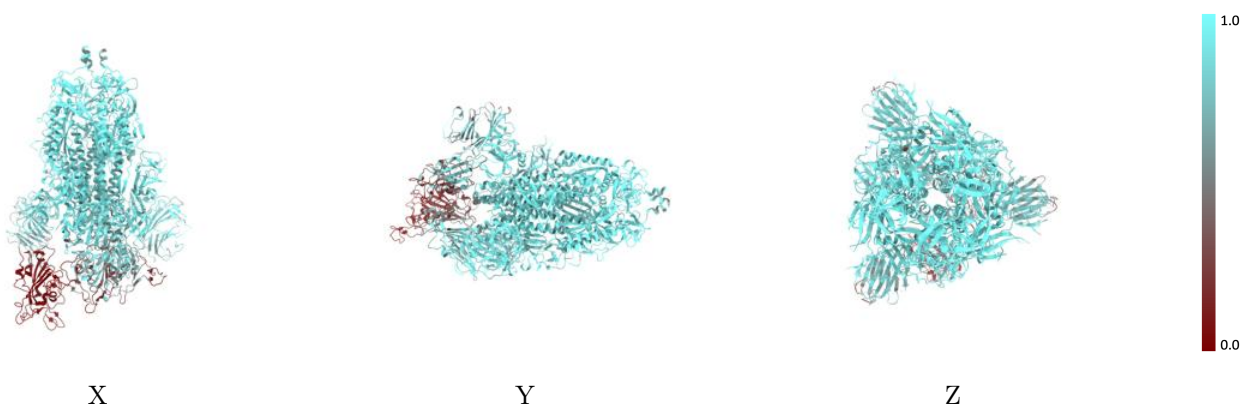

The images above show the model with each residue coloured according to its atom inclusion. This shows to what extent they are inside the map at the recommended contour level (0.28).



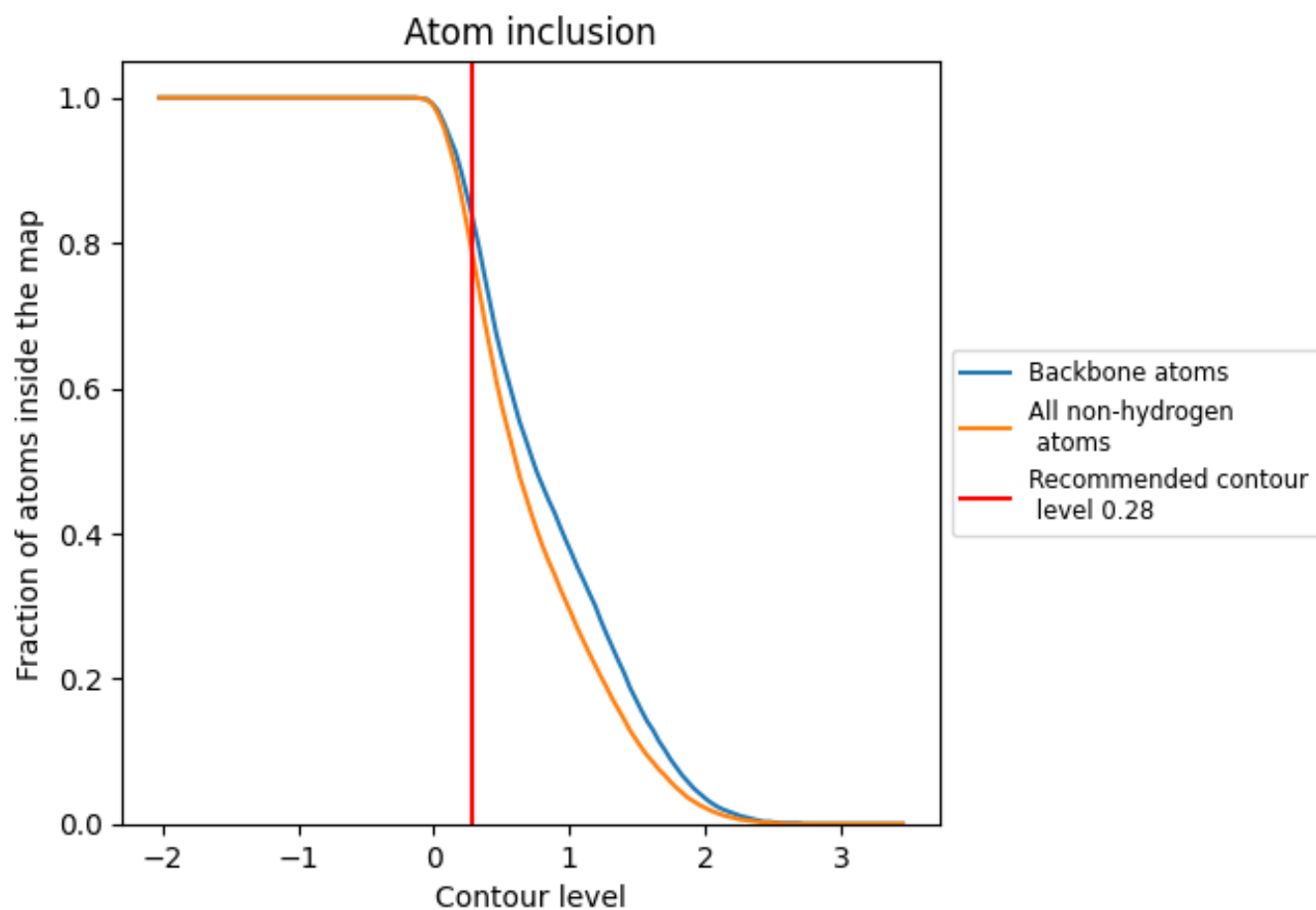





9.4 Atom inclusion [i](#)



At the recommended contour level, 84% of all backbone atoms, 79% of all non-hydrogen atoms, are inside the map.

9.5 Map-model fit summary

The table lists the average atom inclusion at the recommended contour level (0.28) and Q-score for the entire model and for each chain.

Chain	Atom inclusion	Q-score
All	 0.7900	 0.4540
A	 0.8160	 0.4670
B	 0.7210	 0.4300
C	 0.8350	 0.4660

