



# Full wwPDB X-ray Structure Validation Report ⓘ

Oct 10, 2023 – 03:33 AM EDT

PDB ID : 7MP1  
Title : CRYSTAL STRUCTURE OF NATIVE BOVINE ARRESTIN 1 IN COMPLEX WITH 1,5-DI-METHYLENEBISPHOSPHONATE INOSITOL TETRAKISPHOSPHATE (1,5-PCP-IP4)  
Authors : Sander, C.L.; Palczewski, K.; Kiser, P.D.  
Deposited on : 2021-05-04  
Resolution : 2.66 Å(reported)

This is a Full wwPDB X-ray Structure Validation Report for a publicly released PDB entry.

We welcome your comments at [validation@mail.wwpdb.org](mailto:validation@mail.wwpdb.org)

A user guide is available at

<https://www.wwpdb.org/validation/2017/XrayValidationReportHelp>

with specific help available everywhere you see the ⓘ symbol.

The types of validation reports are described at

<http://www.wwpdb.org/validation/2017/FAQs#types>.

---

The following versions of software and data (see [references ⓘ](#)) were used in the production of this report:

MolProbity : 4.02b-467  
Mogul : 1.8.5 (274361), CSD as541be (2020)  
Xtriage (Phenix) : 1.13  
EDS : 2.35.1  
buster-report : 1.1.7 (2018)  
Percentile statistics : 20191225.v01 (using entries in the PDB archive December 25th 2019)  
Refmac : 5.8.0158  
CCP4 : 7.0.044 (Gargrove)  
Ideal geometry (proteins) : Engh & Huber (2001)  
Ideal geometry (DNA, RNA) : Parkinson et al. (1996)  
Validation Pipeline (wwPDB-VP) : 2.35.1

# 1 Overall quality at a glance

The following experimental techniques were used to determine the structure:

*X-RAY DIFFRACTION*

The reported resolution of this entry is 2.66 Å.

Percentile scores (ranging between 0-100) for global validation metrics of the entry are shown in the following graphic. The table shows the number of entries on which the scores are based.

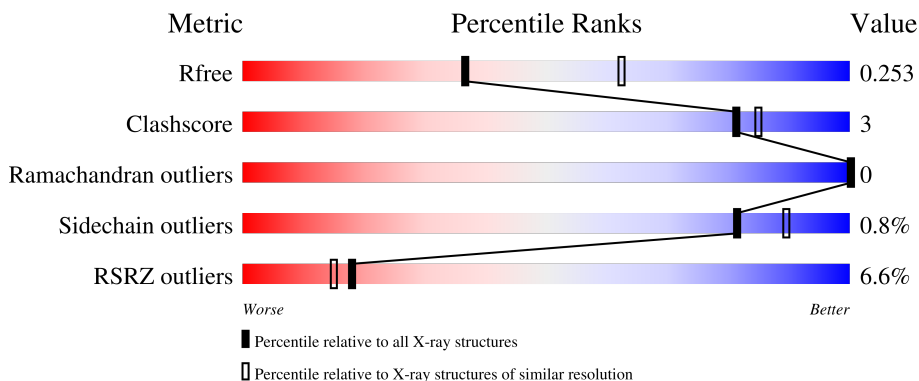

Metric	Whole archive (#Entries)	Similar resolution (#Entries, resolution range(Å))
$R_{free}$	130704	1332 (2.68-2.64)
Clashscore	141614	1374 (2.68-2.64)
Ramachandran outliers	138981	1349 (2.68-2.64)
Sidechain outliers	138945	1349 (2.68-2.64)
RSRZ outliers	127900	1318 (2.68-2.64)

The table below summarises the geometric issues observed across the polymeric chains and their fit to the electron density. The red, orange, yellow and green segments of the lower bar indicate the fraction of residues that contain outliers for  $\geq 3$ , 2, 1 and 0 types of geometric quality criteria respectively. A grey segment represents the fraction of residues that are not modelled. The numeric value for each fraction is indicated below the corresponding segment, with a dot representing fractions  $\leq 5\%$ . The upper red bar (where present) indicates the fraction of residues that have poor fit to the electron density. The numeric value is given above the bar.

Mol	Chain	Length	Quality of chain
1	A	404	 3% 85% 7% 8%
1	B	404	 8% 83% 6% 11%
1	C	404	 3% 82% 8% 10%
1	D	404	 10% 85% 6% 9%

## 2 Entry composition i

There are 3 unique types of molecules in this entry. The entry contains 11750 atoms, of which 0 are hydrogens and 0 are deuteriums.

In the tables below, the ZeroOcc column contains the number of atoms modelled with zero occupancy, the AltConf column contains the number of residues with at least one atom in alternate conformation and the Trace column contains the number of residues modelled with at most 2 atoms.

- Molecule 1 is a protein called S-arrestin.

Mol	Chain	Residues	Atoms					ZeroOcc	AltConf	Trace
			Total	C	N	O	S			
1	A	370	Total 2917	C 1868	N 490	O 550	S 9	0	0	0
1	B	361	Total 2853	C 1826	N 479	O 539	S 9	0	0	0
1	C	363	Total 2857	C 1828	N 482	O 539	S 8	0	0	0
1	D	368	Total 2887	C 1846	N 484	O 548	S 9	0	0	0

- Molecule 2 is  $\{[(1R,3S,4S,5R,6S)\text{-}2,4,5,6\text{-tetrakis(phosphonoxy)cyclohexane-1,3-diyl}]b\text{is[oxy(hydroxyphosphoryl)methanediyl]}\}\text{bis(phosphonic acid)}$  (three-letter code: 4WZ) (formula:  $C_8H_{24}O_{28}P_8$ ) (labeled as "Ligand of Interest" by depositor).

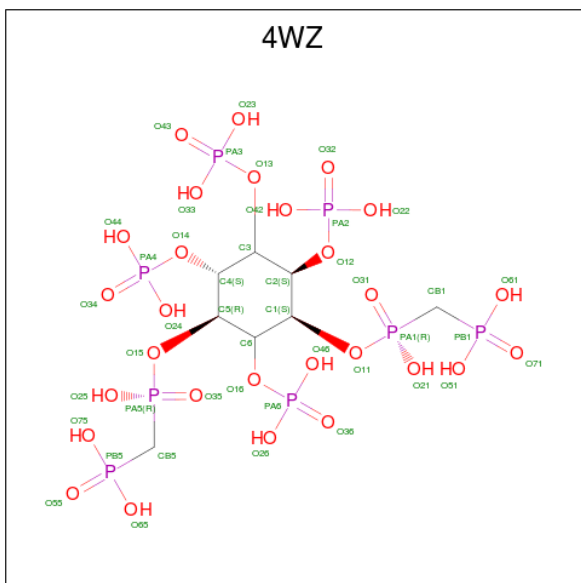

Mol	Chain	Residues	Atoms				ZeroOcc	AltConf
			Total	C	O	P		
2	B	1	Total 44	C 8	O 28	P 8	0	0

*Continued on next page...*

*Continued from previous page...*

Mol	Chain	Residues	Atoms				ZeroOcc	AltConf
2	B	1	Total	C	O	P	0	0
			44	8	28	8		
2	C	1	Total	C	O	P	0	0
			44	8	28	8		
2	D	1	Total	C	O	P	0	0
			44	8	28	8		
2	D	1	Total	C	O	P	0	0
			44	8	28	8		

- Molecule 3 is water.

Mol	Chain	Residues	Atoms		ZeroOcc	AltConf
3	A	5	Total	O	0	0
			5	5		
3	B	7	Total	O	0	0
			7	7		
3	C	1	Total	O	0	0
			1	1		
3	D	3	Total	O	0	0
			3	3		

### 3 Residue-property plots [i](#)

These plots are drawn for all protein, RNA, DNA and oligosaccharide chains in the entry. The first graphic for a chain summarises the proportions of the various outlier classes displayed in the second graphic. The second graphic shows the sequence view annotated by issues in geometry and electron density. Residues are color-coded according to the number of geometric quality criteria for which they contain at least one outlier: green = 0, yellow = 1, orange = 2 and red = 3 or more. A red dot above a residue indicates a poor fit to the electron density ( $RSRZ > 2$ ). Stretches of 2 or more consecutive residues without any outlier are shown as a green connector. Residues present in the sample, but not in the model, are shown in grey.

- Molecule 1: S-arrestin

Chain A: 

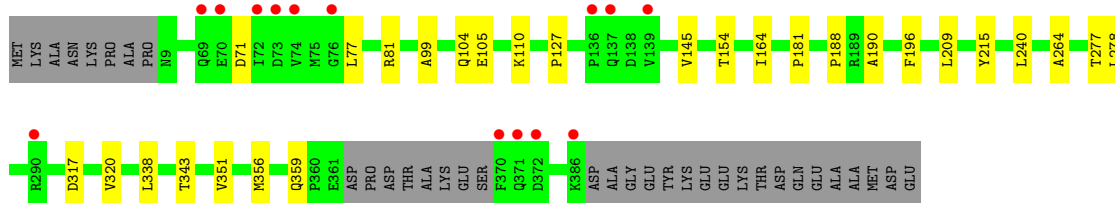

- Molecule 1: S-arrestin

Chain B: 

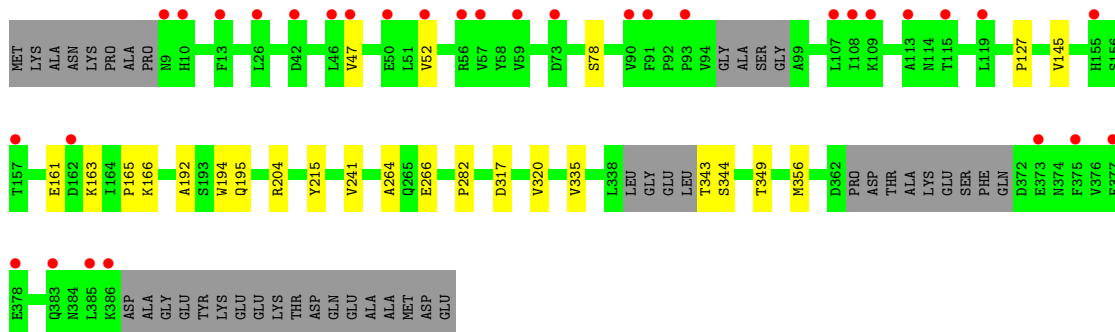

- Molecule 1: S-arrestin

Chain C: 

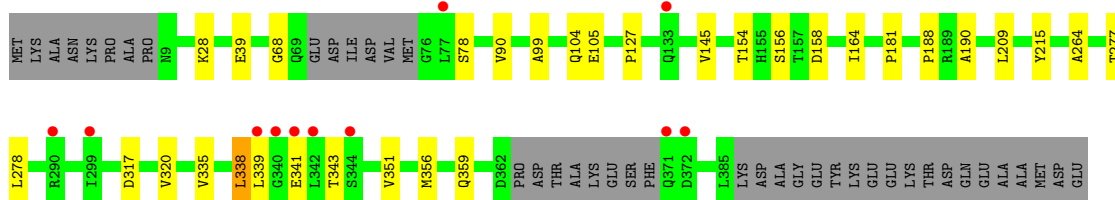

- Molecule 1: S-arrestin

Chain D: 

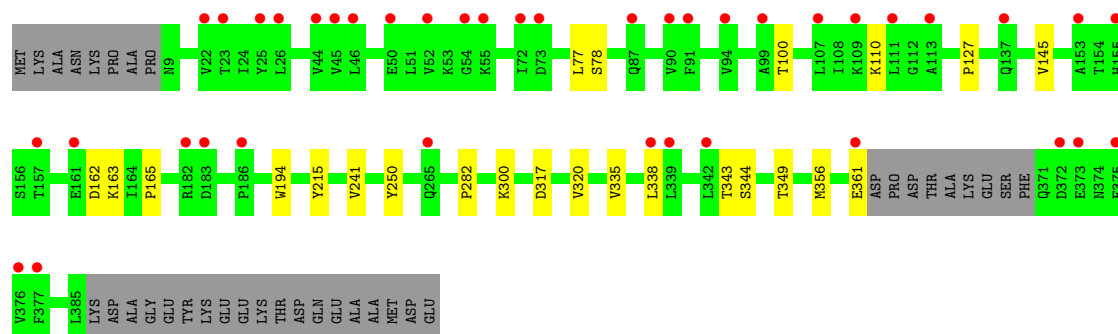

## 4 Data and refinement statistics

Property	Value	Source
Space group	P 21 21 2	Depositor
Cell constants a, b, c, $\alpha$ , $\beta$ , $\gamma$	168.47Å 187.23Å 90.74Å 90.00° 90.00° 90.00°	Depositor
Resolution (Å)	49.23 – 2.66 49.18 – 2.66	Depositor EDS
% Data completeness (in resolution range)	99.5 (49.23-2.66) 99.6 (49.18-2.66)	Depositor EDS
$R_{merge}$	0.14	Depositor
$R_{sym}$	(Not available)	Depositor
$\langle I/\sigma(I) \rangle$ <sup>1</sup>	1.42 (at 2.65Å)	Xtrriage
Refinement program	REFMAC 5.8.0267	Depositor
R, $R_{free}$	0.220 , 0.248 0.230 , 0.253	Depositor DCC
$R_{free}$ test set	4133 reflections (4.99%)	wwPDB-VP
Wilson B-factor (Å <sup>2</sup> )	77.0	Xtrriage
Anisotropy	0.292	Xtrriage
Bulk solvent $k_{sol}$ (e/Å <sup>3</sup> ), $B_{sol}$ (Å <sup>2</sup> )	0.30 , 46.6	EDS
L-test for twinning <sup>2</sup>	$\langle  L  \rangle = 0.50$ , $\langle L^2 \rangle = 0.33$	Xtrriage
Estimated twinning fraction	No twinning to report.	Xtrriage
$F_o, F_c$ correlation	0.94	EDS
Total number of atoms	11750	wwPDB-VP
Average B, all atoms (Å <sup>2</sup> )	93.0	wwPDB-VP

Xtrriage's analysis on translational NCS is as follows: *The largest off-origin peak in the Patterson function is 2.83% of the height of the origin peak. No significant pseudotranslation is detected.*

<sup>1</sup>Intensities estimated from amplitudes.

<sup>2</sup>Theoretical values of  $\langle |L| \rangle$ ,  $\langle L^2 \rangle$  for acentric reflections are 0.5, 0.333 respectively for untwinned datasets, and 0.375, 0.2 for perfectly twinned datasets.

## 5 Model quality [i](#)

### 5.1 Standard geometry [i](#)

Bond lengths and bond angles in the following residue types are not validated in this section: 4WZ

The Z score for a bond length (or angle) is the number of standard deviations the observed value is removed from the expected value. A bond length (or angle) with  $|Z| > 5$  is considered an outlier worth inspection. RMSZ is the root-mean-square of all Z scores of the bond lengths (or angles).

Mol	Chain	Bond lengths		Bond angles	
		RMSZ	# Z  >5	RMSZ	# Z  >5
1	A	0.63	0/2975	0.75	0/4033
1	B	0.64	0/2908	0.74	0/3942
1	C	0.63	0/2913	0.74	0/3949
1	D	0.64	0/2944	0.74	0/3996
All	All	0.64	0/11740	0.74	0/15920

There are no bond length outliers.

There are no bond angle outliers.

There are no chirality outliers.

There are no planarity outliers.

### 5.2 Too-close contacts [i](#)

In the following table, the Non-H and H(model) columns list the number of non-hydrogen atoms and hydrogen atoms in the chain respectively. The H(added) column lists the number of hydrogen atoms added and optimized by MolProbity. The Clashes column lists the number of clashes within the asymmetric unit, whereas Symm-Clashes lists symmetry-related clashes.

Mol	Chain	Non-H	H(model)	H(added)	Clashes	Symm-Clashes
1	A	2917	0	2972	16	0
1	B	2853	0	2899	17	0
1	C	2857	0	2910	19	0
1	D	2887	0	2921	11	0
2	B	88	0	24	1	0
2	C	44	0	12	0	0
2	D	88	0	24	1	0
3	A	5	0	0	0	0
3	B	7	0	0	0	0

*Continued on next page...*



*Continued from previous page...*

Mol	Chain	Non-H	H(model)	H(added)	Clashes	Symm-Clashes
3	C	1	0	0	0	0
3	D	3	0	0	0	0
All	All	11750	0	11762	61	0

The all-atom clashscore is defined as the number of clashes found per 1000 atoms (including hydrogen atoms). The all-atom clashscore for this structure is 3.

All (61) close contacts within the same asymmetric unit are listed below, sorted by their clash magnitude.

Atom-1	Atom-2	Interatomic distance (Å)	Clash overlap (Å)
1:A:154:THR:HG22	1:A:164:ILE:HG12	1.74	0.69
1:C:154:THR:HG22	1:C:164:ILE:HG12	1.76	0.66
1:B:52:VAL:HG12	1:B:52:VAL:O	2.00	0.61
1:C:264:ALA:HB2	1:C:278:LEU:HD21	1.83	0.60
1:D:194:TRP:CD2	1:D:349:THR:HG21	2.38	0.59
1:A:264:ALA:HB2	1:A:278:LEU:HD21	1.86	0.57
1:C:28:LYS:HE3	1:C:39:GLU:OE1	2.06	0.56
1:B:194:TRP:CD2	1:B:349:THR:HG21	2.42	0.55
1:D:335:VAL:O	1:D:344:SER:HB2	2.06	0.55
1:C:338:LEU:HB2	1:C:343:THR:HG22	1.90	0.54
1:D:127:PRO:HG2	1:D:145:VAL:HG11	1.90	0.54
1:B:161:GLU:HG3	1:B:163:LYS:HB3	1.90	0.53
1:B:335:VAL:O	1:B:344:SER:HB2	2.07	0.53
1:C:127:PRO:HG2	1:C:145:VAL:HG11	1.91	0.53
1:A:215:TYR:HA	1:A:356:MET:O	2.10	0.52
1:B:127:PRO:HG2	1:B:145:VAL:HG11	1.90	0.52
1:C:215:TYR:HA	1:C:356:MET:O	2.10	0.52
1:A:196:PHE:CE1	1:A:338:LEU:HD11	2.45	0.52
1:C:335:VAL:HB	1:C:338:LEU:HD21	1.90	0.51
1:C:317:ASP:O	1:C:320:VAL:HG22	2.11	0.51
1:B:215:TYR:HA	1:B:356:MET:O	2.10	0.51
1:A:240:LEU:HD12	1:A:240:LEU:N	2.26	0.50
1:D:215:TYR:HA	1:D:356:MET:O	2.11	0.50
1:D:317:ASP:O	1:D:320:VAL:HG22	2.12	0.50
1:A:127:PRO:HG2	1:A:145:VAL:HG11	1.92	0.50
1:B:317:ASP:O	1:B:320:VAL:HG22	2.13	0.49
1:A:317:ASP:O	1:A:320:VAL:HG22	2.12	0.49
1:B:194:TRP:CZ2	1:B:349:THR:HB	2.48	0.48
1:B:163:LYS:HE2	1:B:165:PRO:HA	1.96	0.47
1:C:99:ALA:HB3	1:C:105:GLU:HG3	1.96	0.47
1:D:77:LEU:HD21	1:D:250:TYR:OH	2.15	0.47

*Continued on next page...*

Continued from previous page...

Atom-1	Atom-2	Interatomic distance (Å)	Clash overlap (Å)
1:D:163:LYS:HE2	1:D:165:PRO:HA	1.96	0.47
1:B:47:VAL:HB	1:B:52:VAL:HG21	1.97	0.47
1:B:52:VAL:O	1:B:52:VAL:CG1	2.63	0.45
1:C:190:ALA:HB2	1:C:351:VAL:HG22	1.97	0.45
1:A:99:ALA:HB3	1:A:105:GLU:HG3	1.99	0.45
1:D:194:TRP:CZ2	1:D:349:THR:HB	2.52	0.45
1:A:277:THR:HB	1:B:343:THR:HG21	1.99	0.45
1:B:195:GLN:HG2	1:B:204:ARG:HG3	1.97	0.45
1:C:338:LEU:O	1:C:341:GLU:N	2.49	0.45
1:A:190:ALA:HB2	1:A:351:VAL:HG22	1.98	0.45
1:B:163:LYS:HD3	2:B:502:4WZ:H22	1.99	0.45
1:C:188:PRO:HG2	1:C:209:LEU:HB2	2.00	0.44
1:C:99:ALA:HB1	1:C:104:GLN:HB2	1.99	0.44
1:A:188:PRO:HG2	1:A:209:LEU:HB2	2.00	0.44
1:A:71:ASP:OD1	1:A:77:LEU:N	2.51	0.43
1:C:68:GLY:HA3	1:C:78:SER:HB3	2.01	0.43
1:B:264:ALA:HB1	1:B:266:GLU:OE2	2.19	0.43
1:C:338:LEU:HD12	1:C:339:LEU:H	1.84	0.43
1:C:156:SER:OG	1:C:158:ASP:O	2.36	0.42
1:C:181:PRO:O	1:C:359:GLN:NE2	2.53	0.42
1:A:181:PRO:O	1:A:359:GLN:NE2	2.52	0.41
1:C:277:THR:HB	1:D:343:THR:HG21	2.02	0.41
1:A:99:ALA:HB1	1:A:104:GLN:HB2	2.03	0.41
1:A:338:LEU:HB3	1:A:343:THR:HG22	2.03	0.41
1:D:300:LYS:NZ	2:D:502:4WZ:O44	2.54	0.41
1:B:192:ALA:HB3	1:B:194:TRP:CH2	2.57	0.40
1:A:110:LYS:HA	1:A:110:LYS:HD2	1.97	0.40
1:D:241:VAL:HG11	1:D:282:PRO:HB3	2.04	0.40
1:B:241:VAL:HG11	1:B:282:PRO:HB3	2.03	0.40
1:C:335:VAL:HB	1:C:338:LEU:HD11	2.02	0.40

There are no symmetry-related clashes.

## 5.3 Torsion angles [i](#)

### 5.3.1 Protein backbone [i](#)

In the following table, the Percentiles column shows the percent Ramachandran outliers of the chain as a percentile score with respect to all X-ray entries followed by that with respect to entries of similar resolution.

The Analysed column shows the number of residues for which the backbone conformation was analysed, and the total number of residues.

Mol	Chain	Analysed	Favoured	Allowed	Outliers	Percentiles	
1	A	366/404 (91%)	346 (94%)	20 (6%)	0	100	100
1	B	353/404 (87%)	343 (97%)	10 (3%)	0	100	100
1	C	357/404 (88%)	341 (96%)	16 (4%)	0	100	100
1	D	364/404 (90%)	350 (96%)	14 (4%)	0	100	100
All	All	1440/1616 (89%)	1380 (96%)	60 (4%)	0	100	100

There are no Ramachandran outliers to report.

### 5.3.2 Protein sidechains [i](#)

In the following table, the Percentiles column shows the percent sidechain outliers of the chain as a percentile score with respect to all X-ray entries followed by that with respect to entries of similar resolution.

The Analysed column shows the number of residues for which the sidechain conformation was analysed, and the total number of residues.

Mol	Chain	Analysed	Rotameric	Outliers	Percentiles	
1	A	330/359 (92%)	329 (100%)	1 (0%)	92	96
1	B	324/359 (90%)	322 (99%)	2 (1%)	86	92
1	C	323/359 (90%)	321 (99%)	2 (1%)	86	92
1	D	325/359 (90%)	319 (98%)	6 (2%)	59	75
All	All	1302/1436 (91%)	1291 (99%)	11 (1%)	81	89

All (11) residues with a non-rotameric sidechain are listed below:

Mol	Chain	Res	Type
1	A	81	ARG
1	B	78	SER
1	B	166	LYS
1	C	90	VAL
1	C	338	LEU
1	D	78	SER
1	D	100	THR
1	D	110	LYS
1	D	162	ASP
1	D	338	LEU

*Continued on next page...*

*Continued from previous page...*

Mol	Chain	Res	Type
1	D	361	GLU

Sometimes sidechains can be flipped to improve hydrogen bonding and reduce clashes. There are no such sidechains identified.

### 5.3.3 RNA [i](#)

There are no RNA molecules in this entry.

## 5.4 Non-standard residues in protein, DNA, RNA chains [i](#)

There are no non-standard protein/DNA/RNA residues in this entry.

## 5.5 Carbohydrates [i](#)

There are no monosaccharides in this entry.

## 5.6 Ligand geometry [i](#)

5 ligands are modelled in this entry.

In the following table, the Counts columns list the number of bonds (or angles) for which Mogul statistics could be retrieved, the number of bonds (or angles) that are observed in the model and the number of bonds (or angles) that are defined in the Chemical Component Dictionary. The Link column lists molecule types, if any, to which the group is linked. The Z score for a bond length (or angle) is the number of standard deviations the observed value is removed from the expected value. A bond length (or angle) with  $|Z| > 2$  is considered an outlier worth inspection. RMSZ is the root-mean-square of all Z scores of the bond lengths (or angles).

Mol	Type	Chain	Res	Link	Bond lengths			Bond angles		
					Counts	RMSZ	# Z  > 2	Counts	RMSZ	# Z  > 2
2	4WZ	D	502	-	40,44,44	0.60	2 (5%)	64,74,74	0.99	2 (3%)
2	4WZ	C	501	-	40,44,44	0.57	2 (5%)	64,74,74	0.91	2 (3%)
2	4WZ	B	501	-	40,44,44	0.58	2 (5%)	64,74,74	0.90	2 (3%)
2	4WZ	B	502	-	40,44,44	0.53	1 (2%)	64,74,74	0.95	2 (3%)
2	4WZ	D	501	-	40,44,44	0.51	1 (2%)	64,74,74	0.92	2 (3%)

In the following table, the Chirals column lists the number of chiral outliers, the number of chiral centers analysed, the number of these observed in the model and the number defined in the

Chemical Component Dictionary. Similar counts are reported in the Torsion and Rings columns. '-' means no outliers of that kind were identified.

Mol	Type	Chain	Res	Link	Chirals	Torsions	Rings
2	4WZ	D	502	-	-	13/40/66/66	0/1/1/1
2	4WZ	C	501	-	-	12/40/66/66	0/1/1/1
2	4WZ	B	501	-	-	10/40/66/66	0/1/1/1
2	4WZ	B	502	-	-	14/40/66/66	0/1/1/1
2	4WZ	D	501	-	-	12/40/66/66	0/1/1/1

All (8) bond length outliers are listed below:

Mol	Chain	Res	Type	Atoms	Z	Observed(Å)	Ideal(Å)
2	D	502	4WZ	PA6-O16	2.61	1.64	1.59
2	C	501	4WZ	PA6-O16	2.38	1.63	1.59
2	D	502	4WZ	PA3-O13	2.23	1.63	1.59
2	B	502	4WZ	PA3-O13	2.23	1.63	1.59
2	B	501	4WZ	PA6-O16	2.21	1.63	1.59
2	B	501	4WZ	PA3-O13	2.17	1.63	1.59
2	D	501	4WZ	PA3-O13	2.14	1.63	1.59
2	C	501	4WZ	PA3-O13	2.08	1.63	1.59

All (10) bond angle outliers are listed below:

Mol	Chain	Res	Type	Atoms	Z	Observed(°)	Ideal(°)
2	D	502	4WZ	O31-PA1-CB1	4.74	121.59	109.07
2	B	502	4WZ	O35-PA5-CB5	4.71	121.53	109.07
2	D	502	4WZ	O35-PA5-CB5	4.67	121.40	109.07
2	B	501	4WZ	O35-PA5-CB5	4.64	121.34	109.07
2	D	501	4WZ	O35-PA5-CB5	4.61	121.26	109.07
2	C	501	4WZ	O35-PA5-CB5	4.56	121.14	109.07
2	C	501	4WZ	O31-PA1-CB1	4.52	121.02	109.07
2	D	501	4WZ	O31-PA1-CB1	4.45	120.84	109.07
2	B	502	4WZ	O31-PA1-CB1	4.45	120.82	109.07
2	B	501	4WZ	O31-PA1-CB1	4.44	120.81	109.07

There are no chirality outliers.

All (61) torsion outliers are listed below:

Mol	Chain	Res	Type	Atoms
2	B	501	4WZ	C1-C2-O12-PA2
2	B	501	4WZ	PA5-CB5-PB5-O55

*Continued on next page...*

*Continued from previous page...*

Mol	Chain	Res	Type	Atoms
2	B	501	4WZ	PA5-CB5-PB5-O65
2	B	501	4WZ	PA5-CB5-PB5-O75
2	B	501	4WZ	PA1-CB1-PB1-O61
2	B	501	4WZ	PA1-CB1-PB1-O71
2	B	502	4WZ	C1-C2-O12-PA2
2	B	502	4WZ	C3-C2-O12-PA2
2	B	502	4WZ	C4-C5-O15-PA5
2	B	502	4WZ	C6-C5-O15-PA5
2	B	502	4WZ	C1-C6-O16-PA6
2	B	502	4WZ	C5-C6-O16-PA6
2	B	502	4WZ	C1-O11-PA1-O31
2	B	502	4WZ	PB1-CB1-PA1-O11
2	B	502	4WZ	PB1-CB1-PA1-O21
2	B	502	4WZ	PB1-CB1-PA1-O31
2	C	501	4WZ	C1-C2-O12-PA2
2	C	501	4WZ	PB5-CB5-PA5-O25
2	C	501	4WZ	PB5-CB5-PA5-O35
2	C	501	4WZ	PB5-CB5-PA5-O15
2	C	501	4WZ	C3-O13-PA3-O43
2	D	501	4WZ	PB5-CB5-PA5-O25
2	D	501	4WZ	PB5-CB5-PA5-O35
2	D	501	4WZ	PB5-CB5-PA5-O15
2	D	501	4WZ	PA1-CB1-PB1-O61
2	D	501	4WZ	PA1-CB1-PB1-O71
2	D	501	4WZ	PA1-CB1-PB1-O51
2	D	502	4WZ	C2-C1-O11-PA1
2	D	502	4WZ	C1-C2-O12-PA2
2	D	502	4WZ	C3-C2-O12-PA2
2	D	502	4WZ	C3-C4-O14-PA4
2	D	502	4WZ	C5-C4-O14-PA4
2	D	502	4WZ	PB5-CB5-PA5-O25
2	D	502	4WZ	PB5-CB5-PA5-O35
2	D	502	4WZ	C5-O15-PA5-O35
2	B	502	4WZ	C2-C1-O11-PA1
2	B	502	4WZ	C6-C1-O11-PA1
2	D	502	4WZ	C6-C1-O11-PA1
2	C	501	4WZ	C3-C2-O12-PA2
2	B	502	4WZ	C1-O11-PA1-CB1
2	B	502	4WZ	C3-O13-PA3-O43
2	C	501	4WZ	C6-O16-PA6-O36
2	B	501	4WZ	C3-C2-O12-PA2
2	B	501	4WZ	C6-O16-PA6-O46

*Continued on next page...*

*Continued from previous page...*

Mol	Chain	Res	Type	Atoms
2	D	501	4WZ	C2-C3-O13-PA3
2	D	501	4WZ	C4-C3-O13-PA3
2	D	502	4WZ	C3-O13-PA3-O33
2	C	501	4WZ	C1-O11-PA1-CB1
2	D	501	4WZ	PB1-CB1-PA1-O21
2	D	502	4WZ	C1-O11-PA1-CB1
2	D	502	4WZ	PA1-CB1-PB1-O51
2	D	501	4WZ	C5-O15-PA5-CB5
2	C	501	4WZ	C2-C1-O11-PA1
2	D	501	4WZ	PB1-CB1-PA1-O31
2	B	501	4WZ	C3-O13-PA3-O43
2	D	501	4WZ	C6-O16-PA6-O36
2	B	501	4WZ	C3-O13-PA3-O33
2	C	501	4WZ	C1-C6-O16-PA6
2	C	501	4WZ	C6-O16-PA6-O26
2	C	501	4WZ	C2-O12-PA2-O42
2	D	502	4WZ	C4-O14-PA4-O44

There are no ring outliers.

2 monomers are involved in 2 short contacts:

Mol	Chain	Res	Type	Clashes	Symm-Clashes
2	D	502	4WZ	1	0
2	B	502	4WZ	1	0

The following is a two-dimensional graphical depiction of Mogul quality analysis of bond lengths, bond angles, torsion angles, and ring geometry for all instances of the Ligand of Interest. In addition, ligands with molecular weight > 250 and outliers as shown on the validation Tables will also be included. For torsion angles, if less than 5% of the Mogul distribution of torsion angles is within 10 degrees of the torsion angle in question, then that torsion angle is considered an outlier. Any bond that is central to one or more torsion angles identified as an outlier by Mogul will be highlighted in the graph. For rings, the root-mean-square deviation (RMSD) between the ring in question and similar rings identified by Mogul is calculated over all ring torsion angles. If the average RMSD is greater than 60 degrees and the minimal RMSD between the ring in question and any Mogul-identified rings is also greater than 60 degrees, then that ring is considered an outlier. The outliers are highlighted in purple. The color gray indicates Mogul did not find sufficient equivalents in the CSD to analyse the geometry.

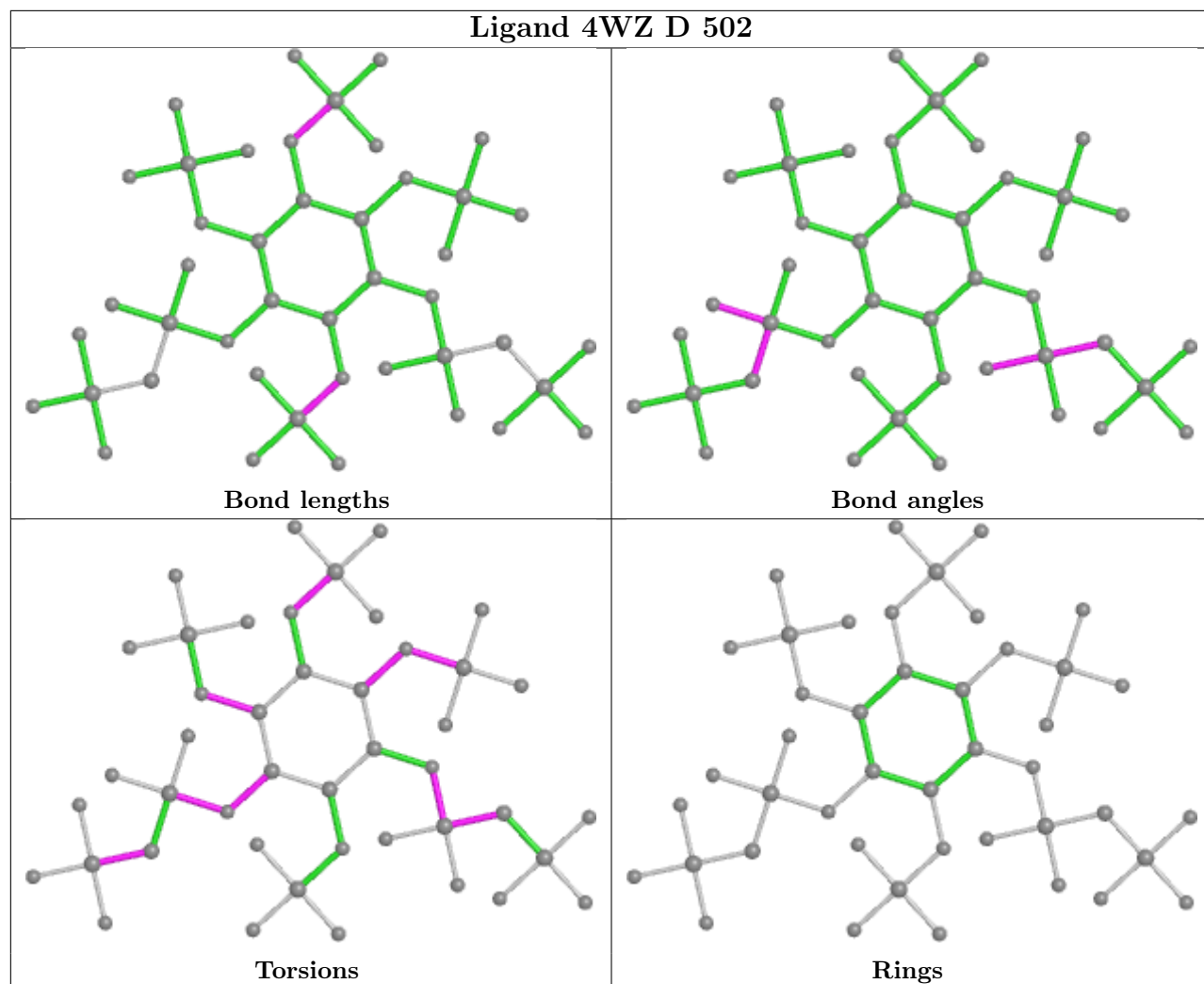



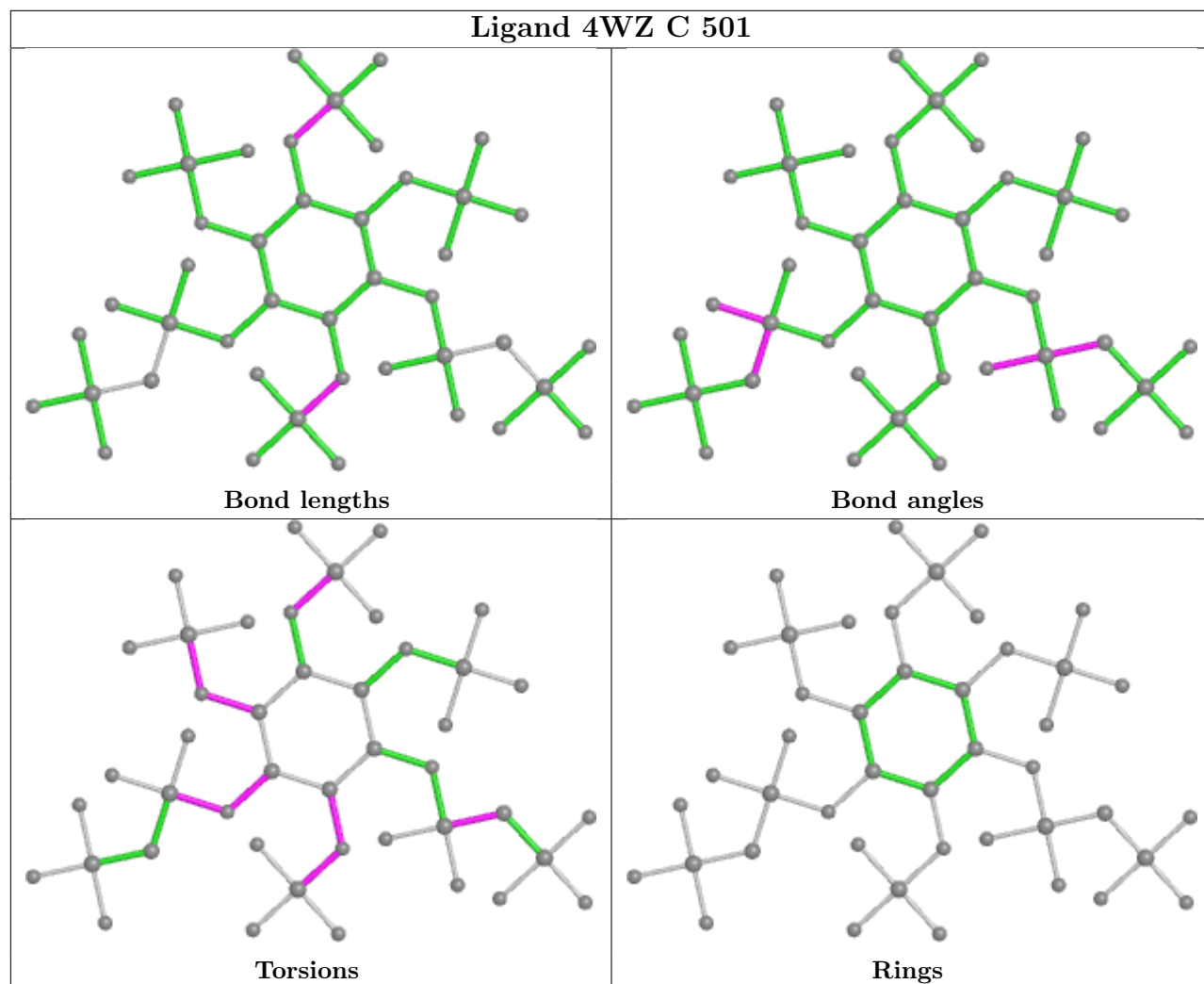

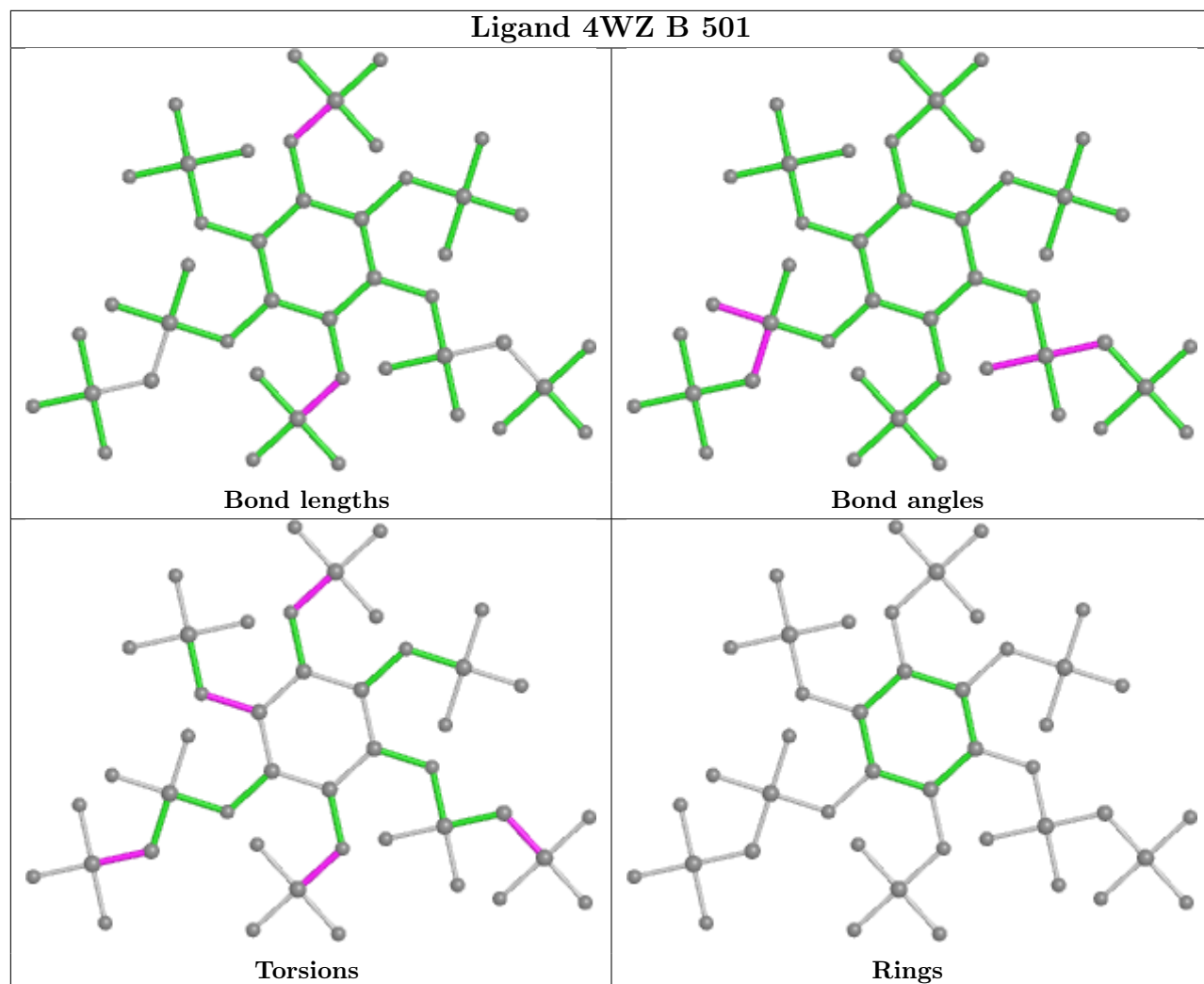

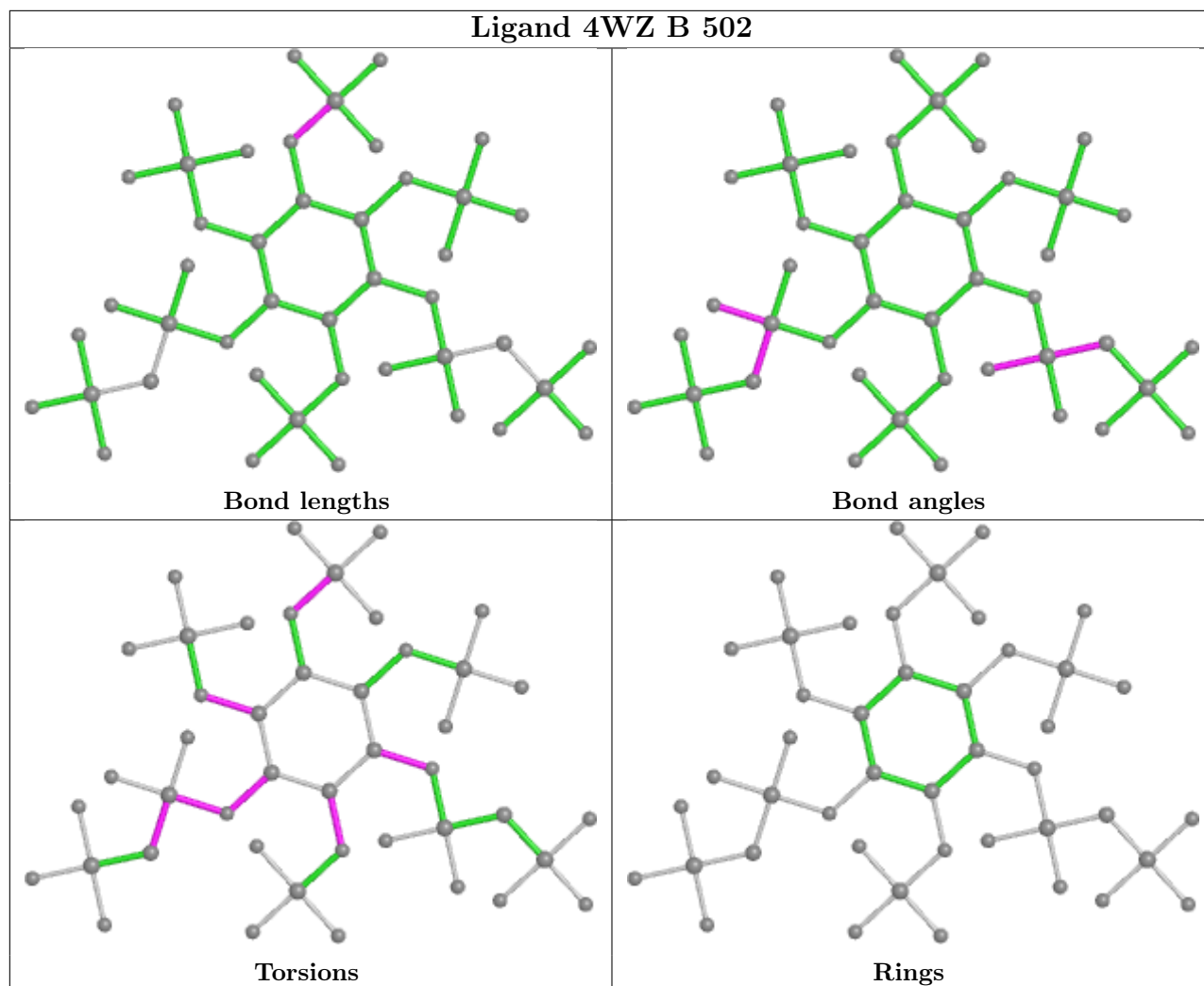

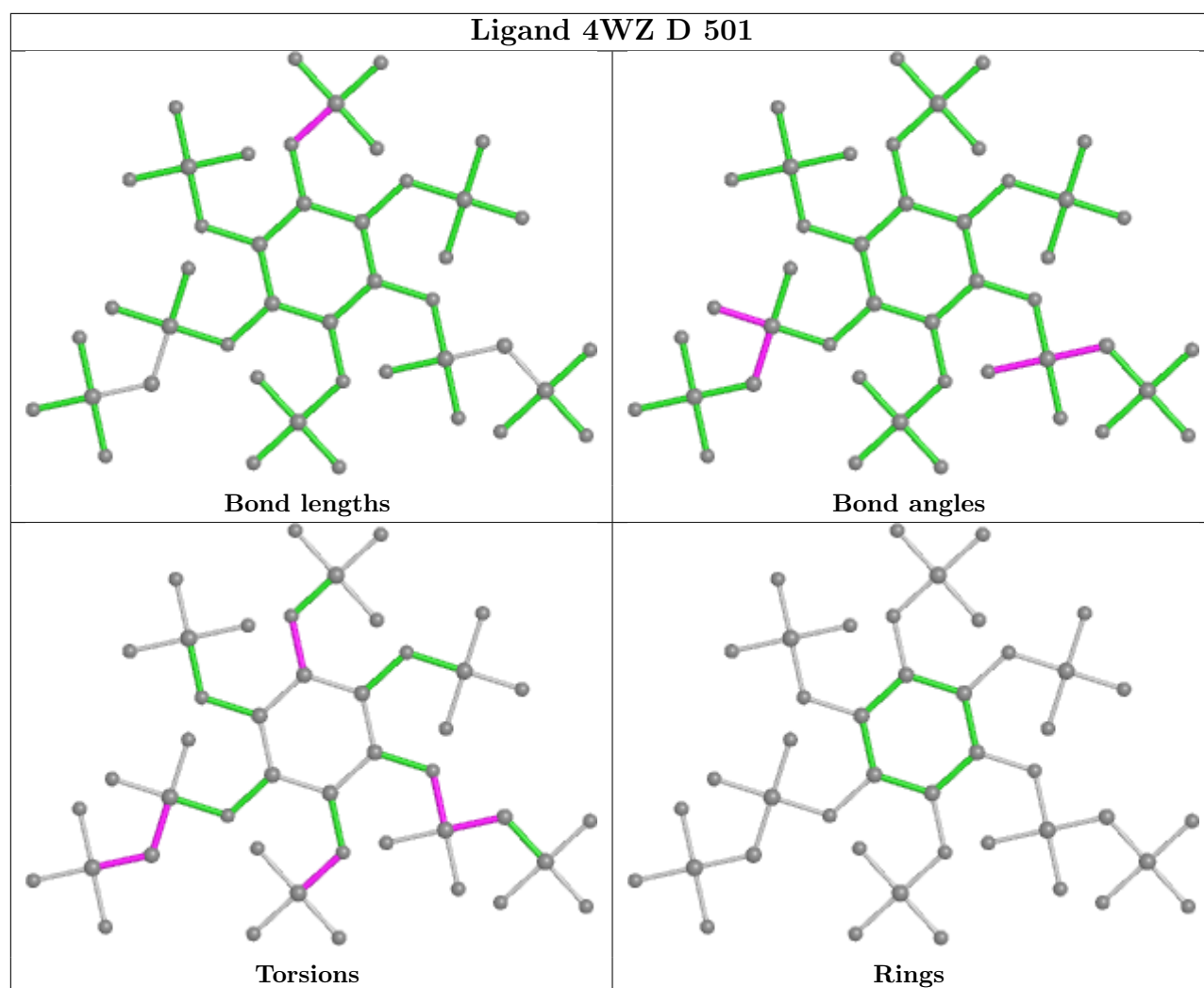

## 5.7 Other polymers [\(i\)](#)

There are no such residues in this entry.

## 5.8 Polymer linkage issues [\(i\)](#)

There are no chain breaks in this entry.

## 6 Fit of model and data

### 6.1 Protein, DNA and RNA chains

In the following table, the column labelled ‘#RSRZ > 2’ contains the number (and percentage) of RSRZ outliers, followed by percent RSRZ outliers for the chain as percentile scores relative to all X-ray entries and entries of similar resolution. The OWAB column contains the minimum, median, 95<sup>th</sup> percentile and maximum values of the occupancy-weighted average B-factor per residue. The column labelled ‘Q < 0.9’ lists the number of (and percentage) of residues with an average occupancy less than 0.9.

Mol	Chain	Analysed	<RSRZ>	#RSRZ>2	OWAB(Å <sup>2</sup> )	Q<0.9
1	A	370/404 (91%)	0.21	14 (3%) 40 36	57, 73, 124, 160	0
1	B	361/404 (89%)	0.49	32 (8%) 9 8	58, 94, 158, 191	0
1	C	363/404 (89%)	0.16	11 (3%) 50 47	60, 77, 124, 143	0
1	D	368/404 (91%)	0.53	40 (10%) 5 4	59, 90, 148, 165	0
All	All	1462/1616 (90%)	0.35	97 (6%) 18 15	57, 82, 147, 191	0

All (97) RSRZ outliers are listed below:

Mol	Chain	Res	Type	RSRZ
1	A	74	VAL	7.2
1	D	73	ASP	6.8
1	D	342	LEU	5.5
1	D	339	LEU	5.1
1	A	370	PHE	4.9
1	D	186	PRO	4.7
1	B	378	GLU	4.7
1	D	265	GLN	4.5
1	D	25	TYR	4.4
1	A	137	GLN	4.3
1	D	111	LEU	4.3
1	C	341	GLU	4.1
1	A	136	PRO	4.0
1	D	50	GLU	4.0
1	D	155	HIS	3.8
1	B	90	VAL	3.8
1	D	54	GLY	3.7
1	D	26	LEU	3.7
1	B	91	PHE	3.7
1	C	342	LEU	3.6
1	D	107	LEU	3.6

*Continued on next page...*

*Continued from previous page...*

<b>Mol</b>	<b>Chain</b>	<b>Res</b>	<b>Type</b>	<b>RSRZ</b>
1	D	91	PHE	3.6
1	D	44	VAL	3.5
1	A	290	ARG	3.5
1	B	59	VAL	3.5
1	B	107	LEU	3.5
1	B	155	HIS	3.5
1	D	375	PHE	3.5
1	D	377	PHE	3.4
1	B	57	VAL	3.4
1	D	45	VAL	3.4
1	B	385	LEU	3.4
1	A	69	GLN	3.4
1	C	77	LEU	3.3
1	D	72	ILE	3.3
1	A	73	ASP	3.3
1	B	9	ASN	3.2
1	B	377	PHE	3.2
1	D	182	ARG	3.0
1	C	371	GLN	3.0
1	B	109	LYS	2.9
1	B	52	VAL	2.9
1	C	340	GLY	2.8
1	B	10	HIS	2.8
1	B	157	THR	2.8
1	D	23	THR	2.8
1	B	115	THR	2.8
1	C	372	ASP	2.7
1	D	46	LEU	2.7
1	C	133	GLN	2.7
1	B	162	ASP	2.6
1	B	373	GLU	2.6
1	C	299	ILE	2.5
1	B	56	ARG	2.5
1	B	383	GLN	2.5
1	B	119	LEU	2.5
1	D	137	GLN	2.4
1	D	376	VAL	2.4
1	B	26	LEU	2.4
1	D	55	LYS	2.4
1	D	361	GLU	2.4
1	B	375	PHE	2.4
1	B	113	ALA	2.4

*Continued on next page...*

*Continued from previous page...*

Mol	Chain	Res	Type	RSRZ
1	B	386	LYS	2.4
1	B	50	GLU	2.4
1	A	372	ASP	2.3
1	D	338	LEU	2.3
1	D	161	GLU	2.3
1	A	386	LYS	2.3
1	C	344	SER	2.3
1	A	72	ILE	2.3
1	A	139	VAL	2.3
1	D	157	THR	2.3
1	D	99	ALA	2.3
1	D	22	VAL	2.3
1	D	109	LYS	2.3
1	D	113	ALA	2.2
1	D	183	ASP	2.2
1	B	47	VAL	2.2
1	B	108	ILE	2.2
1	D	87	GLN	2.2
1	D	153	ALA	2.2
1	A	70	GLU	2.2
1	A	76	GLY	2.2
1	B	13	PHE	2.2
1	D	90	VAL	2.2
1	B	42	ASP	2.1
1	D	372	ASP	2.1
1	C	290	ARG	2.1
1	D	52	VAL	2.1
1	B	73	ASP	2.1
1	B	93	PRO	2.1
1	D	94	VAL	2.1
1	C	339	LEU	2.0
1	B	46	LEU	2.0
1	D	373	GLU	2.0
1	A	371	GLN	2.0

## 6.2 Non-standard residues in protein, DNA, RNA chains

There are no non-standard protein/DNA/RNA residues in this entry.

### 6.3 Carbohydrates [i](#)

There are no monosaccharides in this entry.

### 6.4 Ligands [i](#)

In the following table, the Atoms column lists the number of modelled atoms in the group and the number defined in the chemical component dictionary. The B-factors column lists the minimum, median, 95<sup>th</sup> percentile and maximum values of B factors of atoms in the group. The column labelled 'Q< 0.9' lists the number of atoms with occupancy less than 0.9.

Mol	Type	Chain	Res	Atoms	RSCC	RSR	B-factors(Å <sup>2</sup> )	Q<0.9
2	4WZ	B	502	44/44	0.69	0.20	177,214,226,231	0
2	4WZ	C	501	44/44	0.72	0.18	170,188,204,205	0
2	4WZ	B	501	44/44	0.79	0.17	181,200,206,209	0
2	4WZ	D	502	44/44	0.81	0.18	139,197,202,209	0
2	4WZ	D	501	44/44	0.82	0.15	170,195,206,212	0

The following is a graphical depiction of the model fit to experimental electron density of all instances of the Ligand of Interest. In addition, ligands with molecular weight > 250 and outliers as shown on the geometry validation Tables will also be included. Each fit is shown from different orientation to approximate a three-dimensional view.



**Electron density around 4WZ B 502:**

$2mF_o-DF_c$  (at 0.7 rmsd) in gray  
 $mF_o-DF_c$  (at 3 rmsd) in purple (negative)  
and green (positive)

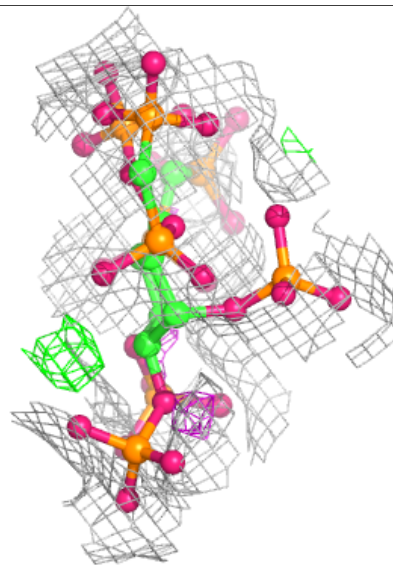
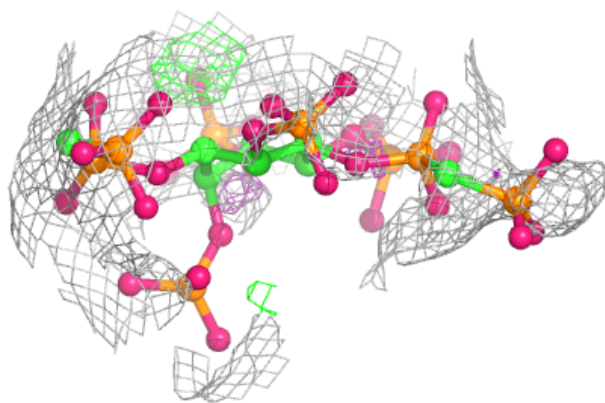
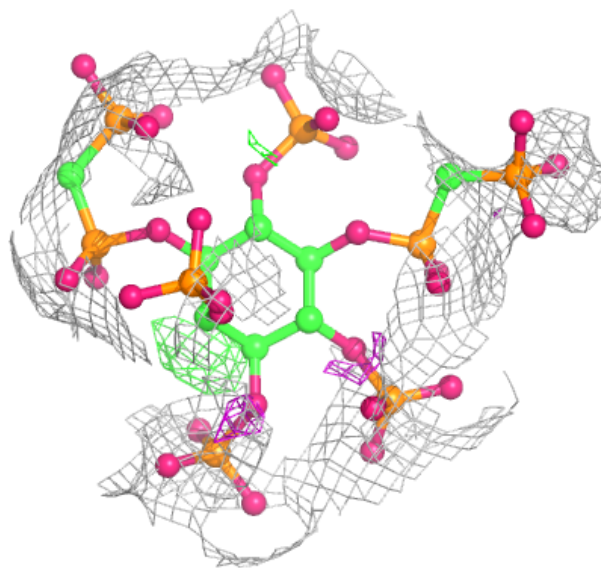

**Electron density around 4WZ C 501:**

$2mF_o-DF_c$  (at 0.7 rmsd) in gray  
 $mF_o-DF_c$  (at 3 rmsd) in purple (negative)  
and green (positive)

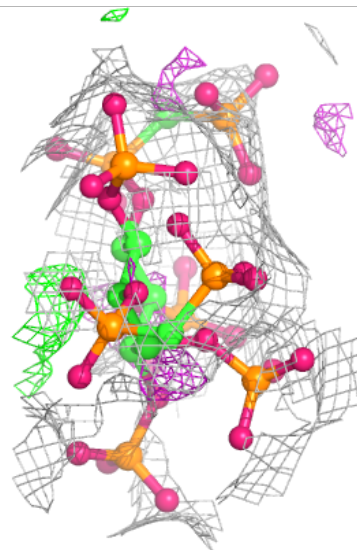
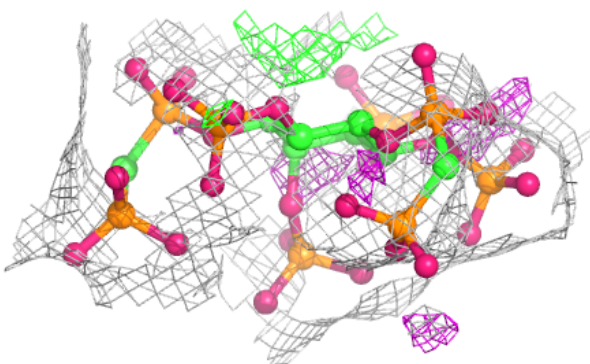
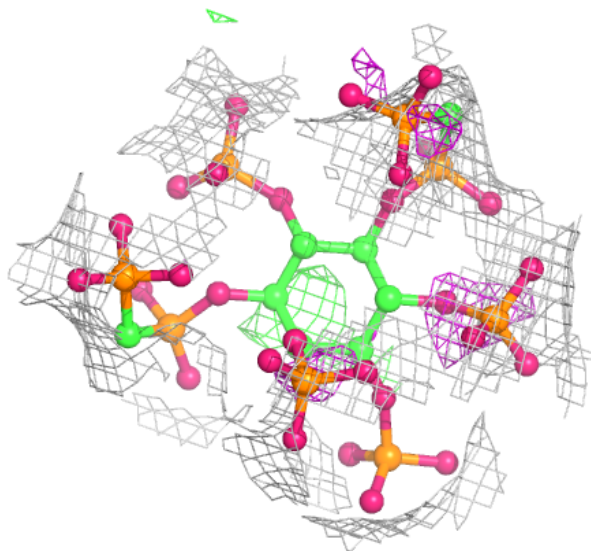

**Electron density around 4WZ B 501:**

$2mF_o-DF_c$  (at 0.7 rmsd) in gray  
 $mF_o-DF_c$  (at 3 rmsd) in purple (negative)  
and green (positive)

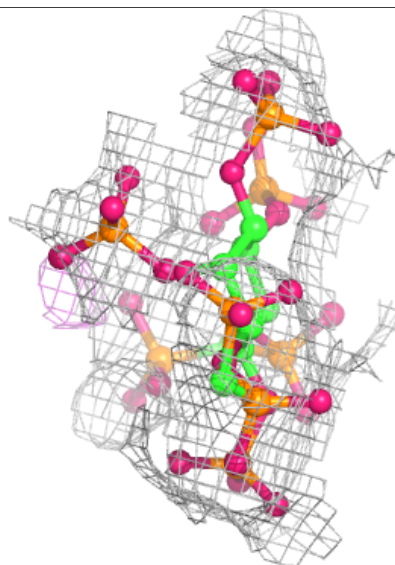
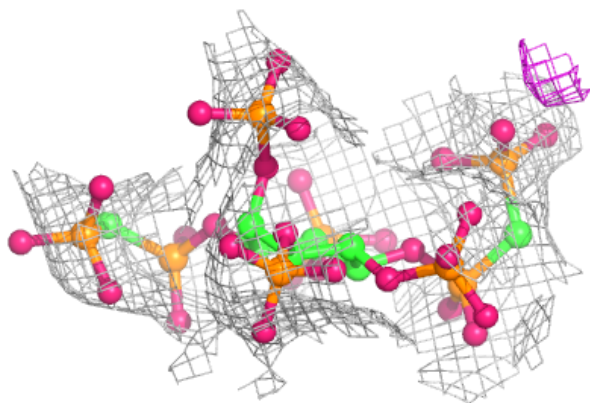
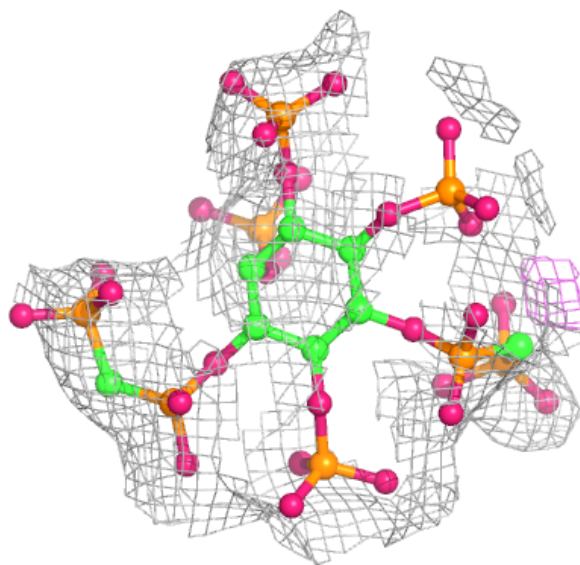

**Electron density around 4WZ D 502:**

$2mF_o-DF_c$  (at 0.7 rmsd) in gray  
 $mF_o-DF_c$  (at 3 rmsd) in purple (negative)  
and green (positive)

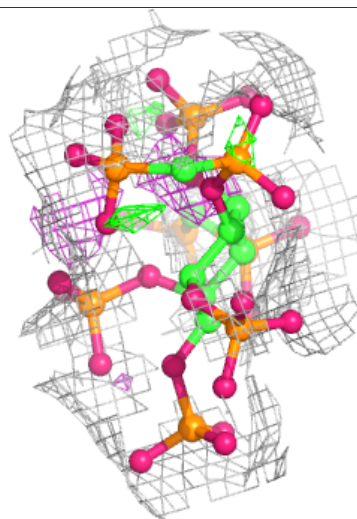
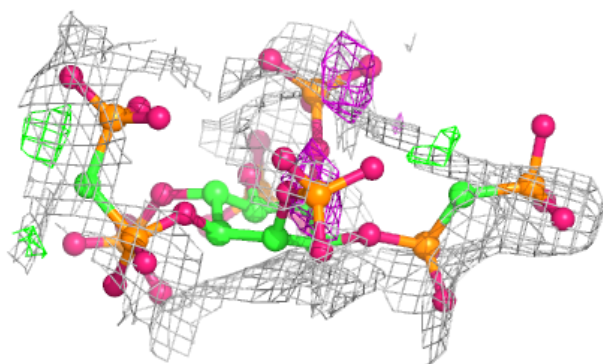
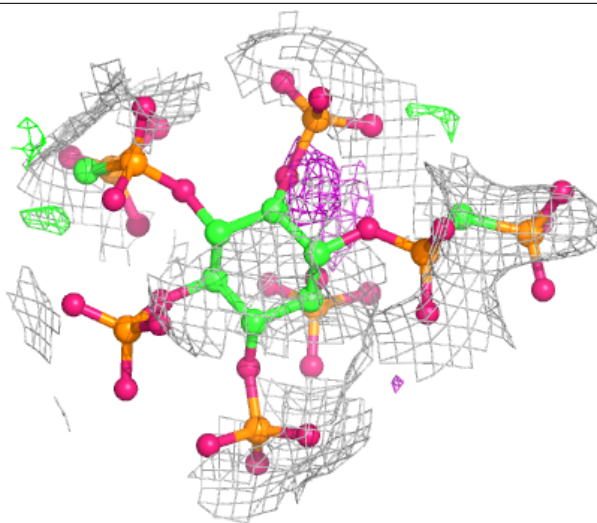

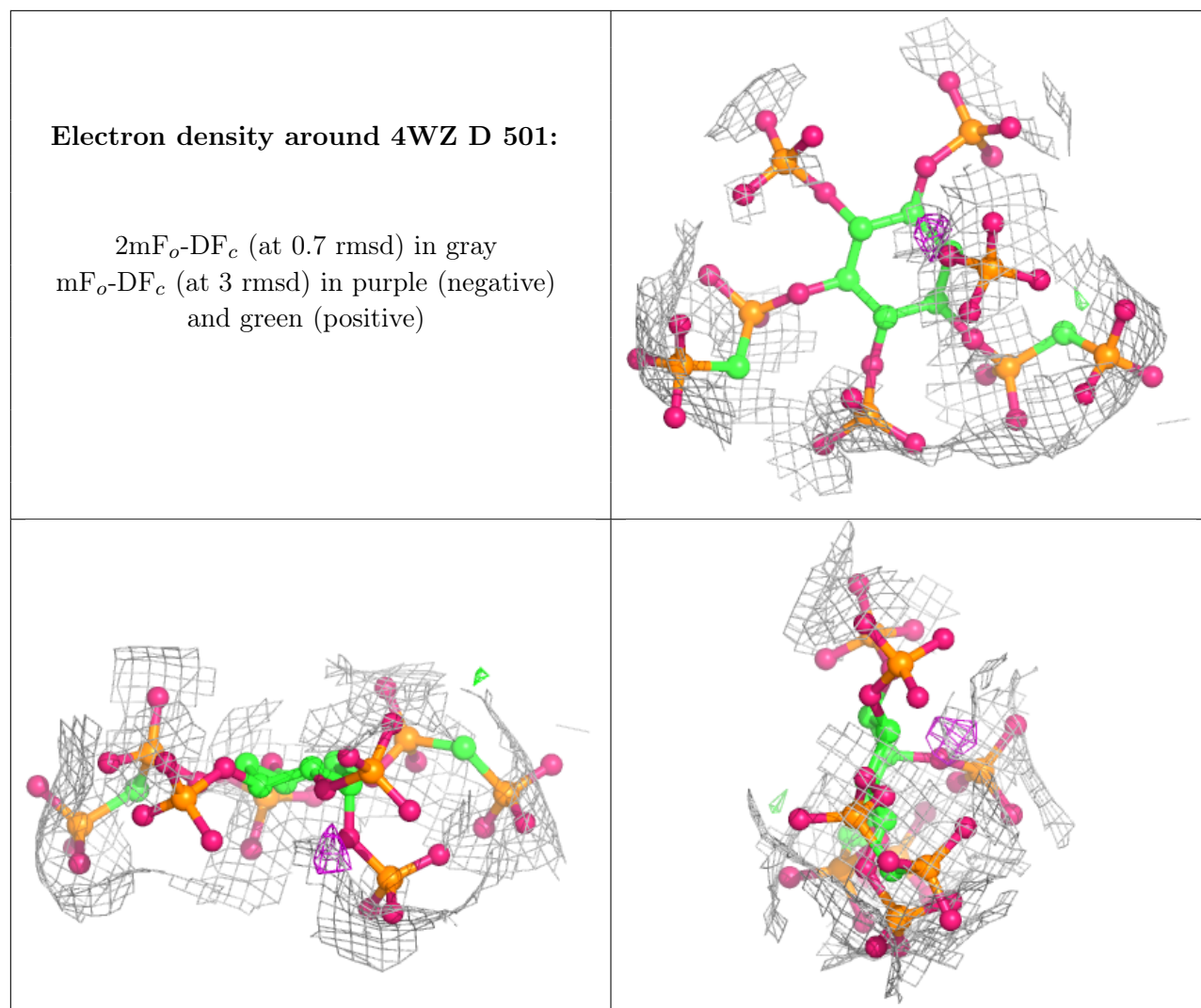

## 6.5 Other polymers [i](#)

There are no such residues in this entry.