



wwPDB EM Validation Summary Report ⓘ

Dec 18, 2023 – 06:41 PM EST

PDB ID : 1O1F
EMDB ID : EMD-1001
Title : MOLECULAR MODELS OF AVERAGED RIGOR CROSSBRIDGES FROM TOMOGRAMS OF INSECT FLIGHT MUSCLE
Authors : Chen, L.F.; Winkler, H.; Reedy, M.K.; Reedy, M.C.; Taylor, K.A.
Deposited on : 2002-11-15
Resolution : 70.00 Å (reported)
Based on initial models : 1ATN, 2MYS

This is a wwPDB EM Validation Summary Report for a publicly released PDB entry.

We welcome your comments at validation@mail.wwpdb.org

A user guide is available at

<https://www.wwpdb.org/validation/2017/EMValidationReportHelp>

with specific help available everywhere you see the ⓘ symbol.

The types of validation reports are described at

<http://www.wwpdb.org/validation/2017/FAQs#types>.

The following versions of software and data (see [references ⓘ](#)) were used in the production of this report:

EMDB validation analysis : 0.0.1.dev70
Mogul : 1.8.5 (274361), CSD as541be (2020)
MolProbity : 4.02b-467
Percentile statistics : 20191225.v01 (using entries in the PDB archive December 25th 2019)
MapQ : 1.9.9
Ideal geometry (proteins) : Engh & Huber (2001)
Ideal geometry (DNA, RNA) : Parkinson et al. (1996)
Validation Pipeline (wwPDB-VP) : 2.36

1 Overall quality at a glance i

The following experimental techniques were used to determine the structure:

ELECTRON MICROSCOPY

The reported resolution of this entry is 70.00 Å.

Percentile scores (ranging between 0-100) for global validation metrics of the entry are shown in the following graphic. The table shows the number of entries on which the scores are based.

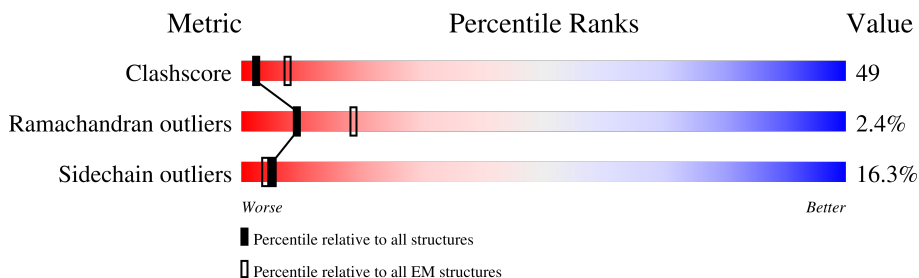

Metric	Whole archive (#Entries)	EM structures (#Entries)
Clashscore	158937	4297
Ramachandran outliers	154571	4023
Sidechain outliers	154315	3826

The table below summarises the geometric issues observed across the polymeric chains and their fit to the map. The red, orange, yellow and green segments of the bar indicate the fraction of residues that contain outliers for ≥ 3 , 2, 1 and 0 types of geometric quality criteria respectively. A grey segment represents the fraction of residues that are not modelled. The numeric value for each fraction is indicated below the corresponding segment, with a dot representing fractions $\leq 5\%$. The upper red bar (where present) indicates the fraction of residues that have poor fit to the EM map (all-atom inclusion $< 40\%$). The numeric value is given above the bar.

Mol	Chain	Length	Quality of chain
1	A	840	100% 26% 50% 20% .
1	D	840	99% 26% 51% 20% .
1	G	840	100% 25% 51% 20% .
1	J	840	99% 25% 51% 20% .
2	B	145	100% 66% 26% 6% .
2	E	145	100% 63% 28% 6% .
2	H	145	100% 63% 28% 6% .
2	K	145	100% 65% 26% 6% .

Continued on next page...

Continued from previous page...

Mol	Chain	Length	Quality of chain		
3	C	147	100%	61%	37%
3	F	147	90%	61%	38%
3	I	147	100%	61%	37%
3	L	147	73%	61%	37%
4	0	375	99%	65%	27%
4	1	375	99%	64%	27%
4	2	375	99%	63%	28%
4	3	375	99%	63%	29%
4	4	375	95%	58%	32%
4	5	375	99%	58%	32%
4	6	375	98%	56%	33%
4	7	375	99%	56%	34%
4	8	375	93%	60%	30%
4	V	375	99%	61%	30%
4	W	375	99%	63%	28%
4	X	375	99%	63%	28%
4	Y	375	99%	64%	28%
4	Z	375	99%	64%	28%

The following table lists non-polymeric compounds, carbohydrate monomers and non-standard residues in protein, DNA, RNA chains that are outliers for geometric or electron-density-fit criteria:

Mol	Type	Chain	Res	Chirality	Geometry	Clashes	Electron density
1	MLY	A	505	-	-	X	-
1	MLY	A	553	-	-	X	-
1	MLY	A	764	-	-	X	-
1	MLY	A	768	-	-	X	-
1	MLY	A	839	-	-	X	-
1	MLY	D	553	-	-	X	-
1	MLY	D	782	-	-	X	-

Continued on next page...

Continued from previous page...

Mol	Type	Chain	Res	Chirality	Geometry	Clashes	Electron density
1	MLY	D	839	-	-	X	-
1	MLY	G	553	-	-	X	-
1	MLY	G	764	-	-	X	-
1	MLY	G	768	-	-	X	-
1	MLY	G	84	-	-	X	-
1	MLY	J	553	-	-	X	-
1	MLY	J	764	-	-	X	-
1	MLY	J	768	-	-	X	-
1	MLY	J	84	-	-	X	-

2 Entry composition i

There are 4 unique types of molecules in this entry. The entry contains 76872 atoms, of which 0 are hydrogens and 0 are deuteriums.

In the tables below, the AltConf column contains the number of residues with at least one atom in alternate conformation and the Trace column contains the number of residues modelled with at most 2 atoms.

- Molecule 1 is a protein called SKELETAL MUSCLE MYOSIN II.

Mol	Chain	Residues	Atoms					AltConf	Trace
			Total	C	N	O	S		
1	A	840	6797	4382	1135	1243	37	0	0
1	D	840	6797	4382	1135	1243	37	0	0
1	G	840	6797	4382	1135	1243	37	0	0
1	J	840	6797	4382	1135	1243	37	0	0

- Molecule 2 is a protein called SKELETAL MUSCLE MYOSIN II REGULATORY LIGHT CHAIN.

Mol	Chain	Residues	Atoms					AltConf	Trace
			Total	C	N	O	S		
2	B	145	1127	717	177	227	6	0	0
2	E	145	1127	717	177	227	6	0	0
2	H	145	1127	717	177	227	6	0	0
2	K	145	1127	717	177	227	6	0	0

- Molecule 3 is a protein called SKELETAL MUSCLE MYOSIN II ESSENTIAL LIGHT CHAIN.

Mol	Chain	Residues	Atoms					AltConf	Trace
			Total	C	N	O	S		
3	C	147	1123	698	188	230	7	0	0
3	F	147	1123	698	188	230	7	0	0
3	I	147	1123	698	188	230	7	0	0
3	L	147	1123	698	188	230	7	0	0

- Molecule 4 is a protein called SKELETAL MUSCLE ACTIN.

Mol	Chain	Residues	Atoms					AltConf	Trace
4	0	372	Total	C	N	O	S	0	0
			2906	1836	489	561	20		
4	1	372	Total	C	N	O	S	0	0
			2906	1836	489	561	20		
4	2	372	Total	C	N	O	S	0	0
			2906	1836	489	561	20		
4	3	372	Total	C	N	O	S	0	0
			2906	1836	489	561	20		
4	4	372	Total	C	N	O	S	0	0
			2906	1836	489	561	20		
4	5	372	Total	C	N	O	S	0	0
			2906	1836	489	561	20		
4	6	372	Total	C	N	O	S	0	0
			2906	1836	489	561	20		
4	7	372	Total	C	N	O	S	0	0
			2906	1836	489	561	20		
4	8	372	Total	C	N	O	S	0	0
			2906	1836	489	561	20		
4	V	372	Total	C	N	O	S	0	0
			2906	1836	489	561	20		
4	W	372	Total	C	N	O	S	0	0
			2906	1836	489	561	20		
4	X	372	Total	C	N	O	S	0	0
			2906	1836	489	561	20		
4	Y	372	Total	C	N	O	S	0	0
			2906	1836	489	561	20		
4	Z	372	Total	C	N	O	S	0	0
			2906	1836	489	561	20		

3 Residue-property plots

These plots are drawn for all protein, RNA, DNA and oligosaccharide chains in the entry. The first graphic for a chain summarises the proportions of the various outlier classes displayed in the second graphic. The second graphic shows the sequence view annotated by issues in geometry and atom inclusion in map density. Residues are color-coded according to the number of geometric quality criteria for which they contain at least one outlier: green = 0, yellow = 1, orange = 2 and red = 3 or more. A red diamond above a residue indicates a poor fit to the EM map for this residue (all-atom inclusion < 40%). Stretches of 2 or more consecutive residues without any outlier are shown as a green connector. Residues present in the sample, but not in the model, are shown in grey.

- Molecule 1: SKELETAL MUSCLE MYOSIN II

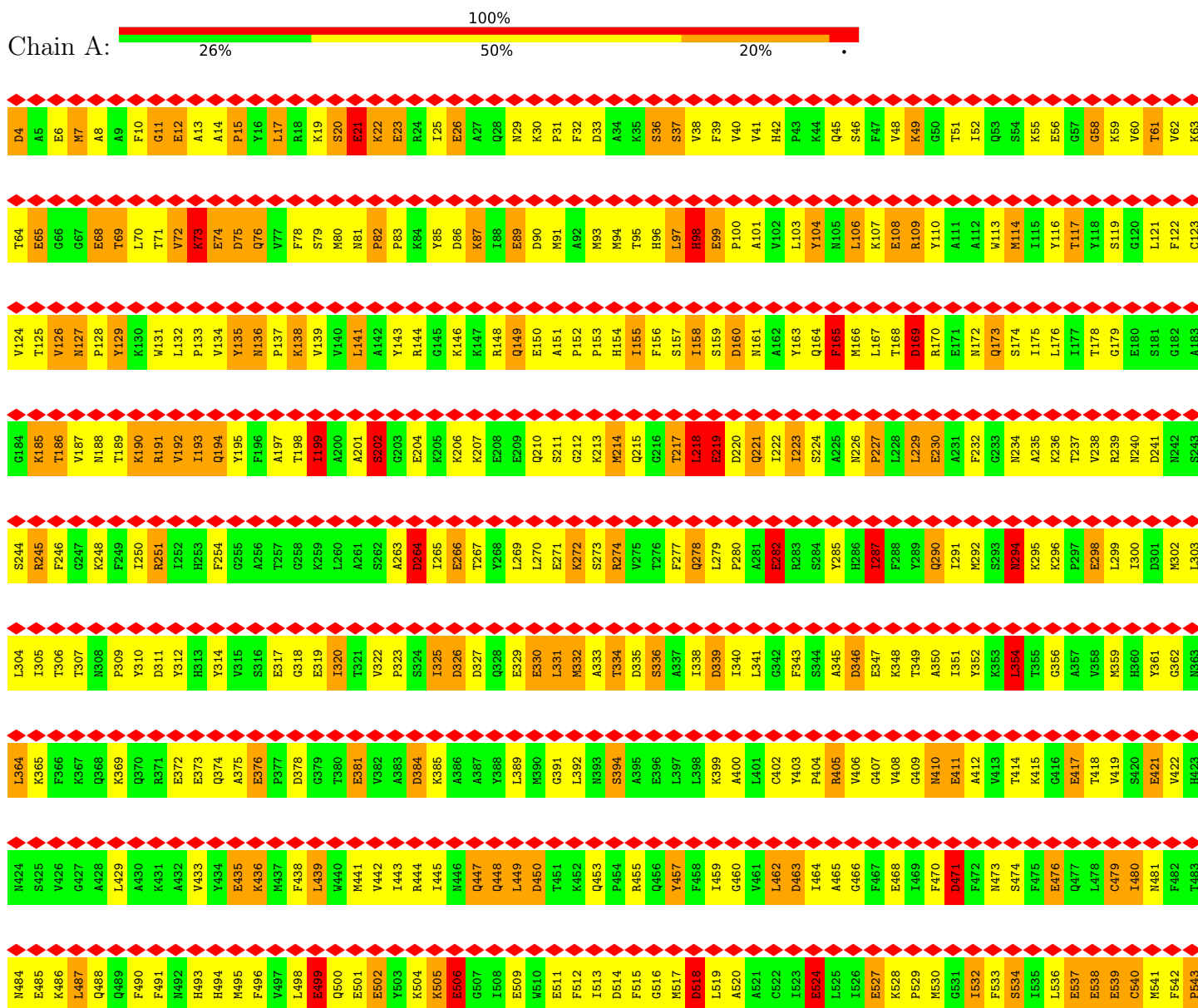

K544	E604	L664	Y724	E784
A645	E605	R665	R725	E785
T546	E606	S666	V726	I786
D647	V607	T667	L727	I787
T548	V608	H668	M728	T788
S649	G609	P669	A729	A789
F550	L610	H670	S730	T790
K651	Y611	F671	A731	Q791
N652	Q612	V672	I732	A792
K653	K613	R673	P733	R793
L654	S614	C674	E734	C794
Y655	S615	I675	G735	R795
D656	V616	I676	Q736	G796
E557	K617	P677	F737	F797
H558	T618	M678	M738	L798
L659	L619	E679	D739	M799
G660	A620	T680	S740	R800
K661	L621	K681	K741	V801
S662	L622	T682	K742	E802
N663	F623	P683	A743	Y803
N664	A624	G684	S744	R804
F665	T625	A685	E745	A805
Q666	Y626	M686	K746	M806
K667	G627	G687	L747	V807
P668	G628	H688	L748	E808
K669	E629	E689	G749	R809
P570	A630	L690	G750	R810
A571	E631	V691	G751	E811
K572	G632	L692	D752	S812
G573	G633	H693	V753	I813
K574	G634	Q694	D754	F814
A575	G635	L695	H755	C815
E576	K636	R696	T756	I816
A577	K637	C697	Q757	Q817
H578	G638	M698	Y758	Y818
F579	G639	G699	A759	N819
S680	K640	V700	F760	V820
L681	K641	L701	G761	R821
V682	K642	E702	H762	S822
H683	G643	G703	T763	F823
Y684	S644	I704	K764	M824
A585	A645	R705	V765	N825
G686	F646	I706	F766	V826
T687	Q647	C707	F767	K827
V688	T648	R708	K768	H828
D689	V649	K709	A769	M829
Y690	S650	G710	G770	P830
N691	A651	F711	L771	M831
L692	L652	P712	L772	M832
S693	F653	S713	G773	K833
G694	R654	R714	L774	L834
V695	E655	V715	L775	F835
L696	M656	L716	E776	F836
E697	L657	L717	T777	I837
K698	M658	A718	M778	I838
N699	K659	D719	R779	K839
K600	L660	F720	D780	P840
D601	M661	K721	D781	L841
P602	A662	Q722	K782	L842
L603	N663	R723	L783	K843

• Molecule 1: SKELETAL MUSCLE MYOSIN II



D4	T64	V124	G184	S244	L304	L364	N424
A5	E65	T125	K185	R245	L305	K365	S425
E6	G66	V126	T186	F246	T306	F366	V426
M7	G67	N127	V187	G247	T307	K367	G427
A8	E68	P128	M188	K248	N308	Q368	A428
A9	T69	Y129	T189	F249	P309	K369	L429
F10	L70	K130	K190	I250	Y310	Q370	A430
G11	T71	V131	R191	R251	D311	R371	K431
E12	V72	L132	V192	I252	Y312	E372	A432
A13	K73	P133	I193	H253	H313	E373	V433
A14	E74	V134	Q194	F254	Y314	Q374	Y434
P15	D75	Y135	Y195	G255	V315	A375	E435
Y16	Q76	N136	F196	A256	S316	E376	K436
L17	V77	P137	T197	T257	E317	P377	H437
R18	F78	K138	T198	G258	G318	D378	F438
K19	S79	V139	I199	K259	E319	Q379	L439
S20	M80	Y140	A200	L260	I320	T380	W440
E21	N81	L141	A201	A261	T321	E381	W441
K22	P82	A142	S202	S262	V322	V382	V442
E23	P83	Y143	G203	A263	P323	A383	L443
A24	K84	R144	E204	D264	S224	D384	R444
I25	Y85	G145	K205	E265	I325	K385	L445
E26	D86	K146	K206	E266	D326	A386	W446
Q27	K87	K147	K207	T267	D327	A387	Q447
A28	I88	L148	E208	Y268	Q328	Y388	L448
N29	E89	Q149	E209	L269	E329	L389	L449
K30	D90	E150	Q210	L270	E330	W390	D450
P31	M91	A151	S211	E271	L331	G391	T451
D32	A92	P152	G212	K272	M332	L392	K452
F33	M93	K153	K213	S273	A333	N393	K453
A34	M94	H154	M214	R274	T334	S394	F454
K35	T95	I155	Q215	V275	D335	A395	R455
S36	H96	F156	G216	T276	S336	E396	Q456
S37	L97	S157	G217	F277	A337	L397	Y457
V38	H98	L158	L218	Q278	L338	L398	F458
F39	E99	S159	E219	L279	D339	K399	L459
V40	P100	D160	D220	P280	L340	A400	G460
V41	A101	N161	Q221	A281	L341	L401	V461
H42	V102	A162	I222	E282	G422	C402	L462
P43	L103	Y163	I223	R283	F433	Y403	D463
K44	Y104	Q164	S224	S284	S344	P404	L464
Q45	N105	F165	A225	Y285	A345	A405	A465
S46	L106	M166	M226	H286	D346	V406	G466
F47	K107	L167	P227	I287	E347	Q407	F467
V48	E108	T168	L228	F288	K348	V408	E468
K49	R109	D169	L229	Y289	T349	Q409	L469
G50	Y110	R170	E230	Q290	A350	N410	F470
T51	A111	E171	A231	L291	I351	E411	D471
I52	A112	M172	F232	M292	Y352	A412	F472
Q53	M113	Q173	G233	S293	K353	V413	N473
S54	M114	S174	M234	M294	L354	T414	S474
K55	I115	L175	A235	K295	T355	K415	F475
E56	Y116	L176	K236	K296	G356	G416	E476
G57	T117	I177	T237	L297	E357	E417	Q477
G58	Y118	T178	V238	E298	V358	T418	L478
K59	S119	G179	R239	L299	K359	V419	C479
V60	G120	E180	M240	I300	H360	S420	L480
T61	L121	L181	D241	T301	Y361	E421	N481
V62	F122	G182	M242	K302	G362	V422	F482
K63	C123	A183	S243	L303	N363	H423	T483

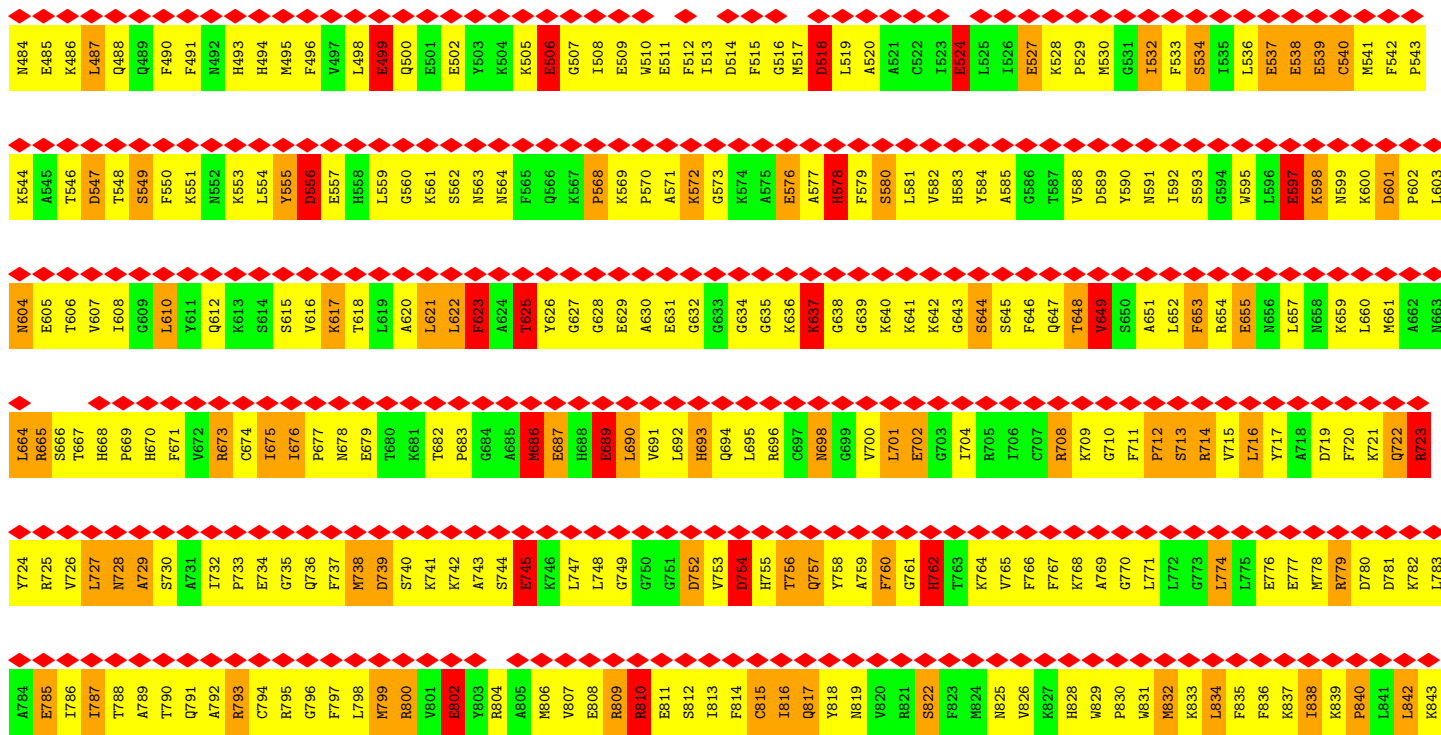

N424	N425	S426	V426	G427	A428	L429	A430	K431	A432	V433	Y434	E435	K436	M437	F438	L439	V440	M441	V442	I443	R444	I445	M446	Q447	Q448	L449	D450	K451	K452	Q453	P454	R455	Q456	Y457	F458	I459	G460	L462	D463	I464	A465	G466	F467	I469	F470	D471	F472	N473	S474	F475	A476	Q477	L478	C479	I480	M481	F482	T483	
M484	E485	K486	L487	Q488	Q489	F490	F491	H492	H493	H494	M495	F496	V497	L498	E499	Q500	E501	Y503	K504	K505	E506	G507	I508	E509	W510	E511	F512	I513	D514	F515	G516	M517	D518	L519	A520	C522	I523	E524	E525	I526	E527	K528	P529	M530	G531	L532	F533	S534	I535	L536	E537	E538	C539	C540	M541	F542	P543		
K544	A545	T546	D547	T548	S549	F550	K551	N552	K553	L554	Y555	D556	H557	L558	L559	G560	K561	S562	N563	N564	F565	Q566	K567	P568	E569	P570	A571	K572	G573	K574	A575	E576	A577	H578	F579	S580	L581	V582	H583	Y584	G585	G586	T587	V588	D589	Y590	N591	L592	F593	S594	W595	L596	E597	K598	N599	K600	D601	P602	L603
N604	E605	T606	V607	I608	G609	L610	H611	Q612	K613	S614	S615	V616	K617	T618	L619	A620	L621	L622	F623	A624	F625	Y626	G627	G628	E629	A630	E631	G632	G633	G634	G635	K636	K637	G638	G639	K640	K641	K642	G643	S644	S645	F646	T647	T648	V649	S650	A651	L652	F653	F654	E655	M656	L657	M658	K659	L660	M661	A662	N663
L664	R665	S666	T667	H668	P669	H670	F671	V672	R673	C674	I675	I676	P677	N678	E679	T680	K681	T682	P683	G684	A685	M686	E687	H688	E689	L690	V691	L692	G693	H694	L695	R696	C697	M698	G699	V700	L701	E702	G703	I704	R705	I706	C707	R708	K709	G710	F711	F712	S713	R714	V715	L716	L717	A718	D719	F720	M721	Q722	R723
Y724	R725	V726	L727	M728	A729	S730	A731	I732	R733	E734	G735	Q736	M738	D739	K741	K742	A743	E744	E745	K746	L747	L748	G749	G750	G751	D752	V753	D754	H755	T756	Q757	Y758	A759	F760	G761	H762	T763	K764	V765	F766	F767	K768	A769	G770	L771	L772	G773	L774	L775	E776	E777	M778	R779	D780	L781	K782	L783		
A784	E785	I786	I787	T788	A789	T790	Q791	R792	R793	C794	R795	G796	F797	L798	M799	R800	V801	E802	H803	R804	A805	M806	V807	E808	R809	R810	E811	S812	L813	F814	C815	I816	Q817	Y818	N819	V820	R821	S822	P823	M824	N825	V826	K827	H828	H829	P830	M831	M832	K833	L834	P835	F836	K837	L838	K839	P840	L841	L842	K843

• Molecule 1: SKELETAL MUSCLE MYOSIN II



D4	A5	E6	M7	A8	A9	F10	G11	E12	A13	A14	P15	Y16	L17	R18	K19	S20	E21	K22	E23	K24	L25	E26	A27	Q28	N29	K30	P31	F32	D33	A34	K35	S36	S37	V38	F39	V40	V41	H42	P43	K44	Q45	S46	F47	V48	K49	G50	T51	L52	Q53	S54	K55	E56	G58	Y59	L60	F61	G62	L63	Y64	L65	L66	K67	V68	K69	G70	L71	M72	M73	Q73	S74	L75	L76	L77	L78	G79	E80	G81	L82	L83	L84	L85	L86	L87	L88	L89	L90	Q210	S211	G212	K213	M214	Q215	G216	T217	I218	E219	D220	Q221	I222	L223	S224	A225	M226	P227	L228	L229	O230	A231	M232	F233	Q233	M234	L235	A236	K236	V238	R239	M240	D241	L242	S243
T64	E65	G66	G67	E68	T69	L70	T71	V72	K73	E74	D75	Q76	V77	F78	S79	M80	N81	P82	P83	K84	Y85	D86	K87	I88	E89	D90	M91	A92	M93	M94	T95	H96	L97	H98	E99	P100	A101	Y102	L103	Y104	N105	L106	S107	E108	R109	K110	Y110	A111	A112	Q113	M114	I115	Y116	Y117	Y118	S119	G120	F121	F122	C123																																																													
V124	T125	V126	M127	P128	Y129	K130	M131	L132	P133	V134	Y135	M136	P137	K138	V139	L140	L141	A142	Y143	R144	G145	K146	K147	L148	Q149	E150	A151	P152	P153	H154	I155	F156	S157	I158	S159	D160	M161	A162	Y163	Q164	M166	L167	T168	D169	R170	E171	M172	L173	Q173	S174	I175	L176	L177	T178	G179	E180	L181	G182	A183																																																														
G184	K185	T186	V187	M188	T189	K190	R191	L192	M193	Q194	Y195	F196	A197	T198	I199	A200	A201	S202	G203	E204	K206	K207	E208	E209	Q210	S211	G212	K213	M214	Q215	G216	T217	L218	E219	D220	I222	L223	S224	A225	M226	P227	L228	L229	O230	A231	M232	F233	Q233	M234	L235	A236	K236	V238	R239	M240	D241	L242	S243																																																															
S244	R245	F246	G247	K248	F249	L250	R251	L252	H253	F254	G255	A256	T257	G258	K259	L260	A261	S262	D264	L265	E266	T267	T268	L269	L270	E271	K272	S273	R274	V275	T276	F277	Q278	L279	P280	Q281	E282	R283	S284	Y285	H286	L287	F288	Y289	Q290	L291	M292	K293	S293	M294	K295	K296	E298	L299	L300	D301	M302	L303																																																															
L304	L305	T306	T307	N308	P309	Y310	D311	Y312	H313	Y314	V315	S316	E317	G318	E319	L320	T321	V322	P323	S324	L325	D326	D327	Q328	E329	E330	L331	M332	A333	T334	D335	S336	A337	L338	D339	L340	L341	G342	F343	S344	A345	D346	E347	K348	A350	L351	Y352	K353	L354	T355	G356	A357	V358	K359	H360	G362	N363																																																																

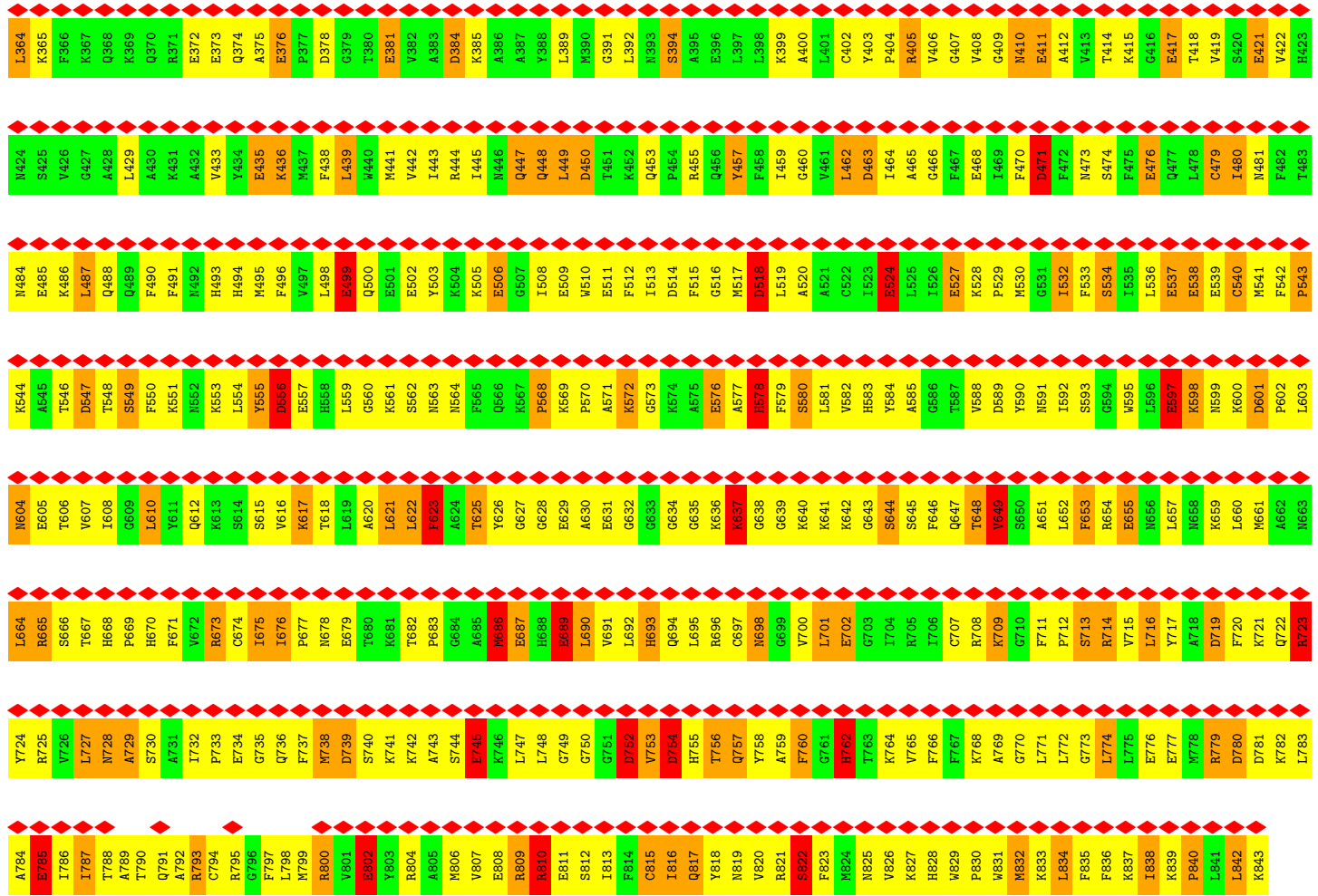

• Molecule 2: SKELETAL MUSCLE MYOSIN II REGULATORY LIGHT CHAIN

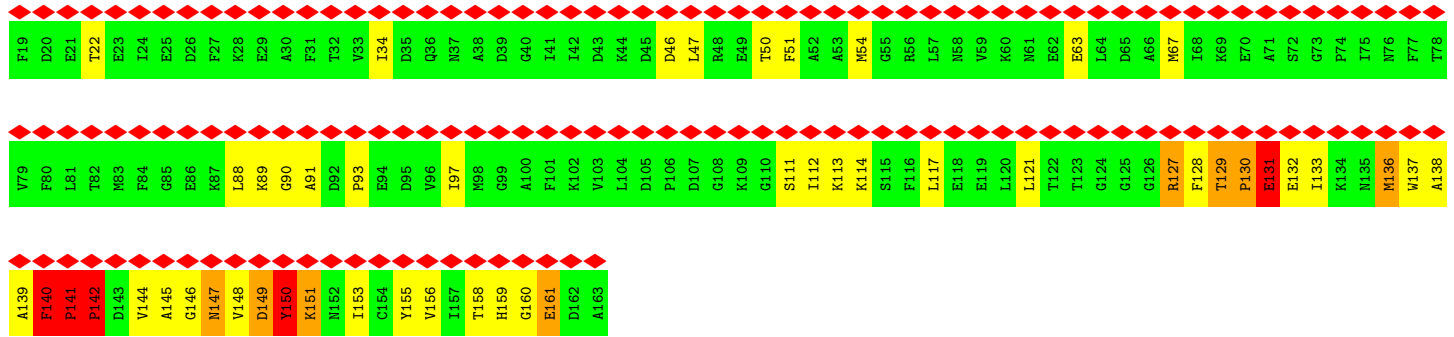

• Molecule 2: SKELETAL MUSCLE MYOSIN II REGULATORY LIGHT CHAIN

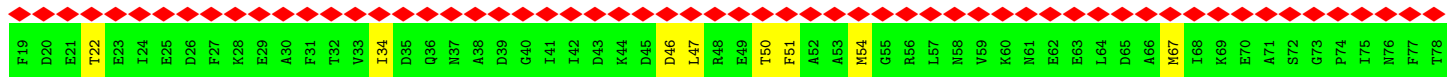



• Molecule 2: SKELETAL MUSCLE MYOSIN II REGULATORY LIGHT CHAIN

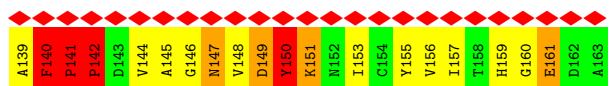
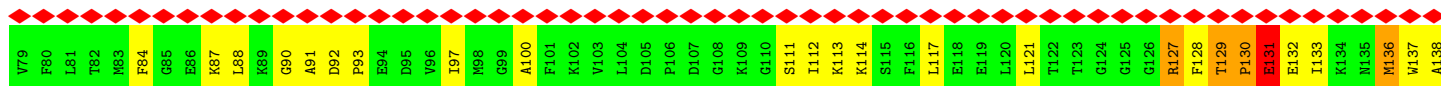
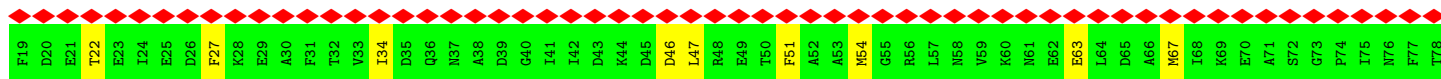

• Molecule 2: SKELETAL MUSCLE MYOSIN II REGULATORY LIGHT CHAIN

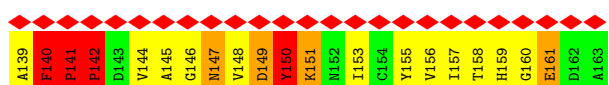
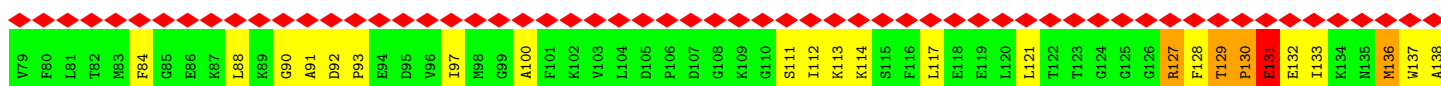

• Molecule 3: SKELETAL MUSCLE MYOSIN II ESSENTIAL LIGHT CHAIN

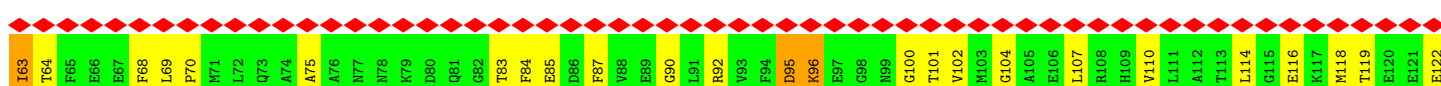

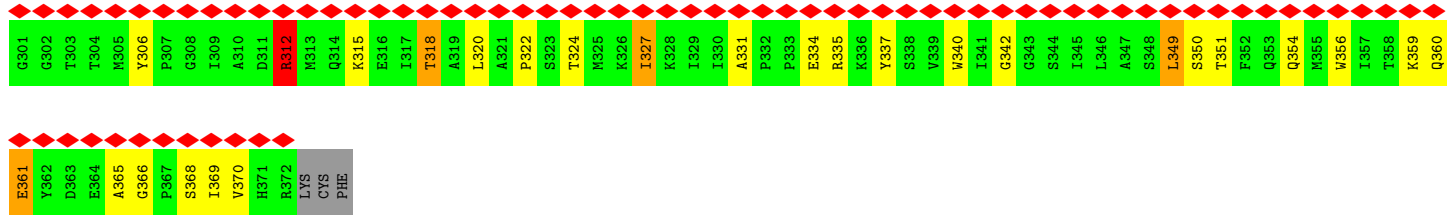

• Molecule 4: SKELETAL MUSCLE ACTIN

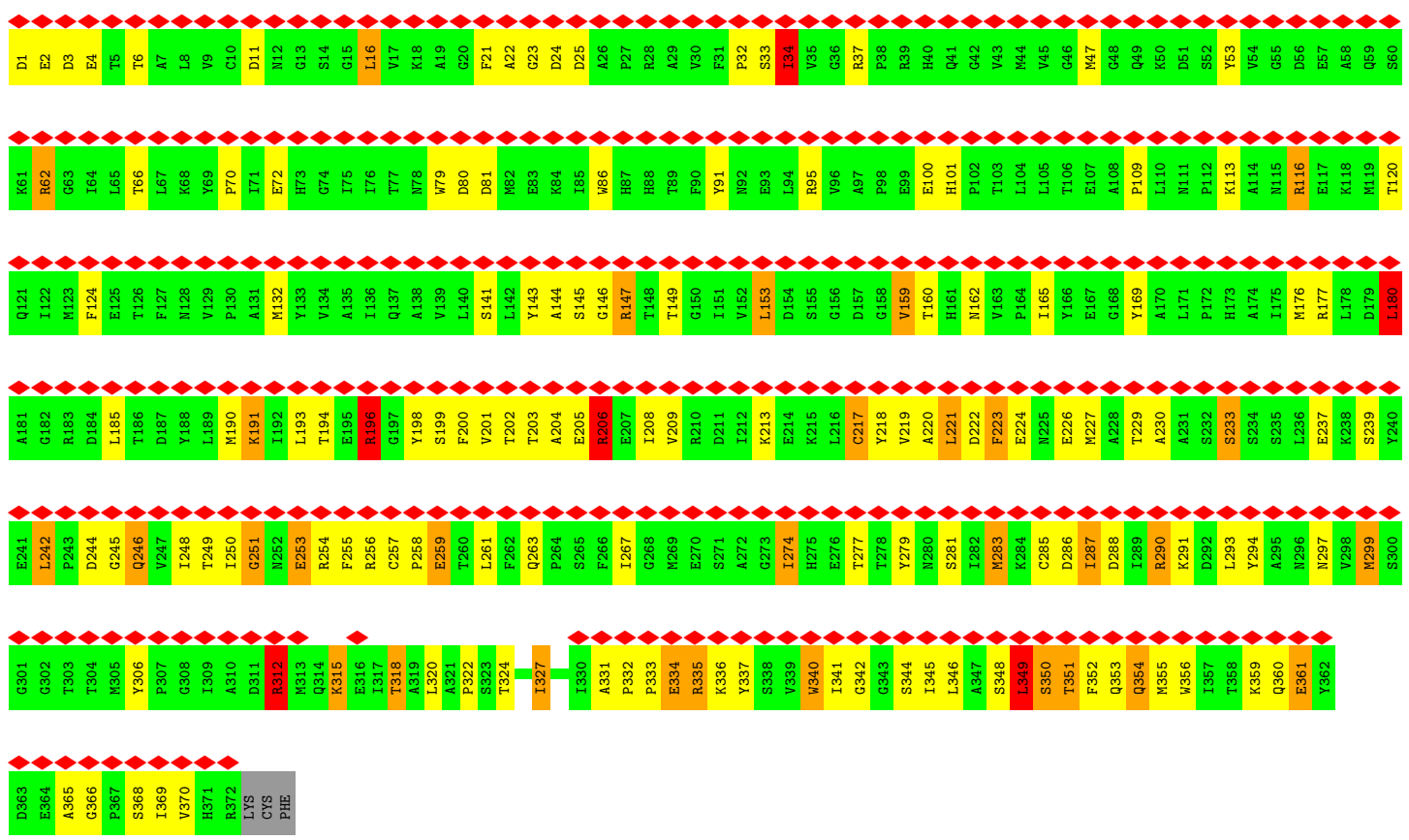
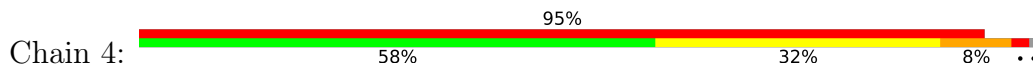

• Molecule 4: SKELETAL MUSCLE ACTIN

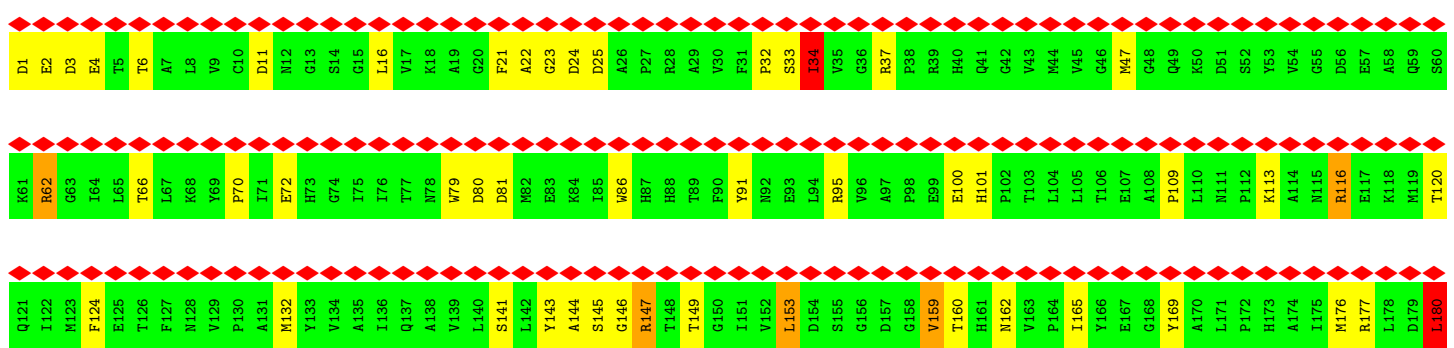



• Molecule 4: SKELETAL MUSCLE ACTIN

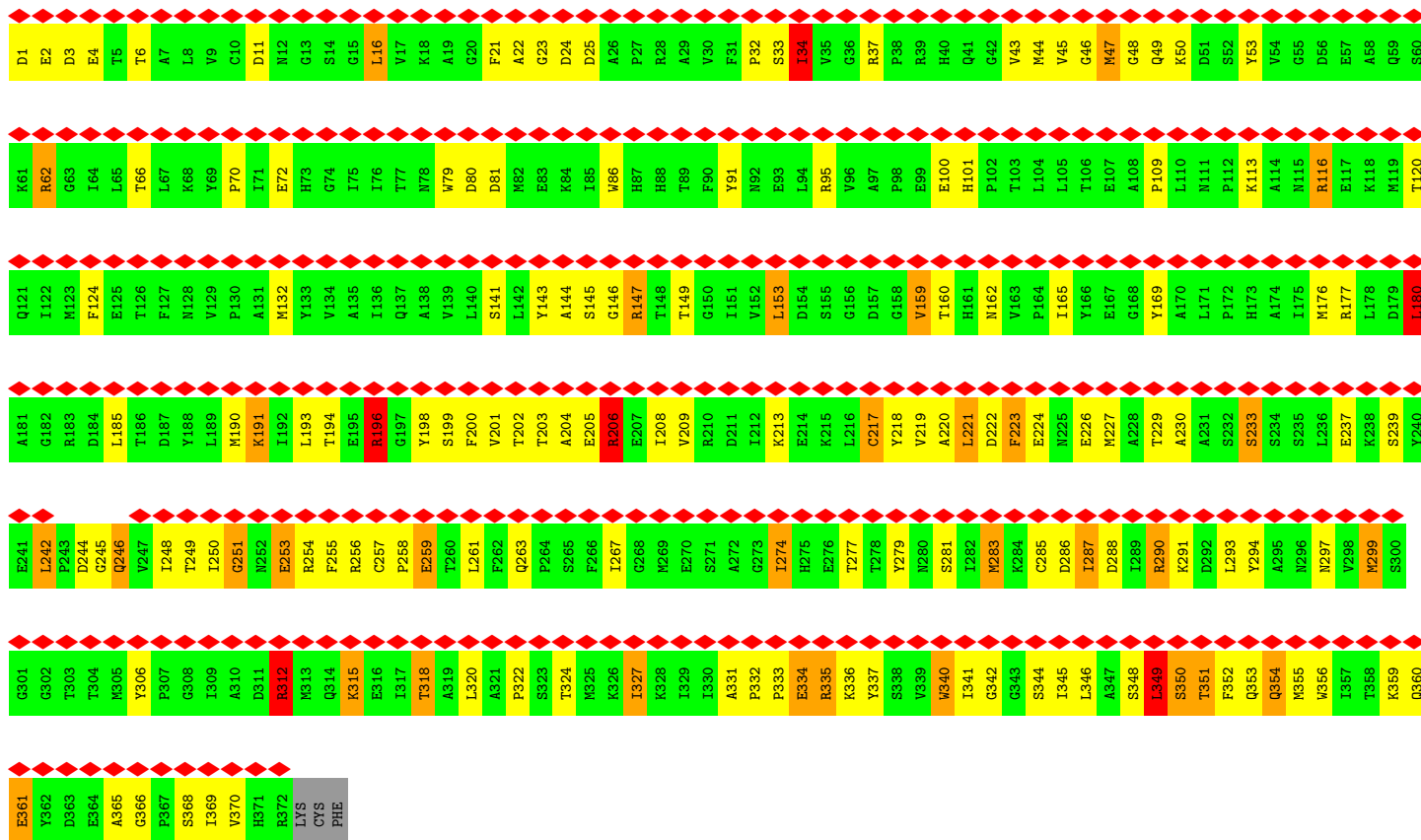
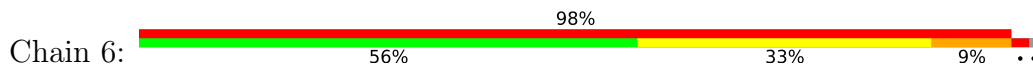

• Molecule 4: SKELETAL MUSCLE ACTIN

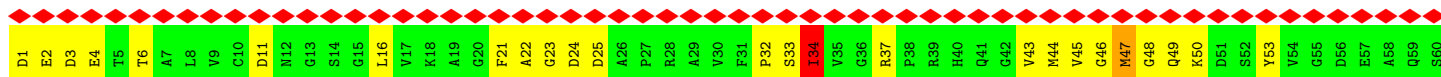

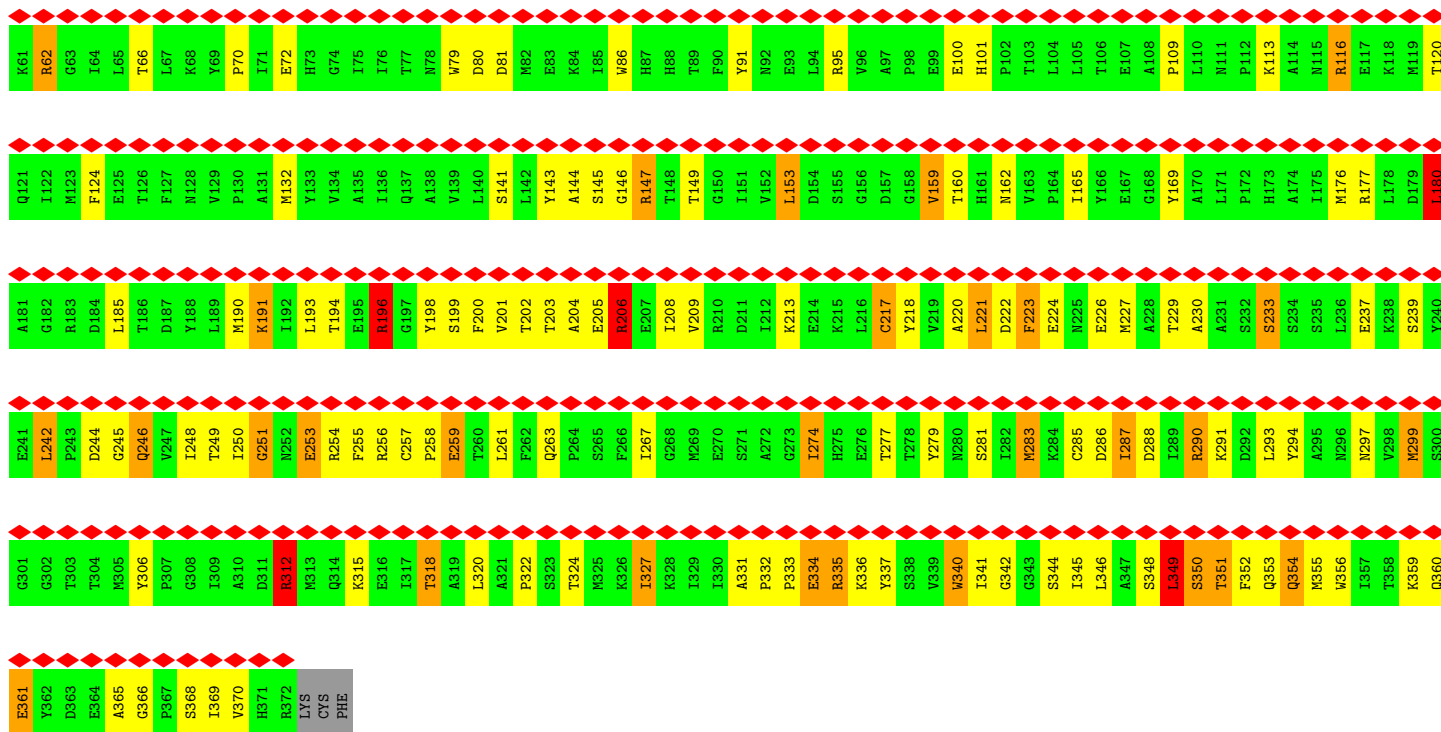

● Molecule 4: SKELETAL MUSCLE ACTIN

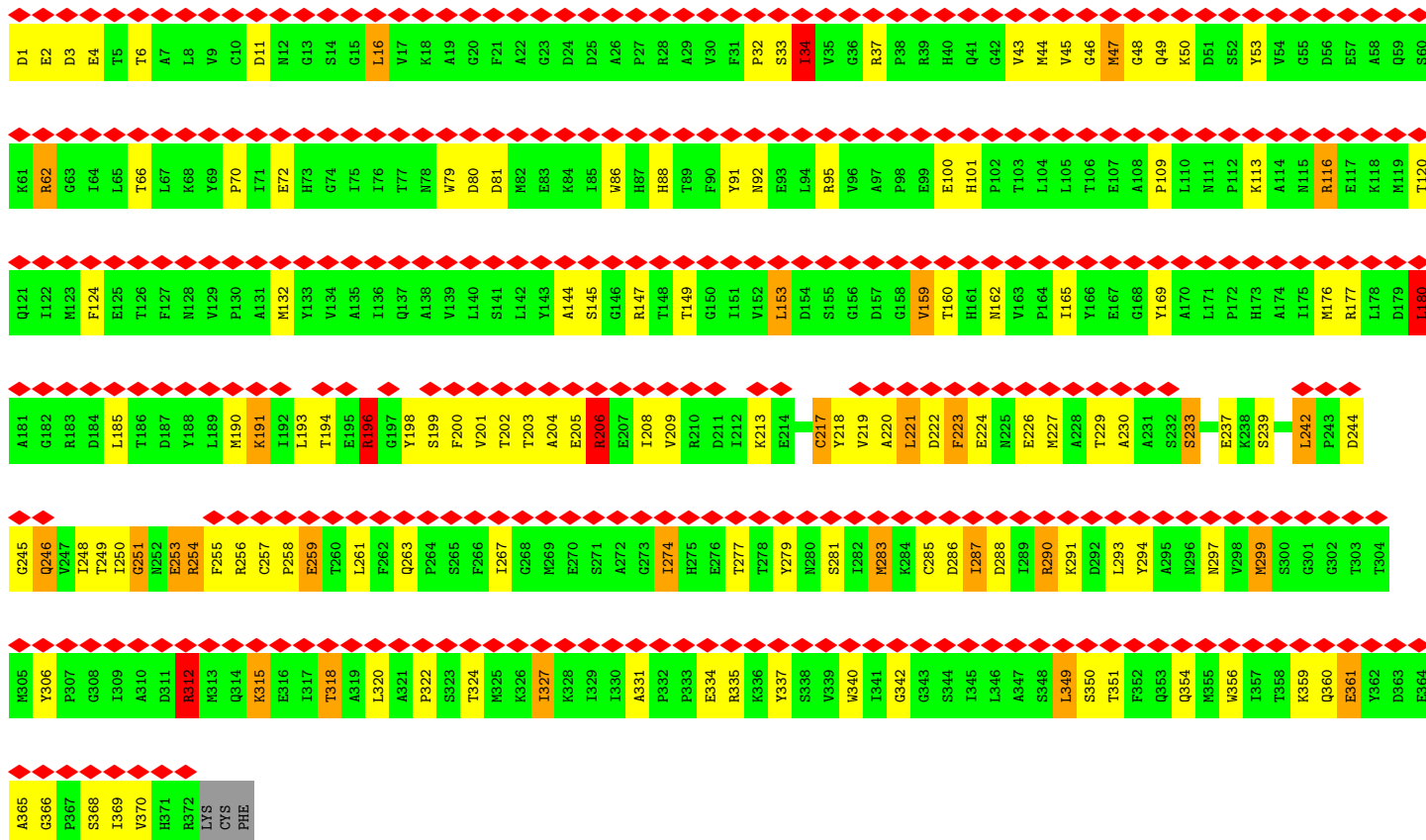
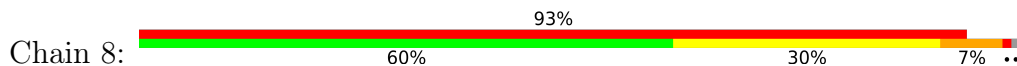

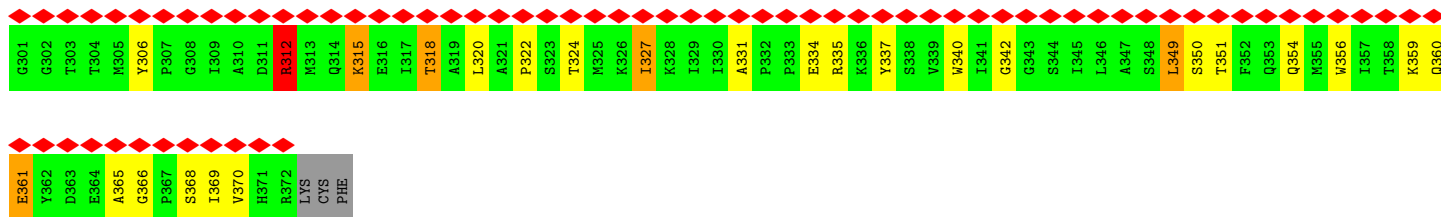

• Molecule 4: SKELETAL MUSCLE ACTIN

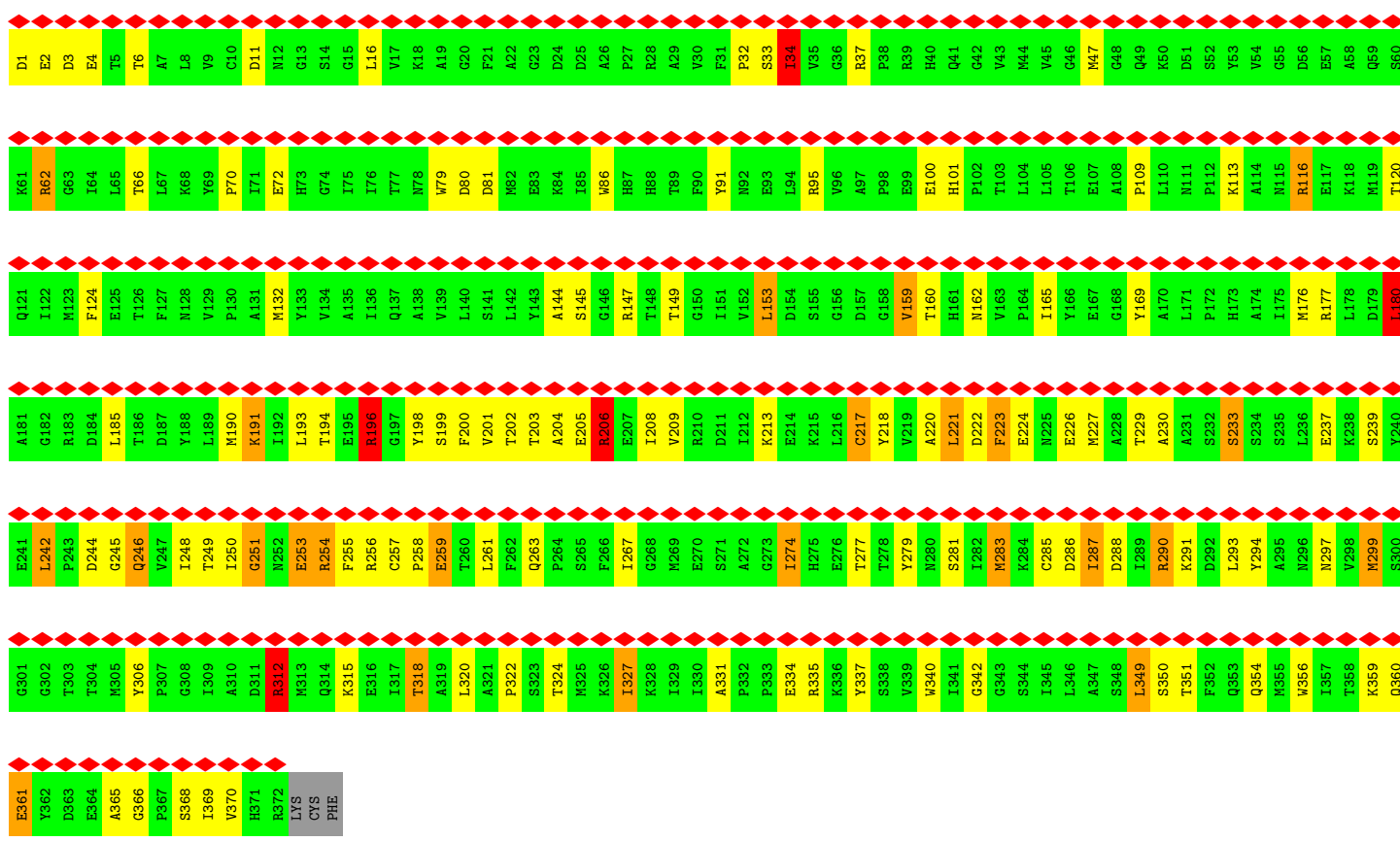

• Molecule 4: SKELETAL MUSCLE ACTIN

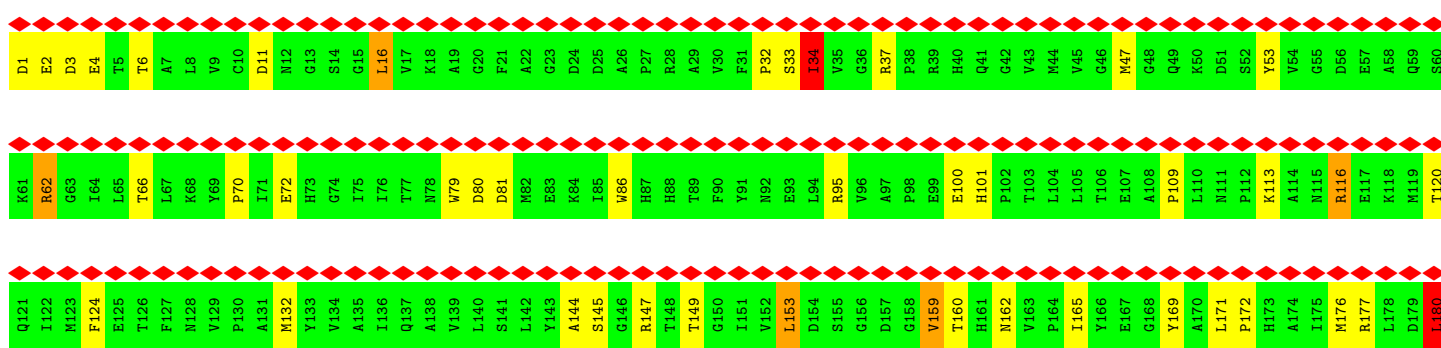



● Molecule 4: SKELETAL MUSCLE ACTIN

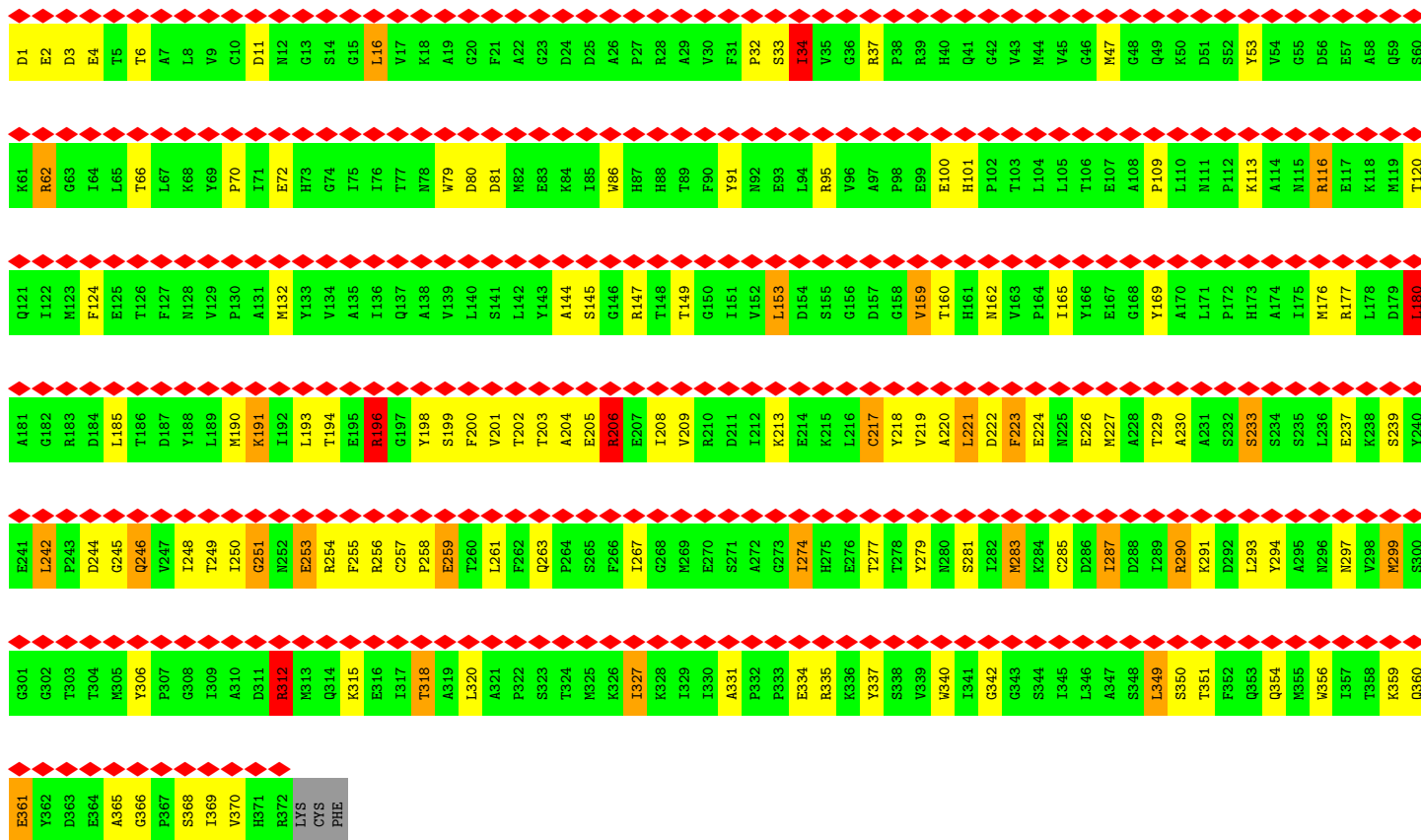

4 Experimental information

Property	Value	Source
EM reconstruction method	TOMOGRAPHY	Depositor
Imposed symmetry	POINT, C1	Depositor
Number of tilted images used	Not provided	
Resolution determination method	Not provided	
CTF correction method	Not provided	
Microscope	FEI/PHILIPS EM400	Depositor
Voltage (kV)	100	Depositor
Electron dose ($e^-/\text{\AA}^2$)	Not provided	
Minimum defocus (nm)	Not provided	
Maximum defocus (nm)	Not provided	
Magnification	17000	Depositor
Image detector	KODAK SO-163 FILM	Depositor
Maximum voxel value	366.680	Depositor
Minimum voxel value	-417.992	Depositor
Average voxel value	1.860	Depositor
Voxel value standard deviation	47.792	Depositor
Recommended contour level	81.2	Depositor
Tomogram size (\AA)	9280, 9280, 464	wwPDB
Tomogram dimensions	600, 600, 30	wwPDB
Tomogram angles ($^\circ$)	90, 90, 90	wwPDB
Grid spacing (\AA)	15.4667, 15.4667, 15.4667	Depositor

5 Model quality i

5.1 Standard geometry i

Bond lengths and bond angles in the following residue types are not validated in this section: MLY

The Z score for a bond length (or angle) is the number of standard deviations the observed value is removed from the expected value. A bond length (or angle) with $|Z| > 5$ is considered an outlier worth inspection. RMSZ is the root-mean-square of all Z scores of the bond lengths (or angles).

Mol	Chain	Bond lengths		Bond angles	
		RMSZ	# Z >5	RMSZ	# Z >5
1	A	1.77	67/6448 (1.0%)	1.82	114/8729 (1.3%)
1	D	1.77	65/6448 (1.0%)	1.82	114/8729 (1.3%)
1	G	1.77	67/6448 (1.0%)	1.82	116/8729 (1.3%)
1	J	1.90	68/6449 (1.1%)	1.84	118/8732 (1.4%)
2	B	1.22	10/1148 (0.9%)	1.61	16/1548 (1.0%)
2	E	1.22	10/1148 (0.9%)	1.61	16/1548 (1.0%)
2	H	1.22	10/1148 (0.9%)	1.62	16/1548 (1.0%)
2	K	1.22	10/1148 (0.9%)	1.61	16/1548 (1.0%)
3	C	0.80	0/1136	0.95	4/1525 (0.3%)
3	F	0.80	0/1136	0.95	4/1525 (0.3%)
3	I	0.80	0/1136	0.95	4/1525 (0.3%)
3	L	0.79	0/1136	0.94	4/1525 (0.3%)
4	0	0.89	1/2968 (0.0%)	1.64	52/4023 (1.3%)
4	1	0.89	2/2968 (0.1%)	1.64	50/4023 (1.2%)
4	2	0.89	1/2968 (0.0%)	1.64	52/4023 (1.3%)
4	3	0.89	1/2968 (0.0%)	1.64	51/4023 (1.3%)
4	4	0.89	1/2968 (0.0%)	1.64	51/4023 (1.3%)
4	5	0.89	2/2968 (0.1%)	1.64	51/4023 (1.3%)
4	6	0.89	2/2968 (0.1%)	1.64	52/4023 (1.3%)
4	7	0.89	2/2968 (0.1%)	1.64	52/4023 (1.3%)
4	8	0.89	2/2968 (0.1%)	1.64	51/4023 (1.3%)
4	V	0.89	1/2968 (0.0%)	1.64	52/4023 (1.3%)
4	W	0.89	2/2968 (0.1%)	1.64	51/4023 (1.3%)
4	X	0.89	2/2968 (0.1%)	1.64	51/4023 (1.3%)
4	Y	0.89	2/2968 (0.1%)	1.64	51/4023 (1.3%)
4	Z	0.89	2/2968 (0.1%)	1.64	52/4023 (1.3%)
All	All	1.29	330/76481 (0.4%)	1.67	1261/103533 (1.2%)

Chiral center outliers are detected by calculating the chiral volume of a chiral center and verifying if the center is modelled as a planar moiety or with the opposite hand. A planarity outlier is detected by checking planarity of atoms in a peptide group, atoms in a mainchain group or atoms of a

sidechain that are expected to be planar.

Mol	Chain	#Chirality outliers	#Planarity outliers
1	A	1	4
1	D	1	4
1	G	2	4
1	J	1	6
2	B	0	3
2	E	0	3
2	H	0	3
2	K	0	3
3	C	0	2
3	F	0	2
3	I	0	2
3	L	0	2
4	0	0	1
4	1	0	1
4	2	0	1
4	3	0	1
4	4	0	1
4	5	0	1
4	6	0	1
4	7	0	1
4	8	0	1
4	V	0	1
4	W	0	1
4	X	0	1
4	Y	0	1
4	Z	0	1
All	All	5	52

The worst 5 of 330 bond length outliers are listed below:

Mol	Chain	Res	Type	Atoms	Z	Observed(Å)	Ideal(Å)
1	J	709	LYS	C-N	-55.36	0.33	1.33
1	J	649	VAL	CB-CG1	53.26	2.64	1.52
1	G	649	VAL	CB-CG1	53.23	2.64	1.52
1	D	649	VAL	CB-CG1	53.18	2.64	1.52
1	A	649	VAL	CB-CG1	53.16	2.64	1.52

The worst 5 of 1261 bond angle outliers are listed below:

Mol	Chain	Res	Type	Atoms	Z	Observed(°)	Ideal(°)
1	G	637	LYS	O-C-N	-58.53	23.69	123.20

Continued on next page...

Continued from previous page...

Mol	Chain	Res	Type	Atoms	Z	Observed(°)	Ideal(°)
1	J	637	LYS	O-C-N	-58.47	23.80	123.20
1	D	637	LYS	O-C-N	-58.47	23.81	123.20
1	A	637	LYS	O-C-N	-58.45	23.83	123.20
1	J	649	VAL	CG1-CB-CG2	-34.02	56.47	110.90

All (5) chirality outliers are listed below:

Mol	Chain	Res	Type	Atom
1	A	648	THR	CB
1	D	648	THR	CB
1	G	75	ASP	CA
1	G	648	THR	CB
1	J	648	THR	CB

5 of 52 planarity outliers are listed below:

Mol	Chain	Res	Type	Group
1	A	623	PHE	Sidechain
1	A	637	LYS	Mainchain
1	A	649	VAL	Mainchain
1	A	98	HIS	Mainchain
2	B	22	THR	Mainchain

5.2 Too-close contacts [i](#)

In the following table, the Non-H and H(model) columns list the number of non-hydrogen atoms and hydrogen atoms in the chain respectively. The H(added) column lists the number of hydrogen atoms added and optimized by MolProbity. The Clashes column lists the number of clashes within the asymmetric unit, whereas Symm-Clashes lists symmetry-related clashes.

Mol	Chain	Non-H	H(model)	H(added)	Clashes	Symm-Clashes
1	A	6797	0	6752	1414	0
1	D	6797	0	6761	1431	0
1	G	6797	0	6754	1380	0
1	J	6797	0	6760	1429	0
2	B	1127	0	1086	252	0
2	E	1127	0	1087	320	0
2	H	1127	0	1087	228	0
2	K	1127	0	1087	227	0
3	C	1123	0	1084	181	0
3	F	1123	0	1082	139	0

Continued on next page...

Continued from previous page...

Mol	Chain	Non-H	H(model)	H(added)	Clashes	Symm-Clashes
3	I	1123	0	1084	169	0
3	L	1123	0	1084	165	0
4	0	2906	0	2866	75	0
4	1	2906	0	2866	77	0
4	2	2906	0	2864	102	0
4	3	2906	0	2864	100	0
4	4	2906	0	2855	345	0
4	5	2906	0	2855	340	0
4	6	2906	0	2852	382	0
4	7	2906	0	2852	377	0
4	8	2906	0	2861	150	0
4	V	2906	0	2861	142	0
4	W	2906	0	2864	107	0
4	X	2906	0	2864	105	0
4	Y	2906	0	2865	78	0
4	Z	2906	0	2865	78	0
All	All	76872	0	75762	7444	0

The all-atom clashscore is defined as the number of clashes found per 1000 atoms (including hydrogen atoms). The all-atom clashscore for this structure is 49.

The worst 5 of 7444 close contacts within the same asymmetric unit are listed below, sorted by their clash magnitude.

Atom-1	Atom-2	Interatomic distance (Å)	Clash overlap (Å)
1:G:797:PHE:CD1	3:I:149:VAL:HG11	1.20	1.68
2:E:144:VAL:HG13	2:E:153:ILE:CD1	1.22	1.66
1:G:798:LEU:CD1	3:I:126:LEU:HD21	1.20	1.65
1:A:725:ARG:HE	1:A:733:PRO:CB	1.09	1.64
1:D:725:ARG:HE	1:D:733:PRO:CB	1.09	1.64

There are no symmetry-related clashes.

5.3 Torsion angles [i](#)

5.3.1 Protein backbone [i](#)

In the following table, the Percentiles column shows the percent Ramachandran outliers of the chain as a percentile score with respect to all PDB entries followed by that with respect to all EM entries.

The Analysed column shows the number of residues for which the backbone conformation was analysed, and the total number of residues.

Mol	Chain	Analysed	Favoured	Allowed	Outliers	Percentiles	
1	A	789/840 (94%)	650 (82%)	113 (14%)	26 (3%)	4	26
1	D	789/840 (94%)	651 (82%)	112 (14%)	26 (3%)	4	26
1	G	789/840 (94%)	649 (82%)	113 (14%)	27 (3%)	3	26
1	J	791/840 (94%)	651 (82%)	112 (14%)	28 (4%)	3	25
2	B	143/145 (99%)	126 (88%)	9 (6%)	8 (6%)	2	19
2	E	143/145 (99%)	126 (88%)	9 (6%)	8 (6%)	2	19
2	H	143/145 (99%)	126 (88%)	9 (6%)	8 (6%)	2	19
2	K	143/145 (99%)	126 (88%)	9 (6%)	8 (6%)	2	19
3	C	143/147 (97%)	133 (93%)	10 (7%)	0	100	100
3	F	143/147 (97%)	133 (93%)	10 (7%)	0	100	100
3	I	143/147 (97%)	133 (93%)	10 (7%)	0	100	100
3	L	143/147 (97%)	133 (93%)	10 (7%)	0	100	100
4	0	370/375 (99%)	334 (90%)	30 (8%)	6 (2%)	9	44
4	1	370/375 (99%)	335 (90%)	29 (8%)	6 (2%)	9	44
4	2	370/375 (99%)	334 (90%)	30 (8%)	6 (2%)	9	44
4	3	370/375 (99%)	335 (90%)	29 (8%)	6 (2%)	9	44
4	4	370/375 (99%)	334 (90%)	30 (8%)	6 (2%)	9	44
4	5	370/375 (99%)	335 (90%)	29 (8%)	6 (2%)	9	44
4	6	370/375 (99%)	335 (90%)	29 (8%)	6 (2%)	9	44
4	7	370/375 (99%)	334 (90%)	30 (8%)	6 (2%)	9	44
4	8	370/375 (99%)	335 (90%)	29 (8%)	6 (2%)	9	44
4	V	370/375 (99%)	334 (90%)	30 (8%)	6 (2%)	9	44
4	W	370/375 (99%)	334 (90%)	30 (8%)	6 (2%)	9	44
4	X	370/375 (99%)	334 (90%)	30 (8%)	6 (2%)	9	44
4	Y	370/375 (99%)	334 (90%)	30 (8%)	6 (2%)	9	44
4	Z	370/375 (99%)	335 (90%)	29 (8%)	6 (2%)	9	44
All	All	9482/9778 (97%)	8319 (88%)	940 (10%)	223 (2%)	9	33

5 of 223 Ramachandran outliers are listed below:

Mol	Chain	Res	Type
1	A	73	LYS
1	A	202	SER
1	A	572	LYS
1	A	712	PRO
1	A	729	ALA

5.3.2 Protein sidechains [i](#)

In the following table, the Percentiles column shows the percent sidechain outliers of the chain as a percentile score with respect to all PDB entries followed by that with respect to all EM entries.

The Analysed column shows the number of residues for which the sidechain conformation was analysed, and the total number of residues.

Mol	Chain	Analysed	Rotameric	Outliers	Percentiles	
1	A	672/672 (100%)	512 (76%)	160 (24%)	0	4
1	D	672/672 (100%)	515 (77%)	157 (23%)	1	4
1	G	672/672 (100%)	514 (76%)	158 (24%)	1	4
1	J	672/672 (100%)	514 (76%)	158 (24%)	1	4
2	B	120/120 (100%)	119 (99%)	1 (1%)	81	89
2	E	120/120 (100%)	119 (99%)	1 (1%)	81	89
2	H	120/120 (100%)	119 (99%)	1 (1%)	81	89
2	K	120/120 (100%)	119 (99%)	1 (1%)	81	89
3	C	117/117 (100%)	112 (96%)	5 (4%)	29	53
3	F	117/117 (100%)	112 (96%)	5 (4%)	29	53
3	I	117/117 (100%)	112 (96%)	5 (4%)	29	53
3	L	117/117 (100%)	112 (96%)	5 (4%)	29	53
4	0	315/318 (99%)	269 (85%)	46 (15%)	3	15
4	1	315/318 (99%)	268 (85%)	47 (15%)	3	15
4	2	315/318 (99%)	268 (85%)	47 (15%)	3	15
4	3	315/318 (99%)	268 (85%)	47 (15%)	3	15
4	4	315/318 (99%)	268 (85%)	47 (15%)	3	15
4	5	315/318 (99%)	269 (85%)	46 (15%)	3	15
4	6	315/318 (99%)	268 (85%)	47 (15%)	3	15
4	7	315/318 (99%)	269 (85%)	46 (15%)	3	15

Continued on next page...

Continued from previous page...

Mol	Chain	Analysed	Rotameric	Outliers	Percentiles	
4	8	315/318 (99%)	268 (85%)	47 (15%)	3	15
4	V	315/318 (99%)	269 (85%)	46 (15%)	3	15
4	W	315/318 (99%)	269 (85%)	46 (15%)	3	15
4	X	315/318 (99%)	269 (85%)	46 (15%)	3	15
4	Y	315/318 (99%)	268 (85%)	47 (15%)	3	15
4	Z	315/318 (99%)	268 (85%)	47 (15%)	3	15
All	All	8046/8088 (100%)	6737 (84%)	1309 (16%)	5	13

5 of 1309 residues with a non-rotameric sidechain are listed below:

Mol	Chain	Res	Type
4	5	320	LEU
4	W	246	GLN
4	6	199	SER
4	5	318	THR
4	8	145	SER

Sometimes sidechains can be flipped to improve hydrogen bonding and reduce clashes. 5 of 184 such sidechains are listed below:

Mol	Chain	Res	Type
4	1	354	GLN
4	7	41	GLN
4	2	252	ASN
4	4	137	GLN
4	8	137	GLN

5.3.3 RNA [i](#)

There are no RNA molecules in this entry.

5.4 Non-standard residues in protein, DNA, RNA chains [i](#)

180 non-standard protein/DNA/RNA residues are modelled in this entry.

In the following table, the Counts columns list the number of bonds (or angles) for which Mogul statistics could be retrieved, the number of bonds (or angles) that are observed in the model and the number of bonds (or angles) that are defined in the Chemical Component Dictionary. The Link column lists molecule types, if any, to which the group is linked. The Z score for a bond

length (or angle) is the number of standard deviations the observed value is removed from the expected value. A bond length (or angle) with $|Z| > 2$ is considered an outlier worth inspection. RMSZ is the root-mean-square of all Z scores of the bond lengths (or angles).

Mol	Type	Chain	Res	Link	Bond lengths			Bond angles		
					Counts	RMSZ	# Z > 2	Counts	RMSZ	# Z > 2
1	MLY	A	436	1	9,10,11	1.04	1 (11%)	6,11,13	0.50	0
1	MLY	D	248	1	9,10,11	0.83	0	6,11,13	0.62	0
1	MLY	A	505	1	9,10,11	0.89	1 (11%)	6,11,13	0.34	0
1	MLY	J	55	1	9,10,11	0.72	0	6,11,13	0.78	0
1	MLY	G	839	1	9,10,11	0.70	0	6,11,13	0.80	0
1	MLY	J	436	1	9,10,11	1.06	1 (11%)	6,11,13	0.49	0
1	MLY	D	659	1	9,10,11	0.83	0	6,11,13	0.60	0
1	MLY	G	367	1	9,10,11	0.66	0	6,11,13	0.38	0
1	MLY	G	659	1	9,10,11	0.84	0	6,11,13	0.59	0
1	MLY	J	87	1	9,10,11	1.23	1 (11%)	6,11,13	0.43	0
1	MLY	J	839	1	9,10,11	0.71	0	6,11,13	0.76	0
1	MLY	D	236	1	9,10,11	0.79	1 (11%)	6,11,13	0.47	0
1	MLY	A	138	1	9,10,11	1.32	1 (11%)	6,11,13	0.84	0
1	MLY	J	617	1	9,10,11	0.96	1 (11%)	6,11,13	0.33	0
1	MLY	D	138	1	9,10,11	1.39	1 (11%)	6,11,13	0.85	0
1	MLY	A	764	1	9,10,11	0.86	0	6,11,13	0.36	0
1	MLY	D	385	1	9,10,11	0.99	1 (11%)	6,11,13	0.44	0
1	MLY	J	768	1	9,10,11	0.77	0	6,11,13	0.42	0
1	MLY	A	353	1	9,10,11	0.86	0	6,11,13	0.78	0
1	MLY	G	138	1	9,10,11	1.31	1 (11%)	6,11,13	0.84	0
1	MLY	D	272	1	9,10,11	0.99	1 (11%)	6,11,13	0.57	0
1	MLY	J	63	1	9,10,11	0.90	0	6,11,13	0.43	0
1	MLY	J	551	1	9,10,11	0.52	0	6,11,13	0.18	0
1	MLY	A	415	1	9,10,11	0.76	0	6,11,13	0.19	0
1	MLY	A	19	1	9,10,11	1.12	1 (11%)	6,11,13	0.57	0
1	MLY	A	30	1	9,10,11	0.89	0	6,11,13	0.32	0
1	MLY	G	30	1	9,10,11	0.89	0	6,11,13	0.30	0
1	MLY	G	827	1	9,10,11	0.69	0	6,11,13	0.49	0
1	MLY	A	190	1	9,10,11	1.26	1 (11%)	6,11,13	0.51	0
1	MLY	D	764	1	9,10,11	0.84	0	6,11,13	0.35	0
1	MLY	G	551	1	9,10,11	0.52	0	6,11,13	0.20	0
1	MLY	G	431	1	9,10,11	0.54	0	6,11,13	0.46	0
1	MLY	D	63	1	9,10,11	0.90	0	6,11,13	0.45	0
1	MLY	J	130	1	9,10,11	0.78	0	6,11,13	0.75	0
1	MLY	A	369	1	9,10,11	0.71	0	6,11,13	0.45	0
1	MLY	A	87	1	9,10,11	1.20	1 (11%)	6,11,13	0.43	0

Mol	Type	Chain	Res	Link	Bond lengths			Bond angles		
					Counts	RMSZ	# Z > 2	Counts	RMSZ	# Z > 2
1	MLY	J	296	1	9,10,11	0.67	0	6,11,13	0.36	0
1	MLY	G	768	1	9,10,11	0.74	0	6,11,13	0.42	0
1	MLY	G	107	1	9,10,11	0.47	0	6,11,13	0.34	0
1	MLY	G	248	1	9,10,11	0.81	0	6,11,13	0.63	0
1	MLY	G	837	1	9,10,11	0.59	0	6,11,13	0.53	0
1	MLY	G	84	1	9,10,11	0.49	0	6,11,13	0.80	0
1	MLY	A	295	1	9,10,11	0.84	0	6,11,13	0.33	0
1	MLY	G	190	1	9,10,11	1.26	1 (11%)	6,11,13	0.52	0
1	MLY	A	617	1	9,10,11	0.94	1 (11%)	6,11,13	0.34	0
1	MLY	J	486	1	9,10,11	0.63	0	6,11,13	0.39	0
1	MLY	D	551	1	9,10,11	0.53	0	6,11,13	0.20	0
1	MLY	D	84	1	9,10,11	0.51	0	6,11,13	0.80	0
1	MLY	D	827	1	9,10,11	0.69	0	6,11,13	0.48	0
1	MLY	J	49	1	9,10,11	1.08	1 (11%)	6,11,13	0.75	0
1	MLY	A	59	1	9,10,11	0.87	0	6,11,13	0.50	0
1	MLY	J	613	1	9,10,11	0.56	0	6,11,13	0.64	0
1	MLY	A	659	1	9,10,11	0.83	0	6,11,13	0.60	0
1	MLY	G	63	1	9,10,11	0.92	1 (11%)	6,11,13	0.43	0
1	MLY	J	248	1	9,10,11	0.82	0	6,11,13	0.62	0
1	MLY	J	84	1	9,10,11	0.49	0	6,11,13	0.80	0
1	MLY	A	236	1	9,10,11	0.80	1 (11%)	6,11,13	0.49	0
1	MLY	G	553	1,4	9,10,11	0.67	0	6,11,13	0.55	0
1	MLY	D	295	1	9,10,11	0.79	0	6,11,13	0.35	0
1	MLY	G	59	1	9,10,11	0.85	0	6,11,13	0.49	0
1	MLY	D	190	1	9,10,11	1.22	1 (11%)	6,11,13	0.54	0
1	MLY	J	295	1	9,10,11	0.78	0	6,11,13	0.35	0
1	MLY	D	768	1	9,10,11	0.74	0	6,11,13	0.41	0
1	MLY	G	505	1	9,10,11	0.87	1 (11%)	6,11,13	0.35	0
1	MLY	J	385	1	9,10,11	1.01	1 (11%)	6,11,13	0.44	0
1	MLY	A	486	1	9,10,11	0.65	0	6,11,13	0.39	0
1	MLY	A	528	1	9,10,11	0.89	0	6,11,13	0.66	0
1	MLY	A	348	1	9,10,11	0.85	0	6,11,13	0.48	0
1	MLY	A	600	1	9,10,11	0.51	0	6,11,13	0.38	0
1	MLY	A	837	1	9,10,11	0.61	0	6,11,13	0.54	0
1	MLY	G	35	1	9,10,11	0.72	0	6,11,13	0.39	0
1	MLY	A	782	1	9,10,11	0.78	0	6,11,13	0.35	0
1	MLY	D	598	1	9,10,11	0.93	1 (11%)	6,11,13	0.44	0
1	MLY	J	272	1	9,10,11	1.02	1 (11%)	6,11,13	0.55	0
1	MLY	J	598	1	9,10,11	0.90	1 (11%)	6,11,13	0.43	0
1	MLY	A	367	1	9,10,11	0.63	0	6,11,13	0.37	0

Mol	Type	Chain	Res	Link	Bond lengths			Bond angles		
					Counts	RMSZ	# Z > 2	Counts	RMSZ	# Z > 2
1	MLY	D	431	1	9,10,11	0.52	0	6,11,13	0.46	0
1	MLY	D	35	1	9,10,11	0.74	0	6,11,13	0.37	0
1	MLY	A	55	1	9,10,11	0.71	0	6,11,13	0.78	0
1	MLY	G	600	1	9,10,11	0.51	0	6,11,13	0.37	0
1	MLY	A	431	1	9,10,11	0.53	0	6,11,13	0.45	0
1	MLY	G	369	1	9,10,11	0.70	0	6,11,13	0.46	0
1	MLY	D	528	1	9,10,11	0.91	0	6,11,13	0.65	0
1	MLY	G	130	1	9,10,11	0.79	0	6,11,13	0.75	0
1	MLY	D	436	1	9,10,11	1.12	1 (11%)	6,11,13	0.49	0
1	MLY	D	30	1	9,10,11	0.91	0	6,11,13	0.32	0
1	MLY	D	59	1	9,10,11	0.87	0	6,11,13	0.49	0
1	MLY	D	369	1	9,10,11	0.70	0	6,11,13	0.44	0
1	MLY	D	130	1	9,10,11	0.80	0	6,11,13	0.74	0
1	MLY	D	55	1	9,10,11	0.72	0	6,11,13	0.79	0
1	MLY	A	839	1,2	9,10,11	0.70	0	6,11,13	0.80	0
1	MLY	A	107	1	9,10,11	0.45	0	6,11,13	0.34	0
1	MLY	J	837	1	9,10,11	0.58	0	6,11,13	0.55	0
1	MLY	A	63	1	9,10,11	0.91	0	6,11,13	0.43	0
1	MLY	A	130	1	9,10,11	0.81	0	6,11,13	0.75	0
1	MLY	J	138	1	9,10,11	1.34	1 (11%)	6,11,13	0.83	0
1	MLY	G	415	1	9,10,11	0.75	0	6,11,13	0.19	0
1	MLY	D	553	1,4	9,10,11	0.68	0	6,11,13	0.56	0
1	MLY	G	295	1	9,10,11	0.81	0	6,11,13	0.33	0
1	MLY	G	19	1	9,10,11	1.15	1 (11%)	6,11,13	0.59	0
1	MLY	G	49	1	9,10,11	1.08	1 (11%)	6,11,13	0.75	0
1	MLY	A	681	1	9,10,11	0.60	0	6,11,13	0.46	0
1	MLY	J	764	1	9,10,11	0.84	0	6,11,13	0.38	0
1	MLY	D	486	1	9,10,11	0.66	0	6,11,13	0.39	0
1	MLY	D	600	1	9,10,11	0.50	0	6,11,13	0.38	0
1	MLY	D	782	1	9,10,11	0.79	0	6,11,13	0.34	0
1	MLY	D	837	1	9,10,11	0.61	0	6,11,13	0.56	0
1	MLY	D	367	1	9,10,11	0.61	0	6,11,13	0.38	0
1	MLY	G	296	1	9,10,11	0.64	0	6,11,13	0.37	0
1	MLY	A	504	1	9,10,11	0.90	0	6,11,13	0.25	0
1	MLY	D	617	1	9,10,11	0.97	1 (11%)	6,11,13	0.34	0
1	MLY	J	415	1	9,10,11	0.79	0	6,11,13	0.19	0
1	MLY	J	30	1	9,10,11	0.89	0	6,11,13	0.32	0
1	MLY	J	190	1	9,10,11	1.25	1 (11%)	6,11,13	0.52	0
1	MLY	A	827	1	9,10,11	0.71	0	6,11,13	0.46	0
1	MLY	A	768	1	9,10,11	0.75	0	6,11,13	0.40	0
1	MLY	J	367	1	9,10,11	0.62	0	6,11,13	0.37	0
1	MLY	D	681	1	9,10,11	0.57	0	6,11,13	0.45	0

Mol	Type	Chain	Res	Link	Bond lengths			Bond angles		
					Counts	RMSZ	# Z > 2	Counts	RMSZ	# Z > 2
1	MLY	G	353	1	9,10,11	0.86	0	6,11,13	0.80	0
1	MLY	G	385	1	9,10,11	1.00	1 (11%)	6,11,13	0.43	0
1	MLY	A	551	1	9,10,11	0.51	0	6,11,13	0.19	0
1	MLY	J	659	1	9,10,11	0.80	0	6,11,13	0.57	0
1	MLY	G	598	1	9,10,11	0.87	1 (11%)	6,11,13	0.42	0
1	MLY	G	613	1	9,10,11	0.59	0	6,11,13	0.64	0
1	MLY	G	617	1	9,10,11	0.95	1 (11%)	6,11,13	0.34	0
1	MLY	D	19	1	9,10,11	1.20	1 (11%)	6,11,13	0.57	0
1	MLY	G	436	1	9,10,11	1.06	1 (11%)	6,11,13	0.48	0
1	MLY	A	35	1	9,10,11	0.71	0	6,11,13	0.38	0
1	MLY	J	236	1	9,10,11	0.79	1 (11%)	6,11,13	0.48	0
1	MLY	G	348	1	9,10,11	0.86	1 (11%)	6,11,13	0.48	0
1	MLY	G	833	1	9,10,11	1.17	2 (22%)	6,11,13	0.33	0
1	MLY	J	431	1	9,10,11	0.53	0	6,11,13	0.44	0
1	MLY	A	49	1	9,10,11	1.07	1 (11%)	6,11,13	0.75	0
1	MLY	D	839	1	9,10,11	0.70	0	6,11,13	0.79	0
1	MLY	D	107	1	9,10,11	0.51	0	6,11,13	0.34	0
1	MLY	D	505	1	9,10,11	0.85	1 (11%)	6,11,13	0.35	0
1	MLY	J	504	1	9,10,11	0.86	0	6,11,13	0.23	0
1	MLY	A	613	1	9,10,11	0.57	0	6,11,13	0.63	0
1	MLY	J	35	1	9,10,11	0.72	0	6,11,13	0.39	0
1	MLY	D	833	1	9,10,11	1.14	2 (22%)	6,11,13	0.31	0
1	MLY	J	19	1	9,10,11	1.18	1 (11%)	6,11,13	0.57	0
1	MLY	A	248	1	9,10,11	0.84	0	6,11,13	0.60	0
1	MLY	A	84	1	9,10,11	0.48	0	6,11,13	0.79	0
1	MLY	D	87	1	9,10,11	1.16	1 (11%)	6,11,13	0.44	0
1	MLY	G	236	1	9,10,11	0.78	1 (11%)	6,11,13	0.47	0
1	MLY	J	505	1	9,10,11	0.92	1 (11%)	6,11,13	0.34	0
1	MLY	A	296	1	9,10,11	0.60	0	6,11,13	0.36	0
1	MLY	J	107	1	9,10,11	0.47	0	6,11,13	0.34	0
1	MLY	J	833	1	9,10,11	1.19	1 (11%)	6,11,13	0.31	0
1	MLY	A	833	1	9,10,11	1.15	1 (11%)	6,11,13	0.32	0
1	MLY	J	59	1	9,10,11	0.88	0	6,11,13	0.49	0
1	MLY	G	87	1	9,10,11	1.21	1 (11%)	6,11,13	0.43	0
1	MLY	J	369	1	9,10,11	0.70	0	6,11,13	0.45	0
1	MLY	D	353	1	9,10,11	0.84	0	6,11,13	0.79	0
1	MLY	G	528	1	9,10,11	0.89	0	6,11,13	0.67	0
1	MLY	G	486	1	9,10,11	0.64	0	6,11,13	0.38	0

Mol	Type	Chain	Res	Link	Bond lengths			Bond angles		
					Counts	RMSZ	# Z > 2	Counts	RMSZ	# Z > 2
1	MLY	A	385	1	9,10,11	1.00	1 (11%)	6,11,13	0.43	0
1	MLY	A	553	1,4	9,10,11	0.68	0	6,11,13	0.54	0
1	MLY	G	782	1	9,10,11	0.76	0	6,11,13	0.35	0
1	MLY	D	613	1	9,10,11	0.56	0	6,11,13	0.64	0
1	MLY	A	272	1	9,10,11	1.01	1 (11%)	6,11,13	0.56	0
1	MLY	A	598	1	9,10,11	0.91	1 (11%)	6,11,13	0.44	0
1	MLY	J	353	1	9,10,11	0.84	0	6,11,13	0.79	0
1	MLY	D	49	1	9,10,11	1.08	1 (11%)	6,11,13	0.73	0
1	MLY	D	296	1	9,10,11	0.64	0	6,11,13	0.37	0
1	MLY	G	504	1	9,10,11	0.88	0	6,11,13	0.23	0
1	MLY	D	348	1	9,10,11	0.81	0	6,11,13	0.47	0
1	MLY	J	553	1,4	9,10,11	0.67	0	6,11,13	0.53	0
1	MLY	G	764	1	9,10,11	0.82	0	6,11,13	0.36	0
1	MLY	J	681	1	9,10,11	0.59	0	6,11,13	0.46	0
1	MLY	G	55	1	9,10,11	0.74	0	6,11,13	0.79	0
1	MLY	J	528	1	9,10,11	0.88	0	6,11,13	0.66	0
1	MLY	D	504	1	9,10,11	0.88	0	6,11,13	0.22	0
1	MLY	G	272	1	9,10,11	0.99	1 (11%)	6,11,13	0.55	0
1	MLY	J	348	1	9,10,11	0.82	0	6,11,13	0.47	0
1	MLY	J	600	1	9,10,11	0.53	0	6,11,13	0.36	0
1	MLY	J	827	1	9,10,11	0.74	0	6,11,13	0.48	0
1	MLY	D	415	1	9,10,11	0.77	0	6,11,13	0.19	0
1	MLY	J	782	1	9,10,11	0.79	0	6,11,13	0.36	0
1	MLY	G	681	1	9,10,11	0.64	0	6,11,13	0.44	0

In the following table, the Chirals column lists the number of chiral outliers, the number of chiral centers analysed, the number of these observed in the model and the number defined in the Chemical Component Dictionary. Similar counts are reported in the Torsion and Rings columns. '-' means no outliers of that kind were identified.

Mol	Type	Chain	Res	Link	Chirals	Torsions	Rings
1	MLY	A	436	1	-	4/8/9/11	-
1	MLY	D	248	1	-	6/8/9/11	-
1	MLY	A	505	1	-	5/8/9/11	-
1	MLY	J	55	1	-	6/8/9/11	-
1	MLY	G	839	1	-	3/8/9/11	-
1	MLY	J	436	1	-	4/8/9/11	-
1	MLY	D	659	1	-	3/8/9/11	-
1	MLY	G	367	1	-	2/8/9/11	-

Continued on next page...

Continued from previous page...

Mol	Type	Chain	Res	Link	Chirals	Torsions	Rings
1	MLY	G	659	1	-	3/8/9/11	-
1	MLY	J	87	1	-	2/8/9/11	-
1	MLY	J	839	1	-	3/8/9/11	-
1	MLY	D	236	1	-	3/8/9/11	-
1	MLY	A	138	1	-	4/8/9/11	-
1	MLY	J	617	1	-	1/8/9/11	-
1	MLY	D	138	1	-	4/8/9/11	-
1	MLY	A	764	1	-	2/8/9/11	-
1	MLY	D	385	1	-	2/8/9/11	-
1	MLY	J	768	1	-	4/8/9/11	-
1	MLY	A	353	1	-	4/8/9/11	-
1	MLY	G	138	1	-	4/8/9/11	-
1	MLY	D	272	1	-	3/8/9/11	-
1	MLY	J	63	1	-	4/8/9/11	-
1	MLY	J	551	1	-	3/8/9/11	-
1	MLY	A	415	1	-	3/8/9/11	-
1	MLY	A	19	1	-	4/8/9/11	-
1	MLY	A	30	1	-	2/8/9/11	-
1	MLY	G	30	1	-	2/8/9/11	-
1	MLY	G	827	1	-	0/8/9/11	-
1	MLY	A	190	1	-	5/8/9/11	-
1	MLY	D	764	1	-	2/8/9/11	-
1	MLY	G	551	1	-	3/8/9/11	-
1	MLY	G	431	1	-	4/8/9/11	-
1	MLY	D	63	1	-	4/8/9/11	-
1	MLY	J	130	1	-	5/8/9/11	-
1	MLY	A	369	1	-	2/8/9/11	-
1	MLY	A	87	1	-	2/8/9/11	-
1	MLY	J	296	1	-	4/8/9/11	-
1	MLY	G	768	1	-	4/8/9/11	-
1	MLY	G	107	1	-	2/8/9/11	-
1	MLY	G	248	1	-	6/8/9/11	-
1	MLY	G	837	1	-	5/8/9/11	-
1	MLY	G	84	1	-	4/8/9/11	-

Continued on next page...

Continued from previous page...

Mol	Type	Chain	Res	Link	Chirals	Torsions	Rings
1	MLY	A	295	1	-	2/8/9/11	-
1	MLY	G	190	1	-	5/8/9/11	-
1	MLY	A	617	1	-	1/8/9/11	-
1	MLY	J	486	1	-	2/8/9/11	-
1	MLY	D	551	1	-	3/8/9/11	-
1	MLY	D	84	1	-	4/8/9/11	-
1	MLY	D	827	1	-	0/8/9/11	-
1	MLY	J	49	1	-	3/8/9/11	-
1	MLY	A	59	1	-	3/8/9/11	-
1	MLY	J	613	1	-	4/8/9/11	-
1	MLY	A	659	1	-	3/8/9/11	-
1	MLY	G	63	1	-	4/8/9/11	-
1	MLY	J	248	1	-	6/8/9/11	-
1	MLY	J	84	1	-	4/8/9/11	-
1	MLY	A	236	1	-	3/8/9/11	-
1	MLY	G	553	1,4	-	4/8/9/11	-
1	MLY	D	295	1	-	2/8/9/11	-
1	MLY	G	59	1	-	3/8/9/11	-
1	MLY	D	190	1	-	5/8/9/11	-
1	MLY	J	295	1	-	2/8/9/11	-
1	MLY	D	768	1	-	4/8/9/11	-
1	MLY	G	505	1	-	5/8/9/11	-
1	MLY	J	385	1	-	2/8/9/11	-
1	MLY	A	486	1	-	2/8/9/11	-
1	MLY	A	528	1	-	5/8/9/11	-
1	MLY	A	348	1	-	5/8/9/11	-
1	MLY	A	600	1	-	3/8/9/11	-
1	MLY	A	837	1	-	5/8/9/11	-
1	MLY	G	35	1	-	3/8/9/11	-
1	MLY	A	782	1	-	6/8/9/11	-
1	MLY	D	598	1	-	5/8/9/11	-
1	MLY	J	272	1	-	3/8/9/11	-
1	MLY	J	598	1	-	5/8/9/11	-
1	MLY	A	367	1	-	2/8/9/11	-

Continued on next page...

Continued from previous page...

Mol	Type	Chain	Res	Link	Chirals	Torsions	Rings
1	MLY	D	431	1	-	4/8/9/11	-
1	MLY	D	35	1	-	3/8/9/11	-
1	MLY	A	55	1	-	6/8/9/11	-
1	MLY	G	600	1	-	3/8/9/11	-
1	MLY	A	431	1	-	4/8/9/11	-
1	MLY	G	369	1	-	2/8/9/11	-
1	MLY	D	528	1	-	4/8/9/11	-
1	MLY	G	130	1	-	5/8/9/11	-
1	MLY	D	436	1	-	4/8/9/11	-
1	MLY	D	30	1	-	2/8/9/11	-
1	MLY	D	59	1	-	3/8/9/11	-
1	MLY	D	369	1	-	2/8/9/11	-
1	MLY	D	130	1	-	5/8/9/11	-
1	MLY	D	55	1	-	6/8/9/11	-
1	MLY	A	839	1,2	-	3/8/9/11	-
1	MLY	A	107	1	-	2/8/9/11	-
1	MLY	J	837	1	-	5/8/9/11	-
1	MLY	A	63	1	-	4/8/9/11	-
1	MLY	A	130	1	-	5/8/9/11	-
1	MLY	J	138	1	-	4/8/9/11	-
1	MLY	G	415	1	-	3/8/9/11	-
1	MLY	D	553	1,4	-	4/8/9/11	-
1	MLY	G	295	1	-	2/8/9/11	-
1	MLY	G	19	1	-	4/8/9/11	-
1	MLY	G	49	1	-	3/8/9/11	-
1	MLY	A	681	1	-	4/8/9/11	-
1	MLY	J	764	1	-	2/8/9/11	-
1	MLY	D	486	1	-	2/8/9/11	-
1	MLY	D	600	1	-	3/8/9/11	-
1	MLY	D	782	1	-	6/8/9/11	-
1	MLY	D	837	1	-	5/8/9/11	-
1	MLY	D	367	1	-	2/8/9/11	-
1	MLY	G	296	1	-	4/8/9/11	-
1	MLY	A	504	1	-	4/8/9/11	-

Continued on next page...

Continued from previous page...

Mol	Type	Chain	Res	Link	Chirals	Torsions	Rings
1	MLY	D	617	1	-	1/8/9/11	-
1	MLY	J	415	1	-	3/8/9/11	-
1	MLY	J	30	1	-	2/8/9/11	-
1	MLY	J	190	1	-	5/8/9/11	-
1	MLY	A	827	1	-	0/8/9/11	-
1	MLY	A	768	1	-	4/8/9/11	-
1	MLY	J	367	1	-	2/8/9/11	-
1	MLY	D	681	1	-	4/8/9/11	-
1	MLY	G	353	1	-	4/8/9/11	-
1	MLY	G	385	1	-	2/8/9/11	-
1	MLY	A	551	1	-	3/8/9/11	-
1	MLY	J	659	1	-	3/8/9/11	-
1	MLY	G	598	1	-	5/8/9/11	-
1	MLY	G	613	1	-	4/8/9/11	-
1	MLY	G	617	1	-	1/8/9/11	-
1	MLY	D	19	1	-	4/8/9/11	-
1	MLY	G	436	1	-	4/8/9/11	-
1	MLY	A	35	1	-	3/8/9/11	-
1	MLY	J	236	1	-	3/8/9/11	-
1	MLY	G	348	1	-	5/8/9/11	-
1	MLY	G	833	1	-	6/8/9/11	-
1	MLY	J	431	1	-	4/8/9/11	-
1	MLY	A	49	1	-	3/8/9/11	-
1	MLY	D	839	1	-	3/8/9/11	-
1	MLY	D	107	1	-	2/8/9/11	-
1	MLY	D	505	1	-	5/8/9/11	-
1	MLY	J	504	1	-	4/8/9/11	-
1	MLY	A	613	1	-	4/8/9/11	-
1	MLY	J	35	1	-	3/8/9/11	-
1	MLY	D	833	1	-	6/8/9/11	-
1	MLY	J	19	1	-	4/8/9/11	-
1	MLY	A	248	1	-	6/8/9/11	-
1	MLY	A	84	1	-	4/8/9/11	-
1	MLY	D	87	1	-	2/8/9/11	-
1	MLY	G	236	1	-	3/8/9/11	-

Continued on next page...

Continued from previous page...

Mol	Type	Chain	Res	Link	Chirals	Torsions	Rings
1	MLY	J	505	1	-	5/8/9/11	-
1	MLY	A	296	1	-	4/8/9/11	-
1	MLY	J	107	1	-	2/8/9/11	-
1	MLY	J	833	1	-	6/8/9/11	-
1	MLY	A	833	1	-	6/8/9/11	-
1	MLY	J	59	1	-	3/8/9/11	-
1	MLY	G	87	1	-	2/8/9/11	-
1	MLY	J	369	1	-	2/8/9/11	-
1	MLY	D	353	1	-	4/8/9/11	-
1	MLY	G	528	1	-	4/8/9/11	-
1	MLY	G	486	1	-	2/8/9/11	-
1	MLY	A	385	1	-	2/8/9/11	-
1	MLY	A	553	1,4	-	4/8/9/11	-
1	MLY	G	782	1	-	6/8/9/11	-
1	MLY	D	613	1	-	4/8/9/11	-
1	MLY	A	272	1	-	3/8/9/11	-
1	MLY	A	598	1	-	5/8/9/11	-
1	MLY	J	353	1	-	4/8/9/11	-
1	MLY	D	49	1	-	3/8/9/11	-
1	MLY	D	296	1	-	4/8/9/11	-
1	MLY	G	504	1	-	4/8/9/11	-
1	MLY	D	348	1	-	5/8/9/11	-
1	MLY	J	553	1,4	-	4/8/9/11	-
1	MLY	G	764	1	-	2/8/9/11	-
1	MLY	J	681	1	-	4/8/9/11	-
1	MLY	G	55	1	-	6/8/9/11	-
1	MLY	J	528	1	-	4/8/9/11	-
1	MLY	D	504	1	-	4/8/9/11	-
1	MLY	G	272	1	-	3/8/9/11	-
1	MLY	J	348	1	-	5/8/9/11	-
1	MLY	J	600	1	-	3/8/9/11	-
1	MLY	J	827	1	-	0/8/9/11	-
1	MLY	D	415	1	-	3/8/9/11	-
1	MLY	J	782	1	-	6/8/9/11	-

Continued on next page...

Continued from previous page...

Mol	Type	Chain	Res	Link	Chirals	Torsions	Rings
1	MLY	G	681	1	-	4/8/9/11	-

The worst 5 of 56 bond length outliers are listed below:

Mol	Chain	Res	Type	Atoms	Z	Observed(Å)	Ideal(Å)
1	D	138	MLY	CB-CA	-3.80	1.48	1.53
1	J	138	MLY	CB-CA	-3.66	1.48	1.53
1	A	138	MLY	CB-CA	-3.60	1.48	1.53
1	G	138	MLY	CB-CA	-3.55	1.48	1.53
1	D	19	MLY	CB-CA	-3.23	1.49	1.53

There are no bond angle outliers.

There are no chirality outliers.

5 of 637 torsion outliers are listed below:

Mol	Chain	Res	Type	Atoms
1	A	19	MLY	C-CA-CB-CG
1	A	49	MLY	N-CA-CB-CG
1	A	49	MLY	C-CA-CB-CG
1	A	55	MLY	N-CA-CB-CG
1	A	55	MLY	C-CA-CB-CG

There are no ring outliers.

124 monomers are involved in 525 short contacts:

Mol	Chain	Res	Type	Clashes	Symm-Clashes
1	A	436	MLY	2	0
1	D	248	MLY	2	0
1	A	505	MLY	11	0
1	J	55	MLY	1	0
1	G	839	MLY	4	0
1	J	436	MLY	2	0
1	D	659	MLY	2	0
1	G	659	MLY	2	0
1	J	87	MLY	3	0
1	J	839	MLY	5	0
1	A	138	MLY	1	0
1	J	617	MLY	1	0
1	D	138	MLY	1	0
1	A	764	MLY	7	0

Continued on next page...

Continued from previous page...

Mol	Chain	Res	Type	Clashes	Symm-Clashes
1	J	768	MLY	41	0
1	G	138	MLY	1	0
1	D	272	MLY	1	0
1	J	63	MLY	4	0
1	J	551	MLY	1	0
1	A	415	MLY	1	0
1	A	30	MLY	1	0
1	G	30	MLY	1	0
1	G	827	MLY	1	0
1	A	190	MLY	2	0
1	D	764	MLY	2	0
1	G	551	MLY	2	0
1	D	63	MLY	3	0
1	A	369	MLY	1	0
1	A	87	MLY	3	0
1	J	296	MLY	3	0
1	G	768	MLY	15	0
1	G	107	MLY	3	0
1	G	248	MLY	2	0
1	G	837	MLY	1	0
1	G	84	MLY	18	0
1	A	295	MLY	6	0
1	G	190	MLY	2	0
1	A	617	MLY	1	0
1	J	486	MLY	3	0
1	D	551	MLY	1	0
1	J	49	MLY	2	0
1	A	59	MLY	2	0
1	A	659	MLY	2	0
1	G	63	MLY	3	0
1	J	248	MLY	2	0
1	J	84	MLY	25	0
1	G	553	MLY	16	0
1	D	295	MLY	6	0
1	G	59	MLY	3	0
1	D	190	MLY	2	0
1	J	295	MLY	6	0
1	D	768	MLY	6	0
1	A	486	MLY	3	0
1	A	528	MLY	2	0
1	A	348	MLY	5	0
1	A	600	MLY	1	0

Continued on next page...

Continued from previous page...

Mol	Chain	Res	Type	Clashes	Symm-Clashes
1	A	837	MLY	1	0
1	A	782	MLY	1	0
1	D	598	MLY	1	0
1	J	272	MLY	1	0
1	J	598	MLY	1	0
1	A	55	MLY	1	0
1	G	600	MLY	1	0
1	G	369	MLY	1	0
1	D	528	MLY	3	0
1	D	436	MLY	2	0
1	D	30	MLY	1	0
1	D	59	MLY	2	0
1	D	55	MLY	1	0
1	A	839	MLY	15	0
1	A	107	MLY	3	0
1	J	837	MLY	1	0
1	A	63	MLY	3	0
1	J	138	MLY	1	0
1	G	415	MLY	1	0
1	D	553	MLY	16	0
1	G	295	MLY	5	0
1	G	49	MLY	2	0
1	J	764	MLY	26	0
1	D	486	MLY	3	0
1	D	600	MLY	1	0
1	D	782	MLY	32	0
1	D	837	MLY	1	0
1	G	296	MLY	2	0
1	A	504	MLY	4	0
1	D	617	MLY	1	0
1	J	415	MLY	1	0
1	J	30	MLY	1	0
1	J	190	MLY	2	0
1	A	768	MLY	14	0
1	A	551	MLY	2	0
1	J	659	MLY	2	0
1	G	598	MLY	1	0
1	G	617	MLY	1	0
1	G	436	MLY	2	0
1	G	348	MLY	4	0
1	A	49	MLY	3	0
1	D	839	MLY	16	0

Continued on next page...

Continued from previous page...

Mol	Chain	Res	Type	Clashes	Symm-Clashes
1	D	107	MLY	2	0
1	A	248	MLY	2	0
1	D	87	MLY	3	0
1	A	296	MLY	2	0
1	J	107	MLY	3	0
1	J	59	MLY	3	0
1	G	87	MLY	2	0
1	G	528	MLY	3	0
1	G	486	MLY	3	0
1	A	553	MLY	17	0
1	G	782	MLY	1	0
1	A	272	MLY	1	0
1	A	598	MLY	1	0
1	D	49	MLY	3	0
1	D	296	MLY	3	0
1	D	348	MLY	6	0
1	J	553	MLY	17	0
1	G	764	MLY	12	0
1	G	55	MLY	1	0
1	J	528	MLY	3	0
1	G	272	MLY	1	0
1	J	348	MLY	5	0
1	J	600	MLY	1	0
1	J	827	MLY	1	0
1	D	415	MLY	1	0
1	J	782	MLY	1	0

5.5 Carbohydrates [i](#)

There are no monosaccharides in this entry.

5.6 Ligand geometry [i](#)

There are no ligands in this entry.

5.7 Other polymers [i](#)

There are no such residues in this entry.

5.8 Polymer linkage issues

The following chains have linkage breaks:

Mol	Chain	Number of breaks
1	G	4
1	J	4
1	D	4
1	A	4
3	C	1
3	F	1
3	I	1
3	L	1
2	B	1
2	E	1
2	H	1
2	K	1

The worst 5 of 24 chain breaks are listed below:

Model	Chain	Residue-1	Atom-1	Residue-2	Atom-2	Distance (Å)
1	G	769:ALA	C	770:GLY	N	4.89
1	J	769:ALA	C	770:GLY	N	4.67
1	D	769:ALA	C	770:GLY	N	4.54
1	D	709:LYS	C	710:GLY	N	3.32
1	A	709:LYS	C	710:GLY	N	3.28

6 Tomogram visualisation [i](#)

This section contains visualisations of the EMDB entry EMD-1001. These allow visual inspection of the internal detail of the tomogram and identification of artifacts.

6.1 Orthogonal projections [i](#)

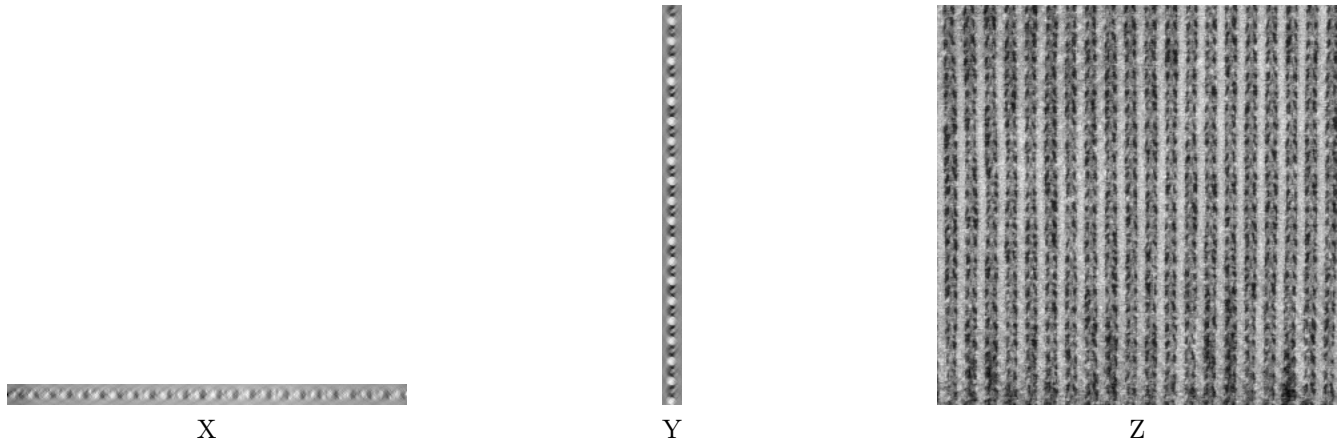

The images above show the tomogram projected in three orthogonal directions.

6.2 Central slices [i](#)

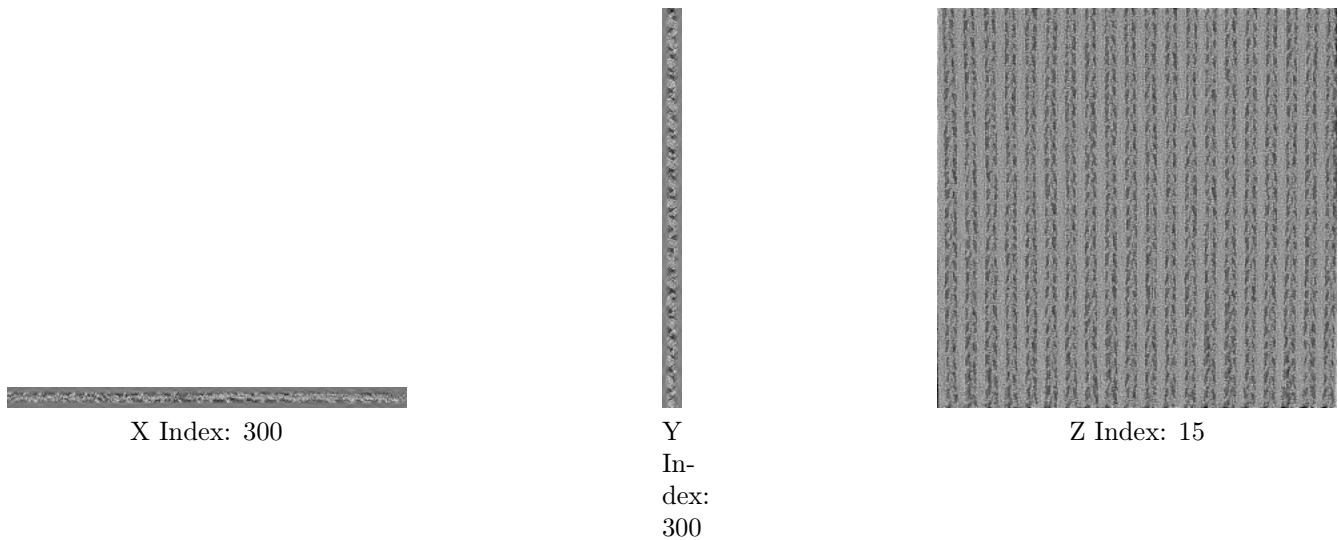

The images above show central slices of the tomogram in three orthogonal directions.

6.3 Largest variance slices [i](#)

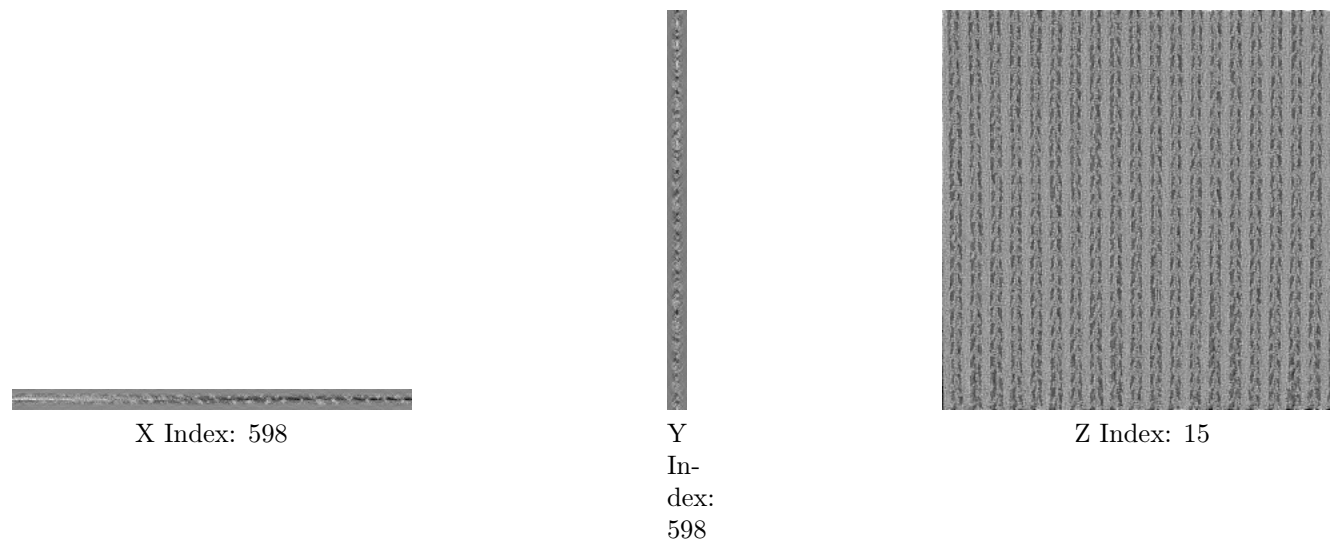

The images above show the largest variance slices of the tomogram in three orthogonal directions.

6.4 Orthogonal standard-deviation projections (False-color) [i](#)

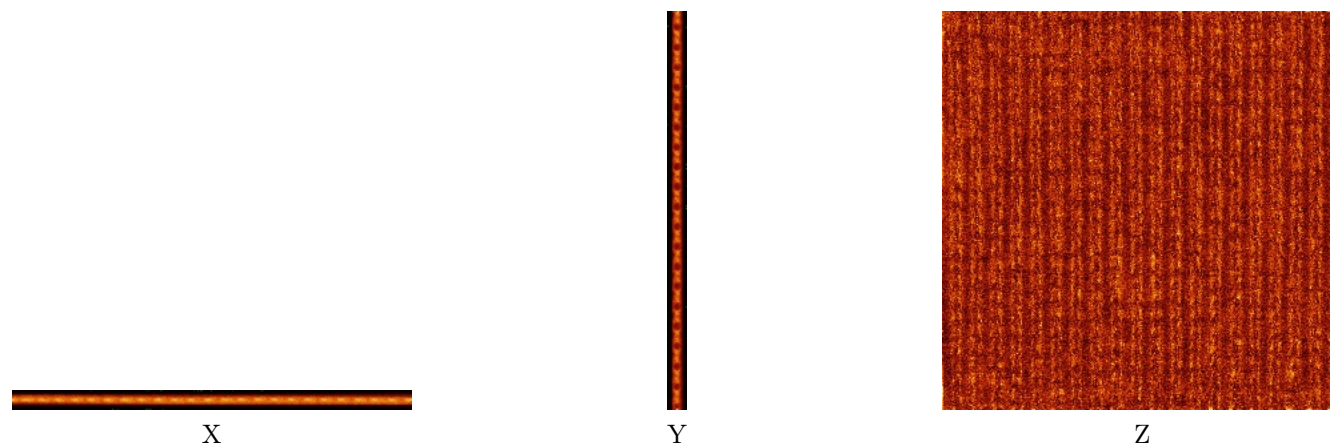

The images above show the tomogram projected in three orthogonal directions.

6.5 Mask visualisation [i](#)

This section shows the 3D surface view of the primary map at 50% transparency overlaid with the specified mask at 0% transparency

A mask typically either:

- Encompasses the whole structure
- Separates out a domain, a functional unit, a monomer or an area of interest from a larger structure

6.5.1 emd_1001_msk_25.map [i](#)

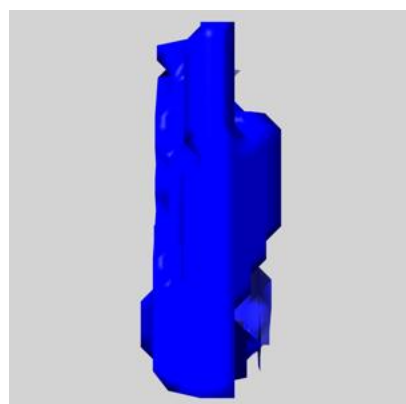

X

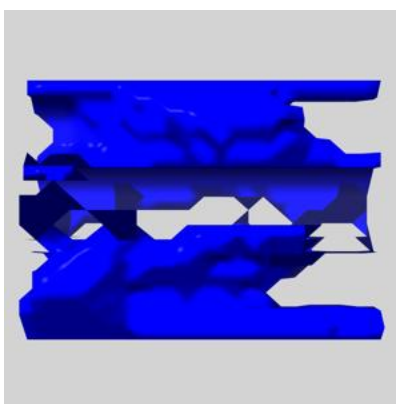

Y

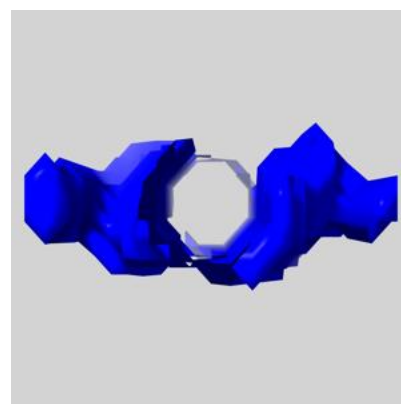

Z

6.5.2 emd_1001_msk_24.map [i](#)

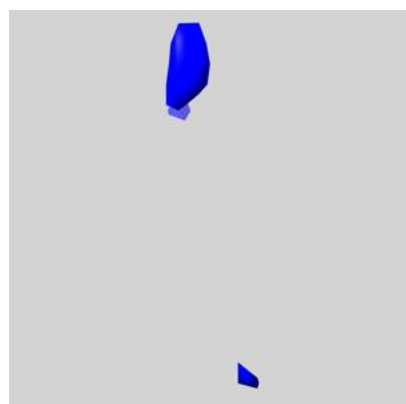

X

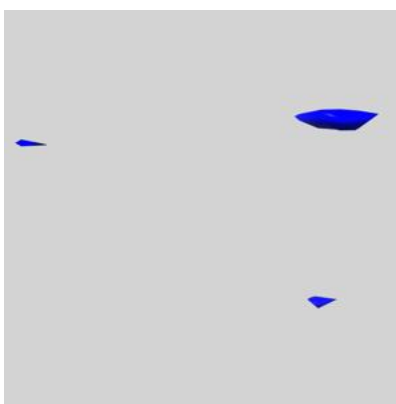

Y

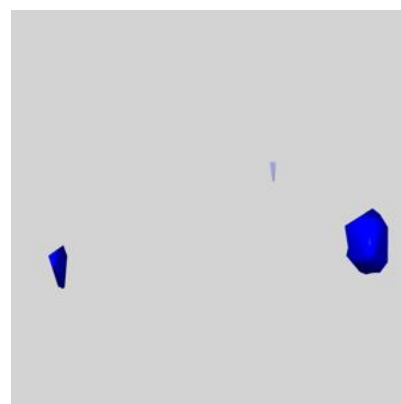

Z

6.5.3 emd_1001_msk_23.map [i](#)

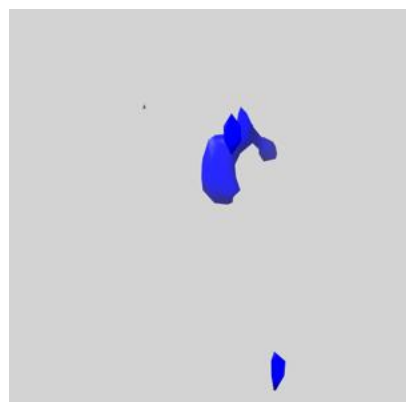

X

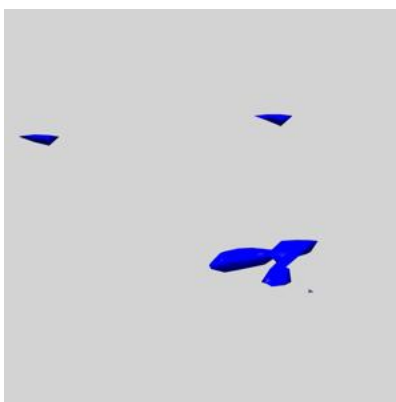

Y

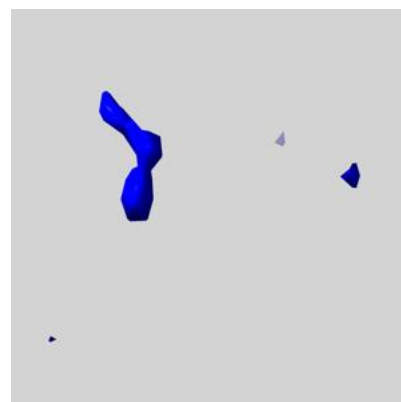

Z

6.5.4 emd_1001_msk_22.map [i](#)

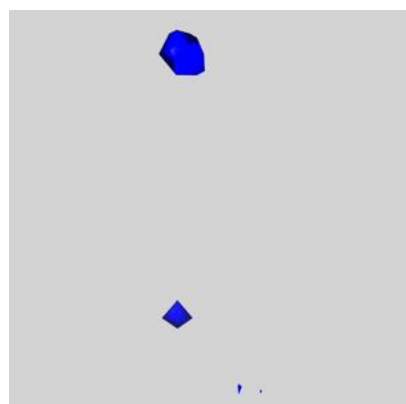

X

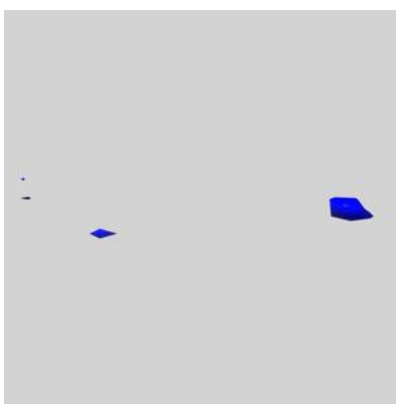

Y

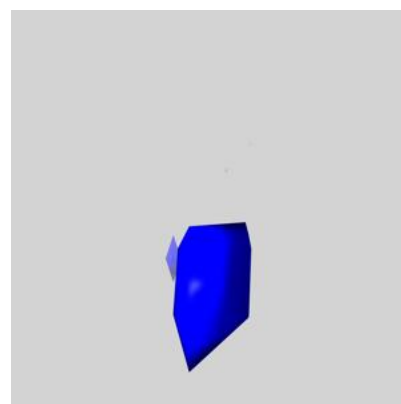

Z

6.5.5 emd_1001_msk_21.map [i](#)

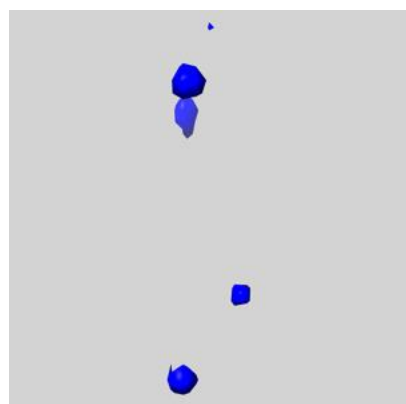

X

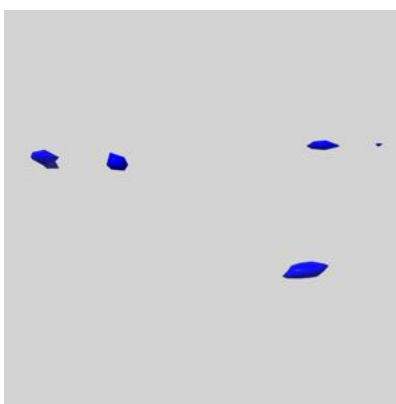

Y

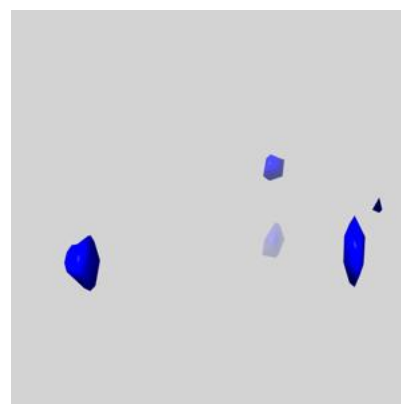

Z

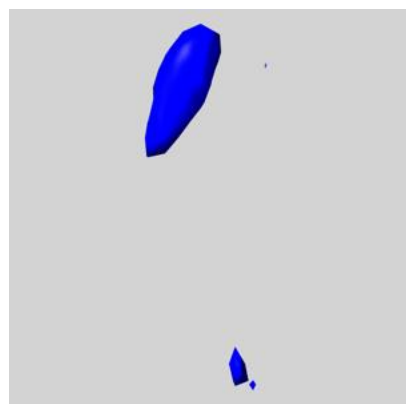
6.5.6 emd_1001_msk_20.map [i](#)

X

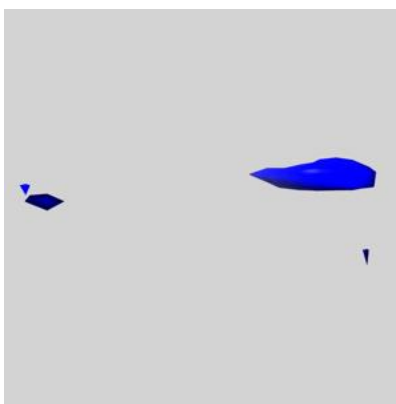

Y

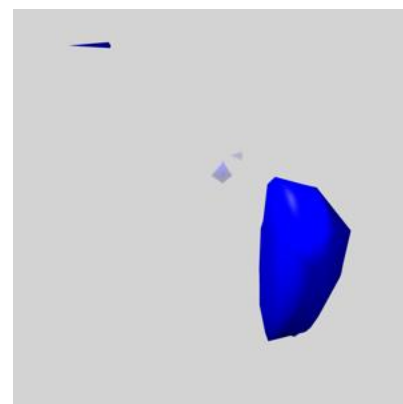

Z

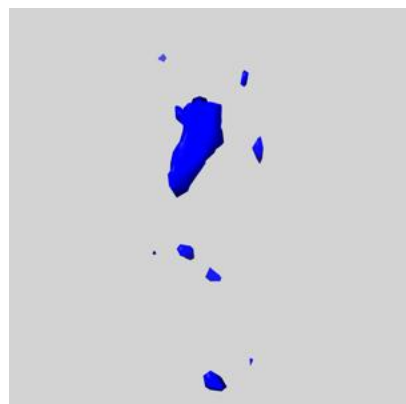
6.5.7 emd_1001_msk_19.map [i](#)

X

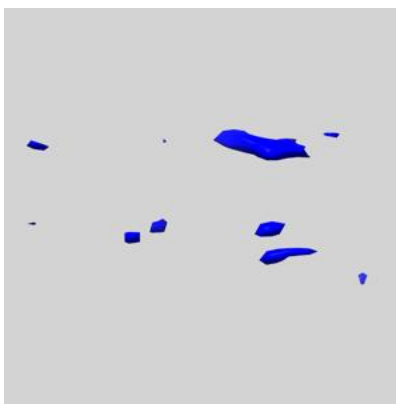

Y

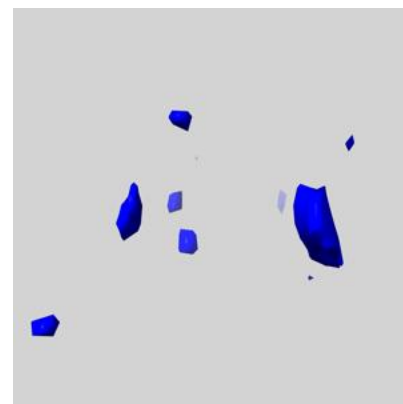

Z

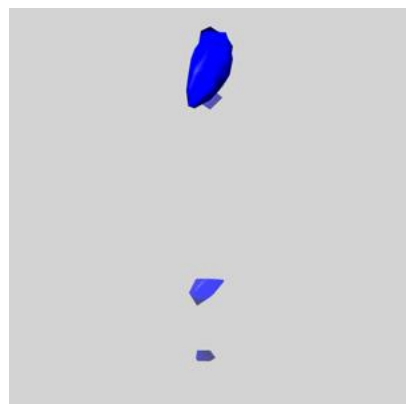
6.5.8 emd_1001_msk_18.map [i](#)

X

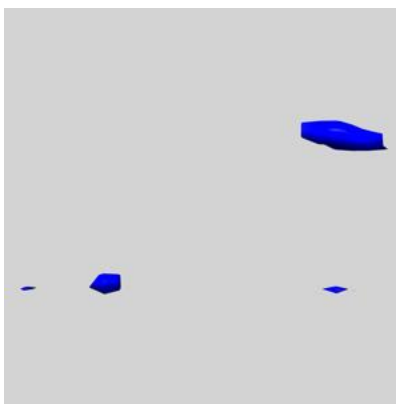

Y

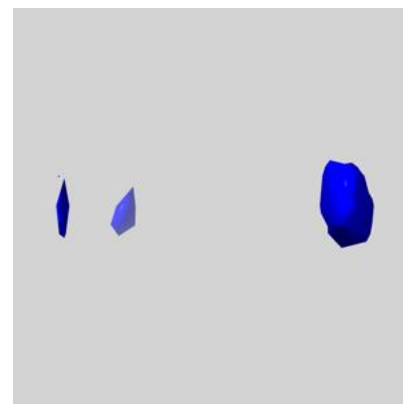

Z

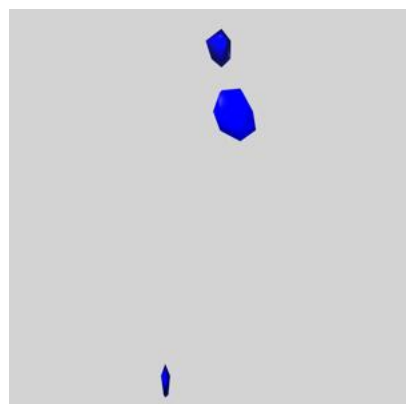
6.5.9 emd_1001_msk_17.map [i](#)

X

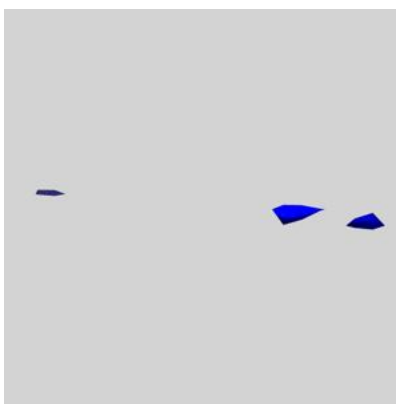

Y

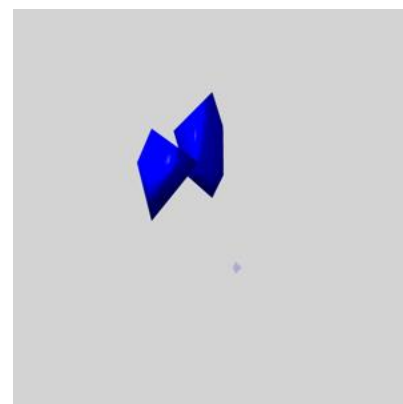

Z

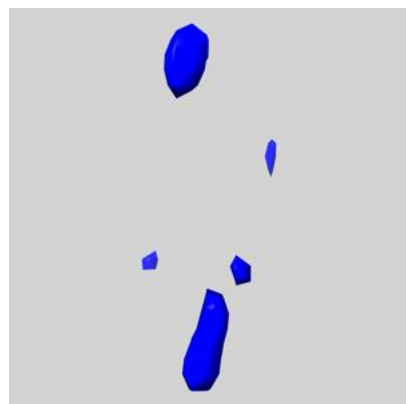
6.5.10 emd_1001_msk_16.map [i](#)

X

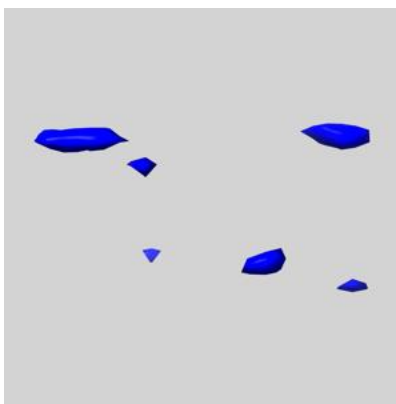

Y

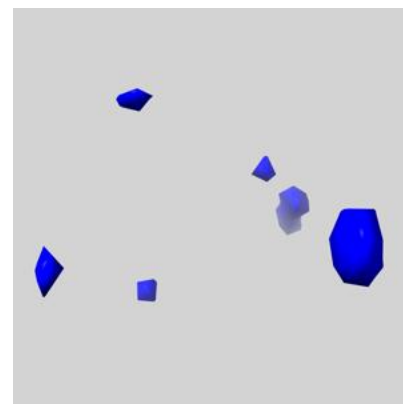

Z

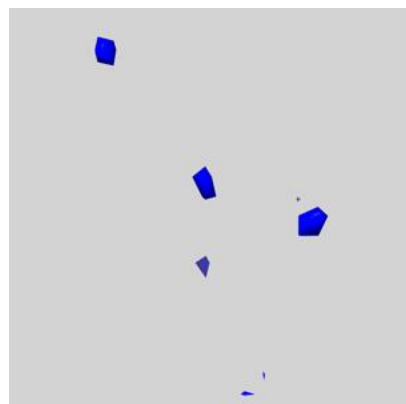
6.5.11 emd_1001_msk_15.map [i](#)

X

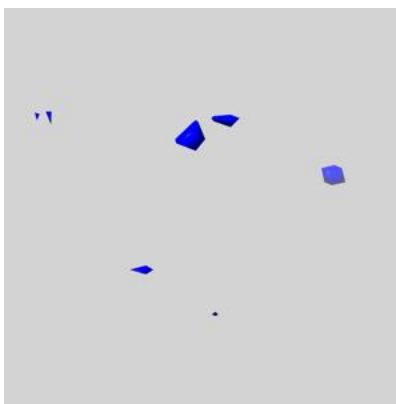

Y

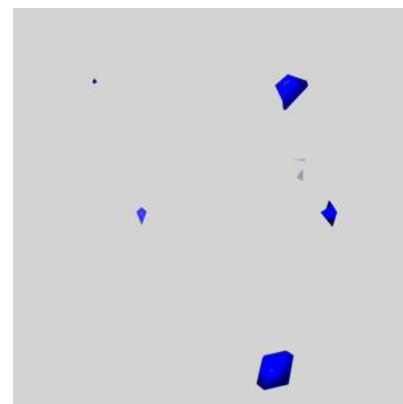

Z

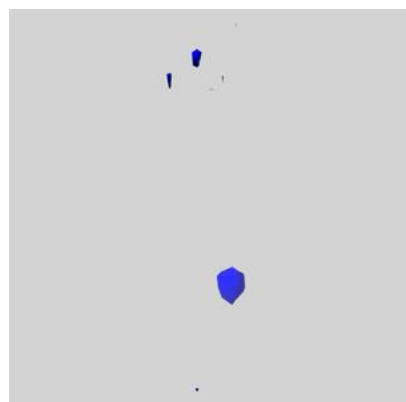
6.5.12 emd_1001_msk_14.map [i](#)

X

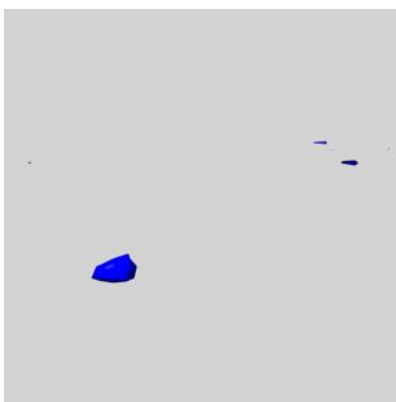

Y

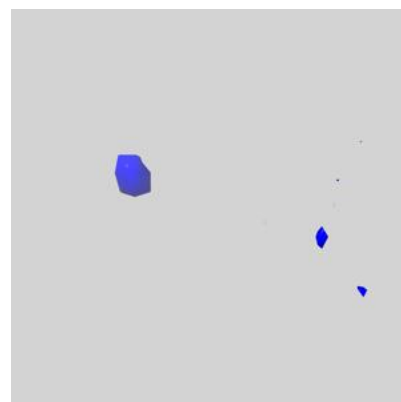

Z

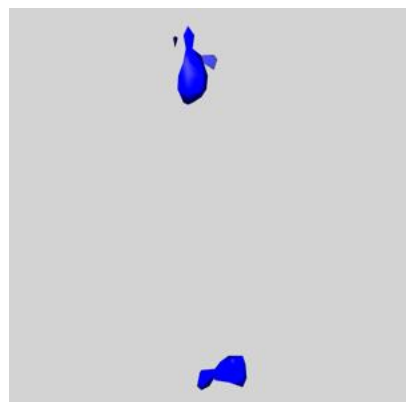
6.5.13 emd_1001_msk_13.map [i](#)

X

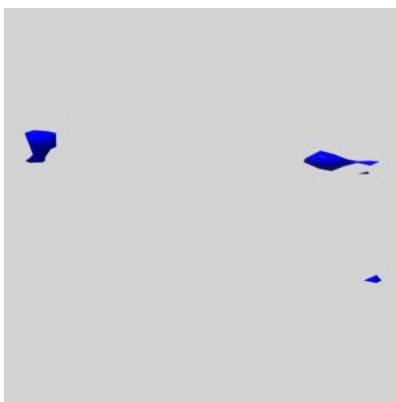

Y

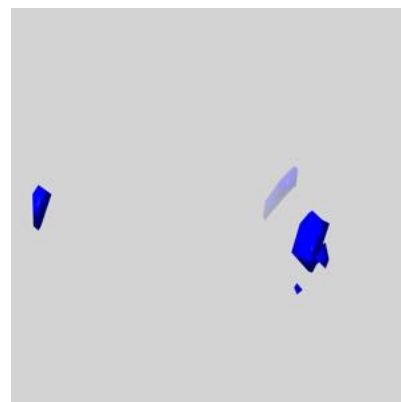

Z

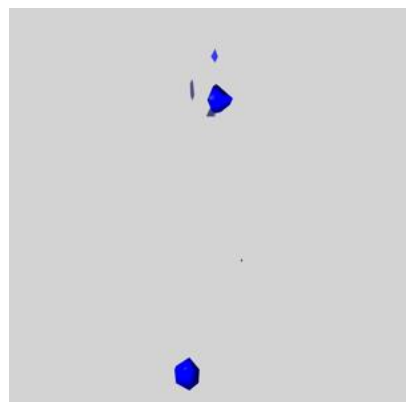
6.5.14 emd_1001_msk_12.map [i](#)

X

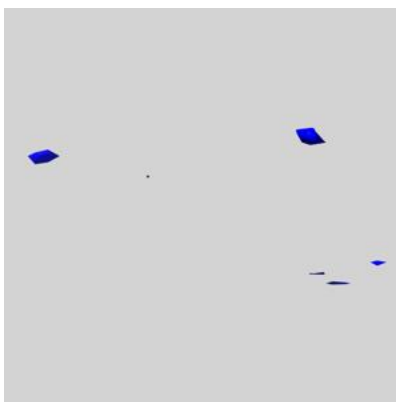

Y

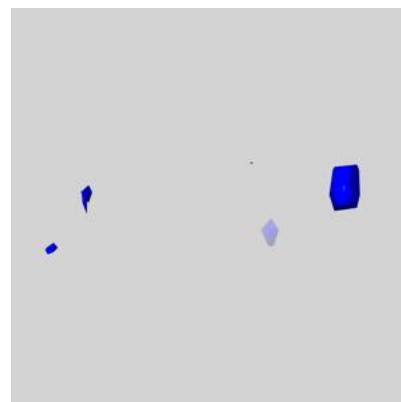

Z

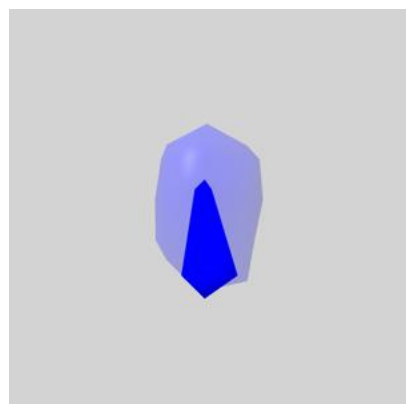
6.5.15 emd_1001_msk_11.map [i](#)

X

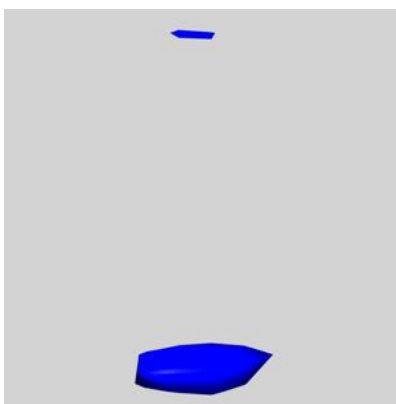

Y

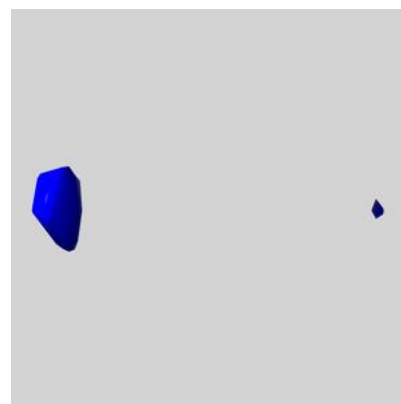

Z

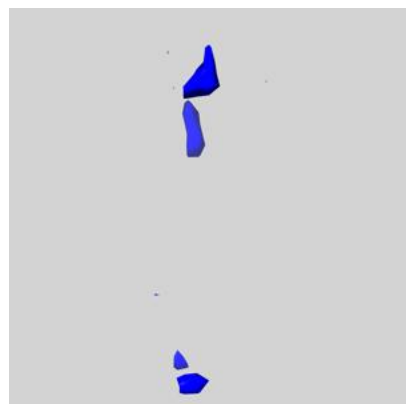
6.5.16 emd_1001_msk_10.map [i](#)

X

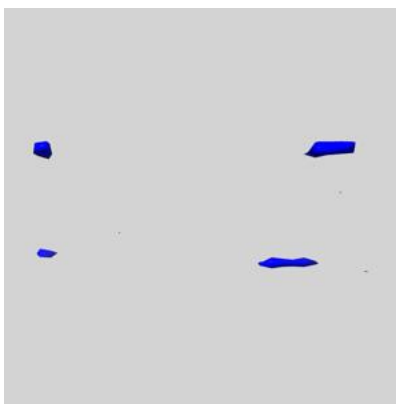

Y

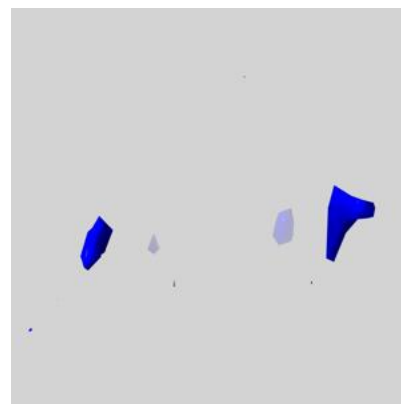

Z

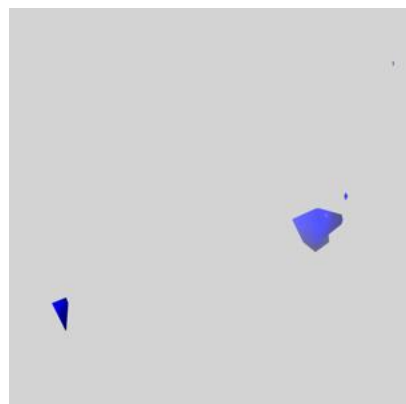
6.5.17 emd_1001_msk_9.map [i](#)

X

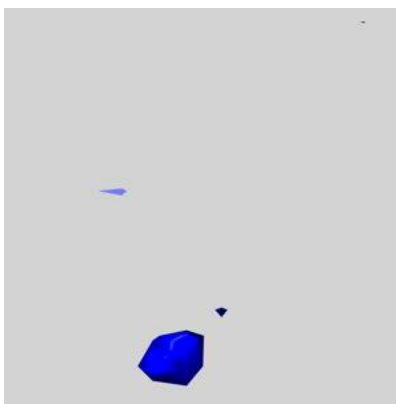

Y

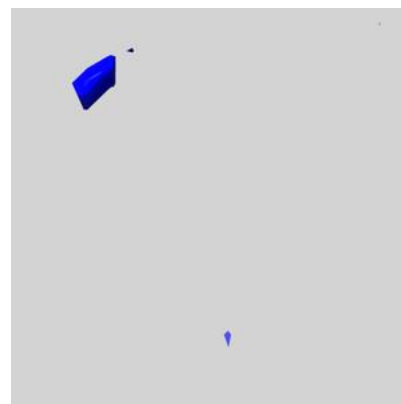

Z

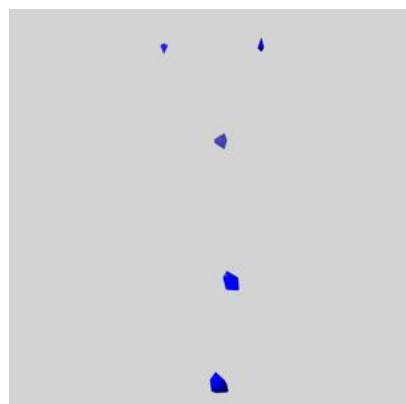
6.5.18 emd_1001_msk_8.map [i](#)

X

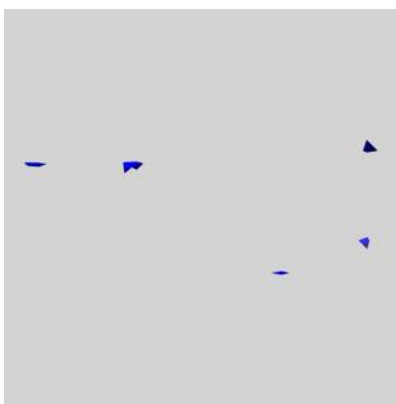

Y

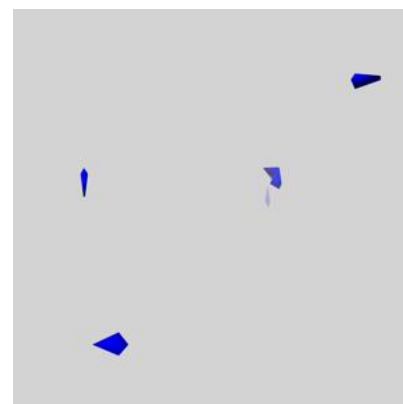

Z

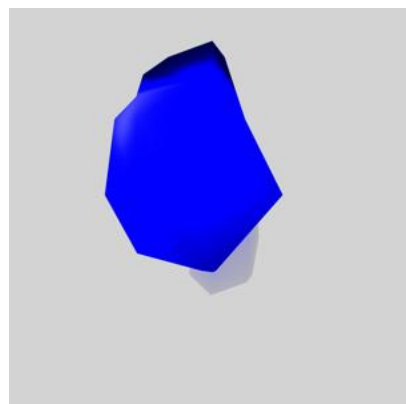
6.5.19 emd_1001_msk_7.map [i](#)

X

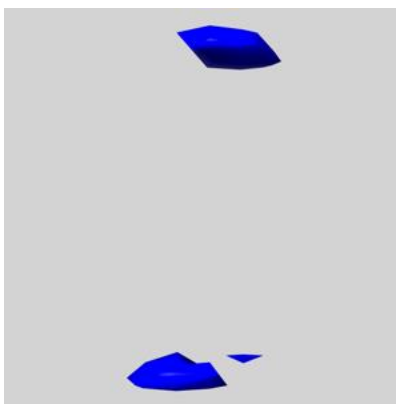

Y

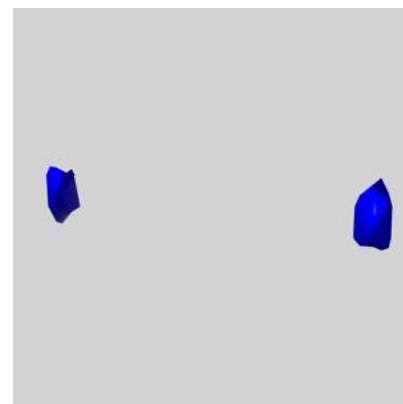

Z

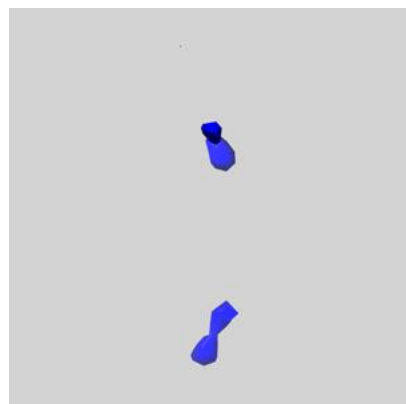
6.5.20 emd_1001_msk_6.map [i](#)

X

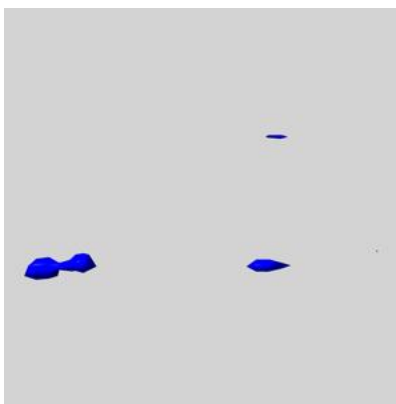

Y

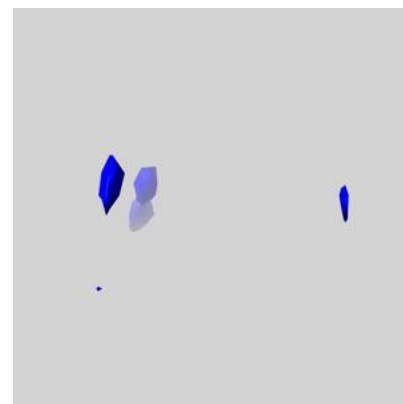

Z

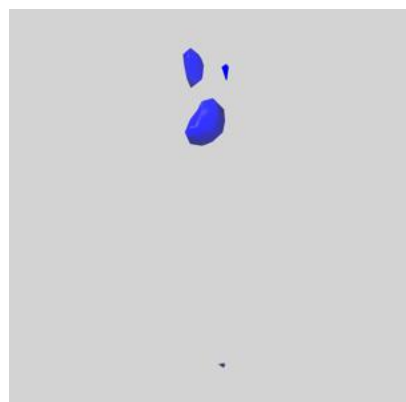
6.5.21 emd_1001_msk_5.map [i](#)

X

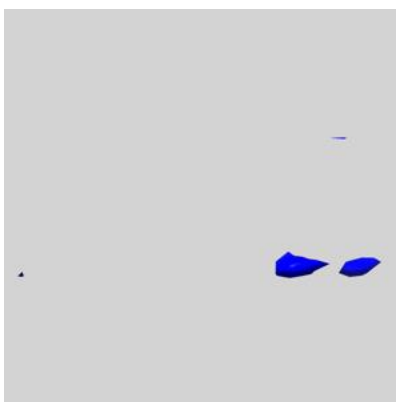

Y

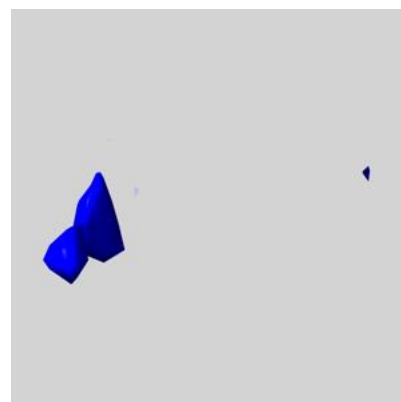

Z

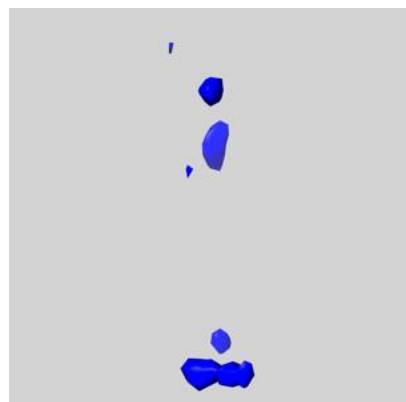
6.5.22 emd_1001_msk_4.map [i](#)

X

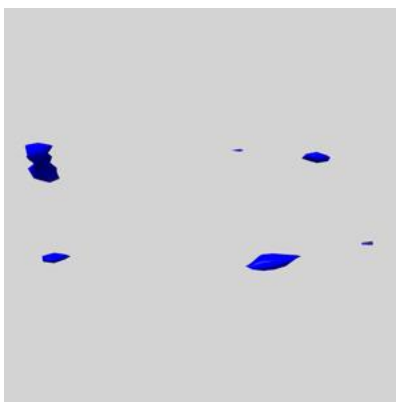

Y

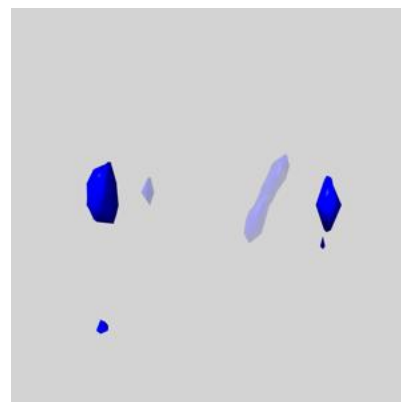

Z

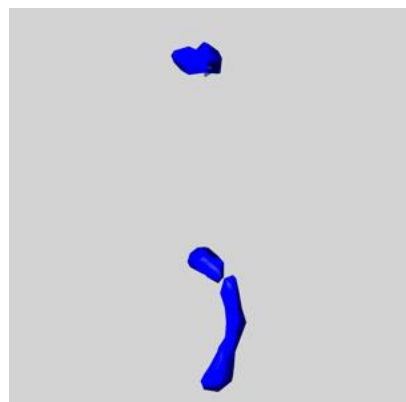
6.5.23 emd_1001_msk_3.map [i](#)

X

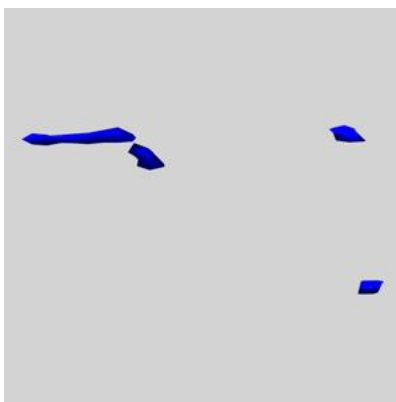

Y

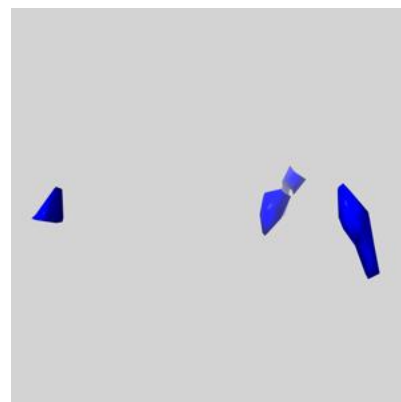

Z

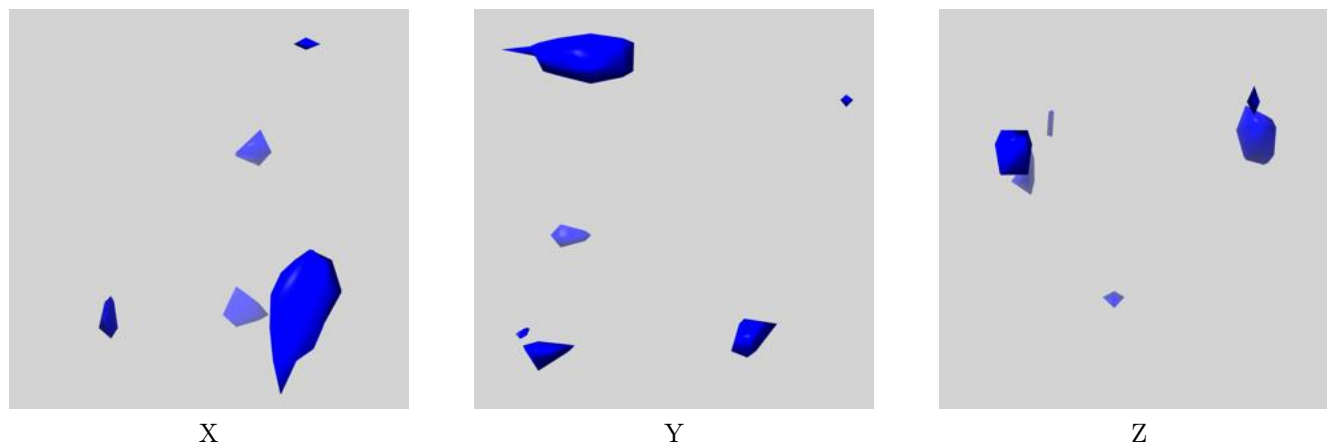
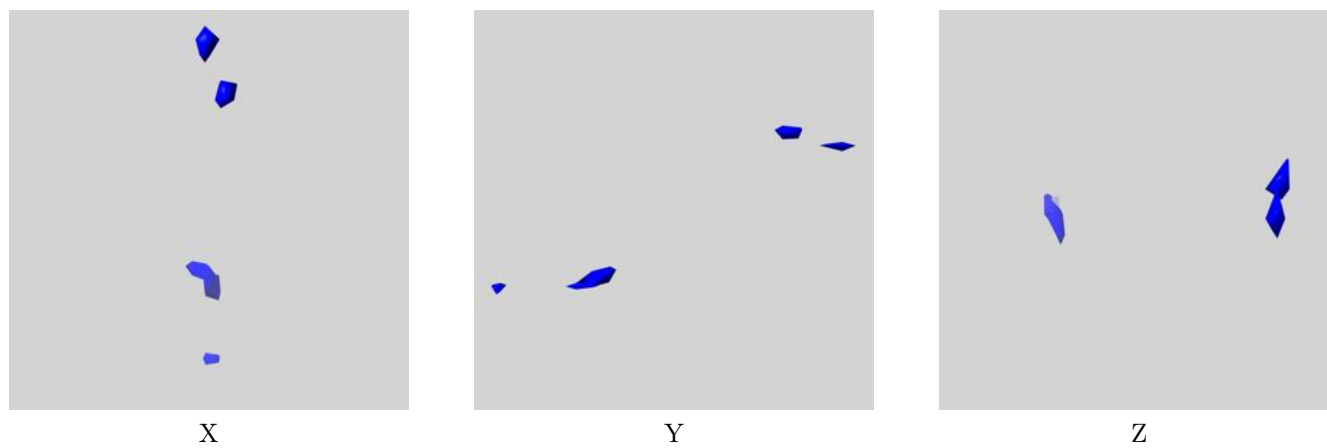
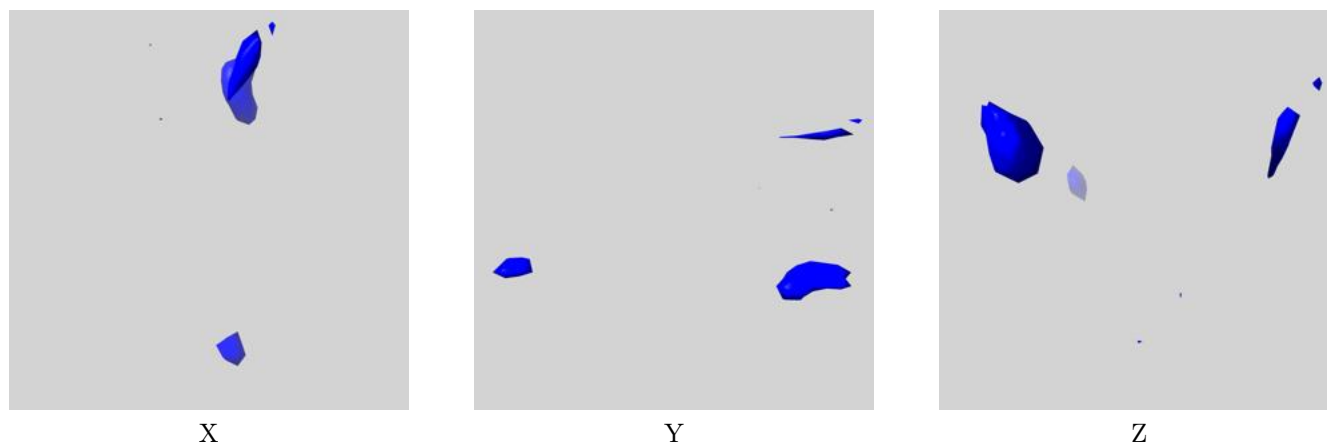
6.5.24 emd_1001_msk_2.map [i](#)6.5.25 emd_1001_msk_1.map [i](#)6.5.26 emd_1001_msk_26.map [i](#)

7 Tomogram analysis [i](#)

This section contains the results of statistical analysis of the tomogram.

7.1 Voxel-value distribution [i](#)

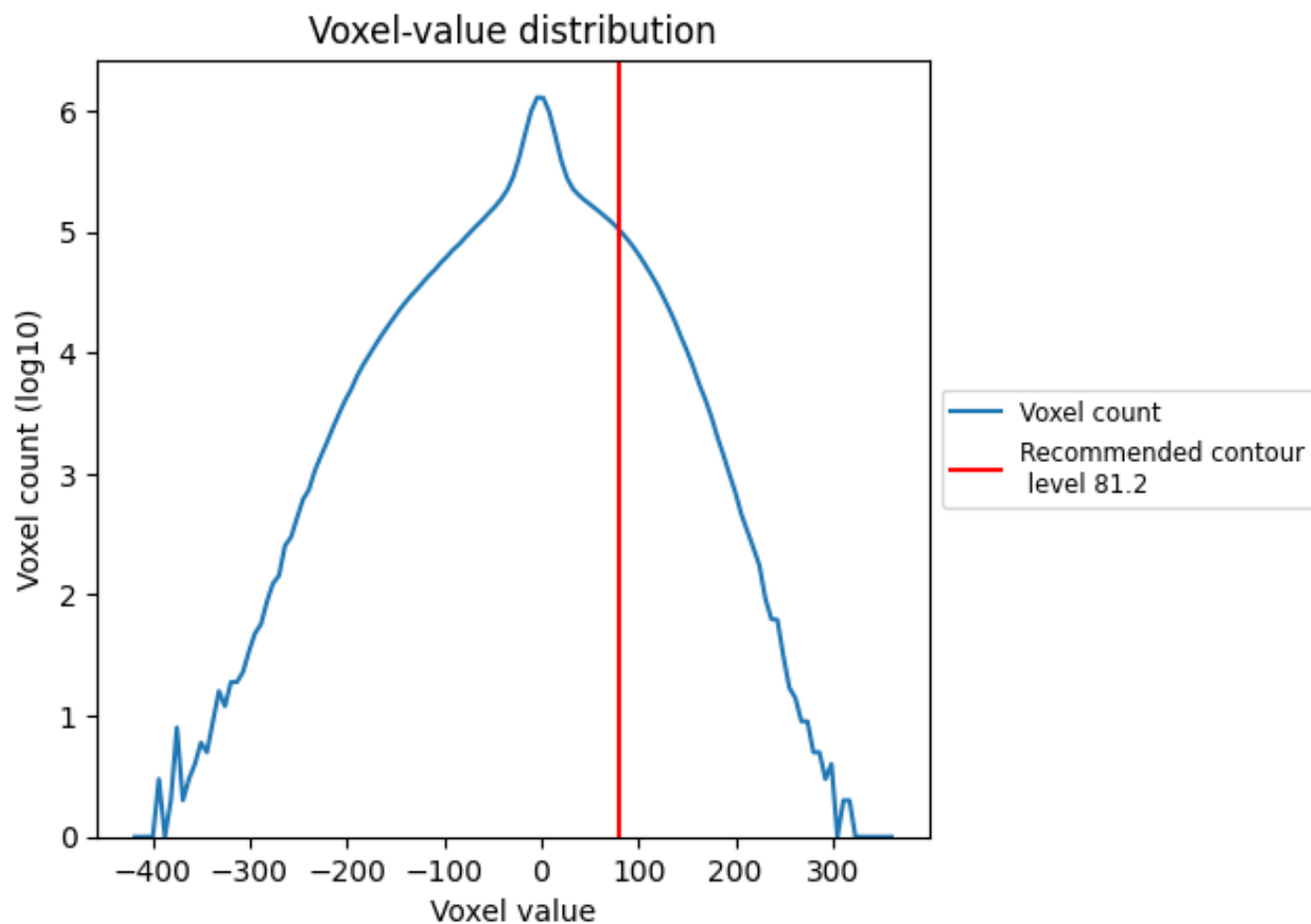

The voxel-value distribution is plotted in 128 intervals along the x-axis. The y-axis is logarithmic.

8 Map-model fit [i](#)

This section contains information regarding the fit between EMDB map EMD-1001 and PDB model 1O1F. Per-residue inclusion information can be found in section 3 on page 7.

8.1 Map-model overlay [i](#)

This section was not generated.

8.2 Q-score mapped to coordinate model [i](#)

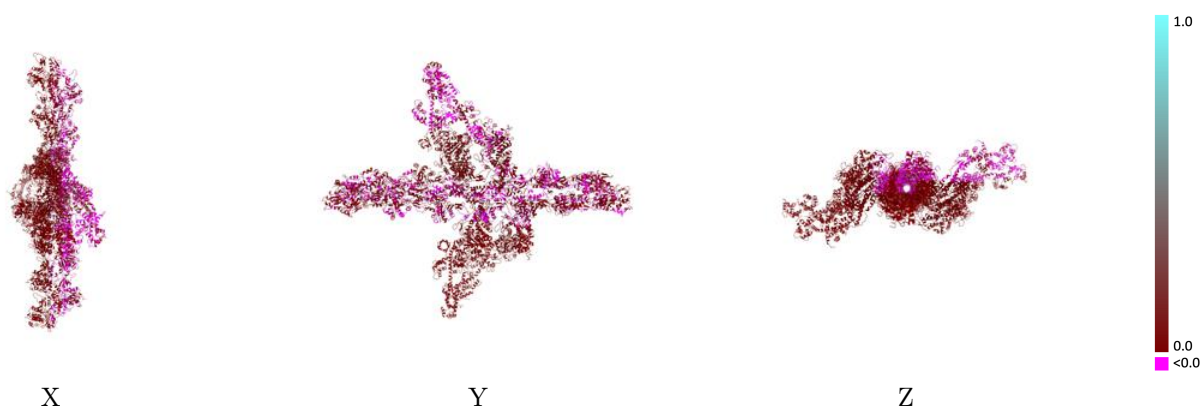

The images above show the model with each residue coloured according its Q-score. This shows their resolvability in the map with higher Q-score values reflecting better resolvability. Please note: Q-score is calculating the resolvability of atoms, and thus high values are only expected at resolutions at which atoms can be resolved. Low Q-score values may therefore be expected for many entries.

8.3 Atom inclusion mapped to coordinate model [i](#)

This section was not generated.



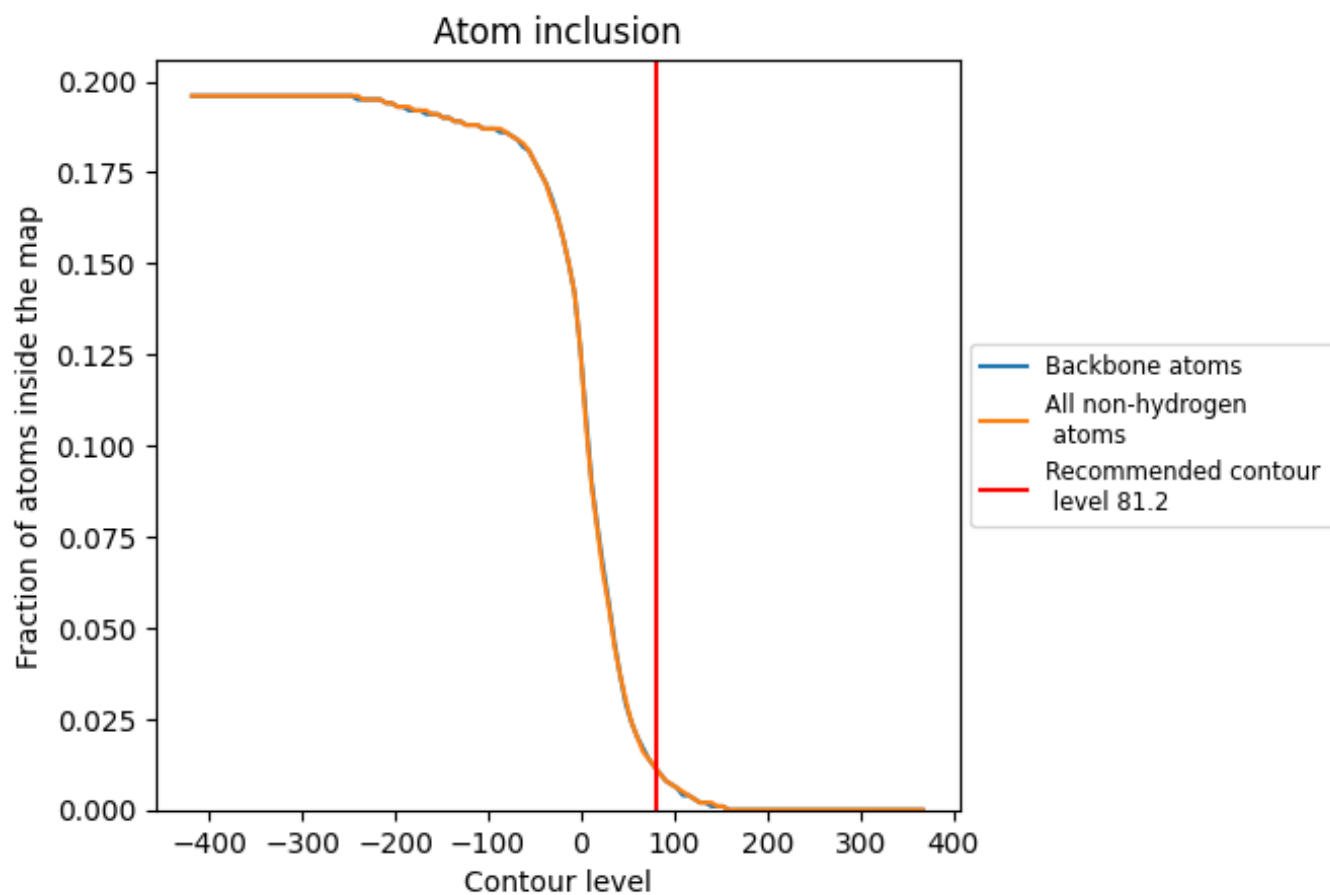



















































8.4 Atom inclusion [i](#)



At the recommended contour level, 1% of all backbone atoms, 1% of all non-hydrogen atoms, are inside the map.

8.5 Map-model fit summary

The table lists the average atom inclusion at the recommended contour level (81.2) and Q-score for the entire model and for each chain.

Chain	Atom inclusion	Q-score
All	 0.0110	 -0.0020
0	 0.0000	 -0.0030
1	 0.0000	 0.0070
2	 0.0000	 -0.0040
3	 0.0000	 0.0010
4	 0.0370	 -0.0030
5	 0.0000	 0.0010
6	 0.0080	 -0.0090
7	 0.0000	 -0.0010
8	 0.0640	 0.0030
A	 0.0000	 -0.0030
B	 0.0000	 0.0000
C	 0.0000	 0.0000
D	 0.0080	 -0.0060
E	 0.0000	 -0.0440
F	 0.0960	 0.0260
G	 0.0000	 0.0030
H	 0.0000	 0.0000
I	 0.0000	 0.0000
J	 0.0090	 -0.0000
K	 0.0000	 -0.0010
L	 0.2550	 -0.0210
V	 0.0000	 0.0010
W	 0.0000	 -0.0010
X	 0.0000	 -0.0020
Y	 0.0000	 -0.0080
Z	 0.0000	 0.0030

