



# wwPDB X-ray Structure Validation Summary Report ⓘ

Oct 31, 2023 – 07:26 PM EDT

PDB ID : 3O4F  
Title : Crystal Structure of Spermidine Synthase from E. coli  
Authors : Zhou, X.; Tkaczuk, K.L.; Chruszcz, M.; Chua, T.K.; Minor, W.; Sivaraman, J.  
Deposited on : 2010-07-27  
Resolution : 2.90 Å(reported)

This is a wwPDB X-ray Structure Validation Summary Report for a publicly released PDB entry.

We welcome your comments at [validation@mail.wwpdb.org](mailto:validation@mail.wwpdb.org)

A user guide is available at

<https://www.wwpdb.org/validation/2017/XrayValidationReportHelp>

with specific help available everywhere you see the ⓘ symbol.

The types of validation reports are described at

<http://www.wwpdb.org/validation/2017/FAQs#types>.

---

The following versions of software and data (see [references ⓘ](#)) were used in the production of this report:

MolProbity : 4.02b-467  
Mogul : 1.8.5 (274361), CSD as541be (2020)  
Xtriage (Phenix) : 1.13  
EDS : 2.36  
Percentile statistics : 20191225.v01 (using entries in the PDB archive December 25th 2019)  
Refmac : 5.8.0158  
CCP4 : 7.0.044 (Gargrove)  
Ideal geometry (proteins) : Engh & Huber (2001)  
Ideal geometry (DNA, RNA) : Parkinson et al. (1996)  
Validation Pipeline (wwPDB-VP) : 2.36

# 1 Overall quality at a glance i

The following experimental techniques were used to determine the structure:

*X-RAY DIFFRACTION*

The reported resolution of this entry is 2.90 Å.

Percentile scores (ranging between 0-100) for global validation metrics of the entry are shown in the following graphic. The table shows the number of entries on which the scores are based.

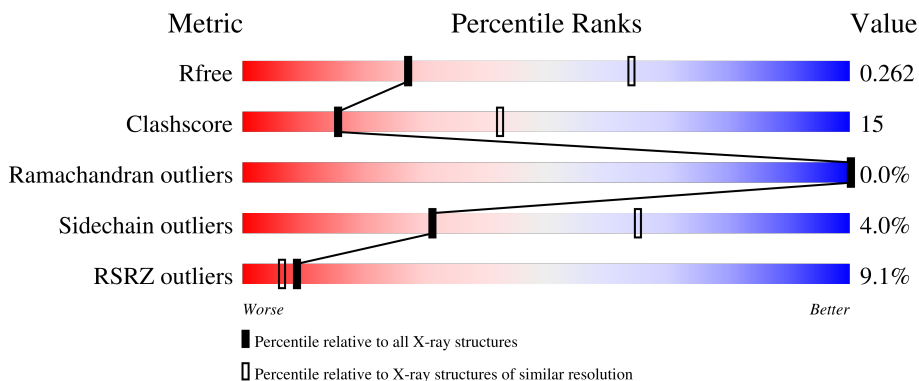

Metric	Whole archive (#Entries)	Similar resolution (#Entries, resolution range(Å))
$R_{free}$	130704	1957 (2.90-2.90)
Clashscore	141614	2172 (2.90-2.90)
Ramachandran outliers	138981	2115 (2.90-2.90)
Sidechain outliers	138945	2117 (2.90-2.90)
RSRZ outliers	127900	1906 (2.90-2.90)

The table below summarises the geometric issues observed across the polymeric chains and their fit to the electron density. The red, orange, yellow and green segments of the lower bar indicate the fraction of residues that contain outliers for  $\geq 3$ , 2, 1 and 0 types of geometric quality criteria respectively. A grey segment represents the fraction of residues that are not modelled. The numeric value for each fraction is indicated below the corresponding segment, with a dot representing fractions  $\leq 5\%$ . The upper red bar (where present) indicates the fraction of residues that have poor fit to the electron density. The numeric value is given above the bar.

Mol	Chain	Length	Quality of chain
1	A	294	<div style="display: flex; align-items: center;"> <div style="width: 6%; height: 10px; background-color: red; margin-right: 5px;"></div> <div style="width: 72%; height: 10px; background-color: green; margin-right: 5px;"></div> <div style="width: 23%; height: 10px; background-color: yellow; margin-right: 5px;"></div> <div style="width: 2%; height: 10px; background-color: orange; margin-right: 5px;"></div> <div style="width: 1%; height: 10px; background-color: grey;"></div> </div> <p style="text-align: center; margin-top: 5px;">6%      72%      23%      • •</p>
1	B	294	<div style="display: flex; align-items: center;"> <div style="width: 2%; height: 10px; background-color: red; margin-right: 5px;"></div> <div style="width: 67%; height: 10px; background-color: green; margin-right: 5px;"></div> <div style="width: 23%; height: 10px; background-color: yellow; margin-right: 5px;"></div> <div style="width: 8%; height: 10px; background-color: orange; margin-right: 5px;"></div> <div style="width: 1%; height: 10px; background-color: grey;"></div> </div> <p style="text-align: center; margin-top: 5px;">2%      67%      23%      • 8%</p>
1	C	294	<div style="display: flex; align-items: center;"> <div style="width: 9%; height: 10px; background-color: red; margin-right: 5px;"></div> <div style="width: 71%; height: 10px; background-color: green; margin-right: 5px;"></div> <div style="width: 24%; height: 10px; background-color: yellow; margin-right: 5px;"></div> <div style="width: 2%; height: 10px; background-color: orange; margin-right: 5px;"></div> <div style="width: 1%; height: 10px; background-color: grey;"></div> </div> <p style="text-align: center; margin-top: 5px;">9%      71%      24%      • •</p>
1	D	294	<div style="display: flex; align-items: center;"> <div style="width: 0%; height: 10px; background-color: red; margin-right: 5px;"></div> <div style="width: 70%; height: 10px; background-color: green; margin-right: 5px;"></div> <div style="width: 21%; height: 10px; background-color: yellow; margin-right: 5px;"></div> <div style="width: 6%; height: 10px; background-color: orange; margin-right: 5px;"></div> <div style="width: 1%; height: 10px; background-color: grey;"></div> </div> <p style="text-align: center; margin-top: 5px;">%      70%      21%      • 6%</p>
1	E	294	<div style="display: flex; align-items: center;"> <div style="width: 17%; height: 10px; background-color: red; margin-right: 5px;"></div> <div style="width: 68%; height: 10px; background-color: green; margin-right: 5px;"></div> <div style="width: 25%; height: 10px; background-color: yellow; margin-right: 5px;"></div> <div style="width: 2%; height: 10px; background-color: orange; margin-right: 5px;"></div> <div style="width: 1%; height: 10px; background-color: grey;"></div> </div> <p style="text-align: center; margin-top: 5px;">17%      68%      25%      • •</p>

*Continued on next page...*

*Continued from previous page...*

Mol	Chain	Length	Quality of chain
1	F	294	
1	G	294	
1	H	294	

The following table lists non-polymeric compounds, carbohydrate monomers and non-standard residues in protein, DNA, RNA chains that are outliers for geometric or electron-density-fit criteria:

Mol	Type	Chain	Res	Chirality	Geometry	Clashes	Electron density
2	SO4	A	292	-	-	X	-
2	SO4	C	291	-	-	X	-
2	SO4	D	291	-	-	-	X
2	SO4	E	290	-	-	X	-

## 2 Entry composition [i](#)

There are 3 unique types of molecules in this entry. The entry contains 17519 atoms, of which 0 are hydrogens and 0 are deuteriums.

In the tables below, the ZeroOcc column contains the number of atoms modelled with zero occupancy, the AltConf column contains the number of residues with at least one atom in alternate conformation and the Trace column contains the number of residues modelled with at most 2 atoms.

- Molecule 1 is a protein called Spermidine synthase.

Mol	Chain	Residues	Atoms					ZeroOcc	AltConf	Trace
			Total	C	N	O	S			
1	A	282	2212	1409	376	415	12	0	0	0
1	B	270	2135	1359	366	398	12	0	0	0
1	C	284	2228	1417	379	420	12	0	0	0
1	D	276	2176	1385	371	408	12	0	0	0
1	E	283	2208	1406	372	418	12	0	0	0
1	F	269	2116	1347	361	396	12	0	0	0
1	G	279	2189	1396	371	410	12	0	0	0
1	H	264	2087	1330	356	389	12	0	0	0

There are 48 discrepancies between the modelled and reference sequences:

Chain	Residue	Modelled	Actual	Comment	Reference
A	-5	HIS	-	expression tag	UNP P09158
A	-4	HIS	-	expression tag	UNP P09158
A	-3	HIS	-	expression tag	UNP P09158
A	-2	HIS	-	expression tag	UNP P09158
A	-1	HIS	-	expression tag	UNP P09158
A	0	HIS	-	expression tag	UNP P09158
B	-5	HIS	-	expression tag	UNP P09158
B	-4	HIS	-	expression tag	UNP P09158
B	-3	HIS	-	expression tag	UNP P09158
B	-2	HIS	-	expression tag	UNP P09158
B	-1	HIS	-	expression tag	UNP P09158
B	0	HIS	-	expression tag	UNP P09158
C	-5	HIS	-	expression tag	UNP P09158

*Continued on next page...*

*Continued from previous page...*

Chain	Residue	Modelled	Actual	Comment	Reference
C	-4	HIS	-	expression tag	UNP P09158
C	-3	HIS	-	expression tag	UNP P09158
C	-2	HIS	-	expression tag	UNP P09158
C	-1	HIS	-	expression tag	UNP P09158
C	0	HIS	-	expression tag	UNP P09158
D	-5	HIS	-	expression tag	UNP P09158
D	-4	HIS	-	expression tag	UNP P09158
D	-3	HIS	-	expression tag	UNP P09158
D	-2	HIS	-	expression tag	UNP P09158
D	-1	HIS	-	expression tag	UNP P09158
D	0	HIS	-	expression tag	UNP P09158
E	-5	HIS	-	expression tag	UNP P09158
E	-4	HIS	-	expression tag	UNP P09158
E	-3	HIS	-	expression tag	UNP P09158
E	-2	HIS	-	expression tag	UNP P09158
E	-1	HIS	-	expression tag	UNP P09158
E	0	HIS	-	expression tag	UNP P09158
F	-5	HIS	-	expression tag	UNP P09158
F	-4	HIS	-	expression tag	UNP P09158
F	-3	HIS	-	expression tag	UNP P09158
F	-2	HIS	-	expression tag	UNP P09158
F	-1	HIS	-	expression tag	UNP P09158
F	0	HIS	-	expression tag	UNP P09158
G	-5	HIS	-	expression tag	UNP P09158
G	-4	HIS	-	expression tag	UNP P09158
G	-3	HIS	-	expression tag	UNP P09158
G	-2	HIS	-	expression tag	UNP P09158
G	-1	HIS	-	expression tag	UNP P09158
G	0	HIS	-	expression tag	UNP P09158
H	-5	HIS	-	expression tag	UNP P09158
H	-4	HIS	-	expression tag	UNP P09158
H	-3	HIS	-	expression tag	UNP P09158
H	-2	HIS	-	expression tag	UNP P09158
H	-1	HIS	-	expression tag	UNP P09158
H	0	HIS	-	expression tag	UNP P09158

- Molecule 2 is SULFATE ION (three-letter code: SO4) (formula: O<sub>4</sub>S).



Mol	Chain	Residues	Atoms			ZeroOcc	AltConf
2	A	1	Total	O	S	0	0
			5	4	1		
2	A	1	Total	O	S	0	0
			5	4	1		
2	A	1	Total	O	S	0	0
			5	4	1		
2	A	1	Total	O	S	0	0
			5	4	1		
2	B	1	Total	O	S	0	0
			5	4	1		
2	B	1	Total	O	S	0	0
			5	4	1		
2	C	1	Total	O	S	0	0
			5	4	1		
2	C	1	Total	O	S	0	0
			5	4	1		
2	C	1	Total	O	S	0	0
			5	4	1		
2	C	1	Total	O	S	0	0
			5	4	1		
2	C	1	Total	O	S	0	0
			5	4	1		
2	D	1	Total	O	S	0	0
			5	4	1		
2	D	1	Total	O	S	0	0
			5	4	1		

*Continued on next page...*

*Continued from previous page...*

Mol	Chain	Residues	Atoms			ZeroOcc	AltConf
2	D	1	Total	O	S	0	0
			5	4	1		
2	D	1	Total	O	S	0	0
			5	4	1		
2	E	1	Total	O	S	0	0
			5	4	1		
2	E	1	Total	O	S	0	0
			5	4	1		
2	E	1	Total	O	S	0	0
			5	4	1		
2	E	1	Total	O	S	0	0
			5	4	1		
2	F	1	Total	O	S	0	0
			5	4	1		
2	F	1	Total	O	S	0	0
			5	4	1		
2	F	1	Total	O	S	0	0
			5	4	1		
2	F	1	Total	O	S	0	0
			5	4	1		
2	G	1	Total	O	S	0	0
			5	4	1		
2	G	1	Total	O	S	0	0
			5	4	1		
2	G	1	Total	O	S	0	0
			5	4	1		
2	G	1	Total	O	S	0	0
			5	4	1		
2	G	1	Total	O	S	0	0
			5	4	1		
2	H	1	Total	O	S	0	0
			5	4	1		
2	H	1	Total	O	S	0	0
			5	4	1		

- Molecule 3 is water.

Mol	Chain	Residues	Atoms		ZeroOcc	AltConf
3	A	2	Total	O	0	0
			2	2		
3	B	1	Total	O	0	0
			1	1		

*Continued on next page...*

*Continued from previous page...*

Mol	Chain	Residues	Atoms	ZeroOcc	AltConf
3	C	3	Total O 3 3	0	0
3	D	1	Total O 1 1	0	0
3	E	3	Total O 3 3	0	0
3	F	1	Total O 1 1	0	0
3	G	1	Total O 1 1	0	0
3	H	1	Total O 1 1	0	0



### 3 Residue-property plots [i](#)

These plots are drawn for all protein, RNA, DNA and oligosaccharide chains in the entry. The first graphic for a chain summarises the proportions of the various outlier classes displayed in the second graphic. The second graphic shows the sequence view annotated by issues in geometry and electron density. Residues are color-coded according to the number of geometric quality criteria for which they contain at least one outlier: green = 0, yellow = 1, orange = 2 and red = 3 or more. A red dot above a residue indicates a poor fit to the electron density ( $RSRZ > 2$ ). Stretches of 2 or more consecutive residues without any outlier are shown as a green connector. Residues present in the sample, but not in the model, are shown in grey.

- Molecule 1: Spermidine synthase

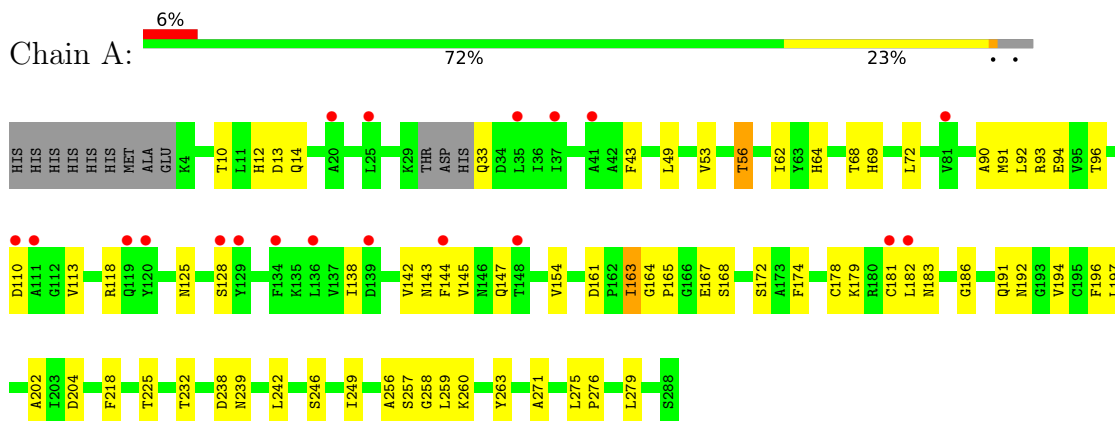

- Molecule 1: Spermidine synthase

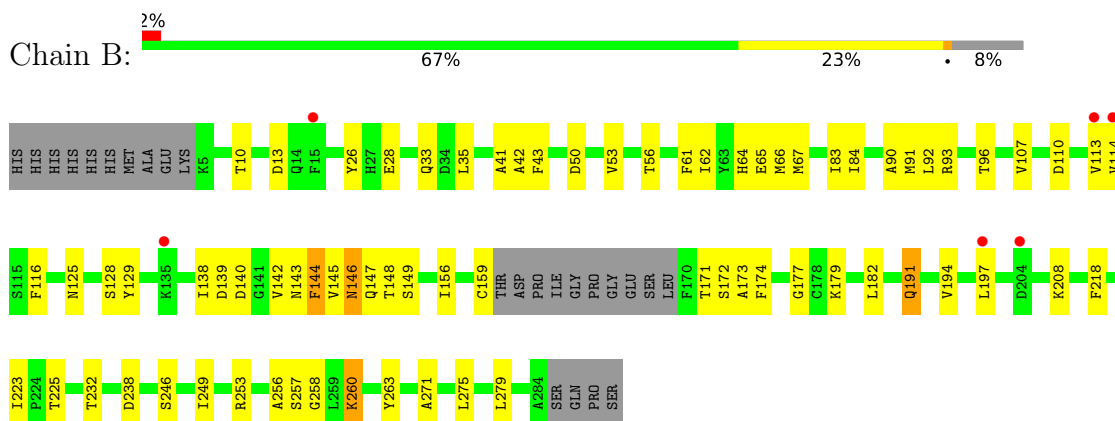

- Molecule 1: Spermidine synthase

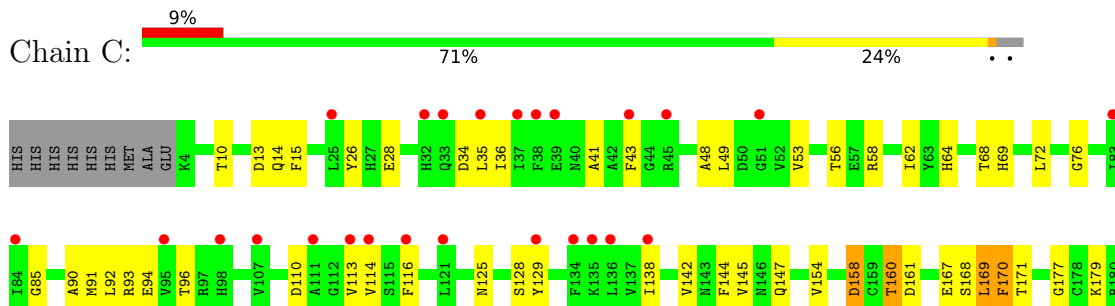



- Molecule 1: Spermidine synthase

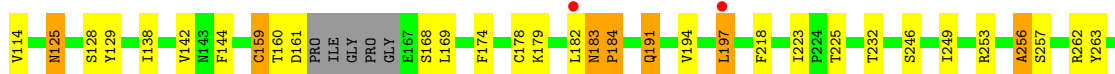
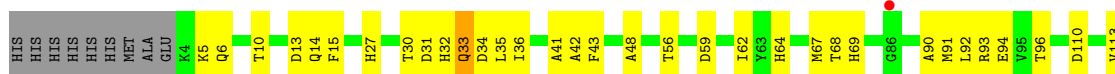

- Molecule 1: Spermidine synthase

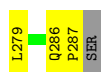
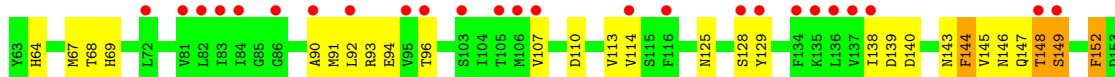
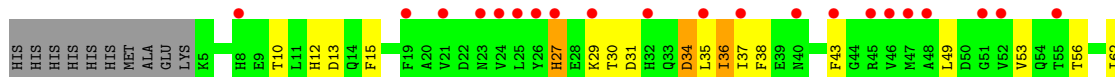

- Molecule 1: Spermidine synthase

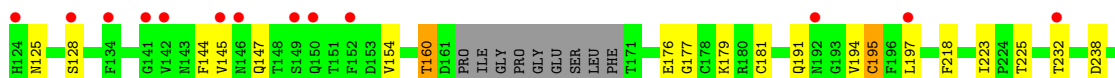
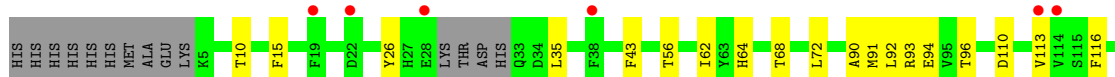
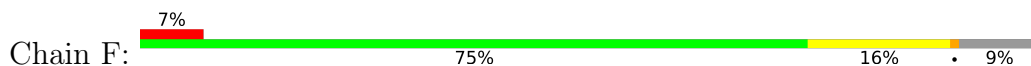

- Molecule 1: Spermidine synthase

Chain G: 15% 70% 23% 5%

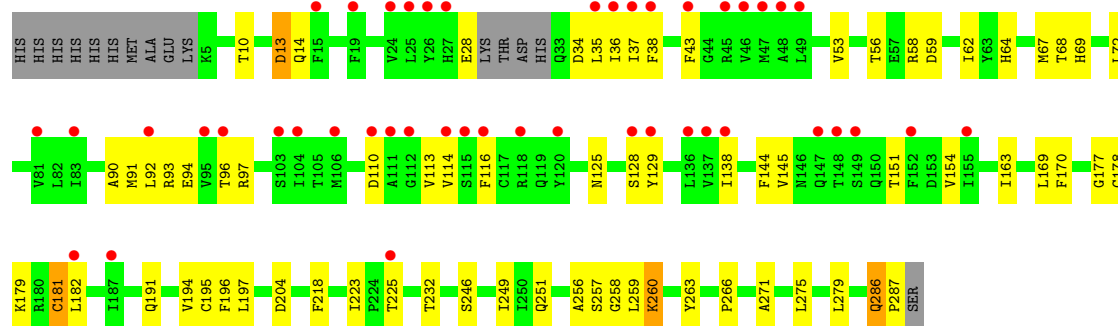

• Molecule 1: Spermidine synthase

Chain H: 10% 71% 19% 10%

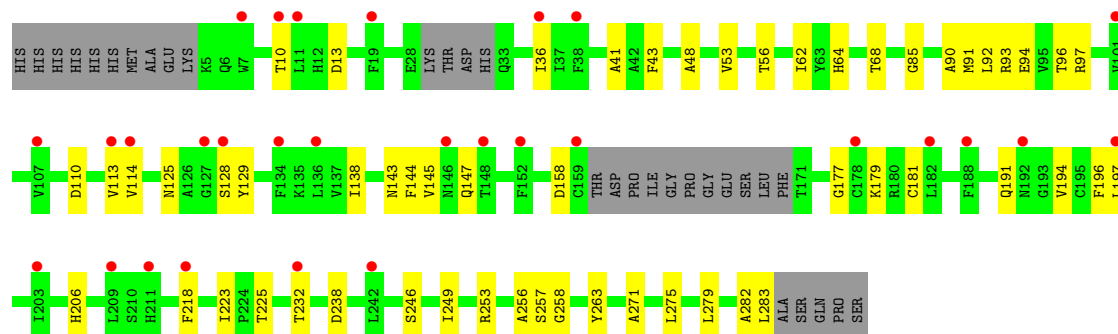

## 4 Data and refinement statistics

Property	Value	Source
Space group	P 43	Depositor
Cell constants a, b, c, $\alpha$ , $\beta$ , $\gamma$	123.11Å 123.11Å 210.01Å 90.00° 90.00° 90.00°	Depositor
Resolution (Å)	48.29 – 2.90 48.29 – 2.85	Depositor EDS
% Data completeness (in resolution range)	98.9 (48.29-2.90) 95.7 (48.29-2.85)	Depositor EDS
$R_{merge}$	0.09	Depositor
$R_{sym}$	(Not available)	Depositor
$\langle I/\sigma(I) \rangle$ <sup>1</sup>	1.29 (at 2.86Å)	Xtrriage
Refinement program	REFMAC 5.6.0070	Depositor
R, $R_{free}$	0.208 , 0.241 0.248 , 0.262	Depositor DCC
$R_{free}$ test set	3486 reflections (5.03%)	wwPDB-VP
Wilson B-factor (Å <sup>2</sup> )	62.7	Xtrriage
Anisotropy	0.053	Xtrriage
Bulk solvent $k_{sol}$ (e/Å <sup>3</sup> ), $B_{sol}$ (Å <sup>2</sup> )	0.33 , 89.4	EDS
L-test for twinning <sup>2</sup>	$\langle  L  \rangle = 0.46$ , $\langle L^2 \rangle = 0.29$	Xtrriage
Estimated twinning fraction	0.108 for h,-k,-l	Xtrriage
$F_o, F_c$ correlation	0.90	EDS
Total number of atoms	17519	wwPDB-VP
Average B, all atoms (Å <sup>2</sup> )	110.0	wwPDB-VP

Xtrriage's analysis on translational NCS is as follows: *The largest off-origin peak in the Patterson function is 2.64% of the height of the origin peak. No significant pseudotranslation is detected.*

<sup>1</sup>Intensities estimated from amplitudes.

<sup>2</sup>Theoretical values of  $\langle |L| \rangle$ ,  $\langle L^2 \rangle$  for acentric reflections are 0.5, 0.333 respectively for untwinned datasets, and 0.375, 0.2 for perfectly twinned datasets.

## 5 Model quality [i](#)

### 5.1 Standard geometry [i](#)

Bond lengths and bond angles in the following residue types are not validated in this section: SO4

The Z score for a bond length (or angle) is the number of standard deviations the observed value is removed from the expected value. A bond length (or angle) with  $|Z| > 5$  is considered an outlier worth inspection. RMSZ is the root-mean-square of all Z scores of the bond lengths (or angles).

Mol	Chain	Bond lengths		Bond angles	
		RMSZ	# $ Z  > 5$	RMSZ	# $ Z  > 5$
1	A	0.79	0/2269	0.80	2/3083 (0.1%)
1	B	0.89	0/2189	0.79	0/2971
1	C	0.89	0/2287	0.81	2/3111 (0.1%)
1	D	0.86	0/2231	0.81	6/3030 (0.2%)
1	E	0.79	0/2266	0.77	2/3084 (0.1%)
1	F	0.72	2/2168 (0.1%)	0.74	1/2943 (0.0%)
1	G	0.83	1/2246 (0.0%)	0.77	2/3052 (0.1%)
1	H	0.71	1/2139 (0.0%)	0.74	0/2903
All	All	0.81	4/17795 (0.0%)	0.78	15/24177 (0.1%)

All (4) bond length outliers are listed below:

Mol	Chain	Res	Type	Atoms	Z	Observed(Å)	Ideal(Å)
1	G	178	CYS	CB-SG	-5.56	1.72	1.81
1	F	176	GLU	CG-CD	-5.18	1.44	1.51
1	F	195	CYS	CB-SG	5.12	1.91	1.82
1	H	143	ASN	CG-ND2	5.11	1.45	1.32

The worst 5 of 15 bond angle outliers are listed below:

Mol	Chain	Res	Type	Atoms	Z	Observed(°)	Ideal(°)
1	C	169	LEU	CA-CB-CG	-5.91	101.72	115.30
1	D	262	ARG	NE-CZ-NH1	5.80	123.20	120.30
1	G	67	MET	CG-SD-CE	-5.62	91.21	100.20
1	A	260	LYS	N-CA-C	-5.39	96.43	111.00
1	F	283	LEU	CA-CB-CG	-5.34	103.02	115.30

There are no chirality outliers.

There are no planarity outliers.

## 5.2 Too-close contacts

In the following table, the Non-H and H(model) columns list the number of non-hydrogen atoms and hydrogen atoms in the chain respectively. The H(added) column lists the number of hydrogen atoms added and optimized by MolProbity. The Clashes column lists the number of clashes within the asymmetric unit, whereas Symm-Clashes lists symmetry-related clashes.

Mol	Chain	Non-H	H(model)	H(added)	Clashes	Symm-Clashes
1	A	2212	0	2078	63	0
1	B	2135	0	2012	74	0
1	C	2228	0	2084	61	0
1	D	2176	0	2039	55	0
1	E	2208	0	2060	104	0
1	F	2116	0	1985	40	0
1	G	2189	0	2060	66	0
1	H	2087	0	1962	48	0
2	A	20	0	0	5	0
2	B	10	0	0	0	0
2	C	30	0	0	5	0
2	D	20	0	0	0	0
2	E	20	0	0	4	0
2	F	20	0	0	0	0
2	G	25	0	0	0	0
2	H	10	0	0	0	0
3	A	2	0	0	0	0
3	B	1	0	0	0	0
3	C	3	0	0	0	0
3	D	1	0	0	0	0
3	E	3	0	0	0	0
3	F	1	0	0	0	0
3	G	1	0	0	0	0
3	H	1	0	0	0	0
All	All	17519	0	16280	496	0

The all-atom clashscore is defined as the number of clashes found per 1000 atoms (including hydrogen atoms). The all-atom clashscore for this structure is 15.

The worst 5 of 496 close contacts within the same asymmetric unit are listed below, sorted by their clash magnitude.

Atom-1	Atom-2	Interatomic distance (Å)	Clash overlap (Å)
1:G:258:GLY:O	1:G:259:LEU:HD12	1.38	1.20
1:E:145:VAL:HG23	1:E:177:GLY:CA	1.80	1.12
1:B:171:THR:HG22	1:B:173:ALA:H	1.11	1.10

*Continued on next page...*

Continued from previous page...

Atom-1	Atom-2	Interatomic distance (Å)	Clash overlap (Å)
1:G:258:GLY:C	1:G:259:LEU:HD12	1.78	1.04
1:E:145:VAL:HG23	1:E:177:GLY:HA2	1.39	1.01

There are no symmetry-related clashes.

## 5.3 Torsion angles [i](#)

### 5.3.1 Protein backbone [i](#)

In the following table, the Percentiles column shows the percent Ramachandran outliers of the chain as a percentile score with respect to all X-ray entries followed by that with respect to entries of similar resolution.

The Analysed column shows the number of residues for which the backbone conformation was analysed, and the total number of residues.

Mol	Chain	Analysed	Favoured	Allowed	Outliers	Percentiles	
1	A	278/294 (95%)	269 (97%)	9 (3%)	0	100	100
1	B	266/294 (90%)	255 (96%)	11 (4%)	0	100	100
1	C	282/294 (96%)	272 (96%)	10 (4%)	0	100	100
1	D	272/294 (92%)	263 (97%)	9 (3%)	0	100	100
1	E	281/294 (96%)	272 (97%)	8 (3%)	1 (0%)	34	66
1	F	263/294 (90%)	254 (97%)	9 (3%)	0	100	100
1	G	275/294 (94%)	264 (96%)	11 (4%)	0	100	100
1	H	258/294 (88%)	248 (96%)	10 (4%)	0	100	100
All	All	2175/2352 (92%)	2097 (96%)	77 (4%)	1 (0%)	100	100

All (1) Ramachandran outliers are listed below:

Mol	Chain	Res	Type
1	E	149	SER

### 5.3.2 Protein sidechains [i](#)

In the following table, the Percentiles column shows the percent sidechain outliers of the chain as a percentile score with respect to all X-ray entries followed by that with respect to entries of similar resolution.

The Analysed column shows the number of residues for which the sidechain conformation was analysed, and the total number of residues.

Mol	Chain	Analysed	Rotameric	Outliers	Percentiles	
1	A	230/247 (93%)	224 (97%)	6 (3%)	46	77
1	B	222/247 (90%)	215 (97%)	7 (3%)	39	73
1	C	232/247 (94%)	221 (95%)	11 (5%)	26	59
1	D	226/247 (92%)	215 (95%)	11 (5%)	25	57
1	E	229/247 (93%)	215 (94%)	14 (6%)	18	48
1	F	219/247 (89%)	212 (97%)	7 (3%)	39	73
1	G	228/247 (92%)	217 (95%)	11 (5%)	25	58
1	H	217/247 (88%)	212 (98%)	5 (2%)	50	80
All	All	1803/1976 (91%)	1731 (96%)	72 (4%)	31	65

5 of 72 residues with a non-rotameric sidechain are listed below:

Mol	Chain	Res	Type
1	G	116	PHE
1	H	194	VAL
1	G	144	PHE
1	G	260	LYS
1	D	13	ASP

Sometimes sidechains can be flipped to improve hydrogen bonding and reduce clashes. All (2) such sidechains are listed below:

Mol	Chain	Res	Type
1	D	191	GLN
1	E	147	GLN

### 5.3.3 RNA [i](#)

There are no RNA molecules in this entry.

## 5.4 Non-standard residues in protein, DNA, RNA chains [i](#)

There are no non-standard protein/DNA/RNA residues in this entry.



## 5.5 Carbohydrates [i](#)

There are no monosaccharides in this entry.

## 5.6 Ligand geometry [i](#)

31 ligands are modelled in this entry.

In the following table, the Counts columns list the number of bonds (or angles) for which Mogul statistics could be retrieved, the number of bonds (or angles) that are observed in the model and the number of bonds (or angles) that are defined in the Chemical Component Dictionary. The Link column lists molecule types, if any, to which the group is linked. The Z score for a bond length (or angle) is the number of standard deviations the observed value is removed from the expected value. A bond length (or angle) with  $|Z| > 2$  is considered an outlier worth inspection. RMSZ is the root-mean-square of all Z scores of the bond lengths (or angles).

Mol	Type	Chain	Res	Link	Bond lengths			Bond angles		
					Counts	RMSZ	$\# Z  > 2$	Counts	RMSZ	$\# Z  > 2$
2	SO4	A	289	-	4,4,4	0.58	0	6,6,6	0.30	0
2	SO4	D	291	-	4,4,4	0.16	0	6,6,6	0.21	0
2	SO4	A	292	-	4,4,4	0.13	0	6,6,6	0.05	0
2	SO4	E	292	-	4,4,4	0.28	0	6,6,6	0.35	0
2	SO4	G	290	-	4,4,4	0.41	0	6,6,6	0.33	0
2	SO4	E	291	-	4,4,4	0.42	0	6,6,6	0.28	0
2	SO4	D	289	-	4,4,4	0.48	0	6,6,6	0.13	0
2	SO4	F	290	-	4,4,4	0.43	0	6,6,6	0.20	0
2	SO4	E	290	-	4,4,4	0.98	0	6,6,6	0.77	0
2	SO4	A	291	-	4,4,4	0.36	0	6,6,6	0.55	0
2	SO4	D	290	-	4,4,4	0.71	0	6,6,6	0.55	0
2	SO4	C	290	-	4,4,4	0.40	0	6,6,6	0.39	0
2	SO4	A	290	-	4,4,4	0.42	0	6,6,6	0.23	0
2	SO4	B	289	-	4,4,4	0.60	0	6,6,6	0.31	0
2	SO4	G	292	-	4,4,4	0.16	0	6,6,6	0.12	0
2	SO4	F	291	-	4,4,4	0.32	0	6,6,6	0.20	0
2	SO4	C	292	-	4,4,4	0.28	0	6,6,6	0.33	0
2	SO4	C	289	-	4,4,4	0.59	0	6,6,6	0.29	0
2	SO4	C	291	-	4,4,4	0.30	0	6,6,6	0.75	0
2	SO4	C	294	-	4,4,4	0.14	0	6,6,6	0.66	0
2	SO4	H	290	-	4,4,4	0.22	0	6,6,6	0.16	0
2	SO4	G	289	-	4,4,4	0.61	0	6,6,6	0.49	0
2	SO4	G	293	-	4,4,4	0.33	0	6,6,6	0.16	0
2	SO4	D	292	-	4,4,4	0.31	0	6,6,6	0.29	0
2	SO4	B	290	-	4,4,4	0.49	0	6,6,6	0.26	0
2	SO4	H	289	-	4,4,4	0.51	0	6,6,6	0.28	0
2	SO4	F	292	-	4,4,4	0.33	0	6,6,6	0.65	0

Mol	Type	Chain	Res	Link	Bond lengths			Bond angles		
					Counts	RMSZ	# Z  > 2	Counts	RMSZ	# Z  > 2
2	SO4	F	289	-	4,4,4	0.44	0	6,6,6	0.26	0
2	SO4	E	289	-	4,4,4	0.57	0	6,6,6	0.27	0
2	SO4	G	291	-	4,4,4	0.39	0	6,6,6	0.26	0
2	SO4	C	293	-	4,4,4	0.32	0	6,6,6	0.39	0

There are no bond length outliers.

There are no bond angle outliers.

There are no chirality outliers.

There are no torsion outliers.

There are no ring outliers.

4 monomers are involved in 14 short contacts:

Mol	Chain	Res	Type	Clashes	Symm-Clashes
2	A	292	SO4	5	0
2	E	292	SO4	1	0
2	E	290	SO4	3	0
2	C	291	SO4	5	0

## 5.7 Other polymers [i](#)

There are no such residues in this entry.

## 5.8 Polymer linkage issues [i](#)

There are no chain breaks in this entry.

## 6 Fit of model and data [i](#)

### 6.1 Protein, DNA and RNA chains [i](#)

In the following table, the column labelled ‘#RSRZ > 2’ contains the number (and percentage) of RSRZ outliers, followed by percent RSRZ outliers for the chain as percentile scores relative to all X-ray entries and entries of similar resolution. The OWAB column contains the minimum, median, 95<sup>th</sup> percentile and maximum values of the occupancy-weighted average B-factor per residue. The column labelled ‘Q < 0.9’ lists the number of (and percentage) of residues with an average occupancy less than 0.9.

Mol	Chain	Analysed	<RSRZ>	#RSRZ>2	OWAB(Å <sup>2</sup> )	Q<0.9
1	A	282/294 (95%)	0.63	19 (6%) 17 13	42, 108, 189, 247	0
1	B	270/294 (91%)	0.28	6 (2%) 62 59	34, 85, 146, 177	0
1	C	284/294 (96%)	0.64	26 (9%) 9 6	36, 104, 186, 242	0
1	D	276/294 (93%)	0.28	3 (1%) 80 80	36, 85, 145, 197	0
1	E	283/294 (96%)	0.87	50 (17%) 1 1	44, 128, 218, 271	0
1	F	269/294 (91%)	0.67	22 (8%) 11 9	35, 107, 186, 241	0
1	G	279/294 (94%)	0.84	45 (16%) 1 1	42, 107, 200, 319	0
1	H	264/294 (89%)	0.81	29 (10%) 5 4	39, 121, 231, 276	0
All	All	2207/2352 (93%)	0.63	200 (9%) 9 6	34, 103, 198, 319	0

The worst 5 of 200 RSRZ outliers are listed below:

Mol	Chain	Res	Type	RSRZ
1	G	111	ALA	13.9
1	A	111	ALA	8.0
1	F	141	GLY	7.9
1	F	285	SER	6.4
1	E	92	LEU	5.8

### 6.2 Non-standard residues in protein, DNA, RNA chains [i](#)

There are no non-standard protein/DNA/RNA residues in this entry.

### 6.3 Carbohydrates [i](#)

There are no monosaccharides in this entry.

## 6.4 Ligands [i](#)

In the following table, the Atoms column lists the number of modelled atoms in the group and the number defined in the chemical component dictionary. The B-factors column lists the minimum, median, 95<sup>th</sup> percentile and maximum values of B factors of atoms in the group. The column labelled 'Q< 0.9' lists the number of atoms with occupancy less than 0.9.

Mol	Type	Chain	Res	Atoms	RSCC	RSR	B-factors(Å <sup>2</sup> )	Q<0.9
2	SO4	E	292	5/5	0.68	0.33	122,147,162,174	0
2	SO4	F	292	5/5	0.72	0.28	96,117,146,154	0
2	SO4	C	293	5/5	0.73	0.37	99,119,140,150	0
2	SO4	C	292	5/5	0.74	0.18	122,128,153,158	0
2	SO4	A	291	5/5	0.75	0.31	84,119,163,185	0
2	SO4	D	291	5/5	0.77	0.43	115,117,151,165	0
2	SO4	H	290	5/5	0.77	0.20	101,113,139,153	0
2	SO4	C	291	5/5	0.88	0.19	59,60,82,87	0
2	SO4	C	290	5/5	0.88	0.18	90,90,125,125	0
2	SO4	D	292	5/5	0.88	0.25	99,129,147,159	0
2	SO4	G	291	5/5	0.90	0.23	99,108,132,153	0
2	SO4	G	293	5/5	0.90	0.16	122,127,140,171	0
2	SO4	H	289	5/5	0.90	0.15	76,96,100,113	0
2	SO4	A	290	5/5	0.90	0.22	107,109,125,146	0
2	SO4	C	289	5/5	0.92	0.11	79,87,92,98	0
2	SO4	G	289	5/5	0.92	0.11	70,77,93,105	0
2	SO4	F	289	5/5	0.93	0.14	76,108,119,121	0
2	SO4	G	292	5/5	0.93	0.50	128,131,159,164	0
2	SO4	F	290	5/5	0.93	0.13	87,92,101,111	0
2	SO4	E	289	5/5	0.93	0.09	74,79,94,102	0
2	SO4	A	289	5/5	0.93	0.09	79,87,101,108	0
2	SO4	B	290	5/5	0.94	0.11	85,86,110,114	0
2	SO4	A	292	5/5	0.95	0.13	47,64,68,70	0
2	SO4	D	289	5/5	0.95	0.10	88,108,116,119	0
2	SO4	G	290	5/5	0.95	0.12	96,108,126,139	0
2	SO4	D	290	5/5	0.95	0.12	58,91,94,98	0
2	SO4	E	291	5/5	0.96	0.08	92,107,125,142	0
2	SO4	F	291	5/5	0.96	0.09	109,109,138,141	0
2	SO4	B	289	5/5	0.98	0.08	78,93,103,115	0
2	SO4	E	290	5/5	0.98	0.10	63,65,74,79	0
2	SO4	C	294	5/5	0.98	0.12	56,66,73,74	0

## 6.5 Other polymers [i](#)

There are no such residues in this entry.