



Full wwPDB X-ray Structure Validation Report ⓘ

Aug 22, 2023 – 01:26 pm BST

PDB ID : 8ODW
Title : Crystal structure of LbmA Ox-ACP didomain in complex with NADP and ethyl glycinate from the lobatamide PKS (*Gyneuella sunshinyii*)
Authors : Francois, R.M.M.; Fraley, A.E.; Piel, J.; Weissman, K.J.; Gruez, A.
Deposited on : 2023-03-09
Resolution : 3.07 Å (reported)

This is a Full wwPDB X-ray Structure Validation Report for a publicly released PDB entry.

We welcome your comments at validation@mail.wwpdb.org

A user guide is available at

<https://www.wwpdb.org/validation/2017/XrayValidationReportHelp>

with specific help available everywhere you see the ⓘ symbol.

The types of validation reports are described at

<http://www.wwpdb.org/validation/2017/FAQs#types>.

The following versions of software and data (see [references ⓘ](#)) were used in the production of this report:

MolProbity : 4.02b-467
Mogul : 1.8.4, CSD as541be (2020)
Xtriage (Phenix) : 1.13
EDS : 2.35
buster-report : 1.1.7 (2018)
Percentile statistics : 20191225.v01 (using entries in the PDB archive December 25th 2019)
Refmac : 5.8.0158
CCP4 : 7.0.044 (Gargrove)
Ideal geometry (proteins) : Engh & Huber (2001)
Ideal geometry (DNA, RNA) : Parkinson et al. (1996)
Validation Pipeline (wwPDB-VP) : 2.35

1 Overall quality at a glance

The following experimental techniques were used to determine the structure:

X-RAY DIFFRACTION

The reported resolution of this entry is 3.07 Å.

Percentile scores (ranging between 0-100) for global validation metrics of the entry are shown in the following graphic. The table shows the number of entries on which the scores are based.

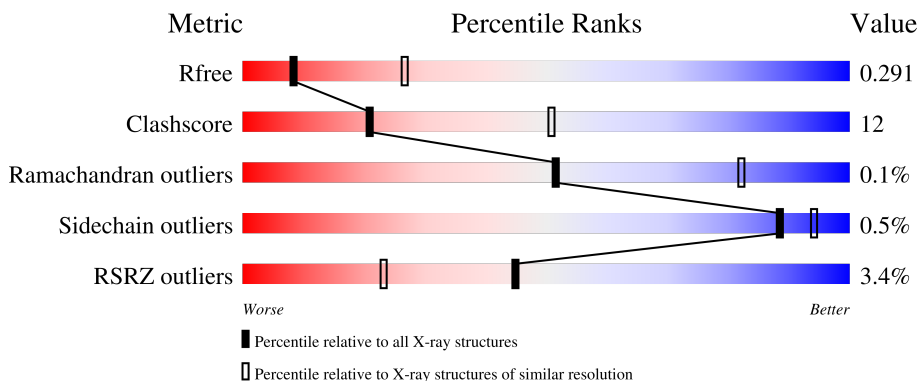

Metric	Whole archive (#Entries)	Similar resolution (#Entries, resolution range(Å))
R_{free}	130704	1447 (3.10-3.06)
Clashscore	141614	1546 (3.10-3.06)
Ramachandran outliers	138981	1487 (3.10-3.06)
Sidechain outliers	138945	1486 (3.10-3.06)
RSRZ outliers	127900	1416 (3.10-3.06)

The table below summarises the geometric issues observed across the polymeric chains and their fit to the electron density. The red, orange, yellow and green segments of the lower bar indicate the fraction of residues that contain outliers for ≥ 3 , 2, 1 and 0 types of geometric quality criteria respectively. A grey segment represents the fraction of residues that are not modelled. The numeric value for each fraction is indicated below the corresponding segment, with a dot representing fractions $\leq 5\%$. The upper red bar (where present) indicates the fraction of residues that have poor fit to the electron density. The numeric value is given above the bar.

Mol	Chain	Length	Quality of chain
1	A	639	
1	B	639	

The following table lists non-polymeric compounds, carbohydrate monomers and non-standard residues in protein, DNA, RNA chains that are outliers for geometric or electron-density-fit criteria:

Mol	Type	Chain	Res	Chirality	Geometry	Clashes	Electron density
5	GEE	A	704	-	-	-	X

2 Entry composition

There are 8 unique types of molecules in this entry. The entry contains 9771 atoms, of which 0 are hydrogens and 0 are deuteriums.

In the tables below, the ZeroOcc column contains the number of atoms modelled with zero occupancy, the AltConf column contains the number of residues with at least one atom in alternate conformation and the Trace column contains the number of residues modelled with at most 2 atoms.

- Molecule 1 is a protein called Polyketide synthase modules-related protein.

Mol	Chain	Residues	Atoms					ZeroOcc	AltConf	Trace
			Total	C	N	O	S			
1	A	612	4878	3098	841	917	22	89	0	0
1	B	569	4525	2877	778	848	22	176	0	0

There are 8 discrepancies between the modelled and reference sequences:

Chain	Residue	Modelled	Actual	Comment	Reference
A	1	GLY	-	expression tag	UNP A0A0C5VQJ2
A	2	PRO	-	expression tag	UNP A0A0C5VQJ2
A	3	GLY	-	expression tag	UNP A0A0C5VQJ2
A	4	SER	-	expression tag	UNP A0A0C5VQJ2
B	1	GLY	-	expression tag	UNP A0A0C5VQJ2
B	2	PRO	-	expression tag	UNP A0A0C5VQJ2
B	3	GLY	-	expression tag	UNP A0A0C5VQJ2
B	4	SER	-	expression tag	UNP A0A0C5VQJ2

- Molecule 2 is FLAVIN-ADENINE DINUCLEOTIDE (three-letter code: FAD) (formula: $C_{27}H_{33}N_9O_{15}P_2$) (labeled as "Ligand of Interest" by depositor).



Mol	Chain	Residues	Atoms				ZeroOcc	AltConf	
			Total	C	N	O			P
2	A	1	53	27	9	15	2	0	0
2	B	1	53	27	9	15	2	0	0

- Molecule 3 is NADP NICOTINAMIDE-ADENINE-DINUCLEOTIDE PHOSPHATE (three-letter code: NAP) (formula: C₂₁H₂₈N₇O₁₇P₃) (labeled as "Ligand of Interest" by depositor).

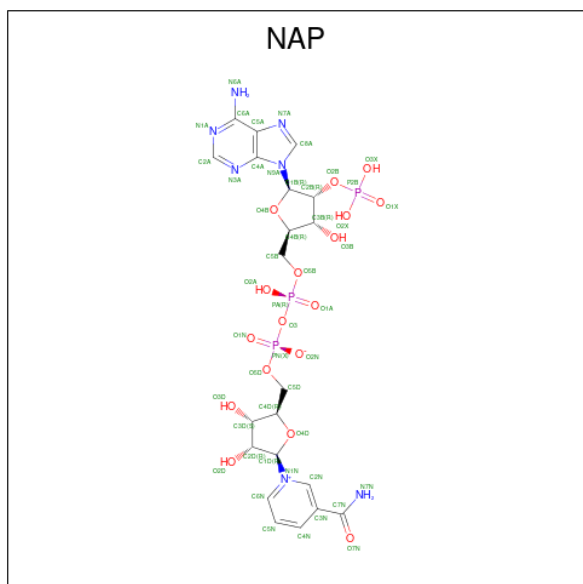

Mol	Chain	Residues	Atoms				ZeroOcc	AltConf	
			Total	C	N	O			P
3	A	1	48	21	7	17	3	2	0

Continued on next page...

Continued from previous page...

Mol	Chain	Residues	Atoms					ZeroOcc	AltConf
			Total	C	N	O	P		
3	B	1	48	21	7	17	3	0	0

- Molecule 4 is OXYGEN MOLECULE (three-letter code: OXY) (formula: O₂) (labeled as "Ligand of Interest" by depositor).

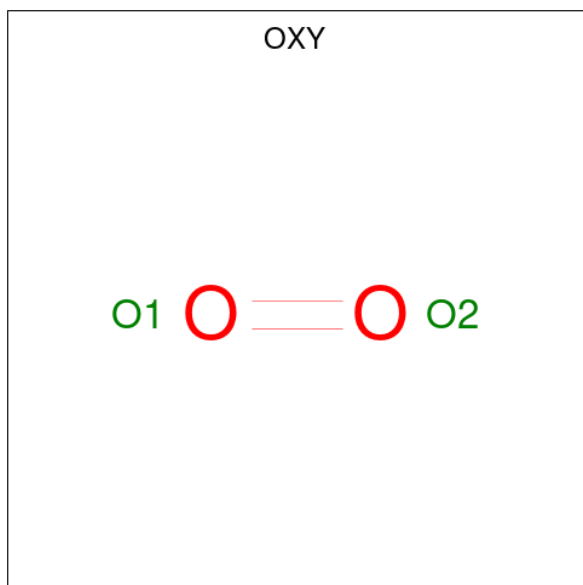

Mol	Chain	Residues	Atoms		ZeroOcc	AltConf
4	A	1	Total	O	0	0
			2	2		

- Molecule 5 is ethyl glycinate (three-letter code: GEE) (formula: C₄H₉NO₂) (labeled as "Ligand of Interest" by depositor).

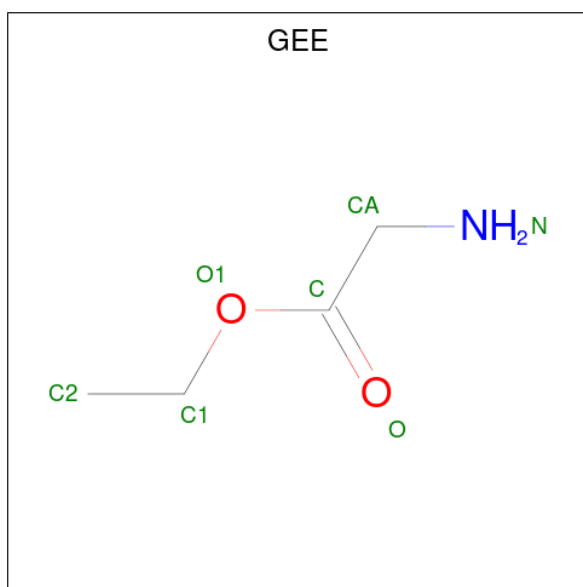

Mol	Chain	Residues	Atoms				ZeroOcc	AltConf
			Total	C	N	O		
5	A	1	7	4	1	2	0	0

- Molecule 6 is GLYCEROL (three-letter code: GOL) (formula: C₃H₈O₃).



Mol	Chain	Residues	Atoms			ZeroOcc	AltConf
			Total	C	O		
6	A	1	6	3	3	0	0

- Molecule 7 is PHOSPHATE ION (three-letter code: PO4) (formula: O₄P).



Mol	Chain	Residues	Atoms	ZeroOcc	AltConf
7	A	1	Total O P 5 4 1	0	0
7	A	1	Total O P 5 4 1	0	0
7	A	1	Total O P 5 4 1	0	0
7	A	1	Total O P 5 4 1	0	0

- Molecule 8 is water.

Mol	Chain	Residues	Atoms	ZeroOcc	AltConf
8	A	121	Total O 121 121	0	0
8	B	10	Total O 10 10	0	0

3 Residue-property plots

These plots are drawn for all protein, RNA, DNA and oligosaccharide chains in the entry. The first graphic for a chain summarises the proportions of the various outlier classes displayed in the second graphic. The second graphic shows the sequence view annotated by issues in geometry and electron density. Residues are color-coded according to the number of geometric quality criteria for which they contain at least one outlier: green = 0, yellow = 1, orange = 2 and red = 3 or more. A red dot above a residue indicates a poor fit to the electron density ($RSRZ > 2$). Stretches of 2 or more consecutive residues without any outlier are shown as a green connector. Residues present in the sample, but not in the model, are shown in grey.

- Molecule 1: Polyketide synthase modules-related protein

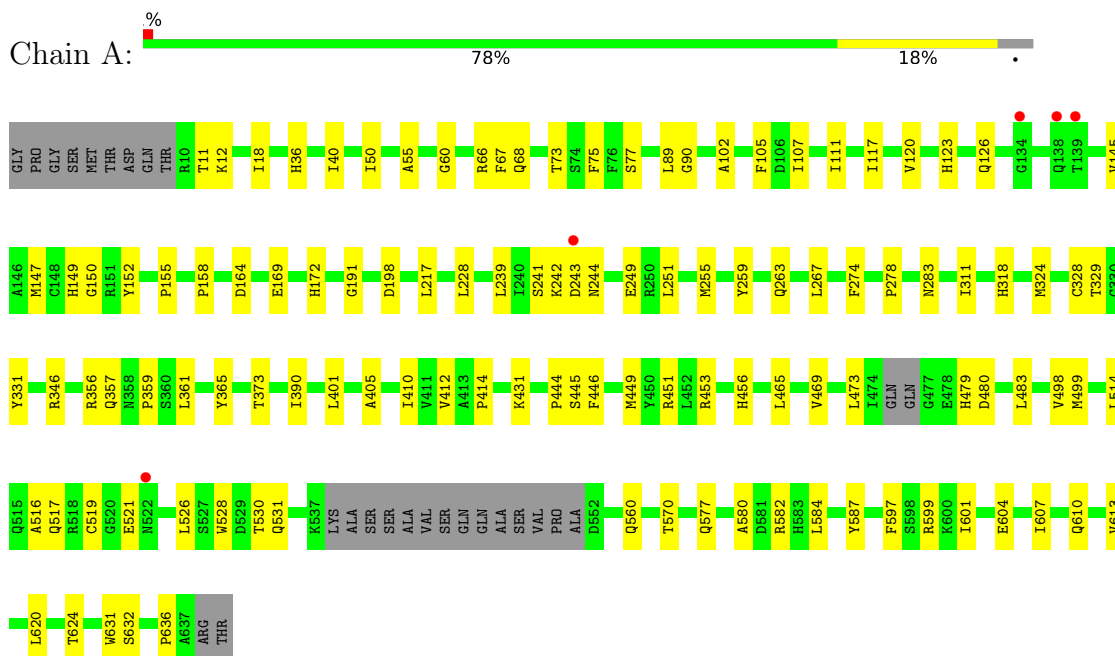

- Molecule 1: Polyketide synthase modules-related protein

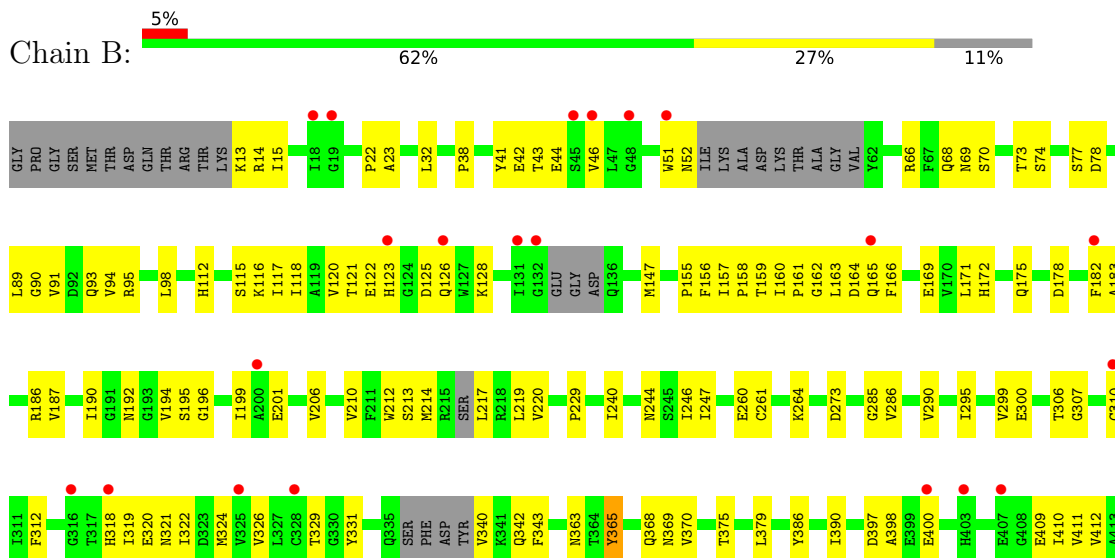

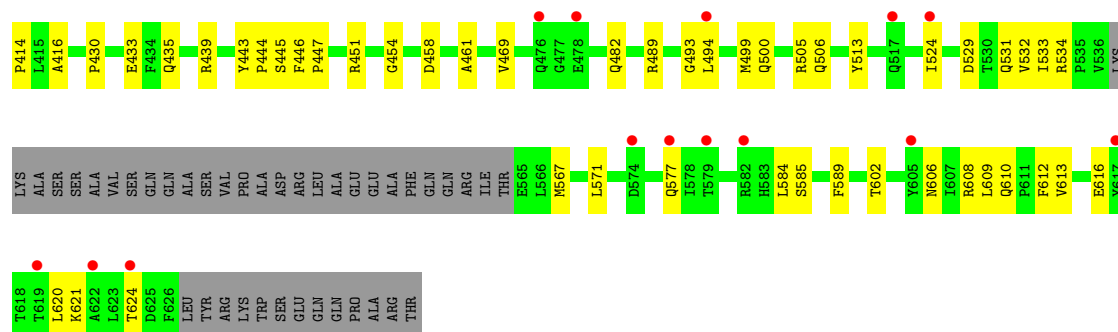

4 Data and refinement statistics

Property	Value	Source
Space group	P 65 2 2	Depositor
Cell constants a, b, c, α , β , γ	206.75Å 206.75Å 178.40Å 90.00° 90.00° 120.00°	Depositor
Resolution (Å)	44.76 – 3.07 44.76 – 3.07	Depositor EDS
% Data completeness (in resolution range)	99.5 (44.76-3.07) 99.5 (44.76-3.07)	Depositor EDS
R_{merge}	0.15	Depositor
R_{sym}	(Not available)	Depositor
$\langle I/\sigma(I) \rangle$ ¹	2.19 (at 3.06Å)	Xtrriage
Refinement program	PHENIX 1.20.1	Depositor
R, R_{free}	0.237 , 0.293 0.236 , 0.291	Depositor DCC
R_{free} test set	2010 reflections (4.74%)	wwPDB-VP
Wilson B-factor (Å ²)	58.8	Xtrriage
Anisotropy	0.268	Xtrriage
Bulk solvent k_{sol} (e/Å ³), B_{sol} (Å ²)	0.25 , 103.3	EDS
L-test for twinning ²	$\langle L \rangle = 0.49$, $\langle L^2 \rangle = 0.32$	Xtrriage
Estimated twinning fraction	No twinning to report.	Xtrriage
F_o, F_c correlation	0.85	EDS
Total number of atoms	9771	wwPDB-VP
Average B, all atoms (Å ²)	50.0	wwPDB-VP

Xtrriage's analysis on translational NCS is as follows: *The largest off-origin peak in the Patterson function is 3.22% of the height of the origin peak. No significant pseudotranslation is detected.*

¹Intensities estimated from amplitudes.

²Theoretical values of $\langle |L| \rangle$, $\langle L^2 \rangle$ for acentric reflections are 0.5, 0.333 respectively for untwinned datasets, and 0.375, 0.2 for perfectly twinned datasets.

5 Model quality [i](#)

5.1 Standard geometry [i](#)

Bond lengths and bond angles in the following residue types are not validated in this section: GOL, PO4, OXY, FAD, NAP, GEE

The Z score for a bond length (or angle) is the number of standard deviations the observed value is removed from the expected value. A bond length (or angle) with $|Z| > 5$ is considered an outlier worth inspection. RMSZ is the root-mean-square of all Z scores of the bond lengths (or angles).

Mol	Chain	Bond lengths		Bond angles	
		RMSZ	# Z >5	RMSZ	# Z >5
1	A	0.53	0/4989	0.73	0/6758
1	B	0.39	0/4626	0.65	0/6266
All	All	0.46	0/9615	0.69	0/13024

There are no bond length outliers.

There are no bond angle outliers.

There are no chirality outliers.

There are no planarity outliers.

5.2 Too-close contacts [i](#)

In the following table, the Non-H and H(model) columns list the number of non-hydrogen atoms and hydrogen atoms in the chain respectively. The H(added) column lists the number of hydrogen atoms added and optimized by MolProbity. The Clashes column lists the number of clashes within the asymmetric unit, whereas Symm-Clashes lists symmetry-related clashes.

Mol	Chain	Non-H	H(model)	H(added)	Clashes	Symm-Clashes
1	A	4878	0	4755	86	0
1	B	4525	0	4406	136	0
2	A	53	0	31	3	0
2	B	53	0	31	4	0
3	A	48	0	25	2	0
3	B	48	0	25	4	0
4	A	2	0	0	0	0
5	A	7	0	9	1	0
6	A	6	0	8	1	0
7	A	20	0	0	0	0
8	A	121	0	0	6	0

Continued on next page...

Continued from previous page...

Mol	Chain	Non-H	H(model)	H(added)	Clashes	Symm-Clashes
8	B	10	0	0	1	0
All	All	9771	0	9290	223	0

The all-atom clashscore is defined as the number of clashes found per 1000 atoms (including hydrogen atoms). The all-atom clashscore for this structure is 12.

All (223) close contacts within the same asymmetric unit are listed below, sorted by their clash magnitude.

Atom-1	Atom-2	Interatomic distance (Å)	Clash overlap (Å)
1:A:73:THR:HG22	1:A:445:SER:O	1.58	1.04
1:B:43:THR:HG22	1:B:116:LYS:HG2	1.46	0.95
1:A:50:ILE:CD1	1:A:60:GLY:HA2	1.99	0.92
1:B:195:SER:O	1:B:199:ILE:HG12	1.73	0.89
1:B:411:VAL:HG12	1:B:532:VAL:HG12	1.58	0.85
1:B:397:ASP:HB3	1:B:400:GLU:HG3	1.63	0.80
1:B:370:VAL:HG21	1:B:375:THR:HG22	1.64	0.79
1:B:187:VAL:HG12	1:B:324:MET:HB2	1.65	0.76
1:B:329:THR:HA	3:B:702:NAP:H8A	1.67	0.76
1:B:368:GLN:HG2	1:B:409:GLU:HG3	1.68	0.74
1:A:373:THR:HG21	1:A:445:SER:HB3	1.69	0.74
1:B:439:ARG:NH1	8:B:801:HOH:O	2.21	0.73
1:A:516:ALA:HA	1:A:519:CYS:SG	2.29	0.72
1:A:577:GLN:OE1	1:A:582:ARG:NH2	2.24	0.71
1:A:498:VAL:HG23	8:A:825:HOH:O	1.91	0.71
1:A:610:GLN:HG3	1:A:613:VAL:HG23	1.72	0.70
1:A:50:ILE:HD12	1:A:60:GLY:HA2	1.71	0.70
1:A:105:PHE:HB2	1:A:107:ILE:HD11	1.74	0.69
1:B:529:ASP:OD2	1:B:534:ARG:NH1	2.17	0.69
1:A:66:ARG:HD2	5:A:704:GEE:H1A	1.74	0.68
1:B:73:THR:HG22	1:B:445:SER:O	1.94	0.68
1:B:584:LEU:HD12	1:B:585:SER:HB2	1.77	0.67
1:A:50:ILE:HD11	1:A:60:GLY:N	2.09	0.67
1:A:73:THR:CG2	1:A:445:SER:O	2.38	0.66
1:B:120:VAL:HG22	1:B:340:VAL:HG12	1.77	0.66
1:A:50:ILE:CD1	1:A:60:GLY:CA	2.75	0.65
1:A:239:LEU:C	1:A:241:SER:H	1.98	0.65
1:B:397:ASP:OD1	1:B:398:ALA:N	2.30	0.64
1:B:23:ALA:HB2	1:B:379:LEU:HD13	1.80	0.64
1:B:51:TRP:O	1:B:95:ARG:NH1	2.30	0.64
1:B:158:PRO:HD3	1:B:329:THR:HG21	1.79	0.64
1:B:155:PRO:HA	1:B:331:TYR:HA	1.79	0.63

Continued on next page...

Continued from previous page...

Atom-1	Atom-2	Interatomic distance (Å)	Clash overlap (Å)
1:B:166:PHE:HZ	1:B:322:ILE:HB	1.65	0.62
1:B:201:GLU:HB2	1:B:286:VAL:HG13	1.82	0.62
1:B:318:HIS:CE1	1:B:320:GLU:HB2	2.34	0.62
1:A:239:LEU:C	1:A:241:SER:N	2.50	0.62
1:B:584:LEU:HD12	1:B:584:LEU:C	2.21	0.61
1:B:319:ILE:HB	1:B:322:ILE:HD11	1.83	0.61
1:A:50:ILE:HD11	1:A:60:GLY:H	1.64	0.61
1:B:310:CYS:O	1:B:318:HIS:HA	1.99	0.61
1:B:410:ILE:HG13	1:B:533:ILE:HB	1.83	0.60
1:B:340:VAL:HB	1:B:343:PHE:HD2	1.66	0.59
1:B:183:ALA:HA	1:B:206:VAL:HG12	1.83	0.59
1:B:329:THR:CA	3:B:702:NAP:H8A	2.32	0.59
1:A:50:ILE:HD11	1:A:60:GLY:CA	2.31	0.59
1:A:599:ARG:NH1	8:A:801:HOH:O	2.30	0.59
1:A:55:ALA:HA	6:A:705:GOL:H31	1.85	0.58
1:A:36:HIS:CE1	1:A:390:ILE:HG22	2.39	0.58
1:B:489:ARG:NH2	1:B:524:ILE:HD11	2.19	0.57
1:B:493:GLY:HA3	1:B:524:ILE:O	2.04	0.57
1:A:449:MET:HA	1:A:465:LEU:HD22	1.87	0.57
1:A:412:VAL:HG12	1:A:414:PRO:HD2	1.87	0.57
1:B:430:PRO:HB2	1:B:494:LEU:HD21	1.87	0.56
1:A:50:ILE:HD11	1:A:60:GLY:HA2	1.84	0.56
1:A:251:LEU:HD12	1:A:255:MET:HG3	1.87	0.56
1:A:521:GLU:O	1:A:521:GLU:HG3	2.05	0.56
1:A:479:HIS:O	1:A:480:ASP:C	2.43	0.56
1:B:121:THR:HG21	1:B:128:LYS:HB2	1.88	0.56
1:B:182:PHE:CD1	1:B:187:VAL:HG11	2.41	0.56
1:A:66:ARG:HA	1:A:90:GLY:HA2	1.88	0.55
1:B:318:HIS:HE1	1:B:320:GLU:HB2	1.71	0.55
1:A:356:ARG:HG2	1:A:401:LEU:HD23	1.89	0.55
1:B:329:THR:HG22	3:B:702:NAP:C8A	2.37	0.55
1:A:11:THR:O	1:A:12:LYS:C	2.43	0.54
1:B:620:LEU:O	1:B:624:THR:HG23	2.08	0.54
1:B:78:ASP:OD1	1:B:78:ASP:N	2.41	0.54
1:A:191:GLY:HA3	1:A:328:CYS:O	2.07	0.54
1:B:68:GLN:OE1	1:B:194:VAL:HG21	2.08	0.54
1:B:156:PHE:HD2	1:B:329:THR:HB	1.74	0.53
1:A:68:GLN:OE1	3:A:702:NAP:H2N	2.08	0.53
1:B:147:MET:HB2	1:B:363:ASN:HA	1.88	0.53
1:A:259:TYR:O	1:A:263:GLN:HG3	2.09	0.53
1:A:244:ASN:HB2	1:A:274:PHE:CZ	2.44	0.53

Continued on next page...

Continued from previous page...

Atom-1	Atom-2	Interatomic distance (Å)	Clash overlap (Å)
1:B:89:LEU:HD23	1:B:93:GLN:HB3	1.91	0.53
1:B:435:GLN:O	1:B:439:ARG:HD3	2.09	0.53
1:A:123:HIS:O	1:A:126:GLN:N	2.42	0.52
1:B:41:TYR:HB3	1:B:115:SER:OG	2.09	0.52
1:A:18:ILE:HG13	1:A:117:ILE:HG13	1.91	0.52
1:A:570:THR:HG21	1:A:597:PHE:HA	1.90	0.52
1:A:242:LYS:O	1:A:243:ASP:C	2.47	0.52
1:B:369:ASN:HB3	1:B:410:ILE:HG22	1.91	0.52
1:B:13:LYS:HE2	1:B:390:ILE:HG23	1.92	0.52
1:B:171:LEU:HB2	1:B:326:VAL:HG22	1.92	0.52
1:B:260:GLU:HG3	1:B:261:CYS:N	2.24	0.52
1:A:77:SER:HB2	1:A:451:ARG:HE	1.74	0.52
1:B:95:ARG:HA	1:B:98:LEU:HD12	1.92	0.51
1:A:519:CYS:SG	1:A:519:CYS:O	2.68	0.51
1:B:386:TYR:OH	1:B:390:ILE:HD11	2.11	0.51
1:B:375:THR:HG21	3:B:702:NAP:H4N	1.92	0.50
1:B:46:VAL:HB	1:B:52:ASN:ND2	2.25	0.50
1:B:567:MET:O	1:B:571:LEU:HG	2.11	0.50
1:A:359:PRO:C	1:A:361:LEU:N	2.60	0.50
1:A:451:ARG:NH1	1:A:456:HIS:O	2.44	0.50
1:B:43:THR:CG2	1:B:116:LYS:HG2	2.30	0.50
1:A:150:GLY:HA3	2:A:701:FAD:O2A	2.12	0.50
1:B:162:GLY:O	1:B:165:GLN:HB2	2.12	0.50
1:B:443:TYR:CE1	1:B:469:VAL:HG13	2.47	0.50
1:A:164:ASP:OD1	1:A:164:ASP:N	2.37	0.50
1:B:94:VAL:HG12	1:B:98:LEU:HD11	1.93	0.49
1:B:416:ALA:HB2	1:B:531:GLN:HG3	1.95	0.49
1:A:241:SER:O	1:A:242:LYS:C	2.51	0.49
1:B:444:PRO:HD2	1:B:446:PHE:CE2	2.47	0.49
1:B:122:GLU:HG3	1:B:342:GLN:HE21	1.77	0.49
1:A:40:ILE:HD12	1:A:111:ILE:HG12	1.95	0.49
1:A:191:GLY:HA2	3:A:702:NAP:H1B	1.95	0.48
1:B:159:THR:O	1:B:161:PRO:HD3	2.12	0.48
1:A:147:MET:HE2	1:A:149:HIS:HE1	1.78	0.48
1:B:121:THR:CG2	1:B:128:LYS:HB2	2.42	0.48
1:B:121:THR:O	1:B:122:GLU:C	2.50	0.48
1:B:219:LEU:HD23	1:B:220:VAL:N	2.28	0.48
1:B:212:TRP:CD1	1:B:214:MET:HG3	2.49	0.48
1:B:412:VAL:HG12	1:B:414:PRO:HD2	1.95	0.48
1:B:609:LEU:HB3	1:B:613:VAL:HG21	1.95	0.48
1:B:214:MET:O	1:B:300:GLU:N	2.47	0.48

Continued on next page...

Continued from previous page...

Atom-1	Atom-2	Interatomic distance (Å)	Clash overlap (Å)
1:A:431:LYS:HG2	1:A:498:VAL:HG11	1.95	0.48
1:B:32:LEU:HG	1:B:38:PRO:HG3	1.96	0.48
1:B:621:LYS:O	1:B:624:THR:OG1	2.18	0.48
1:B:505:ARG:C	1:B:506:GLN:OE1	2.52	0.48
1:B:42:GLU:HG3	1:B:44:GLU:O	2.14	0.47
1:B:73:THR:HA	1:B:447:PRO:HD3	1.96	0.47
1:A:278:PRO:HG2	1:A:410:ILE:HD12	1.97	0.47
1:A:357:GLN:HE22	1:B:454:GLY:H	1.61	0.47
1:A:580:ALA:HA	1:A:620:LEU:HD23	1.96	0.47
1:A:514:LEU:O	1:A:517:GLN:HB2	2.14	0.47
1:B:500:GLN:NE2	1:B:513:TYR:OH	2.46	0.47
1:A:50:ILE:CG1	1:A:60:GLY:HA2	2.44	0.47
1:B:169:GLU:HB3	1:B:324:MET:HG2	1.97	0.47
1:B:214:MET:HE3	1:B:299:VAL:HG22	1.95	0.47
1:A:499:MET:HE1	8:A:904:HOH:O	2.13	0.47
1:B:43:THR:HG23	2:B:701:FAD:N3A	2.30	0.47
1:B:43:THR:HG23	2:B:701:FAD:C2A	2.45	0.47
1:A:102:ALA:HA	1:A:107:ILE:HD13	1.97	0.47
1:B:163:LEU:HB3	1:B:164:ASP:H	1.53	0.47
1:B:217:LEU:HB2	1:B:273:ASP:OD2	2.14	0.47
1:A:584:LEU:HA	1:A:587:TYR:CD2	2.50	0.47
1:B:91:VAL:HG12	1:B:95:ARG:HH12	1.81	0.46
1:B:196:GLY:C	1:B:212:TRP:HH2	2.18	0.46
1:B:386:TYR:CZ	1:B:390:ILE:HD11	2.51	0.46
1:B:244:ASN:O	1:B:247:ILE:HD12	2.16	0.46
1:B:260:GLU:O	1:B:264:LYS:HG3	2.15	0.46
1:A:158:PRO:HG3	1:A:329:THR:HG21	1.98	0.46
1:B:66:ARG:HA	1:B:90:GLY:HA2	1.97	0.45
1:A:123:HIS:O	1:A:126:GLN:O	2.34	0.45
1:A:584:LEU:HA	1:A:587:TYR:HD2	1.80	0.45
1:B:22:PRO:HG3	1:B:98:LEU:HD21	1.98	0.45
2:A:701:FAD:H1'1	2:A:701:FAD:H9	1.68	0.45
2:A:701:FAD:N1	2:A:701:FAD:O2'	2.46	0.45
1:A:483:LEU:HD23	1:A:483:LEU:HA	1.79	0.45
1:A:607:ILE:HD11	1:A:631:TRP:HB2	1.99	0.45
1:B:214:MET:CE	1:B:299:VAL:HG22	2.47	0.45
1:B:299:VAL:O	1:B:300:GLU:HG3	2.17	0.45
1:B:300:GLU:OE1	1:B:312:PHE:HB3	2.17	0.45
1:B:306:THR:HG22	1:B:307:GLY:N	2.32	0.45
1:A:105:PHE:HB2	1:A:107:ILE:CD1	2.45	0.45
1:B:122:GLU:HG3	1:B:342:GLN:HG3	1.99	0.45

Continued on next page...

Continued from previous page...

Atom-1	Atom-2	Interatomic distance (Å)	Clash overlap (Å)
1:B:156:PHE:C	1:B:157:ILE:HD12	2.36	0.45
1:B:172:HIS:O	1:B:175:GLN:HG2	2.16	0.45
1:A:526:LEU:HD22	1:A:530:THR:HG21	2.00	0.44
1:B:340:VAL:HB	1:B:343:PHE:CD2	2.49	0.44
1:B:621:LYS:HA	1:B:624:THR:HG23	1.99	0.44
1:B:171:LEU:HD22	1:B:175:GLN:NE2	2.32	0.44
1:A:453:ARG:HD3	8:A:889:HOH:O	2.16	0.44
1:B:240:ILE:HD12	1:B:246:ILE:HD13	1.99	0.44
1:B:571:LEU:HD13	1:B:577:GLN:HA	1.99	0.44
1:B:187:VAL:HG23	1:B:210:VAL:HG22	2.00	0.44
1:B:212:TRP:NE1	1:B:214:MET:SD	2.90	0.44
1:B:171:LEU:HD22	1:B:175:GLN:HE21	1.81	0.43
1:B:584:LEU:HD12	1:B:585:SER:CB	2.46	0.43
1:A:444:PRO:HD2	1:A:446:PHE:CE2	2.52	0.43
1:B:89:LEU:HB3	1:B:93:GLN:HB3	2.00	0.43
1:B:602:THR:HG22	1:B:608:ARG:HA	2.00	0.43
1:B:365:TYR:HD1	1:B:365:TYR:O	2.00	0.43
1:A:604:GLU:HB3	8:A:804:HOH:O	2.17	0.43
1:B:160:ILE:O	1:B:163:LEU:HG	2.19	0.43
1:B:192:ASN:OD1	1:B:214:MET:HG2	2.17	0.43
1:B:201:GLU:OE2	1:B:285:GLY:HA3	2.18	0.43
1:A:169:GLU:HB2	1:A:324:MET:HG2	2.01	0.43
1:B:201:GLU:HB2	1:B:286:VAL:CG1	2.47	0.43
1:A:228:LEU:HD23	1:A:228:LEU:HA	1.72	0.43
1:B:14:ARG:O	1:B:15:ILE:HD13	2.19	0.43
1:B:212:TRP:HE1	1:B:214:MET:CG	2.32	0.43
1:A:597:PHE:O	1:A:601:ILE:HG13	2.19	0.43
1:B:212:TRP:NE1	1:B:214:MET:CG	2.82	0.43
1:B:190:ILE:HG12	1:B:213:SER:OG	2.18	0.43
1:A:75:PHE:CZ	1:A:89:LEU:HD22	2.54	0.42
1:B:91:VAL:HG12	1:B:95:ARG:NH1	2.34	0.42
1:B:186:ARG:HD3	1:B:321:ASN:HD22	1.83	0.42
1:B:196:GLY:C	1:B:212:TRP:CH2	2.93	0.42
1:A:12:LYS:HE3	8:A:839:HOH:O	2.19	0.42
1:A:632:SER:HA	1:A:636:PRO:HG3	2.01	0.42
1:B:123:HIS:ND1	1:B:126:GLN:O	2.52	0.42
1:B:290:VAL:HG22	1:B:295:ILE:HB	2.02	0.42
1:A:267:LEU:HD23	1:A:267:LEU:HA	1.82	0.42
1:A:311:ILE:HG12	1:A:318:HIS:HD2	1.84	0.42
1:B:458:ASP:HB3	1:B:461:ALA:HB2	2.02	0.42
1:B:602:THR:O	1:B:606:ASN:HA	2.20	0.42

Continued on next page...

Continued from previous page...

Atom-1	Atom-2	Interatomic distance (Å)	Clash overlap (Å)
1:A:560:GLN:HG3	1:A:624:THR:HG21	2.00	0.42
1:B:117:ILE:HB	2:B:701:FAD:H62A	1.84	0.42
1:A:249:GLU:OE2	1:A:479:HIS:HE1	2.03	0.42
1:B:123:HIS:C	1:B:125:ASP:N	2.73	0.42
1:B:612:PHE:O	1:B:616:GLU:HG2	2.19	0.42
1:A:40:ILE:HB	1:A:111:ILE:HA	2.02	0.41
1:A:198:ASP:OD1	1:A:283:ASN:ND2	2.53	0.41
1:A:217:LEU:HD13	1:A:267:LEU:HA	2.02	0.41
1:A:120:VAL:HG11	1:A:145:VAL:HG21	2.02	0.41
1:B:41:TYR:HD1	1:B:112:HIS:HB2	1.86	0.41
1:B:69:ASN:HB2	1:B:74:SER:OG	2.20	0.41
1:B:89:LEU:HB3	1:B:93:GLN:CB	2.50	0.41
1:B:77:SER:HB2	1:B:451:ARG:HE	1.85	0.41
1:A:50:ILE:CD1	1:A:60:GLY:N	2.81	0.41
1:A:155:PRO:HB3	1:A:172:HIS:CE1	2.55	0.41
1:A:469:VAL:O	1:A:473:LEU:HG	2.20	0.41
1:B:482:GLN:H	1:B:482:GLN:HG3	1.74	0.41
1:B:433:GLU:H	1:B:433:GLU:HG2	1.62	0.41
1:A:528:TRP:O	1:A:531:GLN:HG2	2.21	0.41
1:B:73:THR:CG2	1:B:445:SER:O	2.66	0.41
1:B:196:GLY:O	1:B:212:TRP:HZ3	2.04	0.41
1:B:499:MET:HB3	1:B:513:TYR:CE1	2.56	0.40
1:A:346:ARG:HD2	1:A:405:ALA:O	2.22	0.40
1:B:70:SER:HB2	1:B:229:PRO:HB3	2.04	0.40
1:B:610:GLN:HB2	1:B:613:VAL:HG13	2.02	0.40
1:A:152:TYR:HA	1:A:331:TYR:CG	2.56	0.40
1:B:68:GLN:N	2:B:701:FAD:O4	2.51	0.40

There are no symmetry-related clashes.

5.3 Torsion angles [i](#)

5.3.1 Protein backbone [i](#)

In the following table, the Percentiles column shows the percent Ramachandran outliers of the chain as a percentile score with respect to all X-ray entries followed by that with respect to entries of similar resolution.

The Analysed column shows the number of residues for which the backbone conformation was analysed, and the total number of residues.

Mol	Chain	Analysed	Favoured	Allowed	Outliers	Percentiles	
1	A	606/639 (95%)	582 (96%)	24 (4%)	0	100	100
1	B	557/639 (87%)	523 (94%)	33 (6%)	1 (0%)	47	77
All	All	1163/1278 (91%)	1105 (95%)	57 (5%)	1 (0%)	51	82

All (1) Ramachandran outliers are listed below:

Mol	Chain	Res	Type
1	B	178	ASP

5.3.2 Protein sidechains [i](#)

In the following table, the Percentiles column shows the percent sidechain outliers of the chain as a percentile score with respect to all X-ray entries followed by that with respect to entries of similar resolution.

The Analysed column shows the number of residues for which the sidechain conformation was analysed, and the total number of residues.

Mol	Chain	Analysed	Rotameric	Outliers	Percentiles	
1	A	524/545 (96%)	522 (100%)	2 (0%)	91	95
1	B	488/545 (90%)	485 (99%)	3 (1%)	86	93
All	All	1012/1090 (93%)	1007 (100%)	5 (0%)	88	94

All (5) residues with a non-rotameric sidechain are listed below:

Mol	Chain	Res	Type
1	A	67	PHE
1	A	365	TYR
1	B	118	ILE
1	B	365	TYR
1	B	589	PHE

Sometimes sidechains can be flipped to improve hydrogen bonding and reduce clashes. All (11) such sidechains are listed below:

Mol	Chain	Res	Type
1	A	237	ASN
1	A	357	GLN
1	A	479	HIS
1	A	484	GLN
1	A	560	GLN

Continued on next page...

Continued from previous page...

Mol	Chain	Res	Type
1	B	149	HIS
1	B	175	GLN
1	B	263	GLN
1	B	318	HIS
1	B	321	ASN
1	B	482	GLN

5.3.3 RNA [i](#)

There are no RNA molecules in this entry.

5.4 Non-standard residues in protein, DNA, RNA chains [i](#)

There are no non-standard protein/DNA/RNA residues in this entry.

5.5 Carbohydrates [i](#)

There are no monosaccharides in this entry.

5.6 Ligand geometry [i](#)

11 ligands are modelled in this entry.

In the following table, the Counts columns list the number of bonds (or angles) for which Mogul statistics could be retrieved, the number of bonds (or angles) that are observed in the model and the number of bonds (or angles) that are defined in the Chemical Component Dictionary. The Link column lists molecule types, if any, to which the group is linked. The Z score for a bond length (or angle) is the number of standard deviations the observed value is removed from the expected value. A bond length (or angle) with $|Z| > 2$ is considered an outlier worth inspection. RMSZ is the root-mean-square of all Z scores of the bond lengths (or angles).

Mol	Type	Chain	Res	Link	Bond lengths			Bond angles		
					Counts	RMSZ	$\# Z > 2$	Counts	RMSZ	$\# Z > 2$
5	GEE	A	704	-	6,6,6	0.48	0	5,6,6	1.25	1 (20%)
6	GOL	A	705	-	5,5,5	0.98	0	5,5,5	1.37	1 (20%)
7	PO4	A	709	-	4,4,4	0.83	0	6,6,6	0.64	0
7	PO4	A	706	-	4,4,4	0.89	0	6,6,6	0.69	0
2	FAD	B	701	-	53,58,58	1.25	7 (13%)	68,89,89	1.31	9 (13%)
3	NAP	B	702	-	45,52,52	0.80	1 (2%)	56,80,80	1.16	4 (7%)
7	PO4	A	708	-	4,4,4	0.78	0	6,6,6	0.63	0

Mol	Type	Chain	Res	Link	Bond lengths			Bond angles		
					Counts	RMSZ	# Z > 2	Counts	RMSZ	# Z > 2
4	OXY	A	703	-	1,1,1	0.07	0	-		
2	FAD	A	701	-	53,58,58	1.25	7 (13%)	68,89,89	1.39	10 (14%)
7	PO4	A	707	-	4,4,4	0.74	0	6,6,6	0.62	0
3	NAP	A	702	-	45,52,52	0.83	1 (2%)	56,80,80	1.09	4 (7%)

In the following table, the Chirals column lists the number of chiral outliers, the number of chiral centers analysed, the number of these observed in the model and the number defined in the Chemical Component Dictionary. Similar counts are reported in the Torsion and Rings columns. '-' means no outliers of that kind were identified.

Mol	Type	Chain	Res	Link	Chirals	Torsions	Rings
5	GEE	A	704	-	-	4/5/5/5	-
6	GOL	A	705	-	-	2/4/4/4	-
2	FAD	B	701	-	-	6/30/50/50	0/6/6/6
3	NAP	B	702	-	-	14/31/67/67	0/5/5/5
2	FAD	A	701	-	-	10/30/50/50	0/6/6/6
3	NAP	A	702	-	-	10/31/67/67	0/5/5/5

All (16) bond length outliers are listed below:

Mol	Chain	Res	Type	Atoms	Z	Observed(Å)	Ideal(Å)
2	B	701	FAD	C9A-C5X	4.79	1.49	1.41
2	A	701	FAD	C9A-C5X	4.38	1.48	1.41
2	B	701	FAD	C8-C7	3.20	1.48	1.40
2	A	701	FAD	C8-C7	2.96	1.48	1.40
2	A	701	FAD	C4-N3	-2.95	1.33	1.38
2	B	701	FAD	C4-N3	-2.87	1.33	1.38
3	B	702	NAP	C5A-C4A	2.48	1.47	1.40
2	B	701	FAD	C5A-C4A	2.35	1.47	1.40
2	A	701	FAD	C5X-N5	-2.34	1.35	1.39
3	A	702	NAP	C5A-C4A	2.29	1.47	1.40
2	B	701	FAD	C4X-N5	2.26	1.35	1.30
2	A	701	FAD	C5A-C4A	2.12	1.46	1.40
2	B	701	FAD	C5X-N5	-2.09	1.35	1.39
2	A	701	FAD	C4X-N5	2.08	1.34	1.30
2	A	701	FAD	C2-N3	-2.08	1.34	1.39
2	B	701	FAD	C2-N3	-2.05	1.34	1.39

All (29) bond angle outliers are listed below:

Mol	Chain	Res	Type	Atoms	Z	Observed(°)	Ideal(°)
2	B	701	FAD	P-O3P-PA	-3.48	120.89	132.83
3	B	702	NAP	PN-O3-PA	-3.47	120.93	132.83
3	B	702	NAP	C3D-C2D-C1D	3.41	106.11	100.98
2	A	701	FAD	N3A-C2A-N1A	-3.26	123.58	128.68
3	A	702	NAP	C3D-C2D-C1D	3.19	105.78	100.98
3	A	702	NAP	N3A-C2A-N1A	-3.13	123.78	128.68
2	B	701	FAD	C4-C4X-N5	3.05	122.57	118.23
2	A	701	FAD	C4X-C10-N1	-3.02	117.72	124.73
2	A	701	FAD	C4A-C5A-N7A	-3.01	106.26	109.40
3	B	702	NAP	N3A-C2A-N1A	-2.99	124.00	128.68
2	B	701	FAD	N3A-C2A-N1A	-2.92	124.12	128.68
2	A	701	FAD	C4'-C3'-C2'	-2.85	107.43	113.36
5	A	704	GEE	O-C-CA	2.75	125.26	119.11
3	A	702	NAP	C4A-C5A-N7A	-2.58	106.71	109.40
2	A	701	FAD	C10-N1-C2	2.55	121.99	116.90
2	B	701	FAD	C4A-C5A-N7A	-2.54	106.76	109.40
2	A	701	FAD	O4-C4-C4X	-2.51	119.93	126.60
3	B	702	NAP	C4A-C5A-N7A	-2.43	106.87	109.40
3	A	702	NAP	PN-O3-PA	-2.39	124.62	132.83
2	B	701	FAD	C4X-C10-N1	-2.36	119.25	124.73
6	A	705	GOL	O3-C3-C2	-2.35	98.95	110.20
2	A	701	FAD	P-O3P-PA	-2.34	124.81	132.83
2	A	701	FAD	C5X-C9A-N10	2.30	120.33	117.95
2	B	701	FAD	C4X-C10-N10	2.22	119.72	116.48
2	A	701	FAD	C4X-C4-N3	2.22	118.82	113.19
2	B	701	FAD	C4X-C4-N3	2.20	118.78	113.19
2	B	701	FAD	O4-C4-C4X	-2.10	121.03	126.60
2	A	701	FAD	C4-N3-C2	-2.02	121.90	125.64
2	B	701	FAD	C10-N1-C2	2.01	120.91	116.90

There are no chirality outliers.

All (46) torsion outliers are listed below:

Mol	Chain	Res	Type	Atoms
2	A	701	FAD	C2'-C1'-N10-C10
2	A	701	FAD	N10-C1'-C2'-O2'
2	A	701	FAD	N10-C1'-C2'-C3'
2	A	701	FAD	C2'-C3'-C4'-O4'
2	A	701	FAD	O3'-C3'-C4'-O4'
2	A	701	FAD	O3'-C3'-C4'-C5'
2	A	701	FAD	PA-O3P-P-O5'
2	B	701	FAD	C5B-O5B-PA-O2A
2	B	701	FAD	C5B-O5B-PA-O3P

Continued on next page...

Continued from previous page...

Mol	Chain	Res	Type	Atoms
2	B	701	FAD	C5'-O5'-P-O3P
3	B	702	NAP	C5B-O5B-PA-O1A
3	B	702	NAP	C3B-C4B-C5B-O5B
3	B	702	NAP	O4D-C1D-N1N-C6N
3	B	702	NAP	C2N-C3N-C7N-O7N
3	B	702	NAP	C2N-C3N-C7N-N7N
5	A	704	GEE	CA-C-O1-C1
5	A	704	GEE	O-C-CA-N
6	A	705	GOL	C1-C2-C3-O3
3	B	702	NAP	C4N-C3N-C7N-N7N
3	B	702	NAP	C4N-C3N-C7N-O7N
3	A	702	NAP	C4D-C5D-O5D-PN
2	A	701	FAD	C2'-C3'-C4'-C5'
5	A	704	GEE	O1-C-CA-N
5	A	704	GEE	O-C-O1-C1
3	B	702	NAP	O4B-C4B-C5B-O5B
3	A	702	NAP	C3D-C4D-C5D-O5D
3	A	702	NAP	C2N-C3N-C7N-O7N
6	A	705	GOL	O2-C2-C3-O3
3	B	702	NAP	C4B-C5B-O5B-PA
3	B	702	NAP	C4D-C5D-O5D-PN
3	A	702	NAP	C2N-C3N-C7N-N7N
2	B	701	FAD	PA-O3P-P-O5'
3	A	702	NAP	O4D-C4D-C5D-O5D
2	A	701	FAD	C5B-O5B-PA-O3P
3	B	702	NAP	C5B-O5B-PA-O3
2	B	701	FAD	C5'-O5'-P-O1P
3	A	702	NAP	C4N-C3N-C7N-O7N
3	A	702	NAP	C4N-C3N-C7N-N7N
3	A	702	NAP	O4B-C4B-C5B-O5B
3	B	702	NAP	C2B-O2B-P2B-O1X
3	A	702	NAP	C5D-O5D-PN-O3
3	B	702	NAP	C2B-O2B-P2B-O2X
2	B	701	FAD	P-O3P-PA-O2A
3	A	702	NAP	C5D-O5D-PN-O2N
2	A	701	FAD	O4B-C4B-C5B-O5B
3	B	702	NAP	O4D-C4D-C5D-O5D

There are no ring outliers.

6 monomers are involved in 15 short contacts:

Mol	Chain	Res	Type	Clashes	Symm-Clashes
5	A	704	GEE	1	0
6	A	705	GOL	1	0
2	B	701	FAD	4	0
3	B	702	NAP	4	0
2	A	701	FAD	3	0
3	A	702	NAP	2	0

The following is a two-dimensional graphical depiction of Mogul quality analysis of bond lengths, bond angles, torsion angles, and ring geometry for all instances of the Ligand of Interest. In addition, ligands with molecular weight > 250 and outliers as shown on the validation Tables will also be included. For torsion angles, if less than 5% of the Mogul distribution of torsion angles is within 10 degrees of the torsion angle in question, then that torsion angle is considered an outlier. Any bond that is central to one or more torsion angles identified as an outlier by Mogul will be highlighted in the graph. For rings, the root-mean-square deviation (RMSD) between the ring in question and similar rings identified by Mogul is calculated over all ring torsion angles. If the average RMSD is greater than 60 degrees and the minimal RMSD between the ring in question and any Mogul-identified rings is also greater than 60 degrees, then that ring is considered an outlier. The outliers are highlighted in purple. The color gray indicates Mogul did not find sufficient equivalents in the CSD to analyse the geometry.

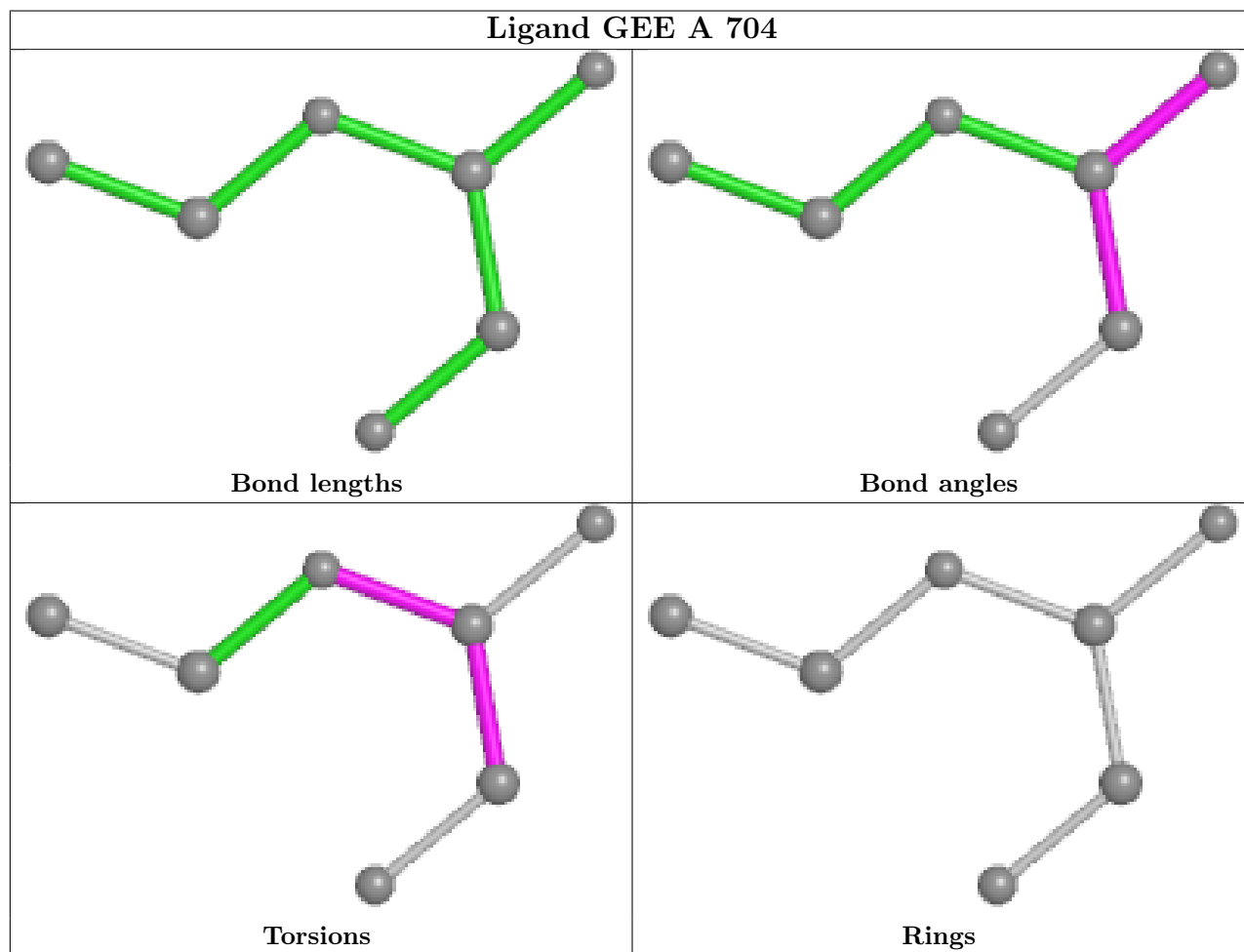

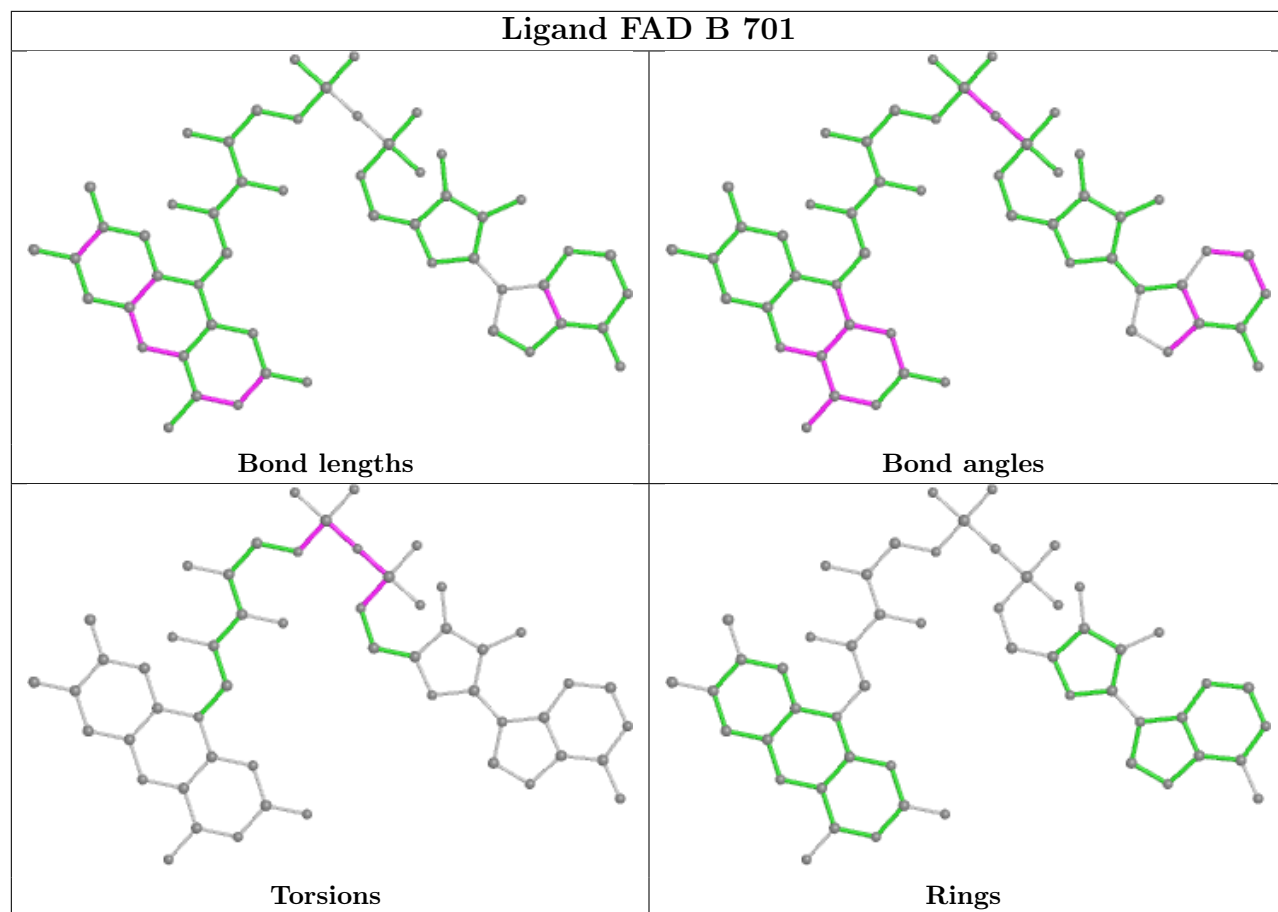

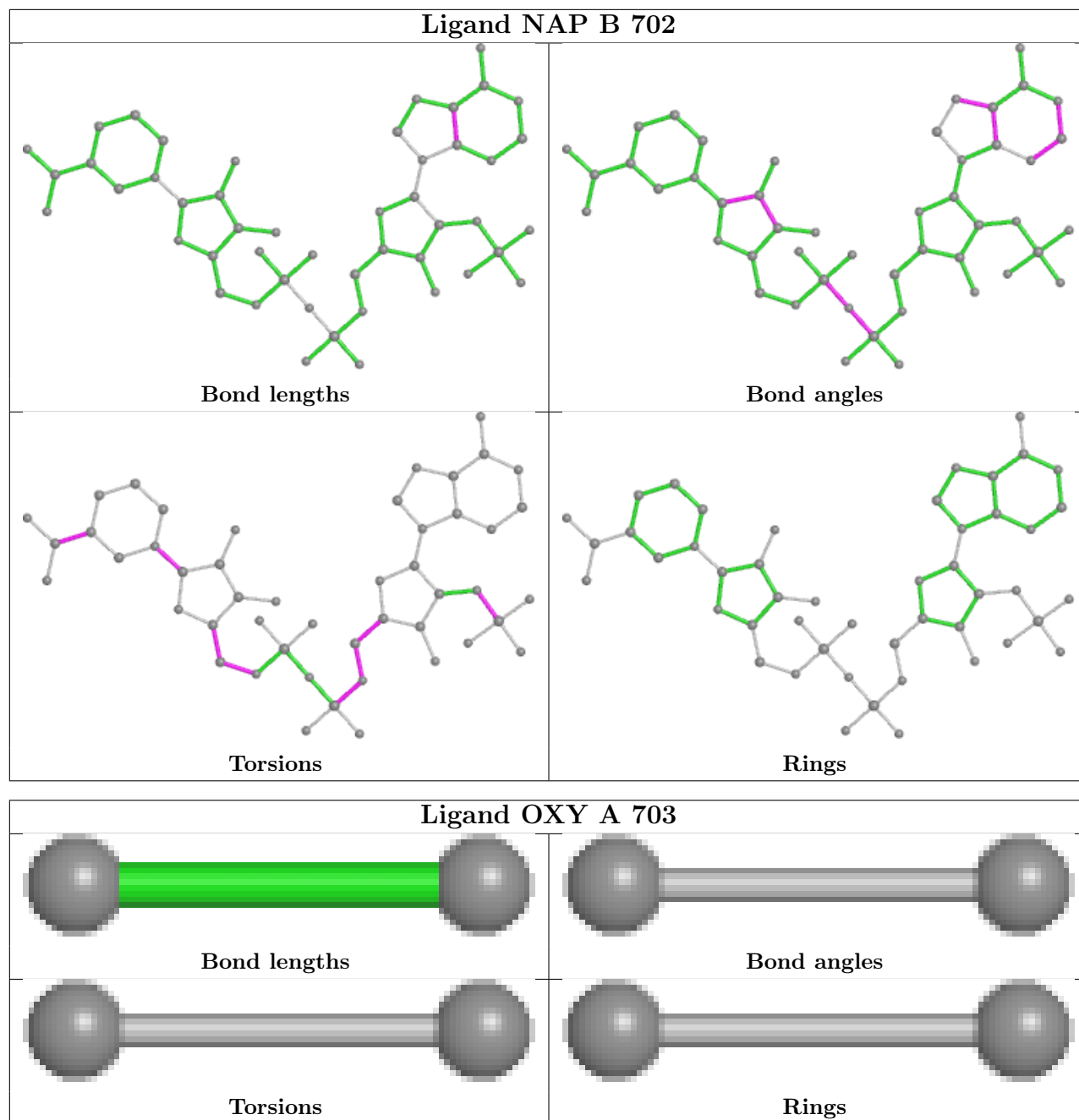

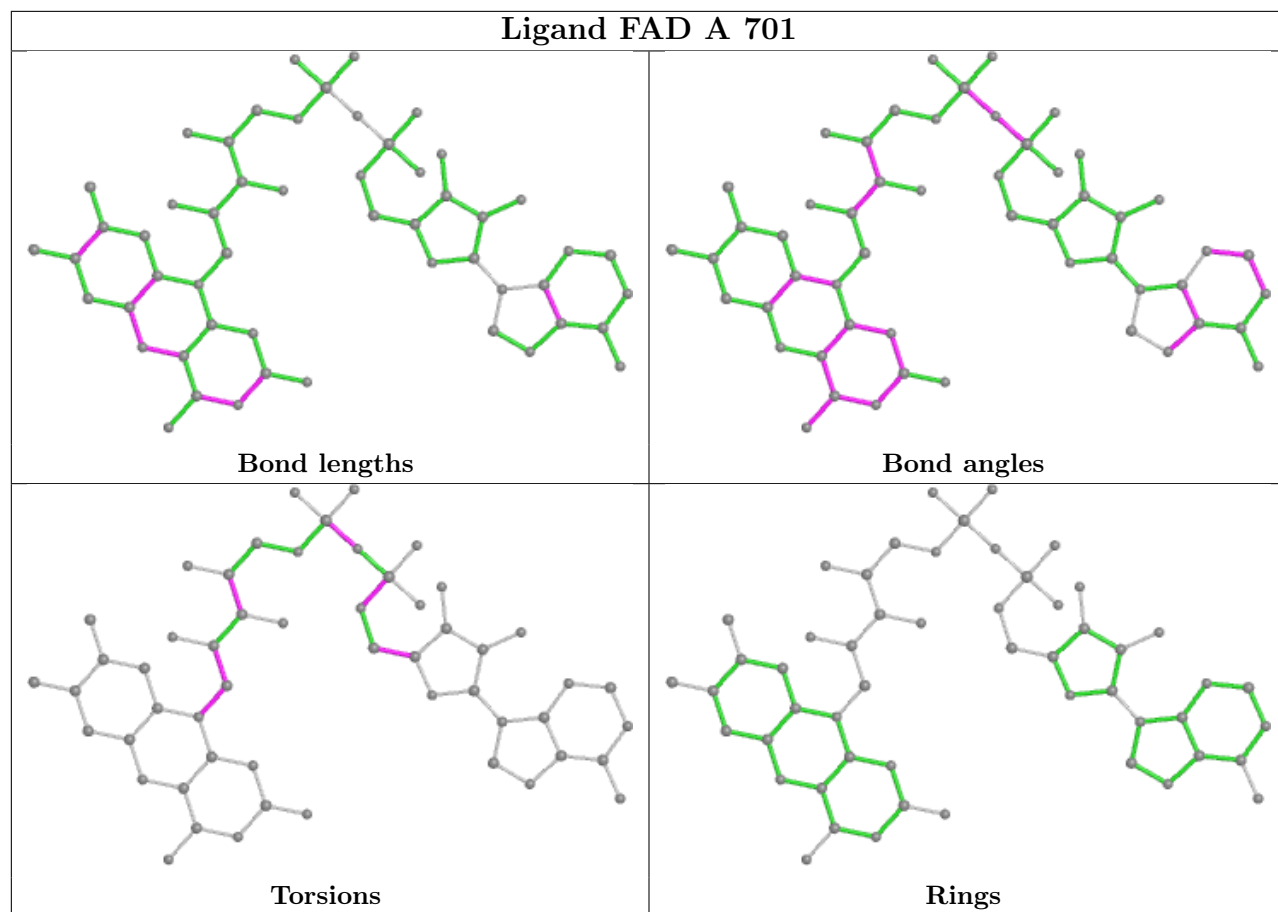

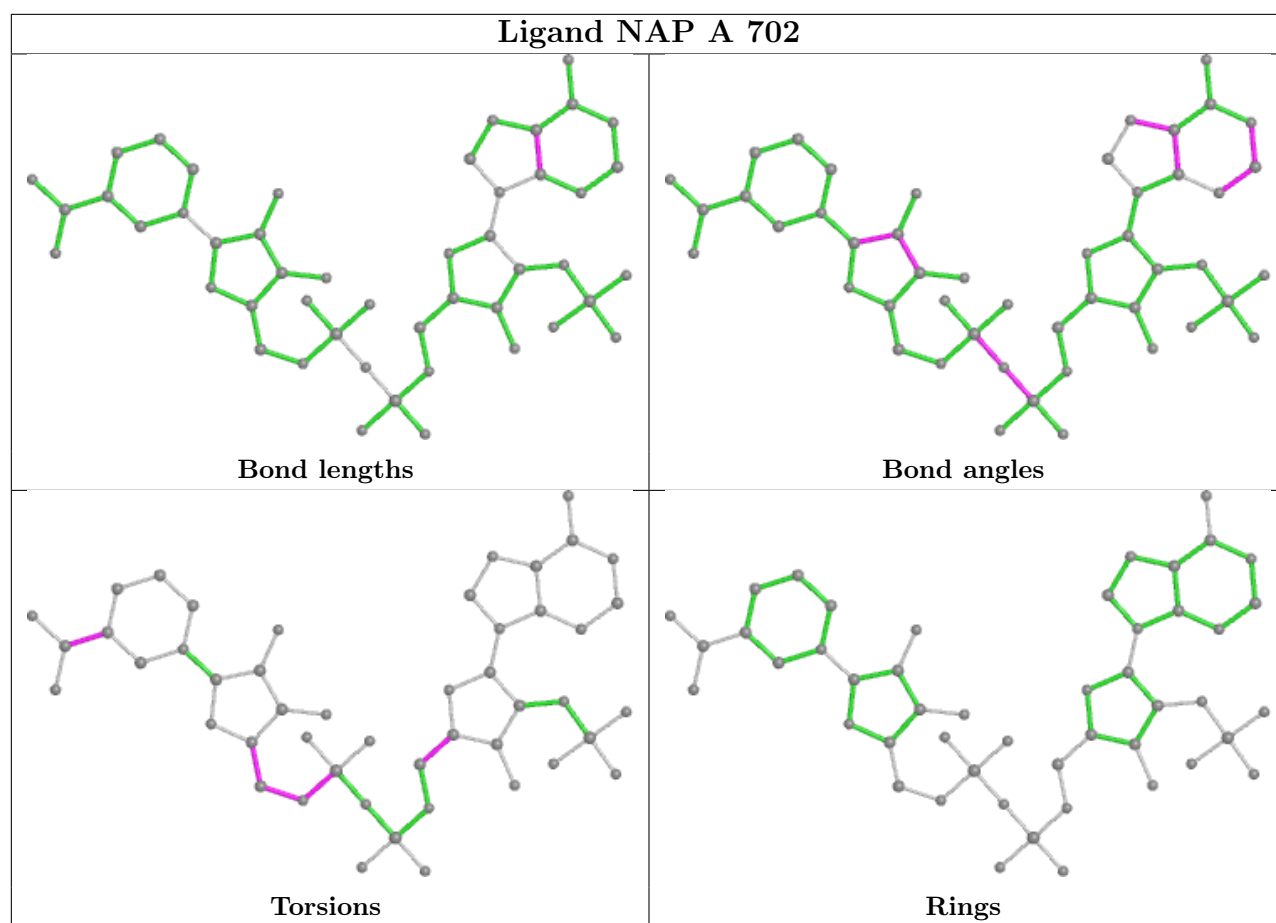

5.7 Other polymers [\(i\)](#)

There are no such residues in this entry.

5.8 Polymer linkage issues [\(i\)](#)

There are no chain breaks in this entry.

6 Fit of model and data

6.1 Protein, DNA and RNA chains

In the following table, the column labelled ‘#RSRZ > 2’ contains the number (and percentage) of RSRZ outliers, followed by percent RSRZ outliers for the chain as percentile scores relative to all X-ray entries and entries of similar resolution. The OWAB column contains the minimum, median, 95th percentile and maximum values of the occupancy-weighted average B-factor per residue. The column labelled ‘Q < 0.9’ lists the number of (and percentage) of residues with an average occupancy less than 0.9.

Mol	Chain	Analysed	<RSRZ>	#RSRZ>2	OWAB(Å ²)	Q<0.9
1	A	612/639 (95%)	-0.50	5 (0%) 86 71	23, 44, 84, 137	25 (4%)
1	B	556/639 (87%)	0.57	35 (6%) 20 8	9, 49, 84, 131	553 (99%)
All	All	1168/1278 (91%)	0.01	40 (3%) 45 23	9, 46, 84, 137	578 (49%)

All (40) RSRZ outliers are listed below:

Mol	Chain	Res	Type	RSRZ
1	B	574	ASP	4.8
1	B	165	GLN	4.5
1	B	605	TYR	3.8
1	B	132	GLY	3.8
1	B	407	GLU	3.7
1	B	182	PHE	3.7
1	B	316	GLY	3.5
1	B	45	SER	3.3
1	B	517	GLN	3.2
1	B	18	ILE	3.1
1	A	243	ASP	3.0
1	B	617	TYR	3.0
1	B	619	THR	3.0
1	B	582	ARG	2.9
1	B	494	LEU	2.8
1	B	51	TRP	2.7
1	B	328	CYS	2.7
1	B	131	ILE	2.6
1	B	123	HIS	2.6
1	B	403	HIS	2.6
1	B	400	GLU	2.6
1	B	310	CYS	2.5
1	B	48	GLY	2.5
1	B	476	GLN	2.5

Continued on next page...

Continued from previous page...

Mol	Chain	Res	Type	RSRZ
1	B	46	VAL	2.4
1	B	19	GLY	2.4
1	B	318	HIS	2.4
1	B	524	ILE	2.4
1	A	134	GLY	2.4
1	B	478	GLU	2.3
1	B	126	GLN	2.3
1	B	200	ALA	2.3
1	A	139	THR	2.2
1	A	138	GLN	2.2
1	B	579	THR	2.2
1	B	325	VAL	2.1
1	A	522	ASN	2.1
1	B	577	GLN	2.1
1	B	622	ALA	2.1
1	B	624	THR	2.0

6.2 Non-standard residues in protein, DNA, RNA chains [i](#)

There are no non-standard protein/DNA/RNA residues in this entry.

6.3 Carbohydrates [i](#)

There are no monosaccharides in this entry.

6.4 Ligands [i](#)

In the following table, the Atoms column lists the number of modelled atoms in the group and the number defined in the chemical component dictionary. The B-factors column lists the minimum, median, 95th percentile and maximum values of B factors of atoms in the group. The column labelled 'Q< 0.9' lists the number of atoms with occupancy less than 0.9.

Mol	Type	Chain	Res	Atoms	RSCC	RSR	B-factors(Å ²)	Q<0.9
5	GEE	A	704	7/7	0.64	0.49	51,76,88,89	0
3	NAP	B	702	48/48	0.73	0.37	29,76,97,112	48
7	PO4	A	707	5/5	0.80	0.37	54,74,106,119	5
2	FAD	B	701	53/53	0.83	0.28	25,49,68,73	53
4	OXY	A	703	2/2	0.83	0.33	52,52,52,67	0
7	PO4	A	709	5/5	0.92	0.21	31,43,78,115	5
3	NAP	A	702	48/48	0.93	0.23	25,45,63,76	25

Continued on next page...

Continued from previous page...

Mol	Type	Chain	Res	Atoms	RSCC	RSR	B-factors(\AA^2)	Q<0.9
7	PO4	A	706	5/5	0.93	0.17	25,48,71,88	5
7	PO4	A	708	5/5	0.94	0.13	37,42,97,98	5
2	FAD	A	701	53/53	0.97	0.14	17,31,46,50	0
6	GOL	A	705	6/6	0.98	0.15	23,31,34,53	0

The following is a graphical depiction of the model fit to experimental electron density of all instances of the Ligand of Interest. In addition, ligands with molecular weight > 250 and outliers as shown on the geometry validation Tables will also be included. Each fit is shown from different orientation to approximate a three-dimensional view.

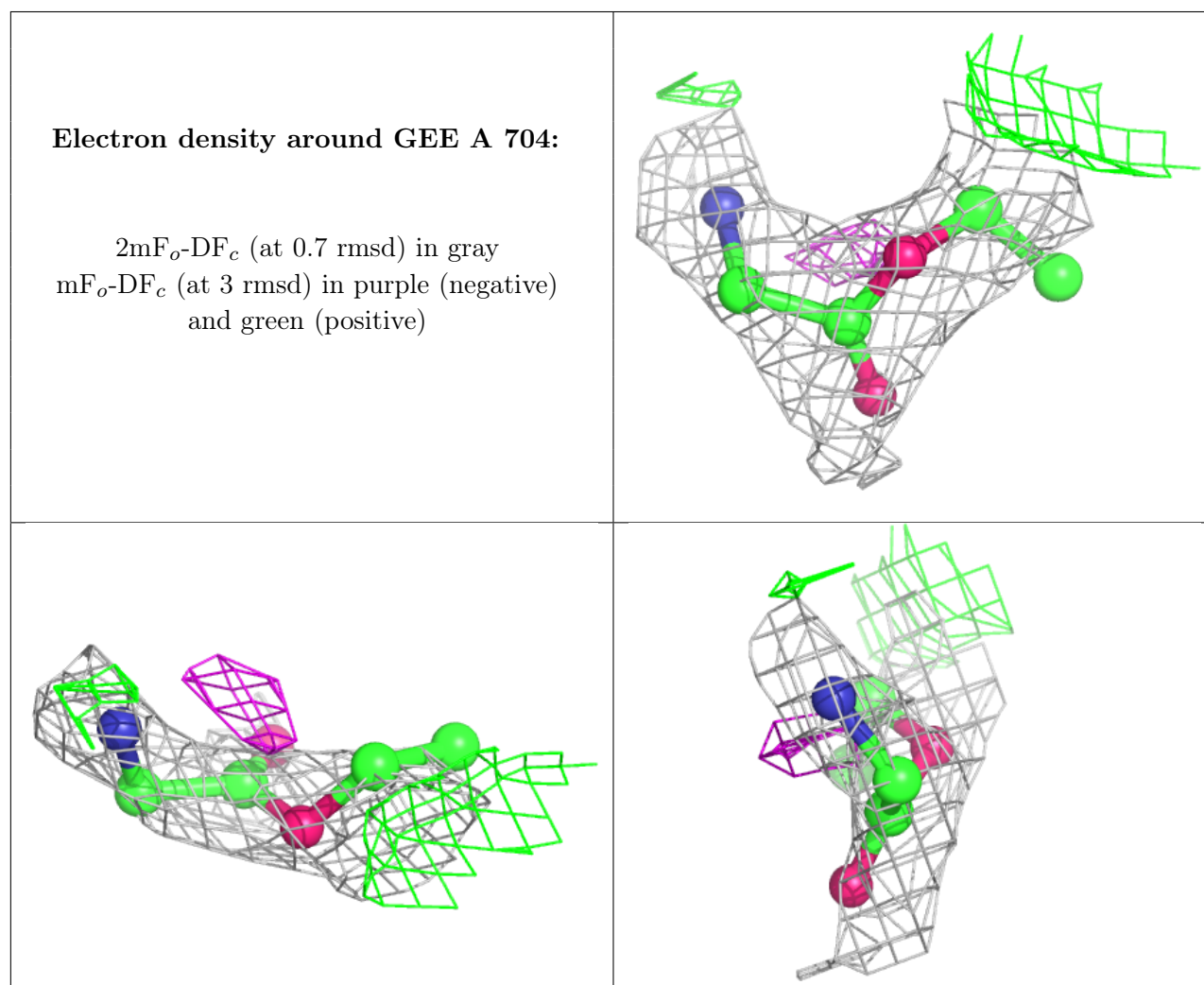

Electron density around NAP B 702:

$2mF_o-DF_c$ (at 0.7 rmsd) in gray
 mF_o-DF_c (at 3 rmsd) in purple (negative)
and green (positive)

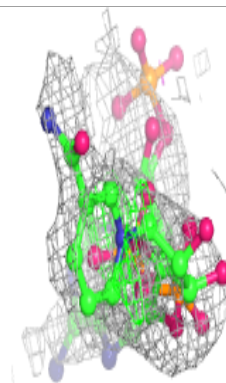
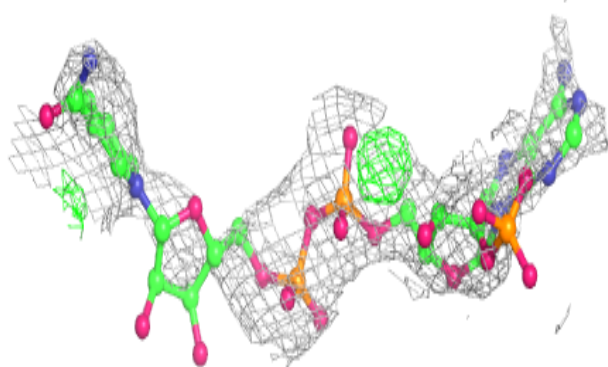
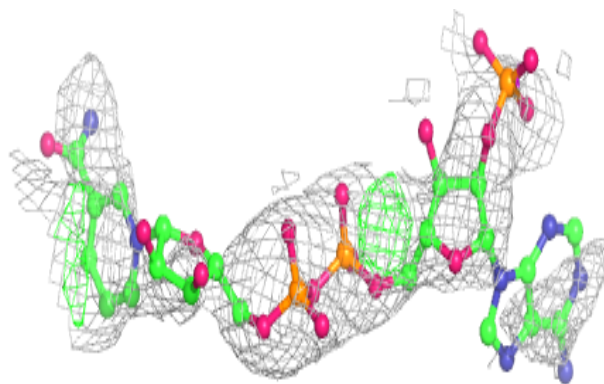
**Electron density around FAD B 701:**

$2mF_o-DF_c$ (at 0.7 rmsd) in gray
 mF_o-DF_c (at 3 rmsd) in purple (negative)
and green (positive)

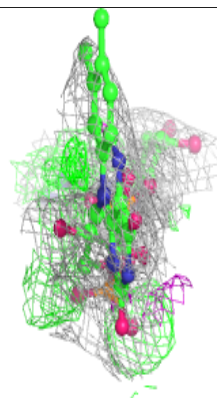
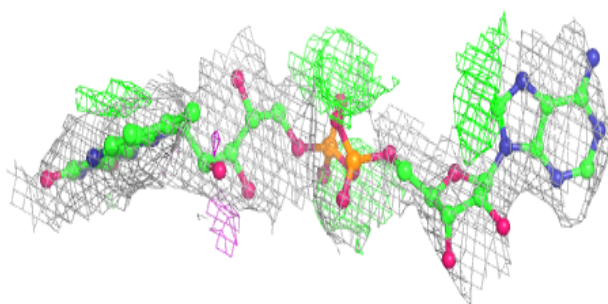
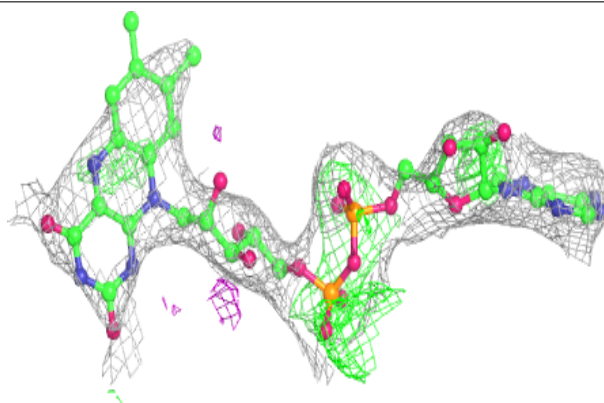

Electron density around OXY A 703:

$2mF_o-DF_c$ (at 0.7 rmsd) in gray
 mF_o-DF_c (at 3 rmsd) in purple (negative)
and green (positive)

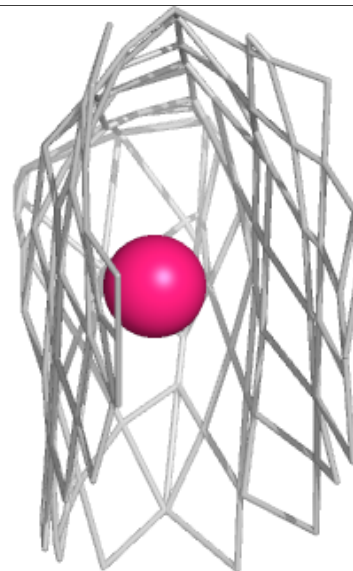
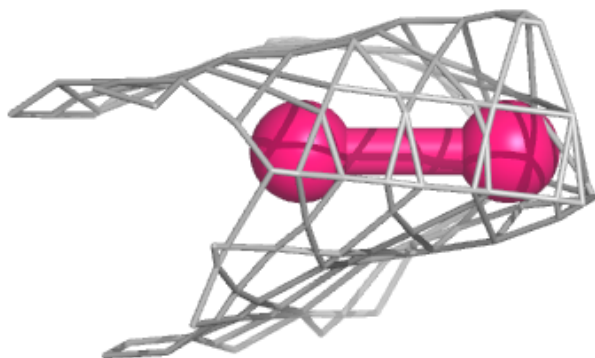
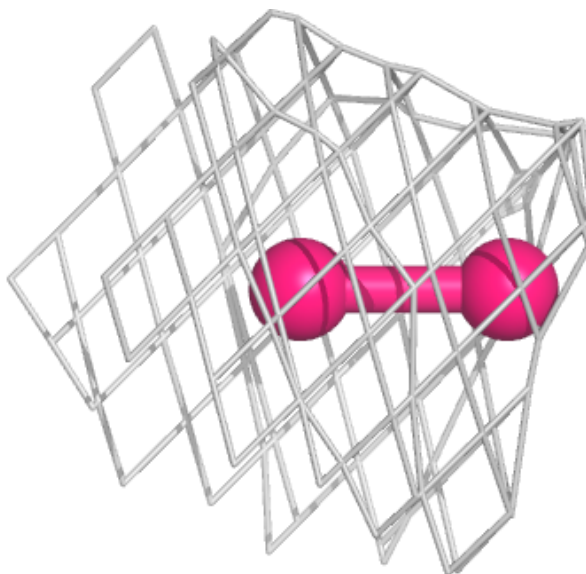

Electron density around NAP A 702:

$2mF_o-DF_c$ (at 0.7 rmsd) in gray
 mF_o-DF_c (at 3 rmsd) in purple (negative)
and green (positive)

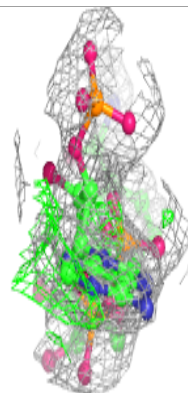
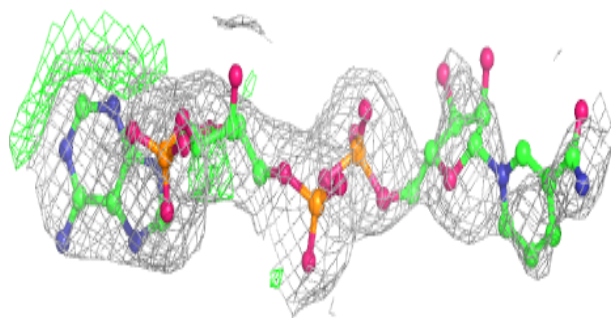
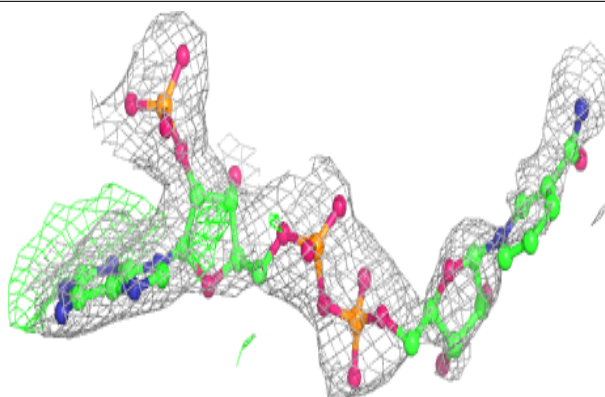
**Electron density around FAD A 701:**

$2mF_o-DF_c$ (at 0.7 rmsd) in gray
 mF_o-DF_c (at 3 rmsd) in purple (negative)
and green (positive)

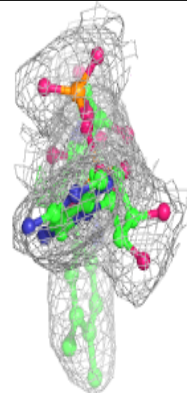
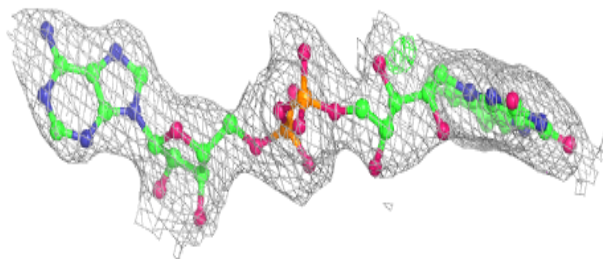
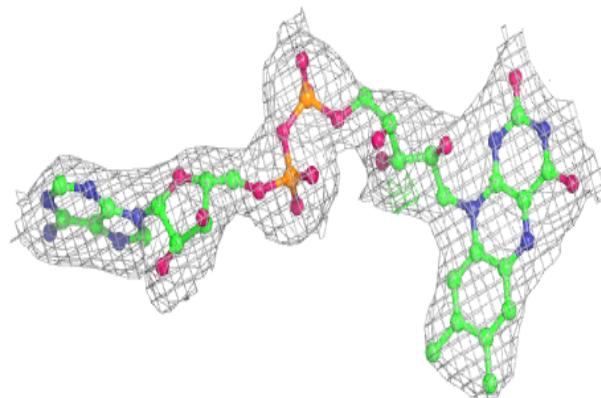

6.5 Other polymers [i](#)

There are no such residues in this entry.