



Full wwPDB EM Validation Report ⓘ

Mar 9, 2023 – 04:08 pm GMT

PDB ID : 5OOM
EMDB ID : EMD-3843
Title : Structure of a native assembly intermediate of the human mitochondrial ribosome with unfolded interfacial rRNA
Authors : Brown, A.; Rathore, S.; Kimanius, D.; Aibara, S.; Bai, X.C.; Rorbach, J.; Amunts, A.; Ramakrishnan, V.
Deposited on : 2017-08-08
Resolution : 3.03 Å (reported)
Based on initial model : 3J9M

This is a Full wwPDB EM Validation Report for a publicly released PDB entry.

We welcome your comments at validation@mail.wwpdb.org

A user guide is available at

<https://www.wwpdb.org/validation/2017/EMValidationReportHelp>

with specific help available everywhere you see the ⓘ symbol.

The types of validation reports are described at

<http://www.wwpdb.org/validation/2017/FAQs#types>.

The following versions of software and data (see [references ⓘ](#)) were used in the production of this report:

EMDB validation analysis : 0.0.1.dev43
Mogul : 1.8.4, CSD as541be (2020)
MolProbity : 4.02b-467
buster-report : 1.1.7 (2018)
Percentile statistics : 20191225.v01 (using entries in the PDB archive December 25th 2019)
MapQ : 1.9.9
Ideal geometry (proteins) : Engh & Huber (2001)
Ideal geometry (DNA, RNA) : Parkinson et al. (1996)
Validation Pipeline (wwPDB-VP) : 2.32.1

1 Overall quality at a glance

The following experimental techniques were used to determine the structure:
ELECTRON MICROSCOPY

The reported resolution of this entry is 3.03 Å.

Percentile scores (ranging between 0-100) for global validation metrics of the entry are shown in the following graphic. The table shows the number of entries on which the scores are based.

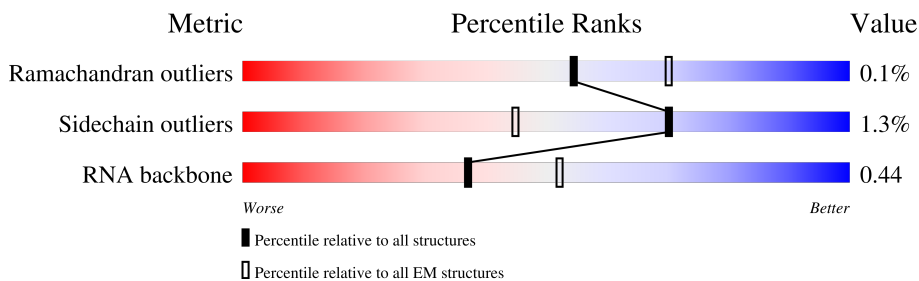











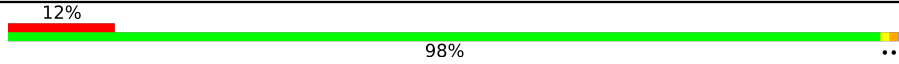

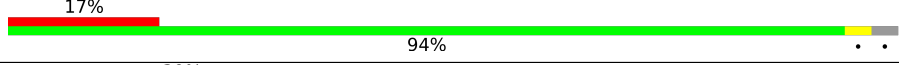

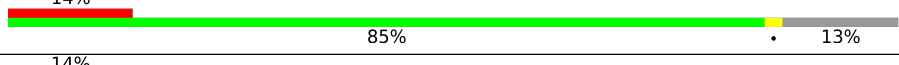
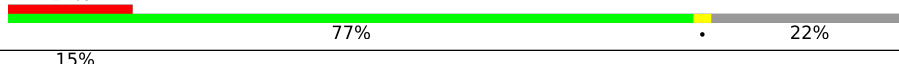
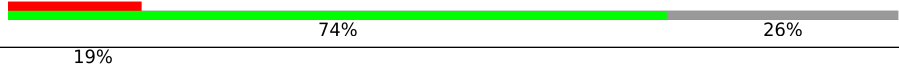
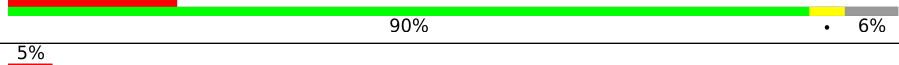
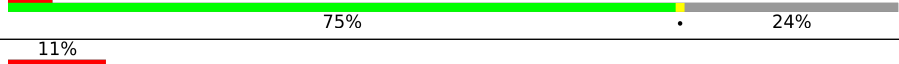
Metric	Whole archive (#Entries)	EM structures (#Entries)
Ramachandran outliers	154571	4023
Sidechain outliers	154315	3826
RNA backbone	4643	859

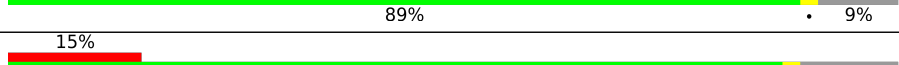
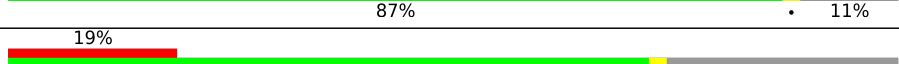
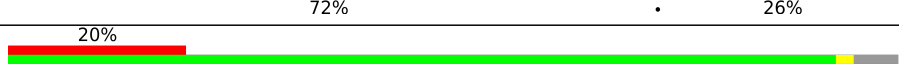
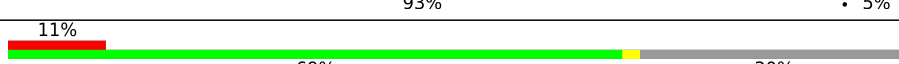
The table below summarises the geometric issues observed across the polymeric chains and their fit to the map. The red, orange, yellow and green segments of the bar indicate the fraction of residues that contain outliers for ≥ 3 , 2, 1 and 0 types of geometric quality criteria respectively. A grey segment represents the fraction of residues that are not modelled. The numeric value for each fraction is indicated below the corresponding segment, with a dot representing fractions $\leq 5\%$. The upper red bar (where present) indicates the fraction of residues that have poor fit to the EM map (all-atom inclusion $< 40\%$). The numeric value is given above the bar.

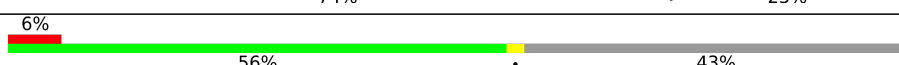
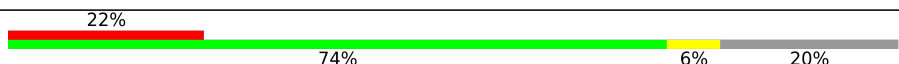
Mol	Chain	Length	Quality of chain
1	A	1559	
2	B	69	
3	D	305	
4	E	348	
5	F	311	
6	H	267	
7	I	261	
8	J	192	

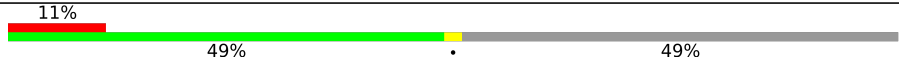
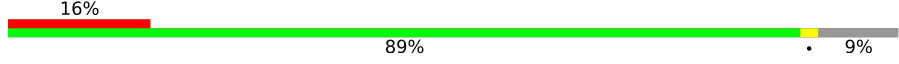
Continued on next page...

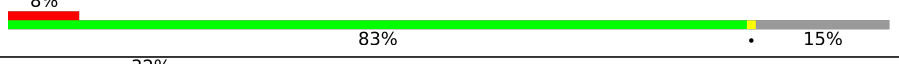
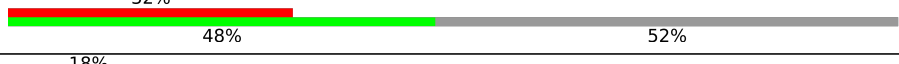
Continued from previous page...

Mol	Chain	Length	Quality of chain
9	K	178	
10	L	145	
11	M	296	
12	N	251	
13	O	175	
14	P	180	
15	Q	292	
16	R	149	
17	S	205	
18	T	206	
19	U	153	
20	V	216	
21	W	148	
22	X	256	
23	Y	250	
24	Z	161	
25	0	188	
26	1	65	
27	2	92	
28	3	188	
29	5	423	
30	6	380	
31	7	338	
32	8	206	
33	9	137	

Continued on next page...

Continued from previous page...

Mol	Chain	Length	Quality of chain
34	a	142	6% 56% 42%
35	b	215	6% 67% 31%
36	c	332	5% 82% 17%
37	d	306	17% 68% 31%
38	e	279	67% 76% 22%
39	f	212	38% 54% 45%
40	g	166	6% 75% 22%
41	h	158	9% 62% 37%
42	i	128	16% 71% 5% 24%
43	j	123	8% 69% 31%
44	k	112	63% 71% 29%
45	l	138	14% 17% 83%
46	m	128	30% 33% 65%
47	o	102	6% 77% 23%
48	p	206	19% 61% 38%
49	q	222	12% 56% 42%
50	r	196	15% 73% 26%
51	s	439	10% 82% 16%
52	t	28	100% 100%
53	u	234	10% 47% 53%
54	v	70	50% 97%
55	w	156	47% 50% 49%

2 Entry composition i

There are 58 unique types of molecules in this entry. The entry contains 90739 atoms, of which 0 are hydrogens and 0 are deuteriums.

In the tables below, the AltConf column contains the number of residues with at least one atom in alternate conformation and the Trace column contains the number of residues modelled with at most 2 atoms.

- Molecule 1 is a RNA chain called 16S ribosomal RNA.

Mol	Chain	Residues	Atoms					AltConf	Trace
			Total	C	N	O	P		
1	A	1092	23184	10409	4202	7481	1092	0	0

There is a discrepancy between the modelled and reference sequences:

Chain	Residue	Modelled	Actual	Comment	Reference
A	3107	U	UNK	conflict	GB 1025814679

- Molecule 2 is a RNA chain called mitochondrial tRNAVal.

Mol	Chain	Residues	Atoms					AltConf	Trace
			Total	C	N	O	P		
2	B	56	1191	534	214	387	56	0	0

- Molecule 3 is a protein called 39S ribosomal protein L2, mitochondrial.

Mol	Chain	Residues	Atoms					AltConf	Trace
			Total	C	N	O	S		
3	D	220	1706	1059	339	299	9	0	0

- Molecule 4 is a protein called 39S ribosomal protein L3, mitochondrial.

Mol	Chain	Residues	Atoms					AltConf	Trace
			Total	C	N	O	S		
4	E	285	2258	1457	384	406	11	0	0

- Molecule 5 is a protein called 39S ribosomal protein L4, mitochondrial.

Mol	Chain	Residues	Atoms					AltConf	Trace
			Total	C	N	O	S		
5	F	250	2013	1294	365	348	6	0	0

- Molecule 6 is a protein called 39S ribosomal protein L9, mitochondrial.

Mol	Chain	Residues	Atoms				AltConf	Trace
6	H	95	Total	C	N	O	0	0
			784	498	152	134		

- Molecule 7 is a protein called 39S ribosomal protein L10, mitochondrial.

Mol	Chain	Residues	Atoms					AltConf	Trace
7	I	158	Total	C	N	O	S	0	0
			1283	828	235	210	10		

- Molecule 8 is a protein called 39S ribosomal protein L11, mitochondrial.

Mol	Chain	Residues	Atoms					AltConf	Trace
8	J	140	Total	C	N	O	S	0	0
			1061	680	192	187	2		

- Molecule 9 is a protein called 39S ribosomal protein L13, mitochondrial.

Mol	Chain	Residues	Atoms					AltConf	Trace
9	K	177	Total	C	N	O	S	0	0
			1451	934	259	251	7		

- Molecule 10 is a protein called 39S ribosomal protein L14, mitochondrial.

Mol	Chain	Residues	Atoms					AltConf	Trace
10	L	115	Total	C	N	O	S	0	0
			889	559	171	154	5		

- Molecule 11 is a protein called 39S ribosomal protein L15, mitochondrial.

Mol	Chain	Residues	Atoms					AltConf	Trace
11	M	287	Total	C	N	O	S	0	0
			2305	1472	425	402	6		

- Molecule 12 is a protein called 39S ribosomal protein L16, mitochondrial.

Mol	Chain	Residues	Atoms					AltConf	Trace
12	N	205	Total	C	N	O	S	0	0
			1654	1056	308	280	10		

- Molecule 13 is a protein called 39S ribosomal protein L17, mitochondrial.

Mol	Chain	Residues	Atoms					AltConf	Trace
13	O	152	Total	C	N	O	S	0	0
			1245	784	239	215	7		

- Molecule 14 is a protein called 39S ribosomal protein L18, mitochondrial.

Mol	Chain	Residues	Atoms					AltConf	Trace
14	P	141	Total	C	N	O	S	0	0
			1148	719	221	203	5		

- Molecule 15 is a protein called 39S ribosomal protein L19, mitochondrial.

Mol	Chain	Residues	Atoms					AltConf	Trace
15	Q	217	Total	C	N	O	S	0	0
			1805	1159	317	320	9		

- Molecule 16 is a protein called 39S ribosomal protein L20, mitochondrial.

Mol	Chain	Residues	Atoms					AltConf	Trace
16	R	140	Total	C	N	O	S	0	0
			1153	732	231	186	4		

- Molecule 17 is a protein called 39S ribosomal protein L21, mitochondrial.

Mol	Chain	Residues	Atoms					AltConf	Trace
17	S	156	Total	C	N	O	S	0	0
			1251	806	222	219	4		

- Molecule 18 is a protein called 39S ribosomal protein L22, mitochondrial.

Mol	Chain	Residues	Atoms					AltConf	Trace
18	T	159	Total	C	N	O	S	0	0
			1305	835	239	224	7		

- Molecule 19 is a protein called 39S ribosomal protein L23, mitochondrial.

Mol	Chain	Residues	Atoms					AltConf	Trace
19	U	139	Total	C	N	O	S	0	0
			1154	734	220	197	3		

- Molecule 20 is a protein called 39S ribosomal protein L24, mitochondrial.

Mol	Chain	Residues	Atoms					AltConf	Trace
			Total	C	N	O	S		
20	V	192	1575	1003	281	283	8	0	0

- Molecule 21 is a protein called 39S ribosomal protein L27, mitochondrial.

Mol	Chain	Residues	Atoms					AltConf	Trace
			Total	C	N	O	S		
21	W	109	859	552	162	142	3	0	0

- Molecule 22 is a protein called 39S ribosomal protein L28, mitochondrial.

Mol	Chain	Residues	Atoms					AltConf	Trace
			Total	C	N	O	S		
22	X	243	2035	1317	351	362	5	0	0

- Molecule 23 is a protein called 39S ribosomal protein L47, mitochondrial.

Mol	Chain	Residues	Atoms					AltConf	Trace
			Total	C	N	O	S		
23	Y	176	1517	970	291	252	4	0	0

- Molecule 24 is a protein called 39S ribosomal protein L30, mitochondrial.

Mol	Chain	Residues	Atoms					AltConf	Trace
			Total	C	N	O	S		
24	Z	120	978	626	183	166	3	0	0

- Molecule 25 is a protein called 39S ribosomal protein L32, mitochondrial.

Mol	Chain	Residues	Atoms					AltConf	Trace
			Total	C	N	O	S		
25	0	108	880	545	172	157	6	0	0

- Molecule 26 is a protein called 39S ribosomal protein L33, mitochondrial.

Mol	Chain	Residues	Atoms					AltConf	Trace
			Total	C	N	O	S		
26	1	52	433	278	83	70	2	0	0

- Molecule 27 is a protein called 39S ribosomal protein L34, mitochondrial.

Mol	Chain	Residues	Atoms					AltConf	Trace
27	2	43	Total	C	N	O	S	0	0
			351	218	76	56	1		

- Molecule 28 is a protein called 39S ribosomal protein L35, mitochondrial.

Mol	Chain	Residues	Atoms					AltConf	Trace
28	3	95	Total	C	N	O	S	0	0
			831	539	162	127	3		

- Molecule 29 is a protein called 39S ribosomal protein L37, mitochondrial.

Mol	Chain	Residues	Atoms					AltConf	Trace
29	5	387	Total	C	N	O	S	0	0
			3156	2039	548	558	11		

- Molecule 30 is a protein called 39S ribosomal protein L38, mitochondrial.

Mol	Chain	Residues	Atoms					AltConf	Trace
30	6	324	Total	C	N	O	S	0	0
			2640	1694	470	468	8		

- Molecule 31 is a protein called 39S ribosomal protein L39, mitochondrial.

Mol	Chain	Residues	Atoms					AltConf	Trace
31	7	287	Total	C	N	O	S	0	0
			2334	1495	397	425	17		

- Molecule 32 is a protein called 39S ribosomal protein L40, mitochondrial.

Mol	Chain	Residues	Atoms					AltConf	Trace
32	8	99	Total	C	N	O	S	0	0
			836	535	144	155	2		

- Molecule 33 is a protein called 39S ribosomal protein L41, mitochondrial.

Mol	Chain	Residues	Atoms					AltConf	Trace
33	9	117	Total	C	N	O	S	0	0
			947	614	163	168	2		

- Molecule 34 is a protein called 39S ribosomal protein L42, mitochondrial.

Mol	Chain	Residues	Atoms					AltConf	Trace
34	a	82	Total	C	N	O	S	0	0
			686	434	124	123	5		

- Molecule 35 is a protein called 39S ribosomal protein L43, mitochondrial.

Mol	Chain	Residues	Atoms					AltConf	Trace
35	b	148	Total	C	N	O	S	0	0
			1178	733	229	213	3		

- Molecule 36 is a protein called 39S ribosomal protein L44, mitochondrial.

Mol	Chain	Residues	Atoms					AltConf	Trace
36	c	275	Total	C	N	O	S	0	0
			2217	1415	383	410	9		

- Molecule 37 is a protein called 39S ribosomal protein L45, mitochondrial.

Mol	Chain	Residues	Atoms					AltConf	Trace
37	d	211	Total	C	N	O	S	0	0
			1741	1123	299	309	10		

- Molecule 38 is a protein called 39S ribosomal protein L46, mitochondrial.

Mol	Chain	Residues	Atoms					AltConf	Trace
38	e	217	Total	C	N	O	S	0	0
			1762	1124	310	323	5		

- Molecule 39 is a protein called 39S ribosomal protein L48, mitochondrial.

Mol	Chain	Residues	Atoms					AltConf	Trace
39	f	116	Total	C	N	O	S	0	0
			915	585	152	175	3		

- Molecule 40 is a protein called 39S ribosomal protein L49, mitochondrial.

Mol	Chain	Residues	Atoms					AltConf	Trace
40	g	129	Total	C	N	O	S	0	0
			1067	690	185	190	2		

- Molecule 41 is a protein called 39S ribosomal protein L50, mitochondrial.

Mol	Chain	Residues	Atoms					AltConf	Trace
41	h	100	Total	C	N	O	S	0	0
			827	524	146	155	2		

- Molecule 42 is a protein called 39S ribosomal protein L51, mitochondrial.

Mol	Chain	Residues	Atoms					AltConf	Trace
42	i	97	Total	C	N	O	S	0	0
			827	532	165	126	4		

- Molecule 43 is a protein called 39S ribosomal protein L52, mitochondrial.

Mol	Chain	Residues	Atoms					AltConf	Trace
43	j	85	Total	C	N	O	S	0	0
			684	423	133	126	2		

- Molecule 44 is a protein called 39S ribosomal protein L53, mitochondrial.

Mol	Chain	Residues	Atoms					AltConf	Trace
44	k	80	Total	C	N	O	S	0	0
			627	392	116	114	5		

- Molecule 45 is a protein called 39S ribosomal protein L54, mitochondrial.

Mol	Chain	Residues	Atoms				AltConf	Trace
45	l	23	Total	C	N	O	0	0
			221	137	52	32		

- Molecule 46 is a protein called 39S ribosomal protein L55, mitochondrial.

Mol	Chain	Residues	Atoms					AltConf	Trace
46	m	45	Total	C	N	O	S	0	0
			372	232	76	62	2		

- Molecule 47 is a protein called Ribosomal protein 63, mitochondrial.

Mol	Chain	Residues	Atoms					AltConf	Trace
47	o	79	Total	C	N	O	S	0	0
			665	420	130	112	3		

- Molecule 48 is a protein called Peptidyl-tRNA hydrolase ICT1, mitochondrial.

Mol	Chain	Residues	Atoms					AltConf	Trace
			Total	C	N	O	S		
48	p	127	1058	661	201	192	4	0	0

- Molecule 49 is a protein called Growth arrest and DNA damage-inducible proteins-interacting protein 1.

Mol	Chain	Residues	Atoms					AltConf	Trace
			Total	C	N	O	S		
49	q	128	1076	671	208	192	5	0	0

- Molecule 50 is a protein called 39S ribosomal protein S18a, mitochondrial.

Mol	Chain	Residues	Atoms					AltConf	Trace
			Total	C	N	O	S		
50	r	146	1203	764	232	199	8	0	0

- Molecule 51 is a protein called 39S ribosomal protein S30, mitochondrial.

Mol	Chain	Residues	Atoms					AltConf	Trace
			Total	C	N	O	S		
51	s	370	3036	1946	542	534	14	0	0

- Molecule 52 is a protein called Unknown protein or protein extension.

Mol	Chain	Residues	Atoms				AltConf	Trace
			Total	C	N	O		
52	t	28	140	84	28	28	0	0

- Molecule 53 is a protein called Mitochondrial assembly of ribosomal large subunit protein 1.

Mol	Chain	Residues	Atoms					AltConf	Trace
			Total	C	N	O	S		
53	u	111	927	595	155	167	10	0	0

- Molecule 54 is a protein called MIEF1 upstream open reading frame protein.

Mol	Chain	Residues	Atoms				AltConf	Trace
			Total	C	N	O		
54	v	69	588	372	116	100	0	0

- Molecule 55 is a protein called Acyl carrier protein, mitochondrial.

Mol	Chain	Residues	Atoms					AltConf	Trace
			Total	C	N	O	S		
55	w	79	638	410	95	128	5	0	0

- Molecule 56 is MAGNESIUM ION (three-letter code: MG) (formula: Mg).

Mol	Chain	Residues	Atoms		AltConf
56	A	47	Total	Mg	0
			47	47	
56	W	1	Total	Mg	0
			1	1	
56	g	1	Total	Mg	0
			1	1	

- Molecule 57 is ZINC ION (three-letter code: ZN) (formula: Zn).

Mol	Chain	Residues	Atoms		AltConf
57	I	1	Total	Zn	0
			1	1	
57	0	1	Total	Zn	0
			1	1	

- Molecule 58 is 4'-PHOSPHOPANTETHEINE (three-letter code: PNS) (formula: C₁₁H₂₃N₂O₇PS).

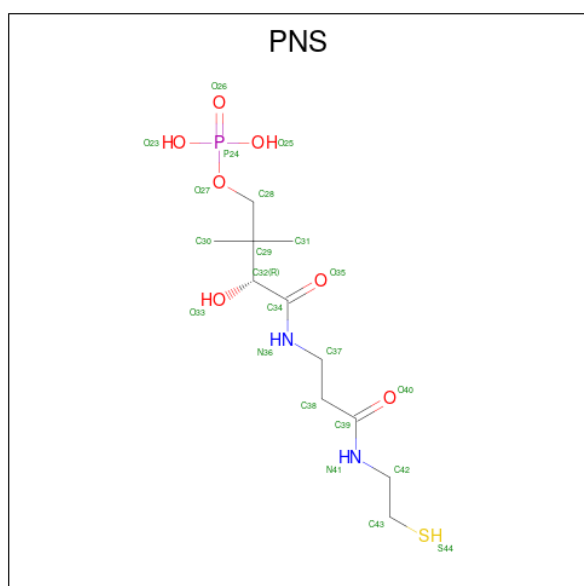

Mol	Chain	Residues	Atoms					AltConf	
			Total	C	N	O	P		S
58	v	1	21	11	2	6	1	1	0

3 Residue-property plots

These plots are drawn for all protein, RNA, DNA and oligosaccharide chains in the entry. The first graphic for a chain summarises the proportions of the various outlier classes displayed in the second graphic. The second graphic shows the sequence view annotated by issues in geometry and atom inclusion in map density. Residues are color-coded according to the number of geometric quality criteria for which they contain at least one outlier: green = 0, yellow = 1, orange = 2 and red = 3 or more. A red diamond above a residue indicates a poor fit to the EM map for this residue (all-atom inclusion < 40%). Stretches of 2 or more consecutive residues without any outlier are shown as a green connector. Residues present in the sample, but not in the model, are shown in grey.

• Molecule 1: 16S ribosomal RNA

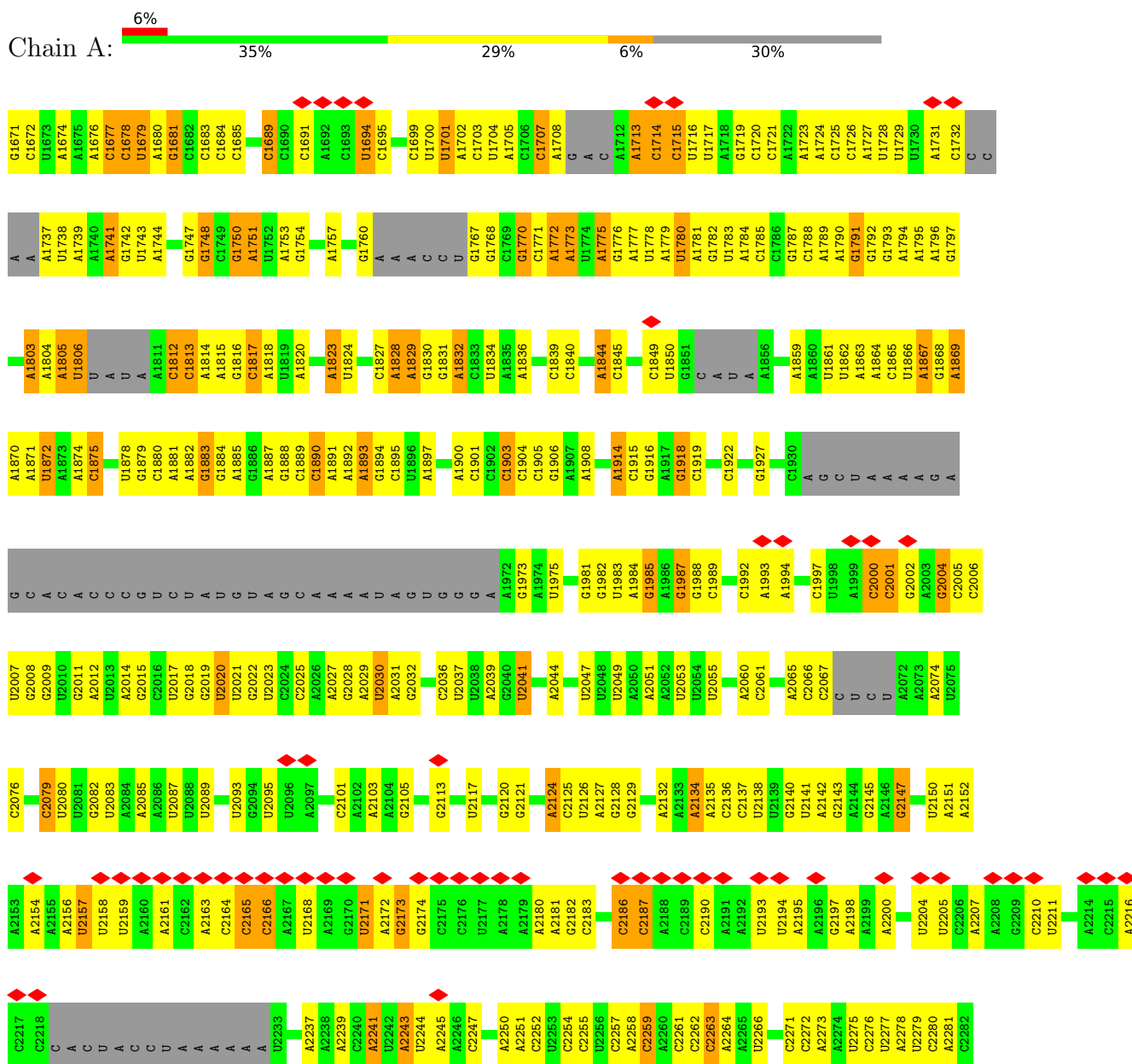

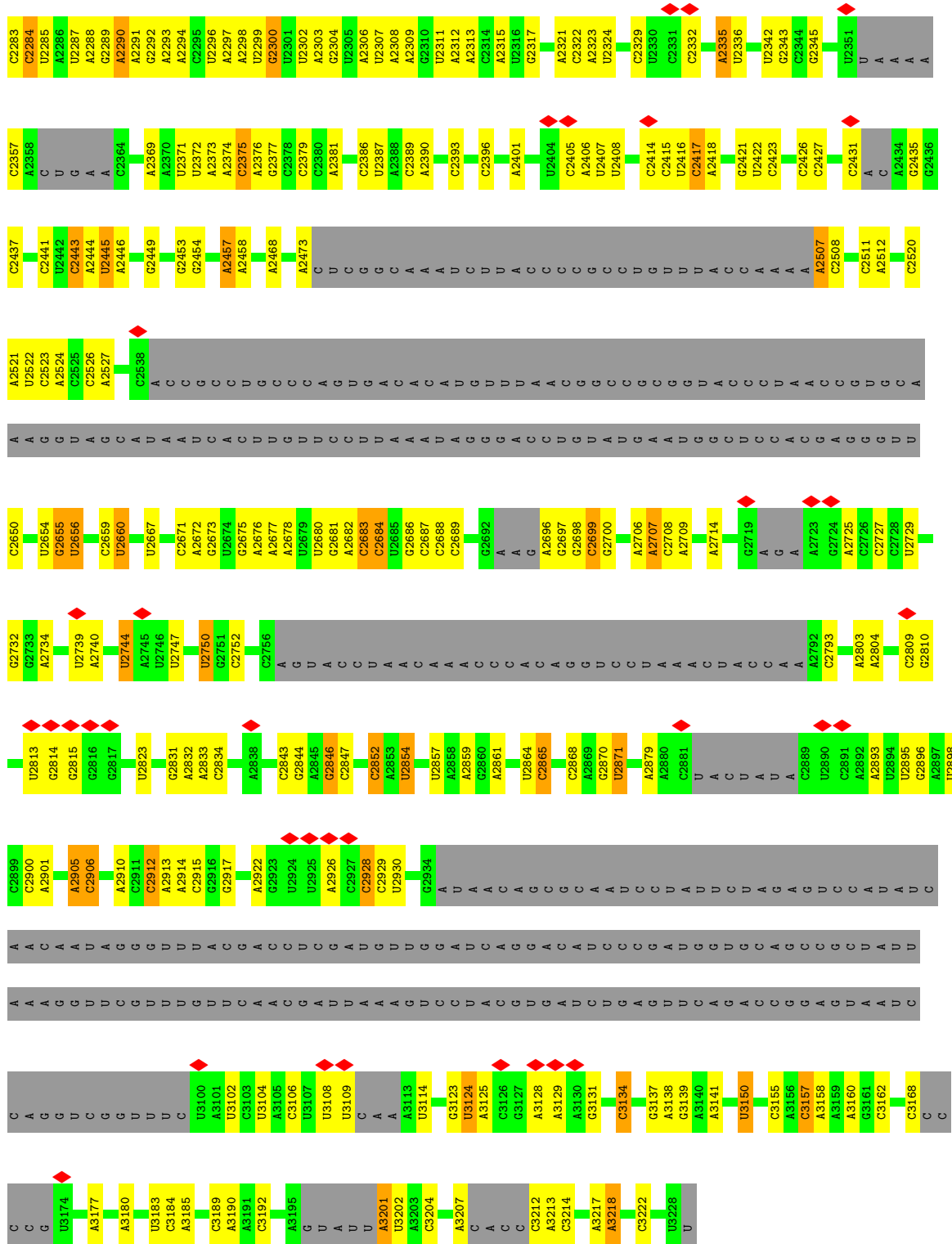

● Molecule 2: mitochondrial tRNAVal



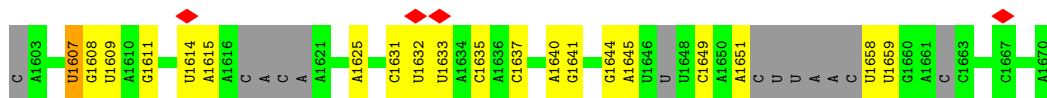

• Molecule 3: 39S ribosomal protein L2, mitochondrial

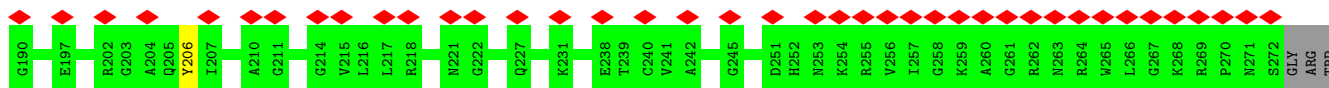
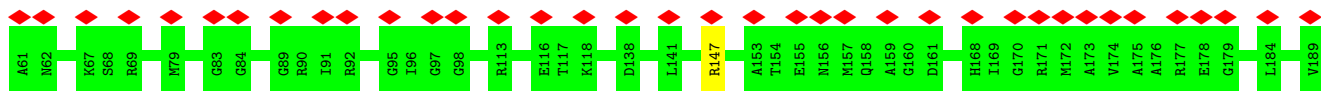
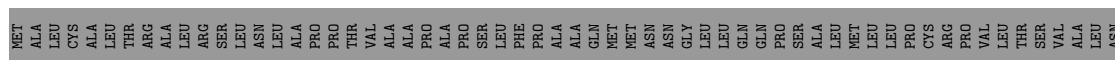

• Molecule 4: 39S ribosomal protein L3, mitochondrial

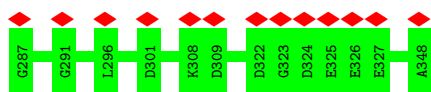
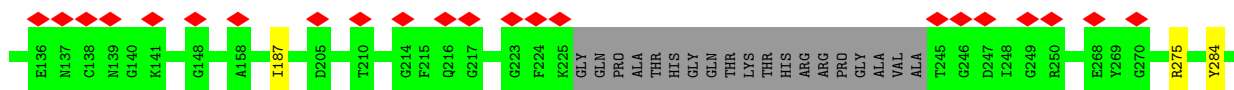
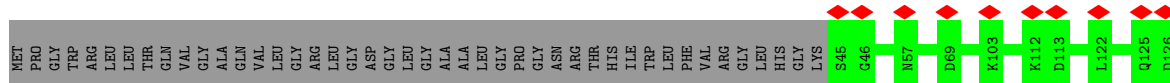
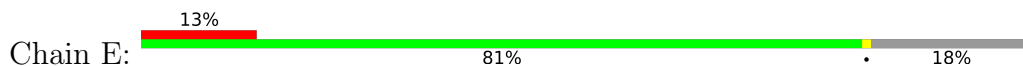

• Molecule 5: 39S ribosomal protein L4, mitochondrial

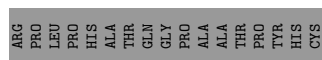
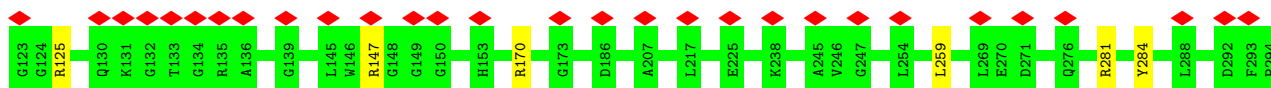
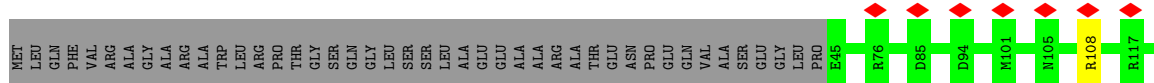
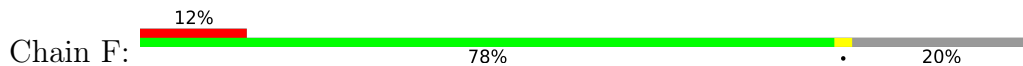

• Molecule 6: 39S ribosomal protein L9, mitochondrial

ALA
ASP
LEU
ALA
ALA
GLN
GLU
GLU
ALA
ALA
LYS
LYS

- Molecule 9: 39S ribosomal protein L13, mitochondrial

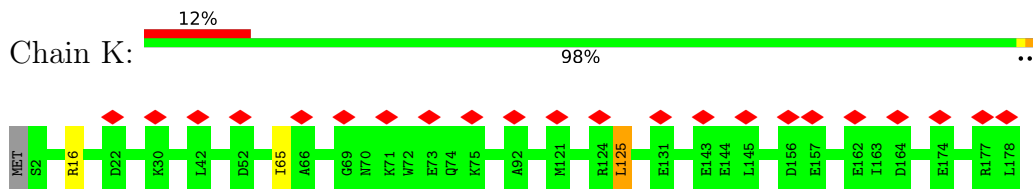

- Molecule 10: 39S ribosomal protein L14, mitochondrial

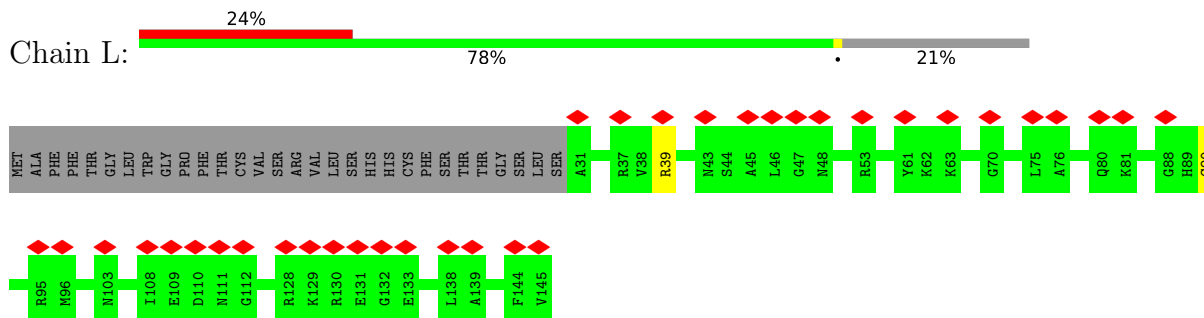

- Molecule 11: 39S ribosomal protein L15, mitochondrial

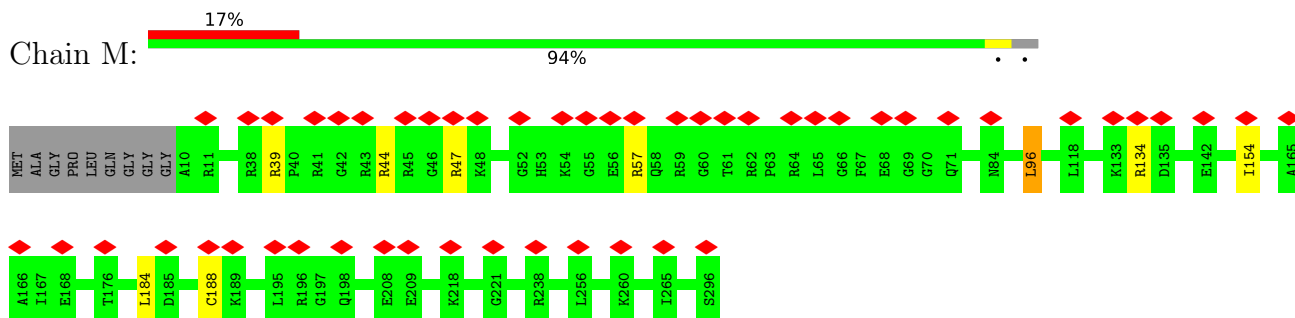

- Molecule 12: 39S ribosomal protein L16, mitochondrial

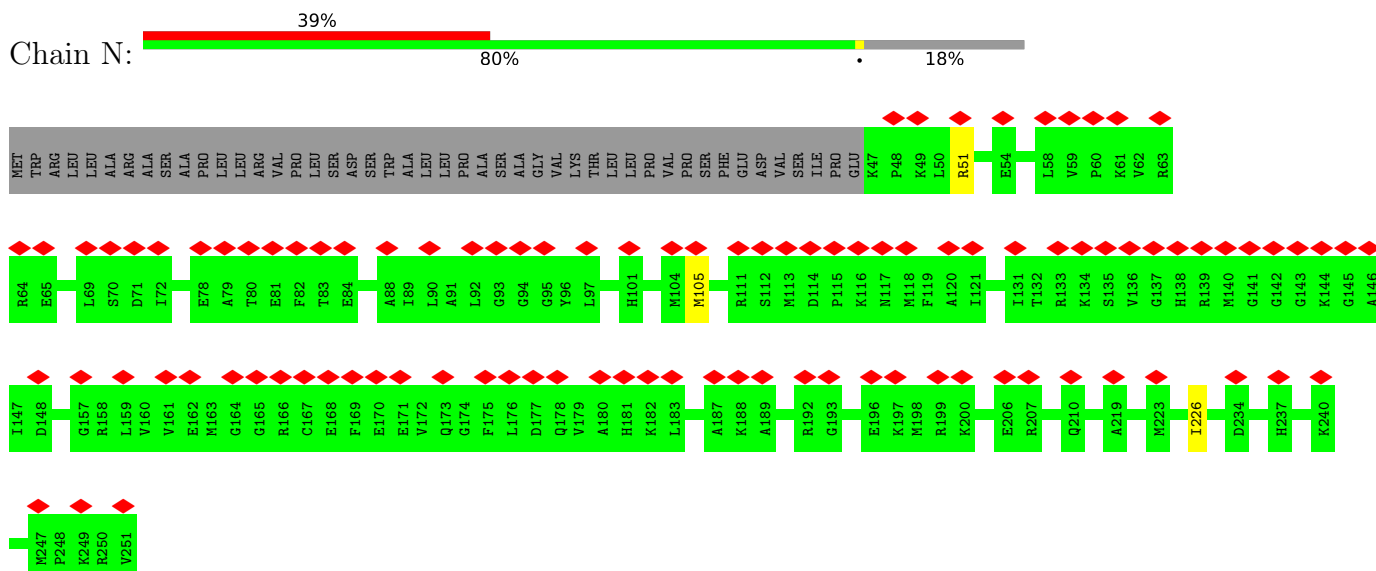

• Molecule 13: 39S ribosomal protein L17, mitochondrial

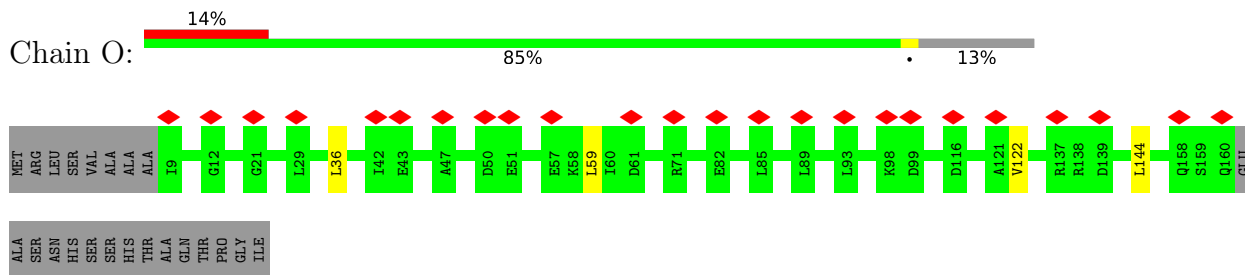

• Molecule 14: 39S ribosomal protein L18, mitochondrial

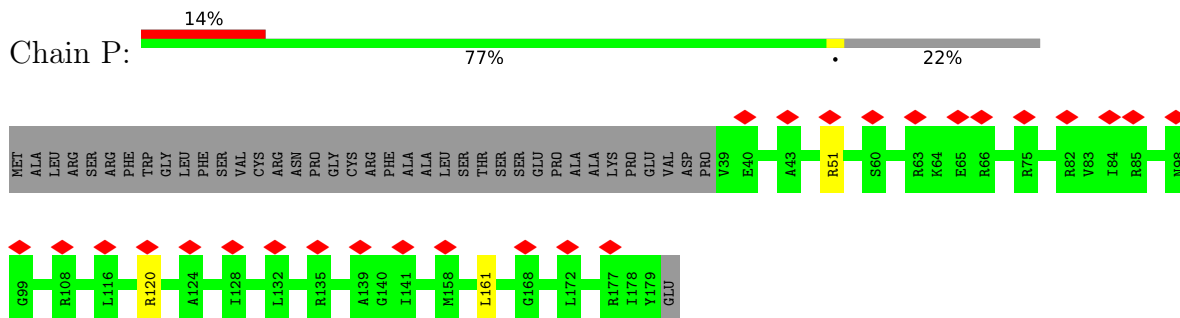

• Molecule 15: 39S ribosomal protein L19, mitochondrial

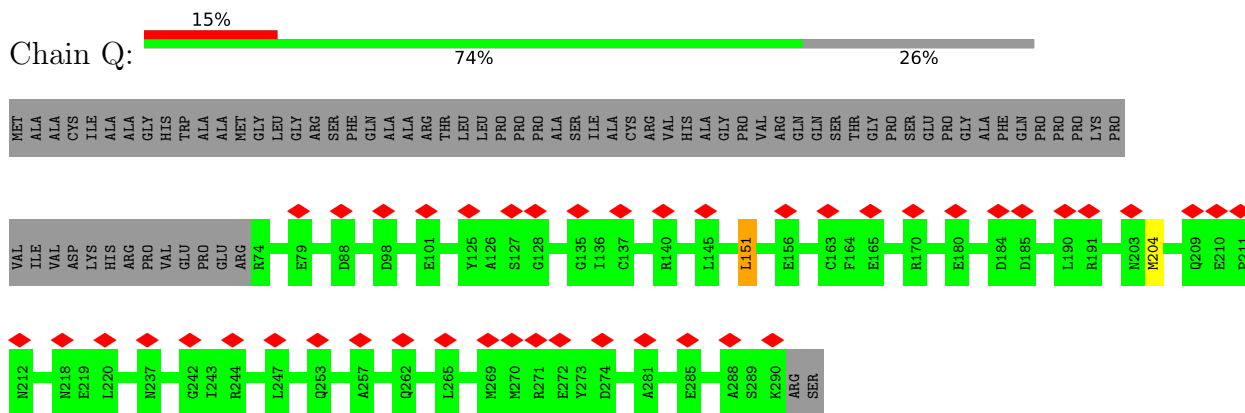

• Molecule 16: 39S ribosomal protein L20, mitochondrial

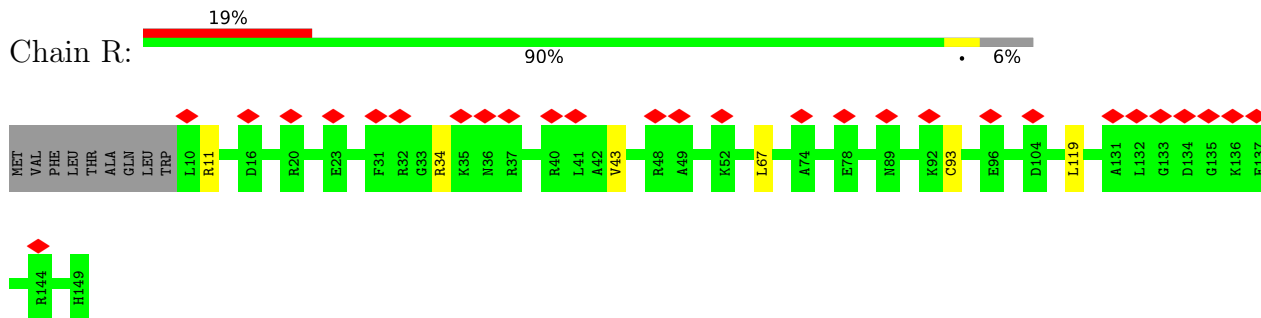

• Molecule 17: 39S ribosomal protein L21, mitochondrial

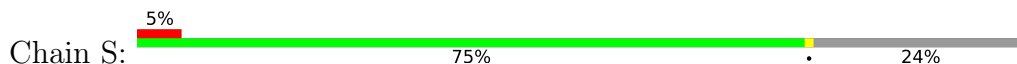

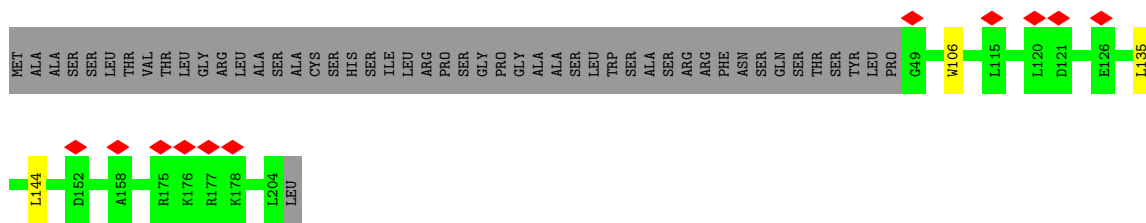

- Molecule 18: 39S ribosomal protein L22, mitochondrial

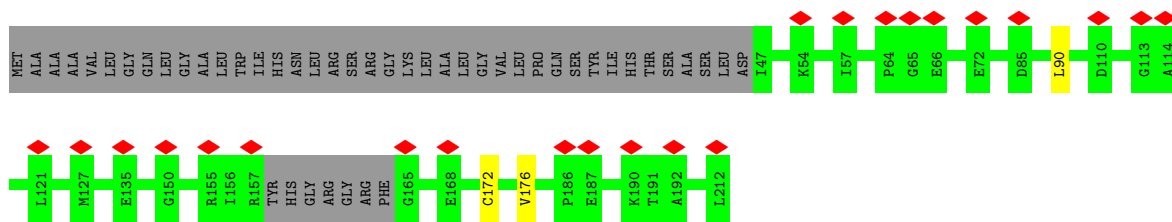
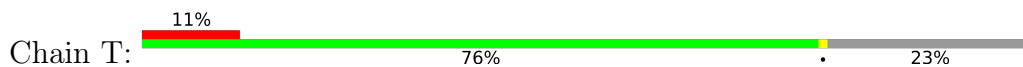

- Molecule 19: 39S ribosomal protein L23, mitochondrial

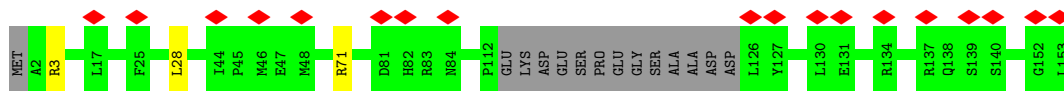
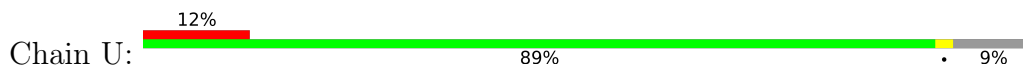

- Molecule 20: 39S ribosomal protein L24, mitochondrial

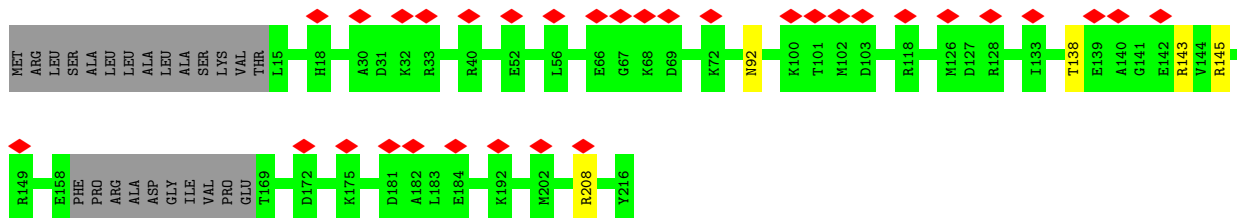
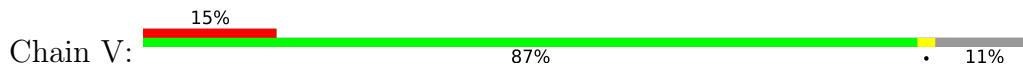

- Molecule 21: 39S ribosomal protein L27, mitochondrial

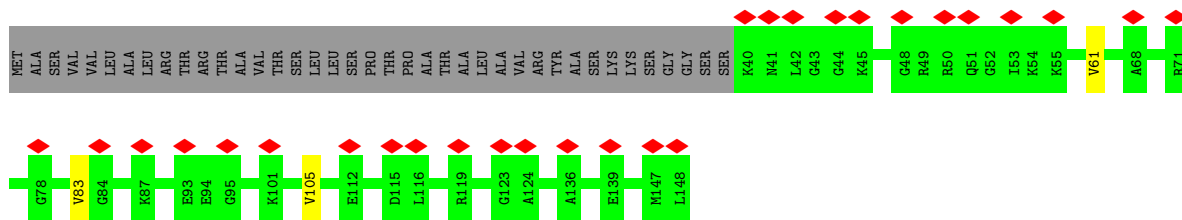
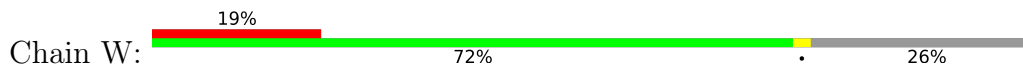

- Molecule 22: 39S ribosomal protein L28, mitochondrial

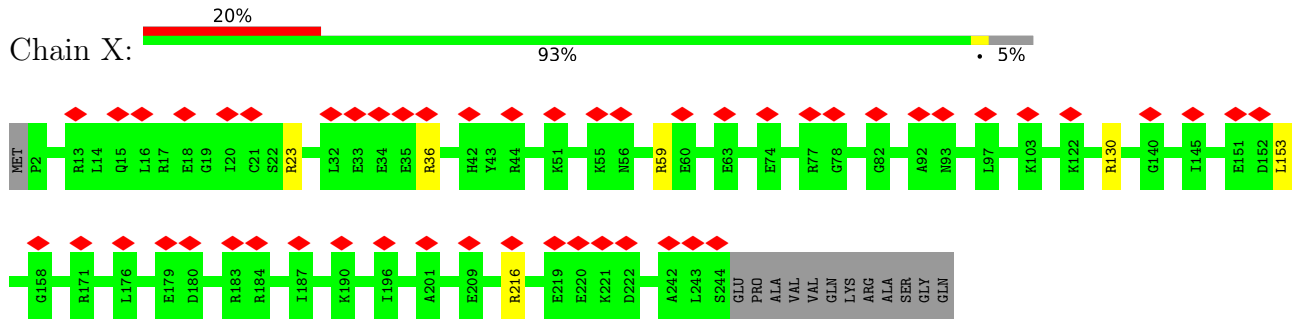

- Molecule 23: 39S ribosomal protein L47, mitochondrial

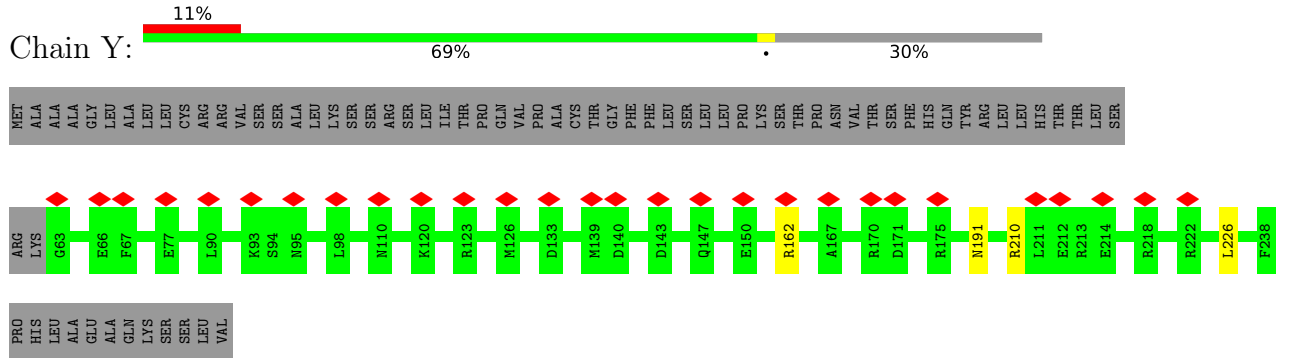

- Molecule 24: 39S ribosomal protein L30, mitochondrial

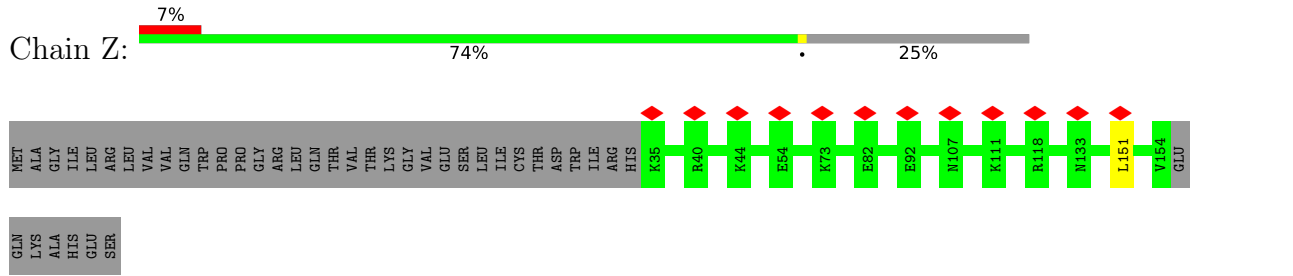

- Molecule 25: 39S ribosomal protein L32, mitochondrial

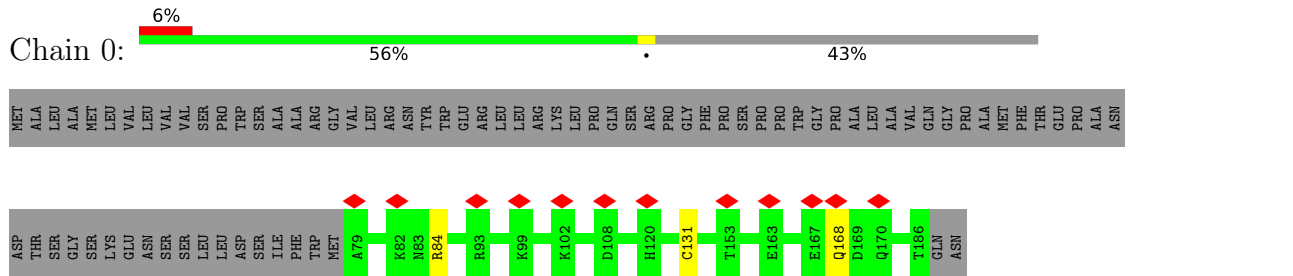

- Molecule 26: 39S ribosomal protein L33, mitochondrial

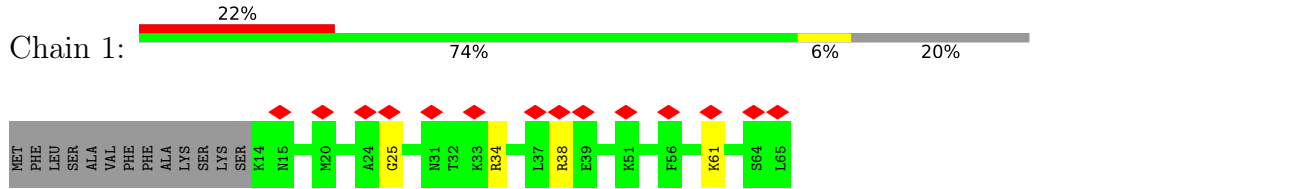

- Molecule 27: 39S ribosomal protein L34, mitochondrial

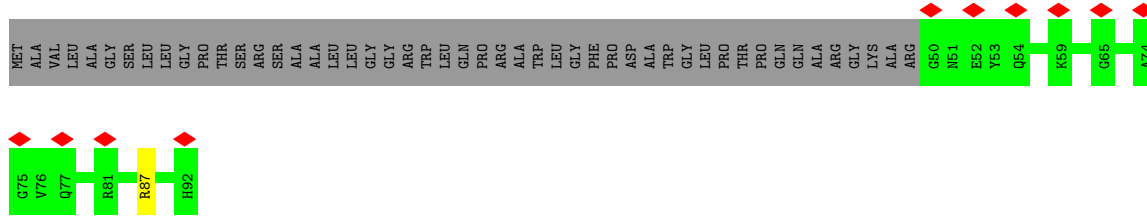

- Molecule 28: 39S ribosomal protein L35, mitochondrial

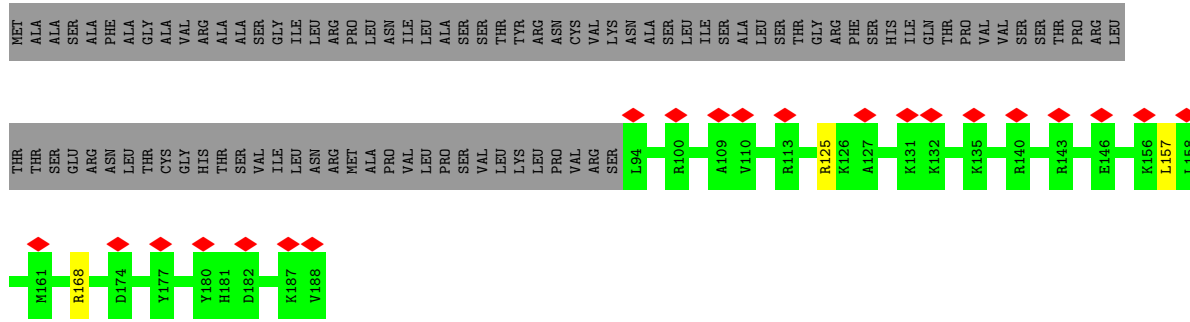

- Molecule 29: 39S ribosomal protein L37, mitochondrial

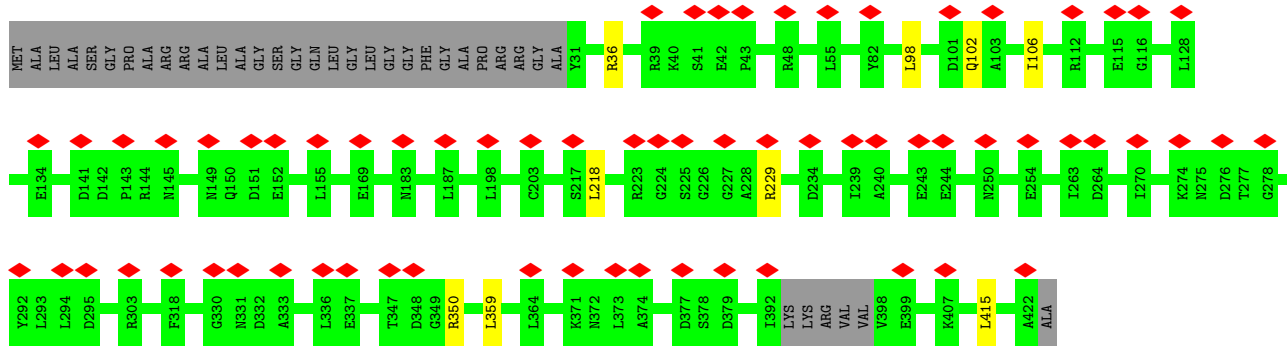
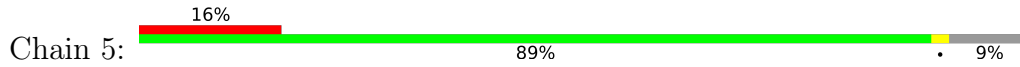

- Molecule 30: 39S ribosomal protein L38, mitochondrial

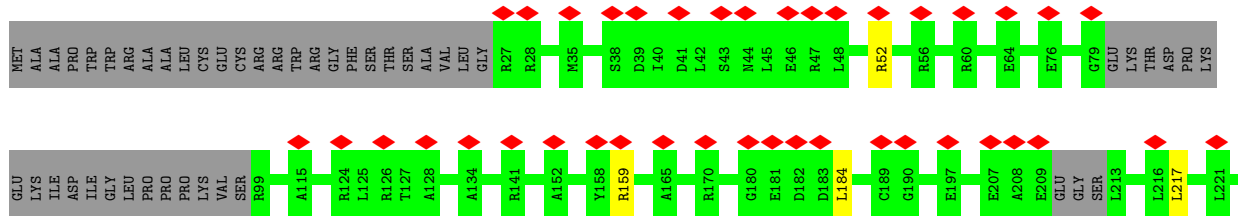
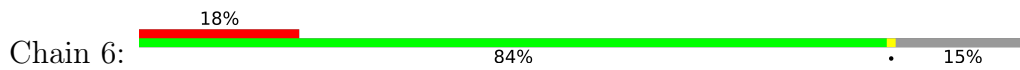

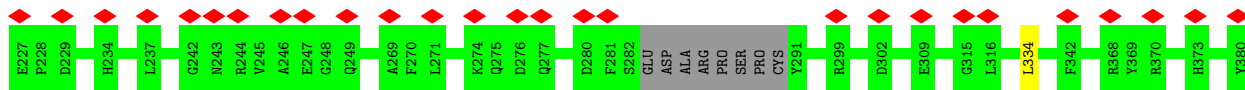

• Molecule 31: 39S ribosomal protein L39, mitochondrial

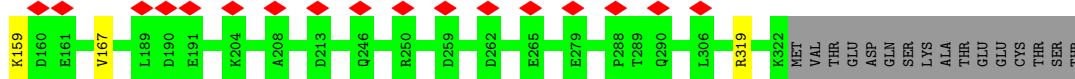
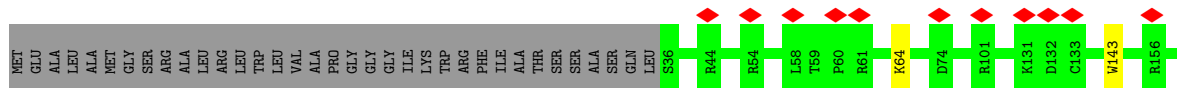
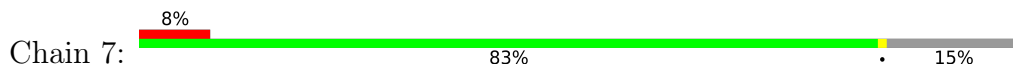

• Molecule 32: 39S ribosomal protein L40, mitochondrial

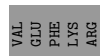
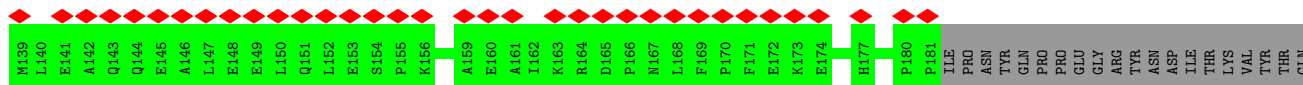
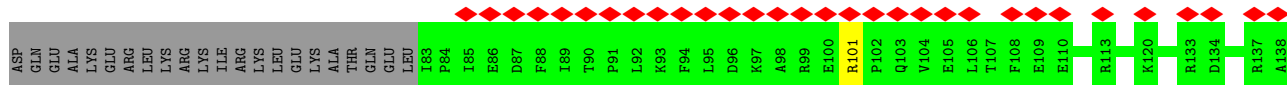
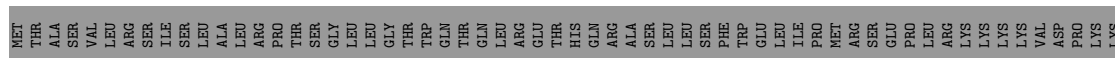

• Molecule 33: 39S ribosomal protein L41, mitochondrial

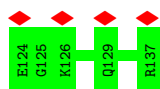
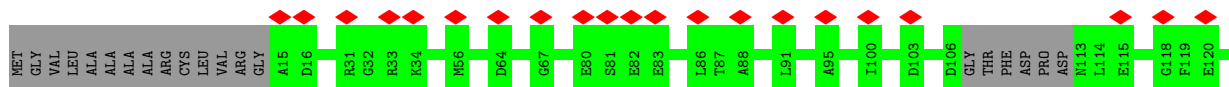
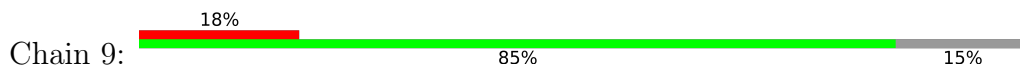

• Molecule 34: 39S ribosomal protein L42, mitochondrial

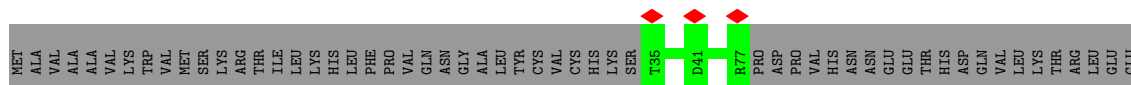

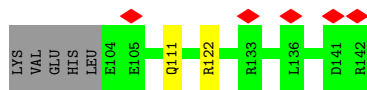

• Molecule 35: 39S ribosomal protein L43, mitochondrial

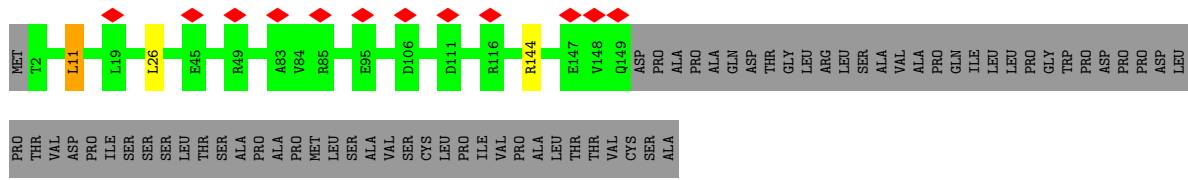

• Molecule 36: 39S ribosomal protein L44, mitochondrial

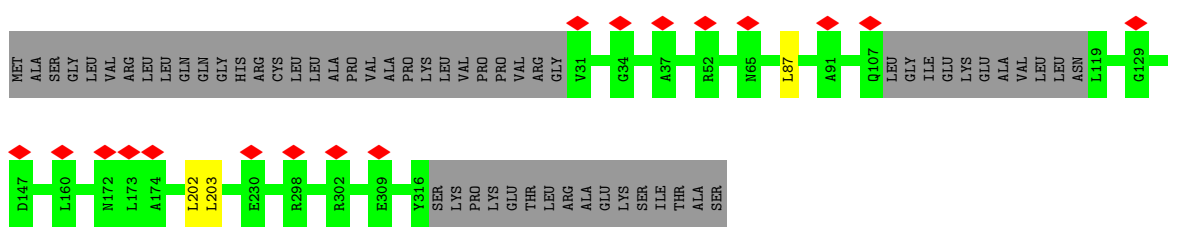
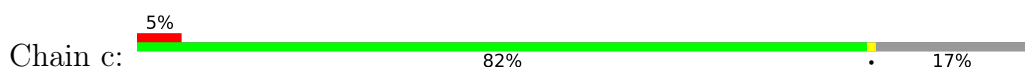

• Molecule 37: 39S ribosomal protein L45, mitochondrial

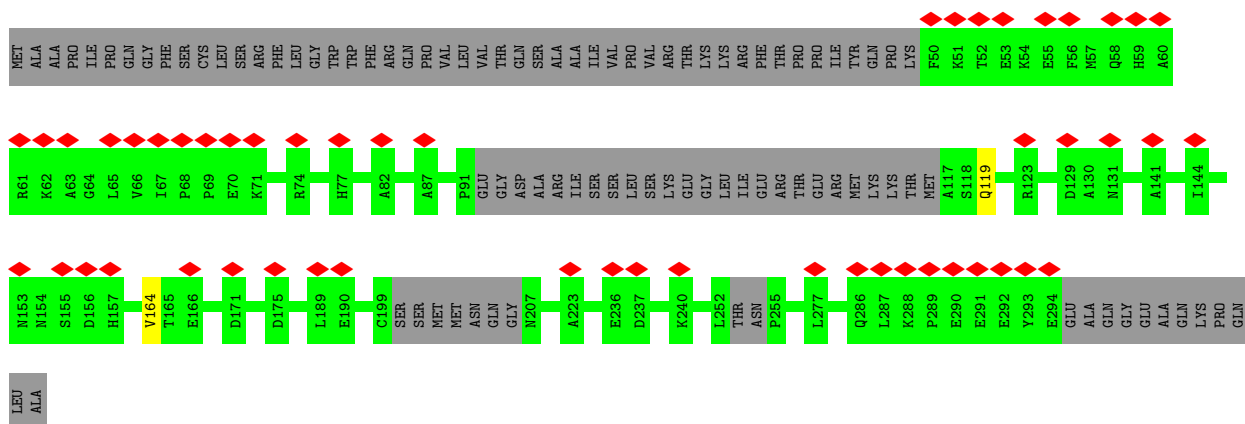

• Molecule 38: 39S ribosomal protein L46, mitochondrial

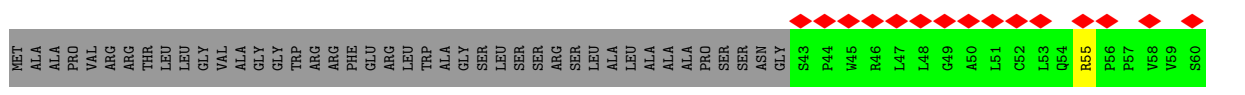
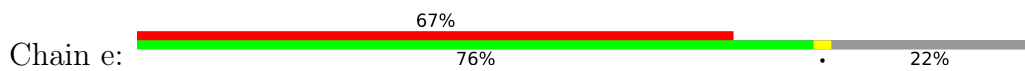

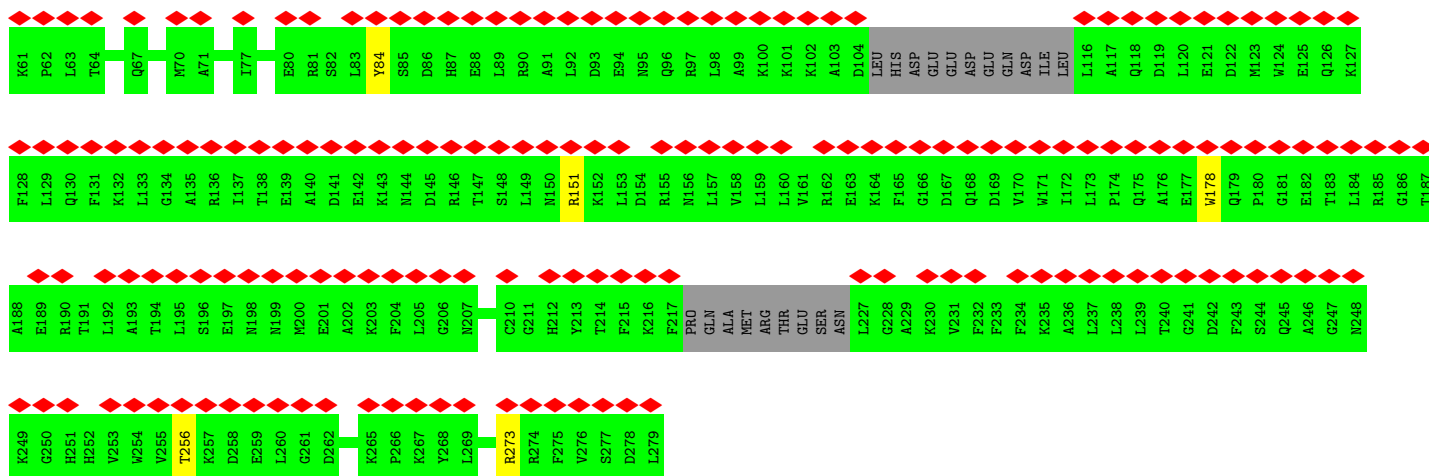

• Molecule 39: 39S ribosomal protein L48, mitochondrial

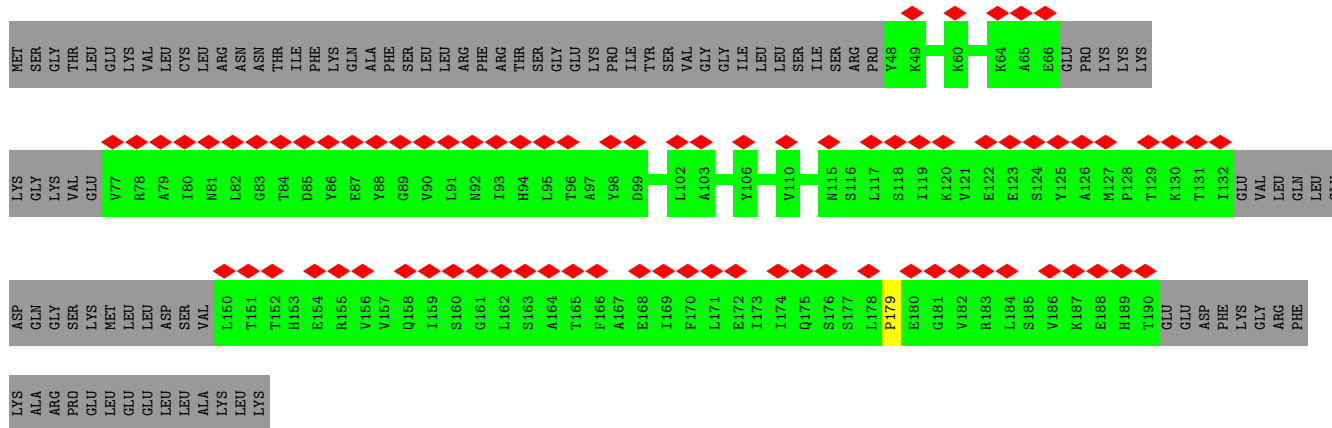
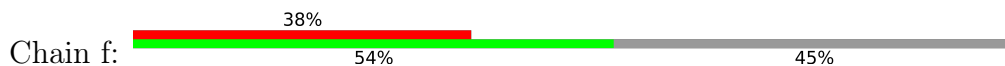

• Molecule 40: 39S ribosomal protein L49, mitochondrial

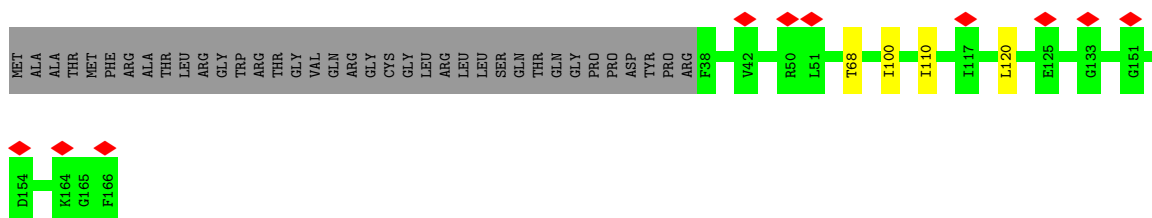
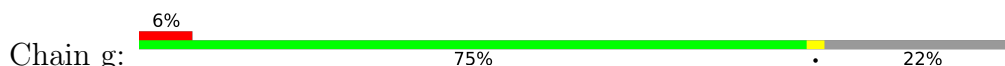

• Molecule 41: 39S ribosomal protein L50, mitochondrial

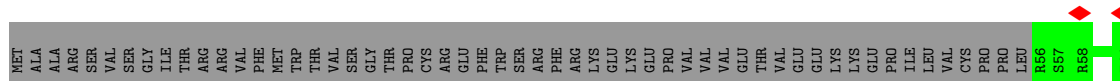

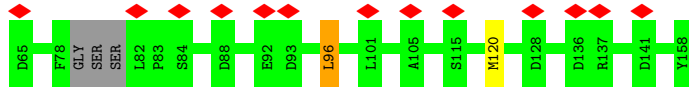

• Molecule 42: 39S ribosomal protein L51, mitochondrial

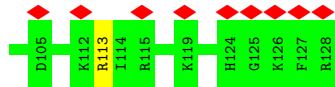
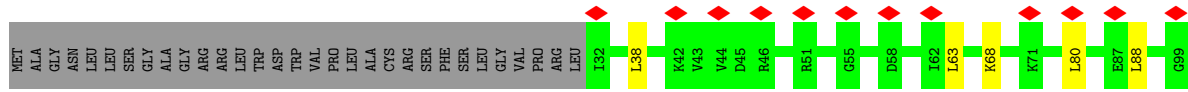

• Molecule 43: 39S ribosomal protein L52, mitochondrial

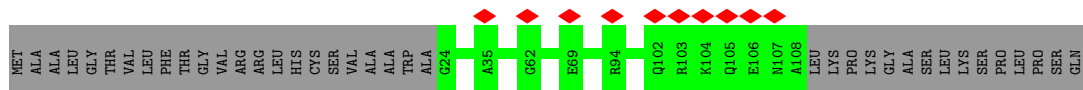

• Molecule 44: 39S ribosomal protein L53, mitochondrial

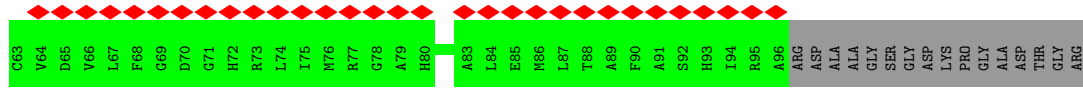
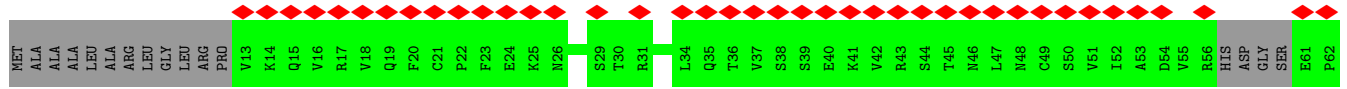

• Molecule 45: 39S ribosomal protein L54, mitochondrial

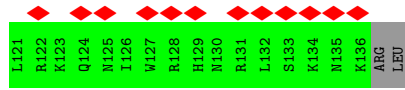
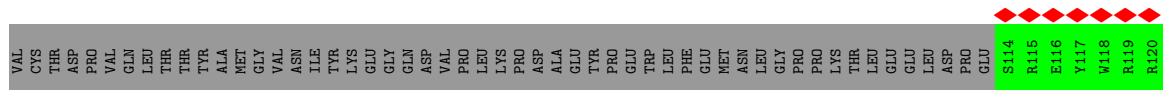
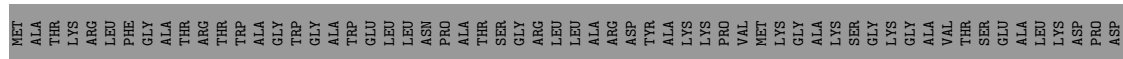

• Molecule 46: 39S ribosomal protein L55, mitochondrial

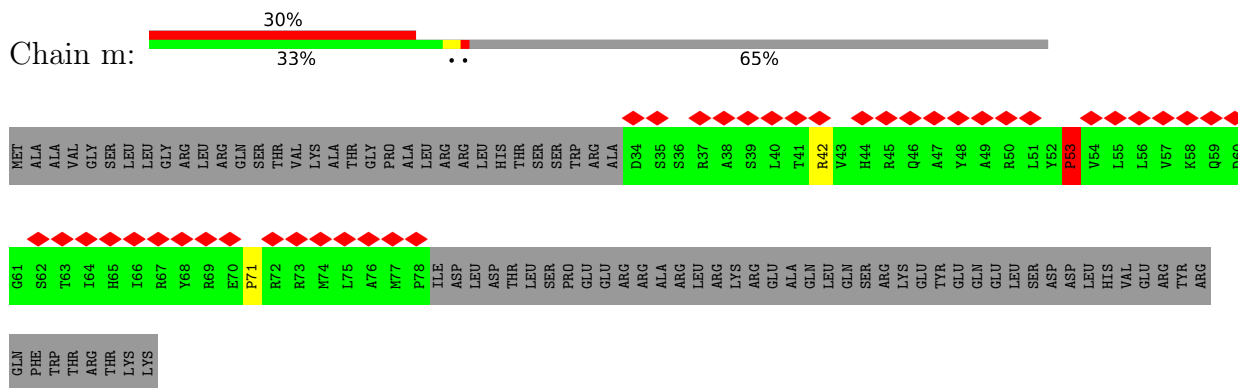

• Molecule 47: Ribosomal protein 63, mitochondrial

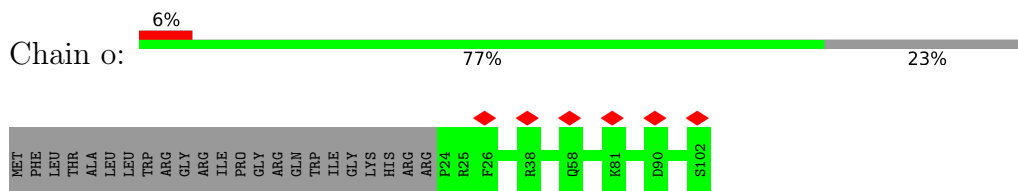

• Molecule 48: Peptidyl-tRNA hydrolase ICT1, mitochondrial

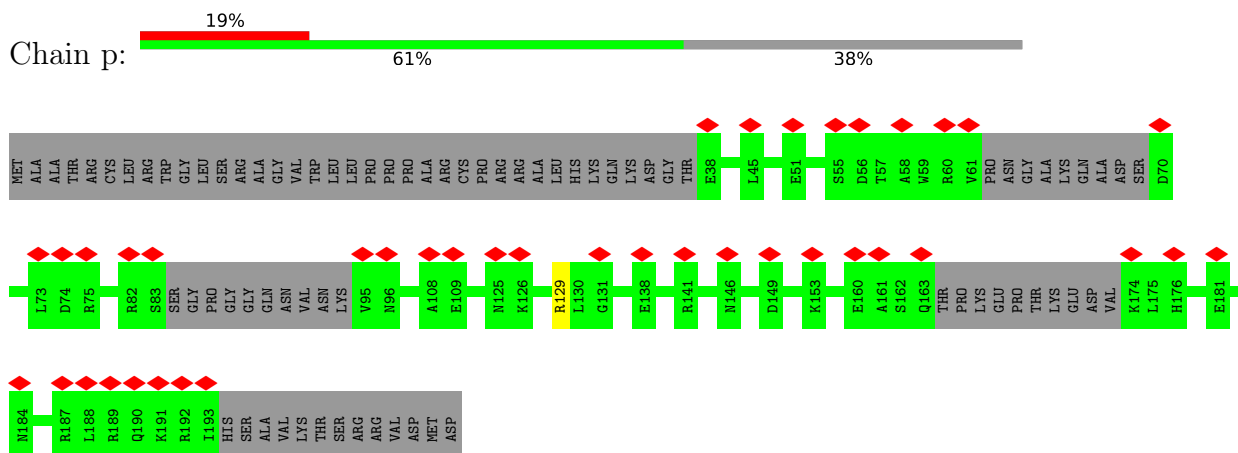

• Molecule 49: Growth arrest and DNA damage-inducible proteins-interacting protein 1

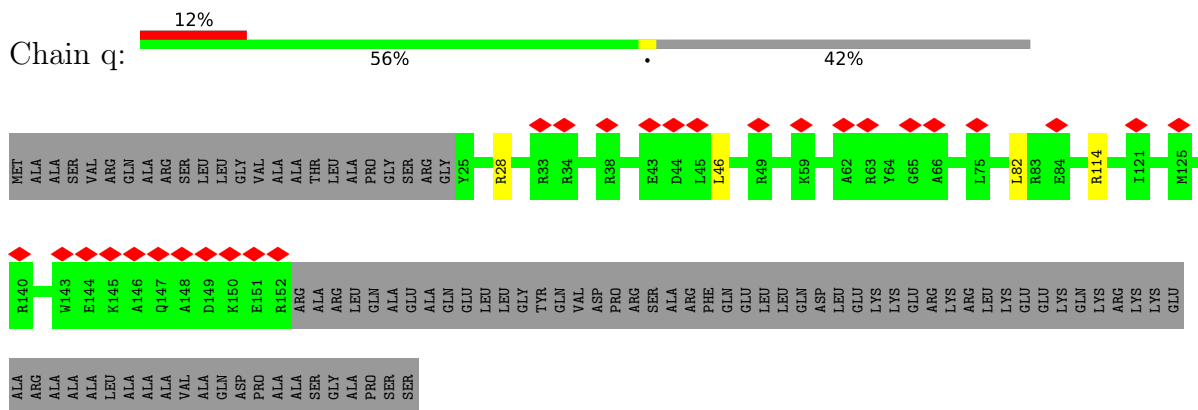

• Molecule 50: 39S ribosomal protein S18a, mitochondrial

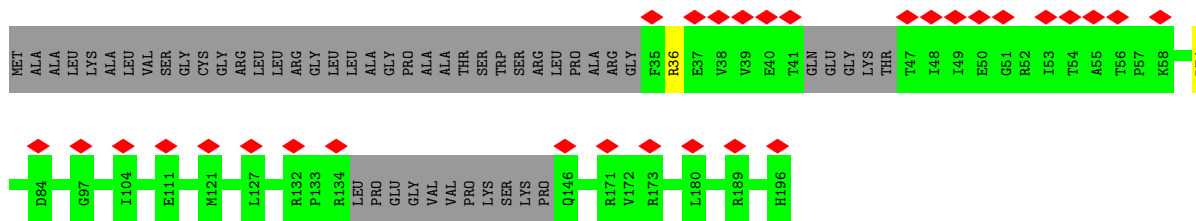

• Molecule 51: 39S ribosomal protein S30, mitochondrial

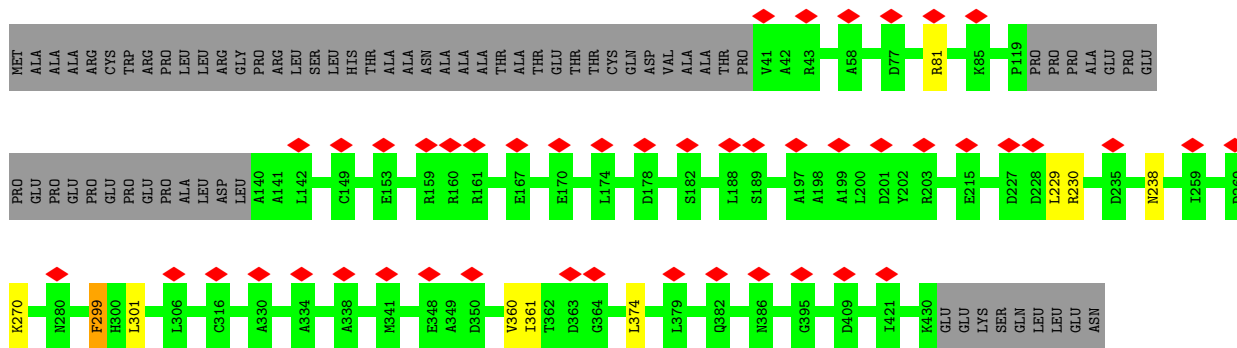
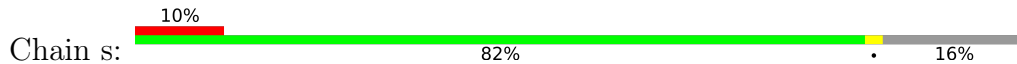

• Molecule 52: Unknown protein or protein extension

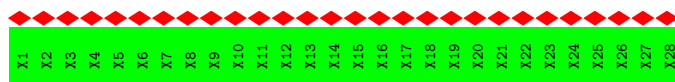

• Molecule 53: Mitochondrial assembly of ribosomal large subunit protein 1

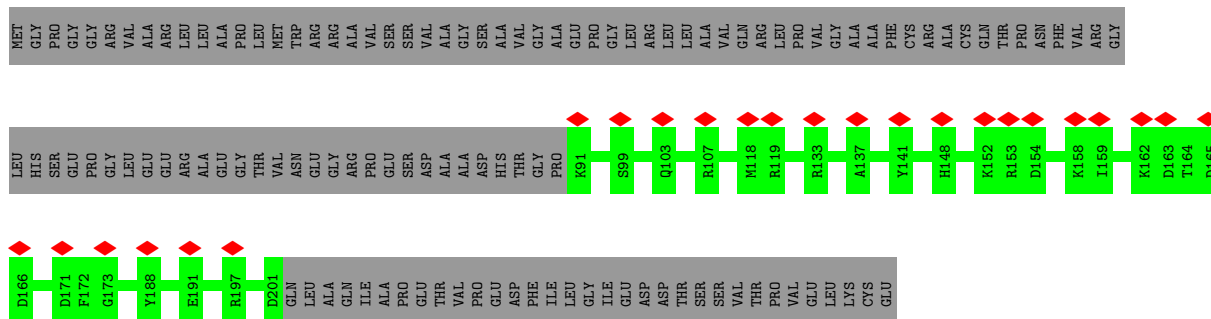

• Molecule 54: MIEF1 upstream open reading frame protein



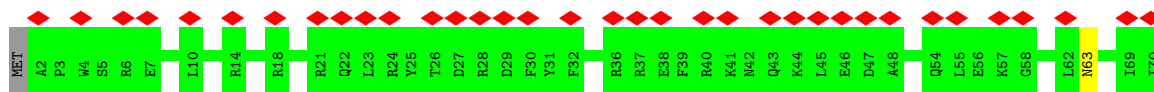

- Molecule 55: Acyl carrier protein, mitochondrial

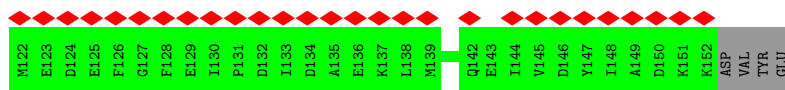
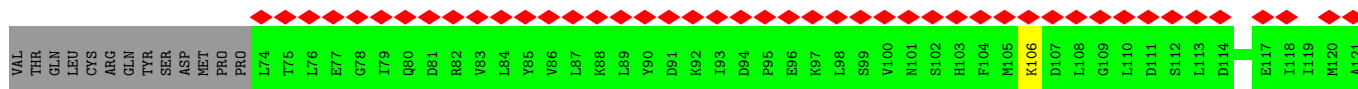

4 Experimental information

Property	Value	Source
EM reconstruction method	SINGLE PARTICLE	Depositor
Imposed symmetry	POINT, C1	Depositor
Number of particles used	379869	Depositor
Resolution determination method	FSC 0.143 CUT-OFF	Depositor
CTF correction method	PHASE FLIPPING AND AMPLITUDE CORRECTION	Depositor
Microscope	FEI TITAN KRIOS	Depositor
Voltage (kV)	300	Depositor
Electron dose ($e^-/\text{\AA}^2$)	1.56	Depositor
Minimum defocus (nm)	Not provided	
Maximum defocus (nm)	Not provided	
Magnification	130841	Depositor
Image detector	FEI FALCON II (4k x 4k)	Depositor
Maximum map value	0.350	Depositor
Minimum map value	-0.156	Depositor
Average map value	0.002	Depositor
Map value standard deviation	0.013	Depositor
Recommended contour level	0.075	Depositor
Map size (Å)	373.12, 373.12, 373.12	wwPDB
Map dimensions	352, 352, 352	wwPDB
Map angles (°)	90.0, 90.0, 90.0	wwPDB
Pixel spacing (Å)	1.06, 1.06, 1.06	Depositor

5 Model quality i

5.1 Standard geometry i

Bond lengths and bond angles in the following residue types are not validated in this section: PNS, ZN, MG

The Z score for a bond length (or angle) is the number of standard deviations the observed value is removed from the expected value. A bond length (or angle) with $|Z| > 5$ is considered an outlier worth inspection. RMSZ is the root-mean-square of all Z scores of the bond lengths (or angles).

Mol	Chain	Bond lengths		Bond angles	
		RMSZ	# Z >5	RMSZ	# Z >5
1	A	1.77	301/25926 (1.2%)	1.45	433/40305 (1.1%)
2	B	0.71	0/1328	1.26	10/2056 (0.5%)
3	D	0.58	0/1736	0.65	0/2335
4	E	0.74	0/2322	0.71	1/3148 (0.0%)
5	F	0.94	1/2071 (0.0%)	0.81	0/2817
6	H	0.65	0/798	0.71	0/1073
7	I	0.41	0/1308	0.68	2/1761 (0.1%)
8	J	0.30	0/1077	0.58	0/1452
9	K	0.84	0/1495	0.76	2/2029 (0.1%)
10	L	0.51	0/904	0.63	1/1218 (0.1%)
11	M	0.88	1/2359 (0.0%)	0.80	4/3185 (0.1%)
12	N	0.56	0/1697	0.63	0/2281
13	O	0.84	1/1269 (0.1%)	0.83	2/1708 (0.1%)
14	P	0.68	0/1173	0.71	1/1588 (0.1%)
15	Q	0.60	1/1846 (0.1%)	0.69	2/2487 (0.1%)
16	R	1.04	3/1174 (0.3%)	0.89	5/1572 (0.3%)
17	S	0.91	1/1276 (0.1%)	0.82	2/1729 (0.1%)
18	T	1.00	1/1335 (0.1%)	0.76	2/1796 (0.1%)
19	U	0.87	0/1183	0.78	1/1600 (0.1%)
20	V	0.73	0/1616	0.64	0/2189
21	W	0.92	2/881 (0.2%)	0.72	0/1188
22	X	0.68	0/2090	0.69	1/2825 (0.0%)
23	Y	0.83	0/1552	0.71	1/2079 (0.0%)
24	Z	0.82	1/1003 (0.1%)	0.74	0/1354
25	0	0.85	1/895 (0.1%)	0.74	0/1201
26	1	0.63	0/438	0.81	0/583
27	2	1.05	1/357 (0.3%)	0.84	0/475
28	3	1.03	0/852	0.79	1/1136 (0.1%)
29	5	0.65	0/3250	0.70	2/4429 (0.0%)
30	6	0.66	0/2726	0.65	2/3715 (0.1%)
31	7	0.67	1/2391 (0.0%)	0.67	0/3234
32	8	0.39	0/855	0.55	0/1152

Mol	Chain	Bond lengths		Bond angles	
		RMSZ	# Z >5	RMSZ	# Z >5
33	9	0.75	0/972	0.68	0/1306
34	a	0.84	0/709	0.65	0/963
35	b	0.92	0/1202	0.78	2/1626 (0.1%)
36	c	0.78	0/2264	0.71	1/3059 (0.0%)
37	d	0.64	0/1790	0.66	0/2423
38	e	0.30	0/1797	0.59	2/2422 (0.1%)
39	f	0.47	0/931	0.58	0/1259
40	g	0.91	0/1102	0.77	1/1503 (0.1%)
41	h	0.63	0/847	0.71	1/1150 (0.1%)
42	i	1.05	1/849 (0.1%)	0.87	5/1135 (0.4%)
43	j	0.75	0/698	0.64	0/940
44	k	0.32	0/635	0.60	0/855
45	l	0.29	0/226	0.43	0/299
46	m	0.29	0/379	0.75	1/510 (0.2%)
47	o	0.74	0/682	0.66	0/916
48	p	0.53	0/1071	0.62	0/1433
49	q	0.58	0/1107	0.59	0/1498
50	r	0.69	0/1238	0.67	0/1676
51	s	0.80	0/3114	0.77	5/4225 (0.1%)
53	u	0.40	0/949	0.59	0/1281
54	v	0.35	0/597	0.58	0/796
55	w	0.31	0/647	0.61	0/871
All	All	1.11	317/94989 (0.3%)	1.00	493/133846 (0.4%)

Chiral center outliers are detected by calculating the chiral volume of a chiral center and verifying if the center is modelled as a planar moiety or with the opposite hand. A planarity outlier is detected by checking planarity of atoms in a peptide group, atoms in a mainchain group or atoms of a sidechain that are expected to be planar.

Mol	Chain	#Chirality outliers	#Planarity outliers
8	J	0	1
26	1	0	1
31	7	0	1
40	g	0	1
46	m	0	1
51	s	0	1
All	All	0	6

All (317) bond length outliers are listed below:

Mol	Chain	Res	Type	Atoms	Z	Observed(Å)	Ideal(Å)
1	A	1789	A	N9-C4	-9.69	1.32	1.37

Continued on next page...

Continued from previous page...

Mol	Chain	Res	Type	Atoms	Z	Observed(Å)	Ideal(Å)
1	A	2308	A	N9-C4	-8.74	1.32	1.37
1	A	1751	A	N9-C8	-7.99	1.31	1.37
1	A	1864	A	C5-C4	-7.96	1.33	1.38
42	i	68	LYS	C-N	-7.79	1.16	1.34
1	A	2152	A	N9-C4	-7.70	1.33	1.37
1	A	1818	A	N9-C4	-7.56	1.33	1.37
1	A	2004	G	N7-C5	-7.40	1.34	1.39
1	A	1785	C	C4-C5	-7.31	1.37	1.43
24	Z	151	LEU	C-N	-7.25	1.17	1.34
1	A	2051	A	N9-C4	-7.18	1.33	1.37
1	A	1772	A	C5-C4	-7.14	1.33	1.38
1	A	2307	U	C2-N3	-7.07	1.32	1.37
1	A	1787	G	C5-C4	-6.95	1.33	1.38
1	A	1864	A	N9-C4	-6.84	1.33	1.37
1	A	1680	A	N7-C5	-6.82	1.35	1.39
1	A	1866	U	C2-N3	-6.80	1.32	1.37
1	A	1828	A	N7-C5	-6.79	1.35	1.39
1	A	1916	G	C5-C4	-6.74	1.33	1.38
1	A	1773	A	N9-C4	-6.69	1.33	1.37
1	A	1790	A	N9-C4	-6.69	1.33	1.37
1	A	2292	G	N9-C8	-6.68	1.33	1.37
1	A	2673	G	C5-C4	-6.68	1.33	1.38
1	A	1983	U	C2-N3	-6.66	1.33	1.37
1	A	1683	C	N3-C4	-6.65	1.29	1.33
1	A	2675	G	C5-C4	-6.64	1.33	1.38
1	A	2373	A	N9-C4	-6.61	1.33	1.37
1	A	1984	A	N9-C4	-6.58	1.33	1.37
1	A	2138	U	C2-N3	-6.55	1.33	1.37
1	A	1900	A	N9-C4	-6.54	1.33	1.37
1	A	1770	G	C2-N3	-6.54	1.27	1.32
1	A	1831	G	C5-C4	-6.54	1.33	1.38
1	A	1793	G	C6-N1	-6.53	1.34	1.39
1	A	1744	A	N7-C5	-6.51	1.35	1.39
1	A	1771	C	N3-C4	-6.51	1.29	1.33
1	A	2302	U	C2-N3	-6.48	1.33	1.37
1	A	2294	A	N9-C4	-6.47	1.33	1.37
1	A	2289	G	C5-C4	-6.46	1.33	1.38
1	A	1904	C	N1-C6	-6.44	1.33	1.37
13	O	122	VAL	CB-CG2	-6.42	1.39	1.52
1	A	2292	G	N7-C5	-6.42	1.35	1.39
1	A	1747	G	C5-C4	-6.41	1.33	1.38
1	A	2276	C	N1-C6	-6.41	1.33	1.37

Continued on next page...

Continued from previous page...

Mol	Chain	Res	Type	Atoms	Z	Observed(Å)	Ideal(Å)
1	A	1678	C	N1-C6	-6.39	1.33	1.37
1	A	2276	C	N3-C4	-6.38	1.29	1.33
1	A	1984	A	C5-C4	-6.37	1.34	1.38
1	A	2298	A	N7-C5	-6.36	1.35	1.39
1	A	1754	G	N1-C2	-6.33	1.32	1.37
1	A	1897	A	N9-C4	-6.33	1.34	1.37
1	A	2009	G	N7-C5	-6.32	1.35	1.39
1	A	1867	A	N7-C5	-6.31	1.35	1.39
1	A	1793	G	C5-C4	-6.30	1.33	1.38
1	A	1793	G	N1-C2	-6.29	1.32	1.37
1	A	1803	A	N9-C4	-6.28	1.34	1.37
1	A	1884	G	N9-C4	-6.24	1.32	1.38
1	A	2288	A	N7-C5	-6.23	1.35	1.39
1	A	1879	G	C8-N7	-6.22	1.27	1.30
1	A	1916	G	N7-C5	-6.21	1.35	1.39
1	A	2150	U	C2-N3	-6.20	1.33	1.37
1	A	1789	A	C5-C4	-6.19	1.34	1.38
1	A	1828	A	C5-C4	-6.19	1.34	1.38
1	A	1914	A	N7-C5	-6.16	1.35	1.39
1	A	2292	G	C8-N7	-6.14	1.27	1.30
1	A	2312	A	C5-C4	-6.14	1.34	1.38
1	A	2276	C	C4-C5	-6.12	1.38	1.43
1	A	1792	G	C5-C4	-6.10	1.34	1.38
1	A	1787	G	N7-C5	-6.08	1.35	1.39
1	A	1879	G	N7-C5	-6.08	1.35	1.39
1	A	2019	G	N9-C8	-6.06	1.33	1.37
1	A	1880	C	N3-C4	-6.03	1.29	1.33
1	A	1884	G	C5-C4	-6.02	1.34	1.38
1	A	1867	A	N9-C4	-6.00	1.34	1.37
1	A	1792	G	N1-C2	-5.99	1.32	1.37
16	R	43	VAL	CB-CG2	-5.98	1.40	1.52
1	A	2020	U	C2-N3	-5.98	1.33	1.37
1	A	1775	A	C5-C4	-5.98	1.34	1.38
1	A	1796	A	N9-C4	-5.98	1.34	1.37
31	7	143	TRP	CB-CG	-5.97	1.39	1.50
1	A	1908	A	N9-C4	-5.96	1.34	1.37
1	A	2681	G	N9-C8	-5.96	1.33	1.37
1	A	2421	G	C5-C4	-5.94	1.34	1.38
1	A	1683	C	N1-C6	-5.92	1.33	1.37
18	T	172	CYS	CB-SG	-5.92	1.72	1.81
1	A	1844	A	N9-C4	-5.91	1.34	1.37
1	A	1739	A	N9-C4	-5.89	1.34	1.37

Continued on next page...

Continued from previous page...

Mol	Chain	Res	Type	Atoms	Z	Observed(Å)	Ideal(Å)
1	A	1879	G	C5-C4	-5.88	1.34	1.38
1	A	2304	G	N9-C4	-5.88	1.33	1.38
1	A	2308	A	C6-N1	-5.88	1.31	1.35
1	A	2145	G	C6-N1	-5.87	1.35	1.39
1	A	1914	A	N9-C4	-5.86	1.34	1.37
1	A	2343	G	C2-N3	-5.86	1.28	1.32
1	A	2714	A	N9-C4	-5.86	1.34	1.37
1	A	1903	C	N3-C4	-5.85	1.29	1.33
1	A	1775	A	C6-N1	-5.83	1.31	1.35
1	A	2678	A	N7-C5	-5.82	1.35	1.39
1	A	1770	G	N9-C4	-5.81	1.33	1.38
1	A	1679	U	C2-N3	-5.80	1.33	1.37
1	A	1742	G	C5-C4	-5.80	1.34	1.38
1	A	2128	G	C5-C4	-5.77	1.34	1.38
1	A	2454	G	C5-C4	-5.77	1.34	1.38
1	A	2676	A	N7-C5	-5.76	1.35	1.39
1	A	2673	G	N9-C8	-5.76	1.33	1.37
1	A	1830	G	C5-C4	-5.75	1.34	1.38
1	A	2376	A	C5-C4	-5.75	1.34	1.38
1	A	2291	A	N9-C4	-5.74	1.34	1.37
1	A	2372	U	C2-N3	-5.72	1.33	1.37
1	A	2147	G	C6-N1	-5.72	1.35	1.39
1	A	1748	G	N7-C5	-5.71	1.35	1.39
1	A	1680	A	C5-C4	-5.70	1.34	1.38
1	A	1865	C	N3-C4	-5.70	1.29	1.33
1	A	2298	A	N9-C4	-5.70	1.34	1.37
1	A	2684	C	N1-C6	-5.69	1.33	1.37
1	A	2004	G	C5-C4	-5.69	1.34	1.38
1	A	2007	U	C4-C5	-5.69	1.38	1.43
1	A	1988	G	C5-C4	-5.67	1.34	1.38
1	A	1750	G	N7-C5	-5.66	1.35	1.39
1	A	1753	A	C5-C4	-5.66	1.34	1.38
1	A	2655	G	C5-C4	-5.66	1.34	1.38
1	A	1915	C	C4-C5	-5.66	1.38	1.43
1	A	1789	A	N7-C5	-5.66	1.35	1.39
1	A	1751	A	C8-N7	-5.65	1.27	1.31
1	A	2014	A	N9-C4	-5.65	1.34	1.37
1	A	1797	G	C5-C4	-5.65	1.34	1.38
1	A	1741	A	C5-C4	-5.63	1.34	1.38
1	A	2250	A	N9-C4	-5.63	1.34	1.37
25	0	131	CYS	CB-SG	-5.62	1.72	1.81
1	A	1897	A	N7-C5	-5.62	1.35	1.39

Continued on next page...

Continued from previous page...

Mol	Chain	Res	Type	Atoms	Z	Observed(Å)	Ideal(Å)
1	A	2151	A	N7-C5	-5.61	1.35	1.39
1	A	2699	C	N3-C4	-5.61	1.30	1.33
1	A	2700	G	C5-C4	-5.61	1.34	1.38
1	A	1790	A	N7-C5	-5.61	1.35	1.39
1	A	2308	A	N7-C5	-5.61	1.35	1.39
1	A	2676	A	C5-C6	-5.61	1.36	1.41
1	A	1869	A	N9-C4	-5.60	1.34	1.37
1	A	2675	G	N1-C2	-5.59	1.33	1.37
1	A	2129	G	C5-C4	-5.59	1.34	1.38
1	A	2012	A	N7-C5	-5.58	1.35	1.39
1	A	2152	A	C5-C4	-5.58	1.34	1.38
1	A	2290	A	C5-C6	-5.57	1.36	1.41
1	A	2369	A	N9-C4	-5.57	1.34	1.37
1	A	1739	A	C2-N3	-5.55	1.28	1.33
1	A	1867	A	N3-C4	-5.54	1.31	1.34
1	A	1879	G	N9-C8	-5.54	1.33	1.37
1	A	2682	A	N7-C5	-5.53	1.35	1.39
1	A	1981	G	C6-N1	-5.53	1.35	1.39
1	A	1787	G	N9-C8	-5.51	1.33	1.37
1	A	1791	G	C5-C4	-5.51	1.34	1.38
1	A	1788	C	N1-C6	-5.51	1.33	1.37
1	A	1813	C	N3-C4	-5.51	1.30	1.33
1	A	2375	C	C4-C5	-5.51	1.38	1.43
1	A	2308	A	C5-C4	-5.49	1.34	1.38
1	A	1883	G	C5-C4	-5.47	1.34	1.38
1	A	1702	A	N9-C4	-5.47	1.34	1.37
1	A	2152	A	N3-C4	-5.47	1.31	1.34
1	A	2018	G	C5-C4	-5.46	1.34	1.38
1	A	1906	G	C5-C4	-5.45	1.34	1.38
1	A	2011	G	C5-C4	-5.45	1.34	1.38
1	A	3218	A	N7-C5	-5.43	1.35	1.39
1	A	2044	A	N9-C4	-5.43	1.34	1.37
1	A	1767	G	C6-N1	-5.43	1.35	1.39
1	A	2143	G	C5-C4	-5.43	1.34	1.38
1	A	2009	G	C8-N7	-5.43	1.27	1.30
1	A	2051	A	C5-C4	-5.43	1.34	1.38
1	A	1757	A	N7-C5	-5.42	1.35	1.39
1	A	3213	A	N7-C5	-5.42	1.35	1.39
1	A	1790	A	N9-C8	-5.42	1.33	1.37
1	A	1863	A	C5-C4	-5.41	1.34	1.38
1	A	2290	A	N9-C4	-5.41	1.34	1.37
15	Q	204	MET	C-N	-5.41	1.21	1.34

Continued on next page...

Continued from previous page...

Mol	Chain	Res	Type	Atoms	Z	Observed(Å)	Ideal(Å)
1	A	1864	A	C5-C6	-5.40	1.36	1.41
1	A	1865	C	N1-C6	-5.40	1.33	1.37
1	A	2672	A	N9-C4	-5.39	1.34	1.37
1	A	1803	A	N3-C4	-5.39	1.31	1.34
1	A	2278	A	C5-C4	-5.39	1.34	1.38
1	A	1881	A	C6-N1	-5.38	1.31	1.35
1	A	1816	G	C5-C4	-5.37	1.34	1.38
1	A	1894	G	C6-N1	-5.37	1.35	1.39
1	A	2006	C	N1-C6	-5.37	1.33	1.37
1	A	1767	G	N7-C5	-5.36	1.36	1.39
1	A	1859	A	N9-C4	-5.35	1.34	1.37
1	A	1753	A	N9-C4	-5.35	1.34	1.37
1	A	1748	G	C8-N7	-5.35	1.27	1.30
17	S	106	TRP	CB-CG	-5.34	1.40	1.50
1	A	2683	C	N1-C6	-5.34	1.33	1.37
1	A	1751	A	N7-C5	-5.34	1.36	1.39
1	A	1903	C	C4-C5	-5.33	1.38	1.43
1	A	2004	G	N9-C8	-5.33	1.34	1.37
1	A	2152	A	C6-N1	-5.33	1.31	1.35
1	A	2254	C	C4-C5	-5.33	1.38	1.43
21	W	83	VAL	CB-CG2	-5.32	1.41	1.52
1	A	2684	C	N3-C4	-5.32	1.30	1.33
1	A	1795	A	C5-C4	-5.32	1.35	1.38
1	A	2250	A	C5-C4	-5.32	1.35	1.38
1	A	1678	C	N3-C4	-5.31	1.30	1.33
1	A	2103	A	C5-C4	-5.31	1.35	1.38
1	A	1785	C	N1-C6	-5.31	1.33	1.37
1	A	1791	G	N7-C5	-5.30	1.36	1.39
1	A	1891	A	N9-C4	-5.30	1.34	1.37
1	A	2681	G	C8-N7	-5.30	1.27	1.30
1	A	1771	C	C4-C5	-5.30	1.38	1.43
1	A	2147	G	C5-C4	-5.29	1.34	1.38
1	A	2293	A	C5-C4	-5.29	1.35	1.38
1	A	1792	G	N9-C8	-5.29	1.34	1.37
1	A	1844	A	N7-C5	-5.29	1.36	1.39
5	F	284	TYR	CD1-CE1	-5.29	1.31	1.39
1	A	1768	G	N1-C2	-5.29	1.33	1.37
1	A	2289	G	N3-C4	-5.28	1.31	1.35
1	A	2289	G	C2-N3	-5.28	1.28	1.32
1	A	2680	U	C2-N3	-5.28	1.34	1.37
1	A	1787	G	C6-N1	-5.28	1.35	1.39
1	A	2121	G	C6-N1	-5.28	1.35	1.39

Continued on next page...

Continued from previous page...

Mol	Chain	Res	Type	Atoms	Z	Observed(Å)	Ideal(Å)
1	A	1768	G	C5-C4	-5.26	1.34	1.38
1	A	2293	A	N7-C5	-5.26	1.36	1.39
1	A	1879	G	C6-N1	-5.26	1.35	1.39
1	A	2289	G	N9-C4	-5.25	1.33	1.38
1	A	1784	A	C6-N1	-5.25	1.31	1.35
1	A	2300	G	C6-N1	-5.24	1.35	1.39
1	A	1885	A	N9-C4	-5.24	1.34	1.37
16	R	93	CYS	CB-SG	-5.24	1.73	1.81
1	A	1674	A	N7-C5	-5.24	1.36	1.39
1	A	1868	G	C6-N1	-5.24	1.35	1.39
1	A	2312	A	N7-C5	-5.24	1.36	1.39
1	A	2689	C	N3-C4	-5.23	1.30	1.33
1	A	2304	G	C2-N3	-5.23	1.28	1.32
1	A	1982	G	C5-C4	-5.23	1.34	1.38
1	A	2309	A	N7-C5	-5.23	1.36	1.39
1	A	1889	C	C4-C5	-5.22	1.38	1.43
1	A	1906	G	N1-C2	-5.22	1.33	1.37
1	A	2134	A	C5-C4	-5.22	1.35	1.38
1	A	1684	C	N3-C4	-5.22	1.30	1.33
1	A	2145	G	C5-C4	-5.22	1.34	1.38
1	A	2683	C	C4-C5	-5.22	1.38	1.43
1	A	1867	A	C5-C4	-5.21	1.35	1.38
1	A	2304	G	C5-C4	-5.21	1.34	1.38
1	A	1779	A	N7-C5	-5.21	1.36	1.39
1	A	2317	G	C5-C4	-5.20	1.34	1.38
1	A	1679	U	C5-C6	-5.20	1.29	1.34
1	A	1818	A	N7-C5	-5.20	1.36	1.39
1	A	2343	G	N1-C2	-5.20	1.33	1.37
1	A	1772	A	N3-C4	-5.19	1.31	1.34
1	A	2278	A	N9-C4	-5.19	1.34	1.37
1	A	2103	A	N9-C4	-5.19	1.34	1.37
1	A	1862	U	C2-N3	-5.19	1.34	1.37
1	A	1894	G	N1-C2	-5.18	1.33	1.37
1	A	1881	A	N3-C4	-5.17	1.31	1.34
1	A	1705	A	N9-C4	-5.17	1.34	1.37
1	A	1791	G	N9-C8	-5.17	1.34	1.37
1	A	2291	A	C8-N7	-5.17	1.27	1.31
1	A	1772	A	N9-C8	-5.17	1.33	1.37
1	A	2089	U	C2-N3	-5.17	1.34	1.37
1	A	1829	A	C5-C4	-5.16	1.35	1.38
1	A	1918	G	C2-N3	-5.16	1.28	1.32
1	A	2019	G	C5-C4	-5.16	1.34	1.38

Continued on next page...

Continued from previous page...

Mol	Chain	Res	Type	Atoms	Z	Observed(Å)	Ideal(Å)
1	A	1773	A	C5-C4	-5.16	1.35	1.38
27	2	87	ARG	CG-CD	-5.16	1.39	1.51
1	A	2303	A	C5-C6	-5.15	1.36	1.41
1	A	2309	A	C6-N1	-5.15	1.31	1.35
1	A	2454	G	N9-C8	-5.15	1.34	1.37
1	A	2279	U	C2-N3	-5.14	1.34	1.37
1	A	2673	G	C6-N1	-5.14	1.35	1.39
1	A	1884	G	N9-C8	-5.14	1.34	1.37
1	A	2422	U	C2-N3	-5.14	1.34	1.37
1	A	2304	G	C8-N7	-5.14	1.27	1.30
1	A	1985	G	C5-C4	-5.14	1.34	1.38
1	A	1880	C	C4-C5	-5.13	1.38	1.43
1	A	1893	A	N3-C4	-5.13	1.31	1.34
1	A	1778	U	C2-N3	-5.13	1.34	1.37
1	A	2137	C	C4-C5	-5.13	1.38	1.43
1	A	2007	U	C2-N3	-5.12	1.34	1.37
1	A	1683	C	C2-N3	-5.12	1.31	1.35
1	A	1894	G	C5-C4	-5.12	1.34	1.38
1	A	2120	G	C5-C4	-5.11	1.34	1.38
1	A	2292	G	N9-C4	-5.11	1.33	1.38
1	A	2008	G	N9-C8	-5.11	1.34	1.37
1	A	2136	C	C4-C5	-5.11	1.38	1.43
1	A	2137	C	N3-C4	-5.11	1.30	1.33
1	A	1741	A	N9-C4	-5.10	1.34	1.37
1	A	2303	A	C5-C4	-5.10	1.35	1.38
1	A	1884	G	C2-N3	-5.09	1.28	1.32
1	A	1753	A	N7-C5	-5.09	1.36	1.39
1	A	2298	A	C5-C6	-5.09	1.36	1.41
1	A	2273	A	N7-C5	-5.09	1.36	1.39
16	R	11	ARG	CB-CG	-5.09	1.38	1.52
1	A	2683	C	C5-C6	-5.08	1.30	1.34
1	A	2335	A	C5-C4	-5.08	1.35	1.38
1	A	1893	A	C5-C4	-5.08	1.35	1.38
1	A	1987	G	C6-N1	-5.08	1.35	1.39
1	A	2128	G	C2-N3	-5.08	1.28	1.32
1	A	2672	A	N7-C5	-5.08	1.36	1.39
1	A	1790	A	C5-C4	-5.07	1.35	1.38
1	A	1830	G	N9-C8	-5.07	1.34	1.37
1	A	2343	G	C5-C4	-5.07	1.34	1.38
1	A	2004	G	C8-N7	-5.06	1.27	1.30
1	A	2304	G	N1-C2	-5.06	1.33	1.37
1	A	1828	A	C5-C6	-5.06	1.36	1.41

Continued on next page...

Continued from previous page...

Mol	Chain	Res	Type	Atoms	Z	Observed(Å)	Ideal(Å)
21	W	61	VAL	CB-CG1	-5.05	1.42	1.52
1	A	1868	G	C5-C4	-5.05	1.34	1.38
1	A	2677	A	N9-C4	-5.05	1.34	1.37
1	A	1815	A	N7-C5	-5.05	1.36	1.39
1	A	1770	G	N3-C4	-5.04	1.31	1.35
1	A	2302	U	C4-C5	-5.04	1.39	1.43
1	A	2275	U	C2-N3	-5.03	1.34	1.37
1	A	2453	G	C8-N7	-5.03	1.27	1.30
1	A	2004	G	N3-C4	-5.03	1.31	1.35
11	M	188	CYS	CB-SG	-5.03	1.73	1.81
1	A	1840	C	N3-C4	-5.02	1.30	1.33
1	A	2290	A	N7-C5	-5.02	1.36	1.39
1	A	2304	G	N9-C8	-5.02	1.34	1.37
1	A	2707	A	N9-C4	-5.02	1.34	1.37
1	A	2681	G	C6-N1	-5.02	1.36	1.39
1	A	1830	G	N1-C2	-5.01	1.33	1.37
1	A	1863	A	N7-C5	-5.01	1.36	1.39
1	A	2124	A	N7-C5	-5.01	1.36	1.39
1	A	2696	A	C5-C4	-5.01	1.35	1.38
1	A	1915	C	N1-C6	-5.01	1.34	1.37
1	A	2277	U	C2-N3	-5.00	1.34	1.37
1	A	1889	C	N1-C6	-5.00	1.34	1.37

All (493) bond angle outliers are listed below:

Mol	Chain	Res	Type	Atoms	Z	Observed(°)	Ideal(°)
1	A	2066	C	N1-C2-O2	10.36	125.12	118.90
1	A	2322	C	N1-C2-O2	10.29	125.08	118.90
1	A	2252	C	C5-C6-N1	10.02	126.01	121.00
38	e	178	TRP	C-N-CA	10.01	146.71	121.70
1	A	2372	U	N3-C2-O2	-9.99	115.21	122.20
1	A	1729	U	N3-C2-O2	-9.96	115.23	122.20
1	A	1840	C	C6-N1-C2	-9.73	116.41	120.30
1	A	1715	C	C2-N1-C1'	9.69	129.46	118.80
1	A	2275	U	N3-C2-O2	-9.64	115.45	122.20
1	A	2322	C	C2-N1-C1'	9.56	129.32	118.80
1	A	2898	U	N3-C2-O2	-9.48	115.56	122.20
1	A	2066	C	N3-C2-O2	-9.33	115.37	121.90
1	A	1701	U	N1-C2-O2	9.29	129.30	122.80
1	A	3212	C	C2-N1-C1'	9.24	128.97	118.80
1	A	2252	C	C6-N1-C2	-9.21	116.62	120.30
1	A	1701	U	N3-C2-O2	-9.19	115.77	122.20

Continued on next page...

Continued from previous page...

Mol	Chain	Res	Type	Atoms	Z	Observed(°)	Ideal(°)
1	A	2386	C	N1-C2-O2	9.15	124.39	118.90
1	A	2684	C	N1-C2-O2	9.02	124.31	118.90
1	A	1782	G	O4'-C1'-N9	9.02	115.41	108.20
1	A	1823	A	P-O3'-C3'	8.97	130.47	119.70
1	A	2379	C	N1-C2-O2	8.93	124.26	118.90
1	A	1813	C	C2-N1-C1'	8.85	128.54	118.80
1	A	1850	U	N3-C2-O2	-8.78	116.05	122.20
1	A	1791	G	O5'-P-OP2	-8.71	97.86	105.70
1	A	2187	C	N3-C2-O2	-8.62	115.87	121.90
1	A	1715	C	N1-C2-O2	8.59	124.05	118.90
1	A	3134	C	N1-C2-O2	8.51	124.00	118.90
1	A	1813	C	N3-C2-O2	-8.50	115.95	121.90
1	A	2375	C	C5-C6-N1	8.49	125.25	121.00
1	A	2372	U	N1-C2-O2	8.46	128.72	122.80
1	A	2898	U	C2-N1-C1'	8.39	127.77	117.70
1	A	2750	U	N3-C2-O2	-8.34	116.36	122.20
1	A	2322	C	N3-C2-O2	-8.30	116.09	121.90
1	A	2066	C	C2-N1-C1'	8.21	127.83	118.80
1	A	2135	A	C2-N3-C4	8.19	114.69	110.60
17	S	135	LEU	CA-CB-CG	8.15	134.05	115.30
1	A	2684	C	C2-N1-C1'	8.07	127.67	118.80
1	A	1780	U	P-O3'-C3'	8.04	129.35	119.70
1	A	1792	G	C4-C5-N7	8.03	114.01	110.80
1	A	1725	C	N1-C2-O2	8.03	123.72	118.90
1	A	2165	C	P-O3'-C3'	7.92	129.20	119.70
1	A	2379	C	C2-N1-C1'	7.92	127.51	118.80
1	A	2852	C	N1-C2-O2	7.81	123.59	118.90
1	A	2150	U	N1-C2-O2	7.81	128.26	122.80
1	A	1806	U	N3-C2-O2	-7.78	116.75	122.20
15	Q	151	LEU	CB-CG-CD2	-7.75	97.83	111.00
1	A	1743	U	C5-C6-N1	7.73	126.56	122.70
1	A	2186	C	N1-C2-O2	7.73	123.54	118.90
1	A	1890	C	C6-N1-C2	-7.70	117.22	120.30
1	A	1916	G	C5-C6-O6	-7.66	124.00	128.60
1	A	2005	C	C6-N1-C2	-7.64	117.25	120.30
1	A	1776	G	C8-N9-C4	-7.63	103.35	106.40
1	A	1689	C	N1-C2-O2	7.63	123.48	118.90
1	A	2900	C	C5-C6-N1	7.62	124.81	121.00
1	A	3134	C	N3-C2-O2	-7.60	116.58	121.90
16	R	34	ARG	CB-CG-CD	-7.57	91.91	111.60
1	A	2329	C	C6-N1-C2	-7.57	117.27	120.30
1	A	2416	U	N1-C2-O2	7.56	128.09	122.80

Continued on next page...

Continued from previous page...

Mol	Chain	Res	Type	Atoms	Z	Observed(°)	Ideal(°)
1	A	1715	C	C6-N1-C1'	-7.54	111.75	120.80
1	A	1984	A	C8-N9-C4	7.54	108.82	105.80
1	A	1783	U	C5-C6-N1	7.53	126.46	122.70
19	U	28	LEU	CA-CB-CG	7.52	132.59	115.30
1	A	1813	C	N1-C2-O2	7.51	123.41	118.90
1	A	1993	A	C2-N3-C4	7.46	114.33	110.60
1	A	3192	C	N1-C2-O2	7.44	123.36	118.90
1	A	2687	C	C6-N1-C2	-7.42	117.33	120.30
1	A	2423	C	C6-N1-C2	-7.41	117.33	120.30
1	A	1817	C	C6-N1-C2	-7.37	117.35	120.30
1	A	2150	U	N3-C2-O2	-7.36	117.05	122.20
1	A	1868	G	N1-C6-O6	-7.36	115.48	119.90
51	s	229	LEU	CA-CB-CG	7.35	132.21	115.30
1	A	2357	C	N3-C2-O2	-7.35	116.76	121.90
1	A	2343	G	C2-N3-C4	7.34	115.57	111.90
1	A	1805	A	N1-C6-N6	-7.34	114.19	118.60
1	A	2093	U	N1-C2-O2	7.33	127.93	122.80
1	A	2681	G	O5'-P-OP2	-7.32	99.11	105.70
1	A	1814	A	C8-N9-C4	-7.31	102.88	105.80
1	A	2750	U	N1-C2-O2	7.30	127.91	122.80
1	A	2080	U	N3-C2-O2	-7.29	117.09	122.20
1	A	2259	C	N1-C2-O2	7.29	123.28	118.90
51	s	374	LEU	CA-CB-CG	7.26	132.01	115.30
1	A	2087	U	C5-C6-N1	7.24	126.32	122.70
1	A	1701	U	C2-N1-C1'	7.21	126.35	117.70
1	A	2000	C	N1-C2-O2	7.21	123.22	118.90
1	A	2138	U	N3-C2-O2	-7.19	117.17	122.20
1	A	1748	G	C4-C5-N7	7.18	113.67	110.80
1	A	3212	C	N1-C2-O2	7.18	123.21	118.90
1	A	1806	U	N1-C2-O2	7.17	127.82	122.80
1	A	2211	U	N1-C2-O2	7.13	127.79	122.80
41	h	96	LEU	CA-CB-CG	7.12	131.68	115.30
1	A	1725	C	O5'-P-OP2	-7.12	99.30	105.70
1	A	1685	C	N1-C2-O2	7.09	123.15	118.90
1	A	2852	C	C2-N1-C1'	7.07	126.58	118.80
1	A	1840	C	C5-C6-N1	7.05	124.53	121.00
1	A	2030	U	P-O3'-C3'	7.05	128.16	119.70
1	A	1689	C	C2-N1-C1'	7.04	126.54	118.80
1	A	3201	A	P-O3'-C3'	7.04	128.14	119.70
1	A	2457	A	P-O3'-C3'	7.03	128.13	119.70
1	A	1729	U	N1-C2-O2	7.02	127.72	122.80
1	A	2322	C	C6-N1-C2	-6.99	117.50	120.30

Continued on next page...

Continued from previous page...

Mol	Chain	Res	Type	Atoms	Z	Observed(°)	Ideal(°)
1	A	2277	U	C5-C6-N1	6.98	126.19	122.70
1	A	2379	C	N3-C2-O2	-6.97	117.02	121.90
1	A	2135	A	C8-N9-C4	-6.96	103.02	105.80
1	A	2372	U	C2-N1-C1'	6.96	126.05	117.70
1	A	1732	C	C6-N1-C2	-6.96	117.52	120.30
1	A	2186	C	C6-N1-C2	-6.93	117.53	120.30
1	A	2292	G	N7-C8-N9	6.93	116.57	113.10
1	A	1793	G	N1-C6-O6	-6.92	115.75	119.90
1	A	2684	C	N3-C2-O2	-6.90	117.07	121.90
2	B	1658	U	N1-C2-O2	6.87	127.61	122.80
1	A	2093	U	N3-C2-O2	-6.86	117.39	122.20
1	A	2280	C	N1-C2-O2	6.86	123.02	118.90
42	i	63	LEU	CA-CB-CG	6.86	131.08	115.30
1	A	2211	U	N3-C2-O2	-6.84	117.41	122.20
1	A	3212	C	C5-C6-N1	6.84	124.42	121.00
1	A	1879	G	C6-C5-N7	-6.81	126.31	130.40
1	A	2076	C	C6-N1-C2	-6.81	117.58	120.30
1	A	2357	C	N1-C2-O2	6.80	122.98	118.90
7	I	183	ASP	CB-CG-OD1	6.78	124.41	118.30
1	A	2020	U	N1-C2-O2	6.77	127.54	122.80
1	A	2416	U	N3-C2-O2	-6.76	117.47	122.20
1	A	2898	U	C6-N1-C2	-6.75	116.95	121.00
1	A	2127	A	N1-C2-N3	-6.75	125.92	129.30
1	A	2263	C	C6-N1-C2	-6.74	117.61	120.30
1	A	2243	A	P-O3'-C3'	6.73	127.78	119.70
1	A	2852	C	N3-C2-O2	-6.72	117.19	121.90
1	A	2871	U	N3-C2-O2	-6.72	117.50	122.20
1	A	2140	G	C8-N9-C4	-6.70	103.72	106.40
1	A	1989	C	C5-C6-N1	6.69	124.35	121.00
1	A	2186	C	C5-C6-N1	6.69	124.35	121.00
1	A	1784	A	C5-C6-N1	6.69	121.05	117.70
1	A	1813	C	C6-N1-C1'	-6.68	112.79	120.80
22	X	153	LEU	CA-CB-CG	6.67	130.64	115.30
1	A	2386	C	C2-N1-C1'	6.65	126.11	118.80
1	A	1695	C	C6-N1-C2	-6.64	117.64	120.30
1	A	2379	C	C6-N1-C1'	-6.64	112.83	120.80
16	R	34	ARG	CG-CD-NE	6.63	125.73	111.80
1	A	2843	C	C6-N1-C2	-6.63	117.65	120.30
36	c	203	LEU	CB-CG-CD1	-6.62	99.75	111.00
1	A	1695	C	N3-C2-O2	-6.61	117.27	121.90
1	A	2671	C	C6-N1-C2	-6.60	117.66	120.30
1	A	2187	C	C6-N1-C2	-6.58	117.67	120.30

Continued on next page...

Continued from previous page...

Mol	Chain	Res	Type	Atoms	Z	Observed(°)	Ideal(°)
1	A	2136	C	C2-N1-C1'	6.57	126.03	118.80
1	A	2656	U	N3-C2-O2	-6.57	117.60	122.20
1	A	1778	U	N3-C2-O2	-6.56	117.61	122.20
1	A	2271	C	C6-N1-C2	-6.55	117.68	120.30
1	A	1792	G	C5-N7-C8	-6.54	101.03	104.30
1	A	1751	A	N7-C8-N9	6.52	117.06	113.80
1	A	1823	A	C8-N9-C4	-6.52	103.19	105.80
1	A	2747	U	N1-C2-O2	6.51	127.36	122.80
1	A	1776	G	N7-C8-N9	6.51	116.36	113.10
1	A	2687	C	C5-C6-N1	6.50	124.25	121.00
1	A	2284	C	C2-N1-C1'	6.49	125.94	118.80
1	A	3104	U	N3-C2-O2	-6.49	117.66	122.20
18	T	176	VAL	CG1-CB-CG2	-6.49	100.52	110.90
1	A	1714	C	N1-C2-O2	6.46	122.78	118.90
1	A	2157	U	C5-C6-N1	6.46	125.93	122.70
1	A	2846	G	O4'-C1'-N9	6.46	113.37	108.20
1	A	2408	U	C5-C6-N1	6.45	125.93	122.70
1	A	2386	C	N3-C2-O2	-6.45	117.39	121.90
1	A	1750	G	C4-C5-N7	6.43	113.37	110.80
1	A	2164	C	N1-C2-O2	6.43	122.76	118.90
1	A	1881	A	N1-C6-N6	-6.42	114.75	118.60
1	A	1875	C	C6-N1-C2	-6.42	117.73	120.30
1	A	2292	G	C5-N7-C8	-6.42	101.09	104.30
1	A	3212	C	C6-N1-C1'	-6.41	113.11	120.80
1	A	2747	U	C2-N1-C1'	6.39	125.37	117.70
2	B	1658	U	N3-C2-O2	-6.38	117.73	122.20
1	A	1725	C	N3-C2-O2	-6.38	117.44	121.90
1	A	2135	A	N7-C8-N9	6.37	116.99	113.80
1	A	2322	C	C6-N1-C1'	-6.37	113.16	120.80
1	A	1715	C	N3-C2-O2	-6.36	117.45	121.90
1	A	3212	C	O4'-C1'-N1	6.36	113.29	108.20
1	A	1983	U	N3-C4-C5	6.35	118.41	114.60
1	A	1747	G	C6-N1-C2	-6.35	121.29	125.10
1	A	1684	C	C6-N1-C2	-6.34	117.76	120.30
1	A	2300	G	C4-C5-N7	6.34	113.33	110.80
1	A	3192	C	N3-C2-O2	-6.31	117.48	121.90
1	A	3192	C	C2-N1-C1'	6.29	125.72	118.80
1	A	1834	U	C5-C6-N1	6.28	125.84	122.70
9	K	125	LEU	CB-CG-CD2	-6.28	100.33	111.00
1	A	1721	C	N1-C2-O2	6.27	122.66	118.90
1	A	2747	U	C5-C6-N1	6.27	125.83	122.70
1	A	2322	C	C5-C6-N1	6.27	124.13	121.00

Continued on next page...

Continued from previous page...

Mol	Chain	Res	Type	Atoms	Z	Observed(°)	Ideal(°)
1	A	1785	C	C4-C5-C6	-6.24	114.28	117.40
1	A	2117	U	N1-C2-O2	6.23	127.16	122.80
1	A	1783	U	O5'-P-OP2	-6.22	100.10	105.70
1	A	2871	U	N1-C2-O2	6.22	127.15	122.80
1	A	2272	C	C6-N1-C2	-6.21	117.82	120.30
11	M	184	LEU	CA-CB-CG	6.20	129.57	115.30
1	A	1806	U	C2-N1-C1'	6.20	125.14	117.70
1	A	2865	C	N3-C2-O2	-6.20	117.56	121.90
1	A	1768	G	N9-C4-C5	-6.20	102.92	105.40
1	A	1732	C	C5-C6-N1	6.18	124.09	121.00
1	A	1784	A	C4-C5-N7	6.16	113.78	110.70
1	A	2275	U	N1-C2-O2	6.16	127.11	122.80
1	A	3125	A	C5-C6-N6	-6.16	118.77	123.70
40	g	120	LEU	CA-CB-CG	6.16	129.47	115.30
1	A	2311	U	N3-C2-O2	-6.14	117.90	122.20
1	A	1785	C	C5-C6-N1	6.14	124.07	121.00
1	A	3222	C	C6-N1-C2	-6.13	117.85	120.30
1	A	2061	C	C6-N1-C2	-6.13	117.85	120.30
1	A	1772	A	C2-N3-C4	6.12	113.66	110.60
1	A	1772	A	C5-C6-N1	6.12	120.76	117.70
1	A	1783	U	C2-N1-C1'	6.12	125.04	117.70
1	A	2928	C	C6-N1-C2	-6.11	117.86	120.30
1	A	1725	C	C6-N1-C2	-6.10	117.86	120.30
1	A	1695	C	N1-C2-O2	6.10	122.56	118.90
1	A	2750	U	C2-N1-C1'	6.10	125.02	117.70
1	A	2082	G	N3-C2-N2	-6.10	115.63	119.90
1	A	1743	U	C6-N1-C2	-6.09	117.34	121.00
46	m	53	PRO	O-C-N	-6.09	112.96	122.70
7	I	182	ASP	CB-CG-OD1	6.09	123.78	118.30
1	A	1845	C	C5-C6-N1	6.09	124.04	121.00
1	A	1839	C	C5-C6-N1	6.08	124.04	121.00
1	A	2266	U	N3-C2-O2	-6.08	117.95	122.20
1	A	2928	C	C2-N1-C1'	6.07	125.48	118.80
1	A	1714	C	C2-N1-C1'	6.06	125.47	118.80
1	A	1783	U	N1-C2-O2	6.05	127.04	122.80
1	A	2793	C	N1-C2-O2	6.05	122.53	118.90
1	A	2303	A	C4-C5-N7	6.04	113.72	110.70
1	A	2865	C	N1-C2-O2	6.04	122.52	118.90
1	A	3212	C	C6-N1-C2	-6.03	117.89	120.30
1	A	1747	G	N3-C2-N2	-6.02	115.69	119.90
1	A	2684	C	C6-N1-C1'	-6.02	113.58	120.80
1	A	1919	C	N1-C2-O2	6.01	122.51	118.90

Continued on next page...

Continued from previous page...

Mol	Chain	Res	Type	Atoms	Z	Observed(°)	Ideal(°)
14	P	161	LEU	CA-CB-CG	6.01	129.12	115.30
18	T	90	LEU	CB-CG-CD2	-6.01	100.79	111.00
16	R	119	LEU	CA-CB-CG	6.00	129.11	115.30
1	A	2205	U	N3-C2-O2	-5.99	118.01	122.20
1	A	2912	C	N1-C2-O2	5.99	122.49	118.90
1	A	2507	A	P-O3'-C3'	5.99	126.88	119.70
2	B	1607	U	P-O3'-C3'	5.98	126.88	119.70
1	A	2266	U	N1-C2-O2	5.97	126.98	122.80
1	A	3124	U	N3-C4-O4	5.97	123.58	119.40
1	A	2900	C	C2-N1-C1'	5.96	125.36	118.80
1	A	2336	U	N3-C2-O2	-5.96	118.03	122.20
1	A	1778	U	C5-C6-N1	5.95	125.68	122.70
1	A	1725	C	C5-C6-N1	5.94	123.97	121.00
1	A	2375	C	C6-N1-C2	-5.93	117.93	120.30
1	A	2255	C	C6-N1-C2	-5.93	117.93	120.30
1	A	2186	C	C2-N1-C1'	5.92	125.32	118.80
1	A	1750	G	O4'-C1'-N9	5.92	112.93	108.20
1	A	2076	C	C2-N1-C1'	5.92	125.31	118.80
1	A	3157	C	C2-N1-C1'	5.90	125.29	118.80
1	A	1783	U	N3-C2-O2	-5.90	118.07	122.20
1	A	1738	U	N3-C2-O2	-5.90	118.07	122.20
1	A	2304	G	C5-N7-C8	-5.89	101.35	104.30
1	A	2912	C	N3-C2-O2	-5.89	117.78	121.90
1	A	2080	U	N1-C2-O2	5.88	126.92	122.80
1	A	1748	G	C6-C5-N7	-5.88	126.87	130.40
1	A	1720	C	C6-N1-C2	-5.88	117.95	120.30
1	A	2186	C	N3-C2-O2	-5.87	117.79	121.90
1	A	2079	C	N1-C2-O2	5.85	122.41	118.90
42	i	63	LEU	CB-CG-CD1	-5.84	101.06	111.00
1	A	2416	U	C2-N1-C1'	5.84	124.71	117.70
1	A	2067	C	N1-C2-O2	5.83	122.40	118.90
1	A	1671	G	O4'-C1'-N9	5.83	112.86	108.20
1	A	1984	A	N9-C4-C5	-5.83	103.47	105.80
1	A	1832	A	C8-N9-C4	5.81	108.13	105.80
1	A	2247	C	N1-C2-O2	5.79	122.38	118.90
1	A	1880	C	C6-N1-C2	-5.79	117.98	120.30
1	A	2284	C	N3-C2-O2	-5.79	117.84	121.90
1	A	1689	C	N3-C2-O2	-5.79	117.85	121.90
1	A	2329	C	C2-N1-C1'	5.79	125.17	118.80
1	A	2252	C	C2-N1-C1'	5.79	125.16	118.80
1	A	2136	C	C5-C6-N1	5.78	123.89	121.00
1	A	2263	C	C2-N1-C1'	5.77	125.15	118.80

Continued on next page...

Continued from previous page...

Mol	Chain	Res	Type	Atoms	Z	Observed(°)	Ideal(°)
1	A	1691	C	C5-C6-N1	5.77	123.89	121.00
1	A	1875	C	C5-C6-N1	5.77	123.88	121.00
2	B	1633	U	N1-C2-O2	5.76	126.83	122.80
1	A	2067	C	C6-N1-C2	-5.75	118.00	120.30
1	A	1785	C	C5-C4-N4	-5.75	116.17	120.20
1	A	2000	C	N3-C2-O2	-5.74	117.88	121.90
1	A	2101	C	C6-N1-C2	-5.72	118.01	120.30
1	A	2868	C	C5-C6-N1	5.72	123.86	121.00
1	A	2654	U	N3-C2-O2	-5.72	118.20	122.20
42	i	88	LEU	CA-CB-CG	5.71	128.43	115.30
1	A	2303	A	C4-C5-C6	-5.70	114.15	117.00
13	O	144	LEU	CA-CB-CG	5.70	128.42	115.30
1	A	3134	C	C6-N1-C2	-5.70	118.02	120.30
1	A	1707	C	N3-C2-O2	-5.70	117.91	121.90
1	A	1890	C	C5-C6-N1	5.70	123.85	121.00
29	5	415	LEU	CA-CB-CG	5.70	128.40	115.30
1	A	2254	C	N1-C2-O2	5.69	122.31	118.90
1	A	3106	C	C6-N1-C2	-5.69	118.03	120.30
17	S	144	LEU	CA-CB-CG	5.68	128.36	115.30
1	A	2697	G	N9-C4-C5	-5.67	103.13	105.40
1	A	2900	C	C6-N1-C2	-5.67	118.03	120.30
1	A	3192	C	C6-N1-C2	-5.67	118.03	120.30
1	A	2276	C	C6-N1-C2	-5.65	118.04	120.30
1	A	2005	C	C5-C6-N1	5.65	123.82	121.00
10	L	90	CYS	C-N-CA	-5.65	107.58	121.70
1	A	2303	A	C5-N7-C8	-5.64	101.08	103.90
1	A	3134	C	C2-N1-C1'	5.63	125.00	118.80
1	A	1915	C	C5-C6-N1	5.63	123.81	121.00
1	A	2834	C	C6-N1-C2	-5.63	118.05	120.30
1	A	2135	A	N3-C4-C5	-5.63	122.86	126.80
2	B	1635	C	N1-C2-O2	5.62	122.28	118.90
1	A	1694	U	N1-C2-O2	5.61	126.73	122.80
1	A	2049	U	C5-C6-N1	5.61	125.51	122.70
1	A	2066	C	C6-N1-C2	-5.61	118.06	120.30
1	A	1768	G	C4-C5-N7	5.61	113.04	110.80
1	A	2066	C	C6-N1-C1'	-5.60	114.08	120.80
1	A	1784	A	C5-N7-C8	-5.60	101.10	103.90
29	5	359	LEU	CA-CB-CG	5.60	128.18	115.30
1	A	2441	C	C6-N1-C2	-5.60	118.06	120.30
1	A	1701	U	C6-N1-C1'	-5.59	113.37	121.20
1	A	1859	A	C4-C5-N7	5.59	113.50	110.70
1	A	1714	C	N3-C2-O2	-5.59	117.98	121.90

Continued on next page...

Continued from previous page...

Mol	Chain	Res	Type	Atoms	Z	Observed(°)	Ideal(°)
1	A	1715	C	O4'-C1'-N1	5.59	112.67	108.20
1	A	2671	C	C5-C6-N1	5.59	123.80	121.00
1	A	2000	C	C6-N1-C2	-5.59	118.06	120.30
1	A	2343	G	N3-C4-C5	-5.58	125.81	128.60
1	A	2300	G	C5-N7-C8	-5.57	101.52	104.30
1	A	2124	A	C8-N9-C4	-5.57	103.57	105.80
1	A	1850	U	N1-C2-O2	5.56	126.69	122.80
1	A	1778	U	C6-N1-C2	-5.56	117.66	121.00
1	A	1905	C	C6-N1-C2	-5.56	118.08	120.30
9	K	65	ILE	CG1-CB-CG2	-5.53	99.23	111.40
42	i	80	LEU	CA-CB-CG	5.53	128.02	115.30
1	A	1823	A	N7-C8-N9	5.53	116.56	113.80
1	A	1671	G	C4-C5-N7	5.51	113.00	110.80
1	A	2004	G	C8-N9-C4	-5.51	104.20	106.40
1	A	2871	U	C5-C6-N1	5.51	125.45	122.70
1	A	1725	C	C2-N1-C1'	5.50	124.86	118.80
11	M	154	ILE	CG1-CB-CG2	-5.50	99.31	111.40
1	A	1823	A	C2-N3-C4	5.49	113.34	110.60
2	B	1607	U	C2-N1-C1'	5.48	124.28	117.70
1	A	1770	G	N3-C4-C5	5.48	131.34	128.60
1	A	1743	U	N3-C2-O2	-5.47	118.37	122.20
1	A	1863	A	N1-C2-N3	-5.47	126.56	129.30
1	A	2117	U	N3-C2-O2	-5.47	118.37	122.20
1	A	3125	A	C4-C5-N7	5.47	113.43	110.70
1	A	1685	C	N3-C2-O2	-5.46	118.08	121.90
1	A	2138	U	N1-C2-O2	5.46	126.62	122.80
1	A	2252	C	C4-C5-C6	-5.46	114.67	117.40
30	6	184	LEU	CA-CB-CG	5.45	127.84	115.30
1	A	1895	C	N3-C4-C5	5.45	124.08	121.90
1	A	1689	C	C6-N1-C1'	-5.45	114.26	120.80
16	R	11	ARG	CG-CD-NE	-5.45	100.36	111.80
1	A	2437	C	C6-N1-C2	-5.44	118.12	120.30
11	M	96	LEU	CB-CG-CD2	-5.44	101.75	111.00
13	O	59	LEU	CA-CB-CG	5.44	127.81	115.30
1	A	2205	U	N1-C2-O2	5.44	126.61	122.80
1	A	2443	C	C2-N1-C1'	5.44	124.78	118.80
1	A	1685	C	C2-N1-C1'	5.43	124.78	118.80
1	A	1817	C	C5-C6-N1	5.43	123.72	121.00
1	A	1770	G	N3-C4-N9	-5.43	122.74	126.00
1	A	1922	C	C5-C6-N1	5.43	123.72	121.00
1	A	1973	G	N3-C4-N9	-5.42	122.75	126.00
1	A	3125	A	N9-C4-C5	-5.42	103.63	105.80

Continued on next page...

Continued from previous page...

Mol	Chain	Res	Type	Atoms	Z	Observed(°)	Ideal(°)
16	R	67	LEU	CA-CB-CG	5.42	127.77	115.30
1	A	2865	C	C6-N1-C2	-5.42	118.13	120.30
1	A	2445	U	C2-N1-C1'	5.41	124.19	117.70
1	A	2001	C	N3-C4-C5	5.41	124.06	121.90
1	A	2020	U	N3-C2-O2	-5.41	118.42	122.20
1	A	2129	G	C4-C5-N7	5.40	112.96	110.80
1	A	1997	C	N3-C4-C5	5.40	124.06	121.90
1	A	1915	C	C6-N1-C2	-5.40	118.14	120.30
1	A	2375	C	C2-N1-C1'	5.40	124.74	118.80
1	A	2017	U	N3-C2-O2	-5.39	118.43	122.20
1	A	1879	G	N3-C4-N9	5.38	129.23	126.00
1	A	2929	C	C6-N1-C2	-5.38	118.15	120.30
1	A	1869	A	O5'-P-OP1	-5.38	100.86	105.70
1	A	2854	U	N1-C2-O2	5.38	126.56	122.80
1	A	1792	G	N9-C4-C5	-5.37	103.25	105.40
1	A	2141	U	O5'-P-OP1	-5.37	100.86	105.70
1	A	2377	G	N1-C6-O6	-5.36	116.68	119.90
1	A	2660	U	N3-C2-O2	-5.36	118.45	122.20
1	A	2729	U	N3-C2-O2	-5.36	118.45	122.20
1	A	2473	A	C4-N9-C1'	5.35	135.94	126.30
51	s	301	LEU	CA-CB-CG	5.35	127.61	115.30
1	A	2898	U	N1-C2-N3	5.35	118.11	114.90
1	A	2258	A	C4-C5-N7	5.35	113.37	110.70
1	A	2417	C	N3-C2-O2	-5.34	118.16	121.90
1	A	2287	U	C5-C6-N1	5.34	125.37	122.70
1	A	2441	C	C5-C6-N1	5.34	123.67	121.00
1	A	2793	C	C6-N1-C2	-5.34	118.16	120.30
1	A	1987	G	C4-N9-C1'	5.34	133.44	126.50
1	A	3157	C	N3-C2-O2	-5.33	118.17	121.90
1	A	3222	C	C5-C6-N1	5.33	123.66	121.00
1	A	1903	C	C6-N1-C2	-5.32	118.17	120.30
1	A	1699	C	N1-C2-O2	5.32	122.09	118.90
1	A	1884	G	C8-N9-C4	5.32	108.53	106.40
1	A	2329	C	N3-C2-O2	-5.32	118.17	121.90
1	A	2688	C	C5-C6-N1	5.32	123.66	121.00
1	A	2857	U	C5-C6-N1	5.32	125.36	122.70
1	A	2129	G	N9-C4-C5	-5.31	103.28	105.40
1	A	2445	U	C6-N1-C1'	-5.31	113.77	121.20
51	s	299	PHE	CB-CG-CD1	5.31	124.51	120.80
1	A	2667	U	N3-C2-O2	-5.30	118.49	122.20
1	A	2252	C	N1-C2-O2	5.29	122.07	118.90
1	A	1916	G	C6-N1-C2	-5.28	121.93	125.10

Continued on next page...

Continued from previous page...

Mol	Chain	Res	Type	Atoms	Z	Observed(°)	Ideal(°)
1	A	1751	A	C4-N9-C1'	5.28	135.80	126.30
1	A	2047	U	N1-C2-O2	5.27	126.49	122.80
35	b	26	LEU	CA-CB-CG	5.27	127.43	115.30
1	A	1879	G	C8-N9-C1'	-5.26	120.16	127.00
35	b	11	LEU	CA-CB-CG	5.26	127.41	115.30
1	A	2259	C	N3-C2-O2	-5.26	118.22	121.90
23	Y	226	LEU	CA-CB-CG	5.26	127.40	115.30
1	A	1754	G	N3-C2-N2	5.26	123.58	119.90
28	3	157	LEU	CA-CB-CG	5.25	127.39	115.30
1	A	2375	C	C4-C5-C6	-5.25	114.77	117.40
1	A	1777	A	O4'-C1'-N9	5.25	112.40	108.20
1	A	2809	C	C6-N1-C2	-5.24	118.20	120.30
1	A	1984	A	N1-C2-N3	-5.24	126.68	129.30
1	A	2898	U	O4'-C1'-N1	5.23	112.39	108.20
1	A	1884	G	N3-C4-C5	5.23	131.22	128.60
1	A	2135	A	O4'-C1'-N9	5.23	112.38	108.20
1	A	2164	C	N3-C2-O2	-5.23	118.24	121.90
1	A	2258	A	C5-N7-C8	-5.23	101.28	103.90
42	i	38	LEU	CA-CB-CG	5.21	127.29	115.30
1	A	2276	C	C5-C6-N1	5.21	123.60	121.00
1	A	2650	C	N1-C2-O2	5.21	122.02	118.90
1	A	2871	U	C2-N1-C1'	5.20	123.94	117.70
1	A	2173	G	N3-C4-N9	5.19	129.11	126.00
1	A	3214	C	C6-N1-C2	-5.18	118.23	120.30
1	A	1672	C	N3-C4-C5	5.18	123.97	121.90
1	A	2302	U	C5-C4-O4	-5.18	122.79	125.90
1	A	2930	U	N3-C2-O2	-5.18	118.58	122.20
1	A	2823	U	N3-C2-O2	-5.17	118.58	122.20
1	A	2473	A	C2-N3-C4	5.17	113.19	110.60
1	A	2311	U	N1-C2-O2	5.16	126.41	122.80
1	A	2656	U	N1-C2-O2	5.16	126.41	122.80
1	A	2171	U	C5-C6-N1	5.15	125.28	122.70
1	A	1828	A	N1-C2-N3	-5.15	126.72	129.30
1	A	1783	U	C6-N1-C2	-5.15	117.91	121.00
1	A	2300	G	C4-N9-C1'	5.15	133.19	126.50
1	A	1778	U	C2-N1-C1'	5.15	123.88	117.70
1	A	1789	A	C4-C5-C6	-5.15	114.43	117.00
1	A	1726	C	C5-C6-N1	5.14	123.57	121.00
1	A	2093	U	C2-N1-C1'	5.14	123.87	117.70
1	A	2868	C	C4-C5-C6	-5.14	114.83	117.40
1	A	1805	A	P-O3'-C3'	5.14	125.87	119.70
1	A	1839	C	C6-N1-C2	-5.14	118.24	120.30

Continued on next page...

Continued from previous page...

Mol	Chain	Res	Type	Atoms	Z	Observed(°)	Ideal(°)
1	A	2445	U	N1-C2-O2	5.13	126.39	122.80
1	A	2667	U	N1-C2-O2	5.13	126.39	122.80
1	A	2688	C	C6-N1-C2	-5.12	118.25	120.30
1	A	1872	U	N1-C2-O2	5.12	126.39	122.80
1	A	2241	A	C4-C5-N7	5.12	113.26	110.70
1	A	1681	G	N1-C6-O6	-5.12	116.83	119.90
1	A	1780	U	OP1-P-O3'	5.12	116.47	105.20
1	A	1694	U	N3-C2-O2	-5.12	118.62	122.20
2	B	1659	U	N1-C2-O2	5.12	126.38	122.80
30	6	217	LEU	CA-CB-CG	5.12	127.08	115.30
1	A	1845	C	C4-C5-C6	-5.11	114.84	117.40
1	A	2166	C	C6-N1-C2	-5.10	118.26	120.30
1	A	2080	U	C2-N1-C1'	5.10	123.82	117.70
1	A	1741	A	C5-C6-N6	-5.10	119.62	123.70
1	A	2076	C	C5-C6-N1	5.10	123.55	121.00
1	A	1879	G	N9-C4-C5	-5.09	103.36	105.40
1	A	2727	C	N3-C2-O2	-5.09	118.34	121.90
1	A	2905	A	P-O3'-C3'	5.09	125.81	119.70
1	A	2697	G	C4-C5-N7	5.08	112.83	110.80
51	s	299	PHE	CB-CG-CD2	-5.08	117.24	120.80
1	A	1713	A	P-O3'-C3'	5.08	125.80	119.70
1	A	1784	A	N9-C4-C5	-5.08	103.77	105.80
15	Q	151	LEU	CA-CB-CG	5.08	126.99	115.30
1	A	2025	C	C5-C6-N1	5.08	123.54	121.00
1	A	1844	A	C5-N7-C8	-5.08	101.36	103.90
1	A	2750	U	C5-C6-N1	5.08	125.24	122.70
1	A	1723	A	N1-C6-N6	-5.08	115.56	118.60
1	A	2280	C	N3-C2-O2	-5.08	118.35	121.90
1	A	2136	C	C6-N1-C2	-5.07	118.27	120.30
1	A	1844	A	C4-C5-N7	5.07	113.24	110.70
2	B	1659	U	N3-C2-O2	-5.07	118.65	122.20
1	A	2251	A	C2-N3-C4	5.07	113.13	110.60
1	A	2854	U	N3-C2-O2	-5.07	118.65	122.20
38	e	84	TYR	CA-CB-CG	5.07	123.03	113.40
1	A	1812	C	C5-C6-N1	5.06	123.53	121.00
11	M	39	ARG	NE-CZ-NH1	-5.05	117.78	120.30
2	B	1633	U	N3-C2-O2	-5.05	118.67	122.20
1	A	1775	A	C5-C6-N1	5.04	120.22	117.70
1	A	1900	A	N3-C4-N9	-5.04	123.37	127.40
1	A	2187	C	N1-C2-O2	5.04	121.92	118.90
1	A	2898	U	N1-C2-O2	5.03	126.32	122.80
1	A	2277	U	C4-C5-C6	-5.03	116.68	119.70

Continued on next page...

Continued from previous page...

Mol	Chain	Res	Type	Atoms	Z	Observed(°)	Ideal(°)
1	A	2744	U	O4'-C1'-N1	5.03	112.22	108.20
1	A	3150	U	C5-C6-N1	5.03	125.21	122.70
1	A	1812	C	C6-N1-C2	-5.02	118.29	120.30
1	A	2186	C	P-O3'-C3'	5.02	125.72	119.70
1	A	2416	U	C5-C6-N1	5.02	125.21	122.70
1	A	1677	C	C6-N1-C1'	5.01	126.82	120.80
1	A	2834	C	C5-C6-N1	5.01	123.51	121.00
1	A	2243	A	OP2-P-O3'	5.01	116.23	105.20
1	A	2205	U	C2-N1-C1'	5.01	123.71	117.70
1	A	1737	A	C5-C6-N1	5.01	120.20	117.70
1	A	2906	C	C6-N1-C2	-5.01	118.30	120.30
1	A	3192	C	C5-C6-N1	5.01	123.50	121.00
1	A	2041	U	N3-C2-O2	-5.00	118.70	122.20
2	B	1637	C	C6-N1-C2	-5.00	118.30	120.30
4	E	187	ILE	CG1-CB-CG2	-5.00	100.39	111.40

There are no chirality outliers.

All (6) planarity outliers are listed below:

Mol	Chain	Res	Type	Group
26	1	25	GLY	Peptide
31	7	159	LYS	Peptide
8	J	69	LYS	Peptide
40	g	110	ILE	Peptide
46	m	53	PRO	Mainchain
51	s	270	LYS	Peptide

5.2 Too-close contacts [i](#)

Due to software issues we are unable to calculate clashes - this section is therefore empty.

5.3 Torsion angles [i](#)

5.3.1 Protein backbone [i](#)

In the following table, the Percentiles column shows the percent Ramachandran outliers of the chain as a percentile score with respect to all PDB entries followed by that with respect to all EM entries.

The Analysed column shows the number of residues for which the backbone conformation was analysed, and the total number of residues.

Mol	Chain	Analysed	Favoured	Allowed	Outliers	Percentiles	
3	D	216/305 (71%)	203 (94%)	13 (6%)	0	100	100
4	E	281/348 (81%)	273 (97%)	8 (3%)	0	100	100
5	F	248/311 (80%)	234 (94%)	14 (6%)	0	100	100
6	H	93/267 (35%)	85 (91%)	7 (8%)	1 (1%)	14	47
7	I	154/261 (59%)	141 (92%)	13 (8%)	0	100	100
8	J	138/192 (72%)	120 (87%)	18 (13%)	0	100	100
9	K	175/178 (98%)	166 (95%)	9 (5%)	0	100	100
10	L	113/145 (78%)	106 (94%)	7 (6%)	0	100	100
11	M	285/296 (96%)	275 (96%)	10 (4%)	0	100	100
12	N	203/251 (81%)	192 (95%)	11 (5%)	0	100	100
13	O	150/175 (86%)	145 (97%)	5 (3%)	0	100	100
14	P	139/180 (77%)	130 (94%)	9 (6%)	0	100	100
15	Q	215/292 (74%)	200 (93%)	15 (7%)	0	100	100
16	R	138/149 (93%)	133 (96%)	5 (4%)	0	100	100
17	S	154/205 (75%)	147 (96%)	7 (4%)	0	100	100
18	T	155/206 (75%)	152 (98%)	3 (2%)	0	100	100
19	U	135/153 (88%)	126 (93%)	9 (7%)	0	100	100
20	V	188/216 (87%)	183 (97%)	5 (3%)	0	100	100
21	W	107/148 (72%)	103 (96%)	4 (4%)	0	100	100
22	X	241/256 (94%)	233 (97%)	8 (3%)	0	100	100
23	Y	174/250 (70%)	170 (98%)	4 (2%)	0	100	100
24	Z	118/161 (73%)	110 (93%)	8 (7%)	0	100	100
25	0	106/188 (56%)	101 (95%)	5 (5%)	0	100	100
26	1	50/65 (77%)	49 (98%)	1 (2%)	0	100	100
27	2	41/92 (45%)	40 (98%)	1 (2%)	0	100	100
28	3	93/188 (50%)	87 (94%)	6 (6%)	0	100	100
29	5	383/423 (90%)	363 (95%)	20 (5%)	0	100	100
30	6	316/380 (83%)	300 (95%)	16 (5%)	0	100	100
31	7	285/338 (84%)	262 (92%)	23 (8%)	0	100	100
32	8	97/206 (47%)	88 (91%)	9 (9%)	0	100	100
33	9	113/137 (82%)	109 (96%)	4 (4%)	0	100	100
34	a	78/142 (55%)	74 (95%)	4 (5%)	0	100	100

Continued on next page...

Continued from previous page...

Mol	Chain	Analysed	Favoured	Allowed	Outliers	Percentiles	
35	b	146/215 (68%)	130 (89%)	16 (11%)	0	100	100
36	c	271/332 (82%)	264 (97%)	7 (3%)	0	100	100
37	d	203/306 (66%)	191 (94%)	12 (6%)	0	100	100
38	e	211/279 (76%)	179 (85%)	31 (15%)	1 (0%)	29	65
39	f	110/212 (52%)	98 (89%)	11 (10%)	1 (1%)	17	52
40	g	127/166 (76%)	115 (91%)	12 (9%)	0	100	100
41	h	96/158 (61%)	93 (97%)	3 (3%)	0	100	100
42	i	95/128 (74%)	90 (95%)	5 (5%)	0	100	100
43	j	83/123 (68%)	81 (98%)	2 (2%)	0	100	100
44	k	76/112 (68%)	71 (93%)	5 (7%)	0	100	100
45	l	21/138 (15%)	21 (100%)	0	0	100	100
46	m	43/128 (34%)	37 (86%)	4 (9%)	2 (5%)	2	12
47	o	77/102 (76%)	76 (99%)	1 (1%)	0	100	100
48	p	119/206 (58%)	114 (96%)	5 (4%)	0	100	100
49	q	126/222 (57%)	124 (98%)	2 (2%)	0	100	100
50	r	140/196 (71%)	134 (96%)	6 (4%)	0	100	100
51	s	366/439 (83%)	354 (97%)	12 (3%)	0	100	100
53	u	109/234 (47%)	100 (92%)	9 (8%)	0	100	100
54	v	67/70 (96%)	66 (98%)	1 (2%)	0	100	100
55	w	77/156 (49%)	69 (90%)	8 (10%)	0	100	100
All	All	7945/11026 (72%)	7507 (94%)	433 (5%)	5 (0%)	54	84

All (5) Ramachandran outliers are listed below:

Mol	Chain	Res	Type
46	m	71	PRO
6	H	104	ASN
38	e	256	THR
39	f	179	PRO
46	m	53	PRO

5.3.2 Protein sidechains [i](#)

In the following table, the Percentiles column shows the percent sidechain outliers of the chain as a percentile score with respect to all PDB entries followed by that with respect to all EM

entries.

The Analysed column shows the number of residues for which the sidechain conformation was analysed, and the total number of residues.

Mol	Chain	Analysed	Rotameric	Outliers	Percentiles	
3	D	179/245 (73%)	177 (99%)	2 (1%)	73	90
4	E	246/290 (85%)	244 (99%)	2 (1%)	81	92
5	F	217/262 (83%)	211 (97%)	6 (3%)	43	75
6	H	86/228 (38%)	86 (100%)	0	100	100
7	I	145/232 (62%)	144 (99%)	1 (1%)	84	93
8	J	113/150 (75%)	113 (100%)	0	100	100
9	K	155/156 (99%)	153 (99%)	2 (1%)	69	88
10	L	98/124 (79%)	97 (99%)	1 (1%)	76	91
11	M	245/249 (98%)	240 (98%)	5 (2%)	55	81
12	N	172/211 (82%)	169 (98%)	3 (2%)	60	84
13	O	133/150 (89%)	132 (99%)	1 (1%)	81	92
14	P	123/155 (79%)	121 (98%)	2 (2%)	62	85
15	Q	199/256 (78%)	198 (100%)	1 (0%)	88	95
16	R	118/126 (94%)	118 (100%)	0	100	100
17	S	141/180 (78%)	141 (100%)	0	100	100
18	T	141/176 (80%)	141 (100%)	0	100	100
19	U	124/135 (92%)	122 (98%)	2 (2%)	62	85
20	V	172/191 (90%)	167 (97%)	5 (3%)	42	74
21	W	89/119 (75%)	88 (99%)	1 (1%)	73	90
22	X	219/229 (96%)	214 (98%)	5 (2%)	50	78
23	Y	159/223 (71%)	156 (98%)	3 (2%)	57	82
24	Z	111/147 (76%)	111 (100%)	0	100	100
25	0	97/164 (59%)	95 (98%)	2 (2%)	53	80
26	1	49/60 (82%)	46 (94%)	3 (6%)	18	50
27	2	38/72 (53%)	38 (100%)	0	100	100
28	3	88/166 (53%)	86 (98%)	2 (2%)	50	78
29	5	348/368 (95%)	341 (98%)	7 (2%)	55	81
30	6	265/332 (80%)	262 (99%)	3 (1%)	73	90
31	7	263/303 (87%)	260 (99%)	3 (1%)	73	90

Continued on next page...

Continued from previous page...

Mol	Chain	Analysed	Rotameric	Outliers	Percentiles	
32	8	91/190 (48%)	90 (99%)	1 (1%)	73	90
33	9	99/112 (88%)	99 (100%)	0	100	100
34	a	78/133 (59%)	76 (97%)	2 (3%)	46	76
35	b	130/186 (70%)	128 (98%)	2 (2%)	65	86
36	c	241/288 (84%)	239 (99%)	2 (1%)	81	92
37	d	193/274 (70%)	191 (99%)	2 (1%)	76	91
38	e	188/236 (80%)	185 (98%)	3 (2%)	62	85
39	f	101/188 (54%)	101 (100%)	0	100	100
40	g	119/148 (80%)	117 (98%)	2 (2%)	60	84
41	h	95/148 (64%)	93 (98%)	2 (2%)	53	80
42	i	86/110 (78%)	85 (99%)	1 (1%)	71	89
43	j	68/97 (70%)	68 (100%)	0	100	100
44	k	71/90 (79%)	71 (100%)	0	100	100
45	l	23/116 (20%)	23 (100%)	0	100	100
46	m	40/113 (35%)	39 (98%)	1 (2%)	47	77
47	o	68/87 (78%)	68 (100%)	0	100	100
48	p	117/181 (65%)	116 (99%)	1 (1%)	78	91
49	q	110/178 (62%)	106 (96%)	4 (4%)	35	68
50	r	133/169 (79%)	131 (98%)	2 (2%)	65	86
51	s	326/381 (86%)	320 (98%)	6 (2%)	59	83
53	u	105/200 (52%)	105 (100%)	0	100	100
54	v	59/60 (98%)	58 (98%)	1 (2%)	60	84
55	w	73/136 (54%)	72 (99%)	1 (1%)	67	86
All	All	7147/9520 (75%)	7052 (99%)	95 (1%)	70	88

All (95) residues with a non-rotameric sidechain are listed below:

Mol	Chain	Res	Type
3	D	147	ARG
3	D	206	TYR
4	E	275	ARG
4	E	284	TYR
5	F	108	ARG
5	F	125	ARG

Continued on next page...

Continued from previous page...

Mol	Chain	Res	Type
5	F	147	ARG
5	F	170	ARG
5	F	259	LEU
5	F	281	ARG
7	I	146	LEU
9	K	16	ARG
9	K	125	LEU
10	L	39	ARG
11	M	44	ARG
11	M	47	ARG
11	M	57	ARG
11	M	96	LEU
11	M	134	ARG
12	N	51	ARG
12	N	105	MET
12	N	226	ILE
13	O	36	LEU
14	P	51	ARG
14	P	120	ARG
15	Q	151	LEU
19	U	3	ARG
19	U	71	ARG
20	V	92	ASN
20	V	138	THR
20	V	143	ARG
20	V	145	ARG
20	V	208	ARG
21	W	105	VAL
22	X	23	ARG
22	X	36	ARG
22	X	59	ARG
22	X	130	ARG
22	X	216	ARG
23	Y	162	ARG
23	Y	191	ASN
23	Y	210	ARG
25	0	84	ARG
25	0	168	GLN
26	1	34	ARG
26	1	38	ARG
26	1	61	LYS
28	3	125	ARG

Continued on next page...

Continued from previous page...

Mol	Chain	Res	Type
28	3	168	ARG
29	5	36	ARG
29	5	98	LEU
29	5	102	GLN
29	5	106	ILE
29	5	218	LEU
29	5	229	ARG
29	5	350	ARG
30	6	52	ARG
30	6	159	ARG
30	6	334	LEU
31	7	64	LYS
31	7	167	VAL
31	7	319	ARG
32	8	101	ARG
34	a	111	GLN
34	a	122	ARG
35	b	11	LEU
35	b	144	ARG
36	c	87	LEU
36	c	202	LEU
37	d	119	GLN
37	d	164	VAL
38	e	55	ARG
38	e	151	ARG
38	e	273	ARG
40	g	68	THR
40	g	100	ILE
41	h	96	LEU
41	h	120	MET
42	i	113	ARG
46	m	42	ARG
48	p	129	ARG
49	q	28	ARG
49	q	46	LEU
49	q	82	LEU
49	q	114	ARG
50	r	36	ARG
50	r	74	ARG
51	s	81	ARG
51	s	230	ARG
51	s	238	ASN

Continued on next page...

Continued from previous page...

Mol	Chain	Res	Type
51	s	299	PHE
51	s	360	VAL
51	s	361	ILE
54	v	63	ASN
55	w	106	LYS

Sometimes sidechains can be flipped to improve hydrogen bonding and reduce clashes. All (39) such sidechains are listed below:

Mol	Chain	Res	Type
3	D	205	GLN
3	D	227	GLN
4	E	184	ASN
6	H	121	ASN
10	L	142	GLN
11	M	170	ASN
13	O	147	GLN
14	P	87	GLN
16	R	89	ASN
16	R	125	HIS
17	S	118	ASN
17	S	140	ASN
18	T	210	HIS
19	U	4	ASN
19	U	82	HIS
20	V	92	ASN
21	W	62	HIS
22	X	46	HIS
23	Y	195	ASN
25	0	106	ASN
29	5	305	GLN
30	6	320	GLN
30	6	332	HIS
30	6	359	HIS
32	8	143	GLN
35	b	27	GLN
37	d	167	HIS
37	d	251	GLN
38	e	212	HIS
39	f	112	ASN
41	h	87	GLN
42	i	120	HIS
42	i	124	HIS

Continued on next page...

Continued from previous page...

Mol	Chain	Res	Type
44	k	26	ASN
50	r	112	HIS
51	s	238	ASN
51	s	298	GLN
54	v	63	ASN
55	w	103	HIS

5.3.3 RNA [i](#)

Mol	Chain	Analysed	Backbone Outliers	Pucker Outliers
1	A	1071/1559 (68%)	302 (28%)	17 (1%)
2	B	51/69 (73%)	15 (29%)	1 (1%)
All	All	1122/1628 (68%)	317 (28%)	18 (1%)

All (317) RNA backbone outliers are listed below:

Mol	Chain	Res	Type
1	A	1676	A
1	A	1677	C
1	A	1678	C
1	A	1679	U
1	A	1681	G
1	A	1689	C
1	A	1694	U
1	A	1700	U
1	A	1701	U
1	A	1703	C
1	A	1704	U
1	A	1707	C
1	A	1708	A
1	A	1713	A
1	A	1714	C
1	A	1715	C
1	A	1716	U
1	A	1717	U
1	A	1719	G
1	A	1724	A
1	A	1727	A
1	A	1728	U
1	A	1731	A
1	A	1741	A

Continued on next page...

Continued from previous page...

Mol	Chain	Res	Type
1	A	1748	G
1	A	1750	G
1	A	1751	A
1	A	1760	G
1	A	1770	G
1	A	1773	A
1	A	1775	A
1	A	1781	A
1	A	1791	G
1	A	1794	A
1	A	1803	A
1	A	1804	A
1	A	1805	A
1	A	1806	U
1	A	1812	C
1	A	1813	C
1	A	1817	C
1	A	1820	A
1	A	1823	A
1	A	1824	U
1	A	1827	C
1	A	1828	A
1	A	1829	A
1	A	1832	A
1	A	1836	A
1	A	1844	A
1	A	1849	C
1	A	1861	U
1	A	1867	A
1	A	1869	A
1	A	1870	A
1	A	1871	A
1	A	1872	U
1	A	1874	A
1	A	1875	C
1	A	1878	U
1	A	1882	A
1	A	1883	G
1	A	1887	A
1	A	1888	G
1	A	1890	C
1	A	1892	A

Continued on next page...

Continued from previous page...

Mol	Chain	Res	Type
1	A	1893	A
1	A	1901	C
1	A	1903	C
1	A	1914	A
1	A	1918	G
1	A	1927	G
1	A	1975	U
1	A	1985	G
1	A	1987	G
1	A	1992	C
1	A	1994	A
1	A	2000	C
1	A	2001	C
1	A	2002	G
1	A	2004	G
1	A	2015	G
1	A	2020	U
1	A	2021	U
1	A	2022	G
1	A	2023	U
1	A	2027	A
1	A	2028	G
1	A	2029	A
1	A	2030	U
1	A	2031	A
1	A	2032	G
1	A	2036	C
1	A	2037	U
1	A	2039	A
1	A	2041	U
1	A	2053	U
1	A	2055	U
1	A	2060	A
1	A	2065	A
1	A	2074	A
1	A	2079	C
1	A	2083	U
1	A	2085	A
1	A	2095	U
1	A	2105	G
1	A	2113	G
1	A	2124	A

Continued on next page...

Continued from previous page...

Mol	Chain	Res	Type
1	A	2125	C
1	A	2126	U
1	A	2132	A
1	A	2134	A
1	A	2142	A
1	A	2147	G
1	A	2154	A
1	A	2156	A
1	A	2157	U
1	A	2158	U
1	A	2159	U
1	A	2161	A
1	A	2163	A
1	A	2166	C
1	A	2168	U
1	A	2171	U
1	A	2172	A
1	A	2173	G
1	A	2174	G
1	A	2180	A
1	A	2181	A
1	A	2182	G
1	A	2183	C
1	A	2187	C
1	A	2190	C
1	A	2193	U
1	A	2194	U
1	A	2195	A
1	A	2197	G
1	A	2198	A
1	A	2200	A
1	A	2204	U
1	A	2207	A
1	A	2210	C
1	A	2216	A
1	A	2237	A
1	A	2239	A
1	A	2241	A
1	A	2243	A
1	A	2244	U
1	A	2245	A
1	A	2257	C

Continued on next page...

Continued from previous page...

Mol	Chain	Res	Type
1	A	2259	C
1	A	2261	C
1	A	2262	C
1	A	2263	C
1	A	2264	A
1	A	2281	A
1	A	2283	C
1	A	2284	C
1	A	2285	U
1	A	2290	A
1	A	2296	U
1	A	2297	A
1	A	2299	U
1	A	2300	G
1	A	2306	A
1	A	2313	A
1	A	2315	A
1	A	2321	A
1	A	2323	A
1	A	2324	U
1	A	2332	C
1	A	2335	A
1	A	2342	U
1	A	2345	G
1	A	2371	U
1	A	2374	A
1	A	2375	C
1	A	2381	A
1	A	2387	U
1	A	2389	C
1	A	2390	A
1	A	2393	C
1	A	2396	C
1	A	2401	A
1	A	2405	C
1	A	2406	A
1	A	2407	U
1	A	2414	C
1	A	2415	C
1	A	2417	C
1	A	2418	A
1	A	2426	C

Continued on next page...

Continued from previous page...

Mol	Chain	Res	Type
1	A	2427	C
1	A	2431	C
1	A	2435	G
1	A	2443	C
1	A	2444	A
1	A	2445	U
1	A	2446	A
1	A	2449	G
1	A	2457	A
1	A	2458	A
1	A	2468	A
1	A	2508	C
1	A	2511	C
1	A	2512	A
1	A	2520	C
1	A	2521	A
1	A	2522	U
1	A	2523	C
1	A	2524	A
1	A	2526	C
1	A	2527	A
1	A	2655	G
1	A	2656	U
1	A	2659	C
1	A	2660	U
1	A	2683	C
1	A	2684	C
1	A	2686	G
1	A	2698	G
1	A	2699	C
1	A	2706	A
1	A	2707	A
1	A	2708	C
1	A	2709	A
1	A	2725	A
1	A	2732	G
1	A	2734	A
1	A	2739	U
1	A	2740	A
1	A	2744	U
1	A	2750	U
1	A	2752	C

Continued on next page...

Continued from previous page...

Mol	Chain	Res	Type
1	A	2803	A
1	A	2804	A
1	A	2810	G
1	A	2813	U
1	A	2814	G
1	A	2815	G
1	A	2831	G
1	A	2832	A
1	A	2833	A
1	A	2844	G
1	A	2846	G
1	A	2847	C
1	A	2852	C
1	A	2854	U
1	A	2859	A
1	A	2861	A
1	A	2864	U
1	A	2865	C
1	A	2870	G
1	A	2871	U
1	A	2879	A
1	A	2893	A
1	A	2895	U
1	A	2896	G
1	A	2901	A
1	A	2906	C
1	A	2910	A
1	A	2912	C
1	A	2913	A
1	A	2914	A
1	A	2915	C
1	A	2917	G
1	A	2922	A
1	A	2926	A
1	A	2928	C
1	A	3102	U
1	A	3108	U
1	A	3109	U
1	A	3114	U
1	A	3123	G
1	A	3124	U
1	A	3128	A

Continued on next page...

Continued from previous page...

Mol	Chain	Res	Type
1	A	3129	A
1	A	3131	G
1	A	3134	C
1	A	3137	G
1	A	3138	A
1	A	3139	G
1	A	3141	A
1	A	3150	U
1	A	3155	C
1	A	3157	C
1	A	3158	A
1	A	3160	A
1	A	3162	C
1	A	3168	C
1	A	3177	A
1	A	3180	A
1	A	3183	U
1	A	3184	C
1	A	3185	A
1	A	3189	C
1	A	3190	A
1	A	3202	U
1	A	3204	C
1	A	3207	A
1	A	3217	A
1	A	3218	A
2	B	1607	U
2	B	1608	G
2	B	1609	U
2	B	1611	G
2	B	1614	U
2	B	1615	A
2	B	1625	A
2	B	1631	C
2	B	1632	U
2	B	1640	A
2	B	1641	G
2	B	1644	G
2	B	1645	A
2	B	1649	C
2	B	1651	A

All (18) RNA pucker outliers are listed below:

Mol	Chain	Res	Type
1	A	1703	C
1	A	1713	A
1	A	1772	A
1	A	1780	U
1	A	1805	A
1	A	1823	A
1	A	2030	U
1	A	2125	C
1	A	2165	C
1	A	2172	A
1	A	2186	C
1	A	2243	A
1	A	2444	A
1	A	2457	A
1	A	2507	A
1	A	2905	A
1	A	3201	A
2	B	1607	U

5.4 Non-standard residues in protein, DNA, RNA chains [i](#)

There are no non-standard protein/DNA/RNA residues in this entry.

5.5 Carbohydrates [i](#)

There are no monosaccharides in this entry.

5.6 Ligand geometry [i](#)

Of 52 ligands modelled in this entry, 51 are monoatomic - leaving 1 for Mogul analysis.

In the following table, the Counts columns list the number of bonds (or angles) for which Mogul statistics could be retrieved, the number of bonds (or angles) that are observed in the model and the number of bonds (or angles) that are defined in the Chemical Component Dictionary. The Link column lists molecule types, if any, to which the group is linked. The Z score for a bond length (or angle) is the number of standard deviations the observed value is removed from the expected value. A bond length (or angle) with $|Z| > 2$ is considered an outlier worth inspection. RMSZ is the root-mean-square of all Z scores of the bond lengths (or angles).

Mol	Type	Chain	Res	Link	Bond lengths			Bond angles		
					Counts	RMSZ	# Z > 2	Counts	RMSZ	# Z > 2
58	PNS	v	101	55	13,20,21	2.39	4 (30%)	18,26,29	1.11	1 (5%)

In the following table, the Chirals column lists the number of chiral outliers, the number of chiral centers analysed, the number of these observed in the model and the number defined in the Chemical Component Dictionary. Similar counts are reported in the Torsion and Rings columns. '-' means no outliers of that kind were identified.

Mol	Type	Chain	Res	Link	Chirals	Torsions	Rings
58	PNS	v	101	55	-	7/24/26/27	-

All (4) bond length outliers are listed below:

Mol	Chain	Res	Type	Atoms	Z	Observed(Å)	Ideal(Å)
58	v	101	PNS	C34-N36	5.55	1.45	1.33
58	v	101	PNS	C39-N41	5.32	1.45	1.33
58	v	101	PNS	O40-C39	-2.18	1.18	1.23
58	v	101	PNS	O35-C34	-2.13	1.19	1.23

All (1) bond angle outliers are listed below:

Mol	Chain	Res	Type	Atoms	Z	Observed(°)	Ideal(°)
58	v	101	PNS	C31-C29-C32	2.55	113.25	108.82

There are no chirality outliers.

All (7) torsion outliers are listed below:

Mol	Chain	Res	Type	Atoms
58	v	101	PNS	C28-C29-C32-O33
58	v	101	PNS	C28-C29-C32-C34
58	v	101	PNS	C31-C29-C32-O33
58	v	101	PNS	N41-C42-C43-S44
58	v	101	PNS	C30-C29-C32-O33
58	v	101	PNS	C31-C29-C32-C34
58	v	101	PNS	C30-C29-C32-C34

There are no ring outliers.

No monomer is involved in short contacts.

The following is a two-dimensional graphical depiction of Mogul quality analysis of bond lengths, bond angles, torsion angles, and ring geometry for all instances of the Ligand of Interest. In addition, ligands with molecular weight > 250 and outliers as shown on the validation Tables will also be included. For torsion angles, if less than 5% of the Mogul distribution of torsion angles is within 10 degrees of the torsion angle in question, then that torsion angle is considered an outlier. Any bond that is central to one or more torsion angles identified as an outlier by Mogul will be highlighted in the graph. For rings, the root-mean-square deviation (RMSD) between the ring in question and similar rings identified by Mogul is calculated over all ring torsion angles. If the

average RMSD is greater than 60 degrees and the minimal RMSD between the ring in question and any Mogul-identified rings is also greater than 60 degrees, then that ring is considered an outlier. The outliers are highlighted in purple. The color gray indicates Mogul did not find sufficient equivalents in the CSD to analyse the geometry.

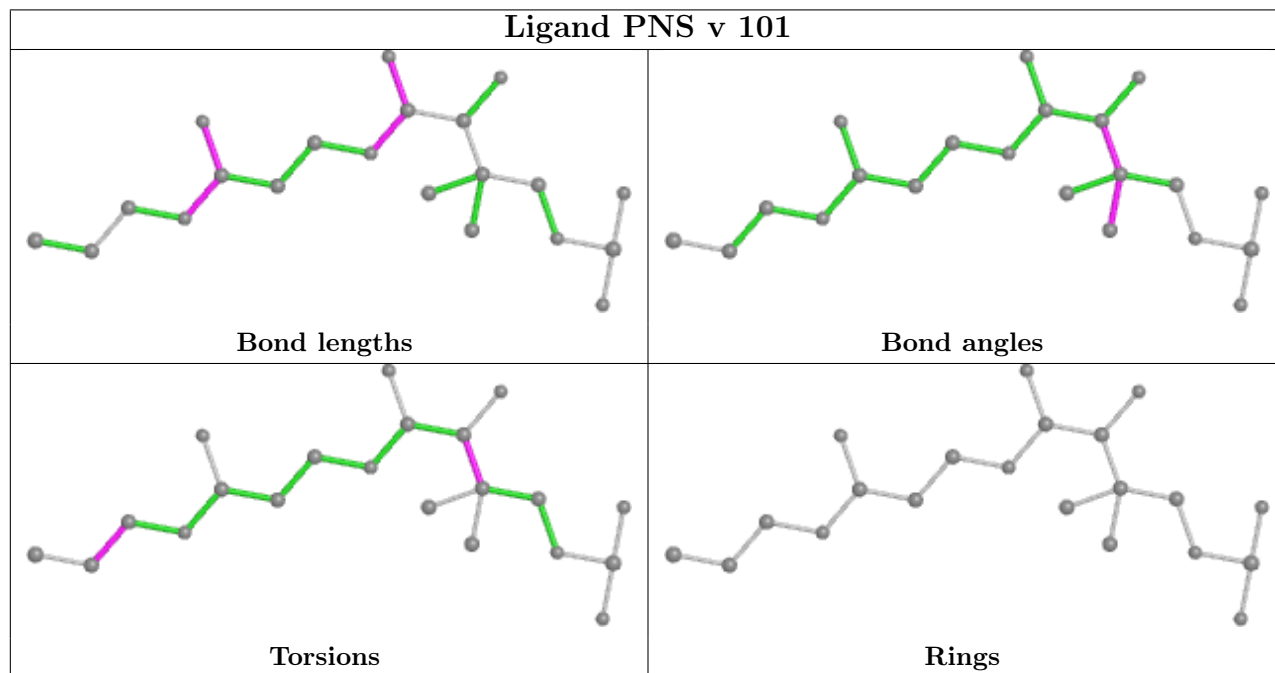

5.7 Other polymers [i](#)

There are no such residues in this entry.

5.8 Polymer linkage issues [i](#)

The following chains have linkage breaks:

Mol	Chain	Number of breaks
24	Z	1
42	i	1

All chain breaks are listed below:

Model	Chain	Residue-1	Atom-1	Residue-2	Atom-2	Distance (Å)
1	Z	151:LEU	C	152:LYS	N	1.17
1	i	68:LYS	C	69:HIS	N	1.16

6 Map visualisation [i](#)

This section contains visualisations of the EMDB entry EMD-3843. These allow visual inspection of the internal detail of the map and identification of artifacts.

Images derived from a raw map, generated by summing the deposited half-maps, are presented below the corresponding image components of the primary map to allow further visual inspection and comparison with those of the primary map.

6.1 Orthogonal projections [i](#)

6.1.1 Primary map

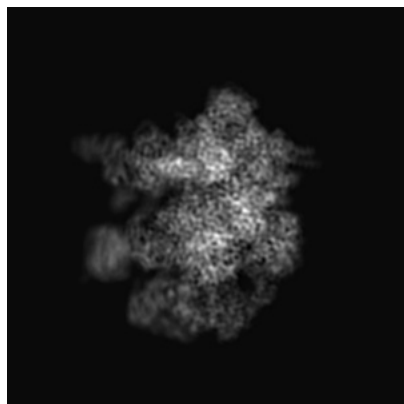

X

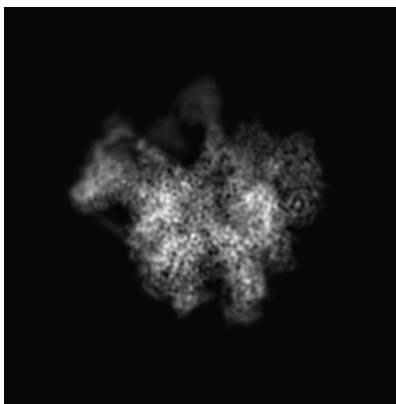

Y

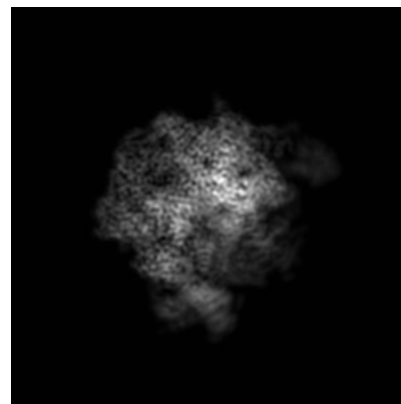

Z

6.1.2 Raw map

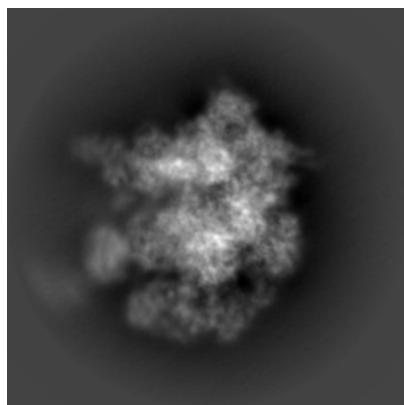

X

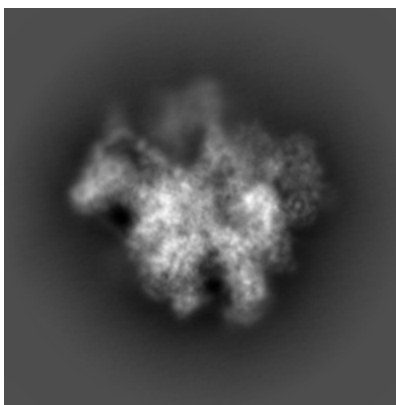

Y

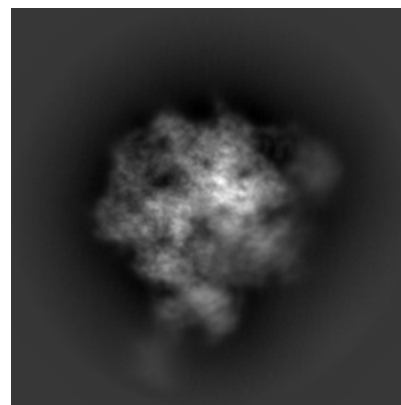

Z

The images above show the map projected in three orthogonal directions.

6.2 Central slices [i](#)

6.2.1 Primary map

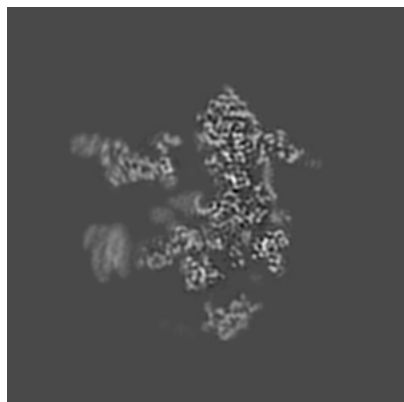

X Index: 176

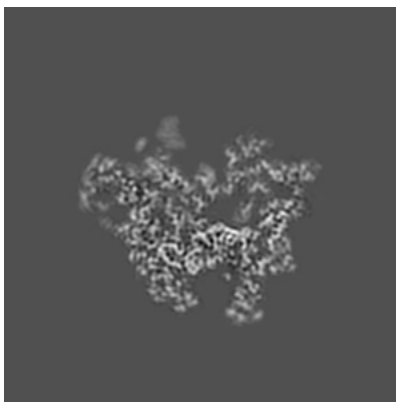

Y Index: 176

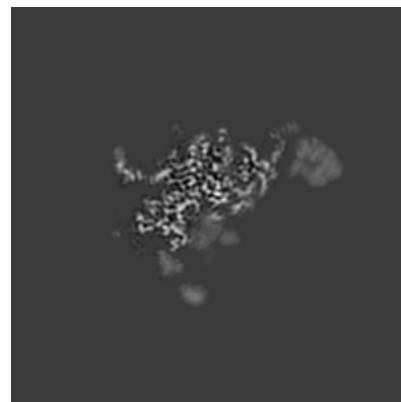

Z Index: 176

6.2.2 Raw map

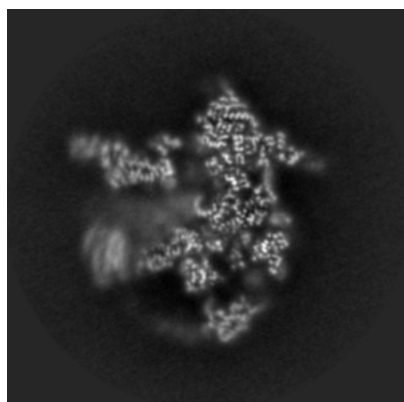

X Index: 176

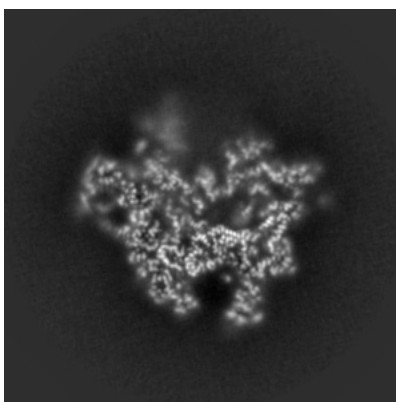

Y Index: 176

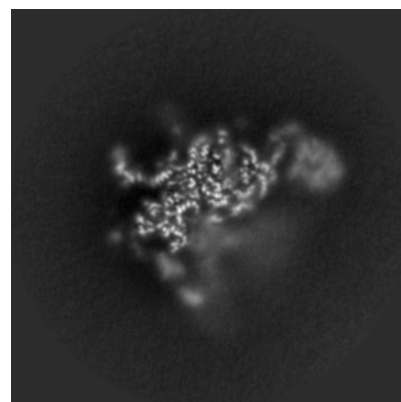

Z Index: 176

The images above show central slices of the map in three orthogonal directions.

6.3 Largest variance slices [i](#)

6.3.1 Primary map

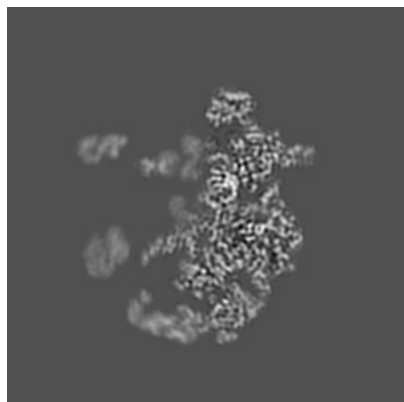

X Index: 188

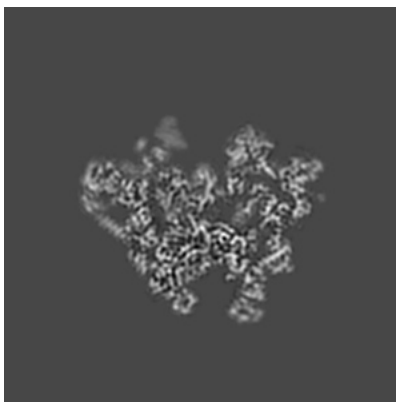

Y Index: 179

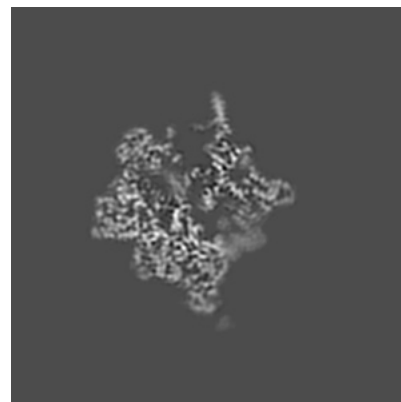

Z Index: 214

6.3.2 Raw map

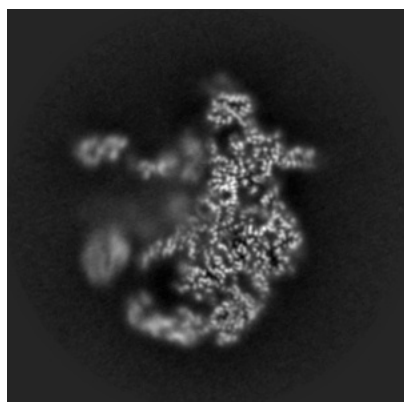

X Index: 187

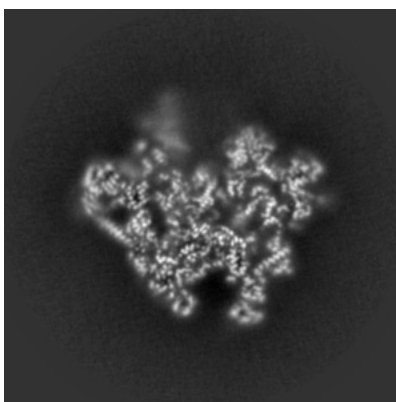

Y Index: 180

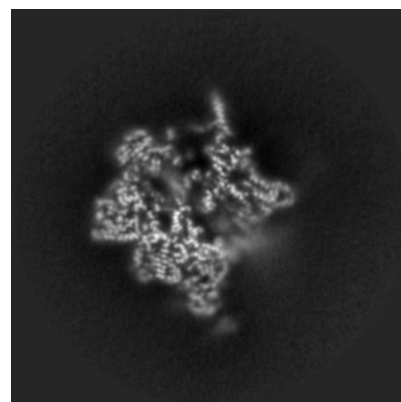

Z Index: 214

The images above show the largest variance slices of the map in three orthogonal directions.

6.4 Orthogonal surface views [i](#)

6.4.1 Primary map

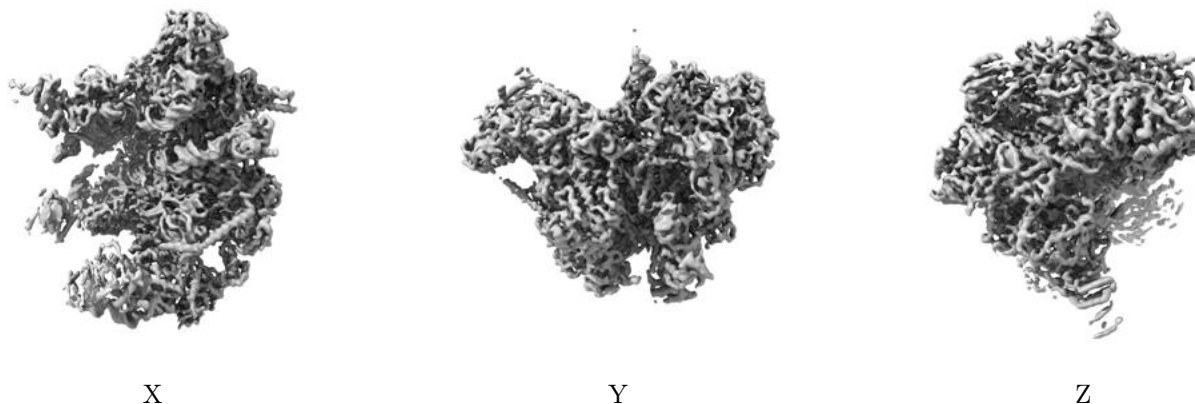

The images above show the 3D surface view of the map at the recommended contour level 0.075. These images, in conjunction with the slice images, may facilitate assessment of whether an appropriate contour level has been provided.

6.4.2 Raw map

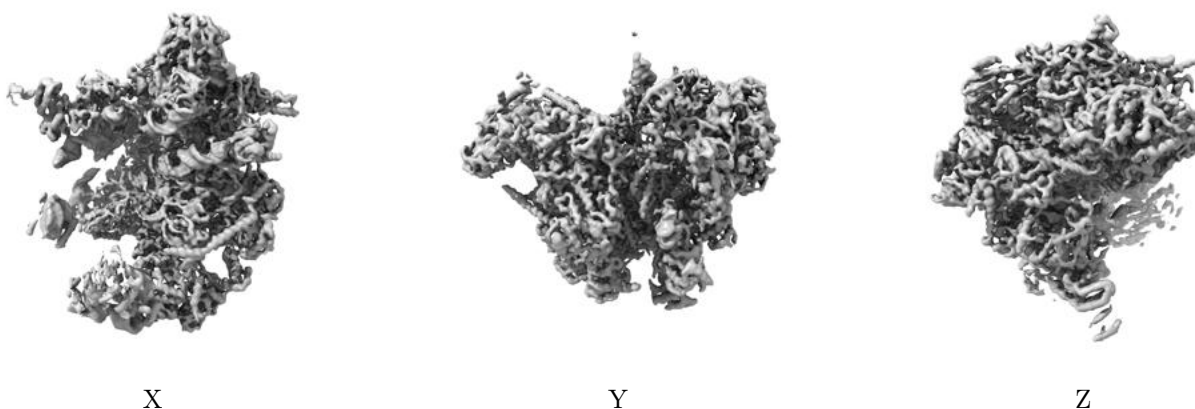

These images show the 3D surface of the raw map. The raw map's contour level was selected so that its surface encloses the same volume as the primary map does at its recommended contour level.

6.5 Mask visualisation [i](#)

This section shows the 3D surface view of the primary map at 50% transparency overlaid with the specified mask at 0% transparency

A mask typically either:

- Encompasses the whole structure
- Separates out a domain, a functional unit, a monomer or an area of interest from a larger structure

6.5.1 emd_3843_msk_1.map [i](#)

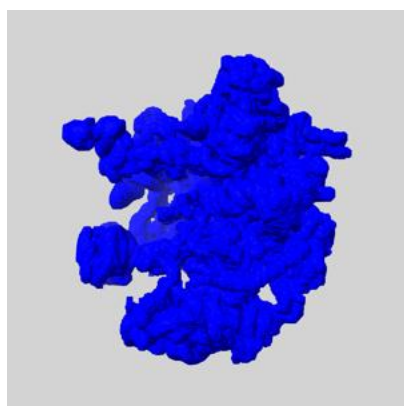

X

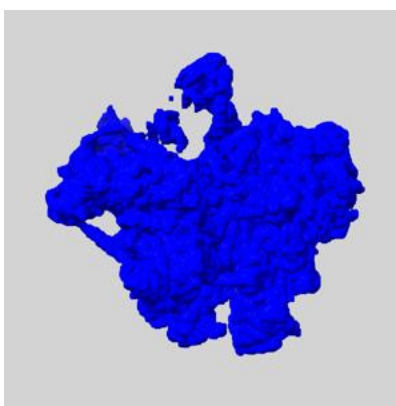

Y

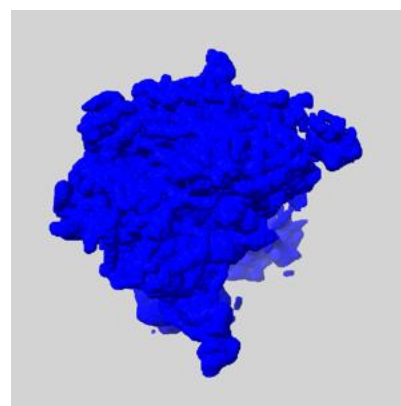

Z

7 Map analysis [i](#)

This section contains the results of statistical analysis of the map.

7.1 Map-value distribution [i](#)

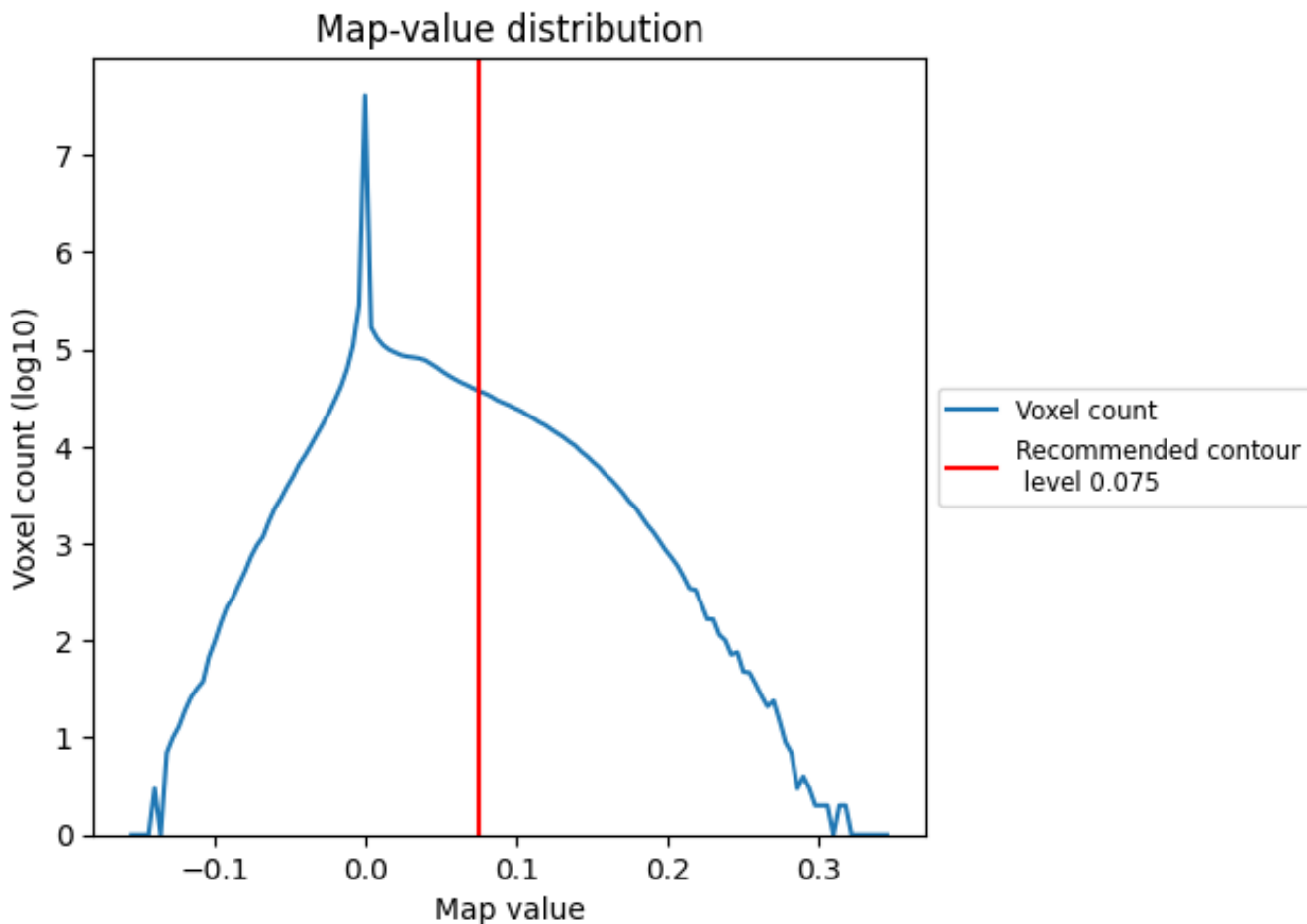

The map-value distribution is plotted in 128 intervals along the x-axis. The y-axis is logarithmic. A spike in this graph at zero usually indicates that the volume has been masked.

7.2 Volume estimate [i](#)

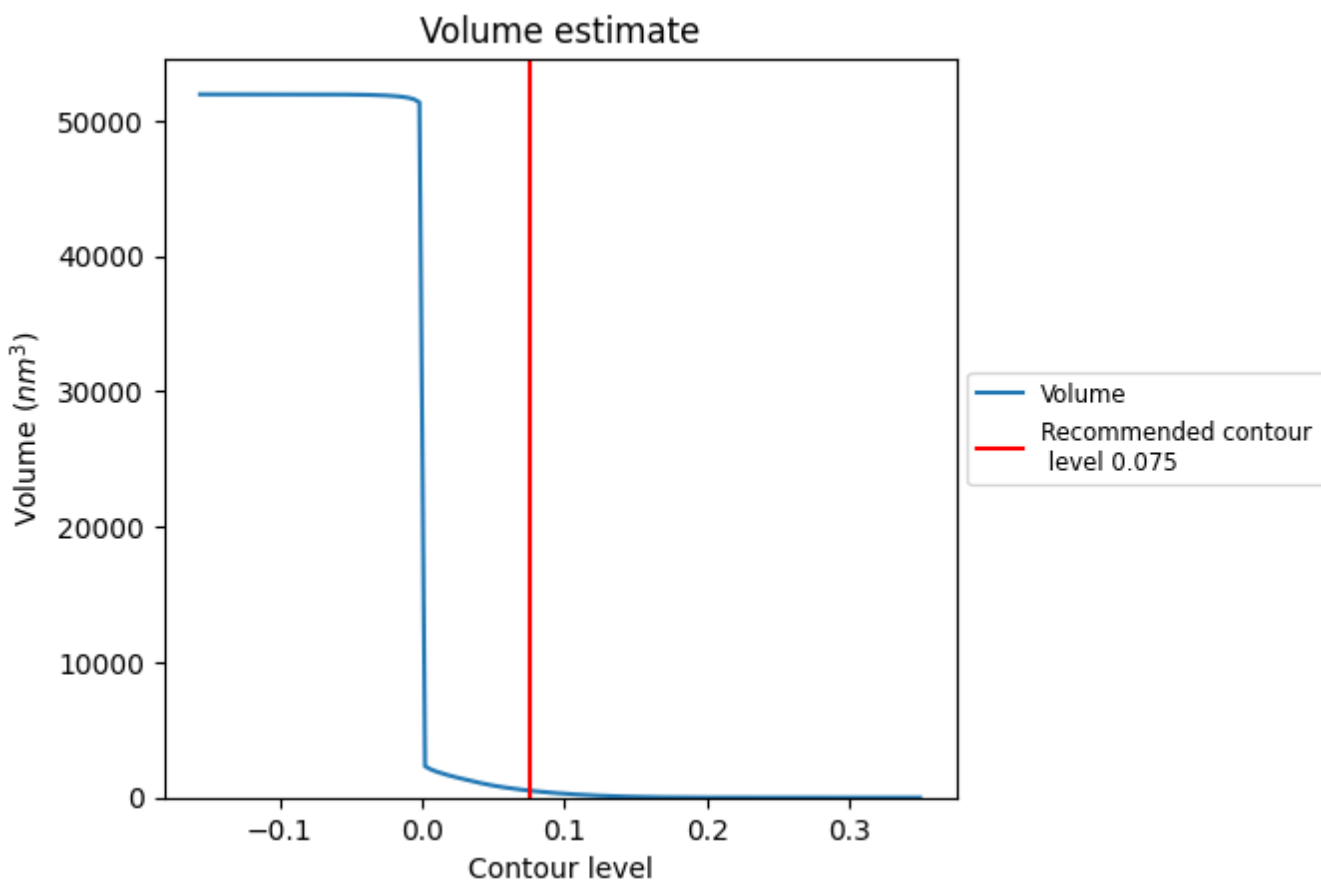

The volume at the recommended contour level is 519 nm³; this corresponds to an approximate mass of 469 kDa.

The volume estimate graph shows how the enclosed volume varies with the contour level. The recommended contour level is shown as a vertical line and the intersection between the line and the curve gives the volume of the enclosed surface at the given level.

7.3 Rotationally averaged power spectrum [i](#)

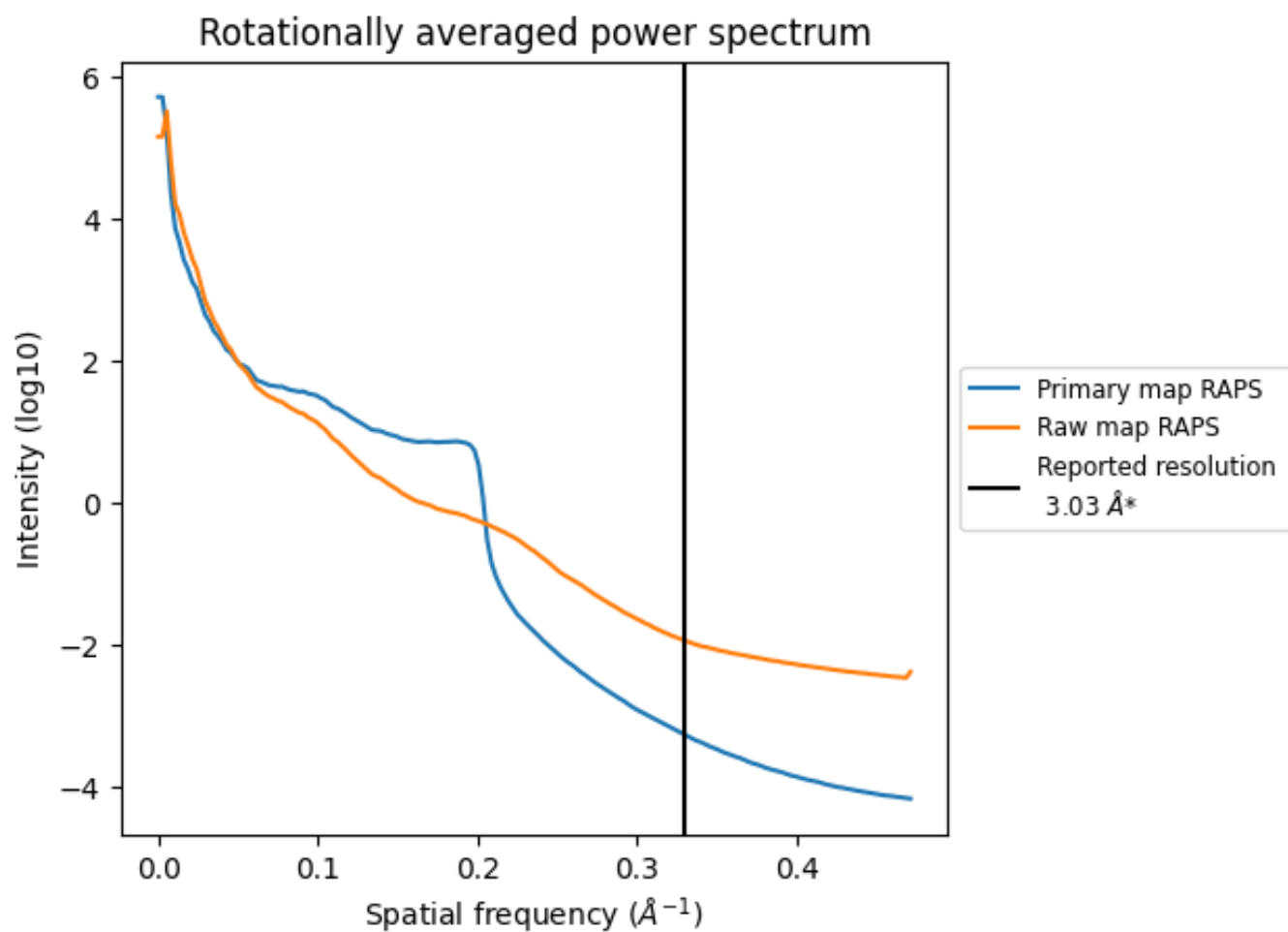

*Reported resolution corresponds to spatial frequency of 0.330 \AA^{-1}

8 Fourier-Shell correlation [\(i\)](#)

Fourier-Shell Correlation (FSC) is the most commonly used method to estimate the resolution of single-particle and subtomogram-averaged maps. The shape of the curve depends on the imposed symmetry, mask and whether or not the two 3D reconstructions used were processed from a common reference. The reported resolution is shown as a black line. A curve is displayed for the half-bit criterion in addition to lines showing the 0.143 gold standard cut-off and 0.5 cut-off.

8.1 FSC [\(i\)](#)

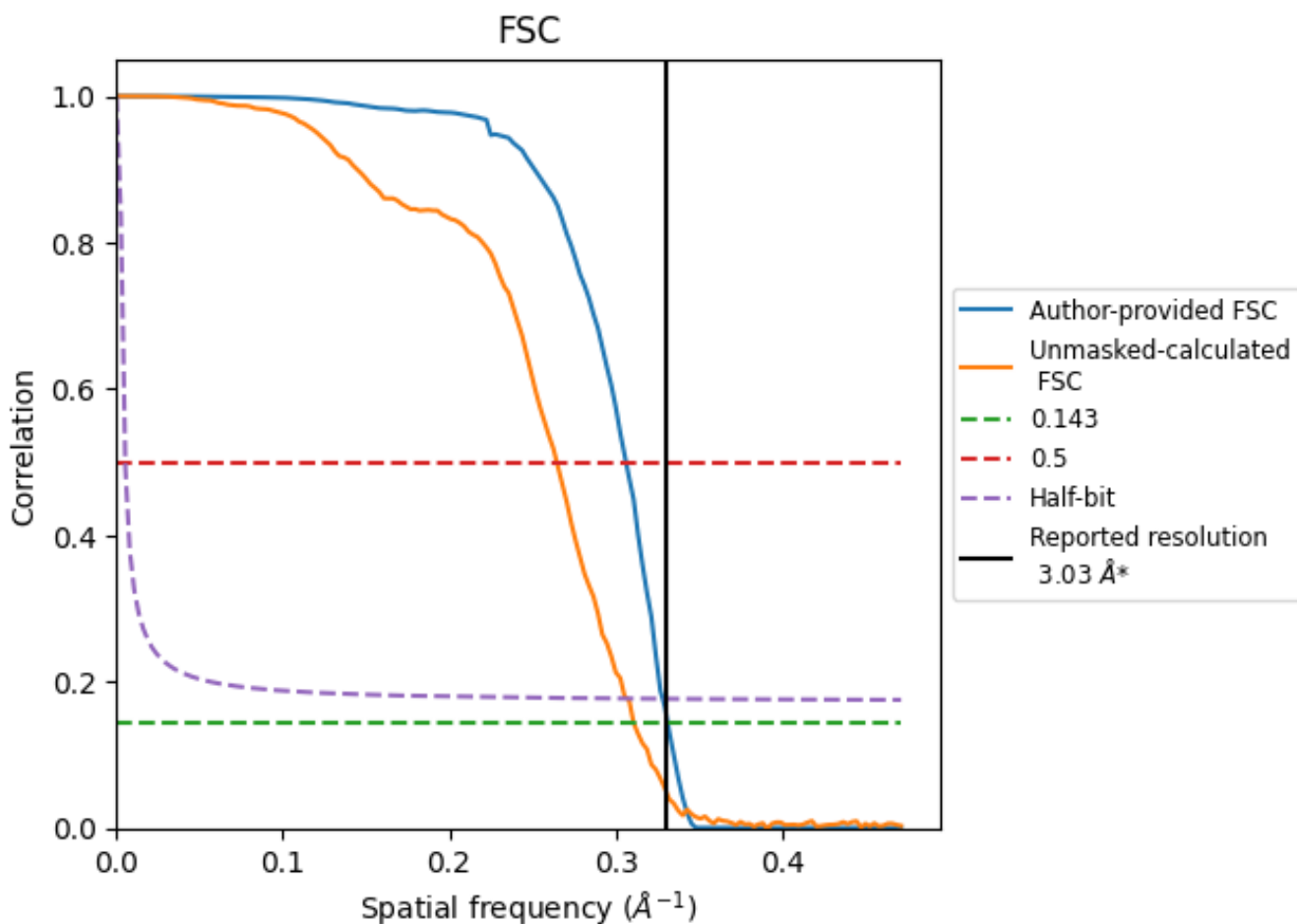

*Reported resolution corresponds to spatial frequency of 0.330 Å⁻¹

8.2 Resolution estimates [i](#)

Resolution estimate (Å)	Estimation criterion (FSC cut-off)		
	0.143	0.5	Half-bit
Reported by author	3.03	-	-
Author-provided FSC curve	3.02	3.26	3.05
Unmasked-calculated*	3.22	3.78	3.26

*Resolution estimate based on FSC curve calculated by comparison of deposited half-maps.

9 Map-model fit [i](#)

This section contains information regarding the fit between EMDB map EMD-3843 and PDB model 5O0M. Per-residue inclusion information can be found in section 3 on page 14.

9.1 Map-model overlay [i](#)

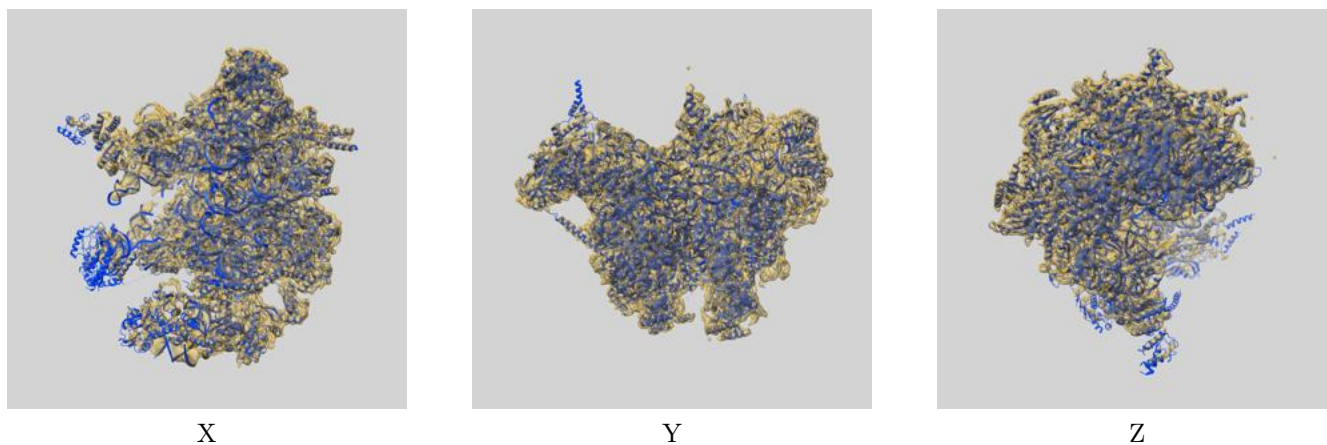

The images above show the 3D surface view of the map at the recommended contour level 0.075 at 50% transparency in yellow overlaid with a ribbon representation of the model coloured in blue. These images allow for the visual assessment of the quality of fit between the atomic model and the map.

9.2 Q-score mapped to coordinate model [i](#)

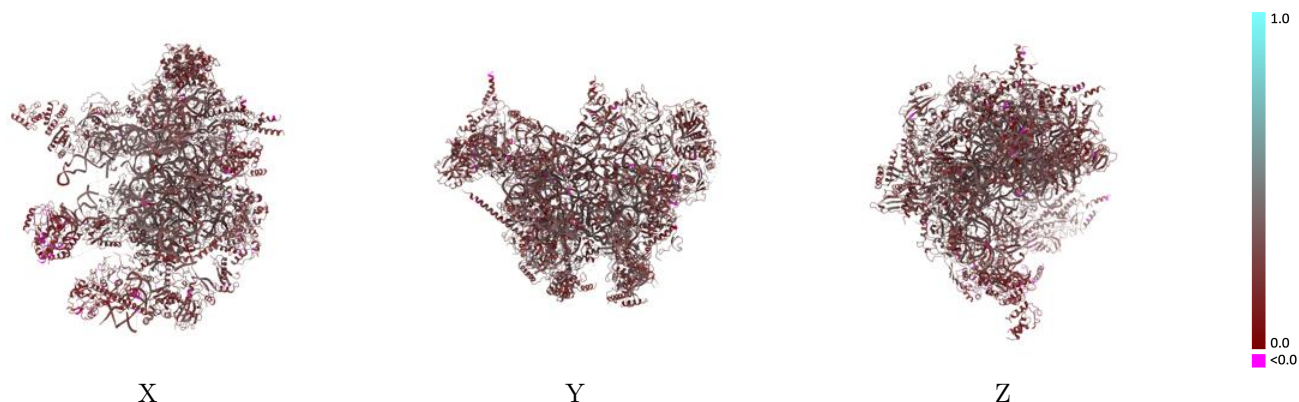

The images above show the model with each residue coloured according to its Q-score. This shows their resolvability in the map with higher Q-score values reflecting better resolvability. Please note: Q-score is calculating the resolvability of atoms, and thus high values are only expected at resolutions at which atoms can be resolved. Low Q-score values may therefore be expected for many entries.

9.3 Atom inclusion mapped to coordinate model [i](#)

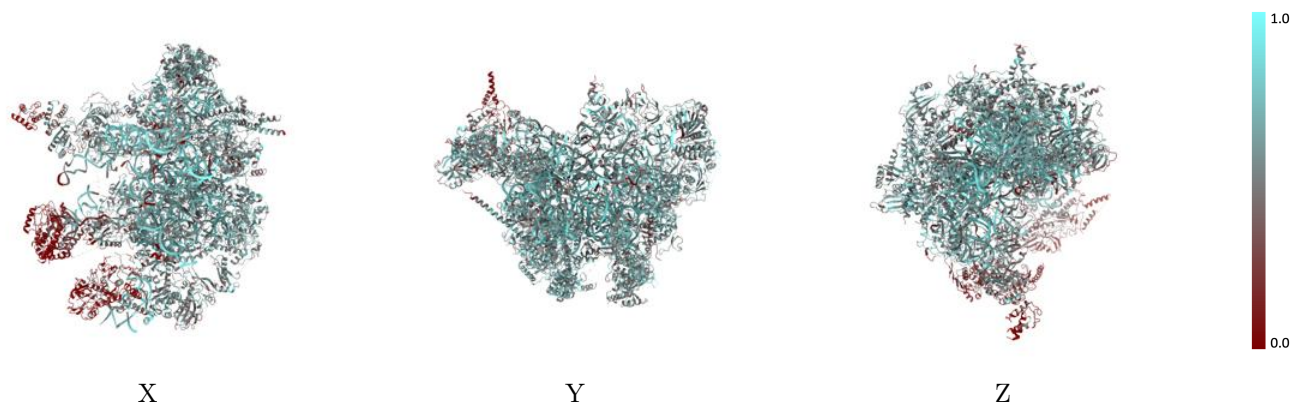

The images above show the model with each residue coloured according to its atom inclusion. This shows to what extent they are inside the map at the recommended contour level (0.075).



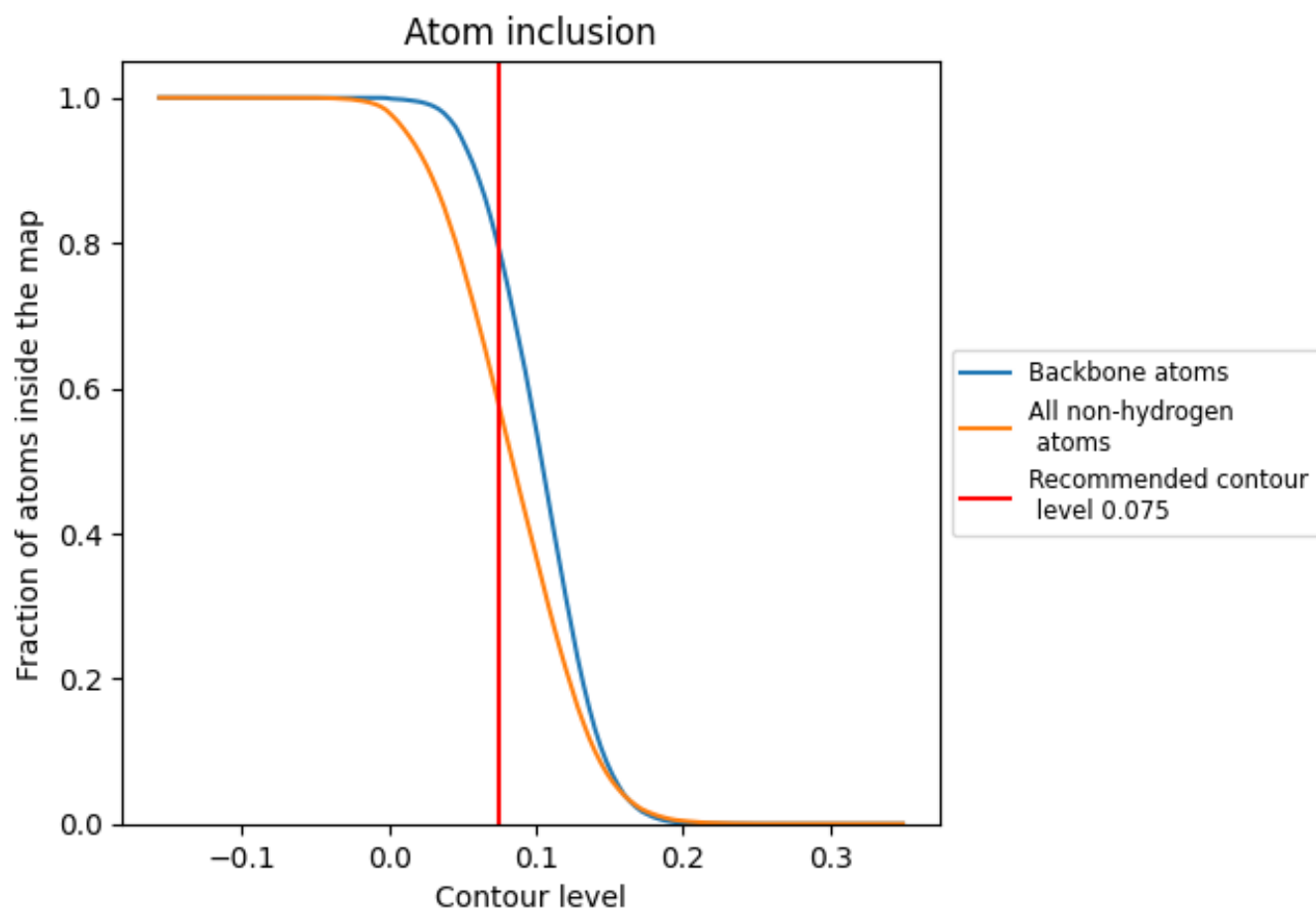



































































9.4 Atom inclusion [i](#)



At the recommended contour level, 79% of all backbone atoms, 58% of all non-hydrogen atoms, are inside the map.

9.5 Map-model fit summary











































The table lists the average atom inclusion at the recommended contour level (0.075) and Q-score for the entire model and for each chain.

Chain	Atom inclusion	Q-score
All	 0.5758	 0.2900
0	 0.5826	 0.2950
1	 0.5190	 0.2800
2	 0.5727	 0.2750
3	 0.5401	 0.2880
5	 0.5636	 0.2750
6	 0.5637	 0.2930
7	 0.5813	 0.2940
8	 0.2815	 0.2180
9	 0.5796	 0.2950
A	 0.7380	 0.3310
B	 0.7364	 0.2960
D	 0.4552	 0.2710
E	 0.5671	 0.3030
F	 0.5890	 0.2970
H	 0.5053	 0.2710
I	 0.1410	 0.1770
J	 0.0000	 0.1210
K	 0.6001	 0.2990
L	 0.4677	 0.2880
M	 0.5742	 0.2790
N	 0.4275	 0.2890
O	 0.6000	 0.2980
P	 0.5564	 0.2740
Q	 0.5535	 0.2920
R	 0.5641	 0.2810
S	 0.6023	 0.3110
T	 0.5800	 0.2970
U	 0.5892	 0.2890
V	 0.5719	 0.3020
W	 0.5131	 0.2790
X	 0.5499	 0.2680
Y	 0.5891	 0.2640
Z	 0.5750	 0.3070
a	 0.5955	 0.3120



Continued on next page...

Continued from previous page...

Chain	Atom inclusion	Q-score
b	 0.6265	 0.3150
c	 0.6150	 0.2960
d	 0.5282	 0.3020
e	 0.1525	 0.1760
f	 0.2930	 0.2410
g	 0.6430	 0.3100
h	 0.5752	 0.2920
i	 0.5597	 0.2750
j	 0.5961	 0.2910
k	 0.1664	 0.2010
l	 0.2427	 0.1580
m	 0.1870	 0.2490
o	 0.6318	 0.2870
p	 0.5196	 0.2680
q	 0.5552	 0.2740
r	 0.5650	 0.3100
s	 0.5971	 0.2770
t	 0.0000	 0.1400
u	 0.5094	 0.2500
v	 0.4010	 0.1980
w	 0.0821	 0.1790