



Full wwPDB X-ray Structure Validation Report ⓘ

Jun 16, 2024 – 05:45 PM EDT

PDB ID : 3OQB
Title : CRYSTAL STRUCTURE OF putative oxidoreductase from Bradyrhizobium japonicum USDA 110
Authors : Malashkevich, V.N.; Toro, R.; Sauder, J.M.; Burley, S.K.; Almo, S.C.; New York SGX Research Center for Structural Genomics (NYSGXRC)
Deposited on : 2010-09-02
Resolution : 2.60 Å(reported)

This is a Full wwPDB X-ray Structure Validation Report for a publicly released PDB entry.

We welcome your comments at validation@mail.wwpdb.org

A user guide is available at

<https://www.wwpdb.org/validation/2017/XrayValidationReportHelp>

with specific help available everywhere you see the ⓘ symbol.

The types of validation reports are described at

<http://www.wwpdb.org/validation/2017/FAQs#types>.

The following versions of software and data (see [references ⓘ](#)) were used in the production of this report:

MolProbity : 4.02b-467
Mogul : 2022.3.0, CSD as543be (2022)
Xtrriage (Phenix) : 1.20.1
EDS : 2.37.1
Percentile statistics : 20191225.v01 (using entries in the PDB archive December 25th 2019)
Refmac : 5.8.0158
CCP4 : 7.0.044 (Gargrove)
Ideal geometry (proteins) : Engh & Huber (2001)
Ideal geometry (DNA, RNA) : Parkinson et al. (1996)
Validation Pipeline (wwPDB-VP) : 2.37.1

1 Overall quality at a glance

The following experimental techniques were used to determine the structure:

X-RAY DIFFRACTION

The reported resolution of this entry is 2.60 Å.

Percentile scores (ranging between 0-100) for global validation metrics of the entry are shown in the following graphic. The table shows the number of entries on which the scores are based.

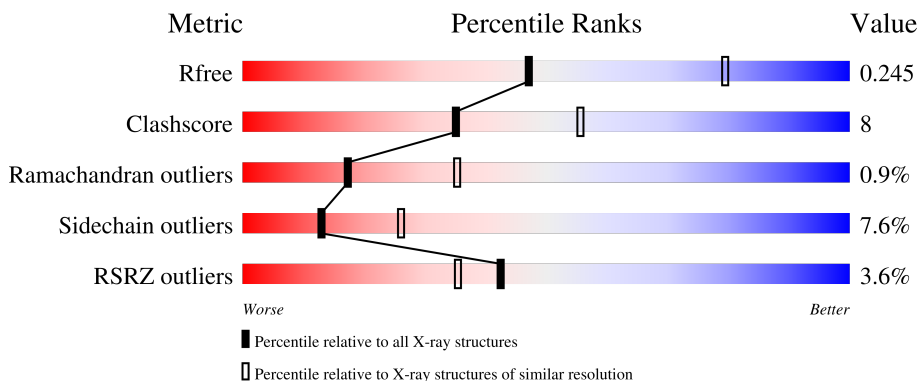



Metric	Whole archive (#Entries)	Similar resolution (#Entries, resolution range(Å))
R_{free}	130704	3163 (2.60-2.60)
Clashscore	141614	3518 (2.60-2.60)
Ramachandran outliers	138981	3455 (2.60-2.60)
Sidechain outliers	138945	3455 (2.60-2.60)
RSRZ outliers	127900	3104 (2.60-2.60)

The table below summarises the geometric issues observed across the polymeric chains and their fit to the electron density. The red, orange, yellow and green segments of the lower bar indicate the fraction of residues that contain outliers for ≥ 3 , 2, 1 and 0 types of geometric quality criteria respectively. A grey segment represents the fraction of residues that are not modelled. The numeric value for each fraction is indicated below the corresponding segment, with a dot representing fractions $\leq 5\%$. The upper red bar (where present) indicates the fraction of residues that have poor fit to the electron density. The numeric value is given above the bar.

Mol	Chain	Length	Quality of chain
1	A	383	 79% 17% ..
1	B	383	 78% 18% ..
1	C	383	 76% 19% ..
1	D	383	 80% 16% ..
1	E	383	 80% 16% ..

Continued on next page...

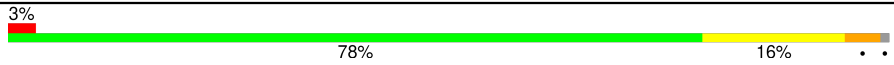
Continued from previous page...

Mol	Chain	Length	Quality of chain
1	F	383	 <p>3% 78% 16% ..</p>
1	G	383	 <p>7% 75% 22% ..</p>
1	H	383	 <p>7% 73% 21% ..</p>

2 Entry composition [i](#)

There are 2 unique types of molecules in this entry. The entry contains 24247 atoms, of which 0 are hydrogens and 0 are deuteriums.

In the tables below, the ZeroOcc column contains the number of atoms modelled with zero occupancy, the AltConf column contains the number of residues with at least one atom in alternate conformation and the Trace column contains the number of residues modelled with at most 2 atoms.

- Molecule 1 is a protein called Oxidoreductase.

Mol	Chain	Residues	Atoms						ZeroOcc	AltConf	Trace
			Total	C	N	O	S	Se			
1	A	376	2989	1901	529	546	5	8	0	0	0
1	B	377	2998	1907	531	547	5	8	0	0	0
1	C	377	3000	1907	533	547	5	8	0	0	0
1	D	378	3005	1910	534	548	5	8	0	0	0
1	E	377	2994	1904	530	547	5	8	0	0	0
1	F	379	3014	1916	536	549	5	8	0	0	0
1	G	378	3005	1910	534	548	5	8	0	0	0
1	H	375	2977	1892	527	545	5	8	0	0	0

There are 16 discrepancies between the modelled and reference sequences:

Chain	Residue	Modelled	Actual	Comment	Reference
A	1	SER	-	expression tag	UNP Q89RD2
A	2	LEU	-	expression tag	UNP Q89RD2
B	1	SER	-	expression tag	UNP Q89RD2
B	2	LEU	-	expression tag	UNP Q89RD2
C	1	SER	-	expression tag	UNP Q89RD2
C	2	LEU	-	expression tag	UNP Q89RD2
D	1	SER	-	expression tag	UNP Q89RD2
D	2	LEU	-	expression tag	UNP Q89RD2
E	1	SER	-	expression tag	UNP Q89RD2
E	2	LEU	-	expression tag	UNP Q89RD2
F	1	SER	-	expression tag	UNP Q89RD2
F	2	LEU	-	expression tag	UNP Q89RD2
G	1	SER	-	expression tag	UNP Q89RD2

Continued on next page...

Continued from previous page...

Chain	Residue	Modelled	Actual	Comment	Reference
G	2	LEU	-	expression tag	UNP Q89RD2
H	1	SER	-	expression tag	UNP Q89RD2
H	2	LEU	-	expression tag	UNP Q89RD2

- Molecule 2 is water.

Mol	Chain	Residues	Atoms	ZeroOcc	AltConf
2	A	27	Total O 27 27	0	0
2	B	45	Total O 45 45	0	0
2	C	37	Total O 37 37	0	0
2	D	36	Total O 36 36	0	0
2	E	45	Total O 45 45	0	0
2	F	24	Total O 24 24	0	0
2	G	20	Total O 20 20	0	0
2	H	31	Total O 31 31	0	0

3 Residue-property plots [i](#)

These plots are drawn for all protein, RNA, DNA and oligosaccharide chains in the entry. The first graphic for a chain summarises the proportions of the various outlier classes displayed in the second graphic. The second graphic shows the sequence view annotated by issues in geometry and electron density. Residues are color-coded according to the number of geometric quality criteria for which they contain at least one outlier: green = 0, yellow = 1, orange = 2 and red = 3 or more. A red dot above a residue indicates a poor fit to the electron density ($RSRZ > 2$). Stretches of 2 or more consecutive residues without any outlier are shown as a green connector. Residues present in the sample, but not in the model, are shown in grey.

• Molecule 1: Oxidoreductase

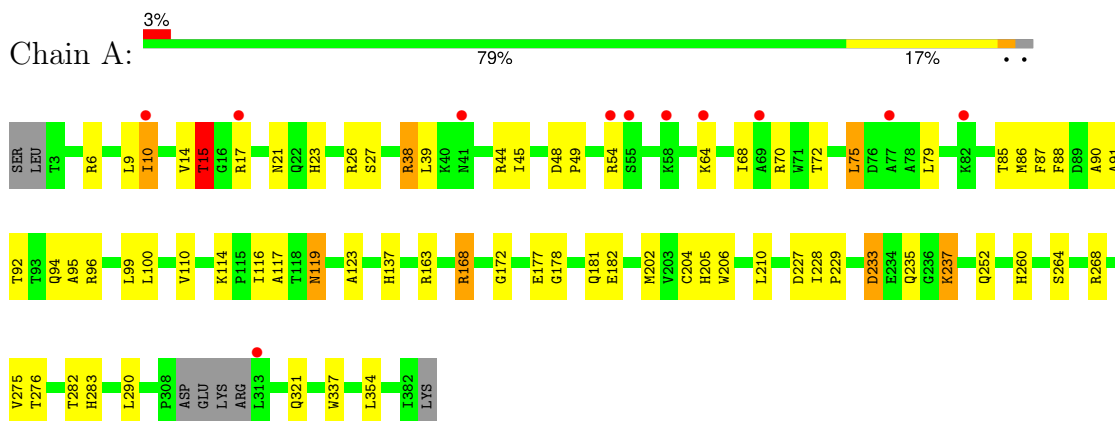

• Molecule 1: Oxidoreductase

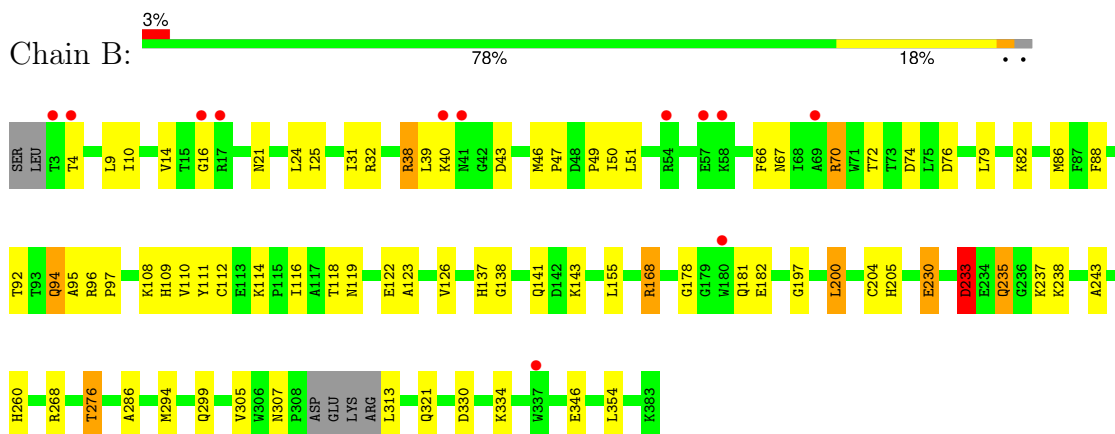

• Molecule 1: Oxidoreductase

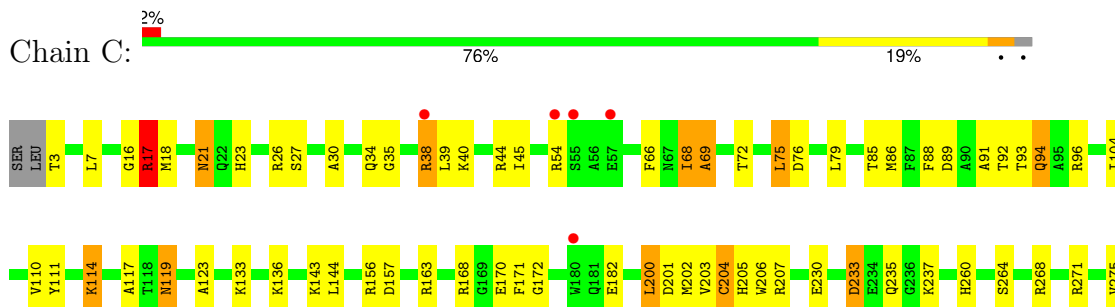

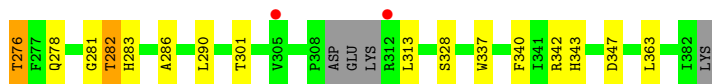

- Molecule 1: Oxidoreductase

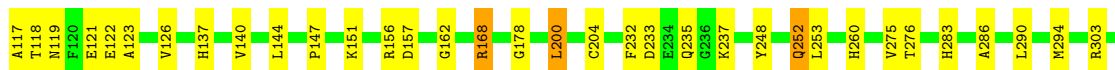
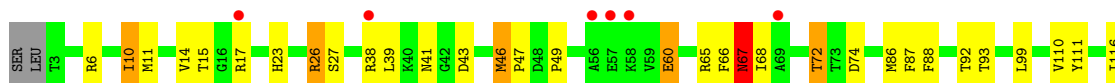
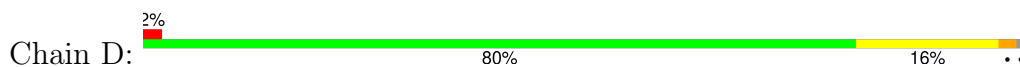

- Molecule 1: Oxidoreductase

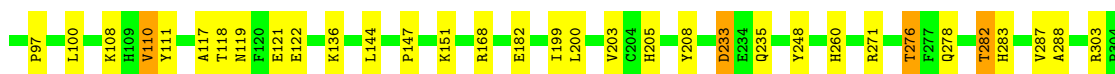
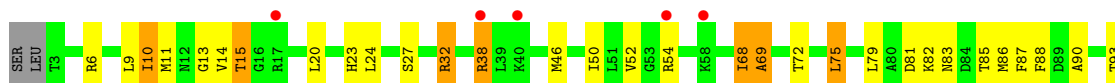
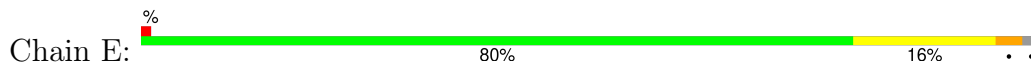

- Molecule 1: Oxidoreductase

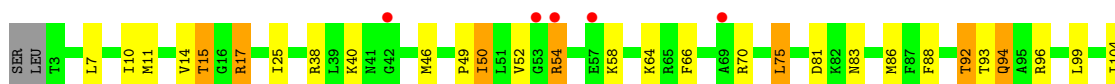
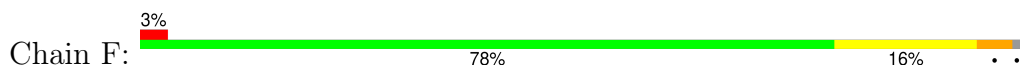

- Molecule 1: Oxidoreductase

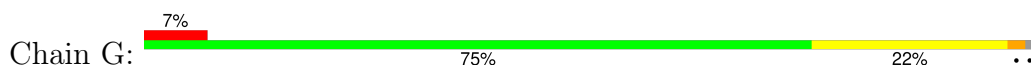

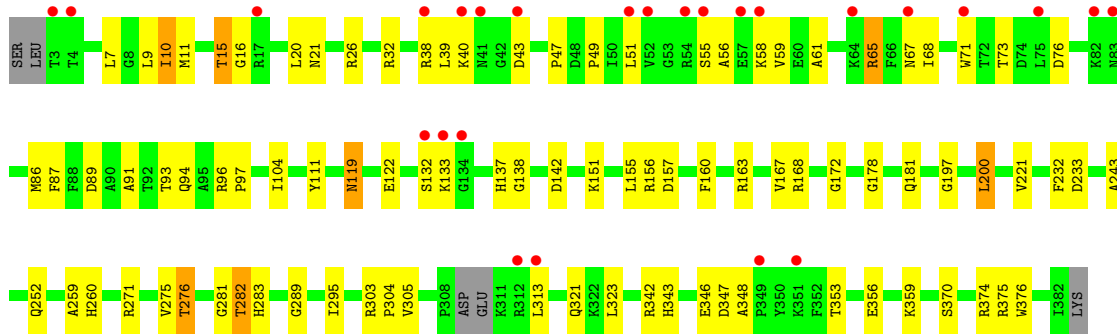

• Molecule 1: Oxidoreductase

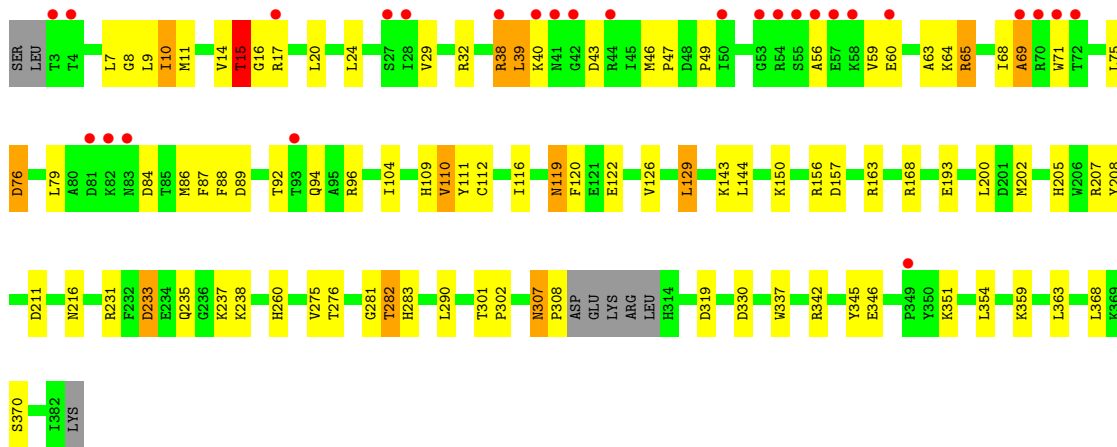
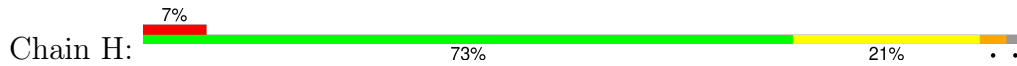

4 Data and refinement statistics

Property	Value	Source
Space group	P 1 21 1	Depositor
Cell constants a, b, c, α , β , γ	93.70Å 163.85Å 117.73Å 90.00° 103.85° 90.00°	Depositor
Resolution (Å)	19.99 – 2.60 19.99 – 2.60	Depositor EDS
% Data completeness (in resolution range)	99.9 (19.99-2.60) 99.9 (19.99-2.60)	Depositor EDS
R_{merge}	0.11	Depositor
R_{sym}	(Not available)	Depositor
$\langle I/\sigma(I) \rangle$ ¹	2.10 (at 2.59Å)	Xtrriage
Refinement program	REFMAC	Depositor
R, R_{free}	0.193 , 0.247 0.191 , 0.245	Depositor DCC
R_{free} test set	5257 reflections (4.99%)	wwPDB-VP
Wilson B-factor (Å ²)	46.9	Xtrriage
Anisotropy	0.048	Xtrriage
Bulk solvent k_{sol} (e/Å ³), B_{sol} (Å ²)	0.30 , 40.0	EDS
L-test for twinning ²	$\langle L \rangle = 0.47$, $\langle L^2 \rangle = 0.30$	Xtrriage
Estimated twinning fraction	No twinning to report.	Xtrriage
F_o, F_c correlation	0.94	EDS
Total number of atoms	24247	wwPDB-VP
Average B, all atoms (Å ²)	55.0	wwPDB-VP

Xtrriage's analysis on translational NCS is as follows: *The largest off-origin peak in the Patterson function is 2.87% of the height of the origin peak. No significant pseudotranslation is detected.*

¹Intensities estimated from amplitudes.

²Theoretical values of $\langle |L| \rangle$, $\langle L^2 \rangle$ for acentric reflections are 0.5, 0.333 respectively for untwinned datasets, and 0.375, 0.2 for perfectly twinned datasets.

5 Model quality [i](#)

5.1 Standard geometry [i](#)

The Z score for a bond length (or angle) is the number of standard deviations the observed value is removed from the expected value. A bond length (or angle) with $|Z| > 5$ is considered an outlier worth inspection. RMSZ is the root-mean-square of all Z scores of the bond lengths (or angles).

Mol	Chain	Bond lengths		Bond angles	
		RMSZ	# Z >5	RMSZ	# Z >5
1	A	0.48	0/3051	0.59	0/4117
1	B	0.51	0/3060	0.60	0/4128
1	C	0.55	1/3062 (0.0%)	0.67	1/4131 (0.0%)
1	D	0.56	0/3067	0.64	1/4138 (0.0%)
1	E	0.57	0/3056	0.65	0/4124
1	F	0.50	0/3076	0.63	1/4149 (0.0%)
1	G	0.47	0/3067	0.61	1/4138 (0.0%)
1	H	0.52	0/3039	0.64	0/4102
All	All	0.52	1/24478 (0.0%)	0.63	4/33027 (0.0%)

All (1) bond length outliers are listed below:

Mol	Chain	Res	Type	Atoms	Z	Observed(Å)	Ideal(Å)
1	C	204	CYS	CB-SG	-9.53	1.66	1.82

All (4) bond angle outliers are listed below:

Mol	Chain	Res	Type	Atoms	Z	Observed(°)	Ideal(°)
1	C	200	LEU	CA-CB-CG	5.93	128.93	115.30
1	D	200	LEU	CA-CB-CG	5.51	127.98	115.30
1	G	200	LEU	CA-CB-CG	5.48	127.91	115.30
1	F	313	LEU	CA-CB-CG	5.32	127.54	115.30

There are no chirality outliers.

There are no planarity outliers.

5.2 Too-close contacts [i](#)

In the following table, the Non-H and H(model) columns list the number of non-hydrogen atoms and hydrogen atoms in the chain respectively. The H(added) column lists the number of hydrogen atoms added and optimized by MolProbity. The Clashes column lists the number of clashes within the asymmetric unit, whereas Symm-Clashes lists symmetry-related clashes.

Mol	Chain	Non-H	H(model)	H(added)	Clashes	Symm-Clashes
1	A	2989	0	2929	46	0
1	B	2998	0	2942	47	0
1	C	3000	0	2942	52	0
1	D	3005	0	2944	55	0
1	E	2994	0	2931	46	0
1	F	3014	0	2957	52	0
1	G	3005	0	2944	48	0
1	H	2977	0	2907	63	0
2	A	27	0	0	3	0
2	B	45	0	0	4	0
2	C	37	0	0	4	0
2	D	36	0	0	5	0
2	E	45	0	0	1	0
2	F	24	0	0	2	0
2	G	20	0	0	3	0
2	H	31	0	0	2	0
All	All	24247	0	23496	391	0

The all-atom clashscore is defined as the number of clashes found per 1000 atoms (including hydrogen atoms). The all-atom clashscore for this structure is 8.

All (391) close contacts within the same asymmetric unit are listed below, sorted by their clash magnitude.

Atom-1	Atom-2	Interatomic distance (Å)	Clash overlap (Å)
1:H:65:ARG:HG3	1:H:65:ARG:HH11	1.12	1.13
1:D:119:ASN:ND2	1:D:121:GLU:HG2	1.63	1.12
1:G:282:THR:HG22	1:G:283:HIS:HD2	1.22	1.02
1:D:156:ARG:HG2	1:D:156:ARG:HH11	1.21	1.01
1:A:237:LYS:HE2	2:A:405:HOH:O	1.62	1.00
1:G:282:THR:HG22	1:G:283:HIS:CD2	1.96	1.00
1:E:9:LEU:HD13	1:E:86:MSE:HE3	1.41	0.98
1:G:156:ARG:HG2	1:G:156:ARG:HH11	1.30	0.96
1:A:282:THR:HG22	1:A:283:HIS:CD2	2.00	0.95
1:A:282:THR:HG22	1:A:283:HIS:HD2	1.36	0.88
1:C:282:THR:HG22	1:C:283:HIS:CD2	2.08	0.87
1:D:26:ARG:HG3	1:D:26:ARG:HH11	1.41	0.86
1:H:9:LEU:HD13	1:H:86:MSE:HE2	1.60	0.83
1:C:75:LEU:HD12	1:C:79:LEU:HD11	1.59	0.83
1:A:14:VAL:O	1:A:15:THR:HB	1.80	0.81
1:D:119:ASN:HD21	1:D:121:GLU:HG2	1.44	0.81
1:B:38:ARG:H	1:B:38:ARG:HD2	1.46	0.81
1:C:89:ASP:OD2	1:C:96:ARG:HG3	1.82	0.80

Continued on next page...

Continued from previous page...

Atom-1	Atom-2	Interatomic distance (Å)	Clash overlap (Å)
1:D:119:ASN:HD22	1:D:121:GLU:HG2	1.45	0.79
1:B:305:VAL:HA	2:B:391:HOH:O	1.81	0.79
1:E:276:THR:HG22	2:E:392:HOH:O	1.81	0.79
1:F:11:MSE:HE2	1:F:49:PRO:HB2	1.65	0.79
1:D:60:GLU:HG3	2:D:396:HOH:O	1.82	0.78
1:H:156:ARG:NH1	1:H:157:ASP:OD1	2.17	0.77
1:H:119:ASN:HB3	2:H:389:HOH:O	1.86	0.76
1:C:75:LEU:O	1:C:79:LEU:HD12	1.85	0.75
1:B:276:THR:HG22	2:B:410:HOH:O	1.86	0.75
1:G:9:LEU:HD13	1:G:86:MSE:HE3	1.68	0.75
1:A:92:THR:HG22	1:A:94:GLN:H	1.52	0.74
1:G:276:THR:HG22	2:G:391:HOH:O	1.87	0.74
1:G:15:THR:HA	1:G:20:LEU:HB2	1.70	0.74
1:H:122:GLU:HB2	2:H:389:HOH:O	1.88	0.73
1:G:172:GLY:O	1:G:271:ARG:NH2	2.22	0.73
1:H:122:GLU:O	1:H:126:VAL:HG23	1.90	0.72
1:A:38:ARG:HB3	1:A:44:ARG:HH11	1.54	0.72
1:C:156:ARG:NH1	1:C:157:ASP:OD1	2.22	0.72
1:A:119:ASN:HB3	2:A:390:HOH:O	1.90	0.71
1:H:65:ARG:HH11	1:H:65:ARG:CG	1.97	0.71
1:B:268:ARG:NH2	1:H:281:GLY:O	2.23	0.70
1:C:38:ARG:HD2	1:C:38:ARG:O	1.91	0.69
1:H:89:ASP:OD2	1:H:96:ARG:HG3	1.92	0.69
1:F:92:THR:HG22	1:F:94:GLN:HE21	1.56	0.68
1:D:86:MSE:HE1	1:D:337:TRP:CZ3	2.29	0.68
1:G:156:ARG:HG2	1:G:156:ARG:NH1	2.06	0.68
1:F:137:HIS:HD2	1:F:354:LEU:H	1.41	0.68
1:C:92:THR:HB	1:C:94:GLN:HE21	1.57	0.67
1:C:171:PHE:HB2	1:C:275:VAL:HG23	1.76	0.67
1:H:65:ARG:HG3	1:H:65:ARG:NH1	1.89	0.67
1:F:282:THR:HG22	1:F:283:HIS:CD2	2.29	0.67
1:F:11:MSE:HE2	1:F:49:PRO:CB	2.25	0.67
1:D:370:SER:HB2	1:D:375:ARG:O	1.95	0.66
1:E:32:ARG:HG3	1:E:46:MSE:HE1	1.77	0.66
1:D:156:ARG:HH11	1:D:156:ARG:CG	2.04	0.66
1:H:56:ALA:HA	1:H:59:VAL:HG12	1.77	0.66
1:B:119:ASN:HB3	1:B:122:GLU:HB2	1.78	0.66
1:G:39:LEU:HD22	1:G:346:GLU:HB2	1.77	0.66
1:C:68:ILE:O	1:C:69:ALA:HB3	1.96	0.65
1:H:68:ILE:HG22	1:H:69:ALA:N	2.10	0.65
1:E:14:VAL:O	1:E:15:THR:HB	1.96	0.65

Continued on next page...

Continued from previous page...

Atom-1	Atom-2	Interatomic distance (Å)	Clash overlap (Å)
1:C:233:ASP:HB3	1:C:235:GLN:H	1.62	0.65
1:E:52:VAL:HG11	1:E:75:LEU:HD22	1.78	0.64
1:C:156:ARG:HH11	1:C:156:ARG:HG2	1.61	0.64
1:E:282:THR:HG22	1:E:283:HIS:ND1	2.11	0.64
1:F:17:ARG:H	1:F:17:ARG:HD3	1.63	0.64
1:H:205:HIS:HA	1:H:208:TYR:CE2	2.32	0.64
1:C:281:GLY:O	1:F:268:ARG:NH2	2.31	0.64
1:D:156:ARG:HG2	1:D:156:ARG:NH1	2.00	0.64
1:H:15:THR:HG23	1:H:15:THR:O	1.97	0.64
1:G:276:THR:CG2	2:G:391:HOH:O	2.45	0.63
1:B:32:ARG:HG3	1:B:46:MSE:HE1	1.79	0.63
1:F:156:ARG:NH1	1:F:157:ASP:OD1	2.31	0.63
1:H:233:ASP:HB3	1:H:235:GLN:H	1.62	0.63
1:H:86:MSE:HE1	1:H:337:TRP:HZ3	1.65	0.62
1:A:48:ASP:O	1:A:70:ARG:NH2	2.32	0.62
1:F:305:VAL:HA	2:F:399:HOH:O	2.00	0.62
1:G:65:ARG:CB	1:G:65:ARG:HH11	2.13	0.62
1:G:21:ASN:O	1:G:26:ARG:HG2	2.00	0.61
1:D:86:MSE:HE1	1:D:337:TRP:HZ3	1.64	0.61
1:E:14:VAL:HG21	1:E:24:LEU:HD22	1.81	0.61
1:H:233:ASP:HB2	1:H:237:LYS:H	1.65	0.61
1:D:233:ASP:HB3	1:D:235:GLN:H	1.65	0.61
1:D:11:MSE:HE2	1:D:14:VAL:HG11	1.82	0.61
1:F:92:THR:HG22	1:F:94:GLN:HG2	1.82	0.61
1:D:39:LEU:HD12	1:D:43:ASP:HB2	1.81	0.61
1:B:233:ASP:HB2	1:B:237:LYS:H	1.66	0.61
1:C:88:PHE:HA	1:C:111:TYR:O	2.00	0.60
1:B:233:ASP:HB3	1:B:235:GLN:H	1.67	0.60
1:A:275:VAL:HG12	1:A:290:LEU:HD12	1.84	0.59
1:B:14:VAL:HG22	1:B:14:VAL:O	2.02	0.59
1:E:233:ASP:HB3	1:E:235:GLN:H	1.66	0.59
1:F:233:ASP:HB2	1:F:237:LYS:H	1.67	0.59
1:D:23:HIS:O	1:D:27:SER:HB2	2.03	0.58
1:E:205:HIS:HA	1:E:208:TYR:CE2	2.38	0.58
1:D:260:HIS:CE1	1:E:260:HIS:CE1	2.92	0.58
1:G:156:ARG:NH1	1:G:157:ASP:OD1	2.34	0.58
1:D:303:ARG:NH2	1:E:182:GLU:O	2.33	0.58
1:D:156:ARG:NH1	1:D:157:ASP:OD1	2.37	0.58
1:G:96:ARG:N	1:G:97:PRO:HD2	2.19	0.58
1:E:88:PHE:HA	1:E:111:TYR:O	2.04	0.58
1:C:260:HIS:CE1	1:F:260:HIS:CE1	2.92	0.57

Continued on next page...

Continued from previous page...

Atom-1	Atom-2	Interatomic distance (Å)	Clash overlap (Å)
1:E:147:PRO:O	1:E:151:LYS:HG3	2.03	0.57
1:F:137:HIS:CD2	1:F:354:LEU:H	2.21	0.57
1:C:182:GLU:O	1:F:303:ARG:NH2	2.37	0.57
1:H:20:LEU:O	1:H:24:LEU:HB3	2.05	0.57
1:H:163:ARG:H	1:H:282:THR:HG22	1.68	0.57
1:H:63:ALA:HB2	1:H:71:TRP:HD1	1.68	0.57
1:A:23:HIS:O	1:A:27:SER:HB2	2.06	0.56
1:D:88:PHE:HA	1:D:111:TYR:O	2.04	0.56
1:E:136:LYS:HD2	1:E:343:HIS:NE2	2.20	0.56
1:H:282:THR:HG23	1:H:283:HIS:CD2	2.40	0.56
1:A:92:THR:HG22	1:A:95:ALA:H	1.70	0.56
1:A:116:ILE:HD11	1:A:123:ALA:HB1	1.87	0.56
1:B:47:PRO:O	1:B:49:PRO:HD3	2.06	0.56
1:E:10:ILE:HG13	1:E:87:PHE:HD1	1.69	0.56
1:F:54:ARG:CD	1:F:54:ARG:H	2.19	0.55
1:F:88:PHE:HA	1:F:111:TYR:O	2.06	0.55
1:E:14:VAL:O	1:E:15:THR:CB	2.54	0.55
1:H:307:ASN:C	1:H:307:ASN:HD22	2.10	0.55
1:E:9:LEU:HD13	1:E:86:MSE:CE	2.27	0.55
1:G:156:ARG:HH11	1:G:156:ARG:CG	2.11	0.55
1:E:68:ILE:O	1:E:69:ALA:CB	2.54	0.55
1:B:31:ILE:HG13	1:B:334:LYS:HE2	1.89	0.54
1:C:301:THR:OG1	1:F:268:ARG:HD3	2.07	0.54
1:C:68:ILE:O	1:C:69:ALA:CB	2.55	0.54
1:G:178:GLY:HA3	1:G:232:PHE:HB2	1.89	0.54
1:B:86:MSE:HG3	1:B:109:HIS:HB2	1.89	0.54
1:A:137:HIS:HD2	1:A:354:LEU:H	1.55	0.54
1:C:38:ARG:NH2	1:C:342:ARG:HD3	2.22	0.54
1:H:8:GLY:HA3	1:H:84:ASP:HA	1.89	0.54
1:E:13:GLY:HA3	1:E:90:ALA:C	2.27	0.54
1:A:227:ASP:O	1:G:163:ARG:NH1	2.41	0.54
1:A:268:ARG:NH2	1:G:281:GLY:O	2.41	0.53
1:B:260:HIS:CE1	1:H:260:HIS:CE1	2.97	0.53
1:C:23:HIS:O	1:C:27:SER:HB2	2.08	0.53
1:H:32:ARG:HH21	1:H:49:PRO:HD3	1.72	0.53
1:B:14:VAL:HG21	1:B:24:LEU:HD13	1.91	0.53
1:F:54:ARG:H	1:F:54:ARG:HD2	1.72	0.53
1:B:299:GLN:HG2	1:F:155:LEU:HD23	1.91	0.53
1:A:168:ARG:NH2	2:A:409:HOH:O	2.41	0.53
1:D:26:ARG:HG3	1:D:26:ARG:NH1	2.17	0.53
1:D:168:ARG:NH1	2:D:407:HOH:O	2.40	0.53

Continued on next page...

Continued from previous page...

Atom-1	Atom-2	Interatomic distance (Å)	Clash overlap (Å)
1:A:182:GLU:O	1:G:303:ARG:NH2	2.42	0.53
1:D:66:PHE:HB2	1:D:68:ILE:HD12	1.90	0.52
1:E:68:ILE:O	1:E:69:ALA:HB3	2.08	0.52
1:H:56:ALA:HB1	1:H:71:TRP:HZ3	1.74	0.52
1:G:9:LEU:O	1:G:49:PRO:HA	2.10	0.52
1:D:86:MSE:CE	1:D:337:TRP:HZ3	2.22	0.52
1:E:81:ASP:O	1:E:82:LYS:HB2	2.09	0.52
1:F:275:VAL:HG22	1:F:276:THR:N	2.24	0.52
1:C:282:THR:CG2	1:C:283:HIS:CD2	2.88	0.52
1:B:230:GLU:HG2	1:B:238:LYS:HG2	1.90	0.52
1:C:233:ASP:HB2	1:C:237:LYS:H	1.73	0.52
1:G:304:PRO:HD2	2:G:384:HOH:O	2.09	0.52
1:D:118:THR:HG22	1:D:118:THR:O	2.09	0.52
1:H:15:THR:O	1:H:15:THR:CG2	2.57	0.52
1:D:11:MSE:HE2	1:D:14:VAL:CG1	2.39	0.51
1:E:14:VAL:HG23	1:E:20:LEU:HA	1.92	0.51
1:A:233:ASP:HB3	1:A:235:GLN:H	1.75	0.51
1:C:21:ASN:O	1:C:26:ARG:HG2	2.11	0.51
1:F:207:ARG:NH2	1:F:359:LYS:HE2	2.25	0.51
1:C:276:THR:CG2	2:C:413:HOH:O	2.58	0.51
1:G:61:ALA:O	1:G:65:ARG:HB2	2.10	0.51
1:D:86:MSE:CE	1:D:337:TRP:CZ3	2.94	0.51
1:H:24:LEU:O	1:H:29:VAL:HG23	2.11	0.51
1:G:59:VAL:HG13	1:G:71:TRP:HB2	1.93	0.51
1:B:79:LEU:HA	1:B:108:LYS:HE3	1.93	0.51
1:D:66:PHE:C	1:D:67:ASN:HD22	2.15	0.51
1:B:14:VAL:HG21	1:B:24:LEU:HD22	1.93	0.50
1:H:275:VAL:HG12	1:H:290:LEU:HD12	1.92	0.50
1:E:97:PRO:HG3	1:E:117:ALA:CB	2.41	0.50
1:A:110:VAL:O	1:A:137:HIS:HA	2.11	0.50
1:D:10:ILE:HG13	1:D:87:PHE:HD1	1.76	0.50
1:C:276:THR:HG23	2:C:413:HOH:O	2.11	0.50
1:G:343:HIS:HA	1:G:348:ALA:H	1.77	0.50
1:D:49:PRO:HG2	1:D:68:ILE:HG12	1.94	0.50
1:H:39:LEU:HB2	1:H:43:ASP:O	2.11	0.50
1:A:14:VAL:O	1:A:15:THR:CB	2.57	0.50
1:G:137:HIS:CE1	1:G:353:THR:HB	2.46	0.50
1:D:118:THR:O	1:D:118:THR:CG2	2.59	0.49
1:G:151:LYS:O	1:G:155:LEU:HG	2.13	0.49
1:G:221:VAL:HB	1:G:376:TRP:CD2	2.47	0.49
1:H:56:ALA:HB1	1:H:71:TRP:CZ3	2.47	0.49

Continued on next page...

Continued from previous page...

Atom-1	Atom-2	Interatomic distance (Å)	Clash overlap (Å)
1:A:95:ALA:O	1:A:99:LEU:HD23	2.13	0.49
1:B:286:ALA:HA	1:B:294:MSE:O	2.12	0.49
1:D:23:HIS:HE1	1:D:140:VAL:HG21	1.78	0.49
1:B:9:LEU:HD13	1:B:86:MSE:HE2	1.94	0.49
1:E:303:ARG:O	1:E:303:ARG:HG2	2.13	0.49
1:C:268:ARG:NH2	1:F:281:GLY:O	2.46	0.49
1:D:15:THR:HG22	2:D:402:HOH:O	2.13	0.49
1:H:143:LYS:HE2	1:H:202:MSE:HE1	1.94	0.49
1:C:39:LEU:HD11	1:C:45:ILE:HD11	1.95	0.49
1:G:56:ALA:O	1:G:59:VAL:HG12	2.12	0.49
1:D:162:GLY:HA3	1:D:283:HIS:CD2	2.48	0.48
1:E:119:ASN:HB3	1:E:122:GLU:CB	2.43	0.48
1:E:100:LEU:HD22	1:E:110:VAL:HG11	1.95	0.48
1:G:119:ASN:HB3	1:G:122:GLU:HB3	1.95	0.48
1:B:137:HIS:HB2	1:B:354:LEU:HG	1.95	0.48
1:H:110:VAL:HG11	1:H:354:LEU:HD11	1.95	0.48
1:H:112:CYS:SG	1:H:116:ILE:HG22	2.54	0.48
1:B:122:GLU:O	1:B:126:VAL:HG23	2.13	0.48
1:D:248:TYR:CD2	1:D:248:TYR:N	2.82	0.48
1:A:38:ARG:H	1:A:38:ARG:HH21	1.62	0.48
1:C:3:THR:HG21	2:C:393:HOH:O	2.14	0.48
1:A:100:LEU:HD22	1:A:110:VAL:HG11	1.96	0.48
1:E:10:ILE:CG1	1:E:87:PHE:HD1	2.26	0.48
1:F:233:ASP:HB3	1:F:235:GLN:H	1.79	0.48
1:A:75:LEU:CD1	1:A:99:LEU:HD12	2.43	0.48
1:C:86:MSE:CE	1:C:337:TRP:HZ3	2.27	0.48
1:B:96:ARG:HD3	1:B:112:CYS:HB2	1.95	0.48
1:D:6:ARG:HG3	2:D:409:HOH:O	2.12	0.48
1:C:66:PHE:HB2	1:C:68:ILE:CD1	2.43	0.47
1:H:38:ARG:HD3	1:H:342:ARG:HD3	1.96	0.47
1:A:21:ASN:O	1:A:26:ARG:HG2	2.13	0.47
1:A:75:LEU:HD22	1:A:79:LEU:HG	1.95	0.47
1:G:343:HIS:O	1:G:347:ASP:HA	2.13	0.47
1:F:122:GLU:O	1:F:126:VAL:HG23	2.14	0.47
1:D:252:GLN:HG2	2:D:388:HOH:O	2.15	0.47
1:G:65:ARG:HH11	1:G:65:ARG:CG	2.27	0.47
1:B:233:ASP:OD1	1:B:237:LYS:HB2	2.14	0.47
1:D:122:GLU:O	1:D:126:VAL:HG23	2.15	0.47
1:B:200:LEU:HD23	2:B:417:HOH:O	2.14	0.47
1:E:79:LEU:O	1:E:108:LYS:HE2	2.15	0.47
1:F:355:LEU:O	1:F:359:LYS:HG3	2.15	0.47

Continued on next page...

Continued from previous page...

Atom-1	Atom-2	Interatomic distance (Å)	Clash overlap (Å)
1:B:114:LYS:HE3	1:B:205:HIS:CD2	2.49	0.47
1:A:86:MSE:CE	1:A:337:TRP:HZ3	2.27	0.47
1:B:50:ILE:HD12	1:B:70:ARG:HD2	1.96	0.47
1:C:30:ALA:O	1:C:34:GLN:HB2	2.15	0.47
1:D:26:ARG:HH11	1:D:26:ARG:CG	2.19	0.47
1:H:11:MSE:HE2	1:H:14:VAL:HG21	1.96	0.47
1:H:15:THR:HA	1:H:20:LEU:HB2	1.97	0.47
1:E:278:GLN:HG3	1:E:287:VAL:HG22	1.97	0.46
1:E:75:LEU:HD12	1:E:79:LEU:HG	1.97	0.46
1:F:7:LEU:HD11	1:F:86:MSE:HB2	1.97	0.46
1:B:66:PHE:O	1:B:67:ASN:HB2	2.15	0.46
1:C:114:LYS:NZ	1:C:201:ASP:OD1	2.49	0.46
1:C:170:GLU:HB2	1:C:276:THR:HG22	1.97	0.46
1:E:97:PRO:HG3	1:E:117:ALA:HB2	1.98	0.46
1:F:14:VAL:O	1:F:15:THR:HB	2.15	0.46
1:F:86:MSE:HE1	1:F:337:TRP:CZ3	2.51	0.46
1:H:9:LEU:HD13	1:H:86:MSE:CE	2.38	0.46
1:B:233:ASP:HB2	1:B:237:LYS:N	2.29	0.46
1:C:104:ILE:HG22	1:C:133:LYS:HG3	1.98	0.46
1:G:10:ILE:HG13	1:G:87:PHE:HD1	1.81	0.46
1:G:55:SER:HB2	1:G:58:LYS:HG3	1.97	0.46
1:E:68:ILE:HG22	1:E:69:ALA:N	2.30	0.46
1:H:207:ARG:CZ	1:H:359:LYS:HB3	2.46	0.46
1:F:112:CYS:SG	1:F:116:ILE:HG22	2.55	0.46
1:G:370:SER:HB2	1:G:375:ARG:O	2.16	0.46
1:H:39:LEU:HB3	1:H:40:LYS:H	1.58	0.46
1:C:156:ARG:NH1	1:C:156:ARG:HG2	2.29	0.46
1:A:117:ALA:HB3	1:A:123:ALA:HB2	1.96	0.45
1:H:68:ILE:CG2	1:H:69:ALA:N	2.79	0.45
1:E:68:ILE:CG2	1:E:69:ALA:N	2.79	0.45
1:D:162:GLY:HA3	1:D:283:HIS:HD2	1.81	0.45
1:F:50:ILE:HD12	1:F:70:ARG:HB3	1.98	0.45
1:A:206:TRP:O	1:A:210:LEU:HG	2.15	0.45
1:G:155:LEU:HD21	1:G:323:LEU:HD11	1.98	0.45
1:H:342:ARG:O	1:H:346:GLU:HB3	2.16	0.45
1:E:199:ILE:O	1:E:203:VAL:HB	2.17	0.45
1:H:193:GLU:H	1:H:193:GLU:CD	2.20	0.45
1:B:114:LYS:HE2	1:B:204:CYS:SG	2.57	0.45
1:B:268:ARG:HD3	1:H:301:THR:OG1	2.17	0.45
1:C:136:LYS:HE3	1:C:343:HIS:O	2.16	0.45
1:H:200:LEU:HD23	1:H:368:LEU:HD11	1.99	0.45

Continued on next page...

Continued from previous page...

Atom-1	Atom-2	Interatomic distance (Å)	Clash overlap (Å)
1:H:211:ASP:OD1	1:H:216:ASN:HA	2.16	0.45
1:C:7:LEU:HG	1:C:7:LEU:O	2.16	0.45
1:B:14:VAL:CG2	1:B:24:LEU:HD22	2.46	0.45
1:B:96:ARG:N	1:B:97:PRO:HD2	2.32	0.45
1:D:275:VAL:HG12	1:D:290:LEU:HD12	1.98	0.45
1:B:21:ASN:HA	1:B:25:ILE:HD12	1.98	0.44
1:B:178:GLY:HA2	1:B:181:GLN:O	2.18	0.44
1:F:119:ASN:HD21	1:F:122:GLU:HB2	1.81	0.44
1:D:117:ALA:HB3	1:D:123:ALA:HB2	1.99	0.44
1:G:356:GLU:HA	1:G:359:LYS:HD2	1.99	0.44
1:A:96:ARG:O	1:A:100:LEU:HG	2.18	0.44
1:A:233:ASP:HB2	1:A:237:LYS:H	1.83	0.44
1:B:14:VAL:HG11	1:B:51:LEU:HD22	1.99	0.44
1:C:172:GLY:HA3	1:C:264:SER:O	2.18	0.44
1:E:38:ARG:H	1:E:38:ARG:HD3	1.82	0.44
1:H:32:ARG:HH21	1:H:49:PRO:CD	2.31	0.44
1:A:260:HIS:CE1	1:G:260:HIS:CE1	3.06	0.44
1:C:119:ASN:ND2	2:C:390:HOH:O	2.49	0.44
1:E:10:ILE:HA	1:E:50:ILE:HG23	1.99	0.44
1:H:231:ARG:O	1:H:238:LYS:HA	2.18	0.44
1:G:51:LEU:HD11	1:G:68:ILE:HG13	1.99	0.44
1:H:10:ILE:HG13	1:H:87:PHE:HD1	1.83	0.44
1:H:63:ALA:HB2	1:H:71:TRP:CD1	2.50	0.44
1:F:96:ARG:HD2	1:F:112:CYS:HB2	1.99	0.44
1:G:197:GLY:HA2	1:G:243:ALA:HB1	1.98	0.44
1:B:299:GLN:O	1:F:323:LEU:HD22	2.18	0.44
1:C:86:MSE:HE1	1:C:337:TRP:CZ3	2.53	0.44
1:D:26:ARG:NH1	1:D:26:ARG:CG	2.80	0.44
1:F:139:THR:HG22	1:F:353:THR:O	2.17	0.44
1:A:10:ILE:HG13	1:A:87:PHE:HD1	1.83	0.44
1:D:147:PRO:O	1:D:151:LYS:HG3	2.18	0.44
1:H:104:ILE:HG21	1:H:129:LEU:HB3	1.99	0.44
1:C:143:LYS:HD2	1:C:205:HIS:ND1	2.33	0.44
1:D:137:HIS:HB2	1:D:354:LEU:HG	1.99	0.44
1:H:76:ASP:HA	1:H:79:LEU:HB2	2.00	0.44
1:A:114:LYS:HE2	1:A:204:CYS:HB3	2.00	0.43
1:D:156:ARG:CG	1:D:156:ARG:NH1	2.70	0.43
1:G:160:PHE:CZ	1:G:295:ILE:HB	2.53	0.43
1:G:342:ARG:O	1:G:346:GLU:HB3	2.18	0.43
1:A:68:ILE:HG22	1:A:70:ARG:H	1.82	0.43
1:B:168:ARG:NH2	2:B:390:HOH:O	2.28	0.43

Continued on next page...

Continued from previous page...

Atom-1	Atom-2	Interatomic distance (Å)	Clash overlap (Å)
1:F:17:ARG:HH12	1:F:186:PRO:HG3	1.83	0.43
1:F:119:ASN:ND2	1:F:122:GLU:HB2	2.34	0.43
1:F:275:VAL:HG22	1:F:276:THR:H	1.83	0.43
1:F:311:LYS:HE2	1:F:311:LYS:C	2.39	0.43
1:G:178:GLY:HA2	1:G:181:GLN:O	2.17	0.43
1:H:46:MSE:HA	1:H:47:PRO:HD3	1.83	0.43
1:B:92:THR:HG22	1:B:94:GLN:HG2	2.00	0.43
1:E:119:ASN:OD1	1:E:121:GLU:HG2	2.19	0.43
1:F:168:ARG:NH1	2:F:391:HOH:O	2.43	0.43
1:A:9:LEU:O	1:A:49:PRO:HA	2.19	0.43
1:D:233:ASP:HB2	1:D:237:LYS:H	1.83	0.43
1:H:207:ARG:HD3	1:H:363:LEU:HB2	1.99	0.43
1:H:346:GLU:O	1:H:346:GLU:HG2	2.19	0.43
1:A:163:ARG:H	1:A:282:THR:HB	1.83	0.43
1:E:119:ASN:HB3	1:E:122:GLU:HB3	2.00	0.43
1:H:7:LEU:HD13	1:H:345:TYR:OH	2.19	0.43
1:C:340:PHE:O	1:C:343:HIS:HB3	2.19	0.43
1:B:313:LEU:O	1:B:313:LEU:HG	2.19	0.43
1:D:144:LEU:HD12	1:D:144:LEU:HA	1.92	0.43
1:D:178:GLY:HA3	1:D:232:PHE:HB2	2.01	0.43
1:F:64:LYS:HB2	1:F:64:LYS:HE3	1.86	0.43
1:F:81:ASP:HB3	1:F:83:ASN:OD1	2.19	0.43
1:A:172:GLY:HA3	1:A:264:SER:O	2.19	0.42
1:E:97:PRO:HG2	1:E:122:GLU:OE2	2.19	0.42
1:A:86:MSE:CE	1:A:337:TRP:CZ3	3.02	0.42
1:E:276:THR:HA	1:E:288:ALA:O	2.19	0.42
1:B:39:LEU:HD22	1:B:346:GLU:HB2	2.00	0.42
1:B:116:ILE:HD11	1:B:123:ALA:HB1	2.01	0.42
1:F:178:GLY:HA3	1:F:232:PHE:HB2	2.02	0.42
1:C:35:GLY:O	1:C:44:ARG:HD3	2.19	0.42
1:E:100:LEU:HD22	1:E:110:VAL:CG1	2.49	0.42
1:H:68:ILE:HG22	1:H:69:ALA:H	1.84	0.42
1:C:16:GLY:C	1:C:17:ARG:HG3	2.39	0.42
1:C:207:ARG:HD3	1:C:363:LEU:HB2	2.00	0.42
1:C:278:GLN:HA	1:C:286:ALA:O	2.19	0.42
1:G:89:ASP:OD2	1:G:96:ARG:HG3	2.19	0.42
1:H:86:MSE:HG3	1:H:109:HIS:HB2	2.01	0.42
1:D:119:ASN:HD22	1:D:121:GLU:CG	2.24	0.42
1:E:14:VAL:HG22	1:E:15:THR:N	2.34	0.42
1:F:10:ILE:HA	1:F:50:ILE:HG23	2.02	0.42
1:F:52:VAL:HG21	1:F:75:LEU:HD23	2.02	0.42

Continued on next page...

Continued from previous page...

Atom-1	Atom-2	Interatomic distance (Å)	Clash overlap (Å)
1:H:302:PRO:HG3	1:H:319:ASP:OD1	2.19	0.42
1:A:177:GLU:HG2	1:A:228:ILE:HG21	2.02	0.42
1:F:260:HIS:NE2	1:F:262:ASN:OD1	2.47	0.42
1:H:307:ASN:HA	1:H:308:PRO:HD3	1.84	0.42
1:A:86:MSE:HE2	1:A:337:TRP:HZ3	1.85	0.41
1:D:116:ILE:HD11	1:D:123:ALA:HB1	2.03	0.41
1:E:248:TYR:CD2	1:E:248:TYR:N	2.87	0.41
1:F:156:ARG:HG2	1:F:156:ARG:HH11	1.85	0.41
1:G:7:LEU:HB3	1:G:47:PRO:HA	2.02	0.41
1:B:111:TYR:HA	1:B:138:GLY:O	2.20	0.41
1:C:117:ALA:HB3	1:C:123:ALA:HB2	2.01	0.41
1:C:163:ARG:NH1	1:F:227:ASP:O	2.53	0.41
1:D:23:HIS:CE1	1:D:140:VAL:HG21	2.55	0.41
1:E:334:LYS:O	1:E:338:GLU:HG3	2.19	0.41
1:G:111:TYR:HA	1:G:138:GLY:O	2.20	0.41
1:A:39:LEU:HD11	1:A:45:ILE:HG12	2.01	0.41
1:C:275:VAL:HG12	1:C:290:LEU:CD1	2.51	0.41
1:D:72:THR:HB	1:D:74:ASP:H	1.84	0.41
1:G:104:ILE:HG22	1:G:133:LYS:HG3	2.01	0.41
1:G:167:VAL:O	1:G:259:ALA:HA	2.19	0.41
1:A:202:MSE:O	1:A:205:HIS:HB2	2.21	0.41
1:B:92:THR:HB	1:B:95:ALA:HB3	2.02	0.41
1:G:275:VAL:O	1:G:289:GLY:HA2	2.21	0.41
1:E:121:GLU:CD	1:E:121:GLU:H	2.24	0.41
1:H:88:PHE:HA	1:H:111:TYR:O	2.20	0.41
1:B:155:LEU:HD23	1:F:299:GLN:HG2	2.03	0.41
1:C:17:ARG:HB2	1:C:18:MSE:H	1.73	0.41
1:C:143:LYS:HE2	1:C:202:MSE:HE1	2.02	0.41
1:D:286:ALA:HA	1:D:294:MSE:O	2.21	0.41
1:F:25:ILE:HG12	1:F:66:PHE:CZ	2.56	0.41
1:H:119:ASN:ND2	1:H:120:PHE:N	2.68	0.41
1:A:178:GLY:HA2	1:A:181:GLN:O	2.20	0.41
1:F:275:VAL:HG12	1:F:290:LEU:HD12	2.02	0.41
1:C:203:VAL:HA	1:C:206:TRP:CD1	2.55	0.40
1:D:46:MSE:HA	1:D:47:PRO:HD3	1.98	0.40
1:E:23:HIS:O	1:E:27:SER:HB2	2.21	0.40
1:A:228:ILE:HA	1:A:229:PRO:HD3	1.99	0.40
1:B:197:GLY:HA2	1:B:243:ALA:HB1	2.03	0.40
1:F:104:ILE:C	1:F:106:ALA:H	2.24	0.40
1:C:86:MSE:HE1	1:C:337:TRP:HZ3	1.86	0.40
1:F:86:MSE:HE1	1:F:337:TRP:HZ3	1.86	0.40

Continued on next page...

Continued from previous page...

Atom-1	Atom-2	Interatomic distance (Å)	Clash overlap (Å)
1:A:88:PHE:CZ	1:A:90:ALA:HB2	2.57	0.40
1:D:252:GLN:HE21	1:D:252:GLN:HB2	1.66	0.40
1:H:275:VAL:HG12	1:H:290:LEU:CD1	2.51	0.40
1:B:88:PHE:HA	1:B:111:TYR:O	2.21	0.40

There are no symmetry-related clashes.

5.3 Torsion angles [i](#)

5.3.1 Protein backbone [i](#)

In the following table, the Percentiles column shows the percent Ramachandran outliers of the chain as a percentile score with respect to all X-ray entries followed by that with respect to entries of similar resolution.

The Analysed column shows the number of residues for which the backbone conformation was analysed, and the total number of residues.

Mol	Chain	Analysed	Favoured	Allowed	Outliers	Percentiles	
1	A	372/383 (97%)	353 (95%)	15 (4%)	4 (1%)	14	30
1	B	373/383 (97%)	352 (94%)	19 (5%)	2 (0%)	29	52
1	C	373/383 (97%)	358 (96%)	11 (3%)	4 (1%)	14	30
1	D	374/383 (98%)	352 (94%)	21 (6%)	1 (0%)	41	64
1	E	373/383 (97%)	355 (95%)	15 (4%)	3 (1%)	19	39
1	F	375/383 (98%)	355 (95%)	17 (4%)	3 (1%)	19	39
1	G	374/383 (98%)	350 (94%)	19 (5%)	5 (1%)	12	24
1	H	371/383 (97%)	339 (91%)	28 (8%)	4 (1%)	14	30
All	All	2985/3064 (97%)	2814 (94%)	145 (5%)	26 (1%)	17	35

All (26) Ramachandran outliers are listed below:

Mol	Chain	Res	Type
1	E	15	THR
1	E	69	ALA
1	G	313	LEU
1	H	15	THR
1	H	233	ASP
1	A	15	THR

Continued on next page...

Continued from previous page...

Mol	Chain	Res	Type
1	A	91	ALA
1	B	16	GLY
1	B	233	ASP
1	C	69	ALA
1	E	233	ASP
1	F	105	ASN
1	G	67	ASN
1	H	16	GLY
1	H	69	ALA
1	A	17	ARG
1	D	67	ASN
1	G	16	GLY
1	G	91	ALA
1	C	17	ARG
1	C	233	ASP
1	F	15	THR
1	G	233	ASP
1	A	233	ASP
1	C	91	ALA
1	F	233	ASP

5.3.2 Protein sidechains [i](#)

In the following table, the Percentiles column shows the percent sidechain outliers of the chain as a percentile score with respect to all X-ray entries followed by that with respect to entries of similar resolution.

The Analysed column shows the number of residues for which the sidechain conformation was analysed, and the total number of residues.

Mol	Chain	Analysed	Rotameric	Outliers	Percentiles	
1	A	310/309 (100%)	295 (95%)	15 (5%)	25	49
1	B	311/309 (101%)	286 (92%)	25 (8%)	12	24
1	C	311/309 (101%)	285 (92%)	26 (8%)	11	21
1	D	311/309 (101%)	289 (93%)	22 (7%)	14	29
1	E	310/309 (100%)	285 (92%)	25 (8%)	11	23
1	F	312/309 (101%)	284 (91%)	28 (9%)	9	18
1	G	311/309 (101%)	288 (93%)	23 (7%)	13	28
1	H	308/309 (100%)	284 (92%)	24 (8%)	12	25

Continued on next page...

Continued from previous page...

Mol	Chain	Analysed	Rotameric	Outliers	Percentiles	
All	All	2484/2472 (100%)	2296 (92%)	188 (8%)	13	26

All (188) residues with a non-rotameric sidechain are listed below:

Mol	Chain	Res	Type
1	A	6	ARG
1	A	10	ILE
1	A	15	THR
1	A	38	ARG
1	A	54	ARG
1	A	64	LYS
1	A	72	THR
1	A	75	LEU
1	A	85	THR
1	A	119	ASN
1	A	168	ARG
1	A	237	LYS
1	A	252	GLN
1	A	276	THR
1	A	321	GLN
1	B	4	THR
1	B	10	ILE
1	B	38	ARG
1	B	40	LYS
1	B	43	ASP
1	B	70	ARG
1	B	72	THR
1	B	74	ASP
1	B	76	ASP
1	B	82	LYS
1	B	94	GLN
1	B	110	VAL
1	B	118	THR
1	B	141	GLN
1	B	143	LYS
1	B	168	ARG
1	B	182	GLU
1	B	200	LEU
1	B	230	GLU
1	B	233	ASP
1	B	235	GLN
1	B	276	THR

Continued on next page...

Continued from previous page...

Mol	Chain	Res	Type
1	B	307	ASN
1	B	321	GLN
1	B	330	ASP
1	C	17	ARG
1	C	21	ASN
1	C	38	ARG
1	C	40	LYS
1	C	54	ARG
1	C	68	ILE
1	C	72	THR
1	C	75	LEU
1	C	76	ASP
1	C	85	THR
1	C	93	THR
1	C	94	GLN
1	C	110	VAL
1	C	114	LYS
1	C	119	ASN
1	C	144	LEU
1	C	168	ARG
1	C	200	LEU
1	C	204	CYS
1	C	230	GLU
1	C	271	ARG
1	C	276	THR
1	C	282	THR
1	C	313	LEU
1	C	328	SER
1	C	347	ASP
1	D	10	ILE
1	D	17	ARG
1	D	26	ARG
1	D	38	ARG
1	D	41	ASN
1	D	46	MSE
1	D	60	GLU
1	D	65	ARG
1	D	67	ASN
1	D	72	THR
1	D	92	THR
1	D	93	THR
1	D	99	LEU

Continued on next page...

Continued from previous page...

Mol	Chain	Res	Type
1	D	110	VAL
1	D	168	ARG
1	D	200	LEU
1	D	204	CYS
1	D	252	GLN
1	D	253	LEU
1	D	276	THR
1	D	312	ARG
1	D	370	SER
1	E	6	ARG
1	E	10	ILE
1	E	11	MSE
1	E	32	ARG
1	E	38	ARG
1	E	54	ARG
1	E	68	ILE
1	E	72	THR
1	E	75	LEU
1	E	83	ASN
1	E	85	THR
1	E	93	THR
1	E	110	VAL
1	E	118	THR
1	E	144	LEU
1	E	168	ARG
1	E	200	LEU
1	E	271	ARG
1	E	276	THR
1	E	282	THR
1	E	305	VAL
1	E	313	LEU
1	E	330	ASP
1	E	347	ASP
1	E	383	LYS
1	F	17	ARG
1	F	38	ARG
1	F	40	LYS
1	F	46	MSE
1	F	50	ILE
1	F	54	ARG
1	F	58	LYS
1	F	75	LEU

Continued on next page...

Continued from previous page...

Mol	Chain	Res	Type
1	F	92	THR
1	F	93	THR
1	F	94	GLN
1	F	99	LEU
1	F	112	CYS
1	F	118	THR
1	F	125	GLU
1	F	168	ARG
1	F	235	GLN
1	F	237	LYS
1	F	252	GLN
1	F	271	ARG
1	F	276	THR
1	F	282	THR
1	F	311	LYS
1	F	312	ARG
1	F	313	LEU
1	F	347	ASP
1	F	374	ARG
1	F	383	LYS
1	G	10	ILE
1	G	11	MSE
1	G	15	THR
1	G	32	ARG
1	G	38	ARG
1	G	40	LYS
1	G	43	ASP
1	G	65	ARG
1	G	73	THR
1	G	76	ASP
1	G	93	THR
1	G	94	GLN
1	G	119	ASN
1	G	132	SER
1	G	142	ASP
1	G	168	ARG
1	G	200	LEU
1	G	252	GLN
1	G	276	THR
1	G	282	THR
1	G	305	VAL
1	G	321	GLN

Continued on next page...

Continued from previous page...

Mol	Chain	Res	Type
1	G	374	ARG
1	H	10	ILE
1	H	15	THR
1	H	17	ARG
1	H	38	ARG
1	H	39	LEU
1	H	60	GLU
1	H	64	LYS
1	H	65	ARG
1	H	75	LEU
1	H	76	ASP
1	H	92	THR
1	H	94	GLN
1	H	110	VAL
1	H	119	ASN
1	H	129	LEU
1	H	144	LEU
1	H	150	LYS
1	H	168	ARG
1	H	276	THR
1	H	282	THR
1	H	307	ASN
1	H	330	ASP
1	H	351	LYS
1	H	370	SER

Sometimes sidechains can be flipped to improve hydrogen bonding and reduce clashes. All (30) such sidechains are listed below:

Mol	Chain	Res	Type
1	A	21	ASN
1	A	137	HIS
1	A	252	GLN
1	A	283	HIS
1	A	296	GLN
1	B	216	ASN
1	B	235	GLN
1	B	283	HIS
1	B	307	ASN
1	C	94	GLN
1	C	283	HIS
1	C	321	GLN
1	D	67	ASN

Continued on next page...

Continued from previous page...

Mol	Chain	Res	Type
1	D	216	ASN
1	D	252	GLN
1	D	283	HIS
1	E	216	ASN
1	E	321	GLN
1	F	94	GLN
1	F	137	HIS
1	F	216	ASN
1	F	235	GLN
1	F	252	GLN
1	F	283	HIS
1	G	189	ASN
1	G	283	HIS
1	G	296	GLN
1	H	216	ASN
1	H	283	HIS
1	H	307	ASN

5.3.3 RNA [i](#)

There are no RNA molecules in this entry.

5.4 Non-standard residues in protein, DNA, RNA chains [i](#)

There are no non-standard protein/DNA/RNA residues in this entry.

5.5 Carbohydrates [i](#)

There are no monosaccharides in this entry.

5.6 Ligand geometry [i](#)

There are no ligands in this entry.

5.7 Other polymers [i](#)

There are no such residues in this entry.

5.8 Polymer linkage issues

There are no chain breaks in this entry.

6 Fit of model and data

6.1 Protein, DNA and RNA chains

In the following table, the column labelled ‘#RSRZ > 2’ contains the number (and percentage) of RSRZ outliers, followed by percent RSRZ outliers for the chain as percentile scores relative to all X-ray entries and entries of similar resolution. The OWAB column contains the minimum, median, 95th percentile and maximum values of the occupancy-weighted average B-factor per residue. The column labelled ‘Q < 0.9’ lists the number of (and percentage) of residues with an average occupancy less than 0.9.

Mol	Chain	Analysed	<RSRZ>	#RSRZ>2	OWAB(Å ²)	Q<0.9
1	A	368/383 (96%)	-0.14	11 (2%) 50 43	26, 53, 101, 116	0
1	B	369/383 (96%)	-0.15	12 (3%) 46 39	22, 50, 107, 115	0
1	C	369/383 (96%)	-0.26	7 (1%) 66 62	25, 43, 83, 110	0
1	D	370/383 (96%)	-0.22	8 (2%) 62 56	20, 46, 90, 106	0
1	E	369/383 (96%)	-0.35	5 (1%) 75 71	22, 41, 76, 92	0
1	F	371/383 (96%)	-0.11	11 (2%) 50 43	26, 53, 88, 98	0
1	G	370/383 (96%)	0.14	26 (7%) 16 12	26, 60, 125, 137	0
1	H	367/383 (95%)	0.06	27 (7%) 14 10	24, 46, 132, 144	0
All	All	2953/3064 (96%)	-0.13	107 (3%) 42 35	20, 49, 108, 144	0

All (107) RSRZ outliers are listed below:

Mol	Chain	Res	Type	RSRZ
1	H	70	ARG	5.3
1	G	54	ARG	5.2
1	H	55	SER	4.8
1	G	57	GLU	4.6
1	H	54	ARG	4.5
1	C	180	TRP	4.5
1	H	57	GLU	4.5
1	H	58	LYS	4.0
1	F	312	ARG	4.0
1	G	17	ARG	4.0
1	H	56	ALA	3.9
1	D	312	ARG	3.8
1	F	132	SER	3.8
1	G	64	LYS	3.7
1	G	312	ARG	3.7
1	G	3	THR	3.6

Continued on next page...

Continued from previous page...

Mol	Chain	Res	Type	RSRZ
1	H	42	GLY	3.6
1	B	4	THR	3.6
1	G	75	LEU	3.6
1	G	82	LYS	3.5
1	A	69	ALA	3.5
1	G	4	THR	3.4
1	B	16	GLY	3.4
1	B	17	ARG	3.3
1	H	17	ARG	3.3
1	F	42	GLY	3.2
1	H	3	THR	3.2
1	H	71	TRP	3.2
1	H	83	ASN	3.2
1	C	57	GLU	3.2
1	H	41	ASN	3.2
1	D	311	LYS	3.1
1	C	54	ARG	3.0
1	A	64	LYS	3.0
1	G	67	ASN	2.9
1	H	40	LYS	2.9
1	C	312	ARG	2.9
1	B	41	ASN	2.9
1	A	54	ARG	2.9
1	G	51	LEU	2.8
1	C	55	SER	2.8
1	G	83	ASN	2.8
1	F	313	LEU	2.8
1	D	17	ARG	2.8
1	B	69	ALA	2.8
1	G	38	ARG	2.8
1	F	134	GLY	2.7
1	H	38	ARG	2.7
1	B	3	THR	2.7
1	D	56	ALA	2.7
1	E	17	ARG	2.7
1	A	55	SER	2.7
1	G	349	PRO	2.7
1	E	58	LYS	2.7
1	H	82	LYS	2.6
1	B	180	TRP	2.6
1	G	71	TRP	2.6
1	H	53	GLY	2.6

Continued on next page...

Continued from previous page...

Mol	Chain	Res	Type	RSRZ
1	D	69	ALA	2.6
1	A	313	LEU	2.6
1	E	54	ARG	2.6
1	H	69	ALA	2.6
1	B	40	LYS	2.6
1	D	38	ARG	2.6
1	H	60	GLU	2.6
1	C	305	VAL	2.5
1	F	54	ARG	2.5
1	H	44	ARG	2.5
1	H	349	PRO	2.5
1	D	57	GLU	2.5
1	G	40	LYS	2.5
1	G	58	LYS	2.5
1	G	133	LYS	2.4
1	G	351	LYS	2.4
1	H	93	THR	2.4
1	H	50	ILE	2.4
1	H	81	ASP	2.3
1	A	82	LYS	2.3
1	G	43	ASP	2.3
1	E	40	LYS	2.3
1	D	58	LYS	2.3
1	G	132	SER	2.3
1	B	54	ARG	2.3
1	G	134	GLY	2.3
1	A	10	ILE	2.2
1	B	58	LYS	2.2
1	H	27	SER	2.2
1	H	72	THR	2.2
1	F	328	SER	2.2
1	A	77	ALA	2.2
1	A	41	ASN	2.2
1	G	52	VAL	2.2
1	C	38	ARG	2.2
1	G	55	SER	2.1
1	B	57	GLU	2.1
1	A	17	ARG	2.1
1	E	38	ARG	2.1
1	G	41	ASN	2.1
1	F	53	GLY	2.1
1	G	313	LEU	2.1

Continued on next page...

Continued from previous page...

Mol	Chain	Res	Type	RSRZ
1	F	69	ALA	2.1
1	F	57	GLU	2.1
1	A	58	LYS	2.1
1	H	28	ILE	2.1
1	B	337	TRP	2.0
1	F	349	PRO	2.0
1	H	4	THR	2.0

6.2 Non-standard residues in protein, DNA, RNA chains [i](#)

There are no non-standard protein/DNA/RNA residues in this entry.

6.3 Carbohydrates [i](#)

There are no monosaccharides in this entry.

6.4 Ligands [i](#)

There are no ligands in this entry.

6.5 Other polymers [i](#)

There are no such residues in this entry.