



wwPDB EM Validation Summary Report ⓘ

Nov 12, 2024 – 10:21 am GMT

PDB ID : 8P7X
EMDB ID : EMD-17132
Title : Mycoplasma pneumoniae 70S ribosome in chloramphenicol-treated cells
Authors : Schacherl, M.; Xue, L.; Spahn, C.M.T.; Mahamid, J.
Deposited on : 2023-05-31
Resolution : 3.03 Å(reported)
Based on initial models : 7OOC, 7OOD

This is a wwPDB EM Validation Summary Report for a publicly released PDB entry.

We welcome your comments at validation@mail.wwpdb.org

A user guide is available at

<https://www.wwpdb.org/validation/2017/EMValidationReportHelp>

with specific help available everywhere you see the ⓘ symbol.

The types of validation reports are described at

<http://www.wwpdb.org/validation/2017/FAQs#types>.

The following versions of software and data (see [references ⓘ](#)) were used in the production of this report:

EMDB validation analysis : 0.0.1.dev113
Mogul : 1.8.4, CSD as541be (2020)
MolProbity : 4.02b-467
buster-report : 1.1.7 (2018)
Percentile statistics : 20231227.v01 (using entries in the PDB archive December 27th 2023)
MapQ : 1.9.13
Ideal geometry (proteins) : Engh & Huber (2001)
Ideal geometry (DNA, RNA) : Parkinson et al. (1996)
Validation Pipeline (wwPDB-VP) : 2.39

1 Overall quality at a glance i

The following experimental techniques were used to determine the structure:
ELECTRON MICROSCOPY

The reported resolution of this entry is 3.03 Å.

Percentile scores (ranging between 0-100) for global validation metrics of the entry are shown in the following graphic. The table shows the number of entries on which the scores are based.

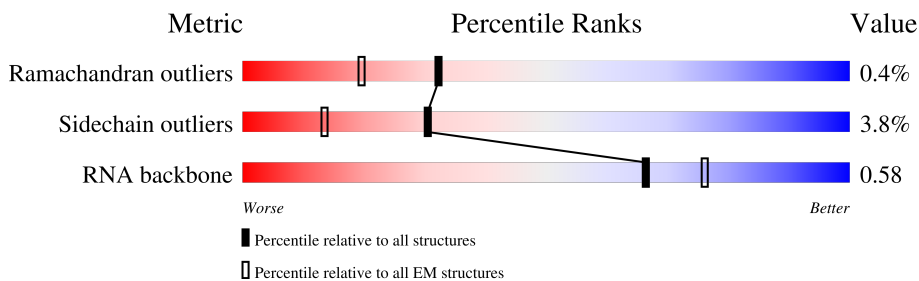

Metric	Whole archive (#Entries)	EM structures (#Entries)
Ramachandran outliers	207382	16835
Sidechain outliers	206894	16415
RNA backbone	6643	2191

The table below summarises the geometric issues observed across the polymeric chains and their fit to the map. The red, orange, yellow and green segments of the bar indicate the fraction of residues that contain outliers for ≥ 3 , 2, 1 and 0 types of geometric quality criteria respectively. A grey segment represents the fraction of residues that are not modelled. The numeric value for each fraction is indicated below the corresponding segment, with a dot representing fractions $\leq 5\%$. The upper red bar (where present) indicates the fraction of residues that have poor fit to the EM map (all-atom inclusion $< 40\%$). The numeric value is given above the bar.

Mol	Chain	Length	Quality of chain
1	0	48	
2	1	59	
3	2	37	
4	3	2907	
5	4	108	
6	5	1520	
7	6	76	
8	7	75	

Continued on next page...

Continued from previous page...

Mol	Chain	Length	Quality of chain
9	8	76	75% 70% 29%
10	A	294	73% 87% 10%
11	B	273	49% 81% 15%
12	C	205	89% 94% 5%
13	D	219	32% 70% 29%
14	E	215	79% 81% 5% 14%
15	F	155	90% 97%
16	G	142	69% 93% 6%
17	H	132	79% 94%
18	I	108	78% 93%
19	J	121	77% 91% 6%
20	K	139	40% 92% 5%
21	L	124	94% 94% 5%
22	M	61	56% 98%
23	N	86	79% 98%
24	O	94	78% 88% 7%
25	P	85	85% 93% 7%
26	Q	104	52% 66% 32%
27	R	87	91% 93% 6%
28	S	87	76% 89% 9%
29	T	60	72% 90% 8%
30	X	444	7% 6% 93%
31	Y	21	52% 33% 67%
32	Z	36	94% 100%
33	a	287	8% 98%

Continued on next page...

Continued from previous page...

Mol	Chain	Length	Quality of chain
34	b	287	8% 77% 20%
35	c	212	14% 95% 5%
36	d	180	65% 94% 6%
37	e	184	29% 92% • •
38	f	149	82% 96% •
39	g	161	77% 73% 5% 22%
40	h	137	93% 91% • 7%
41	i	146	8% 95% • •
42	j	122	6% 98% •
43	k	151	13% 95% • •
44	l	139	5% 94% • •
45	m	124	• 91% 5% •
46	n	116	16% 97% •
47	o	119	11% 97% • •
48	p	127	9% 91% • 7%
49	q	100	11% 93% 6% •
50	r	159	• 87% • 11%
51	s	237	• 38% 60%
52	t	111	32% 96% •
53	u	104	17% 83% • 15%
54	v	65	17% 97% • •
55	w	111	29% 95% 5% •
56	x	97	93% 89% 10% •
57	y	57	11% 84% 14% •
58	z	53	9% 91% • 6%

2 Entry composition

There are 67 unique types of molecules in this entry. The entry contains 151591 atoms, of which 0 are hydrogens and 0 are deuteriums.

In the tables below, the AltConf column contains the number of residues with at least one atom in alternate conformation and the Trace column contains the number of residues modelled with at most 2 atoms.

- Molecule 1 is a protein called 50S ribosomal protein L34.

Mol	Chain	Residues	Atoms					AltConf	Trace
			Total	C	N	O	S		
1	0	48	392	242	85	63	2	0	0

- Molecule 2 is a protein called 50S ribosomal protein L35.

Mol	Chain	Residues	Atoms					AltConf	Trace
			Total	C	N	O	S		
2	1	59	477	300	99	77	1	0	0

- Molecule 3 is a protein called 50S ribosomal protein L36.

Mol	Chain	Residues	Atoms					AltConf	Trace
			Total	C	N	O	S		
3	2	37	304	189	65	46	4	0	0

- Molecule 4 is a RNA chain called 23S ribosomal RNA.

Mol	Chain	Residues	Atoms					AltConf	Trace
			Total	C	N	O	P		
4	3	2893	61995	27704	11293	20105	2893	0	0

- Molecule 5 is a RNA chain called 5S ribosomal RNA.

Mol	Chain	Residues	Atoms					AltConf	Trace
			Total	C	N	O	P		
5	4	108	2305	1030	415	752	108	0	0

- Molecule 6 is a RNA chain called 16S ribosomal RNA.

Mol	Chain	Residues	Atoms					AltConf	Trace
			Total	C	N	O	P		
6	5	1507	32258	14420	5847	10484	1507	0	0

There is a discrepancy between the modelled and reference sequences:

Chain	Residue	Modelled	Actual	Comment	Reference
5	1003	A	G	conflict	GB 26117688

- Molecule 7 is a RNA chain called tRNA-Ala (E-site).

Mol	Chain	Residues	Atoms					AltConf	Trace
7	6	76	Total	C	N	O	P	0	0
			1620	723	287	534	76		

- Molecule 8 is a RNA chain called tRNA-Asp (P-site).

Mol	Chain	Residues	Atoms					AltConf	Trace
8	7	75	Total	C	N	O	P	0	0
			1599	712	279	533	75		

There are 2 discrepancies between the modelled and reference sequences:

Chain	Residue	Modelled	Actual	Comment	Reference
7	17	G	-	insertion	GB 26117688
7	55	C	U	conflict	GB 26117688

- Molecule 9 is a RNA chain called tRNA-Lys (A-site).

Mol	Chain	Residues	Atoms					AltConf	Trace
9	8	76	Total	C	N	O	P	0	0
			1615	722	284	533	76		

- Molecule 10 is a protein called 30S ribosomal protein S2.

Mol	Chain	Residues	Atoms					AltConf	Trace
10	A	266	Total	C	N	O	S	0	0
			2138	1359	376	394	9		

- Molecule 11 is a protein called 30S ribosomal protein S3.

Mol	Chain	Residues	Atoms					AltConf	Trace
11	B	232	Total	C	N	O	S	0	0
			1835	1158	343	329	5		

- Molecule 12 is a protein called 30S ribosomal protein S4.

Mol	Chain	Residues	Atoms					AltConf	Trace
12	C	204	Total	C	N	O	S	0	0
			1669	1057	316	292	4		

- Molecule 13 is a protein called 30S ribosomal protein S5.

Mol	Chain	Residues	Atoms					AltConf	Trace
13	D	155	Total	C	N	O	S	0	0
			1191	753	228	207	3		

- Molecule 14 is a protein called 30S ribosomal protein S6.

Mol	Chain	Residues	Atoms					AltConf	Trace
14	E	184	Total	C	N	O	S	0	0
			1509	950	270	287	2		

- Molecule 15 is a protein called 30S ribosomal protein S7.

Mol	Chain	Residues	Atoms					AltConf	Trace
15	F	155	Total	C	N	O	S	0	0
			1254	790	240	217	7		

- Molecule 16 is a protein called 30S ribosomal protein S8.

Mol	Chain	Residues	Atoms					AltConf	Trace
16	G	141	Total	C	N	O	S	0	0
			1110	723	193	192	2		

- Molecule 17 is a protein called 30S ribosomal protein S9.

Mol	Chain	Residues	Atoms					AltConf	Trace
17	H	129	Total	C	N	O	S	0	0
			1040	661	195	183	1		

- Molecule 18 is a protein called 30S ribosomal protein S10.

Mol	Chain	Residues	Atoms					AltConf	Trace
18	I	104	Total	C	N	O	S	0	0
			832	536	147	148	1		

- Molecule 19 is a protein called 30S ribosomal protein S11.

Mol	Chain	Residues	Atoms					AltConf	Trace
19	J	114	Total	C	N	O	S	0	0
			829	514	153	156	6		

- Molecule 20 is a protein called 30S ribosomal protein S12.

Mol	Chain	Residues	Atoms					AltConf	Trace
20	K	135	Total	C	N	O	S	0	0
			1071	677	212	180	2		

- Molecule 21 is a protein called 30S ribosomal protein S13.

Mol	Chain	Residues	Atoms				AltConf	Trace
21	L	123	Total	C	N	O	0	0
			991	618	200	173		

- Molecule 22 is a protein called 30S ribosomal protein S14 type Z.

Mol	Chain	Residues	Atoms					AltConf	Trace
22	M	60	Total	C	N	O	S	0	0
			474	302	96	72	4		

- Molecule 23 is a protein called 30S ribosomal protein S15.

Mol	Chain	Residues	Atoms				AltConf	Trace
23	N	85	Total	C	N	O	0	0
			689	436	130	123		

- Molecule 24 is a protein called 30S ribosomal protein S16.

Mol	Chain	Residues	Atoms					AltConf	Trace
24	O	87	Total	C	N	O	S	0	0
			705	453	130	118	4		

- Molecule 25 is a protein called 30S ribosomal protein S17.

Mol	Chain	Residues	Atoms					AltConf	Trace
25	P	85	Total	C	N	O	S	0	0
			693	436	138	118	1		

- Molecule 26 is a protein called 30S ribosomal protein S18.

Mol	Chain	Residues	Atoms					AltConf	Trace
26	Q	71	Total	C	N	O	S	0	0
			590	378	115	93	4		

- Molecule 27 is a protein called 30S ribosomal protein S19.

Mol	Chain	Residues	Atoms					AltConf	Trace
27	R	86	Total	C	N	O	S	0	0
			700	444	132	122	2		

- Molecule 28 is a protein called 30S ribosomal protein S20.

Mol	Chain	Residues	Atoms				AltConf	Trace
28	S	79	Total	C	N	O	0	0
			643	391	138	114		

- Molecule 29 is a protein called 30S ribosomal protein S21.

Mol	Chain	Residues	Atoms					AltConf	Trace
29	T	59	Total	C	N	O	S	0	0
			519	326	111	80	2		

- Molecule 30 is a protein called Trigger factor.

Mol	Chain	Residues	Atoms					AltConf	Trace
30	X	30	Total	C	N	O	S	0	0
			242	155	43	43	1		

- Molecule 31 is a RNA chain called mRNA.

Mol	Chain	Residues	Atoms					AltConf	Trace
31	Y	21	Total	C	N	O	P	0	0
			446	200	80	145	21		

- Molecule 32 is a protein called Nascent chain.

Mol	Chain	Residues	Atoms				AltConf	Trace
32	Z	36	Total	C	N	O	0	0
			187	112	37	38		

- Molecule 33 is a protein called 50S ribosomal protein L2.

Mol	Chain	Residues	Atoms					AltConf	Trace
			Total	C	N	O	S		
33	a	285	2225	1385	437	397	6	0	0

- Molecule 34 is a protein called 50S ribosomal protein L3.

Mol	Chain	Residues	Atoms					AltConf	Trace
			Total	C	N	O	S		
34	b	231	1778	1129	320	322	7	0	0

- Molecule 35 is a protein called 50S ribosomal protein L4.

Mol	Chain	Residues	Atoms					AltConf	Trace
			Total	C	N	O	S		
35	c	211	1654	1053	299	299	3	0	0

- Molecule 36 is a protein called 50S ribosomal protein L5.

Mol	Chain	Residues	Atoms					AltConf	Trace
			Total	C	N	O	S		
36	d	179	1416	910	251	251	4	0	0

- Molecule 37 is a protein called 50S ribosomal protein L6.

Mol	Chain	Residues	Atoms				AltConf	Trace
			Total	C	N	O		
37	e	176	1396	899	247	250	0	0

- Molecule 38 is a protein called 50S ribosomal protein L9.

Mol	Chain	Residues	Atoms					AltConf	Trace
			Total	C	N	O	S		
38	f	149	1208	779	212	214	3	0	0

- Molecule 39 is a protein called 50S ribosomal protein L10.

Mol	Chain	Residues	Atoms					AltConf	Trace
			Total	C	N	O	S		
39	g	125	951	606	165	177	3	0	0

- Molecule 40 is a protein called 50S ribosomal protein L11.

Mol	Chain	Residues	Atoms					AltConf	Trace
			Total	C	N	O	S		
40	h	128	959	616	160	177	6	0	0

- Molecule 41 is a protein called 50S ribosomal protein L13.

Mol	Chain	Residues	Atoms					AltConf	Trace
			Total	C	N	O	S		
41	i	144	1164	737	213	209	5	0	0

- Molecule 42 is a protein called 50S ribosomal protein L14.

Mol	Chain	Residues	Atoms					AltConf	Trace
			Total	C	N	O	S		
42	j	122	944	595	178	167	4	0	0

- Molecule 43 is a protein called 50S ribosomal protein L15.

Mol	Chain	Residues	Atoms					AltConf	Trace
			Total	C	N	O	S		
43	k	150	1170	741	228	200	1	0	0

- Molecule 44 is a protein called 50S ribosomal protein L16.

Mol	Chain	Residues	Atoms					AltConf	Trace
			Total	C	N	O	S		
44	l	136	1079	694	196	182	7	0	0

- Molecule 45 is a protein called 50S ribosomal protein L17.

Mol	Chain	Residues	Atoms					AltConf	Trace
			Total	C	N	O	S		
45	m	119	958	609	175	171	3	0	0

- Molecule 46 is a protein called 50S ribosomal protein L18.

Mol	Chain	Residues	Atoms					AltConf	Trace
			Total	C	N	O	S		
46	n	116	918	573	181	162	2	0	0

- Molecule 47 is a protein called 50S ribosomal protein L19.

Mol	Chain	Residues	Atoms					AltConf	Trace
47	o	118	Total	C	N	O	S	0	0
			966	609	186	170	1		

- Molecule 48 is a protein called 50S ribosomal protein L20.

Mol	Chain	Residues	Atoms					AltConf	Trace
48	p	118	Total	C	N	O	S	0	0
			981	624	194	161	2		

- Molecule 49 is a protein called 50S ribosomal protein L21.

Mol	Chain	Residues	Atoms					AltConf	Trace
49	q	99	Total	C	N	O	S	0	0
			811	525	148	134	4		

- Molecule 50 is a protein called 50S ribosomal protein L22.

Mol	Chain	Residues	Atoms					AltConf	Trace
50	r	142	Total	C	N	O	S	0	0
			1091	677	212	195	7		

- Molecule 51 is a protein called 50S ribosomal protein L23.

Mol	Chain	Residues	Atoms					AltConf	Trace
51	s	95	Total	C	N	O	S	0	0
			740	486	125	128	1		

- Molecule 52 is a protein called 50S ribosomal protein L24.

Mol	Chain	Residues	Atoms					AltConf	Trace
52	t	111	Total	C	N	O	S	0	0
			871	550	166	152	3		

- Molecule 53 is a protein called 50S ribosomal protein L27.

Mol	Chain	Residues	Atoms					AltConf	Trace
53	u	88	Total	C	N	O	S	0	0
			670	416	132	121	1		

- Molecule 54 is a protein called 50S ribosomal protein L28.

Mol	Chain	Residues	Atoms					AltConf	Trace
54	v	64	Total	C	N	O	S	0	0
			520	320	109	90	1		

- Molecule 55 is a protein called 50S ribosomal protein L29.

Mol	Chain	Residues	Atoms				AltConf	Trace
55	w	110	Total	C	N	O	0	0
			906	576	168	162		

- Molecule 56 is a protein called 50S ribosomal protein L31.

Mol	Chain	Residues	Atoms					AltConf	Trace
56	x	96	Total	C	N	O	S	0	0
			761	481	133	143	4		

- Molecule 57 is a protein called 50S ribosomal protein L32.

Mol	Chain	Residues	Atoms					AltConf	Trace
57	y	56	Total	C	N	O	S	0	0
			452	274	98	75	5		

- Molecule 58 is a protein called 50S ribosomal protein L33 1.

Mol	Chain	Residues	Atoms					AltConf	Trace
58	z	50	Total	C	N	O	S	0	0
			408	255	81	68	4		

- Molecule 59 is ZINC ION (three-letter code: ZN) (formula: Zn).

Mol	Chain	Residues	Atoms		AltConf
59	2	1	Total	Zn	0
			1	1	
59	M	1	Total	Zn	0
			1	1	
59	Q	1	Total	Zn	0
			1	1	
59	x	1	Total	Zn	0
			1	1	
59	y	1	Total	Zn	0
			1	1	
59	z	1	Total	Zn	0
			1	1	

- Molecule 60 is CHLORAMPHENICOL (three-letter code: CLM) (formula: C₁₁H₁₂Cl₂N₂O₅) (labeled as "Ligand of Interest" by depositor).

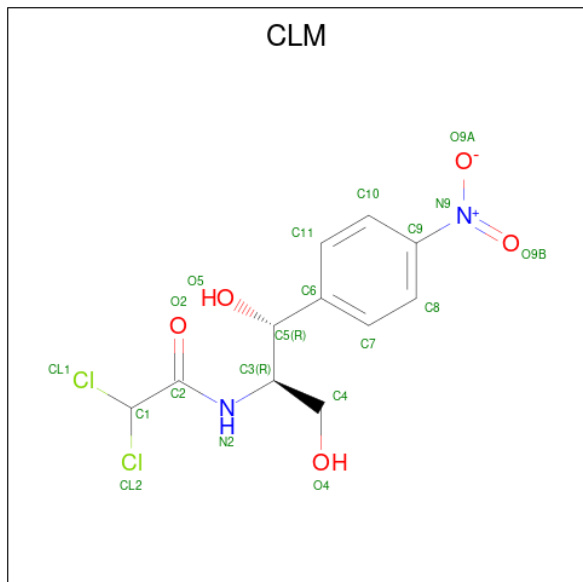

Mol	Chain	Residues	Atoms				AltConf	
			Total	C	Cl	N		O
60	3	1	20	11	2	2	5	0

- Molecule 61 is POTASSIUM ION (three-letter code: K) (formula: K).

Mol	Chain	Residues	Atoms		AltConf
			Total	K	
61	3	1	1	1	0

- Molecule 62 is MAGNESIUM ION (three-letter code: MG) (formula: Mg).

Mol	Chain	Residues	Atoms		AltConf
			Total	Mg	
62	3	218	218	218	0
62	4	1	1	1	0
62	5	89	89	89	0
62	6	1	1	1	0
62	7	2	2	2	0
62	8	2	2	2	0

Continued on next page...

Continued from previous page...

Mol	Chain	Residues	Atoms		AltConf
62	K	1	Total	Mg	0
			1	1	
62	P	1	Total	Mg	0
			1	1	
62	S	1	Total	Mg	0
			1	1	
62	Y	2	Total	Mg	0
			2	2	
62	a	1	Total	Mg	0
			1	1	
62	b	2	Total	Mg	0
			2	2	
62	i	1	Total	Mg	0
			1	1	
62	y	2	Total	Mg	0
			2	2	

- Molecule 63 is 1,4-DIAMINOBTUTANE (three-letter code: PUT) (formula: C₄H₁₂N₂).

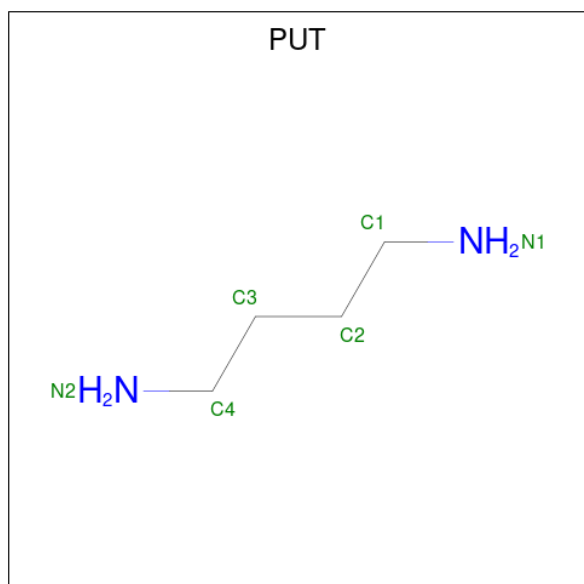

Mol	Chain	Residues	Atoms			AltConf
63	3	1	Total	C	N	0
			6	4	2	
63	3	1	Total	C	N	0
			6	4	2	
63	3	1	Total	C	N	0
			6	4	2	

Continued on next page...

Continued from previous page...

Mol	Chain	Residues	Atoms			AltConf
			Total	C	N	
63	3	1	6	4	2	0
63	3	1	6	4	2	0
63	3	1	6	4	2	0
63	3	1	6	4	2	0
63	5	1	6	4	2	0

- Molecule 64 is SPERMINE (three-letter code: SPM) (formula: $C_{10}H_{26}N_4$).

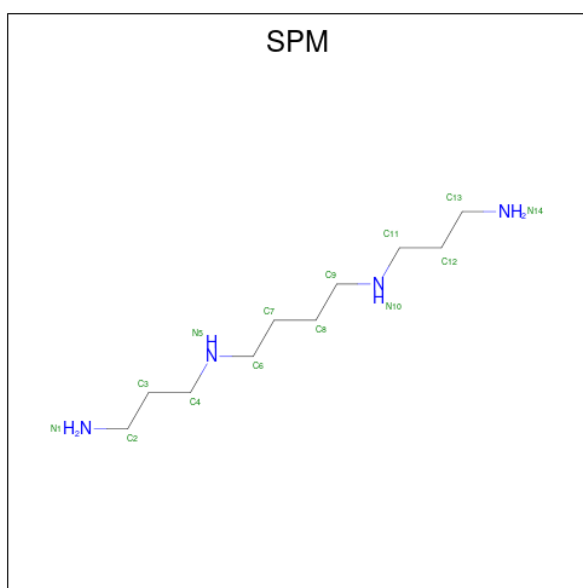

Mol	Chain	Residues	Atoms			AltConf
			Total	C	N	
64	3	1	14	10	4	0
64	3	1	14	10	4	0
64	3	1	14	10	4	0
64	b	1	14	10	4	0

- Molecule 65 is SPERMIDINE (three-letter code: SPD) (formula: $C_7H_{19}N_3$).

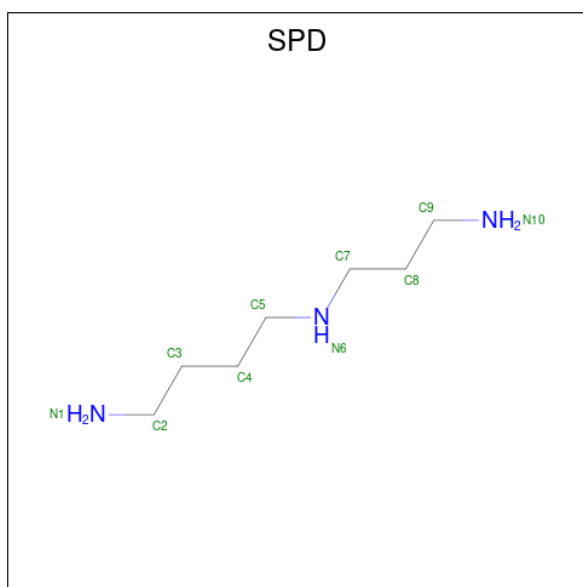

Mol	Chain	Residues	Atoms			AltConf
			Total	C	N	
65	3	1	10	7	3	0
65	3	1	10	7	3	0
65	3	1	10	7	3	0
65	3	1	10	7	3	0
65	3	1	10	7	3	0
65	3	1	10	7	3	0
65	3	1	10	7	3	0
65	3	1	10	7	3	0
65	3	1	10	7	3	0
65	3	1	10	7	3	0
65	3	1	10	7	3	0
65	3	1	10	7	3	0
65	3	1	10	7	3	0
65	3	1	10	7	3	0
65	3	1	10	7	3	0

Continued on next page...

Continued from previous page...

Mol	Chain	Residues	Atoms			AltConf
			Total	C	N	
65	3	1	10	7	3	0
65	3	1	10	7	3	0
65	5	1	10	7	3	0
65	5	1	10	7	3	0

- Molecule 66 is PENTANE-1,5-DIAMINE (three-letter code: N2P) (formula: $C_5H_{14}N_2$).

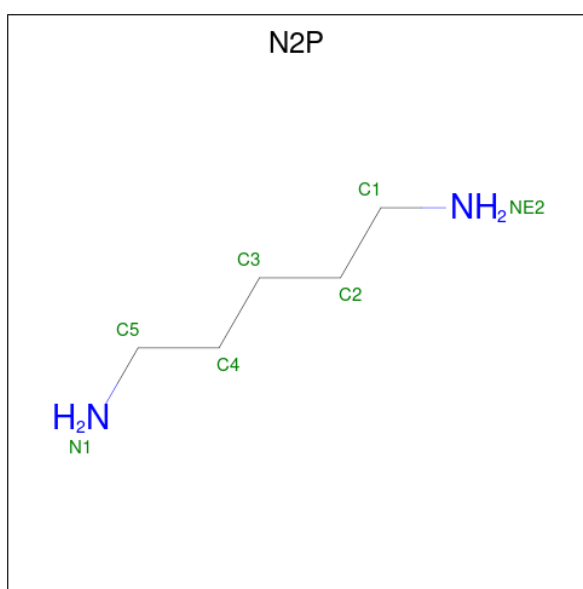

Mol	Chain	Residues	Atoms			AltConf
			Total	C	N	
66	3	1	7	5	2	0
66	3	1	7	5	2	0
66	3	1	7	5	2	0
66	5	1	7	5	2	0

- Molecule 67 is LYSINE (three-letter code: LYS) (formula: $C_6H_{15}N_2O_2$).

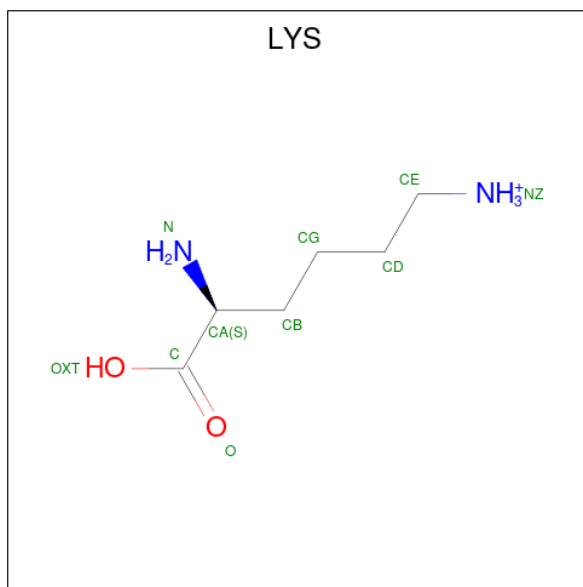

Mol	Chain	Residues	Atoms				AltConf
			Total	C	N	O	
67	8	1	9	6	2	1	0

3 Residue-property plots [i](#)

These plots are drawn for all protein, RNA, DNA and oligosaccharide chains in the entry. The first graphic for a chain summarises the proportions of the various outlier classes displayed in the second graphic. The second graphic shows the sequence view annotated by issues in geometry and atom inclusion in map density. Residues are color-coded according to the number of geometric quality criteria for which they contain at least one outlier: green = 0, yellow = 1, orange = 2 and red = 3 or more. A red diamond above a residue indicates a poor fit to the EM map for this residue (all-atom inclusion < 40%). Stretches of 2 or more consecutive residues without any outlier are shown as a green connector. Residues present in the sample, but not in the model, are shown in grey.

- Molecule 1: 50S ribosomal protein L34

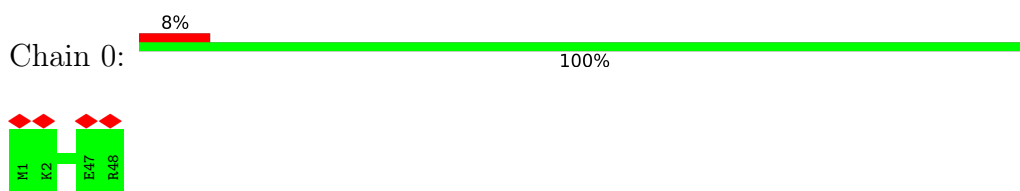

- Molecule 2: 50S ribosomal protein L35

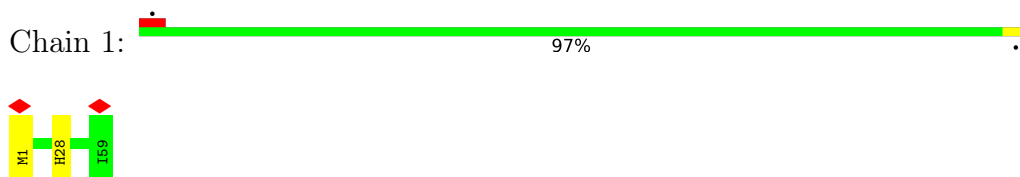

- Molecule 3: 50S ribosomal protein L36

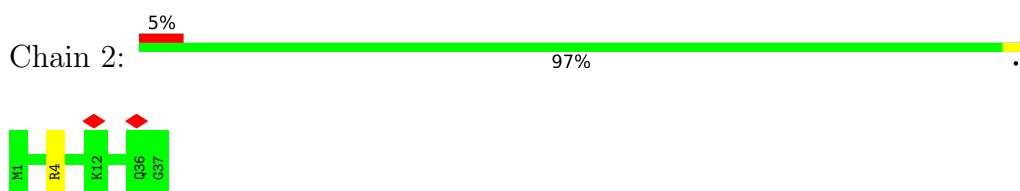

- Molecule 4: 23S ribosomal RNA

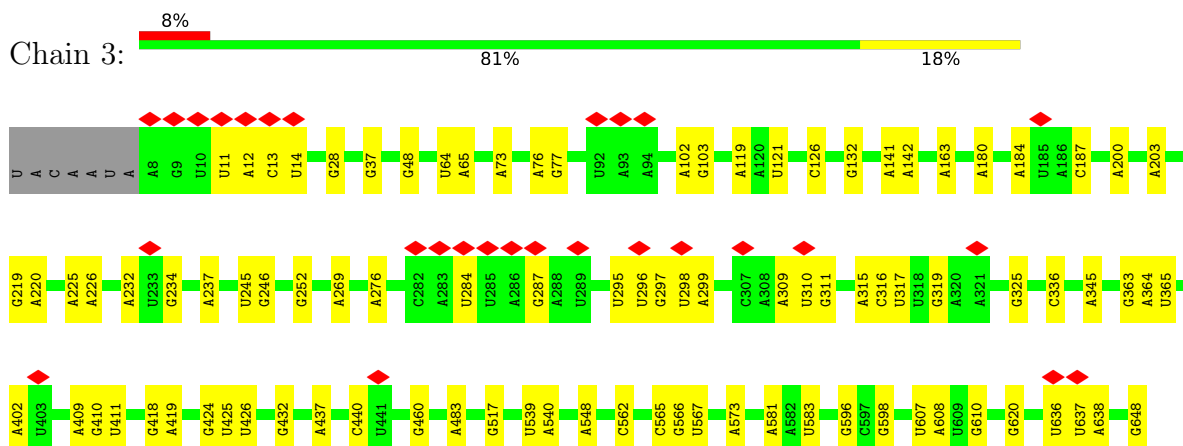

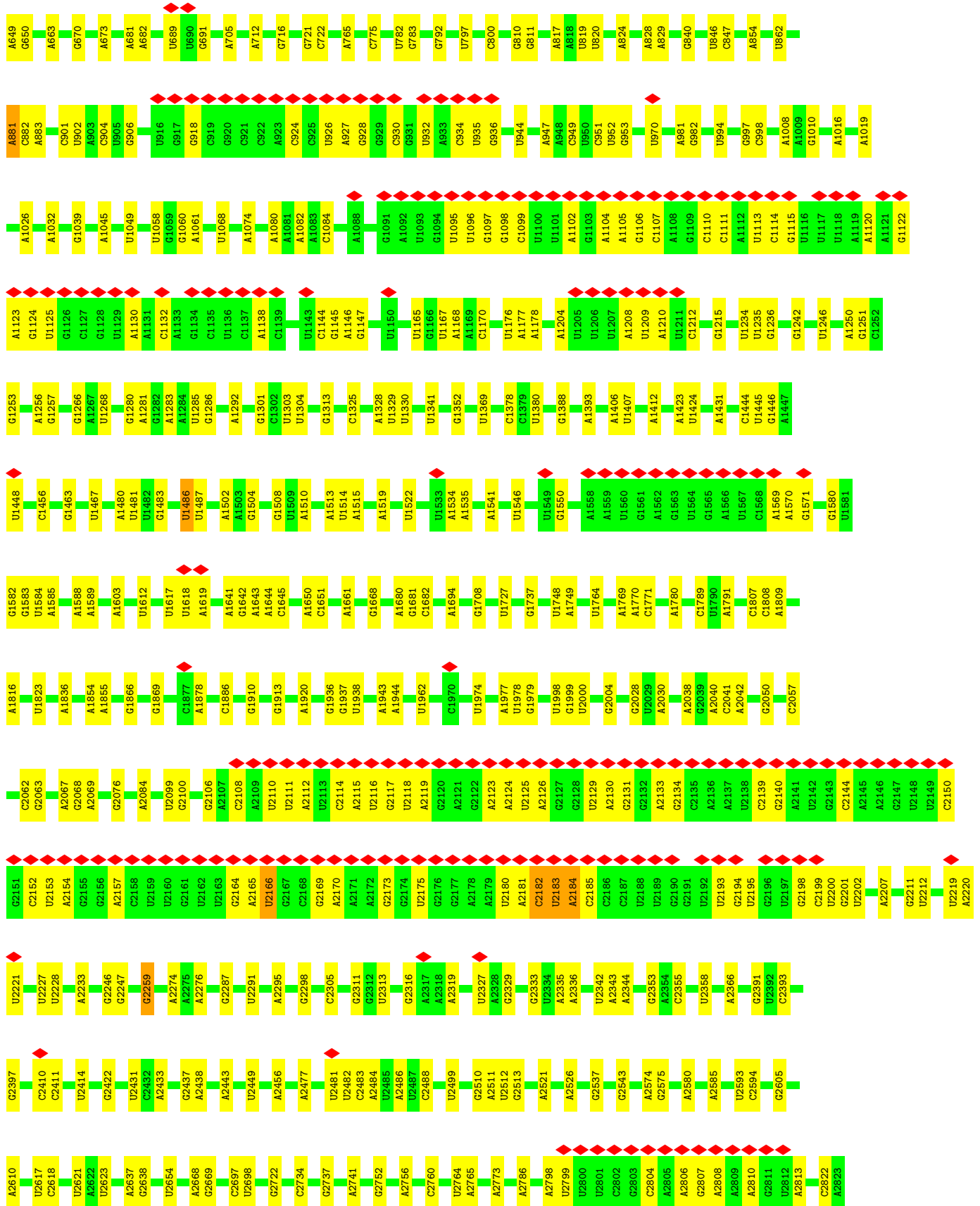



• Molecule 5: 5S ribosomal RNA

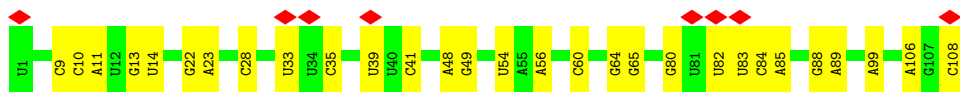
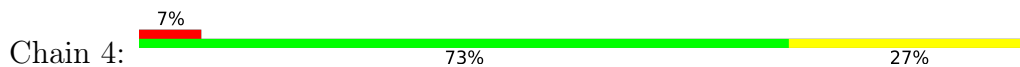

• Molecule 6: 16S ribosomal RNA

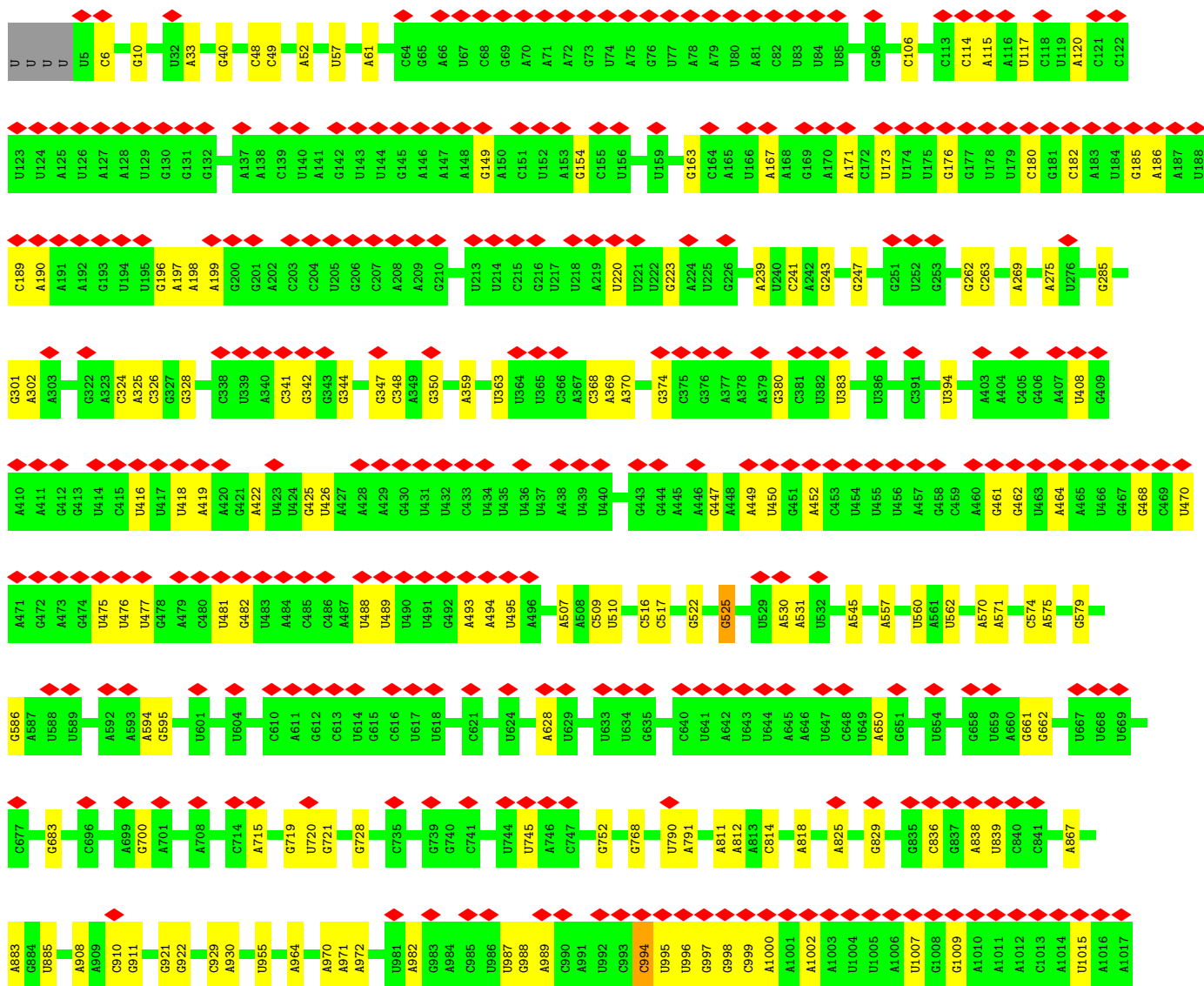
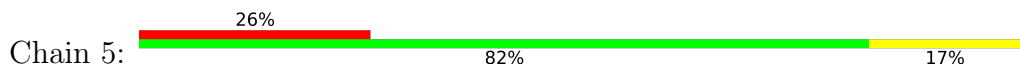

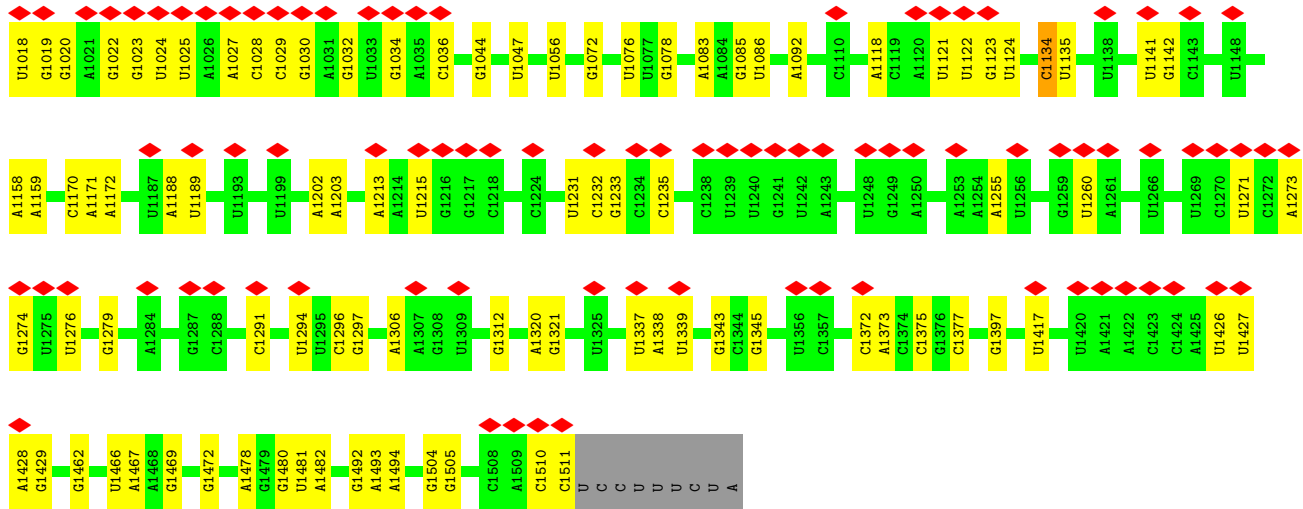

• Molecule 7: tRNA-Ala (E-site)

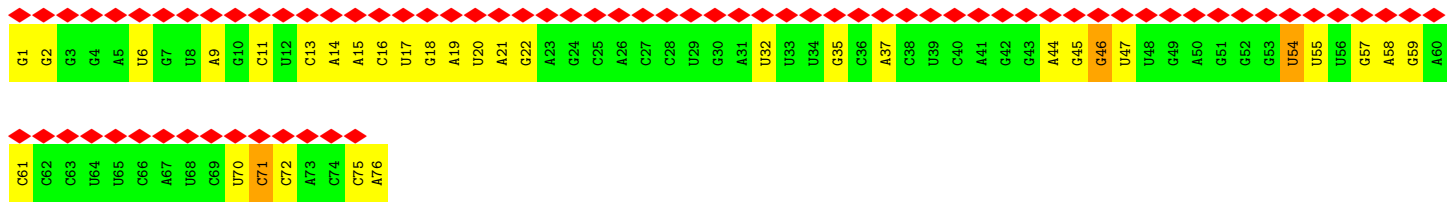

• Molecule 8: tRNA-Asp (P-site)

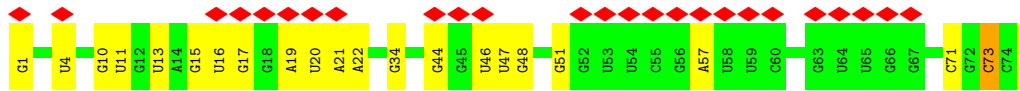

• Molecule 9: tRNA-Lys (A-site)

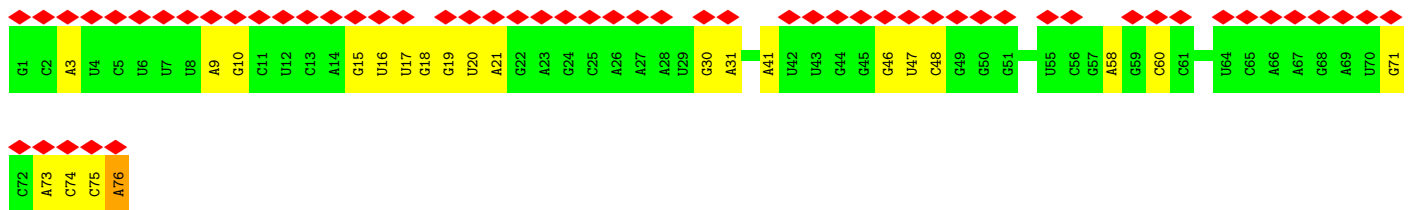
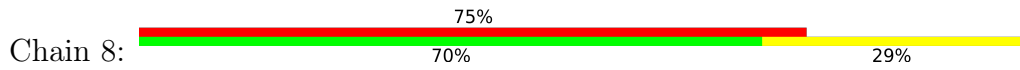

• Molecule 10: 30S ribosomal protein S2

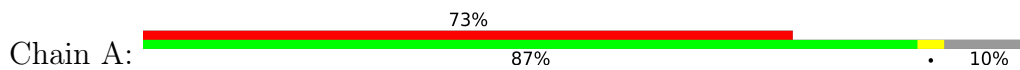

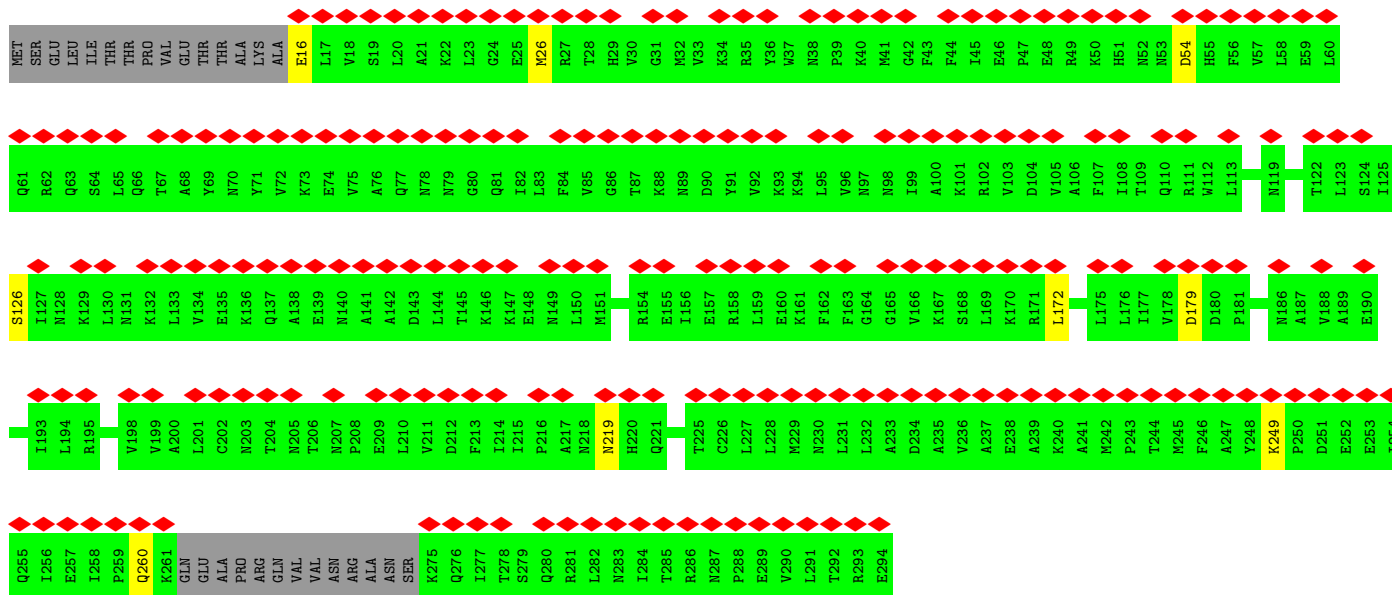

• Molecule 11: 30S ribosomal protein S3

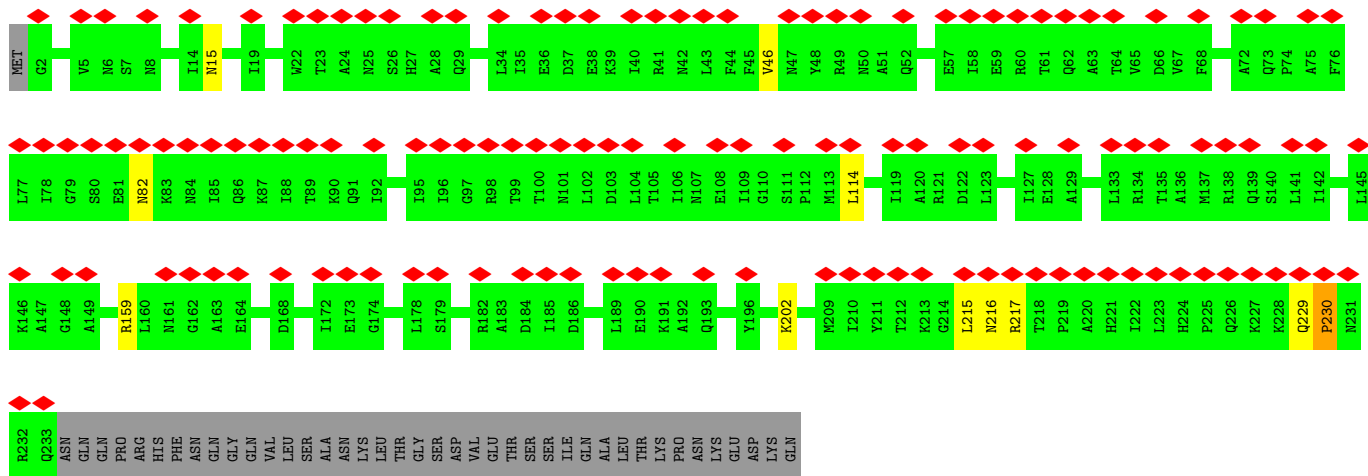
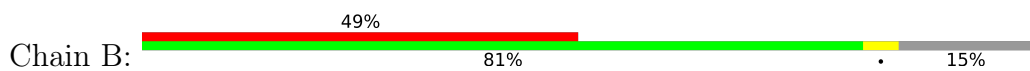

• Molecule 12: 30S ribosomal protein S4

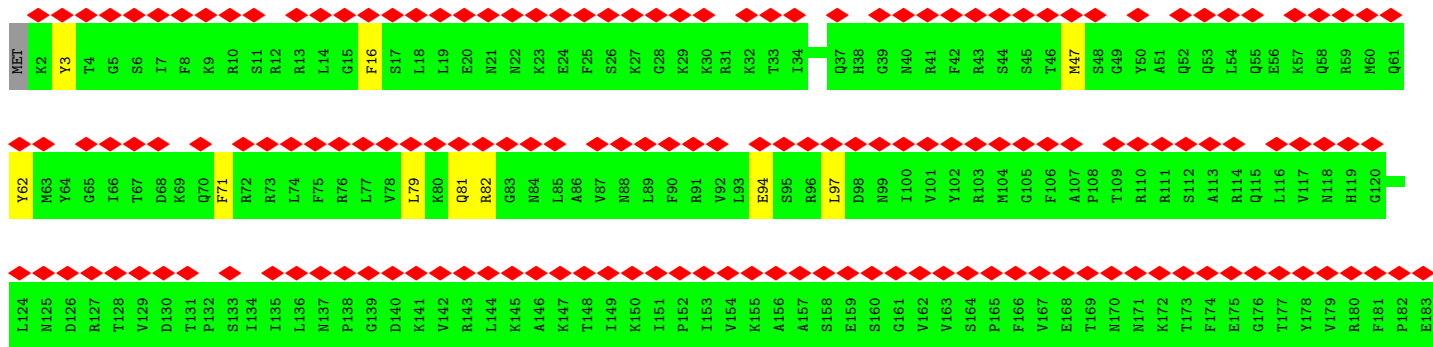
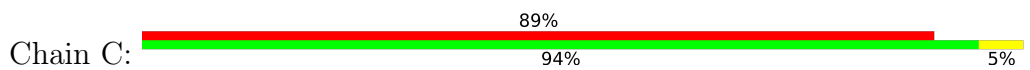



• Molecule 13: 30S ribosomal protein S5

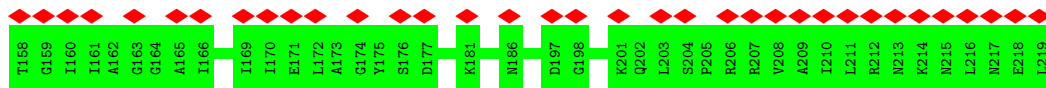
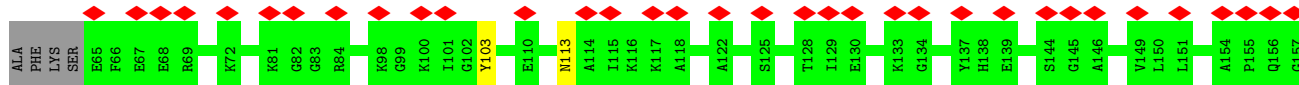
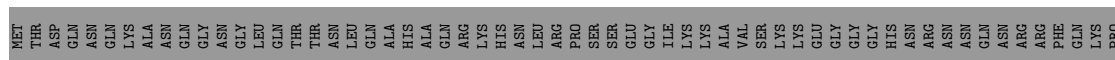

• Molecule 14: 30S ribosomal protein S6

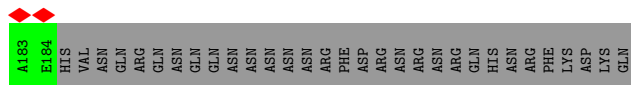
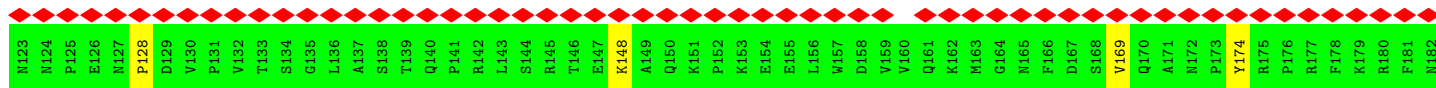
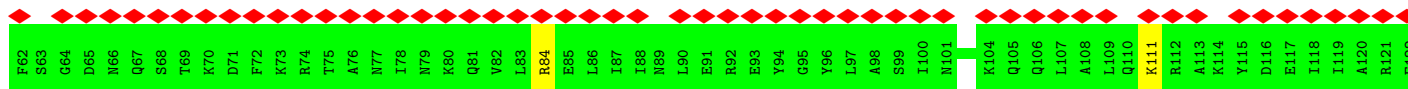
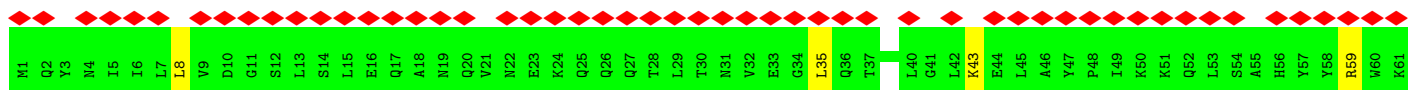
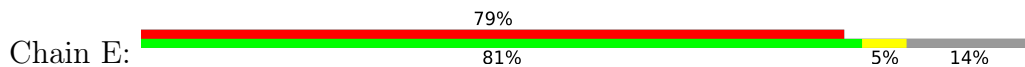

• Molecule 15: 30S ribosomal protein S7

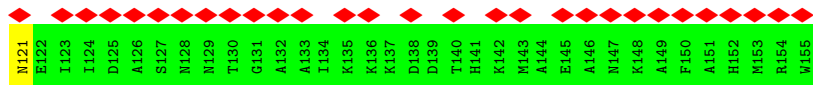
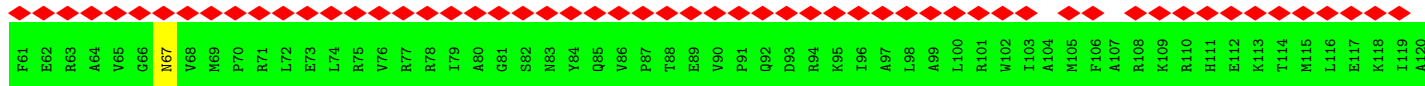
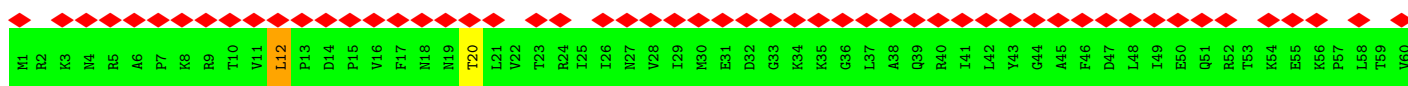

• Molecule 16: 30S ribosomal protein S8

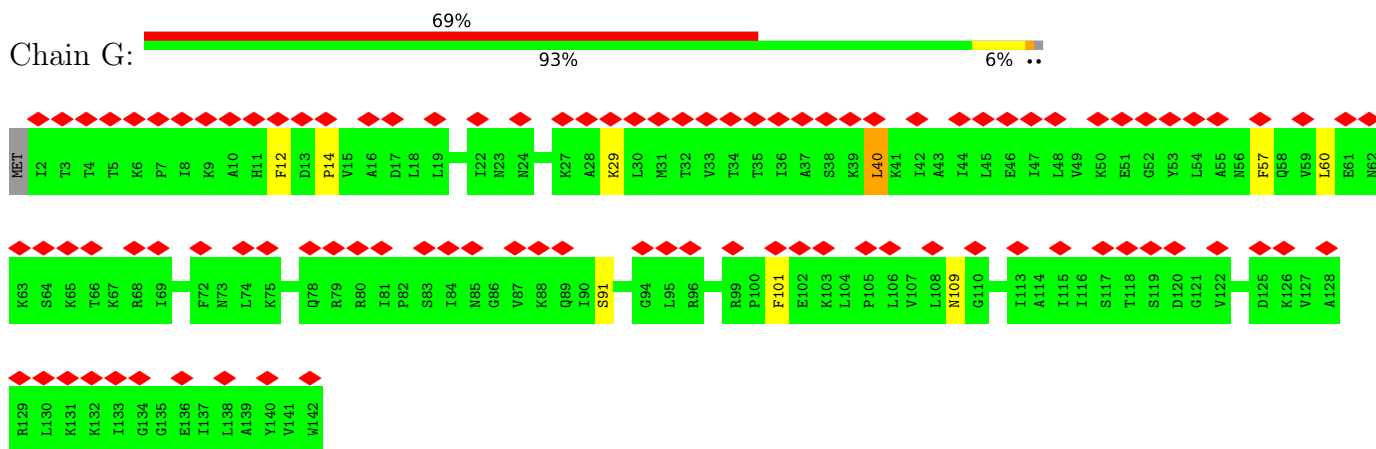

• Molecule 17: 30S ribosomal protein S9

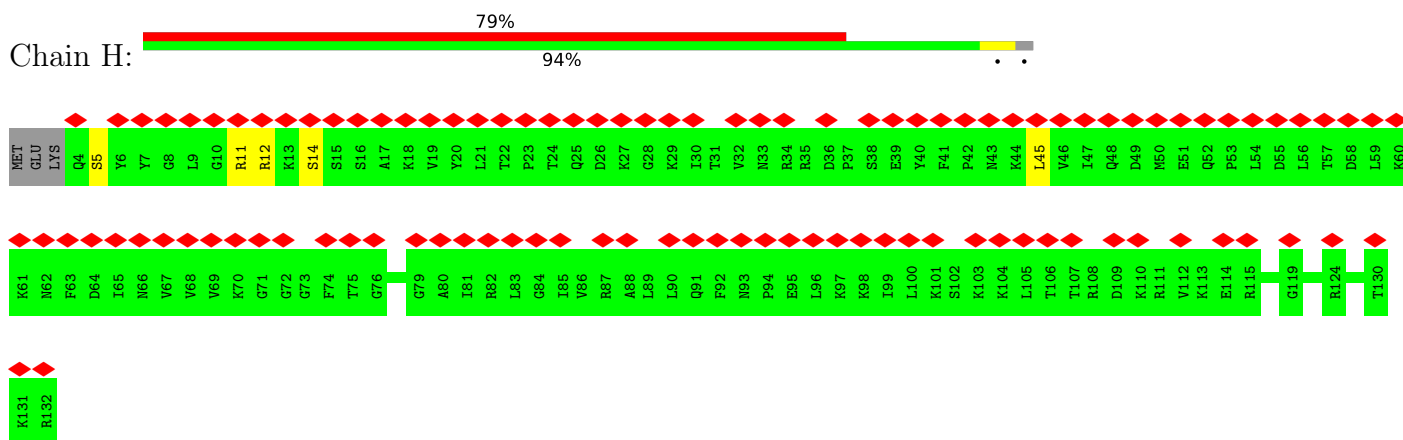

• Molecule 18: 30S ribosomal protein S10

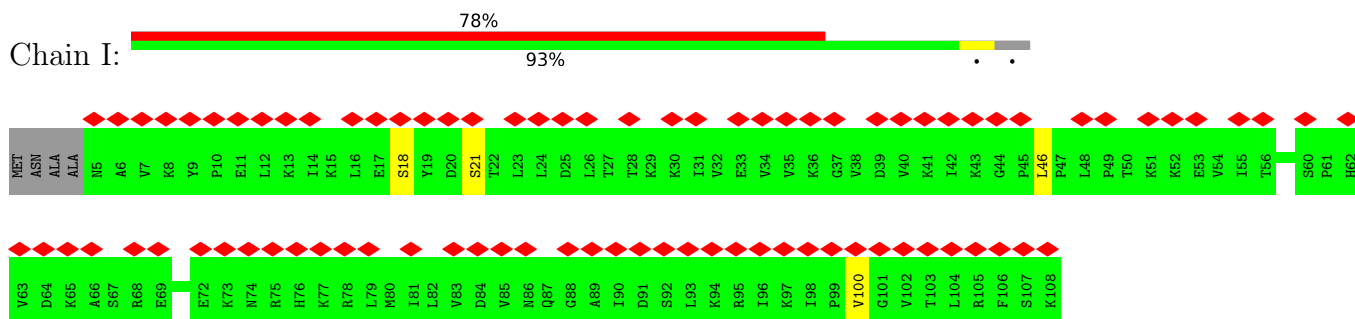

• Molecule 19: 30S ribosomal protein S11

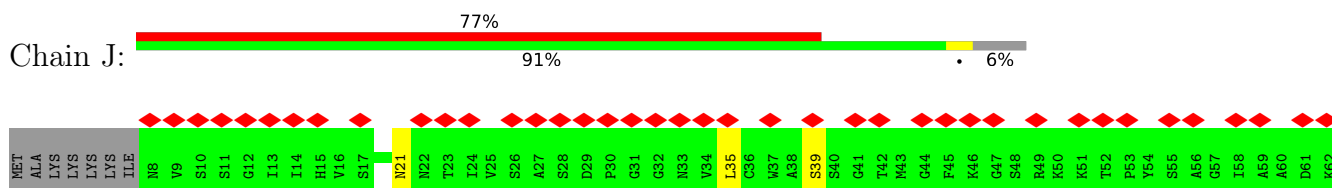



- Molecule 20: 30S ribosomal protein S12

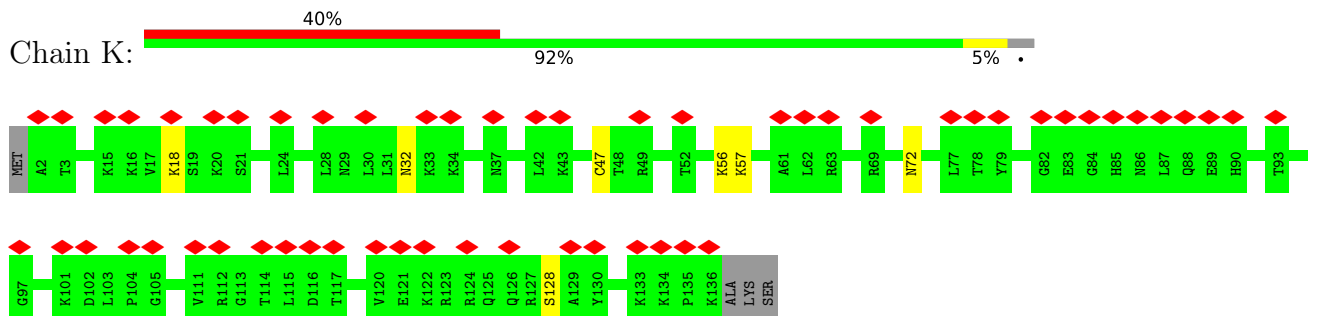

- Molecule 21: 30S ribosomal protein S13

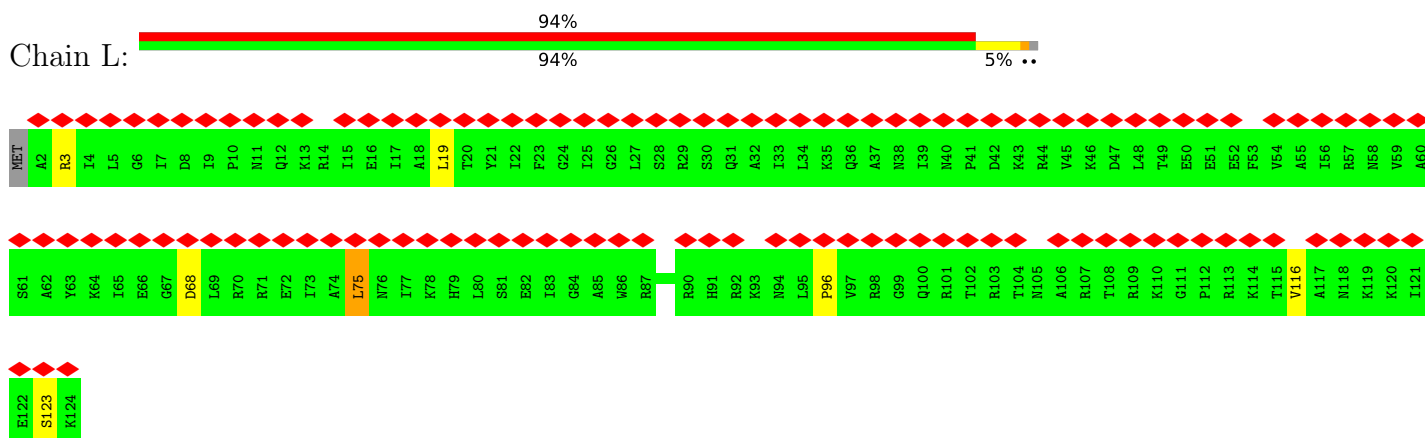

- Molecule 22: 30S ribosomal protein S14 type Z

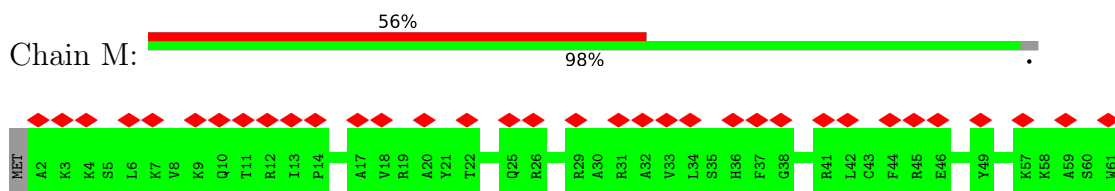

- Molecule 23: 30S ribosomal protein S15

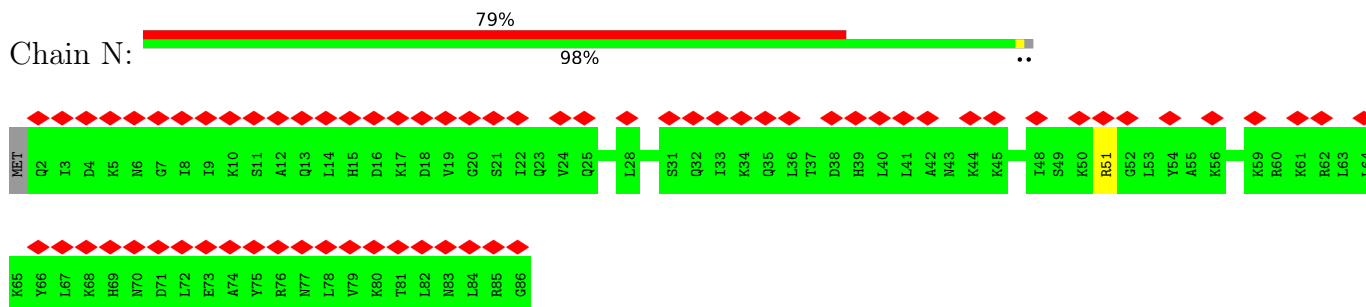

- Molecule 24: 30S ribosomal protein S16

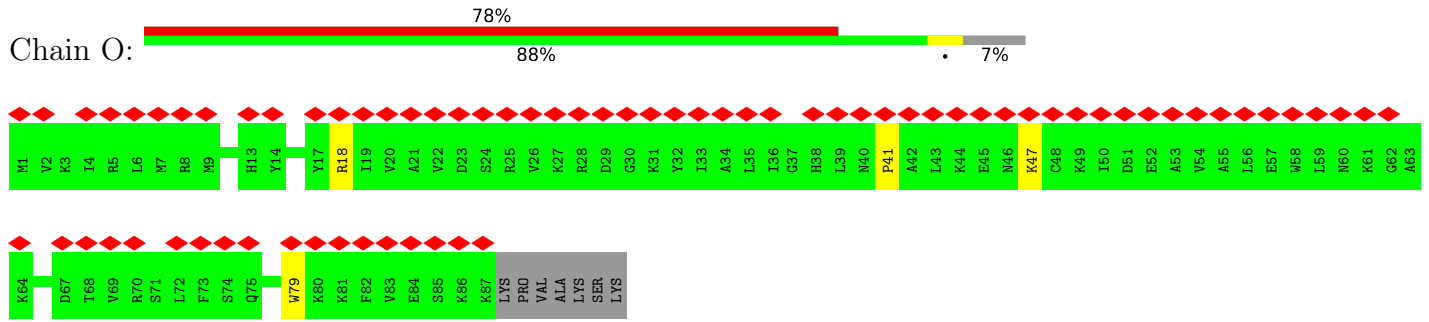

• Molecule 25: 30S ribosomal protein S17

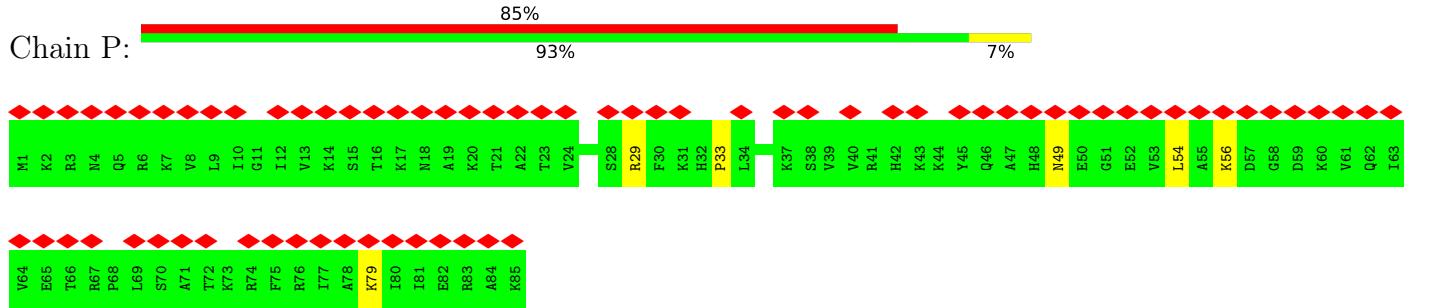

• Molecule 26: 30S ribosomal protein S18

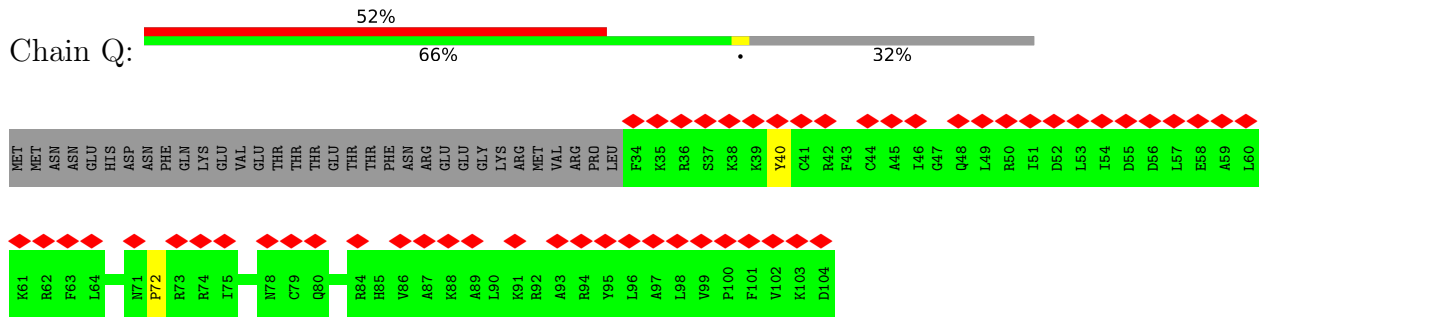

• Molecule 27: 30S ribosomal protein S19

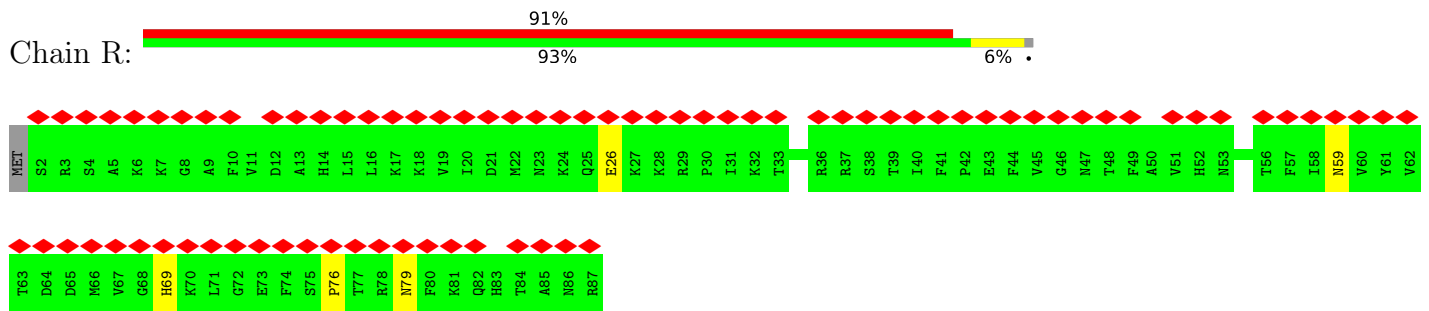

• Molecule 28: 30S ribosomal protein S20

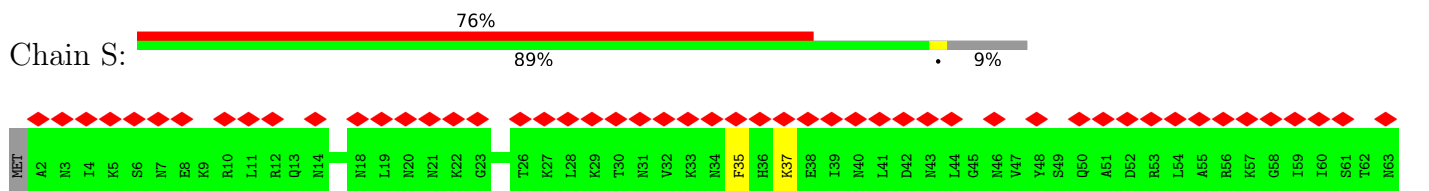

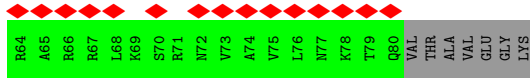

- Molecule 29: 30S ribosomal protein S21

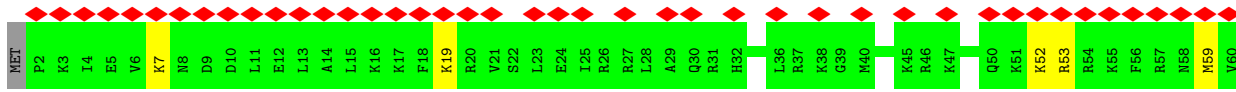
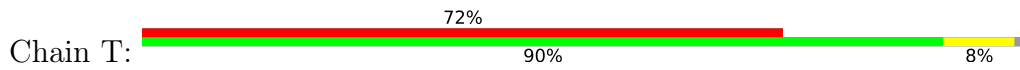

- Molecule 30: Trigger factor

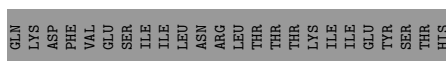
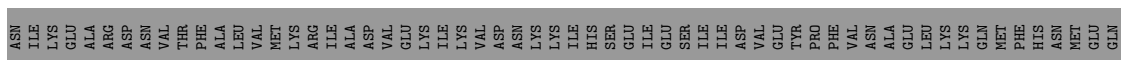
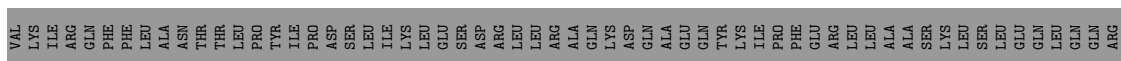
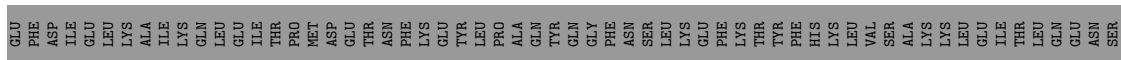
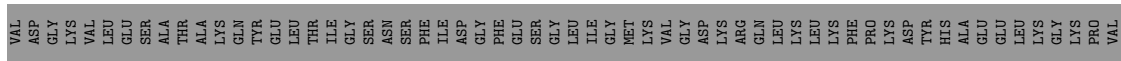
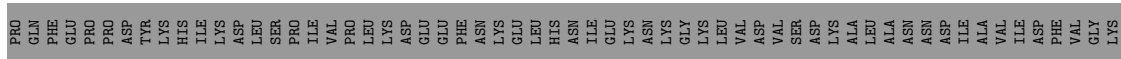
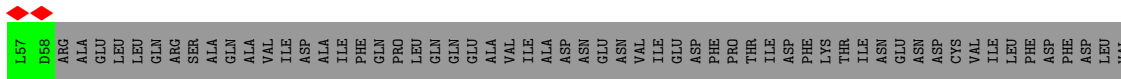
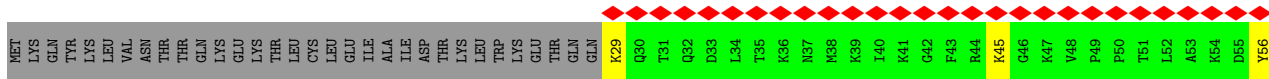

- Molecule 31: mRNA

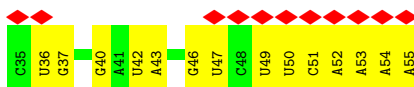

- Molecule 32: Nascent chain

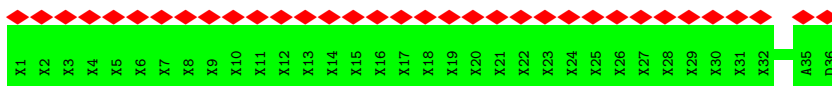

• Molecule 33: 50S ribosomal protein L2

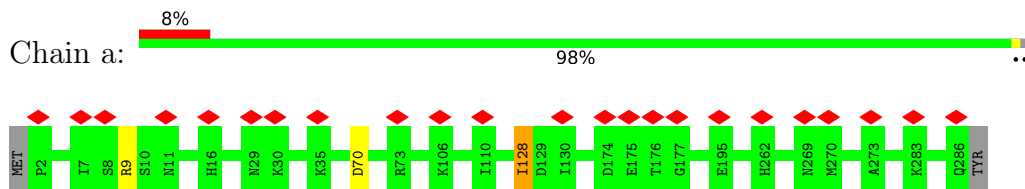

• Molecule 34: 50S ribosomal protein L3

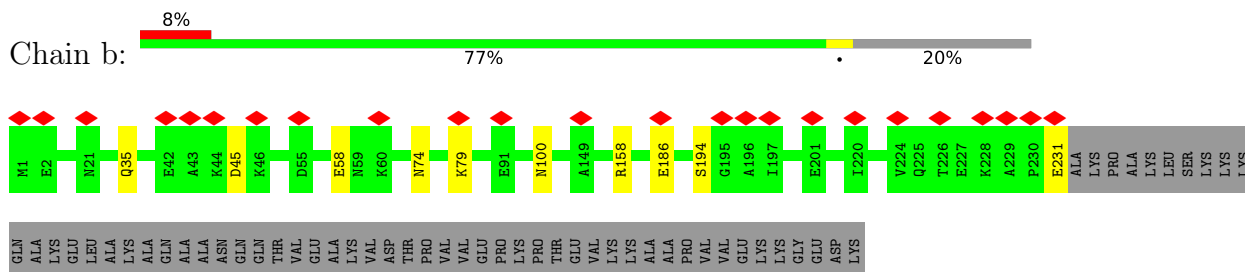

• Molecule 35: 50S ribosomal protein L4

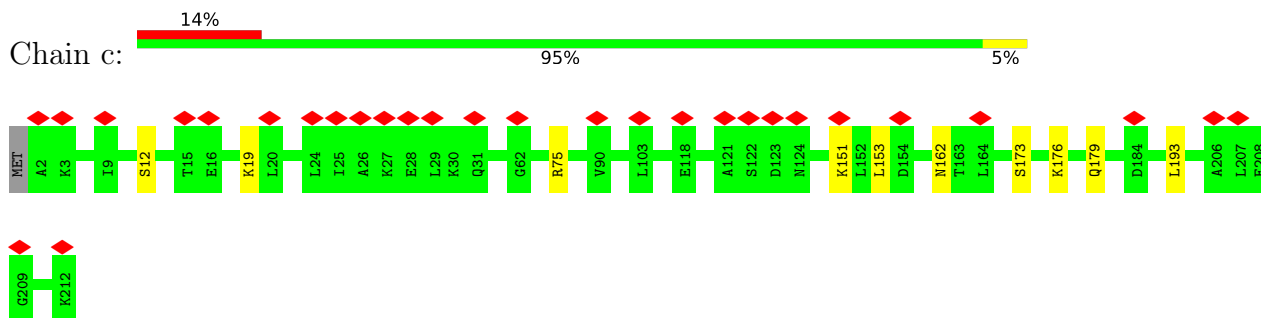

• Molecule 36: 50S ribosomal protein L5

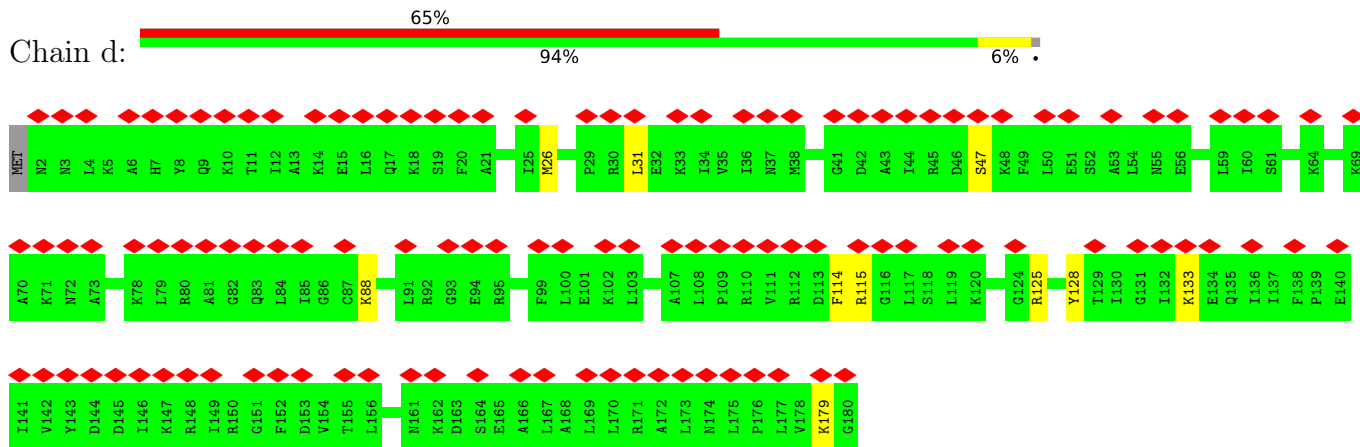

• Molecule 37: 50S ribosomal protein L6

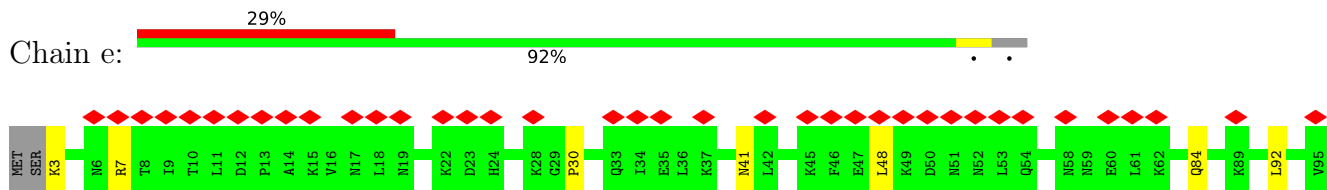

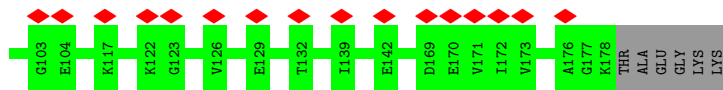

- Molecule 38: 50S ribosomal protein L9

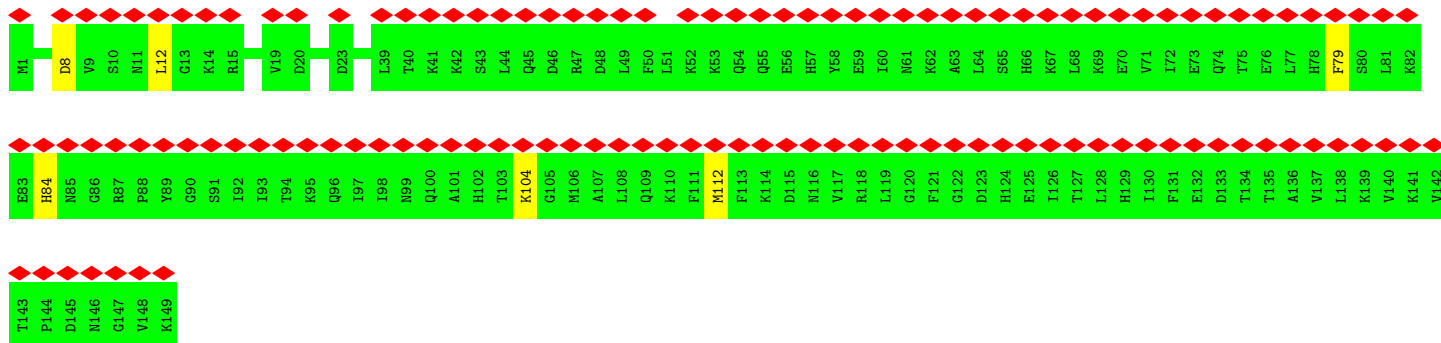
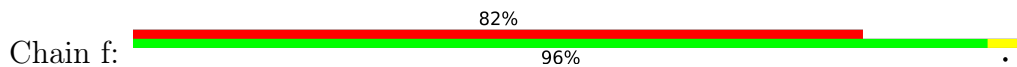

- Molecule 39: 50S ribosomal protein L10

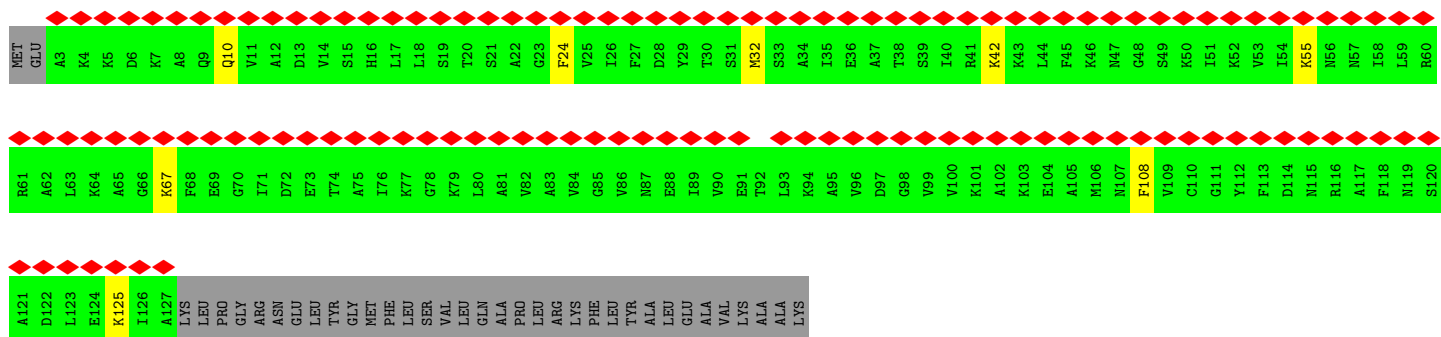
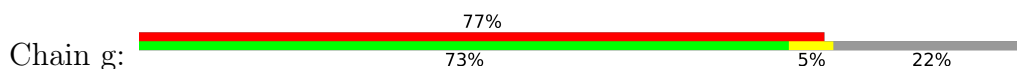

- Molecule 40: 50S ribosomal protein L11

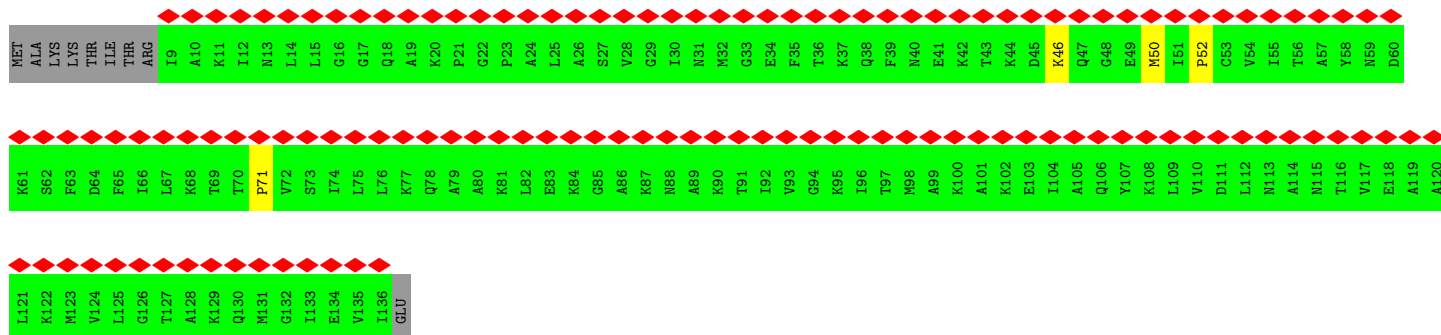
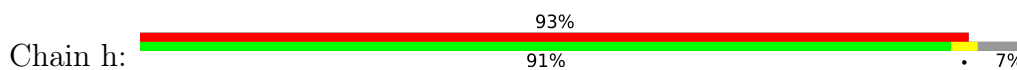

- Molecule 41: 50S ribosomal protein L13

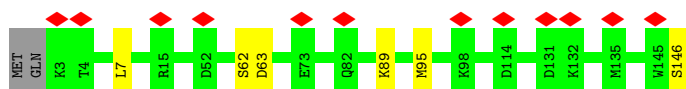
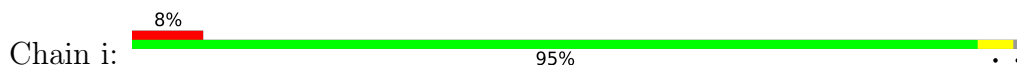

- Molecule 42: 50S ribosomal protein L14

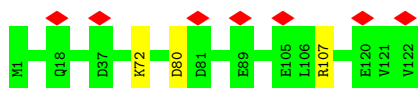

- Molecule 43: 50S ribosomal protein L15



- Molecule 44: 50S ribosomal protein L16



- Molecule 45: 50S ribosomal protein L17



- Molecule 46: 50S ribosomal protein L18

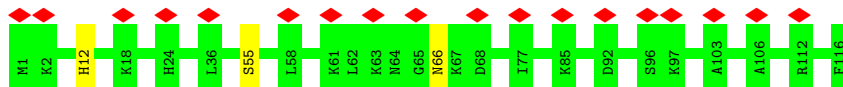

- Molecule 47: 50S ribosomal protein L19

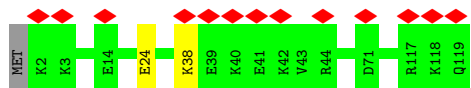

• Molecule 48: 50S ribosomal protein L20

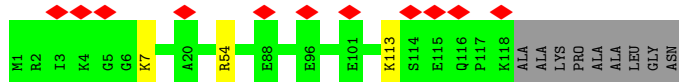
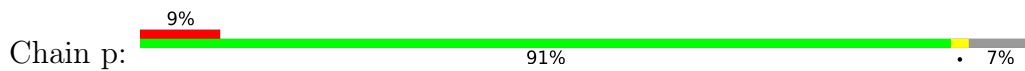

• Molecule 49: 50S ribosomal protein L21

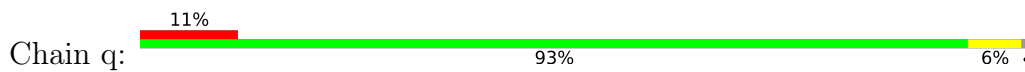

• Molecule 50: 50S ribosomal protein L22

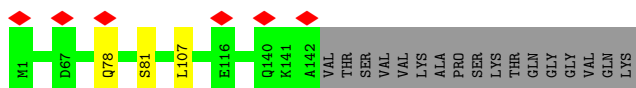
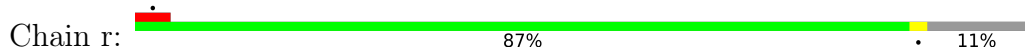

• Molecule 51: 50S ribosomal protein L23

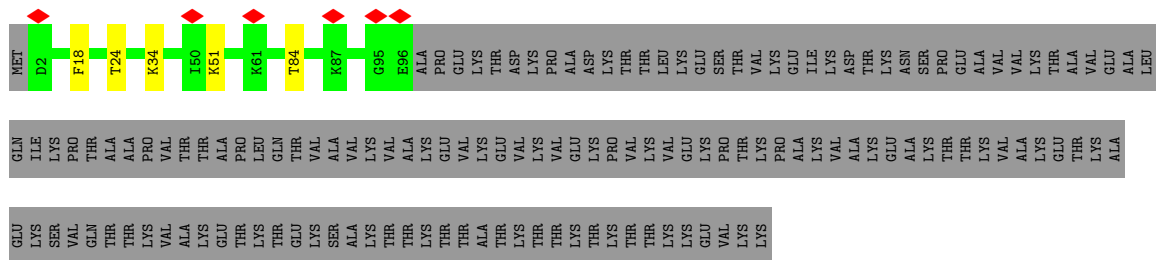

• Molecule 52: 50S ribosomal protein L24

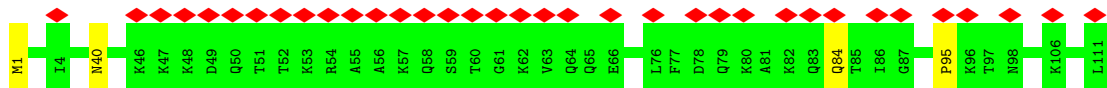
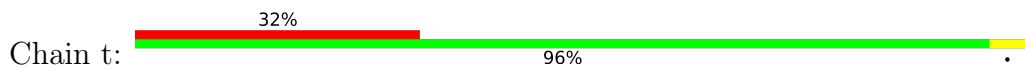

• Molecule 53: 50S ribosomal protein L27

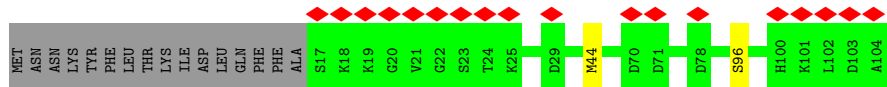
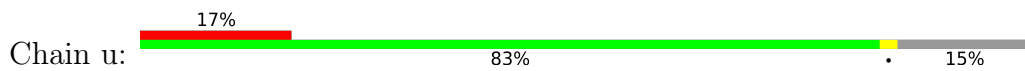

- Molecule 54: 50S ribosomal protein L28

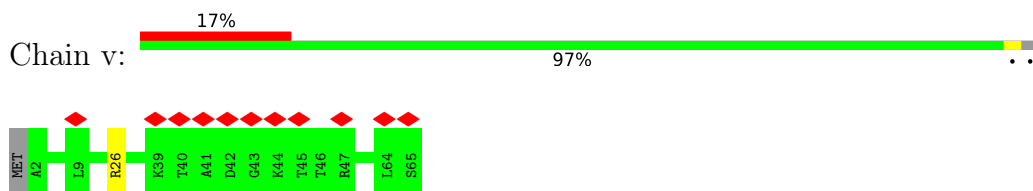

- Molecule 55: 50S ribosomal protein L29

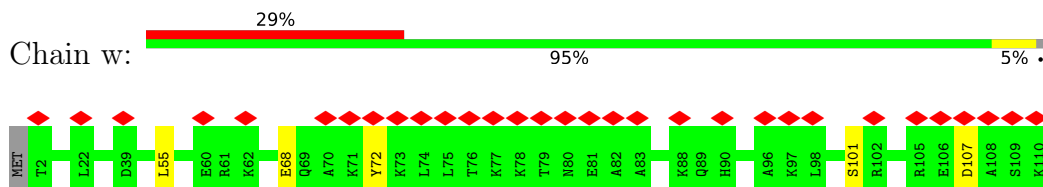

- Molecule 56: 50S ribosomal protein L31

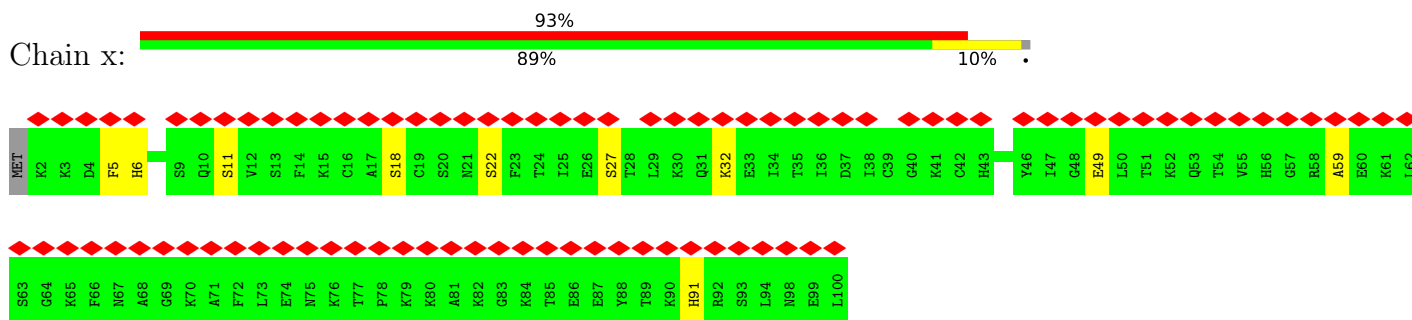

- Molecule 57: 50S ribosomal protein L32

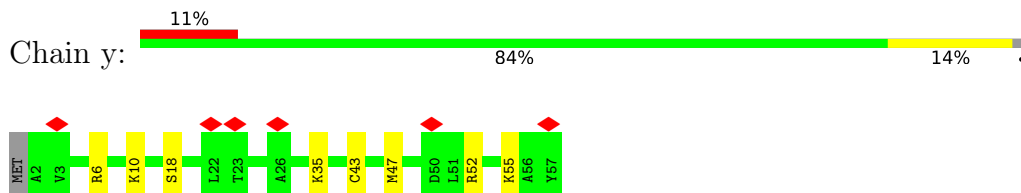

- Molecule 58: 50S ribosomal protein L33 1

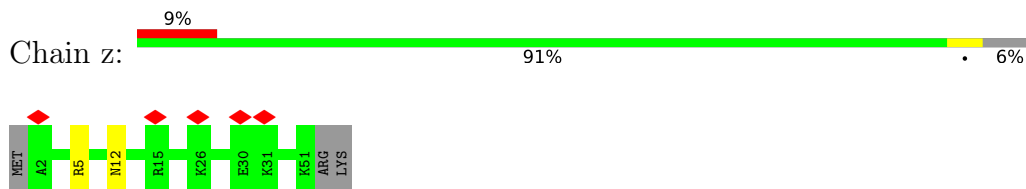

4 Experimental information

Property	Value	Source
EM reconstruction method	SUBTOMOGRAM AVERAGING	Depositor
Imposed symmetry	POINT, C1	Depositor
Number of subtomograms used	30774	Depositor
Resolution determination method	FSC 0.143 CUT-OFF	Depositor
CTF correction method	PHASE FLIPPING AND AMPLITUDE CORRECTION; CTF estimation and 3D CTF correction are done in Warp	Depositor
Microscope	FEI TITAN KRIOS	Depositor
Voltage (kV)	300	Depositor
Electron dose ($e^-/\text{\AA}^2$)	137	Depositor
Minimum defocus (nm)	1000	Depositor
Maximum defocus (nm)	3250	Depositor
Magnification	64000	Depositor
Image detector	GATAN K3 BIOQUANTUM (6k x 4k)	Depositor
Maximum map value	0.022	Depositor
Minimum map value	-0.012	Depositor
Average map value	0.000	Depositor
Map value standard deviation	0.000	Depositor
Recommended contour level	0.0022	Depositor
Map size (\AA)	560.838, 560.838, 560.838	wwPDB
Map dimensions	422, 422, 422	wwPDB
Map angles ($^\circ$)	90.0, 90.0, 90.0	wwPDB
Pixel spacing (\AA)	1.329, 1.329, 1.329	Depositor

5 Model quality i

5.1 Standard geometry i

Bond lengths and bond angles in the following residue types are not validated in this section: PUT, B8T, 2MA, MA6, CLM, K, 1MG, ZN, OMG, SPD, N2P, MG, SPM, 5MC, 7MG

The Z score for a bond length (or angle) is the number of standard deviations the observed value is removed from the expected value. A bond length (or angle) with $|Z| > 5$ is considered an outlier worth inspection. RMSZ is the root-mean-square of all Z scores of the bond lengths (or angles).

Mol	Chain	Bond lengths		Bond angles	
		RMSZ	# Z >5	RMSZ	# Z >5
1	0	0.23	0/395	0.57	0/518
2	1	0.24	0/484	0.51	0/637
3	2	0.31	0/306	0.59	0/401
4	3	0.19	1/69363 (0.0%)	0.72	26/108161 (0.0%)
5	4	0.16	0/2578	0.72	0/4016
6	5	0.16	0/35992	0.70	2/56111 (0.0%)
7	6	0.40	1/1810 (0.1%)	0.91	5/2817 (0.2%)
8	7	0.30	1/1785 (0.1%)	0.82	1/2779 (0.0%)
9	8	0.49	3/1804 (0.2%)	1.03	8/2807 (0.3%)
10	A	0.26	0/2172	0.52	0/2934
11	B	0.28	0/1863	0.68	2/2516 (0.1%)
12	C	0.36	1/1700 (0.1%)	0.75	3/2278 (0.1%)
13	D	0.26	0/1206	0.58	0/1616
14	E	0.28	0/1536	0.64	3/2072 (0.1%)
15	F	0.29	0/1274	0.69	1/1710 (0.1%)
16	G	0.53	1/1126 (0.1%)	0.98	6/1517 (0.4%)
17	H	0.30	0/1056	0.77	2/1409 (0.1%)
18	I	0.25	0/843	0.62	1/1132 (0.1%)
19	J	0.27	0/844	0.58	1/1136 (0.1%)
20	K	0.28	0/1089	0.64	0/1461
21	L	0.35	1/1002 (0.1%)	0.82	4/1340 (0.3%)
22	M	0.27	0/483	0.63	0/643
23	N	0.27	0/695	0.63	0/926
24	O	0.29	0/718	0.71	1/962 (0.1%)
25	P	0.28	0/702	0.67	1/934 (0.1%)
26	Q	0.40	0/601	0.69	1/801 (0.1%)
27	R	0.29	0/716	0.66	1/958 (0.1%)
28	S	0.29	0/645	0.65	0/857
29	T	0.27	0/524	0.75	1/685 (0.1%)
30	X	0.27	0/245	0.58	0/325
31	Y	0.29	0/498	0.89	0/773
32	Z	0.75	0/26	1.33	0/33

Mol	Chain	Bond lengths		Bond angles	
		RMSZ	# Z >5	RMSZ	# Z >5
33	a	0.26	0/2267	0.56	1/3044 (0.0%)
34	b	0.28	0/1812	0.55	1/2436 (0.0%)
35	c	0.26	0/1681	0.52	1/2257 (0.0%)
36	d	0.28	0/1437	0.62	0/1931
37	e	0.26	0/1420	0.59	2/1912 (0.1%)
38	f	0.26	0/1231	0.60	0/1650
39	g	0.27	0/960	0.57	0/1284
40	h	0.40	1/968 (0.1%)	0.91	4/1298 (0.3%)
41	i	0.24	0/1186	0.49	0/1592
42	j	0.26	0/953	0.59	0/1275
43	k	0.27	0/1187	0.57	0/1581
44	l	0.27	0/1104	0.56	0/1481
45	m	0.25	0/973	0.51	0/1309
46	n	0.26	0/927	0.58	0/1239
47	o	0.27	0/976	0.58	0/1296
48	p	0.24	0/996	0.50	0/1325
49	q	0.25	0/828	0.54	0/1111
50	r	0.25	0/1100	0.48	0/1471
51	s	0.26	0/752	0.54	0/1015
52	t	0.26	0/878	0.64	3/1165 (0.3%)
53	u	0.25	0/678	0.51	0/902
54	v	0.23	0/526	0.57	0/703
55	w	0.24	0/916	0.53	0/1222
56	x	0.27	0/776	0.60	0/1033
57	y	0.24	0/457	0.60	0/601
58	z	0.23	0/412	0.53	0/547
All	All	0.23	10/163482 (0.0%)	0.70	82/243945 (0.0%)

Chiral center outliers are detected by calculating the chiral volume of a chiral center and verifying if the center is modelled as a planar moiety or with the opposite hand. A planarity outlier is detected by checking planarity of atoms in a peptide group, atoms in a mainchain group or atoms of a sidechain that are expected to be planar.

Mol	Chain	#Chirality outliers	#Planarity outliers
23	N	0	1

The worst 5 of 10 bond length outliers are listed below:

Mol	Chain	Res	Type	Atoms	Z	Observed(Å)	Ideal(Å)
9	8	76	A	C6-N6	15.15	1.46	1.33
16	G	14	PRO	CG-CD	-14.43	1.03	1.50
12	C	188	PRO	CG-CD	-7.76	1.25	1.50

Continued on next page...

Continued from previous page...

Mol	Chain	Res	Type	Atoms	Z	Observed(Å)	Ideal(Å)
8	7	1	G	OP3-P	-7.55	1.52	1.61
7	6	1	G	OP3-P	-7.38	1.52	1.61

The worst 5 of 82 bond angle outliers are listed below:

Mol	Chain	Res	Type	Atoms	Z	Observed(°)	Ideal(°)
9	8	76	A	C2-N3-C4	22.07	121.63	110.60
16	G	14	PRO	N-CD-CG	-21.16	71.46	103.20
40	h	52	PRO	CA-N-CD	-19.95	83.57	111.50
16	G	14	PRO	CA-CB-CG	-16.91	71.86	104.00
9	8	76	A	N1-C2-N3	-15.26	121.67	129.30

There are no chirality outliers.

All (1) planarity outliers are listed below:

Mol	Chain	Res	Type	Group
23	N	51	ARG	Sidechain

5.2 Too-close contacts [i](#)

Due to software issues we are unable to calculate clashes - this section is therefore empty.

5.3 Torsion angles [i](#)

5.3.1 Protein backbone [i](#)

In the following table, the Percentiles column shows the percent Ramachandran outliers of the chain as a percentile score with respect to all PDB entries followed by that with respect to all EM entries.

The Analysed column shows the number of residues for which the backbone conformation was analysed, and the total number of residues.

Mol	Chain	Analysed	Favoured	Allowed	Outliers	Percentiles	
1	0	46/48 (96%)	45 (98%)	1 (2%)	0	100	100
2	1	57/59 (97%)	57 (100%)	0	0	100	100
3	2	35/37 (95%)	35 (100%)	0	0	100	100
10	A	262/294 (89%)	237 (90%)	23 (9%)	2 (1%)	16	47
11	B	230/273 (84%)	203 (88%)	22 (10%)	5 (2%)	5	24

Continued on next page...

Continued from previous page...

Mol	Chain	Analysed	Favoured	Allowed	Outliers	Percentiles	
12	C	202/205 (98%)	171 (85%)	30 (15%)	1 (0%)	25	58
13	D	153/219 (70%)	143 (94%)	10 (6%)	0	100	100
14	E	182/215 (85%)	153 (84%)	27 (15%)	2 (1%)	12	40
15	F	153/155 (99%)	140 (92%)	11 (7%)	2 (1%)	10	36
16	G	139/142 (98%)	131 (94%)	8 (6%)	0	100	100
17	H	127/132 (96%)	112 (88%)	15 (12%)	0	100	100
18	I	102/108 (94%)	88 (86%)	13 (13%)	1 (1%)	13	42
19	J	112/121 (93%)	106 (95%)	5 (4%)	1 (1%)	14	45
20	K	133/139 (96%)	116 (87%)	14 (10%)	3 (2%)	5	23
21	L	121/124 (98%)	109 (90%)	10 (8%)	2 (2%)	7	30
22	M	58/61 (95%)	56 (97%)	2 (3%)	0	100	100
23	N	83/86 (96%)	78 (94%)	5 (6%)	0	100	100
24	O	85/94 (90%)	80 (94%)	4 (5%)	1 (1%)	11	38
25	P	83/85 (98%)	73 (88%)	9 (11%)	1 (1%)	11	38
26	Q	69/104 (66%)	65 (94%)	4 (6%)	0	100	100
27	R	84/87 (97%)	78 (93%)	6 (7%)	0	100	100
28	S	77/87 (88%)	74 (96%)	2 (3%)	1 (1%)	10	36
29	T	57/60 (95%)	54 (95%)	3 (5%)	0	100	100
30	X	28/444 (6%)	24 (86%)	4 (14%)	0	100	100
32	Z	3/36 (8%)	3 (100%)	0	0	100	100
33	a	283/287 (99%)	266 (94%)	16 (6%)	1 (0%)	30	62
34	b	229/287 (80%)	221 (96%)	8 (4%)	0	100	100
35	c	209/212 (99%)	198 (95%)	11 (5%)	0	100	100
36	d	177/180 (98%)	170 (96%)	7 (4%)	0	100	100
37	e	174/184 (95%)	161 (92%)	13 (8%)	0	100	100
38	f	147/149 (99%)	134 (91%)	12 (8%)	1 (1%)	19	51
39	g	123/161 (76%)	118 (96%)	5 (4%)	0	100	100
40	h	126/137 (92%)	121 (96%)	5 (4%)	0	100	100
41	i	142/146 (97%)	134 (94%)	8 (6%)	0	100	100
42	j	120/122 (98%)	115 (96%)	5 (4%)	0	100	100
43	k	148/151 (98%)	139 (94%)	9 (6%)	0	100	100

Continued on next page...

Continued from previous page...

Mol	Chain	Analysed	Favoured	Allowed	Outliers	Percentiles	
44	l	134/139 (96%)	132 (98%)	2 (2%)	0	100	100
45	m	117/124 (94%)	112 (96%)	5 (4%)	0	100	100
46	n	114/116 (98%)	109 (96%)	5 (4%)	0	100	100
47	o	116/119 (98%)	107 (92%)	9 (8%)	0	100	100
48	p	116/127 (91%)	114 (98%)	2 (2%)	0	100	100
49	q	97/100 (97%)	92 (95%)	5 (5%)	0	100	100
50	r	140/159 (88%)	136 (97%)	4 (3%)	0	100	100
51	s	93/237 (39%)	89 (96%)	4 (4%)	0	100	100
52	t	109/111 (98%)	102 (94%)	7 (6%)	0	100	100
53	u	86/104 (83%)	83 (96%)	3 (4%)	0	100	100
54	v	62/65 (95%)	62 (100%)	0	0	100	100
55	w	108/111 (97%)	103 (95%)	5 (5%)	0	100	100
56	x	94/97 (97%)	67 (71%)	24 (26%)	3 (3%)	3	16
57	y	54/57 (95%)	52 (96%)	2 (4%)	0	100	100
58	z	48/53 (91%)	47 (98%)	1 (2%)	0	100	100
All	All	6047/7150 (85%)	5615 (93%)	405 (7%)	27 (0%)	32	62

5 of 27 Ramachandran outliers are listed below:

Mol	Chain	Res	Type
11	B	229	GLN
11	B	230	PRO
20	K	56	LYS
25	P	54	LEU
11	B	217	ARG

5.3.2 Protein sidechains [i](#)

In the following table, the Percentiles column shows the percent sidechain outliers of the chain as a percentile score with respect to all PDB entries followed by that with respect to all EM entries.

The Analysed column shows the number of residues for which the sidechain conformation was analysed, and the total number of residues.

Mol	Chain	Analysed	Rotameric	Outliers	Percentiles	
1	0	41/41 (100%)	41 (100%)	0	100	100

Continued on next page...

Continued from previous page...

Mol	Chain	Analysed	Rotameric	Outliers	Percentiles	
2	1	51/51 (100%)	49 (96%)	2 (4%)	27	59
3	2	35/35 (100%)	34 (97%)	1 (3%)	37	67
10	A	238/262 (91%)	231 (97%)	7 (3%)	37	67
11	B	195/232 (84%)	190 (97%)	5 (3%)	41	69
12	C	182/183 (100%)	172 (94%)	10 (6%)	18	47
13	D	125/178 (70%)	123 (98%)	2 (2%)	58	79
14	E	165/196 (84%)	160 (97%)	5 (3%)	36	66
15	F	132/132 (100%)	130 (98%)	2 (2%)	60	80
16	G	123/124 (99%)	116 (94%)	7 (6%)	17	46
17	H	112/115 (97%)	109 (97%)	3 (3%)	40	68
18	I	97/99 (98%)	95 (98%)	2 (2%)	48	74
19	J	91/97 (94%)	89 (98%)	2 (2%)	47	73
20	K	117/120 (98%)	113 (97%)	4 (3%)	32	63
21	L	104/105 (99%)	101 (97%)	3 (3%)	37	67
22	M	47/48 (98%)	47 (100%)	0	100	100
23	N	77/78 (99%)	77 (100%)	0	100	100
24	O	76/82 (93%)	74 (97%)	2 (3%)	41	69
25	P	75/75 (100%)	71 (95%)	4 (5%)	19	48
26	Q	62/94 (66%)	61 (98%)	1 (2%)	58	79
27	R	76/77 (99%)	72 (95%)	4 (5%)	19	48
28	S	71/77 (92%)	70 (99%)	1 (1%)	62	81
29	T	55/56 (98%)	51 (93%)	4 (7%)	11	36
30	X	27/406 (7%)	24 (89%)	3 (11%)	5	19
32	Z	2/2 (100%)	2 (100%)	0	100	100
33	a	241/243 (99%)	239 (99%)	2 (1%)	79	89
34	b	188/233 (81%)	179 (95%)	9 (5%)	21	52
35	c	183/184 (100%)	174 (95%)	9 (5%)	21	51
36	d	153/154 (99%)	143 (94%)	10 (6%)	14	41
37	e	153/159 (96%)	148 (97%)	5 (3%)	33	64
38	f	133/134 (99%)	128 (96%)	5 (4%)	28	59
39	g	100/129 (78%)	92 (92%)	8 (8%)	10	32

Continued on next page...

Continued from previous page...

Mol	Chain	Analysed	Rotameric	Outliers	Percentiles	
40	h	102/110 (93%)	100 (98%)	2 (2%)	50	75
41	i	126/128 (98%)	120 (95%)	6 (5%)	21	52
42	j	103/103 (100%)	100 (97%)	3 (3%)	37	67
43	k	125/126 (99%)	119 (95%)	6 (5%)	21	52
44	l	113/115 (98%)	108 (96%)	5 (4%)	24	55
45	m	105/109 (96%)	99 (94%)	6 (6%)	17	46
46	n	99/99 (100%)	96 (97%)	3 (3%)	36	66
47	o	104/105 (99%)	102 (98%)	2 (2%)	52	76
48	p	104/108 (96%)	101 (97%)	3 (3%)	37	67
49	q	90/91 (99%)	84 (93%)	6 (7%)	13	40
50	r	118/132 (89%)	115 (98%)	3 (2%)	42	70
51	s	84/208 (40%)	79 (94%)	5 (6%)	16	44
52	t	96/96 (100%)	93 (97%)	3 (3%)	35	65
53	u	70/85 (82%)	68 (97%)	2 (3%)	37	67
54	v	59/60 (98%)	58 (98%)	1 (2%)	56	78
55	w	97/98 (99%)	92 (95%)	5 (5%)	19	49
56	x	85/86 (99%)	78 (92%)	7 (8%)	9	31
57	y	48/49 (98%)	40 (83%)	8 (17%)	2	8
58	z	47/50 (94%)	45 (96%)	2 (4%)	25	55
All	All	5302/6159 (86%)	5102 (96%)	200 (4%)	30	59

5 of 200 residues with a non-rotameric sidechain are listed below:

Mol	Chain	Res	Type
39	g	24	PHE
44	l	83	MET
58	z	12	ASN
39	g	67	LYS
42	j	72	LYS

Sometimes sidechains can be flipped to improve hydrogen bonding and reduce clashes. 5 of 32 such sidechains are listed below:

Mol	Chain	Res	Type
52	t	65	GLN

Continued on next page...

Continued from previous page...

Mol	Chain	Res	Type
56	x	91	HIS
21	L	79	HIS
20	K	29	ASN
56	x	98	ASN

5.3.3 RNA [i](#)

Mol	Chain	Analysed	Backbone Outliers	Pucker Outliers
31	Y	20/21 (95%)	14 (70%)	4 (20%)
4	3	2891/2907 (99%)	522 (18%)	22 (0%)
5	4	107/108 (99%)	29 (27%)	0
6	5	1503/1520 (98%)	254 (16%)	9 (0%)
7	6	75/76 (98%)	29 (38%)	6 (8%)
8	7	74/75 (98%)	20 (27%)	2 (2%)
9	8	75/76 (98%)	23 (30%)	0
All	All	4745/4783 (99%)	891 (18%)	43 (0%)

5 of 891 RNA backbone outliers are listed below:

Mol	Chain	Res	Type
4	3	11	U
4	3	12	A
4	3	13	C
4	3	14	U
4	3	28	G

5 of 43 RNA pucker outliers are listed below:

Mol	Chain	Res	Type
6	5	1158	A
7	6	58	A
6	5	1273	A
7	6	18	G
8	7	10	G

5.4 Non-standard residues in protein, DNA, RNA chains [i](#)

8 non-standard protein/DNA/RNA residues are modelled in this entry.

In the following table, the Counts columns list the number of bonds (or angles) for which Mogul statistics could be retrieved, the number of bonds (or angles) that are observed in the model and

the number of bonds (or angles) that are defined in the Chemical Component Dictionary. The Link column lists molecule types, if any, to which the group is linked. The Z score for a bond length (or angle) is the number of standard deviations the observed value is removed from the expected value. A bond length (or angle) with $|Z| > 2$ is considered an outlier worth inspection. RMSZ is the root-mean-square of all Z scores of the bond lengths (or angles).

Mol	Type	Chain	Res	Link	Bond lengths			Bond angles		
					Counts	RMSZ	# Z > 2	Counts	RMSZ	# Z > 2
6	5MC	5	1375	6	18,22,23	4.06	7 (38%)	26,32,35	1.03	2 (7%)
6	MA6	5	1493	6	18,26,27	1.06	2 (11%)	19,38,41	3.38	3 (15%)
4	2MA	3	2511	4,62	17,25,26	2.64	5 (29%)	17,37,40	1.34	3 (17%)
4	OMG	3	2259	4,62,8	18,26,27	2.83	7 (38%)	19,38,41	1.56	4 (21%)
4	1MG	3	783	4	18,26,27	2.72	6 (33%)	19,39,42	1.46	3 (15%)
6	MA6	5	1494	6	18,26,27	1.06	2 (11%)	19,38,41	3.39	3 (15%)
6	7MG	5	525	6	22,26,27	3.89	10 (45%)	29,39,42	2.03	9 (31%)
6	B8T	5	1377	6	19,22,23	3.29	8 (42%)	26,31,34	0.84	1 (3%)

In the following table, the Chirals column lists the number of chiral outliers, the number of chiral centers analysed, the number of these observed in the model and the number defined in the Chemical Component Dictionary. Similar counts are reported in the Torsion and Rings columns. '-' means no outliers of that kind were identified.

Mol	Type	Chain	Res	Link	Chirals	Torsions	Rings
6	5MC	5	1375	6	-	0/7/25/26	0/2/2/2
6	MA6	5	1493	6	-	0/7/29/30	0/3/3/3
4	2MA	3	2511	4,62	-	2/3/25/26	0/3/3/3
4	OMG	3	2259	4,62,8	-	3/5/27/28	0/3/3/3
4	1MG	3	783	4	-	0/3/25/26	0/3/3/3
6	MA6	5	1494	6	-	3/7/29/30	0/3/3/3
6	7MG	5	525	6	-	2/7/37/38	0/3/3/3
6	B8T	5	1377	6	-	2/7/27/28	0/2/2/2

The worst 5 of 47 bond length outliers are listed below:

Mol	Chain	Res	Type	Atoms	Z	Observed(Å)	Ideal(Å)
6	5	525	7MG	C8-N9	9.96	1.51	1.46
6	5	1375	5MC	C6-C5	9.89	1.50	1.34
6	5	525	7MG	C5-N7	7.98	1.44	1.35
4	3	2511	2MA	C2-N3	7.87	1.47	1.31
6	5	1375	5MC	C4-N3	7.53	1.46	1.34

The worst 5 of 28 bond angle outliers are listed below:

Mol	Chain	Res	Type	Atoms	Z	Observed(°)	Ideal(°)
6	5	1494	MA6	N1-C6-N6	-12.30	104.11	117.06
6	5	1493	MA6	N1-C6-N6	-12.26	104.15	117.06
6	5	1494	MA6	N3-C2-N1	-5.53	120.04	128.68
6	5	1493	MA6	C1'-N9-C4	5.52	136.33	126.64
6	5	1493	MA6	N3-C2-N1	-5.47	120.13	128.68

There are no chirality outliers.

5 of 12 torsion outliers are listed below:

Mol	Chain	Res	Type	Atoms
4	3	2259	OMG	O4'-C4'-C5'-O5'
4	3	2259	OMG	C3'-C4'-C5'-O5'
4	3	2259	OMG	C1'-C2'-O2'-CM2
6	5	525	7MG	O4'-C4'-C5'-O5'
6	5	525	7MG	C3'-C4'-C5'-O5'

There are no ring outliers.

No monomer is involved in short contacts.

5.5 Carbohydrates [i](#)

There are no oligosaccharides in this entry.

5.6 Ligand geometry [i](#)

Of 367 ligands modelled in this entry, 331 are monoatomic - leaving 36 for Mogul analysis.

In the following table, the Counts columns list the number of bonds (or angles) for which Mogul statistics could be retrieved, the number of bonds (or angles) that are observed in the model and the number of bonds (or angles) that are defined in the Chemical Component Dictionary. The Link column lists molecule types, if any, to which the group is linked. The Z score for a bond length (or angle) is the number of standard deviations the observed value is removed from the expected value. A bond length (or angle) with $|Z| > 2$ is considered an outlier worth inspection. RMSZ is the root-mean-square of all Z scores of the bond lengths (or angles).

Mol	Type	Chain	Res	Link	Bond lengths			Bond angles		
					Counts	RMSZ	$\# Z > 2$	Counts	RMSZ	$\# Z > 2$
65	SPD	5	1603	-	9,9,9	0.31	0	8,8,8	0.79	0
64	SPM	3	3248	-	13,13,13	0.35	0	12,12,12	0.89	0
64	SPM	b	303	-	13,13,13	0.16	0	12,12,12	0.32	0
65	SPD	5	1601	-	9,9,9	0.35	0	8,8,8	0.78	0
63	PUT	3	3225	-	5,5,5	0.26	0	4,4,4	0.52	0

Mol	Type	Chain	Res	Link	Bond lengths			Bond angles		
					Counts	RMSZ	# Z > 2	Counts	RMSZ	# Z > 2
63	PUT	3	3224	-	5,5,5	0.25	0	4,4,4	0.53	0
65	SPD	3	3232	-	9,9,9	0.32	0	8,8,8	0.88	0
65	SPD	3	3249	-	9,9,9	0.17	0	8,8,8	0.19	0
65	SPD	3	3247	-	9,9,9	0.32	0	8,8,8	0.87	0
63	PUT	3	3241	-	5,5,5	0.26	0	4,4,4	0.54	0
60	CLM	3	3001	-	19,20,20	0.55	1 (5%)	23,27,27	0.62	0
63	PUT	3	3221	-	5,5,5	0.24	0	4,4,4	0.55	0
63	PUT	5	1604	-	5,5,5	0.26	0	4,4,4	0.54	0
65	SPD	3	3229	-	9,9,9	0.33	0	8,8,8	0.79	0
65	SPD	3	3238	-	9,9,9	0.32	0	8,8,8	0.87	0
65	SPD	3	3239	-	9,9,9	0.32	0	8,8,8	0.86	0
66	N2P	5	1602	-	6,6,6	0.26	0	5,5,5	0.64	0
65	SPD	3	3227	-	9,9,9	0.33	0	8,8,8	0.86	0
65	SPD	3	3236	-	9,9,9	0.33	0	8,8,8	0.93	0
63	PUT	3	3223	-	5,5,5	0.25	0	4,4,4	0.54	0
65	SPD	3	3228	-	9,9,9	0.32	0	8,8,8	0.85	0
65	SPD	3	3233	-	9,9,9	0.33	0	8,8,8	0.78	0
67	LYS	8	103	9	7,8,9	0.85	0	3,8,10	0.33	0
65	SPD	3	3237	-	9,9,9	0.32	0	8,8,8	0.84	0
66	N2P	3	3246	-	6,6,6	0.25	0	5,5,5	0.66	0
65	SPD	3	3231	-	9,9,9	0.35	0	8,8,8	0.75	0
64	SPM	3	3226	-	13,13,13	0.36	0	12,12,12	0.91	0
63	PUT	3	3222	-	5,5,5	0.24	0	4,4,4	0.56	0
63	PUT	3	3230	-	5,5,5	0.26	0	4,4,4	0.51	0
65	SPD	3	3234	-	9,9,9	0.33	0	8,8,8	0.86	0
65	SPD	3	3235	-	9,9,9	0.33	0	8,8,8	0.83	0
64	SPM	3	3240	-	13,13,13	0.35	0	12,12,12	0.91	0
66	N2P	3	3243	-	6,6,6	0.25	0	5,5,5	0.63	0
65	SPD	3	3245	-	9,9,9	0.33	0	8,8,8	0.83	0
66	N2P	3	3242	-	6,6,6	0.26	0	5,5,5	0.65	0
65	SPD	3	3244	-	9,9,9	0.33	0	8,8,8	0.89	0

In the following table, the Chirals column lists the number of chiral outliers, the number of chiral centers analysed, the number of these observed in the model and the number defined in the Chemical Component Dictionary. Similar counts are reported in the Torsion and Rings columns. '-' means no outliers of that kind were identified.

Mol	Type	Chain	Res	Link	Chirals	Torsions	Rings
65	SPD	5	1603	-	-	1/7/7/7	-
64	SPM	3	3248	-	-	2/11/11/11	-
64	SPM	b	303	-	-	2/11/11/11	-
65	SPD	5	1601	-	-	1/7/7/7	-

Continued on next page...

Continued from previous page...

Mol	Type	Chain	Res	Link	Chirals	Torsions	Rings
63	PUT	3	3225	-	-	0/3/3/3	-
63	PUT	3	3224	-	-	1/3/3/3	-
65	SPD	3	3232	-	-	0/7/7/7	-
65	SPD	3	3249	-	-	0/7/7/7	-
65	SPD	3	3247	-	-	0/7/7/7	-
63	PUT	3	3241	-	-	0/3/3/3	-
60	CLM	3	3001	-	-	2/20/22/22	0/1/1/1
63	PUT	3	3221	-	-	0/3/3/3	-
63	PUT	5	1604	-	-	0/3/3/3	-
65	SPD	3	3229	-	-	0/7/7/7	-
65	SPD	3	3238	-	-	2/7/7/7	-
65	SPD	3	3239	-	-	0/7/7/7	-
66	N2P	5	1602	-	-	3/4/4/4	-
65	SPD	3	3227	-	-	0/7/7/7	-
65	SPD	3	3236	-	-	1/7/7/7	-
63	PUT	3	3223	-	-	0/3/3/3	-
65	SPD	3	3228	-	-	1/7/7/7	-
65	SPD	3	3233	-	-	1/7/7/7	-
67	LYS	8	103	9	-	3/6/7/9	-
65	SPD	3	3237	-	-	0/7/7/7	-
66	N2P	3	3246	-	-	1/4/4/4	-
65	SPD	3	3231	-	-	1/7/7/7	-
64	SPM	3	3226	-	-	4/11/11/11	-
63	PUT	3	3222	-	-	0/3/3/3	-
63	PUT	3	3230	-	-	0/3/3/3	-
65	SPD	3	3234	-	-	0/7/7/7	-
65	SPD	3	3235	-	-	0/7/7/7	-
64	SPM	3	3240	-	-	2/11/11/11	-
66	N2P	3	3243	-	-	2/4/4/4	-
65	SPD	3	3245	-	-	1/7/7/7	-
66	N2P	3	3242	-	-	1/4/4/4	-
65	SPD	3	3244	-	-	0/7/7/7	-

All (1) bond length outliers are listed below:

Mol	Chain	Res	Type	Atoms	Z	Observed(Å)	Ideal(Å)
60	3	3001	CLM	C1-C2	-2.13	1.49	1.53

There are no bond angle outliers.

There are no chirality outliers.

5 of 32 torsion outliers are listed below:

Mol	Chain	Res	Type	Atoms
67	8	103	LYS	O-C-CA-CB
67	8	103	LYS	C-CA-CB-CG
65	5	1603	SPD	C8-C7-N6-C5
66	3	3242	N2P	C2-C3-C4-C5
66	5	1602	N2P	C2-C3-C4-C5

There are no ring outliers.

No monomer is involved in short contacts.

The following is a two-dimensional graphical depiction of Mogul quality analysis of bond lengths, bond angles, torsion angles, and ring geometry for all instances of the Ligand of Interest. In addition, ligands with molecular weight > 250 and outliers as shown on the validation Tables will also be included. For torsion angles, if less than 5% of the Mogul distribution of torsion angles is within 10 degrees of the torsion angle in question, then that torsion angle is considered an outlier. Any bond that is central to one or more torsion angles identified as an outlier by Mogul will be highlighted in the graph. For rings, the root-mean-square deviation (RMSD) between the ring in question and similar rings identified by Mogul is calculated over all ring torsion angles. If the average RMSD is greater than 60 degrees and the minimal RMSD between the ring in question and any Mogul-identified rings is also greater than 60 degrees, then that ring is considered an outlier. The outliers are highlighted in purple. The color gray indicates Mogul did not find sufficient equivalents in the CSD to analyse the geometry.

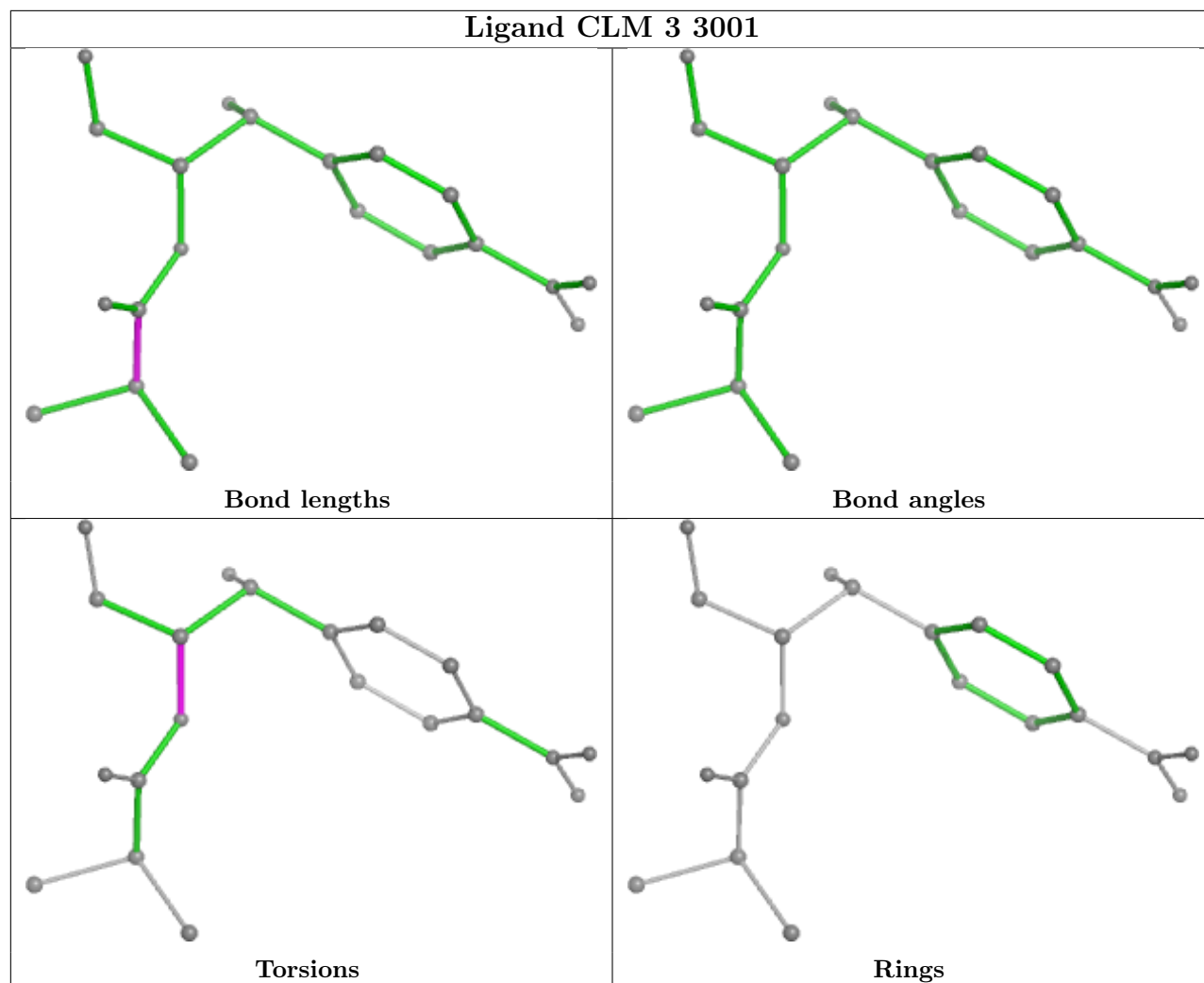

5.7 Other polymers [i](#)

There are no such residues in this entry.

5.8 Polymer linkage issues [i](#)

There are no chain breaks in this entry.

6 Map visualisation [i](#)

This section contains visualisations of the EMDB entry EMD-17132. These allow visual inspection of the internal detail of the map and identification of artifacts.

Images derived from a raw map, generated by summing the deposited half-maps, are presented below the corresponding image components of the primary map to allow further visual inspection and comparison with those of the primary map.

6.1 Orthogonal projections [i](#)

6.1.1 Primary map

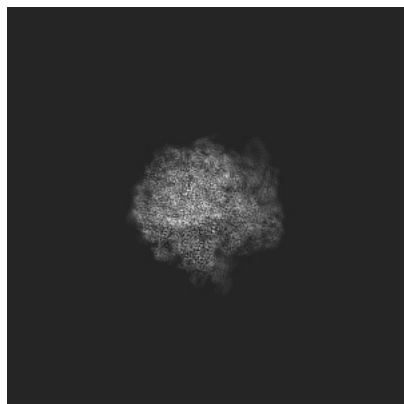

X

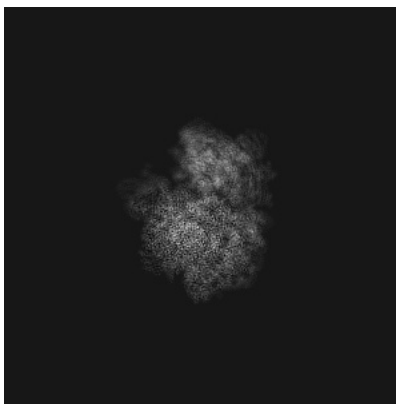

Y

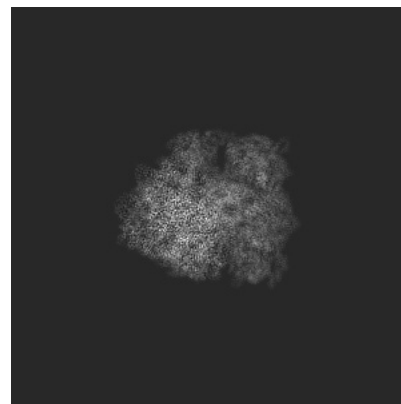

Z

6.1.2 Raw map

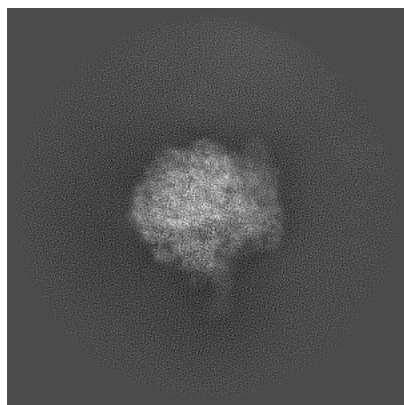

X

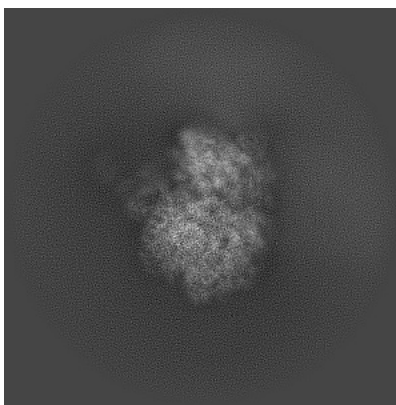

Y

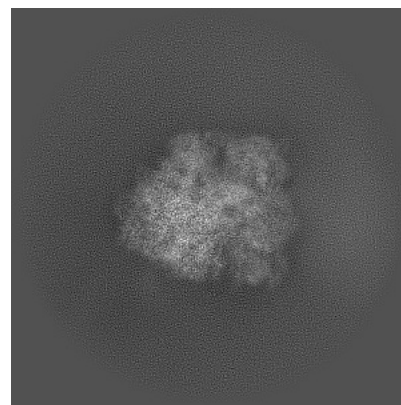

Z

The images above show the map projected in three orthogonal directions.

6.2 Central slices [i](#)

6.2.1 Primary map

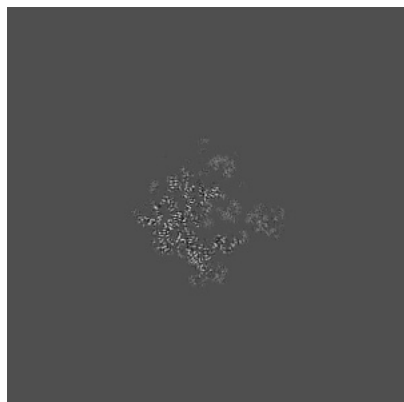

X Index: 211

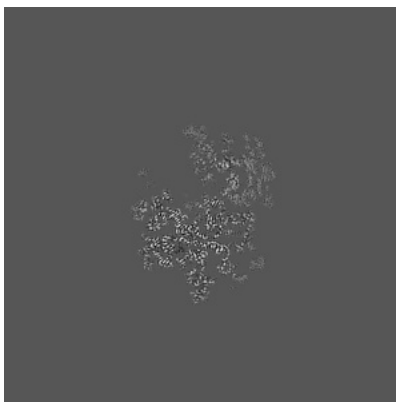

Y Index: 211

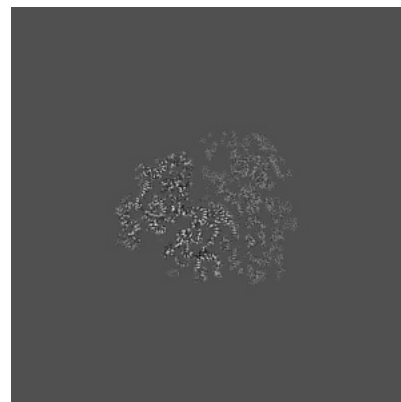

Z Index: 211

6.2.2 Raw map

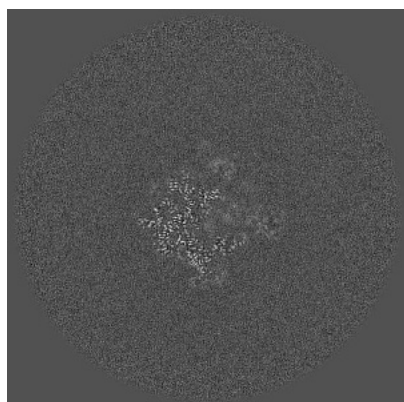

X Index: 211

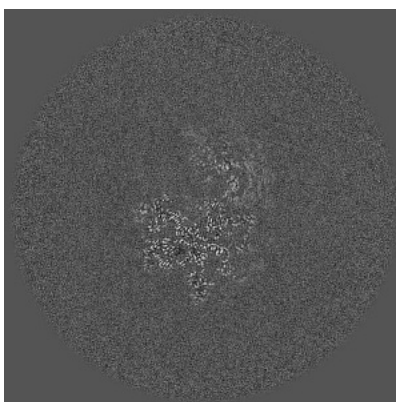

Y Index: 211

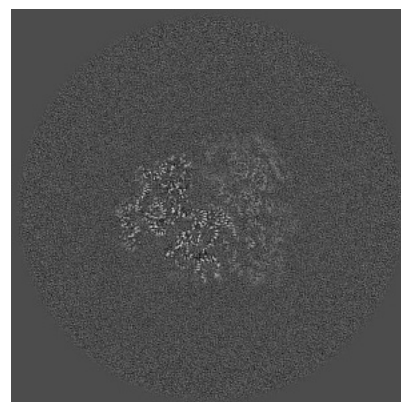

Z Index: 211

The images above show central slices of the map in three orthogonal directions.

6.3 Largest variance slices [i](#)

6.3.1 Primary map



X Index: 182

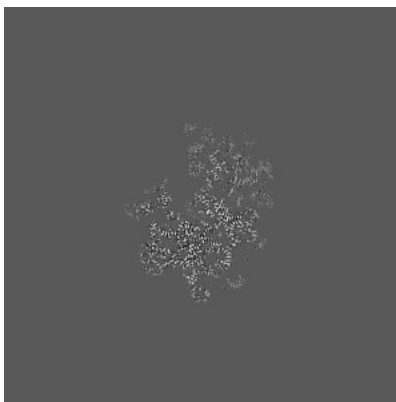

Y Index: 204

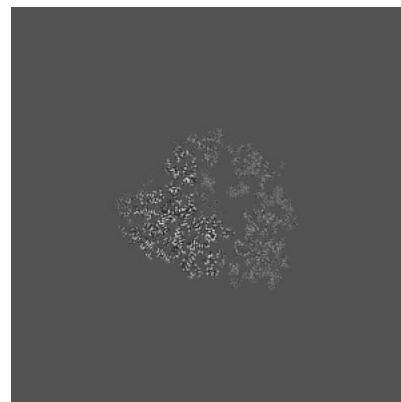

Z Index: 199

6.3.2 Raw map

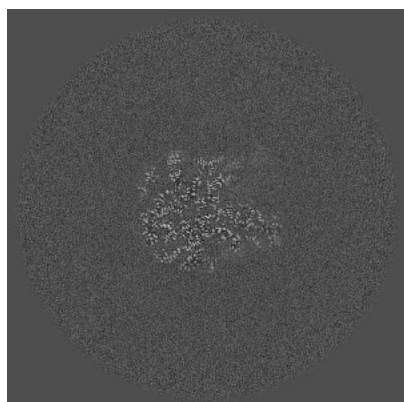

X Index: 185

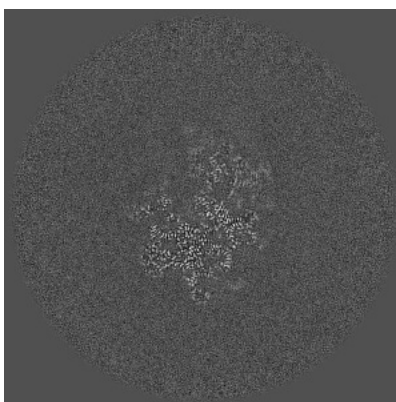

Y Index: 204

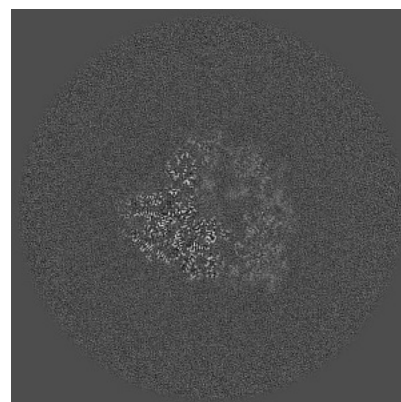

Z Index: 199

The images above show the largest variance slices of the map in three orthogonal directions.

6.4 Orthogonal standard-deviation projections (False-color) [i](#)

6.4.1 Primary map

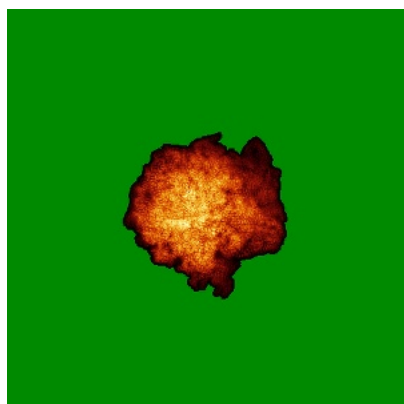

X

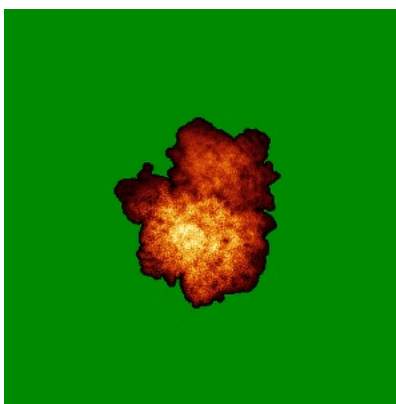

Y

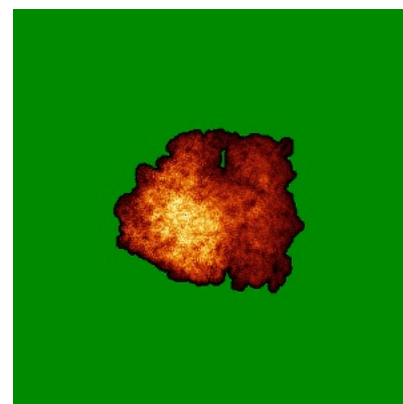

Z

6.4.2 Raw map

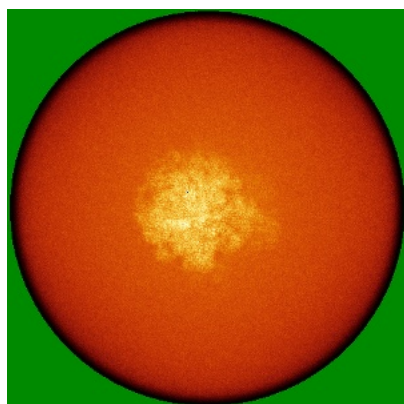

X

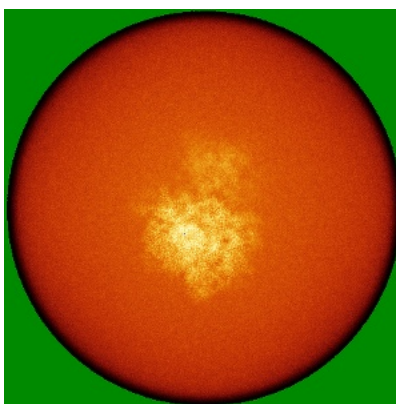

Y

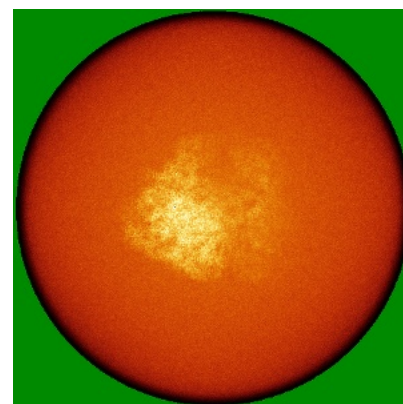

Z

The images above show the map standard deviation projections with false color in three orthogonal directions. Minimum values are shown in green, max in blue, and dark to light orange shades represent small to large values respectively.

6.5 Orthogonal surface views [i](#)

6.5.1 Primary map

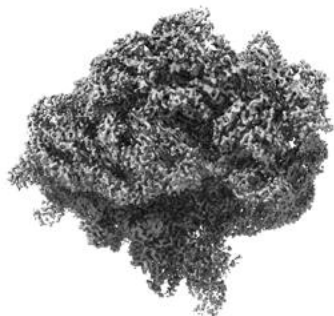

X

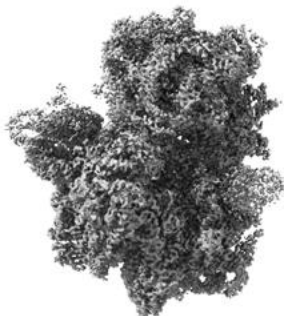

Y

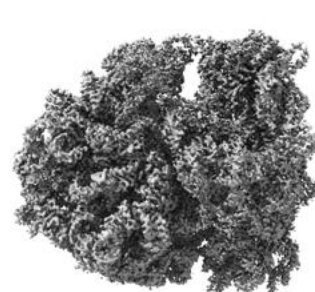

Z

The images above show the 3D surface view of the map at the recommended contour level 0.0022. These images, in conjunction with the slice images, may facilitate assessment of whether an appropriate contour level has been provided.

6.5.2 Raw map

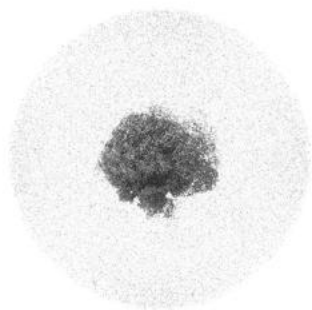

X

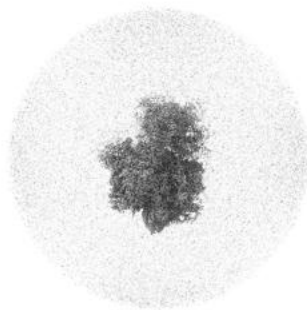

Y

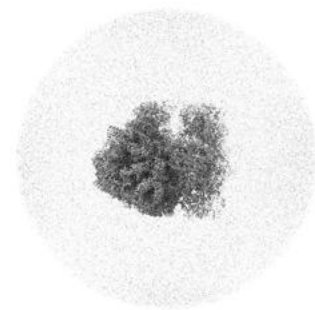

Z

These images show the 3D surface of the raw map. The raw map's contour level was selected so that its surface encloses the same volume as the primary map does at its recommended contour level.

6.6 Mask visualisation [i](#)

This section shows the 3D surface view of the primary map at 50% transparency overlaid with the specified mask at 0% transparency

A mask typically either:

- Encompasses the whole structure
- Separates out a domain, a functional unit, a monomer or an area of interest from a larger structure

6.6.1 emd_17132_msk_1.map [i](#)

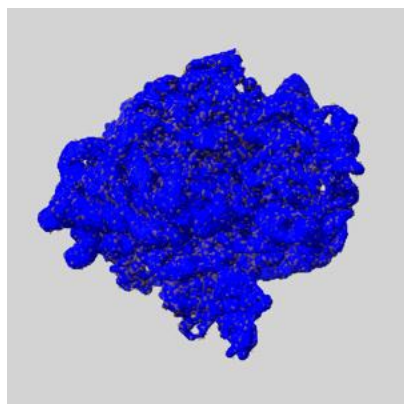

X

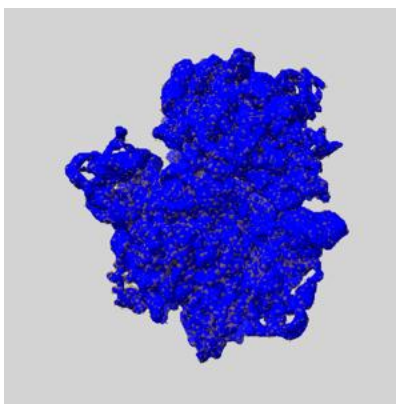

Y

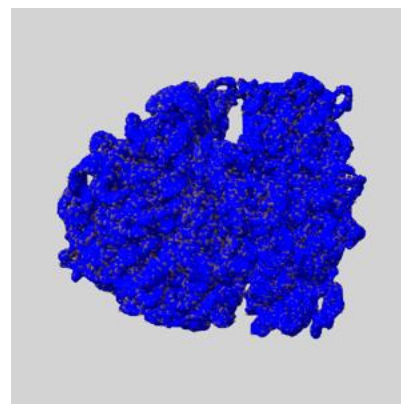

Z

7 Map analysis [i](#)

This section contains the results of statistical analysis of the map.

7.1 Map-value distribution [i](#)

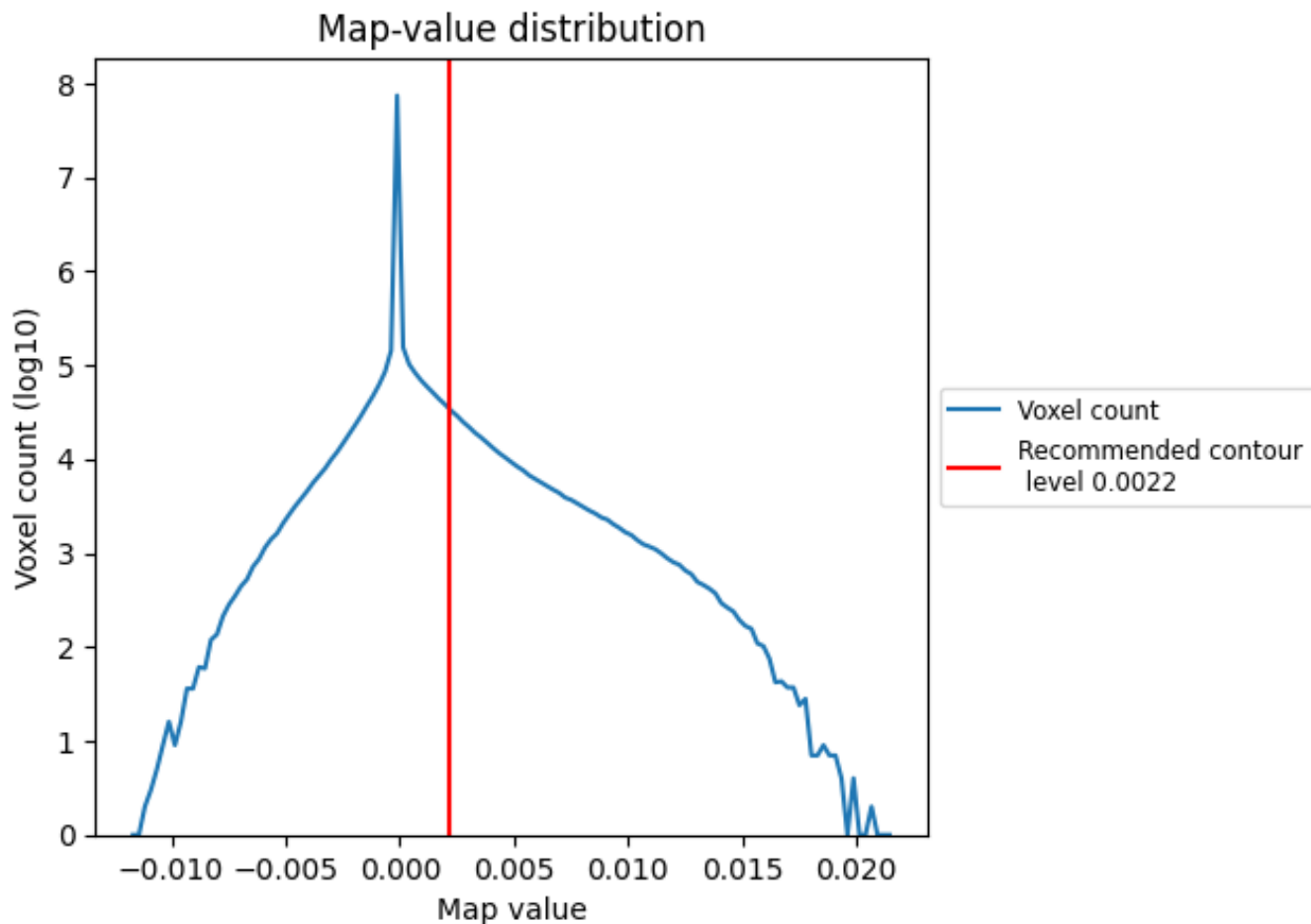

The map-value distribution is plotted in 128 intervals along the x-axis. The y-axis is logarithmic. A spike in this graph at zero usually indicates that the volume has been masked.

7.2 Volume estimate [\(i\)](#)

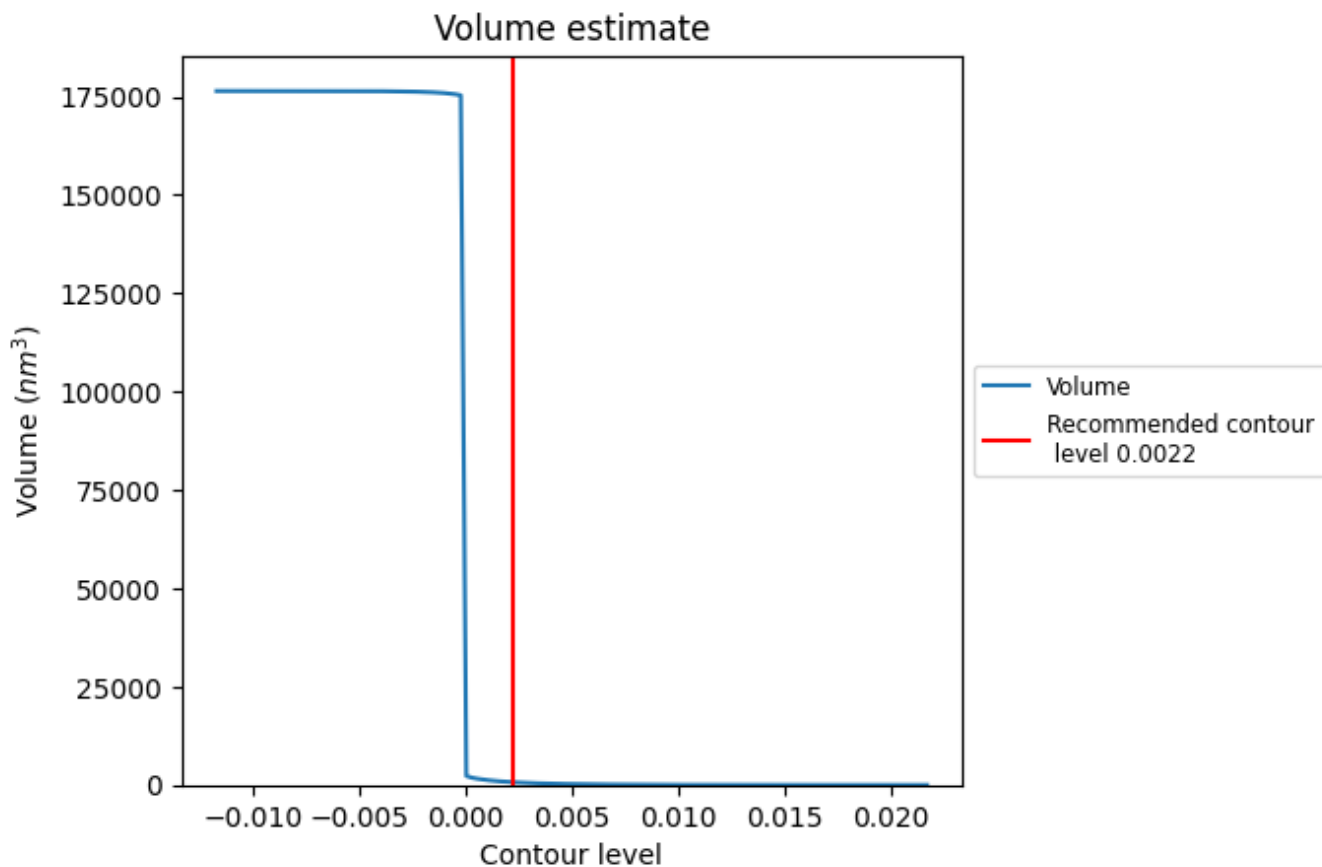

The volume at the recommended contour level is 710 nm³; this corresponds to an approximate mass of 642 kDa.

The volume estimate graph shows how the enclosed volume varies with the contour level. The recommended contour level is shown as a vertical line and the intersection between the line and the curve gives the volume of the enclosed surface at the given level.

7.3 Rotationally averaged power spectrum i

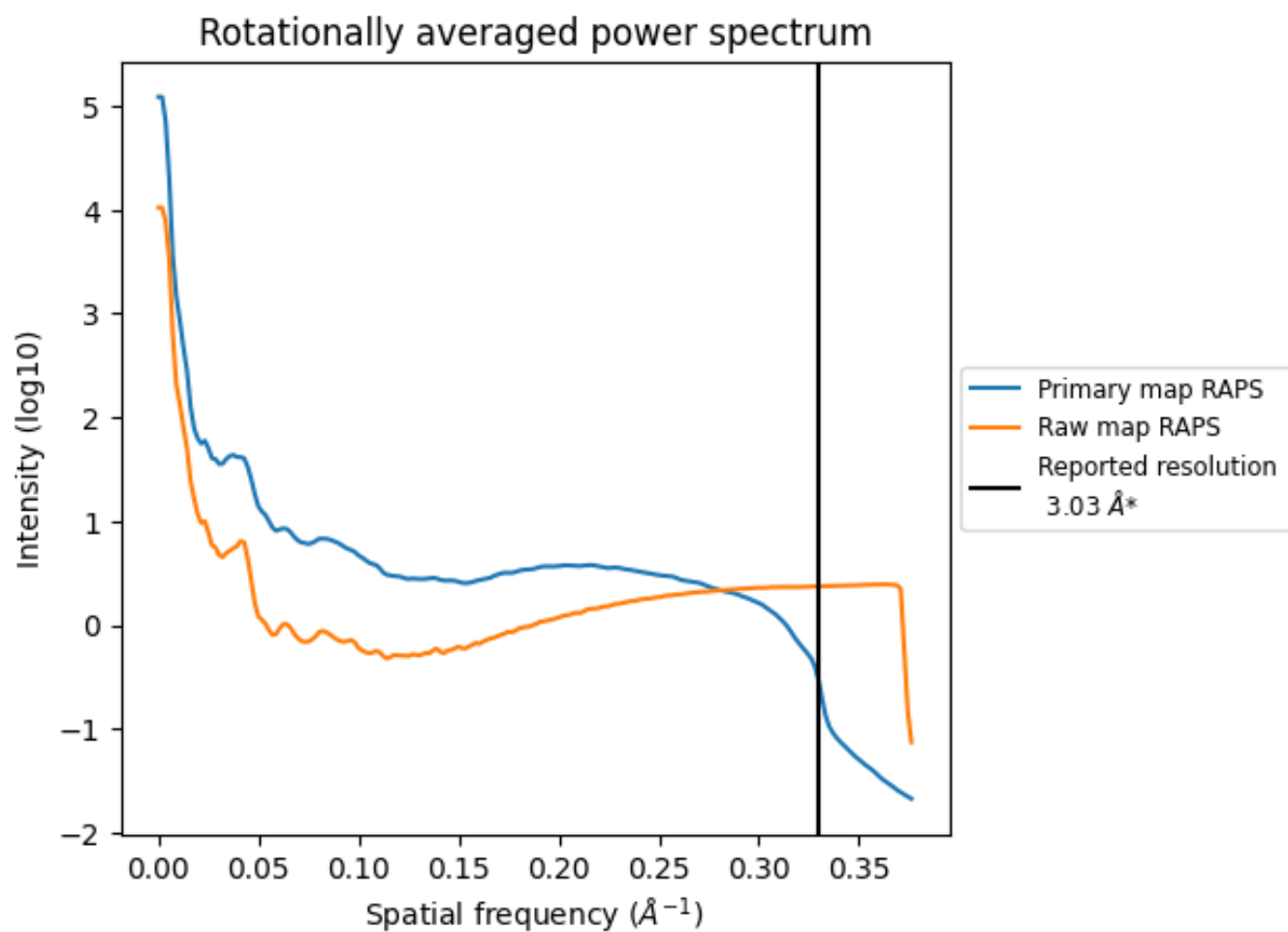

*Reported resolution corresponds to spatial frequency of 0.330 \AA^{-1}

8 Fourier-Shell correlation [i](#)

Fourier-Shell Correlation (FSC) is the most commonly used method to estimate the resolution of single-particle and subtomogram-averaged maps. The shape of the curve depends on the imposed symmetry, mask and whether or not the two 3D reconstructions used were processed from a common reference. The reported resolution is shown as a black line. A curve is displayed for the half-bit criterion in addition to lines showing the 0.143 gold standard cut-off and 0.5 cut-off.

8.1 FSC [i](#)

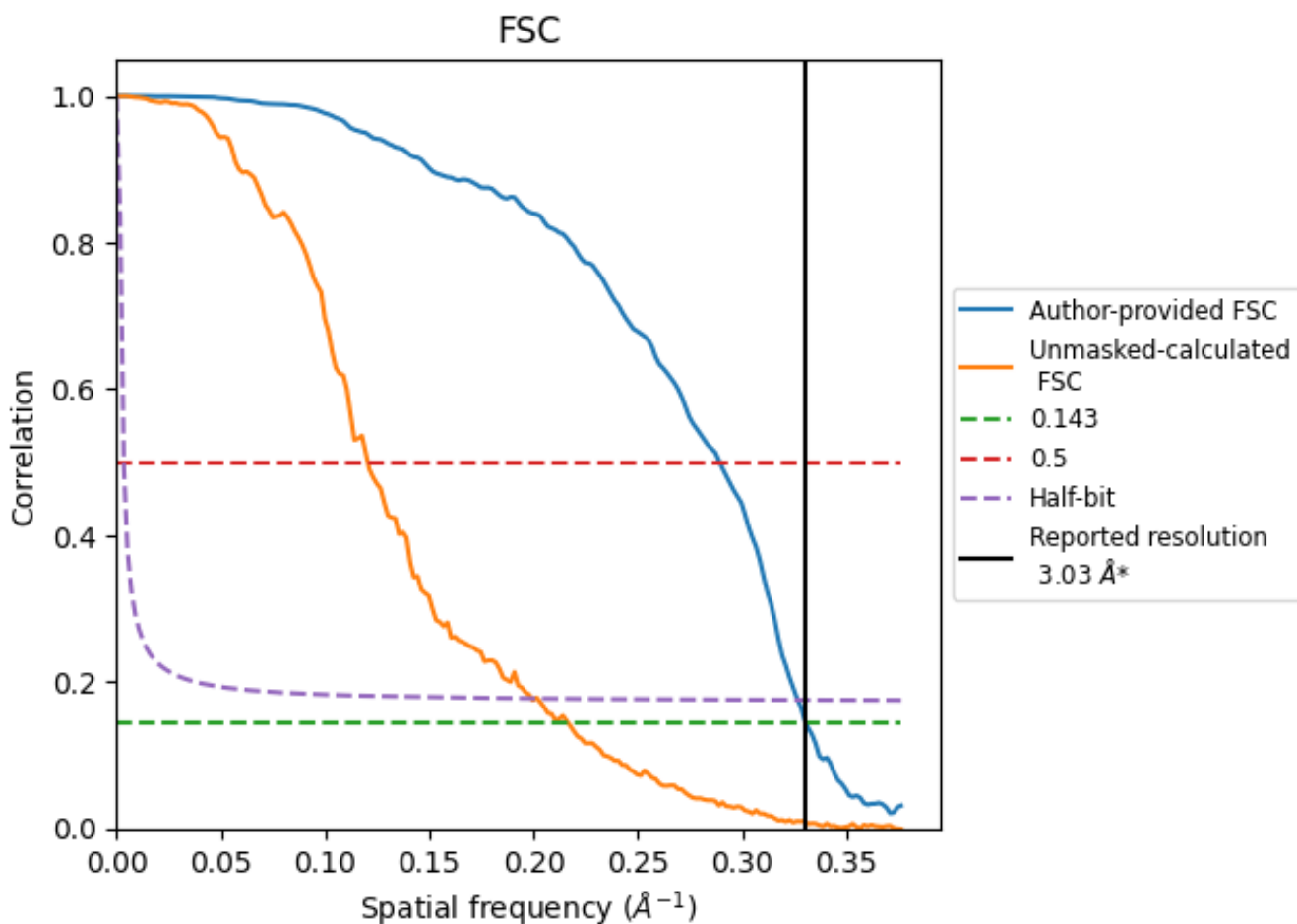

*Reported resolution corresponds to spatial frequency of 0.330 Å⁻¹

8.2 Resolution estimates [i](#)

Resolution estimate (Å)	Estimation criterion (FSC cut-off)		
	0.143	0.5	Half-bit
Reported by author	3.03	-	-
Author-provided FSC curve	3.02	3.46	3.06
Unmasked-calculated*	4.61	8.30	5.02

*Resolution estimate based on FSC curve calculated by comparison of deposited half-maps. The value from deposited half-maps intersecting FSC 0.143 CUT-OFF 4.61 differs from the reported value 3.03 by more than 10 %

9 Map-model fit [i](#)

This section contains information regarding the fit between EMDB map EMD-17132 and PDB model 8P7X. Per-residue inclusion information can be found in section 3 on page 20.

9.1 Map-model overlay [i](#)

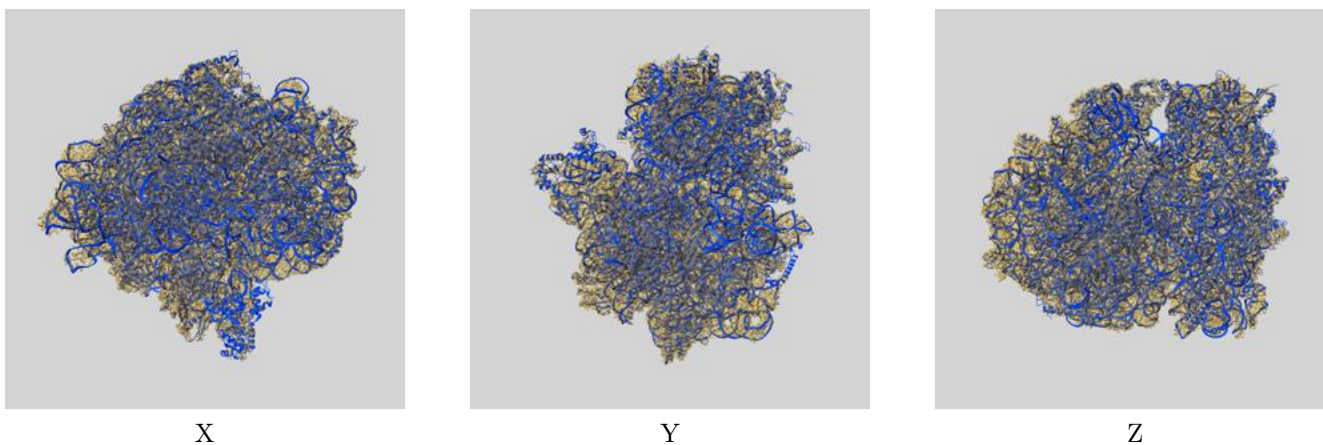

The images above show the 3D surface view of the map at the recommended contour level 0.0022 at 50% transparency in yellow overlaid with a ribbon representation of the model coloured in blue. These images allow for the visual assessment of the quality of fit between the atomic model and the map.

9.2 Q-score mapped to coordinate model [i](#)

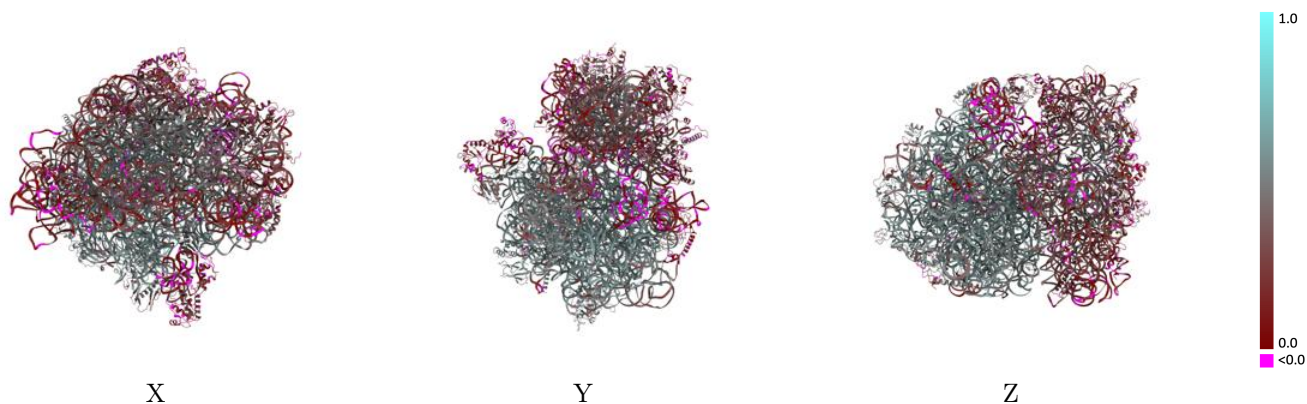

The images above show the model with each residue coloured according to its Q-score. This shows their resolvability in the map with higher Q-score values reflecting better resolvability. Please note: Q-score is calculating the resolvability of atoms, and thus high values are only expected at resolutions at which atoms can be resolved. Low Q-score values may therefore be expected for many entries.

9.3 Atom inclusion mapped to coordinate model [i](#)

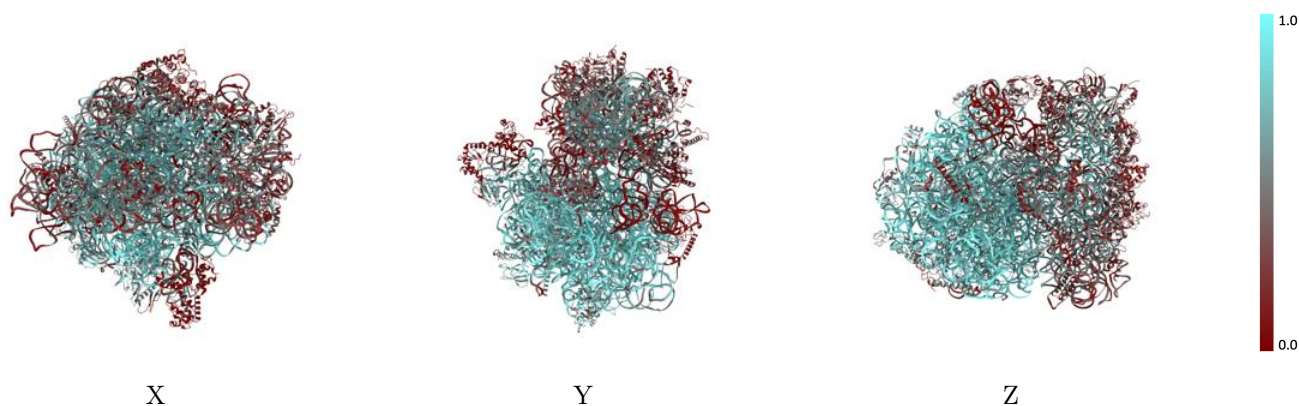

The images above show the model with each residue coloured according to its atom inclusion. This shows to what extent they are inside the map at the recommended contour level (0.0022).



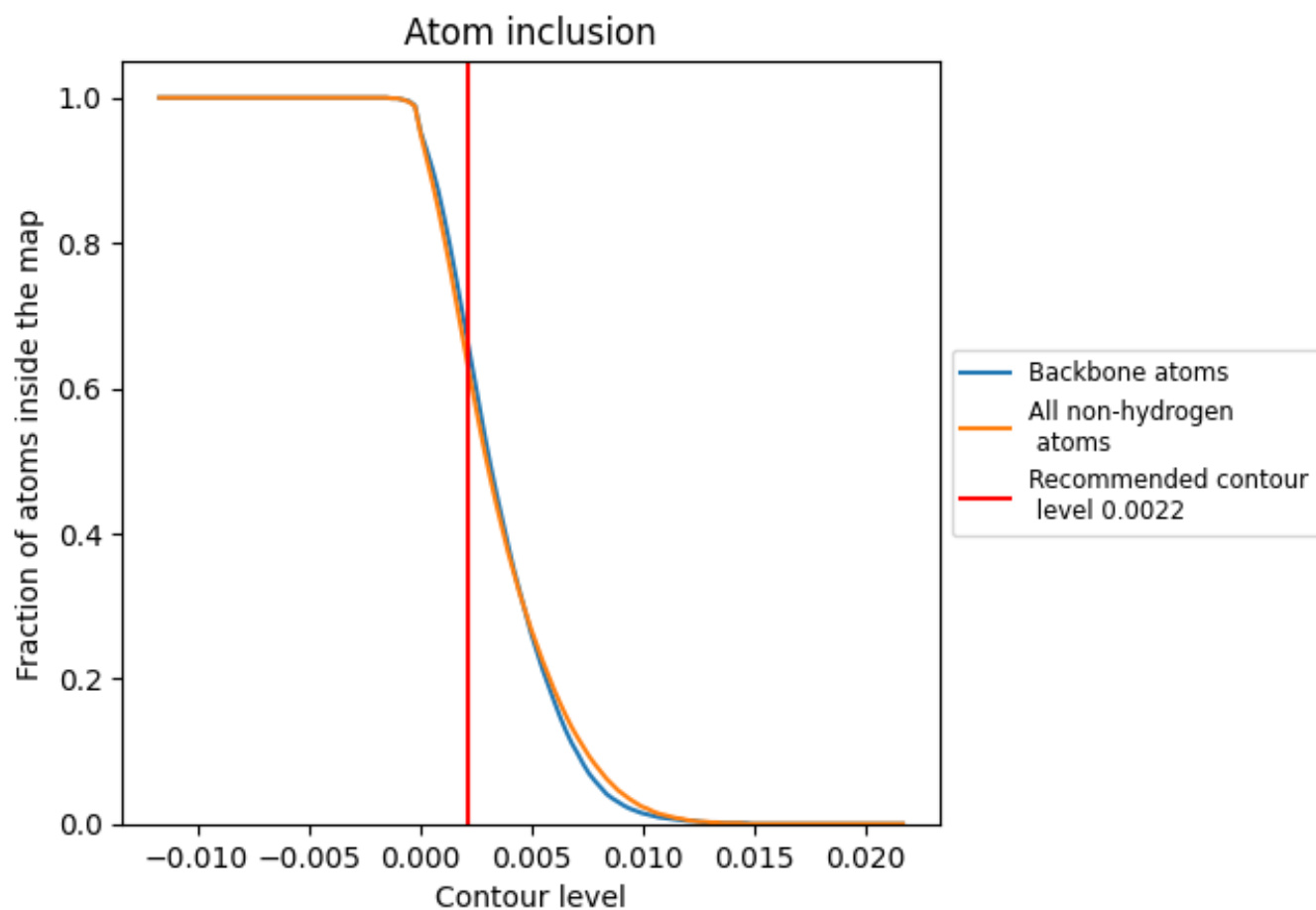



































































9.4 Atom inclusion [i](#)



At the recommended contour level, 66% of all backbone atoms, 62% of all non-hydrogen atoms, are inside the map.

9.5 Map-model fit summary

















































The table lists the average atom inclusion at the recommended contour level (0.0022) and Q-score for the entire model and for each chain.

Chain	Atom inclusion	Q-score
All	 0.6250	 0.4120
0	 0.7390	 0.5420
1	 0.7000	 0.5460
2	 0.7070	 0.5340
3	 0.8280	 0.5150
4	 0.7390	 0.4420
5	 0.5710	 0.3220
6	 0.0210	 0.0030
7	 0.5260	 0.3410
8	 0.2850	 0.2860
A	 0.2370	 0.2030
B	 0.3660	 0.3460
C	 0.1850	 0.1980
D	 0.4190	 0.3590
E	 0.1760	 0.1810
F	 0.1790	 0.2280
G	 0.3020	 0.2960
H	 0.2360	 0.2410
I	 0.2570	 0.2710
J	 0.2360	 0.2450
K	 0.4300	 0.3510
L	 0.1700	 0.1900
M	 0.3880	 0.3510
N	 0.2750	 0.2470
O	 0.2220	 0.1900
P	 0.1950	 0.1980
Q	 0.2400	 0.2100
R	 0.1470	 0.1980
S	 0.2400	 0.2080
T	 0.2940	 0.2930
X	 0.0170	 0.1080
Y	 0.3770	 0.3210
Z	 0.0700	 0.1610
a	 0.6990	 0.5260
b	 0.6870	 0.5170



Continued on next page...

Continued from previous page...

Chain	Atom inclusion	Q-score
c	 0.6560	 0.4900
d	 0.3530	 0.3310
e	 0.4920	 0.4340
f	 0.1300	 0.1140
g	 0.0820	 0.1300
h	 0.0260	 0.0700
i	 0.7010	 0.5140
j	 0.6700	 0.5200
k	 0.6430	 0.4890
l	 0.7100	 0.5230
m	 0.7040	 0.5300
n	 0.5760	 0.4810
o	 0.6550	 0.5000
p	 0.6840	 0.5400
q	 0.6910	 0.5180
r	 0.7020	 0.5280
s	 0.6390	 0.4880
t	 0.4990	 0.4110
u	 0.6550	 0.5070
v	 0.6470	 0.5030
w	 0.5020	 0.4290
x	 0.1260	 0.1750
y	 0.7210	 0.5340
z	 0.6830	 0.5260