



## Full wwPDB EM Validation Report ⓘ

Oct 11, 2022 – 06:09 pm BST

PDB ID : 7PIA  
EMDB ID : EMD-13434  
Title : 70S ribosome with A/P- and P/E-site tRNAs in spectinomycin-treated Mycoplasma pneumoniae cells  
Authors : Xue, L.; Lenz, S.; Rappsilber, J.; Mahamid, J.  
Deposited on : 2021-08-19  
Resolution : 13.60 Å (reported)  
Based on initial models : 4V7C, 7OOD, 7OOC

This is a Full wwPDB EM Validation Report for a publicly released PDB entry.

We welcome your comments at [validation@mail.wwpdb.org](mailto:validation@mail.wwpdb.org)

A user guide is available at

<https://www.wwpdb.org/validation/2017/EMValidationReportHelp>

with specific help available everywhere you see the ⓘ symbol.

The types of validation reports are described at

<http://www.wwpdb.org/validation/2017/FAQs#types>.

---

The following versions of software and data (see [references ⓘ](#)) were used in the production of this report:

EMDB validation analysis : 0.0.1.dev43  
MolProbity : 4.02b-467  
Percentile statistics : 20191225.v01 (using entries in the PDB archive December 25th 2019)  
MapQ : 1.9.9  
Ideal geometry (proteins) : Engh & Huber (2001)  
Ideal geometry (DNA, RNA) : Parkinson et al. (1996)  
Validation Pipeline (wwPDB-VP) : 2.31.2

# 1 Overall quality at a glance

The following experimental techniques were used to determine the structure:  
*ELECTRON MICROSCOPY*

The reported resolution of this entry is 13.60 Å.

Percentile scores (ranging between 0-100) for global validation metrics of the entry are shown in the following graphic. The table shows the number of entries on which the scores are based.

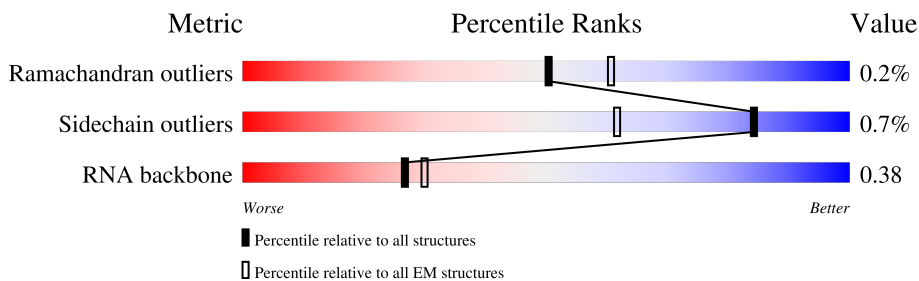

Metric	Whole archive (#Entries)	EM structures (#Entries)
Ramachandran outliers	154571	4023
Sidechain outliers	154315	3826
RNA backbone	4643	859

The table below summarises the geometric issues observed across the polymeric chains and their fit to the map. The red, orange, yellow and green segments of the bar indicate the fraction of residues that contain outliers for  $\geq 3$ , 2, 1 and 0 types of geometric quality criteria respectively. A grey segment represents the fraction of residues that are not modelled. The numeric value for each fraction is indicated below the corresponding segment, with a dot representing fractions  $\leq 5\%$ . The upper red bar (where present) indicates the fraction of residues that have poor fit to the EM map (all-atom inclusion  $< 40\%$ ). The numeric value is given above the bar.

Mol	Chain	Length	Quality of chain
1	0	48	
2	1	59	
3	2	37	
4	A	294	
5	B	273	
6	C	205	
7	D	219	
8	E	215	

Continued on next page...

Continued from previous page...

Mol	Chain	Length	Quality of chain
9	F	155	55% 99%
10	G	142	46% 99%
11	H	132	43% 95%
12	I	108	35% 94% 6%
13	J	121	39% 93% 6%
14	K	139	26% 96%
15	L	124	40% 95% 5%
16	M	61	97%
17	N	86	37% 95%
18	O	94	20% 84% 15%
19	P	85	25% 98%
20	Q	104	16% 62% 38%
21	R	87	21% 93%
22	S	87	9% 89% 11%
23	T	60	22% 88% 12%
24	a	287	98%
25	b	287	79% 20%
26	c	212	99%
27	d	180	14% 97%
28	e	184	40% 96%
29	f	149	47% 94%
30	g	161	43% 74% 22%
31	h	137	55% 93% 7%
32	i	146	6% 97%
33	j	122	23% 100%

Continued on next page...

Continued from previous page...

Mol	Chain	Length	Quality of chain
34	k	151	97%
35	l	139	98%
36	m	124	96%
37	n	116	96%
38	o	119	97%
39	p	127	90% 10%
40	q	100	98%
41	r	159	87% 13%
42	s	237	39% 61%
43	t	111	100%
44	u	104	83% 17%
45	v	65	97%
46	w	111	89% 10%
47	x	97	45% 55%
48	y	57	95%
49	z	53	94% 6%
50	3	2907	60% 38%
51	4	108	54% 42%
52	5	1520	64% 33%
53	7	76	59% 39%
53	8	76	59% 39%

## 2 Entry composition

There are 53 unique types of molecules in this entry. The entry contains 146142 atoms, of which 0 are hydrogens and 0 are deuteriums.

In the tables below, the AltConf column contains the number of residues with at least one atom in alternate conformation and the Trace column contains the number of residues modelled with at most 2 atoms.

- Molecule 1 is a protein called 50S ribosomal protein L34.

Mol	Chain	Residues	Atoms					AltConf	Trace
			Total	C	N	O	S		
1	0	47	380	236	81	61	2	0	0

- Molecule 2 is a protein called 50S ribosomal protein L35.

Mol	Chain	Residues	Atoms					AltConf	Trace
			Total	C	N	O	S		
2	1	59	477	300	99	77	1	0	0

- Molecule 3 is a protein called 50S ribosomal protein L36.

Mol	Chain	Residues	Atoms					AltConf	Trace
			Total	C	N	O	S		
3	2	37	304	189	65	46	4	0	0

- Molecule 4 is a protein called 30S ribosomal protein S2.

Mol	Chain	Residues	Atoms					AltConf	Trace
			Total	C	N	O	S		
4	A	240	1921	1226	334	352	9	0	0

- Molecule 5 is a protein called 30S ribosomal protein S3.

Mol	Chain	Residues	Atoms					AltConf	Trace
			Total	C	N	O	S		
5	B	215	1698	1073	313	307	5	0	0

- Molecule 6 is a protein called 30S ribosomal protein S4.

Mol	Chain	Residues	Atoms					AltConf	Trace
			Total	C	N	O	S		
6	C	203	1660	1051	314	290	5	0	0

- Molecule 7 is a protein called 30S ribosomal protein S5.

Mol	Chain	Residues	Atoms					AltConf	Trace
			Total	C	N	O	S		
7	D	153	1173	742	226	202	3	0	0

- Molecule 8 is a protein called 30S ribosomal protein S6.

Mol	Chain	Residues	Atoms					AltConf	Trace
			Total	C	N	O	S		
8	E	167	1362	857	240	263	2	0	0

- Molecule 9 is a protein called 30S ribosomal protein S7.

Mol	Chain	Residues	Atoms					AltConf	Trace
			Total	C	N	O	S		
9	F	154	1246	785	239	216	6	0	0

- Molecule 10 is a protein called 30S ribosomal protein S8.

Mol	Chain	Residues	Atoms					AltConf	Trace
			Total	C	N	O	S		
10	G	141	1110	723	193	192	2	0	0

- Molecule 11 is a protein called 30S ribosomal protein S9.

Mol	Chain	Residues	Atoms					AltConf	Trace
			Total	C	N	O	S		
11	H	128	1028	655	191	181	1	0	0

- Molecule 12 is a protein called 30S ribosomal protein S10.

Mol	Chain	Residues	Atoms					AltConf	Trace
			Total	C	N	O	S		
12	I	101	809	523	142	143	1	0	0

- Molecule 13 is a protein called 30S ribosomal protein S11.

Mol	Chain	Residues	Atoms					AltConf	Trace
			Total	C	N	O	S		
13	J	114	829	514	153	156	6	0	0

- Molecule 14 is a protein called 30S ribosomal protein S12.

Mol	Chain	Residues	Atoms					AltConf	Trace
			Total	C	N	O	S		
14	K	136	1076	680	213	181	2	0	0

- Molecule 15 is a protein called 30S ribosomal protein S13.

Mol	Chain	Residues	Atoms					AltConf	Trace
			Total	C	N	O	S		
15	L	118	951	594	191	166		0	0

- Molecule 16 is a protein called 30S ribosomal protein S14 type Z.

Mol	Chain	Residues	Atoms					AltConf	Trace
			Total	C	N	O	S		
16	M	60	474	302	96	72	4	0	0

- Molecule 17 is a protein called 30S ribosomal protein S15.

Mol	Chain	Residues	Atoms					AltConf	Trace
			Total	C	N	O	S		
17	N	83	673	428	125	120		0	0

- Molecule 18 is a protein called 30S ribosomal protein S16.

Mol	Chain	Residues	Atoms					AltConf	Trace
			Total	C	N	O	S		
18	O	80	646	414	119	111	2	0	0

- Molecule 19 is a protein called 30S ribosomal protein S17.

Mol	Chain	Residues	Atoms					AltConf	Trace
			Total	C	N	O	S		
19	P	83	675	425	135	115		0	0

- Molecule 20 is a protein called 30S ribosomal protein S18.

Mol	Chain	Residues	Atoms					AltConf	Trace
			Total	C	N	O	S		
20	Q	65	535	342	103	86	4	0	0

- Molecule 21 is a protein called 30S ribosomal protein S19.

Mol	Chain	Residues	Atoms					AltConf	Trace
21	R	84	Total	C	N	O	S	0	0
			682	435	127	118	2		

- Molecule 22 is a protein called 30S ribosomal protein S20.

Mol	Chain	Residues	Atoms					AltConf	Trace
22	S	77	Total	C	N	O	S	0	0
			629	383	135	111			

- Molecule 23 is a protein called 30S ribosomal protein S21.

Mol	Chain	Residues	Atoms					AltConf	Trace
23	T	53	Total	C	N	O	S	0	0
			471	295	103	72	1		

- Molecule 24 is a protein called 50S ribosomal protein L2.

Mol	Chain	Residues	Atoms					AltConf	Trace
24	a	285	Total	C	N	O	S	0	0
			2225	1385	437	397	6		

- Molecule 25 is a protein called 50S ribosomal protein L3.

Mol	Chain	Residues	Atoms					AltConf	Trace
25	b	229	Total	C	N	O	S	0	0
			1762	1119	318	318	7		

- Molecule 26 is a protein called 50S ribosomal protein L4.

Mol	Chain	Residues	Atoms					AltConf	Trace
26	c	210	Total	C	N	O	S	0	0
			1644	1047	297	297	3		

- Molecule 27 is a protein called 50S ribosomal protein L5.

Mol	Chain	Residues	Atoms					AltConf	Trace
27	d	175	Total	C	N	O	S	0	0
			1388	893	245	246	4		

- Molecule 28 is a protein called 50S ribosomal protein L6.



Mol	Chain	Residues	Atoms				AltConf	Trace
28	e	176	Total	C	N	O	0	0
			1396	899	247	250		

- Molecule 29 is a protein called 50S ribosomal protein L9.

Mol	Chain	Residues	Atoms					AltConf	Trace
29	f	145	Total	C	N	O	S	0	0
			1182	763	206	210	3		

- Molecule 30 is a protein called 50S ribosomal protein L10.

Mol	Chain	Residues	Atoms					AltConf	Trace
30	g	126	Total	C	N	O	S	0	0
			960	612	167	178	3		

- Molecule 31 is a protein called 50S ribosomal protein L11.

Mol	Chain	Residues	Atoms					AltConf	Trace
31	h	128	Total	C	N	O	S	0	0
			959	616	160	177	6		

- Molecule 32 is a protein called 50S ribosomal protein L13.

Mol	Chain	Residues	Atoms					AltConf	Trace
32	i	144	Total	C	N	O	S	0	0
			1164	737	213	209	5		

- Molecule 33 is a protein called 50S ribosomal protein L14.

Mol	Chain	Residues	Atoms					AltConf	Trace
33	j	122	Total	C	N	O	S	0	0
			944	595	178	167	4		

- Molecule 34 is a protein called 50S ribosomal protein L15.

Mol	Chain	Residues	Atoms				AltConf	Trace
34	k	148	Total	C	N	O	0	0
			1153	731	226	196		

- Molecule 35 is a protein called 50S ribosomal protein L16.

Mol	Chain	Residues	Atoms					AltConf	Trace
			Total	C	N	O	S		
35	l	136	1079	694	196	182	7	0	0

- Molecule 36 is a protein called 50S ribosomal protein L17.

Mol	Chain	Residues	Atoms					AltConf	Trace
			Total	C	N	O	S		
36	m	119	958	609	175	171	3	0	0

- Molecule 37 is a protein called 50S ribosomal protein L18.

Mol	Chain	Residues	Atoms					AltConf	Trace
			Total	C	N	O	S		
37	n	112	889	557	175	155	2	0	0

- Molecule 38 is a protein called 50S ribosomal protein L19.

Mol	Chain	Residues	Atoms					AltConf	Trace
			Total	C	N	O	S		
38	o	115	938	592	180	165	1	0	0

- Molecule 39 is a protein called 50S ribosomal protein L20.

Mol	Chain	Residues	Atoms					AltConf	Trace
			Total	C	N	O	S		
39	p	114	947	603	188	154	2	0	0

- Molecule 40 is a protein called 50S ribosomal protein L21.

Mol	Chain	Residues	Atoms					AltConf	Trace
			Total	C	N	O	S		
40	q	99	811	525	148	134	4	0	0

- Molecule 41 is a protein called 50S ribosomal protein L22.

Mol	Chain	Residues	Atoms					AltConf	Trace
			Total	C	N	O	S		
41	r	139	1068	663	207	191	7	0	0

- Molecule 42 is a protein called 50S ribosomal protein L23.

Mol	Chain	Residues	Atoms					AltConf	Trace
42	s	92	Total	C	N	O	S	0	0
			720	475	122	122	1		

- Molecule 43 is a protein called 50S ribosomal protein L24.

Mol	Chain	Residues	Atoms					AltConf	Trace
43	t	111	Total	C	N	O	S	0	0
			872	550	166	153	3		

- Molecule 44 is a protein called 50S ribosomal protein L27.

Mol	Chain	Residues	Atoms					AltConf	Trace
44	u	86	Total	C	N	O	S	0	0
			657	409	130	117	1		

- Molecule 45 is a protein called 50S ribosomal protein L28.

Mol	Chain	Residues	Atoms					AltConf	Trace
45	v	63	Total	C	N	O	S	0	0
			513	317	108	87	1		

- Molecule 46 is a protein called 50S ribosomal protein L29.

Mol	Chain	Residues	Atoms				AltConf	Trace
46	w	100	Total	C	N	O	0	0
			818	517	153	148		

- Molecule 47 is a protein called 50S ribosomal protein L31.

Mol	Chain	Residues	Atoms					AltConf	Trace
47	x	44	Total	C	N	O	S	0	0
			344	221	55	64	4		

- Molecule 48 is a protein called 50S ribosomal protein L32.

Mol	Chain	Residues	Atoms					AltConf	Trace
48	y	56	Total	C	N	O	S	0	0
			452	274	98	75	5		

- Molecule 49 is a protein called 50S ribosomal protein L33 1.

Mol	Chain	Residues	Atoms					AltConf	Trace
49	z	50	Total	C	N	O	S	0	0
			408	255	81	68	4		

- Molecule 50 is a RNA chain called 23S ribosomal RNA.

Mol	Chain	Residues	Atoms					AltConf	Trace
50	3	2878	Total	C	N	O	P	0	0
			61664	27558	11236	19995	2875		

- Molecule 51 is a RNA chain called 5S ribosomal RNA.

Mol	Chain	Residues	Atoms					AltConf	Trace
51	4	105	Total	C	N	O	P	0	0
			2239	1003	409	724	103		

- Molecule 52 is a RNA chain called 16S ribosomal RNA.

Mol	Chain	Residues	Atoms					AltConf	Trace
52	5	1493	Total	C	N	O	P	0	0
			31943	14279	5792	10382	1490		

- Molecule 53 is a RNA chain called tRNA-Phe.

Mol	Chain	Residues	Atoms					AltConf	Trace
53	7	76	Total	C	N	O	P	0	0
			1618	723	289	531	75		
53	8	76	Total	C	N	O	P	0	0
			1618	723	289	531	75		

### 3 Residue-property plots [i](#)

These plots are drawn for all protein, RNA, DNA and oligosaccharide chains in the entry. The first graphic for a chain summarises the proportions of the various outlier classes displayed in the second graphic. The second graphic shows the sequence view annotated by issues in geometry and atom inclusion in map density. Residues are color-coded according to the number of geometric quality criteria for which they contain at least one outlier: green = 0, yellow = 1, orange = 2 and red = 3 or more. A red diamond above a residue indicates a poor fit to the EM map for this residue (all-atom inclusion < 40%). Stretches of 2 or more consecutive residues without any outlier are shown as a green connector. Residues present in the sample, but not in the model, are shown in grey.

- Molecule 1: 50S ribosomal protein L34

Chain 0:  98%

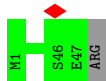

- Molecule 2: 50S ribosomal protein L35

Chain 1:  100%

There are no outlier residues recorded for this chain.

- Molecule 3: 50S ribosomal protein L36

Chain 2:  100%

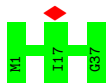

- Molecule 4: 30S ribosomal protein S2

Chain A:  39% 81% 18%

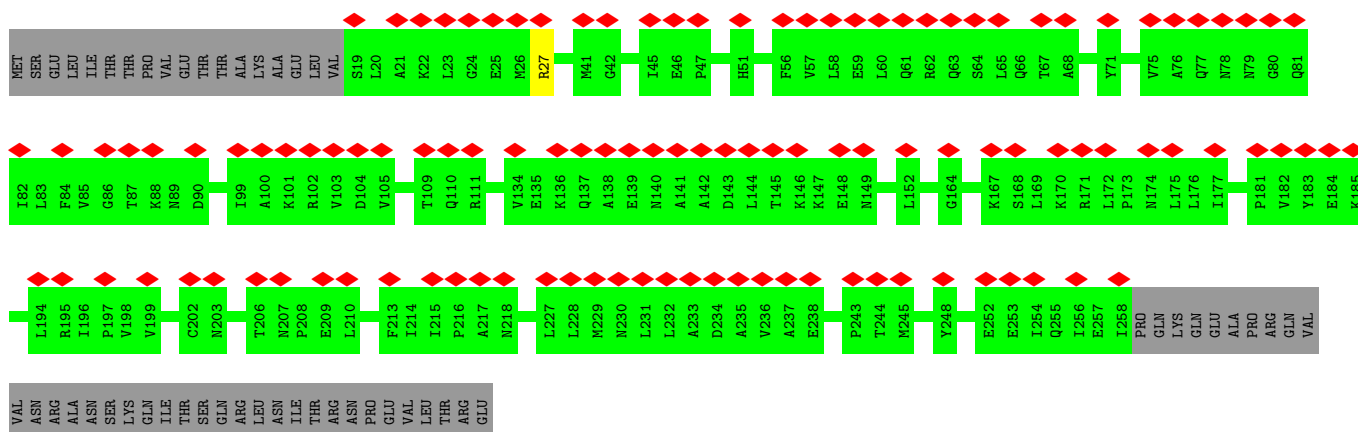

• Molecule 5: 30S ribosomal protein S3

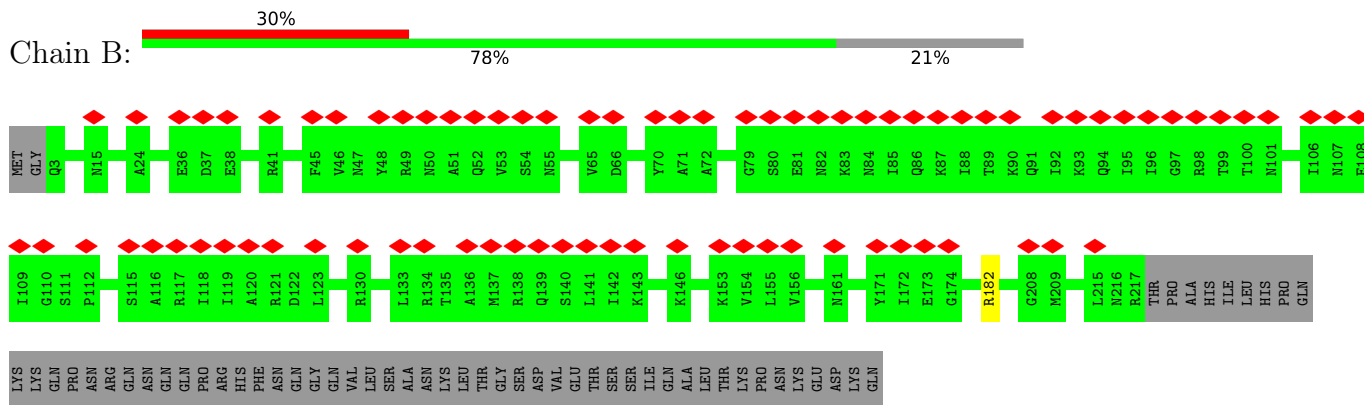

• Molecule 6: 30S ribosomal protein S4

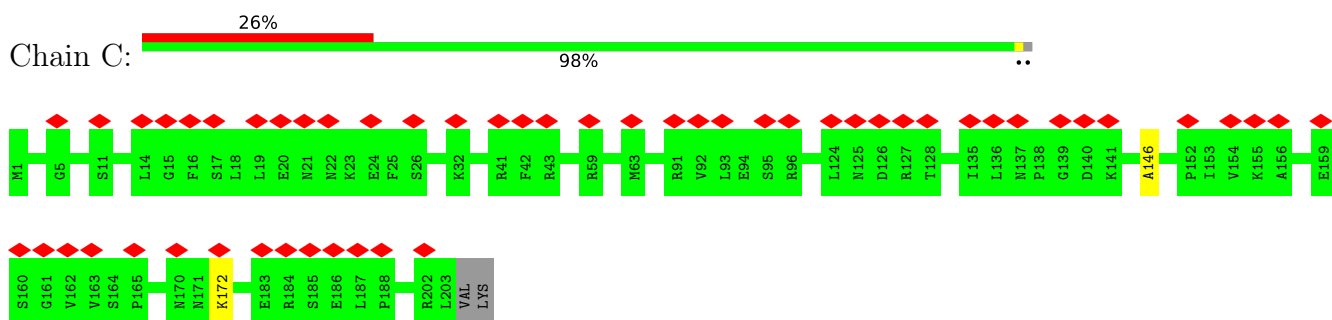

• Molecule 7: 30S ribosomal protein S5

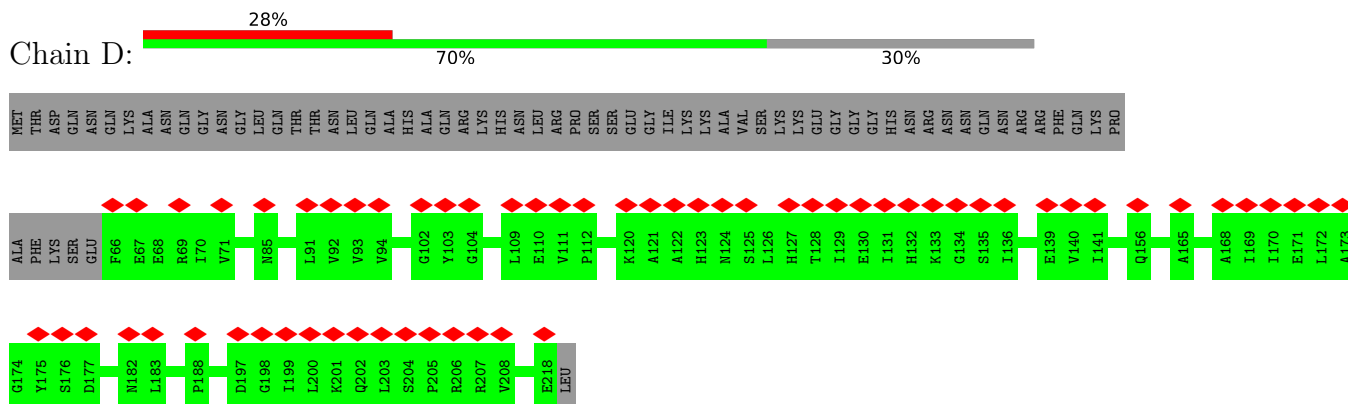

• Molecule 8: 30S ribosomal protein S6

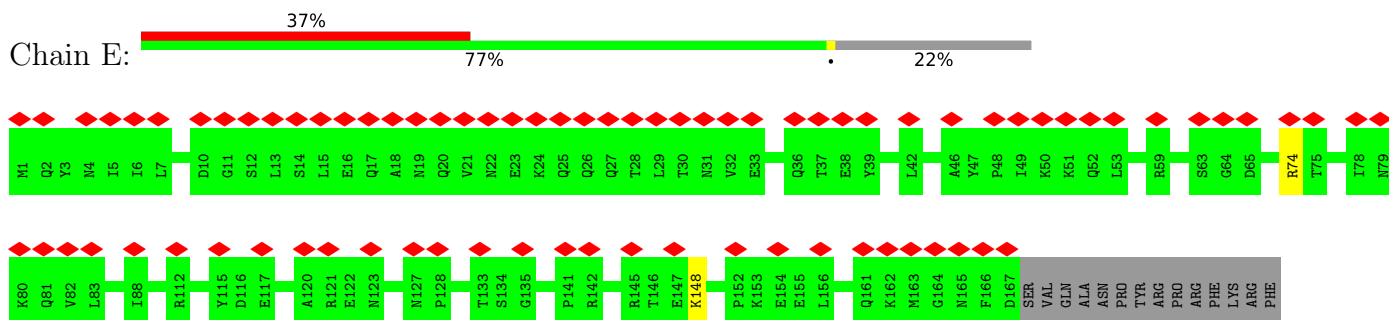

ASN  
ALA  
GLU  
HIS  
VAL  
ASN  
GLN  
ARG  
GLN  
ASN  
GLN  
ASN  
ASN  
ASN  
ASN  
ARG  
PHE  
ASP  
ARG  
ASN  
ARG  
ASN  
ASN  
GLN  
GLN  
HIS  
ASN  
ARG  
PHE  
LYS  
ASP  
LYS  
GLN

- Molecule 9: 30S ribosomal protein S7



- Molecule 10: 30S ribosomal protein S8

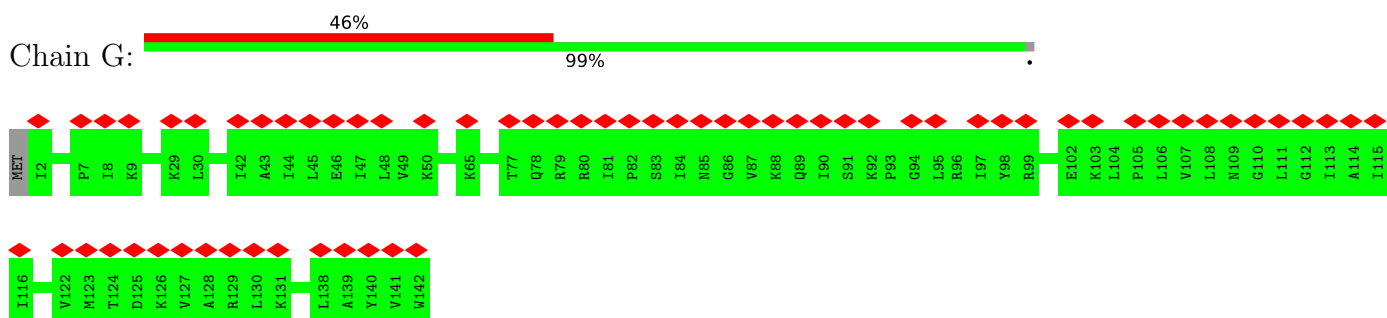

- Molecule 11: 30S ribosomal protein S9

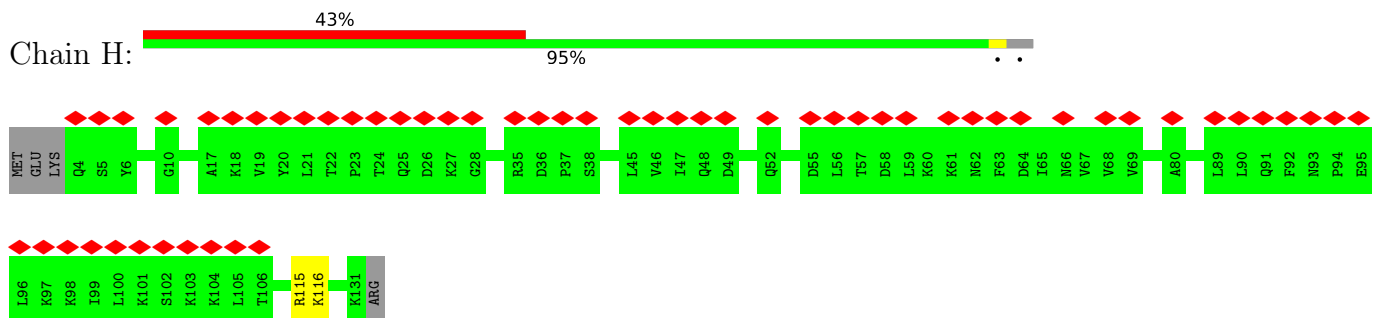

- Molecule 12: 30S ribosomal protein S10

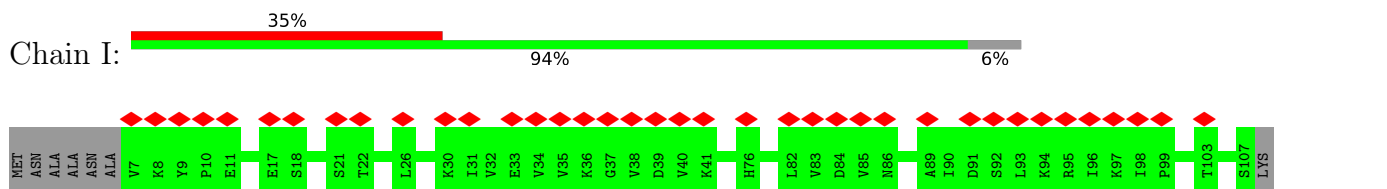

- Molecule 13: 30S ribosomal protein S11

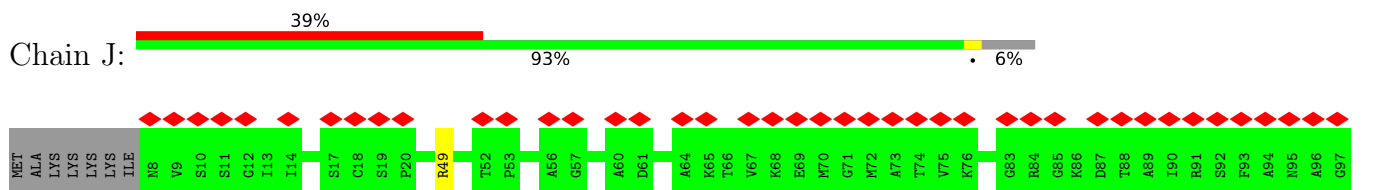



- Molecule 14: 30S ribosomal protein S12

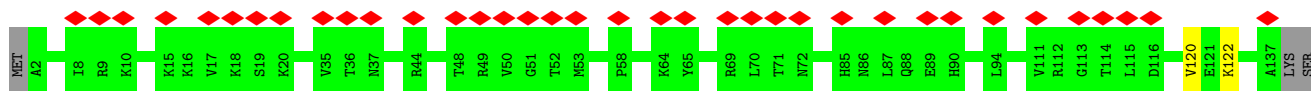

- Molecule 15: 30S ribosomal protein S13

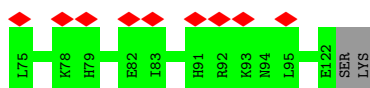
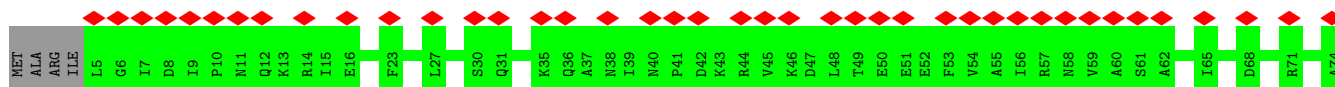
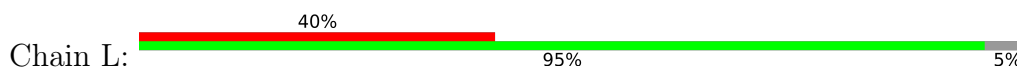

- Molecule 16: 30S ribosomal protein S14 type Z



- Molecule 17: 30S ribosomal protein S15

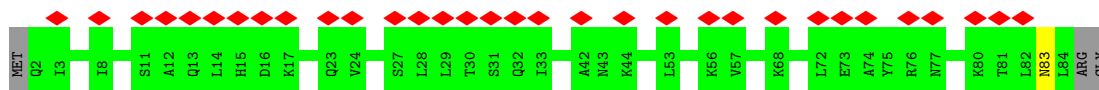

- Molecule 18: 30S ribosomal protein S16

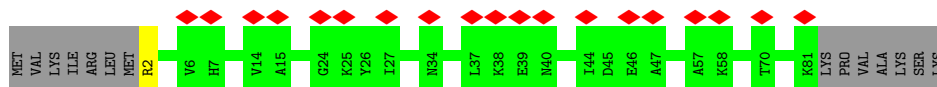
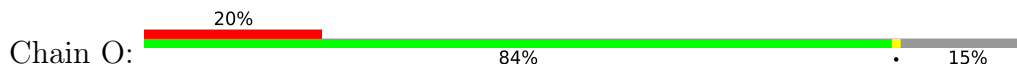

- Molecule 19: 30S ribosomal protein S17





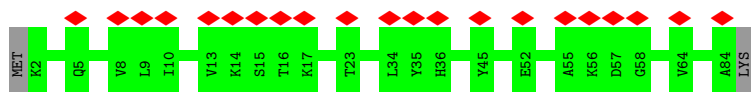

- Molecule 20: 30S ribosomal protein S18

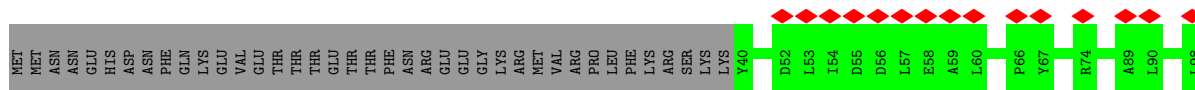

- Molecule 21: 30S ribosomal protein S19

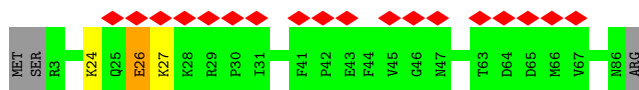

- Molecule 22: 30S ribosomal protein S20

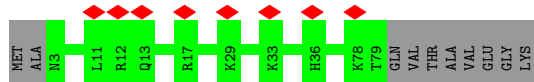
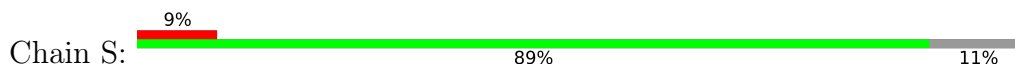

- Molecule 23: 30S ribosomal protein S21

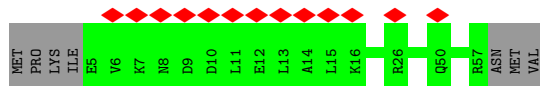
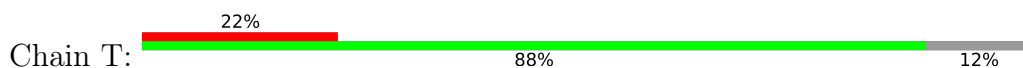

- Molecule 24: 50S ribosomal protein L2

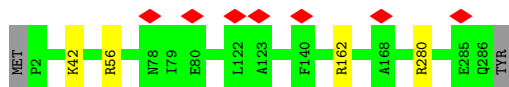

- Molecule 25: 50S ribosomal protein L3

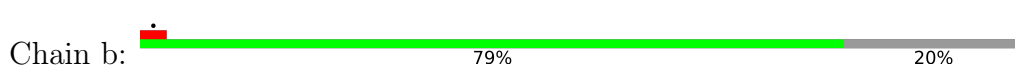

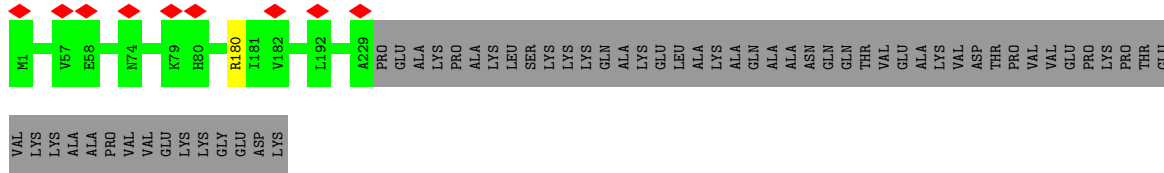

• Molecule 26: 50S ribosomal protein L4

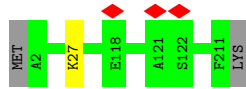

• Molecule 27: 50S ribosomal protein L5

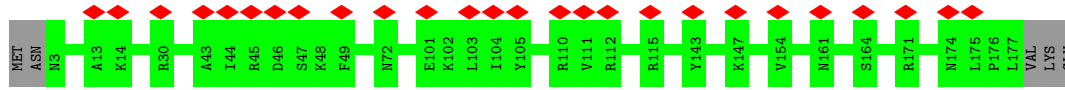

• Molecule 28: 50S ribosomal protein L6

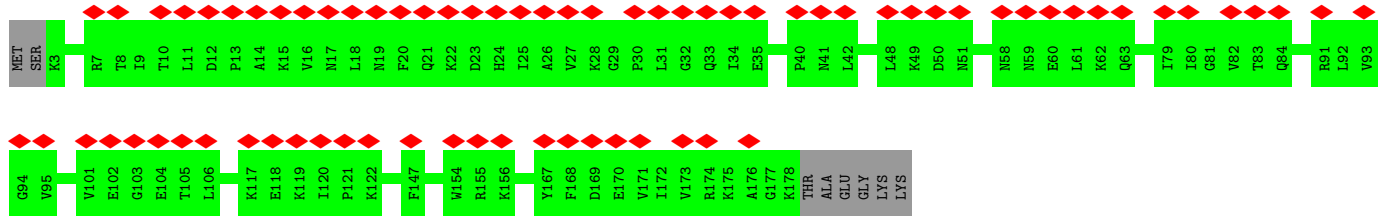
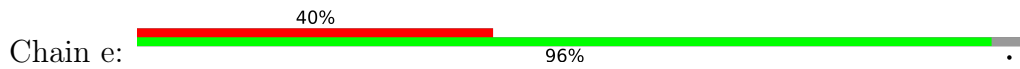

• Molecule 29: 50S ribosomal protein L9

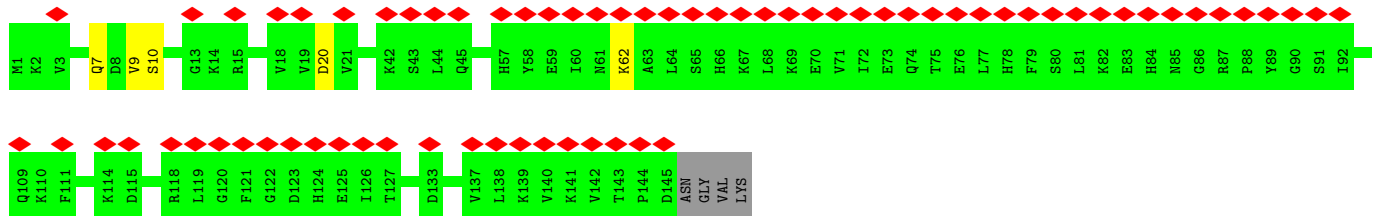
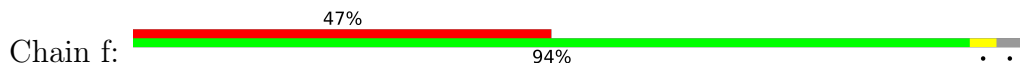

• Molecule 30: 50S ribosomal protein L10

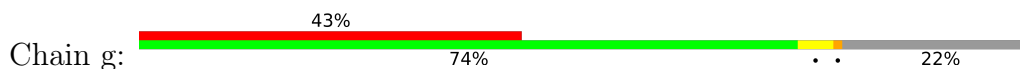

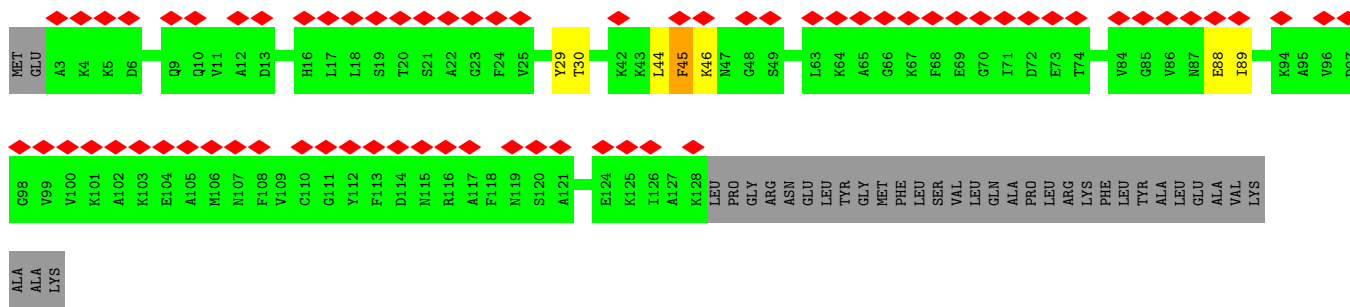

• Molecule 31: 50S ribosomal protein L11

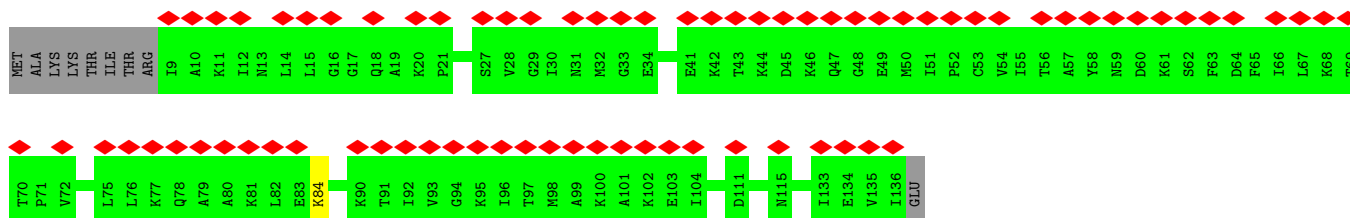
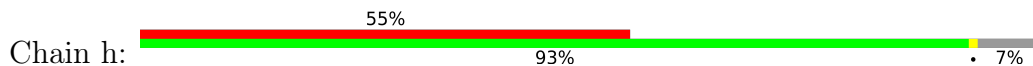

• Molecule 32: 50S ribosomal protein L13

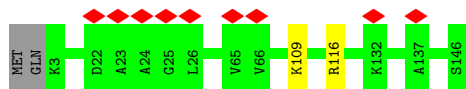

• Molecule 33: 50S ribosomal protein L14

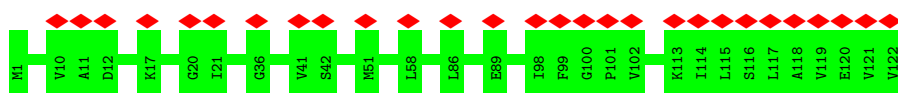

• Molecule 34: 50S ribosomal protein L15

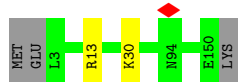

• Molecule 35: 50S ribosomal protein L16



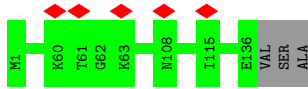

- Molecule 36: 50S ribosomal protein L17

Chain m: 96%

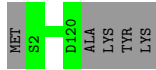

- Molecule 37: 50S ribosomal protein L18

Chain n: 6% 96%

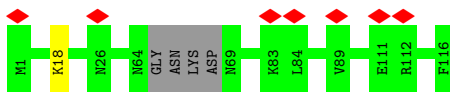

- Molecule 38: 50S ribosomal protein L19

Chain o: 19% 97%

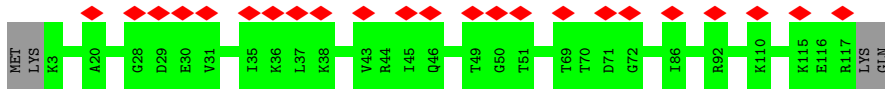

- Molecule 39: 50S ribosomal protein L20

Chain p: 9% 90% 10%

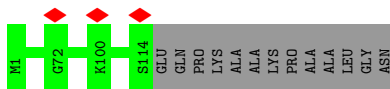

- Molecule 40: 50S ribosomal protein L21

Chain q: 9% 98%

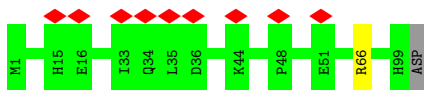

- Molecule 41: 50S ribosomal protein L22

Chain r: 87% 13%

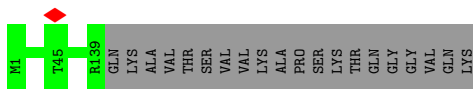

- Molecule 42: 50S ribosomal protein L23

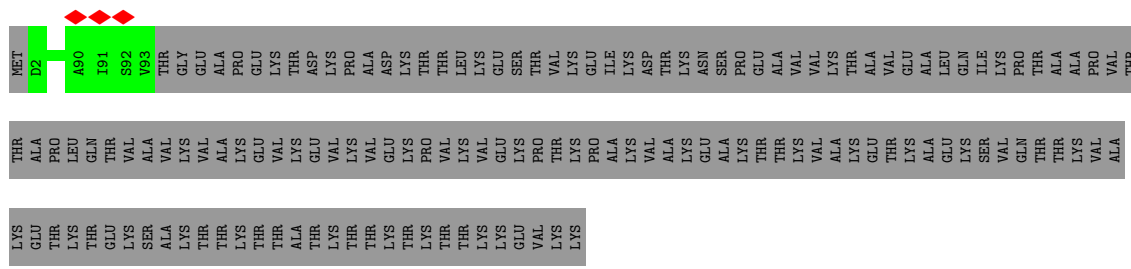

● Molecule 43: 50S ribosomal protein L24

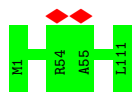

● Molecule 44: 50S ribosomal protein L27

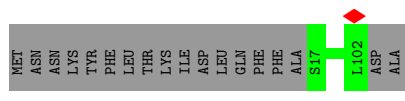
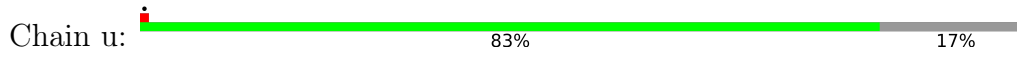

● Molecule 45: 50S ribosomal protein L28

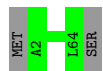

● Molecule 46: 50S ribosomal protein L29

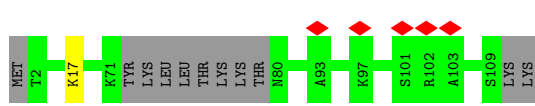
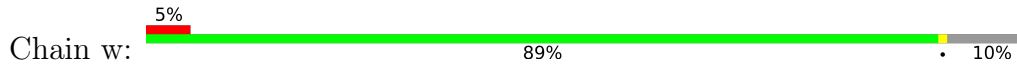

● Molecule 47: 50S ribosomal protein L31

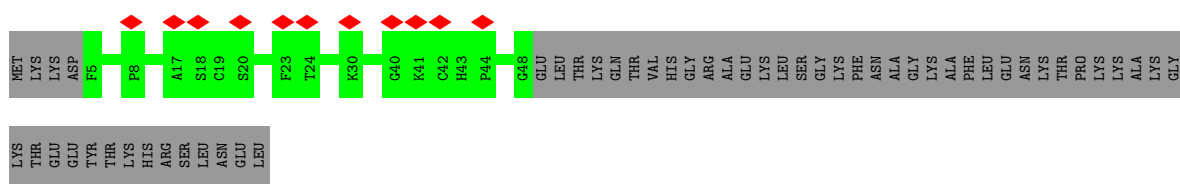
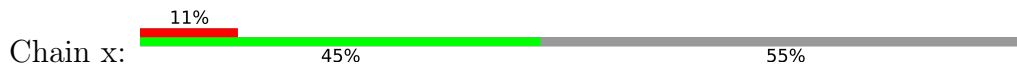

• Molecule 48: 50S ribosomal protein L32

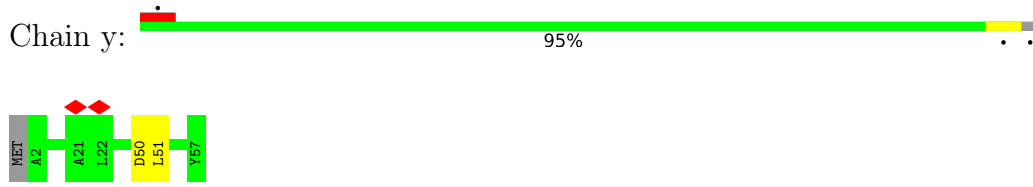

• Molecule 49: 50S ribosomal protein L33 1

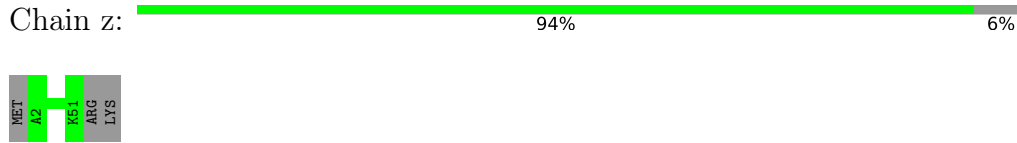

• Molecule 50: 23S ribosomal RNA

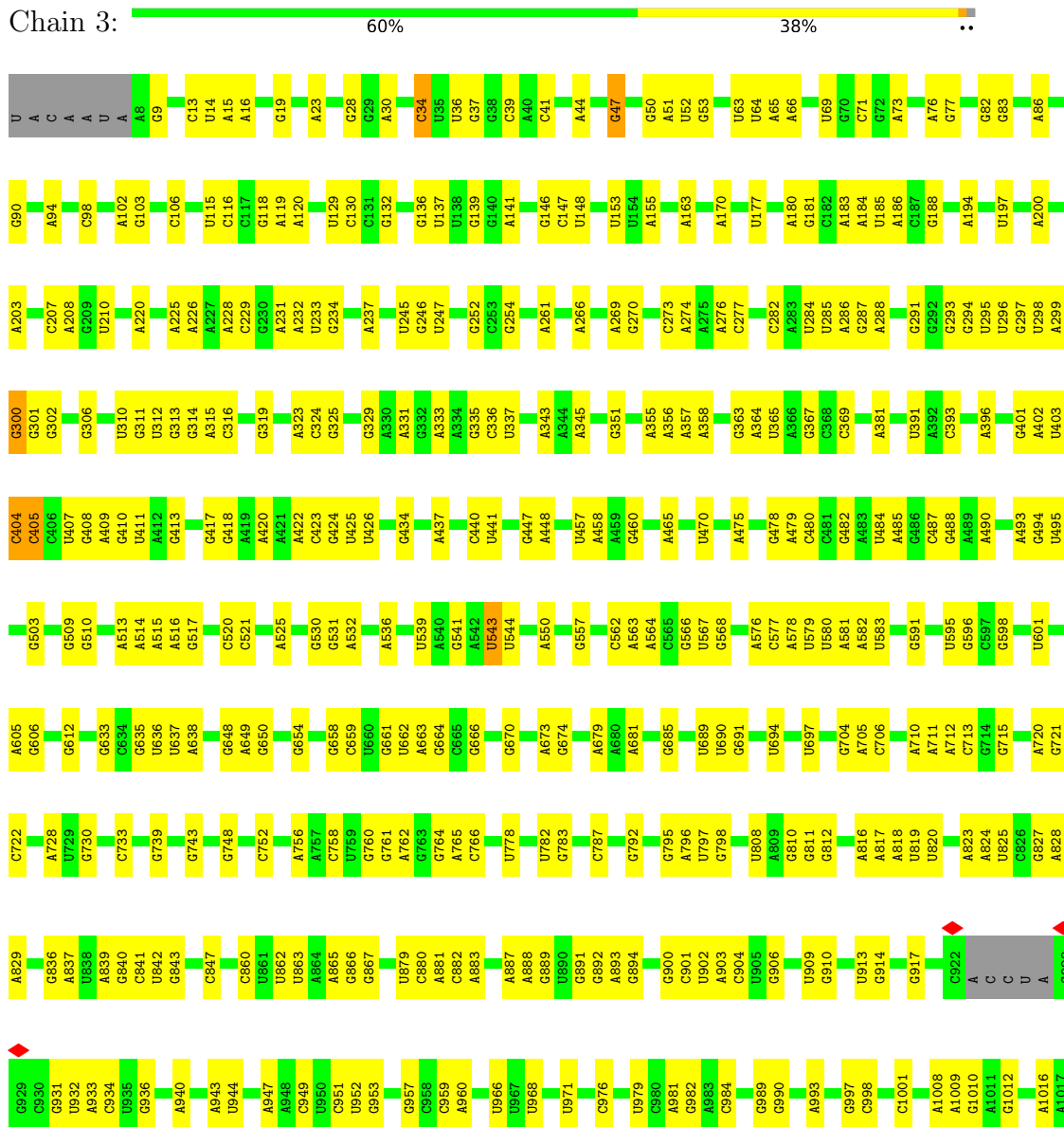

A2277	A2178	A2084	C1997	U1764	A1874	G1579	U1467	U1368	A1284	A1202	U1113	G1018
U2280	A2179	G2087	U1998	G1765	U1678	G1580	C1474	U1369	U1285	G1203	G1114	A1019
A2281	U2180	U2094	G1999	A1766	U1679	G1581	C1475	U1370	G1286	A1204	G1115	C1020
A2282	U2181	U2095	U2000	A1767	U1680	U1582	U1478	U1205	C1287	U1206	G1122	A1024
A2286	C2185	U2099	C2001	A1769	G1681	U1583	A1479	U1206	C1291	U1209	G1123	G1025
A2287	C2186	G2100	G2004	A1770	C1682	U1584	A1480	U1206	A1292	U1209	G1124	A1026
G2288	C2187	G2100	G2005	A1780	G1683	U1585	U1481	U1206	G1296	A1210	U1125	U1027
G2289	U2188	G2105	A2008	U1784	G1687	A1588	U1482	C1378	G1296	G1215	G1128	C1028
G2290	G2106	A2107	U1921	A1788	A1688	A1589	G1484	C1378	U1297	U1216	U1298	U1029
U2291	G2107	U2110	G2011	A1789	A1689	A1590	A1485	A1381	U1298	G1217	U1031	U1030
U2292	U2111	U2111	G2016	C1789	G1694	G1591	A1486	G1386	A1299	G2218	C1132	U1031
U2293	U2112	A2112	U1924	U1790	G1695	G1592	U1487	G1387	C1300	G2218	C1137	A1032
A2295	U2195	U2113	A1925	A1791	G1698	C1595	U1488	G1388	G1301	A1219	A1138	U1035
A2300	G2198	C2114	A1928	A1794	U1698	U1596	G1489	G1388	U1302	A1220	C1139	U1035
U2304	C2199	G2117	G1928	A1794	G1701	G1597	A1493	A1393	U1303	G1221	G1142	G1039
G2312	U2118	G2117	G1936	C1797	A1702	A1600	U1494	A1386	G1306	A1225	G1145	U1040
U2313	A2119	U2118	G1937	G1806	A1703	A1601	A1497	A1386	G1307	G1226	G1146	A1046
U2320	U2202	U2119	U1938	C1807	U1705	A1603	A1497	A1406	A1315	U1229	A1146	A1046
U2314	U2203	A2136	A1945	C1808	U1706	A1608	G1507	A1407	A1316	U1229	G1147	A1046
G2315	A2206	A2137	A1946	G1808	U1707	C1608	G1508	G1408	U1316	U1229	U1148	A1047
G2316	U2211	A2138	U1946	A1809	G1708	C1609	U1509	G1409	C1317	U1234	G1149	A1048
A2317	G2211	G2127	C1949	C1813	C1709	G1611	A1510	A1410	U1317	U1235	U1150	U1049
A2318	U2212	G2134	U1950	G1814	A1710	U1612	U1514	C1411	A1322	G1236	U1154	U1054
U2319	G2201	A2135	A1951	U1815	A1712	G1615	U1514	A1412	A1323	U1240	G1155	A1055
U2320	U2202	A2136	G1952	A1816	U1713	G1616	A1520	C1413	C1325	U1241	G1155	A1055
C2321	U2203	A2137	U1953	A1816	U1714	U1617	A1521	C1414	G1325	G1242	G1158	G1060
G2326	A2206	A2138	U1953	G1821	U1715	U1618	U1522	A1415	A1328	G1245	U1162	A1061
A2330	U2211	U2139	G1956	A1822	A1716	U1619	G1528	A1420	U1329	U1246	A1162	U1068
U2332	G2217	G2143	U1957	U1823	C1717	A1641	U1528	U1422	U1330	U1246	G1163	U1068
U2333	U2218	A2143	G1958	A1826	C1718	G1642	U1533	A1423	A1332	A1250	A1166	G1073
U2334	A2231	C2144	A1959	U1827	G1719	A1643	U1534	U1424	A1333	G1251	G1167	A1074
A2335	G2232	A2145	A1960	A1828	G1720	A1644	A1535	U1425	U1334	C1252	U1167	A1074
G2338	U2142	A2146	A1961	G1831	G1721	A1645	A1535	C1426	A1336	G1253	A1168	U1075
U2342	U2143	G2147	U1962	G1831	U1727	C1645	A1541	C1427	U1340	U1254	G1170	U1075
A2343	C2150	A2148	C1964	A1836	A1728	A1646	A1548	C1432	U1341	G1255	C1171	A1080
G2349	G2062	G2063	C1965	A1836	G1729	A1647	A1549	C1435	C1342	A1257	G1171	A1081
U2352	G2064	G2064	U1967	G1842	C1730	A1649	G1550	A1435	G1345	C1258	C1175	A1082
G2353	A2067	G2068	C1968	C1843	G1733	C1651	G1555	C1444	G1345	A1259	U1176	C1084
A2354	G2068	A2069	C1969	C1844	A1734	A1652	G1555	C1444	A1350	G1265	A1177	A1088
U2358	C2070	C2071	C1970	A1868	G1737	G1653	A1558	G1446	G1351	G1265	A1178	A1088
A2362	C2072	G2075	C1972	G1868	G1738	U1655	A1559	A1447	G1352	A1267	G1179	A1088
C2363	U1981	U2075	U1973	G1870	G1741	A1656	U	A1455	G1353	U1268	U1180	U1095
A2377	U1982	G2076	U1974	U1871	G1742	A1660	G	C1456	U1354	A1274	A1181	U1096
	U1983	G2076	A1977	U1872	G1743	A1661	A	C1456	C1355	A1274	C1187	G1097
	A1984	G2076	A1978	A1873	U1748	A1661	C	A1457	G1356	A1277	C1188	U1101
		G2076	U1979	G1876	A1749	A1669	U	A1458	U1357	A1277	G1189	A1102
		G2076	G1980	A1884	A1750	A1669	C	A1459	C1358	G1278	G1189	G1103
		G2076	U1981	A1884	A1751	A1669	A	A1459	C1359	U1279	A1190	A1104
		G2076	U1982	A1884	A1751	A1669	U	G1463	U1360	G2280	A1191	A1104
		G2076	U1983	C1900	C1761	C1671	C	G1464	U1361	A1281	U1192	G1106
		G2076	A1984	C1900	C1761	U1673	A	A1466	C1363	A1283	G1196	C1107

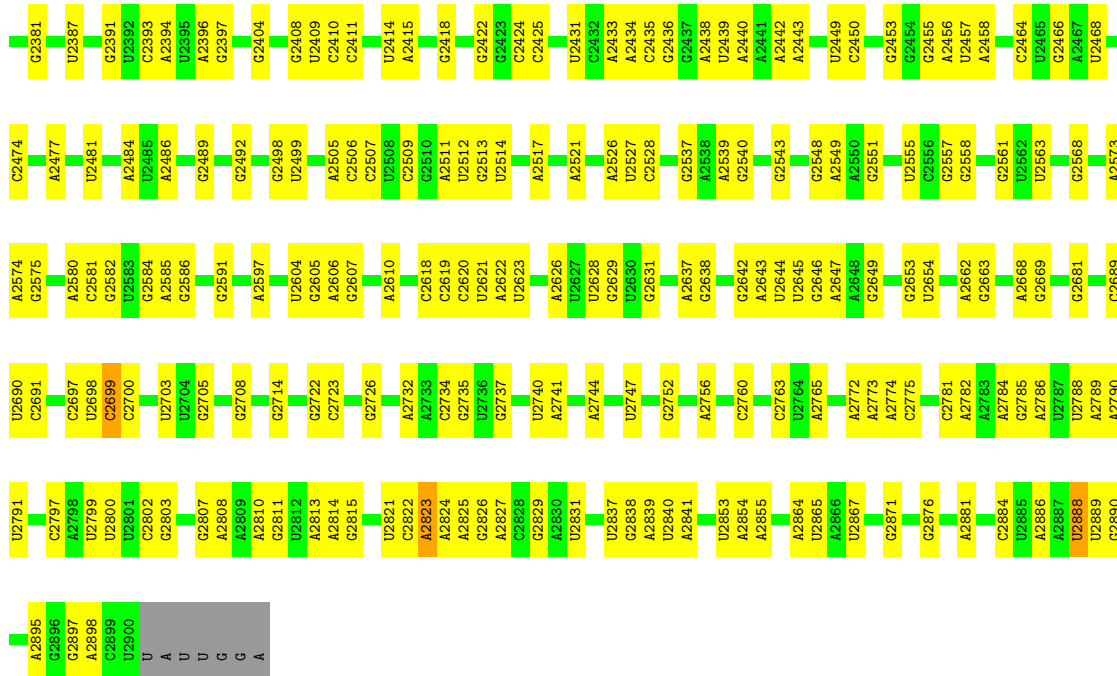

• Molecule 51: 5S ribosomal RNA

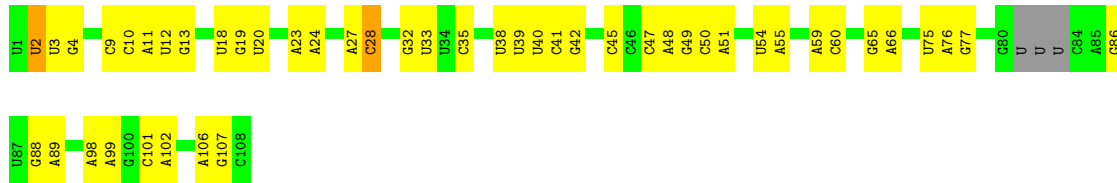

• Molecule 52: 16S ribosomal RNA

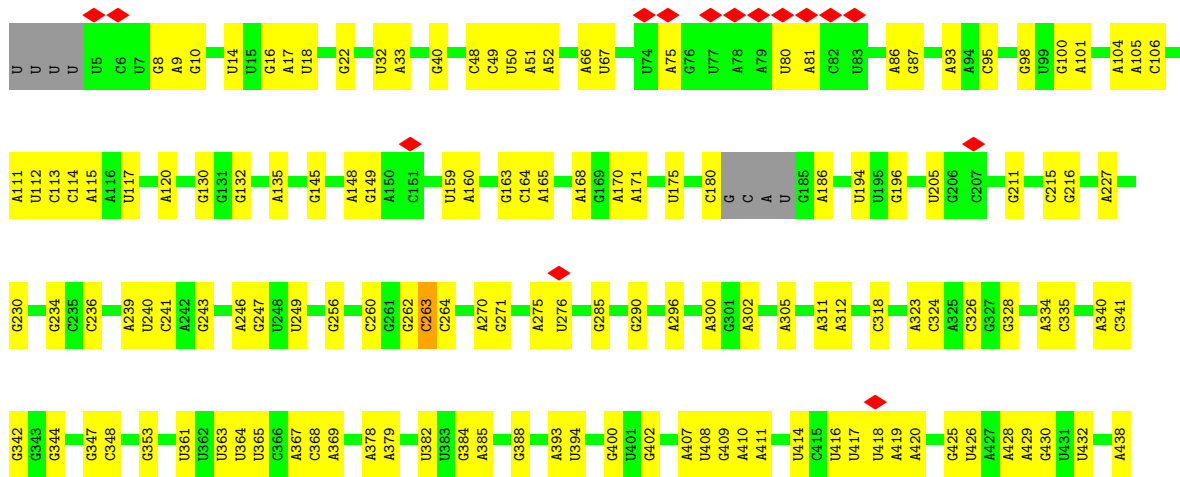



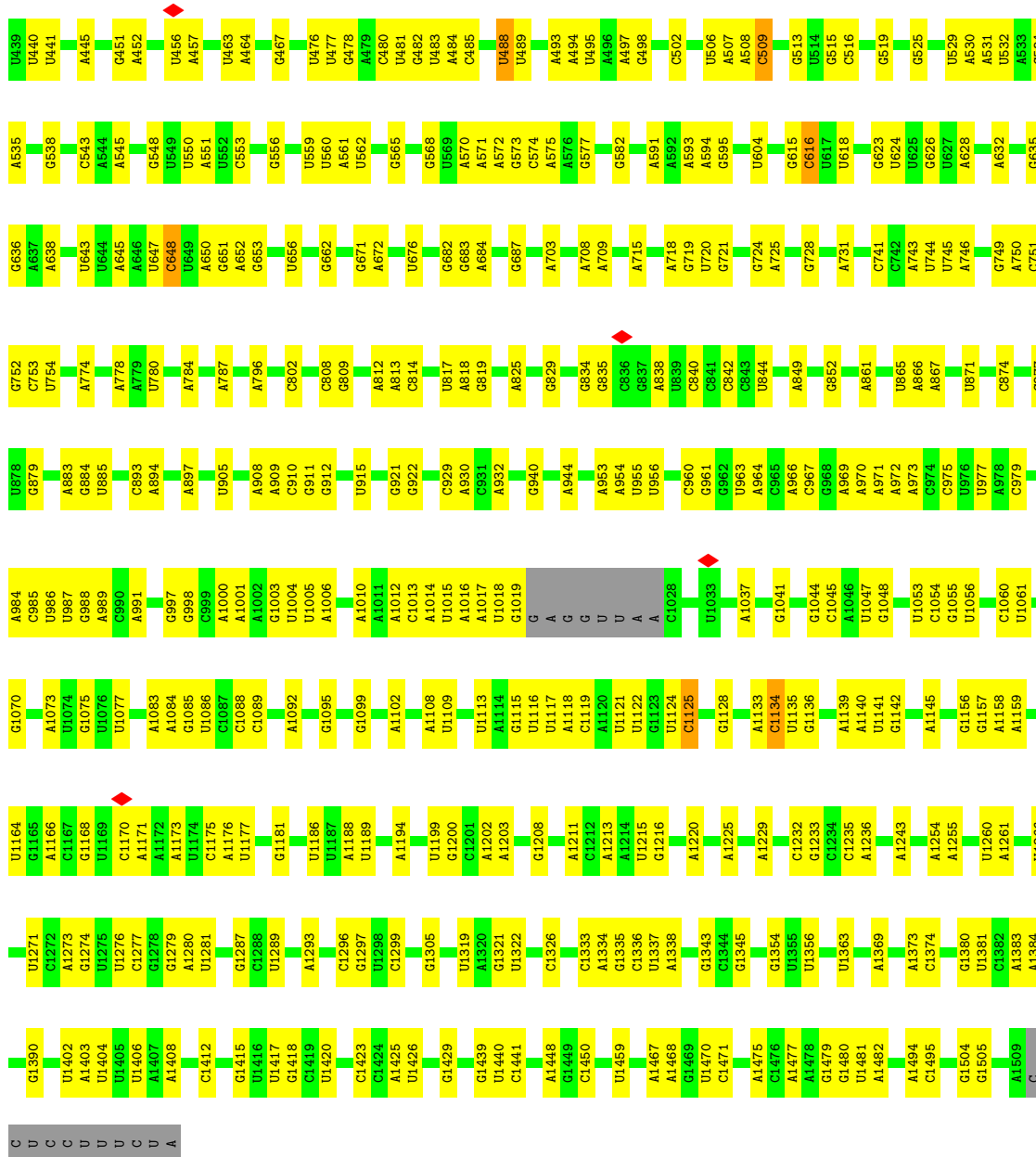

● Molecule 53: tRNA-Phe

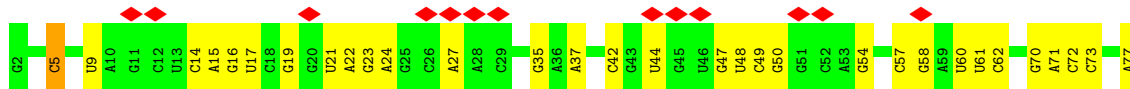

● Molecule 53: tRNA-Phe

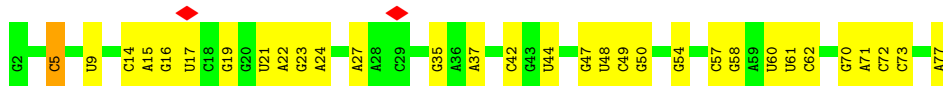

## 4 Experimental information

Property	Value	Source
EM reconstruction method	SUBTOMOGRAM AVERAGING	Depositor
Imposed symmetry	POINT, C1	Depositor
Number of subtomograms used	1119	Depositor
Resolution determination method	FSC 0.143 CUT-OFF	Depositor
CTF correction method	PHASE FLIPPING AND AMPLITUDE CORRECTION	Depositor
Microscope	FEI TITAN KRIOS	Depositor
Voltage (kV)	300	Depositor
Electron dose ( $e^-/\text{\AA}^2$ )	3.2	Depositor
Minimum defocus (nm)	1500	Depositor
Maximum defocus (nm)	3750	Depositor
Magnification	81000	Depositor
Image detector	GATAN K3 (6k x 4k)	Depositor
Maximum map value	0.743	Depositor
Minimum map value	-0.278	Depositor
Average map value	0.015	Depositor
Map value standard deviation	0.069	Depositor
Recommended contour level	0.22	Depositor
Map size (Å)	435.328, 435.328, 435.328	wwPDB
Map dimensions	256, 256, 256	wwPDB
Map angles (°)	90.0, 90.0, 90.0	wwPDB
Pixel spacing (Å)	1.7005, 1.7005, 1.7005	Depositor

## 5 Model quality [i](#)

### 5.1 Standard geometry [i](#)

The Z score for a bond length (or angle) is the number of standard deviations the observed value is removed from the expected value. A bond length (or angle) with  $|Z| > 5$  is considered an outlier worth inspection. RMSZ is the root-mean-square of all Z scores of the bond lengths (or angles).

Mol	Chain	Bond lengths		Bond angles	
		RMSZ	# Z  >5	RMSZ	# Z  >5
1	0	0.25	0/383	0.49	0/504
2	1	0.24	0/484	0.45	0/637
3	2	0.24	0/306	0.53	0/401
4	A	0.26	0/1954	0.45	0/2642
5	B	0.25	0/1721	0.46	0/2323
6	C	0.25	0/1691	0.45	0/2267
7	D	0.24	0/1188	0.47	0/1593
8	E	0.29	0/1384	0.48	0/1867
9	F	0.24	0/1266	0.48	0/1700
10	G	0.25	0/1126	0.48	0/1517
11	H	0.26	0/1044	0.51	0/1395
12	I	0.25	0/820	0.50	0/1103
13	J	0.26	0/844	0.47	0/1136
14	K	0.29	0/1094	0.51	0/1468
15	L	0.24	0/962	0.45	0/1289
16	M	0.26	0/483	0.45	0/643
17	N	0.24	0/679	0.48	0/907
18	O	0.25	0/659	0.48	0/885
19	P	0.24	0/684	0.47	0/913
20	Q	0.25	0/545	0.46	0/730
21	R	0.29	0/698	0.51	0/936
22	S	0.24	0/631	0.43	0/838
23	T	0.23	0/475	0.43	0/621
24	a	0.25	0/2267	0.49	0/3044
25	b	0.26	0/1795	0.47	0/2412
26	c	0.24	0/1671	0.45	0/2246
27	d	0.25	0/1409	0.45	0/1894
28	e	0.25	0/1420	0.48	0/1912
29	f	0.28	0/1205	0.56	1/1616 (0.1%)
30	g	0.33	0/969	0.57	0/1295
31	h	0.26	0/968	0.45	0/1298
32	i	0.24	0/1186	0.45	0/1592
33	j	0.24	0/953	0.50	0/1275
34	k	0.26	0/1170	0.49	0/1559

Mol	Chain	Bond lengths		Bond angles	
		RMSZ	# Z  >5	RMSZ	# Z  >5
35	l	0.25	0/1104	0.43	0/1481
36	m	0.24	0/973	0.46	0/1309
37	n	0.24	0/897	0.48	0/1198
38	o	0.25	0/948	0.47	0/1262
39	p	0.26	0/961	0.42	0/1278
40	q	0.26	0/828	0.48	0/1111
41	r	0.26	0/1077	0.44	0/1441
42	s	0.24	0/732	0.50	0/988
43	t	0.26	0/879	0.48	0/1165
44	u	0.24	0/665	0.46	0/884
45	v	0.30	0/519	0.52	0/695
46	w	0.24	0/826	0.41	0/1104
47	x	0.25	0/353	0.46	0/474
48	y	0.28	0/457	0.50	0/601
49	z	0.24	0/412	0.47	0/547
50	3	0.25	0/69073	0.91	111/107710 (0.1%)
51	4	0.23	0/2505	0.87	4/3902 (0.1%)
52	5	0.24	0/35768	0.88	40/55764 (0.1%)
53	7	0.27	0/1808	0.96	2/2817 (0.1%)
53	8	0.27	0/1808	0.96	2/2817 (0.1%)
All	All	0.25	0/158727	0.81	160/237006 (0.1%)

There are no bond length outliers.

All (160) bond angle outliers are listed below:

Mol	Chain	Res	Type	Atoms	Z	Observed(°)	Ideal(°)
50	3	1359	C	N3-C2-O2	-11.32	113.98	121.90
50	3	404	C	N1-C2-O2	10.59	125.26	118.90
50	3	405	C	C6-N1-C2	-9.99	116.30	120.30
52	5	616	C	C2-N1-C1'	9.92	129.71	118.80
50	3	2620	C	N3-C2-O2	-9.79	115.05	121.90
50	3	1359	C	N1-C2-O2	9.49	124.59	118.90
50	3	405	C	N3-C2-O2	-9.41	115.31	121.90
52	5	1134	C	N3-C2-O2	-9.11	115.52	121.90
52	5	263	C	N1-C2-O2	8.93	124.25	118.90
50	3	2199	C	N3-C2-O2	-8.91	115.66	121.90
50	3	1718	C	N3-C2-O2	-8.79	115.75	121.90
50	3	2199	C	N1-C2-O2	8.62	124.07	118.90
52	5	264	C	N3-C2-O2	-8.62	115.87	121.90
50	3	1188	C	N3-C2-O2	-8.38	116.04	121.90
52	5	1134	C	N1-C2-O2	8.27	123.86	118.90
50	3	1363	C	N3-C2-O2	-8.21	116.15	121.90

*Continued on next page...*

*Continued from previous page...*

Mol	Chain	Res	Type	Atoms	Z	Observed(°)	Ideal(°)
50	3	404	C	C2-N1-C1'	8.19	127.81	118.80
52	5	1134	C	C6-N1-C2	-7.94	117.12	120.30
50	3	34	C	N3-C2-O2	-7.92	116.35	121.90
50	3	2425	C	N3-C2-O2	-7.87	116.39	121.90
50	3	1718	C	N1-C2-O2	7.87	123.62	118.90
50	3	1507	G	O4'-C1'-N9	7.71	114.36	108.20
50	3	2620	C	N1-C2-O2	7.64	123.48	118.90
50	3	659	C	N3-C2-O2	-7.53	116.63	121.90
52	5	488	U	C2-N1-C1'	7.51	126.71	117.70
50	3	47	G	C5-C6-O6	7.50	133.10	128.60
50	3	758	C	N3-C2-O2	-7.44	116.69	121.90
50	3	1188	C	C6-N1-C2	-7.42	117.33	120.30
52	5	263	C	C2-N1-C1'	7.40	126.94	118.80
50	3	47	G	N1-C6-O6	-7.39	115.46	119.90
52	5	509	C	C6-N1-C2	-7.38	117.35	120.30
50	3	2781	C	N3-C2-O2	-7.37	116.74	121.90
50	3	1235	U	C2-N1-C1'	7.36	126.53	117.70
50	3	2781	C	N1-C2-O2	7.26	123.26	118.90
50	3	1813	C	N3-C2-O2	-7.26	116.82	121.90
50	3	115	U	C2-N1-C1'	7.26	126.41	117.70
52	5	616	C	N1-C2-O2	7.25	123.25	118.90
52	5	648	C	N1-C2-O2	7.21	123.23	118.90
50	3	2700	C	N3-C2-O2	-7.17	116.88	121.90
52	5	648	C	N3-C2-O2	-7.16	116.89	121.90
50	3	1432	C	N3-C2-O2	-7.13	116.91	121.90
50	3	1235	U	N3-C2-O2	-7.11	117.22	122.20
52	5	502	C	N1-C2-O2	7.09	123.15	118.90
50	3	301	G	N3-C4-N9	7.08	130.25	126.00
50	3	2148	U	C2-N1-C1'	7.04	126.15	117.70
50	3	1358	C	N1-C2-O2	7.01	123.11	118.90
52	5	616	C	C6-N1-C1'	-6.99	112.41	120.80
50	3	404	C	C6-N1-C1'	-6.96	112.45	120.80
50	3	543	U	C2-N1-C1'	6.88	125.95	117.70
50	3	482	G	O4'-C1'-N9	6.79	113.63	108.20
52	5	488	U	N1-C2-O2	6.76	127.53	122.80
50	3	404	C	N3-C2-O2	-6.73	117.19	121.90
50	3	1999	G	O4'-C1'-N9	-6.70	102.84	108.20
50	3	1719	C	N3-C2-O2	-6.65	117.25	121.90
50	3	1235	U	N1-C2-O2	6.64	127.45	122.80
50	3	2148	U	N1-C2-O2	6.63	127.44	122.80
50	3	758	C	N1-C2-O2	6.63	122.88	118.90
52	5	318	C	N3-C2-O2	-6.61	117.27	121.90

*Continued on next page...*

*Continued from previous page...*

Mol	Chain	Res	Type	Atoms	Z	Observed(°)	Ideal(°)
50	3	301	G	N3-C4-C5	-6.58	125.31	128.60
52	5	1134	C	C2-N1-C1'	6.55	126.00	118.80
50	3	1844	C	N3-C2-O2	-6.54	117.33	121.90
50	3	1359	C	C6-N1-C2	-6.47	117.71	120.30
52	5	263	C	C6-N1-C1'	-6.47	113.04	120.80
50	3	1968	C	N1-C2-O2	6.44	122.76	118.90
52	5	335	C	N3-C2-O2	-6.44	117.39	121.90
50	3	2105	G	N3-C4-N9	6.39	129.84	126.00
50	3	405	C	N1-C2-N3	6.36	123.65	119.20
52	5	318	C	N1-C2-O2	6.33	122.70	118.90
50	3	1909	C	N1-C2-O2	6.30	122.68	118.90
50	3	2699	C	N1-C2-O2	6.30	122.68	118.90
50	3	1709	C	N1-C2-O2	6.29	122.68	118.90
50	3	1997	C	N3-C2-O2	-6.28	117.50	121.90
50	3	2424	C	N1-C2-O2	6.27	122.66	118.90
52	5	488	U	N3-C2-O2	-6.23	117.84	122.20
50	3	1997	C	N1-C2-O2	6.22	122.63	118.90
50	3	2064	G	C5-C6-O6	6.20	132.32	128.60
52	5	264	C	C6-N1-C2	-6.18	117.83	120.30
50	3	521	C	N3-C2-O2	-6.12	117.62	121.90
52	5	616	C	C6-N1-C2	-6.10	117.86	120.30
50	3	1964	C	N3-C2-O2	-6.09	117.64	121.90
50	3	1427	C	C2-N1-C1'	6.08	125.49	118.80
50	3	879	U	N1-C2-O2	6.07	127.05	122.80
52	5	335	C	N1-C2-O2	6.07	122.54	118.90
50	3	1358	C	C2-N1-C1'	6.04	125.45	118.80
50	3	2148	U	N3-C2-O2	-6.03	117.98	122.20
50	3	2321	C	N3-C2-O2	-6.02	117.69	121.90
52	5	616	C	N3-C2-O2	-6.01	117.69	121.90
50	3	1970	C	C2-N1-C1'	6.00	125.40	118.80
50	3	1671	C	N1-C2-O2	5.94	122.46	118.90
50	3	1187	C	N1-C2-O2	5.94	122.46	118.90
50	3	1813	C	C6-N1-C2	-5.93	117.93	120.30
50	3	579	U	N3-C4-O4	-5.91	115.26	119.40
50	3	2782	A	N1-C6-N6	-5.88	115.07	118.60
52	5	502	C	C2-N1-C1'	5.88	125.27	118.80
50	3	1039	G	N1-C6-O6	-5.87	116.38	119.90
50	3	2797	C	C2-N3-C4	-5.87	116.97	119.90
50	3	659	C	N1-C2-O2	5.83	122.40	118.90
53	8	5	C	N3-C2-O2	-5.81	117.84	121.90
50	3	1737	G	N3-C4-N9	5.80	129.48	126.00
50	3	879	U	N3-C2-O2	-5.79	118.14	122.20

*Continued on next page...*

*Continued from previous page...*

Mol	Chain	Res	Type	Atoms	Z	Observed(°)	Ideal(°)
53	7	5	C	N3-C2-O2	-5.72	117.90	121.90
50	3	405	C	C6-N1-C1'	5.71	127.65	120.80
50	3	1709	C	C2-N1-C1'	5.70	125.07	118.80
50	3	2823	A	OP1-P-O3'	5.66	117.66	105.20
52	5	1119	C	N1-C2-O2	5.66	122.30	118.90
50	3	1351	G	N3-C4-N9	5.63	129.38	126.00
50	3	2064	G	N1-C6-O6	-5.56	116.56	119.90
52	5	751	C	N3-C2-O2	-5.56	118.01	121.90
53	8	5	C	N1-C2-O2	5.54	122.23	118.90
50	3	543	U	N1-C2-O2	5.53	126.67	122.80
50	3	1137	C	C6-N1-C2	-5.53	118.09	120.30
50	3	2700	C	C6-N1-C2	-5.51	118.09	120.30
50	3	1709	C	N3-C2-O2	-5.51	118.05	121.90
52	5	264	C	N1-C2-O2	5.49	122.19	118.90
51	4	28	C	N3-C2-O2	-5.48	118.06	121.90
51	4	2	U	C5-C4-O4	-5.48	122.61	125.90
50	3	1738	G	N1-C2-N2	-5.48	111.27	116.20
50	3	34	C	N1-C2-O2	5.46	122.18	118.90
50	3	2105	G	C4-N9-C1'	5.45	133.59	126.50
53	7	5	C	N1-C2-O2	5.43	122.16	118.90
50	3	1039	G	C5-C6-O6	5.43	131.86	128.60
50	3	302	G	N1-C2-N2	-5.42	111.32	116.20
50	3	2072	C	C2-N1-C1'	5.41	124.75	118.80
50	3	2888	U	N1-C2-O2	5.40	126.58	122.80
50	3	2823	A	P-O3'-C3'	5.40	126.18	119.70
50	3	1325	C	C2-N1-C1'	5.40	124.74	118.80
50	3	1432	C	N1-C2-O2	5.39	122.13	118.90
50	3	1507	G	C4-N9-C1'	-5.38	119.51	126.50
50	3	2114	C	N1-C2-O2	5.37	122.12	118.90
52	5	1119	C	C2-N1-C1'	5.36	124.70	118.80
50	3	2408	G	N1-C2-N2	-5.36	111.37	116.20
52	5	751	C	N1-C2-O2	5.36	122.12	118.90
50	3	521	C	N1-C2-O2	5.35	122.11	118.90
50	3	2105	G	N3-C4-C5	-5.35	125.93	128.60
51	4	28	C	N1-C2-O2	5.33	122.10	118.90
50	3	115	U	C6-N1-C1'	-5.31	113.77	121.20
52	5	1125	C	N1-C2-O2	5.26	122.06	118.90
50	3	1345	G	N3-C4-N9	5.25	129.15	126.00
50	3	300	G	N3-C4-N9	-5.24	122.86	126.00
52	5	318	C	C6-N1-C2	-5.22	118.21	120.30
50	3	1303	U	C2-N1-C1'	5.22	123.96	117.70
50	3	2071	C	C2-N1-C1'	5.21	124.53	118.80

*Continued on next page...*

Continued from previous page...

Mol	Chain	Res	Type	Atoms	Z	Observed(°)	Ideal(°)
52	5	709	A	C6-N1-C2	-5.20	115.48	118.60
50	3	1363	C	N1-C2-O2	5.20	122.02	118.90
50	3	2321	C	N1-C2-O2	5.19	122.01	118.90
29	f	20	ASP	CB-CG-OD2	5.18	122.97	118.30
50	3	2072	C	C5-C6-N1	5.16	123.58	121.00
51	4	2	U	N3-C4-O4	5.16	123.01	119.40
50	3	579	U	C5-C4-O4	5.15	128.99	125.90
52	5	263	C	N3-C2-O2	-5.14	118.30	121.90
50	3	1507	G	C8-N9-C1'	5.12	133.66	127.00
52	5	502	C	N3-C2-O2	-5.12	118.32	121.90
50	3	2071	C	N1-C2-O2	5.11	121.97	118.90
50	3	530	G	N3-C4-N9	5.09	129.05	126.00
50	3	1363	C	C6-N1-C2	-5.09	118.26	120.30
52	5	463	U	C2-N1-C1'	5.07	123.78	117.70
52	5	975	C	N1-C2-O2	5.07	121.94	118.90
52	5	509	C	C6-N1-C1'	5.06	126.87	120.80
50	3	405	C	O4'-C1'-N1	5.01	112.21	108.20
52	5	1125	C	N3-C2-O2	-5.00	118.40	121.90

There are no chirality outliers.

There are no planarity outliers.

## 5.2 Too-close contacts [i](#)

Due to software issues we are unable to calculate clashes - this section is therefore empty.

## 5.3 Torsion angles [i](#)

### 5.3.1 Protein backbone [i](#)

In the following table, the Percentiles column shows the percent Ramachandran outliers of the chain as a percentile score with respect to all PDB entries followed by that with respect to all EM entries.

The Analysed column shows the number of residues for which the backbone conformation was analysed, and the total number of residues.

Mol	Chain	Analysed	Favoured	Allowed	Outliers	Percentiles	
1	0	45/48 (94%)	43 (96%)	2 (4%)	0	100	100
2	1	57/59 (97%)	55 (96%)	2 (4%)	0	100	100

Continued on next page...



Continued from previous page...

Mol	Chain	Analysed	Favoured	Allowed	Outliers	Percentiles	
3	2	35/37 (95%)	34 (97%)	1 (3%)	0	100	100
4	A	238/294 (81%)	218 (92%)	20 (8%)	0	100	100
5	B	213/273 (78%)	195 (92%)	18 (8%)	0	100	100
6	C	201/205 (98%)	187 (93%)	13 (6%)	1 (0%)	29	69
7	D	151/219 (69%)	137 (91%)	14 (9%)	0	100	100
8	E	165/215 (77%)	142 (86%)	23 (14%)	0	100	100
9	F	152/155 (98%)	142 (93%)	10 (7%)	0	100	100
10	G	139/142 (98%)	120 (86%)	19 (14%)	0	100	100
11	H	126/132 (96%)	109 (86%)	17 (14%)	0	100	100
12	I	99/108 (92%)	88 (89%)	11 (11%)	0	100	100
13	J	112/121 (93%)	104 (93%)	8 (7%)	0	100	100
14	K	134/139 (96%)	116 (87%)	17 (13%)	1 (1%)	22	63
15	L	116/124 (94%)	104 (90%)	12 (10%)	0	100	100
16	M	58/61 (95%)	51 (88%)	7 (12%)	0	100	100
17	N	81/86 (94%)	71 (88%)	10 (12%)	0	100	100
18	O	78/94 (83%)	68 (87%)	10 (13%)	0	100	100
19	P	81/85 (95%)	76 (94%)	5 (6%)	0	100	100
20	Q	63/104 (61%)	54 (86%)	9 (14%)	0	100	100
21	R	82/87 (94%)	73 (89%)	7 (8%)	2 (2%)	6	33
22	S	75/87 (86%)	75 (100%)	0	0	100	100
23	T	51/60 (85%)	49 (96%)	2 (4%)	0	100	100
24	a	283/287 (99%)	252 (89%)	31 (11%)	0	100	100
25	b	227/287 (79%)	212 (93%)	15 (7%)	0	100	100
26	c	208/212 (98%)	193 (93%)	15 (7%)	0	100	100
27	d	173/180 (96%)	160 (92%)	13 (8%)	0	100	100
28	e	174/184 (95%)	161 (92%)	13 (8%)	0	100	100
29	f	143/149 (96%)	132 (92%)	9 (6%)	2 (1%)	11	46
30	g	124/161 (77%)	106 (86%)	16 (13%)	2 (2%)	9	44
31	h	126/137 (92%)	116 (92%)	10 (8%)	0	100	100
32	i	142/146 (97%)	131 (92%)	11 (8%)	0	100	100
33	j	120/122 (98%)	113 (94%)	7 (6%)	0	100	100

Continued on next page...

Continued from previous page...

Mol	Chain	Analysed	Favoured	Allowed	Outliers	Percentiles	
34	k	146/151 (97%)	127 (87%)	19 (13%)	0	100	100
35	l	134/139 (96%)	127 (95%)	7 (5%)	0	100	100
36	m	117/124 (94%)	106 (91%)	11 (9%)	0	100	100
37	n	108/116 (93%)	99 (92%)	9 (8%)	0	100	100
38	o	113/119 (95%)	103 (91%)	10 (9%)	0	100	100
39	p	112/127 (88%)	107 (96%)	5 (4%)	0	100	100
40	q	97/100 (97%)	89 (92%)	8 (8%)	0	100	100
41	r	137/159 (86%)	132 (96%)	5 (4%)	0	100	100
42	s	90/237 (38%)	84 (93%)	6 (7%)	0	100	100
43	t	109/111 (98%)	98 (90%)	11 (10%)	0	100	100
44	u	84/104 (81%)	75 (89%)	9 (11%)	0	100	100
45	v	61/65 (94%)	58 (95%)	3 (5%)	0	100	100
46	w	96/111 (86%)	91 (95%)	5 (5%)	0	100	100
47	x	42/97 (43%)	34 (81%)	8 (19%)	0	100	100
48	y	54/57 (95%)	46 (85%)	7 (13%)	1 (2%)	8	38
49	z	48/53 (91%)	47 (98%)	1 (2%)	0	100	100
All	All	5820/6670 (87%)	5310 (91%)	501 (9%)	9 (0%)	50	81

All (9) Ramachandran outliers are listed below:

Mol	Chain	Res	Type
29	f	9	VAL
30	g	89	ILE
48	y	50	ASP
21	R	27	LYS
30	g	45	PHE
14	K	120	VAL
29	f	7	GLN
6	C	146	ALA
21	R	26	GLU

### 5.3.2 Protein sidechains [i](#)

In the following table, the Percentiles column shows the percent sidechain outliers of the chain as a percentile score with respect to all PDB entries followed by that with respect to all EM entries.

The Analysed column shows the number of residues for which the sidechain conformation was analysed, and the total number of residues.

Mol	Chain	Analysed	Rotameric	Outliers	Percentiles	
1	0	40/41 (98%)	40 (100%)	0	100	100
2	1	51/51 (100%)	51 (100%)	0	100	100
3	2	35/35 (100%)	35 (100%)	0	100	100
4	A	212/262 (81%)	211 (100%)	1 (0%)	88	93
5	B	180/232 (78%)	179 (99%)	1 (1%)	86	92
6	C	181/183 (99%)	180 (99%)	1 (1%)	86	92
7	D	123/178 (69%)	123 (100%)	0	100	100
8	E	150/196 (76%)	148 (99%)	2 (1%)	69	81
9	F	131/132 (99%)	131 (100%)	0	100	100
10	G	123/124 (99%)	123 (100%)	0	100	100
11	H	111/115 (96%)	109 (98%)	2 (2%)	59	77
12	I	95/99 (96%)	95 (100%)	0	100	100
13	J	91/97 (94%)	89 (98%)	2 (2%)	52	71
14	K	117/120 (98%)	116 (99%)	1 (1%)	78	87
15	L	100/105 (95%)	100 (100%)	0	100	100
16	M	47/48 (98%)	46 (98%)	1 (2%)	53	72
17	N	76/78 (97%)	75 (99%)	1 (1%)	69	81
18	O	69/82 (84%)	68 (99%)	1 (1%)	67	80
19	P	73/75 (97%)	73 (100%)	0	100	100
20	Q	56/94 (60%)	56 (100%)	0	100	100
21	R	74/77 (96%)	72 (97%)	2 (3%)	44	65
22	S	70/77 (91%)	70 (100%)	0	100	100
23	T	49/56 (88%)	49 (100%)	0	100	100
24	a	241/243 (99%)	237 (98%)	4 (2%)	60	78
25	b	186/233 (80%)	185 (100%)	1 (0%)	88	93
26	c	182/184 (99%)	181 (100%)	1 (0%)	88	93
27	d	150/154 (97%)	150 (100%)	0	100	100
28	e	153/159 (96%)	153 (100%)	0	100	100
29	f	131/134 (98%)	129 (98%)	2 (2%)	65	80
30	g	101/129 (78%)	95 (94%)	6 (6%)	19	45

Continued on next page...

*Continued from previous page...*

Mol	Chain	Analysed	Rotameric	Outliers	Percentiles	
31	h	102/110 (93%)	101 (99%)	1 (1%)	76	86
32	i	126/128 (98%)	124 (98%)	2 (2%)	62	79
33	j	103/103 (100%)	103 (100%)	0	100	100
34	k	123/126 (98%)	121 (98%)	2 (2%)	62	79
35	l	113/115 (98%)	113 (100%)	0	100	100
36	m	105/109 (96%)	105 (100%)	0	100	100
37	n	96/99 (97%)	95 (99%)	1 (1%)	76	86
38	o	101/105 (96%)	101 (100%)	0	100	100
39	p	100/108 (93%)	100 (100%)	0	100	100
40	q	90/91 (99%)	89 (99%)	1 (1%)	73	84
41	r	116/132 (88%)	116 (100%)	0	100	100
42	s	82/208 (39%)	82 (100%)	0	100	100
43	t	96/96 (100%)	96 (100%)	0	100	100
44	u	69/85 (81%)	69 (100%)	0	100	100
45	v	58/60 (97%)	58 (100%)	0	100	100
46	w	87/98 (89%)	86 (99%)	1 (1%)	73	84
47	x	41/86 (48%)	41 (100%)	0	100	100
48	y	48/49 (98%)	47 (98%)	1 (2%)	53	72
49	z	47/50 (94%)	47 (100%)	0	100	100
All	All	5101/5751 (89%)	5063 (99%)	38 (1%)	84	90

All (38) residues with a non-rotameric sidechain are listed below:

Mol	Chain	Res	Type
4	A	27	ARG
5	B	182	ARG
6	C	172	LYS
8	E	74	ARG
8	E	148	LYS
11	H	115	ARG
11	H	116	LYS
13	J	49	ARG
13	J	121	ARG
14	K	122	LYS
16	M	10	GLN

*Continued on next page...*

*Continued from previous page...*

Mol	Chain	Res	Type
17	N	83	ASN
18	O	2	ARG
21	R	24	LYS
21	R	26	GLU
24	a	42	LYS
24	a	56	ARG
24	a	162	ARG
24	a	280	ARG
25	b	180	ARG
26	c	27	LYS
29	f	10	SER
29	f	62	LYS
30	g	29	TYR
30	g	30	THR
30	g	44	LEU
30	g	45	PHE
30	g	46	LYS
30	g	88	GLU
31	h	84	LYS
32	i	109	LYS
32	i	116	ARG
34	k	13	ARG
34	k	30	LYS
37	n	18	LYS
40	q	66	ARG
46	w	17	LYS
48	y	51	LEU

Sometimes sidechains can be flipped to improve hydrogen bonding and reduce clashes. All (27) such sidechains are listed below:

Mol	Chain	Res	Type
5	B	47	ASN
5	B	91	GLN
6	C	61	GLN
6	C	70	GLN
6	C	115	GLN
6	C	118	ASN
7	D	127	HIS
8	E	67	GLN
8	E	110	GLN
14	K	86	ASN
14	K	88	GLN

*Continued on next page...*

*Continued from previous page...*

Mol	Chain	Res	Type
14	K	109	HIS
24	a	78	ASN
24	a	238	HIS
26	c	70	HIS
26	c	76	GLN
27	d	135	GLN
28	e	109	GLN
29	f	11	ASN
30	g	87	ASN
35	l	13	HIS
35	l	40	ASN
36	m	69	ASN
37	n	7	GLN
37	n	38	HIS
37	n	64	ASN
44	u	54	GLN

### 5.3.3 RNA [i](#)

Mol	Chain	Analysed	Backbone Outliers	Pucker Outliers
50	3	2875/2907 (98%)	1078 (37%)	34 (1%)
51	4	103/108 (95%)	44 (42%)	5 (4%)
52	5	1490/1520 (98%)	496 (33%)	19 (1%)
53	7	75/76 (98%)	30 (40%)	3 (4%)
53	8	75/76 (98%)	30 (40%)	3 (4%)
All	All	4618/4687 (98%)	1678 (36%)	64 (1%)

All (1678) RNA backbone outliers are listed below:

Mol	Chain	Res	Type
50	3	9	G
50	3	13	C
50	3	14	U
50	3	15	A
50	3	16	A
50	3	19	G
50	3	23	A
50	3	28	G
50	3	30	A
50	3	34	C
50	3	36	U

*Continued on next page...*

*Continued from previous page...*

<b>Mol</b>	<b>Chain</b>	<b>Res</b>	<b>Type</b>
50	3	37	G
50	3	39	C
50	3	41	C
50	3	44	A
50	3	47	G
50	3	50	G
50	3	51	A
50	3	52	U
50	3	53	G
50	3	63	U
50	3	64	U
50	3	65	A
50	3	66	A
50	3	69	U
50	3	71	C
50	3	73	A
50	3	76	A
50	3	77	G
50	3	82	G
50	3	83	G
50	3	86	A
50	3	90	G
50	3	94	A
50	3	98	C
50	3	102	A
50	3	103	G
50	3	106	C
50	3	116	C
50	3	118	G
50	3	119	A
50	3	120	A
50	3	129	U
50	3	130	C
50	3	132	G
50	3	136	G
50	3	137	U
50	3	139	G
50	3	141	A
50	3	146	G
50	3	147	C
50	3	148	U
50	3	153	U

*Continued on next page...*

*Continued from previous page...*

<b>Mol</b>	<b>Chain</b>	<b>Res</b>	<b>Type</b>
50	3	155	A
50	3	163	A
50	3	170	A
50	3	177	U
50	3	180	A
50	3	181	G
50	3	183	A
50	3	184	A
50	3	185	U
50	3	186	A
50	3	188	G
50	3	194	A
50	3	197	U
50	3	200	A
50	3	203	A
50	3	207	C
50	3	208	A
50	3	210	U
50	3	220	A
50	3	225	A
50	3	226	A
50	3	228	A
50	3	229	C
50	3	231	A
50	3	232	A
50	3	233	U
50	3	234	G
50	3	237	A
50	3	245	U
50	3	246	G
50	3	247	U
50	3	252	G
50	3	254	G
50	3	261	A
50	3	266	A
50	3	269	A
50	3	270	G
50	3	273	C
50	3	274	A
50	3	276	A
50	3	277	C
50	3	282	C

*Continued on next page...*



*Continued from previous page...*

<b>Mol</b>	<b>Chain</b>	<b>Res</b>	<b>Type</b>
50	3	284	U
50	3	285	U
50	3	286	A
50	3	287	G
50	3	288	A
50	3	291	G
50	3	293	G
50	3	294	G
50	3	295	U
50	3	296	U
50	3	297	G
50	3	298	U
50	3	299	A
50	3	300	G
50	3	306	G
50	3	310	U
50	3	312	U
50	3	313	G
50	3	314	G
50	3	315	A
50	3	316	C
50	3	319	G
50	3	323	A
50	3	324	C
50	3	325	G
50	3	329	G
50	3	331	A
50	3	333	A
50	3	335	G
50	3	336	C
50	3	337	U
50	3	343	A
50	3	345	A
50	3	351	G
50	3	355	A
50	3	356	A
50	3	357	A
50	3	358	A
50	3	363	G
50	3	364	A
50	3	365	U
50	3	367	G

*Continued on next page...*

*Continued from previous page...*

<b>Mol</b>	<b>Chain</b>	<b>Res</b>	<b>Type</b>
50	3	369	C
50	3	381	A
50	3	391	U
50	3	393	C
50	3	396	A
50	3	401	G
50	3	402	A
50	3	403	U
50	3	404	C
50	3	405	C
50	3	407	U
50	3	408	G
50	3	409	A
50	3	410	G
50	3	411	U
50	3	413	G
50	3	417	G
50	3	418	G
50	3	420	A
50	3	422	A
50	3	423	C
50	3	424	G
50	3	425	U
50	3	426	U
50	3	434	G
50	3	437	A
50	3	440	C
50	3	441	U
50	3	447	G
50	3	448	A
50	3	457	U
50	3	458	A
50	3	460	G
50	3	465	A
50	3	470	U
50	3	475	A
50	3	478	G
50	3	479	A
50	3	480	C
50	3	484	U
50	3	485	A
50	3	487	C

*Continued on next page...*

*Continued from previous page...*

<b>Mol</b>	<b>Chain</b>	<b>Res</b>	<b>Type</b>
50	3	488	G
50	3	490	A
50	3	493	A
50	3	494	G
50	3	495	U
50	3	503	G
50	3	509	G
50	3	510	G
50	3	513	A
50	3	514	A
50	3	515	A
50	3	516	A
50	3	517	G
50	3	520	C
50	3	525	A
50	3	531	G
50	3	532	A
50	3	536	A
50	3	539	U
50	3	541	G
50	3	543	U
50	3	544	U
50	3	550	A
50	3	557	G
50	3	563	A
50	3	564	A
50	3	566	G
50	3	567	U
50	3	568	G
50	3	576	A
50	3	577	C
50	3	578	A
50	3	580	U
50	3	581	A
50	3	582	A
50	3	583	U
50	3	591	G
50	3	595	U
50	3	596	G
50	3	598	G
50	3	601	U
50	3	605	A

*Continued on next page...*

*Continued from previous page...*

<b>Mol</b>	<b>Chain</b>	<b>Res</b>	<b>Type</b>
50	3	606	G
50	3	612	G
50	3	633	G
50	3	636	U
50	3	637	U
50	3	638	A
50	3	648	G
50	3	649	A
50	3	650	G
50	3	654	G
50	3	658	G
50	3	661	G
50	3	662	U
50	3	663	A
50	3	664	G
50	3	666	G
50	3	670	G
50	3	673	A
50	3	674	G
50	3	679	A
50	3	681	A
50	3	685	G
50	3	689	U
50	3	690	U
50	3	691	G
50	3	694	U
50	3	697	U
50	3	704	G
50	3	705	A
50	3	706	C
50	3	710	A
50	3	711	A
50	3	712	A
50	3	713	C
50	3	715	G
50	3	720	A
50	3	721	G
50	3	722	C
50	3	728	A
50	3	730	G
50	3	733	C
50	3	739	G

*Continued on next page...*

*Continued from previous page...*

<b>Mol</b>	<b>Chain</b>	<b>Res</b>	<b>Type</b>
50	3	743	G
50	3	748	G
50	3	752	C
50	3	756	A
50	3	760	G
50	3	761	G
50	3	762	A
50	3	764	G
50	3	765	A
50	3	766	C
50	3	778	U
50	3	782	U
50	3	783	G
50	3	787	C
50	3	792	G
50	3	795	G
50	3	796	A
50	3	797	U
50	3	798	G
50	3	808	U
50	3	810	G
50	3	811	G
50	3	812	G
50	3	816	A
50	3	817	A
50	3	818	A
50	3	819	U
50	3	820	U
50	3	823	A
50	3	824	A
50	3	825	U
50	3	827	G
50	3	828	A
50	3	829	A
50	3	836	G
50	3	837	A
50	3	839	A
50	3	840	G
50	3	841	C
50	3	842	U
50	3	843	G
50	3	847	C

*Continued on next page...*

*Continued from previous page...*

<b>Mol</b>	<b>Chain</b>	<b>Res</b>	<b>Type</b>
50	3	860	C
50	3	862	U
50	3	863	U
50	3	865	A
50	3	866	G
50	3	867	G
50	3	880	C
50	3	881	A
50	3	882	C
50	3	883	A
50	3	887	A
50	3	888	A
50	3	889	G
50	3	891	G
50	3	892	G
50	3	893	A
50	3	894	G
50	3	900	G
50	3	901	C
50	3	902	U
50	3	903	A
50	3	904	C
50	3	906	G
50	3	909	U
50	3	910	G
50	3	913	U
50	3	914	G
50	3	917	G
50	3	931	G
50	3	932	U
50	3	933	A
50	3	934	C
50	3	936	G
50	3	940	A
50	3	943	A
50	3	944	U
50	3	947	A
50	3	949	C
50	3	951	C
50	3	952	U
50	3	953	G
50	3	957	G

*Continued on next page...*

*Continued from previous page...*

<b>Mol</b>	<b>Chain</b>	<b>Res</b>	<b>Type</b>
50	3	959	C
50	3	960	A
50	3	966	U
50	3	968	U
50	3	971	U
50	3	976	C
50	3	979	U
50	3	981	A
50	3	982	G
50	3	984	C
50	3	989	G
50	3	990	G
50	3	993	A
50	3	997	G
50	3	998	C
50	3	1001	C
50	3	1008	A
50	3	1009	A
50	3	1010	G
50	3	1012	G
50	3	1016	A
50	3	1018	G
50	3	1019	A
50	3	1021	C
50	3	1024	A
50	3	1025	G
50	3	1026	A
50	3	1027	U
50	3	1029	A
50	3	1031	U
50	3	1032	A
50	3	1035	U
50	3	1039	G
50	3	1041	C
50	3	1045	A
50	3	1047	A
50	3	1049	U
50	3	1054	U
50	3	1055	A
50	3	1060	G
50	3	1061	A
50	3	1068	U

*Continued on next page...*

*Continued from previous page...*

<b>Mol</b>	<b>Chain</b>	<b>Res</b>	<b>Type</b>
50	3	1069	G
50	3	1073	A
50	3	1075	G
50	3	1076	U
50	3	1080	A
50	3	1081	A
50	3	1082	A
50	3	1083	A
50	3	1084	C
50	3	1088	A
50	3	1095	U
50	3	1096	U
50	3	1097	G
50	3	1101	U
50	3	1103	G
50	3	1104	A
50	3	1105	A
50	3	1106	G
50	3	1107	C
50	3	1113	U
50	3	1115	G
50	3	1122	G
50	3	1123	A
50	3	1124	G
50	3	1125	U
50	3	1128	G
50	3	1132	C
50	3	1137	C
50	3	1139	C
50	3	1142	G
50	3	1145	G
50	3	1147	G
50	3	1149	G
50	3	1150	U
50	3	1154	U
50	3	1155	G
50	3	1158	C
50	3	1162	A
50	3	1163	G
50	3	1165	U
50	3	1166	G
50	3	1167	U

*Continued on next page...*



*Continued from previous page...*

<b>Mol</b>	<b>Chain</b>	<b>Res</b>	<b>Type</b>
50	3	1168	A
50	3	1169	A
50	3	1170	C
50	3	1171	G
50	3	1174	G
50	3	1175	C
50	3	1176	U
50	3	1177	A
50	3	1179	G
50	3	1180	U
50	3	1181	A
50	3	1189	G
50	3	1191	A
50	3	1192	U
50	3	1196	U
50	3	1202	A
50	3	1203	G
50	3	1204	A
50	3	1205	U
50	3	1206	U
50	3	1209	U
50	3	1210	A
50	3	1215	G
50	3	1216	U
50	3	1217	G
50	3	1219	U
50	3	1221	G
50	3	1222	A
50	3	1225	A
50	3	1226	G
50	3	1229	U
50	3	1234	U
50	3	1235	U
50	3	1236	G
50	3	1240	U
50	3	1241	U
50	3	1242	G
50	3	1245	G
50	3	1246	U
50	3	1250	A
50	3	1251	G
50	3	1253	G

*Continued on next page...*

*Continued from previous page...*

<b>Mol</b>	<b>Chain</b>	<b>Res</b>	<b>Type</b>
50	3	1255	G
50	3	1256	A
50	3	1257	G
50	3	1259	A
50	3	1265	G
50	3	1266	G
50	3	1267	A
50	3	1268	U
50	3	1274	A
50	3	1277	A
50	3	1278	G
50	3	1279	U
50	3	1281	A
50	3	1282	G
50	3	1283	A
50	3	1285	U
50	3	1286	G
50	3	1287	C
50	3	1291	C
50	3	1292	A
50	3	1295	A
50	3	1296	G
50	3	1298	A
50	3	1300	C
50	3	1301	G
50	3	1302	C
50	3	1304	U
50	3	1305	G
50	3	1307	G
50	3	1315	A
50	3	1316	U
50	3	1317	C
50	3	1322	A
50	3	1323	A
50	3	1325	C
50	3	1328	A
50	3	1329	U
50	3	1331	G
50	3	1332	A
50	3	1334	U
50	3	1335	A
50	3	1340	U

*Continued on next page...*

*Continued from previous page...*

<b>Mol</b>	<b>Chain</b>	<b>Res</b>	<b>Type</b>
50	3	1342	C
50	3	1350	A
50	3	1353	G
50	3	1354	U
50	3	1355	C
50	3	1357	U
50	3	1359	C
50	3	1360	U
50	3	1361	U
50	3	1368	U
50	3	1369	U
50	3	1370	A
50	3	1371	G
50	3	1375	G
50	3	1377	A
50	3	1378	C
50	3	1381	A
50	3	1387	A
50	3	1388	G
50	3	1393	A
50	3	1396	A
50	3	1406	A
50	3	1407	U
50	3	1408	G
50	3	1410	A
50	3	1412	A
50	3	1414	C
50	3	1415	A
50	3	1420	A
50	3	1422	U
50	3	1423	A
50	3	1424	U
50	3	1425	U
50	3	1426	C
50	3	1427	C
50	3	1432	C
50	3	1435	A
50	3	1444	C
50	3	1445	U
50	3	1447	A
50	3	1455	A
50	3	1456	C

*Continued on next page...*

*Continued from previous page...*

<b>Mol</b>	<b>Chain</b>	<b>Res</b>	<b>Type</b>
50	3	1457	A
50	3	1458	A
50	3	1459	A
50	3	1463	G
50	3	1466	U
50	3	1467	U
50	3	1474	C
50	3	1478	U
50	3	1480	A
50	3	1481	U
50	3	1482	U
50	3	1484	G
50	3	1486	U
50	3	1487	U
50	3	1489	G
50	3	1493	A
50	3	1494	U
50	3	1497	A
50	3	1507	G
50	3	1508	G
50	3	1510	A
50	3	1514	U
50	3	1520	A
50	3	1522	U
50	3	1528	G
50	3	1533	U
50	3	1534	A
50	3	1535	A
50	3	1541	A
50	3	1548	A
50	3	1549	U
50	3	1550	G
50	3	1555	G
50	3	1558	A
50	3	1579	G
50	3	1580	G
50	3	1584	U
50	3	1585	A
50	3	1587	U
50	3	1588	A
50	3	1589	A
50	3	1592	A

*Continued on next page...*

*Continued from previous page...*

<b>Mol</b>	<b>Chain</b>	<b>Res</b>	<b>Type</b>
50	3	1593	U
50	3	1595	C
50	3	1598	U
50	3	1600	A
50	3	1601	A
50	3	1603	A
50	3	1608	C
50	3	1611	C
50	3	1612	U
50	3	1615	G
50	3	1616	G
50	3	1618	U
50	3	1619	A
50	3	1641	A
50	3	1642	G
50	3	1644	A
50	3	1645	C
50	3	1646	G
50	3	1648	A
50	3	1649	C
50	3	1651	C
50	3	1653	C
50	3	1655	U
50	3	1656	A
50	3	1660	A
50	3	1661	A
50	3	1668	G
50	3	1669	A
50	3	1671	C
50	3	1672	C
50	3	1674	A
50	3	1678	U
50	3	1679	U
50	3	1680	A
50	3	1681	G
50	3	1682	C
50	3	1683	G
50	3	1687	G
50	3	1688	A
50	3	1694	A
50	3	1695	G
50	3	1698	A

*Continued on next page...*

*Continued from previous page...*

<b>Mol</b>	<b>Chain</b>	<b>Res</b>	<b>Type</b>
50	3	1701	G
50	3	1704	C
50	3	1705	U
50	3	1706	C
50	3	1707	U
50	3	1708	G
50	3	1709	C
50	3	1710	A
50	3	1712	A
50	3	1713	U
50	3	1714	U
50	3	1716	A
50	3	1717	C
50	3	1721	G
50	3	1727	U
50	3	1728	A
50	3	1730	C
50	3	1733	G
50	3	1734	A
50	3	1741	G
50	3	1747	G
50	3	1750	A
50	3	1751	A
50	3	1761	C
50	3	1764	U
50	3	1765	G
50	3	1766	A
50	3	1768	G
50	3	1769	A
50	3	1770	A
50	3	1780	A
50	3	1784	U
50	3	1788	A
50	3	1789	C
50	3	1791	A
50	3	1794	A
50	3	1797	C
50	3	1806	G
50	3	1807	C
50	3	1809	A
50	3	1814	G
50	3	1816	A

*Continued on next page...*

*Continued from previous page...*

<b>Mol</b>	<b>Chain</b>	<b>Res</b>	<b>Type</b>
50	3	1821	G
50	3	1822	A
50	3	1823	U
50	3	1826	A
50	3	1827	U
50	3	1828	A
50	3	1831	G
50	3	1836	A
50	3	1842	G
50	3	1868	A
50	3	1870	G
50	3	1872	U
50	3	1873	A
50	3	1876	G
50	3	1884	A
50	3	1900	C
50	3	1907	A
50	3	1910	G
50	3	1911	G
50	3	1913	G
50	3	1914	G
50	3	1919	A
50	3	1920	A
50	3	1921	C
50	3	1923	A
50	3	1925	A
50	3	1928	G
50	3	1936	G
50	3	1937	G
50	3	1938	U
50	3	1945	A
50	3	1946	U
50	3	1949	C
50	3	1950	U
50	3	1951	A
50	3	1952	G
50	3	1953	U
50	3	1956	G
50	3	1958	U
50	3	1959	A
50	3	1960	A
50	3	1961	A

*Continued on next page...*

*Continued from previous page...*

<b>Mol</b>	<b>Chain</b>	<b>Res</b>	<b>Type</b>
50	3	1962	U
50	3	1963	U
50	3	1966	G
50	3	1969	C
50	3	1970	C
50	3	1971	G
50	3	1972	C
50	3	1974	U
50	3	1977	A
50	3	1978	U
50	3	1979	G
50	3	1980	G
50	3	1982	G
50	3	1984	A
50	3	1998	U
50	3	2000	U
50	3	2001	C
50	3	2004	G
50	3	2005	G
50	3	2008	A
50	3	2011	G
50	3	2016	G
50	3	2020	A
50	3	2023	U
50	3	2025	C
50	3	2026	A
50	3	2028	G
50	3	2029	U
50	3	2030	A
50	3	2033	G
50	3	2037	A
50	3	2038	A
50	3	2039	G
50	3	2040	A
50	3	2041	C
50	3	2043	C
50	3	2050	G
50	3	2053	G
50	3	2056	A
50	3	2058	G
50	3	2059	G
50	3	2062	C

*Continued on next page...*



*Continued from previous page...*

<b>Mol</b>	<b>Chain</b>	<b>Res</b>	<b>Type</b>
50	3	2063	G
50	3	2064	G
50	3	2067	A
50	3	2068	G
50	3	2069	A
50	3	2070	C
50	3	2071	C
50	3	2075	U
50	3	2076	G
50	3	2084	A
50	3	2087	G
50	3	2094	A
50	3	2099	U
50	3	2100	G
50	3	2106	G
50	3	2107	A
50	3	2110	U
50	3	2111	U
50	3	2112	A
50	3	2114	C
50	3	2117	G
50	3	2119	A
50	3	2123	A
50	3	2124	A
50	3	2127	G
50	3	2134	G
50	3	2138	U
50	3	2139	C
50	3	2140	G
50	3	2142	U
50	3	2143	G
50	3	2144	C
50	3	2145	A
50	3	2149	U
50	3	2150	C
50	3	2151	G
50	3	2152	C
50	3	2153	U
50	3	2163	U
50	3	2167	G
50	3	2169	G
50	3	2170	A

*Continued on next page...*

*Continued from previous page...*

<b>Mol</b>	<b>Chain</b>	<b>Res</b>	<b>Type</b>
50	3	2173	G
50	3	2178	A
50	3	2180	U
50	3	2184	A
50	3	2185	C
50	3	2187	C
50	3	2188	U
50	3	2191	G
50	3	2193	U
50	3	2194	G
50	3	2195	U
50	3	2198	G
50	3	2199	C
50	3	2200	U
50	3	2202	U
50	3	2203	U
50	3	2206	A
50	3	2211	G
50	3	2212	U
50	3	2217	G
50	3	2219	U
50	3	2220	A
50	3	2221	U
50	3	2222	C
50	3	2229	C
50	3	2231	A
50	3	2233	A
50	3	2234	C
50	3	2235	A
50	3	2242	G
50	3	2246	G
50	3	2247	G
50	3	2248	C
50	3	2253	U
50	3	2254	G
50	3	2258	G
50	3	2259	G
50	3	2260	G
50	3	2274	A
50	3	2275	A
50	3	2276	A
50	3	2277	A

*Continued on next page...*

*Continued from previous page...*

<b>Mol</b>	<b>Chain</b>	<b>Res</b>	<b>Type</b>
50	3	2280	U
50	3	2281	A
50	3	2282	A
50	3	2286	A
50	3	2287	G
50	3	2289	C
50	3	2291	U
50	3	2293	C
50	3	2294	A
50	3	2295	A
50	3	2300	A
50	3	2304	U
50	3	2312	G
50	3	2313	U
50	3	2315	G
50	3	2316	G
50	3	2317	A
50	3	2318	A
50	3	2319	A
50	3	2320	U
50	3	2326	G
50	3	2330	A
50	3	2332	U
50	3	2333	G
50	3	2334	U
50	3	2335	A
50	3	2338	G
50	3	2341	G
50	3	2342	U
50	3	2343	A
50	3	2349	G
50	3	2352	U
50	3	2353	G
50	3	2354	A
50	3	2355	C
50	3	2358	U
50	3	2362	A
50	3	2363	C
50	3	2377	A
50	3	2381	G
50	3	2387	U
50	3	2391	G

*Continued on next page...*

*Continued from previous page...*

<b>Mol</b>	<b>Chain</b>	<b>Res</b>	<b>Type</b>
50	3	2393	C
50	3	2394	A
50	3	2396	A
50	3	2397	G
50	3	2404	G
50	3	2409	U
50	3	2410	C
50	3	2411	C
50	3	2414	U
50	3	2415	A
50	3	2418	G
50	3	2422	G
50	3	2431	U
50	3	2433	A
50	3	2434	A
50	3	2435	C
50	3	2436	G
50	3	2438	A
50	3	2439	U
50	3	2440	A
50	3	2442	A
50	3	2443	A
50	3	2449	U
50	3	2450	C
50	3	2453	G
50	3	2455	G
50	3	2456	A
50	3	2457	U
50	3	2458	A
50	3	2464	C
50	3	2466	G
50	3	2468	U
50	3	2474	C
50	3	2477	A
50	3	2481	U
50	3	2484	A
50	3	2486	A
50	3	2489	G
50	3	2492	G
50	3	2498	G
50	3	2499	U
50	3	2505	A

*Continued on next page...*

*Continued from previous page...*

<b>Mol</b>	<b>Chain</b>	<b>Res</b>	<b>Type</b>
50	3	2506	C
50	3	2507	C
50	3	2509	C
50	3	2511	A
50	3	2512	U
50	3	2513	G
50	3	2514	U
50	3	2517	A
50	3	2521	A
50	3	2526	A
50	3	2527	U
50	3	2528	C
50	3	2537	G
50	3	2539	A
50	3	2540	G
50	3	2543	G
50	3	2548	G
50	3	2549	A
50	3	2551	G
50	3	2555	U
50	3	2557	G
50	3	2558	G
50	3	2561	G
50	3	2563	U
50	3	2568	G
50	3	2573	A
50	3	2574	A
50	3	2575	G
50	3	2580	A
50	3	2581	C
50	3	2582	G
50	3	2584	G
50	3	2585	A
50	3	2586	G
50	3	2591	G
50	3	2597	A
50	3	2604	U
50	3	2605	G
50	3	2606	A
50	3	2607	G
50	3	2610	A
50	3	2618	C

*Continued on next page...*

*Continued from previous page...*

<b>Mol</b>	<b>Chain</b>	<b>Res</b>	<b>Type</b>
50	3	2619	C
50	3	2621	U
50	3	2622	A
50	3	2623	U
50	3	2626	A
50	3	2628	U
50	3	2629	G
50	3	2631	G
50	3	2637	A
50	3	2638	G
50	3	2642	G
50	3	2643	A
50	3	2644	U
50	3	2646	G
50	3	2647	A
50	3	2649	G
50	3	2653	G
50	3	2654	U
50	3	2662	A
50	3	2663	G
50	3	2668	A
50	3	2669	G
50	3	2681	G
50	3	2689	C
50	3	2690	U
50	3	2691	C
50	3	2697	C
50	3	2698	U
50	3	2699	C
50	3	2703	U
50	3	2705	G
50	3	2708	G
50	3	2714	G
50	3	2722	G
50	3	2723	C
50	3	2726	G
50	3	2732	A
50	3	2734	C
50	3	2735	G
50	3	2737	G
50	3	2740	U
50	3	2741	A

*Continued on next page...*

*Continued from previous page...*

<b>Mol</b>	<b>Chain</b>	<b>Res</b>	<b>Type</b>
50	3	2744	A
50	3	2747	U
50	3	2752	G
50	3	2756	A
50	3	2760	C
50	3	2763	C
50	3	2765	A
50	3	2772	A
50	3	2773	A
50	3	2774	A
50	3	2775	C
50	3	2784	A
50	3	2785	G
50	3	2786	A
50	3	2788	U
50	3	2789	A
50	3	2790	A
50	3	2791	U
50	3	2799	U
50	3	2800	U
50	3	2802	C
50	3	2803	G
50	3	2807	G
50	3	2808	A
50	3	2810	A
50	3	2811	G
50	3	2813	A
50	3	2814	A
50	3	2815	G
50	3	2821	U
50	3	2822	C
50	3	2824	A
50	3	2825	A
50	3	2826	G
50	3	2827	A
50	3	2829	G
50	3	2831	U
50	3	2837	U
50	3	2838	G
50	3	2839	A
50	3	2840	U
50	3	2841	A

*Continued on next page...*

*Continued from previous page...*

<b>Mol</b>	<b>Chain</b>	<b>Res</b>	<b>Type</b>
50	3	2853	U
50	3	2854	A
50	3	2855	A
50	3	2864	A
50	3	2865	U
50	3	2867	U
50	3	2871	G
50	3	2876	G
50	3	2881	A
50	3	2884	C
50	3	2886	A
50	3	2888	U
50	3	2889	U
50	3	2890	G
50	3	2895	A
50	3	2897	G
50	3	2898	A
51	4	2	U
51	4	3	U
51	4	4	G
51	4	9	C
51	4	10	C
51	4	11	A
51	4	12	U
51	4	13	G
51	4	18	U
51	4	19	G
51	4	20	U
51	4	23	A
51	4	24	A
51	4	27	A
51	4	28	C
51	4	33	U
51	4	35	C
51	4	38	U
51	4	39	U
51	4	40	U
51	4	41	C
51	4	42	G
51	4	45	C
51	4	47	C
51	4	48	A

*Continued on next page...*



*Continued from previous page...*

<b>Mol</b>	<b>Chain</b>	<b>Res</b>	<b>Type</b>
51	4	49	G
51	4	50	C
51	4	51	A
51	4	54	U
51	4	55	A
51	4	60	C
51	4	65	G
51	4	66	A
51	4	75	U
51	4	76	A
51	4	77	G
51	4	86	G
51	4	88	G
51	4	89	A
51	4	98	A
51	4	99	A
51	4	102	A
51	4	106	A
51	4	107	G
52	5	8	G
52	5	9	A
52	5	10	G
52	5	14	U
52	5	16	G
52	5	17	A
52	5	18	U
52	5	22	G
52	5	32	U
52	5	33	A
52	5	40	G
52	5	48	C
52	5	49	C
52	5	50	U
52	5	51	A
52	5	52	A
52	5	66	A
52	5	67	U
52	5	75	A
52	5	80	U
52	5	81	A
52	5	86	A
52	5	87	G

*Continued on next page...*

*Continued from previous page...*

<b>Mol</b>	<b>Chain</b>	<b>Res</b>	<b>Type</b>
52	5	93	A
52	5	95	C
52	5	98	G
52	5	100	G
52	5	101	A
52	5	104	A
52	5	105	A
52	5	106	C
52	5	111	A
52	5	112	U
52	5	113	C
52	5	114	C
52	5	115	A
52	5	117	U
52	5	120	A
52	5	130	G
52	5	132	G
52	5	135	A
52	5	145	G
52	5	148	A
52	5	149	G
52	5	160	A
52	5	163	G
52	5	164	C
52	5	165	A
52	5	168	A
52	5	170	A
52	5	171	A
52	5	175	U
52	5	180	C
52	5	186	A
52	5	194	U
52	5	196	G
52	5	205	U
52	5	211	G
52	5	215	C
52	5	216	G
52	5	227	A
52	5	230	G
52	5	234	G
52	5	236	C
52	5	239	A

*Continued on next page...*

*Continued from previous page...*

<b>Mol</b>	<b>Chain</b>	<b>Res</b>	<b>Type</b>
52	5	240	U
52	5	241	C
52	5	243	G
52	5	246	A
52	5	247	G
52	5	249	U
52	5	256	G
52	5	260	C
52	5	262	G
52	5	263	C
52	5	271	G
52	5	275	A
52	5	276	U
52	5	285	G
52	5	290	G
52	5	296	A
52	5	300	A
52	5	302	A
52	5	305	A
52	5	311	A
52	5	312	A
52	5	323	A
52	5	324	C
52	5	326	C
52	5	328	G
52	5	334	A
52	5	341	C
52	5	342	G
52	5	344	G
52	5	347	G
52	5	348	C
52	5	353	G
52	5	361	U
52	5	363	U
52	5	364	U
52	5	365	U
52	5	367	A
52	5	368	C
52	5	369	A
52	5	378	A
52	5	379	A
52	5	382	U

*Continued on next page...*

*Continued from previous page...*

<b>Mol</b>	<b>Chain</b>	<b>Res</b>	<b>Type</b>
52	5	384	G
52	5	385	A
52	5	388	G
52	5	393	A
52	5	394	U
52	5	400	G
52	5	402	G
52	5	407	A
52	5	408	U
52	5	409	G
52	5	410	A
52	5	411	A
52	5	414	U
52	5	416	U
52	5	417	U
52	5	418	U
52	5	419	A
52	5	420	A
52	5	425	G
52	5	426	U
52	5	428	A
52	5	429	A
52	5	430	G
52	5	432	U
52	5	438	A
52	5	440	U
52	5	441	U
52	5	445	A
52	5	451	G
52	5	452	A
52	5	456	U
52	5	457	A
52	5	464	A
52	5	467	G
52	5	476	U
52	5	477	U
52	5	478	G
52	5	480	C
52	5	481	U
52	5	482	G
52	5	483	U
52	5	484	A

*Continued on next page...*

*Continued from previous page...*

<b>Mol</b>	<b>Chain</b>	<b>Res</b>	<b>Type</b>
52	5	485	C
52	5	488	U
52	5	489	U
52	5	493	A
52	5	494	A
52	5	495	U
52	5	497	A
52	5	498	G
52	5	506	U
52	5	507	A
52	5	508	A
52	5	509	C
52	5	513	G
52	5	515	G
52	5	516	C
52	5	519	G
52	5	525	G
52	5	529	U
52	5	530	A
52	5	531	A
52	5	532	U
52	5	534	C
52	5	535	A
52	5	538	G
52	5	543	C
52	5	545	A
52	5	548	G
52	5	550	U
52	5	551	A
52	5	553	C
52	5	556	G
52	5	559	U
52	5	560	U
52	5	561	A
52	5	562	U
52	5	565	G
52	5	568	G
52	5	570	A
52	5	571	A
52	5	572	A
52	5	573	G
52	5	574	C

*Continued on next page...*

*Continued from previous page...*

<b>Mol</b>	<b>Chain</b>	<b>Res</b>	<b>Type</b>
52	5	575	A
52	5	577	G
52	5	582	G
52	5	591	A
52	5	593	A
52	5	594	A
52	5	595	G
52	5	604	U
52	5	615	G
52	5	616	C
52	5	618	U
52	5	623	G
52	5	624	U
52	5	626	G
52	5	628	A
52	5	632	A
52	5	635	G
52	5	636	G
52	5	638	A
52	5	643	U
52	5	645	A
52	5	647	U
52	5	648	C
52	5	650	A
52	5	651	G
52	5	652	A
52	5	653	G
52	5	656	U
52	5	662	G
52	5	671	G
52	5	672	A
52	5	676	U
52	5	682	G
52	5	683	G
52	5	684	A
52	5	687	G
52	5	703	A
52	5	708	A
52	5	715	A
52	5	718	A
52	5	719	G
52	5	720	U

*Continued on next page...*

*Continued from previous page...*

<b>Mol</b>	<b>Chain</b>	<b>Res</b>	<b>Type</b>
52	5	721	G
52	5	724	G
52	5	725	A
52	5	728	G
52	5	731	A
52	5	741	C
52	5	743	A
52	5	744	U
52	5	745	U
52	5	746	A
52	5	749	G
52	5	750	A
52	5	752	G
52	5	753	C
52	5	754	U
52	5	774	A
52	5	778	A
52	5	780	U
52	5	784	A
52	5	787	A
52	5	796	A
52	5	802	C
52	5	809	G
52	5	812	A
52	5	813	A
52	5	814	C
52	5	817	U
52	5	818	A
52	5	819	G
52	5	825	A
52	5	829	G
52	5	834	G
52	5	835	G
52	5	838	A
52	5	840	C
52	5	842	C
52	5	844	U
52	5	849	A
52	5	852	G
52	5	861	A
52	5	865	U
52	5	866	A

*Continued on next page...*

*Continued from previous page...*

<b>Mol</b>	<b>Chain</b>	<b>Res</b>	<b>Type</b>
52	5	867	A
52	5	871	U
52	5	874	C
52	5	877	C
52	5	879	G
52	5	883	A
52	5	884	G
52	5	885	U
52	5	894	A
52	5	897	A
52	5	905	U
52	5	908	A
52	5	909	A
52	5	910	C
52	5	911	G
52	5	912	G
52	5	915	U
52	5	921	G
52	5	922	G
52	5	929	C
52	5	930	A
52	5	932	A
52	5	940	G
52	5	944	A
52	5	953	A
52	5	954	A
52	5	955	U
52	5	956	U
52	5	960	C
52	5	961	G
52	5	963	U
52	5	964	A
52	5	966	A
52	5	967	C
52	5	969	A
52	5	970	A
52	5	971	A
52	5	972	A
52	5	973	A
52	5	977	U
52	5	979	C
52	5	984	A

*Continued on next page...*



*Continued from previous page...*

<b>Mol</b>	<b>Chain</b>	<b>Res</b>	<b>Type</b>
52	5	985	C
52	5	986	U
52	5	987	U
52	5	988	G
52	5	989	A
52	5	991	A
52	5	997	G
52	5	998	G
52	5	1000	A
52	5	1001	A
52	5	1003	G
52	5	1004	U
52	5	1005	U
52	5	1006	A
52	5	1010	A
52	5	1012	A
52	5	1013	C
52	5	1014	A
52	5	1015	U
52	5	1016	A
52	5	1017	A
52	5	1018	U
52	5	1019	G
52	5	1037	A
52	5	1041	G
52	5	1044	G
52	5	1045	C
52	5	1047	U
52	5	1048	G
52	5	1053	U
52	5	1054	C
52	5	1055	G
52	5	1056	U
52	5	1060	C
52	5	1061	U
52	5	1070	G
52	5	1073	A
52	5	1075	G
52	5	1077	U
52	5	1083	A
52	5	1084	A
52	5	1085	G

*Continued on next page...*

*Continued from previous page...*

<b>Mol</b>	<b>Chain</b>	<b>Res</b>	<b>Type</b>
52	5	1086	U
52	5	1088	C
52	5	1089	C
52	5	1092	A
52	5	1095	G
52	5	1099	G
52	5	1102	A
52	5	1108	A
52	5	1109	U
52	5	1113	U
52	5	1116	U
52	5	1117	U
52	5	1118	A
52	5	1121	U
52	5	1122	U
52	5	1124	U
52	5	1125	C
52	5	1128	G
52	5	1134	C
52	5	1135	U
52	5	1136	G
52	5	1139	A
52	5	1140	A
52	5	1141	U
52	5	1142	G
52	5	1145	A
52	5	1157	G
52	5	1158	A
52	5	1159	A
52	5	1164	U
52	5	1166	A
52	5	1168	G
52	5	1170	C
52	5	1171	A
52	5	1173	A
52	5	1175	C
52	5	1176	A
52	5	1177	U
52	5	1181	G
52	5	1186	U
52	5	1188	A
52	5	1189	U

*Continued on next page...*

*Continued from previous page...*

<b>Mol</b>	<b>Chain</b>	<b>Res</b>	<b>Type</b>
52	5	1194	A
52	5	1199	U
52	5	1200	G
52	5	1202	A
52	5	1203	A
52	5	1208	G
52	5	1211	A
52	5	1213	A
52	5	1215	U
52	5	1216	G
52	5	1220	A
52	5	1225	A
52	5	1229	A
52	5	1232	C
52	5	1233	G
52	5	1235	C
52	5	1236	A
52	5	1243	A
52	5	1254	A
52	5	1255	A
52	5	1260	U
52	5	1261	A
52	5	1266	U
52	5	1271	U
52	5	1273	A
52	5	1274	G
52	5	1276	U
52	5	1277	C
52	5	1279	G
52	5	1280	A
52	5	1281	U
52	5	1287	G
52	5	1289	U
52	5	1293	A
52	5	1296	C
52	5	1297	G
52	5	1299	C
52	5	1305	G
52	5	1319	U
52	5	1321	G
52	5	1322	U
52	5	1326	C

*Continued on next page...*

*Continued from previous page...*

<b>Mol</b>	<b>Chain</b>	<b>Res</b>	<b>Type</b>
52	5	1333	C
52	5	1334	A
52	5	1335	G
52	5	1336	C
52	5	1337	U
52	5	1338	A
52	5	1343	G
52	5	1345	G
52	5	1354	G
52	5	1356	U
52	5	1363	U
52	5	1369	A
52	5	1373	A
52	5	1374	C
52	5	1380	G
52	5	1381	U
52	5	1383	A
52	5	1384	A
52	5	1390	G
52	5	1402	U
52	5	1403	A
52	5	1404	U
52	5	1406	U
52	5	1408	A
52	5	1412	C
52	5	1415	G
52	5	1417	U
52	5	1418	G
52	5	1420	U
52	5	1423	C
52	5	1425	A
52	5	1426	U
52	5	1429	G
52	5	1439	G
52	5	1440	U
52	5	1441	C
52	5	1448	A
52	5	1450	C
52	5	1459	U
52	5	1467	A
52	5	1468	A
52	5	1470	U

*Continued on next page...*

*Continued from previous page...*

<b>Mol</b>	<b>Chain</b>	<b>Res</b>	<b>Type</b>
52	5	1471	C
52	5	1475	A
52	5	1477	A
52	5	1479	G
52	5	1480	G
52	5	1481	U
52	5	1482	A
52	5	1494	A
52	5	1495	C
52	5	1504	G
52	5	1505	G
53	7	5	C
53	7	9	U
53	7	14	C
53	7	15	A
53	7	17	U
53	7	19	G
53	7	21	U
53	7	22	A
53	7	23	G
53	7	24	A
53	7	27	A
53	7	35	G
53	7	37	A
53	7	42	C
53	7	44	U
53	7	47	G
53	7	48	U
53	7	49	C
53	7	50	G
53	7	54	G
53	7	57	C
53	7	58	G
53	7	60	U
53	7	61	U
53	7	62	C
53	7	70	G
53	7	71	A
53	7	72	C
53	7	73	C
53	7	77	A
53	8	5	C

*Continued on next page...*

*Continued from previous page...*

<b>Mol</b>	<b>Chain</b>	<b>Res</b>	<b>Type</b>
53	8	9	U
53	8	14	C
53	8	15	A
53	8	17	U
53	8	19	G
53	8	21	U
53	8	22	A
53	8	23	G
53	8	24	A
53	8	27	A
53	8	35	G
53	8	37	A
53	8	42	C
53	8	44	U
53	8	47	G
53	8	48	U
53	8	49	C
53	8	50	G
53	8	54	G
53	8	57	C
53	8	58	G
53	8	60	U
53	8	61	U
53	8	62	C
53	8	70	G
53	8	71	A
53	8	72	C
53	8	73	C
53	8	77	A

All (64) RNA pucker outliers are listed below:

<b>Mol</b>	<b>Chain</b>	<b>Res</b>	<b>Type</b>
50	3	232	A
50	3	276	A
50	3	296	U
50	3	311	G
50	3	410	G
50	3	425	U
50	3	513	A
50	3	515	A
50	3	562	C

*Continued on next page...*

*Continued from previous page...*

<b>Mol</b>	<b>Chain</b>	<b>Res</b>	<b>Type</b>
50	3	635	G
50	3	663	A
50	3	881	A
50	3	952	U
50	3	1124	G
50	3	1209	U
50	3	1216	U
50	3	1297	U
50	3	1386	G
50	3	1465	U
50	3	1507	G
50	3	1587	U
50	3	1588	A
50	3	1687	G
50	3	1703	A
50	3	1749	A
50	3	1827	U
50	3	2318	A
50	3	2341	G
50	3	2506	C
50	3	2604	U
50	3	2645	U
50	3	2668	A
50	3	2823	A
50	3	2897	G
51	4	32	G
51	4	50	C
51	4	54	U
51	4	59	A
51	4	101	C
52	5	113	C
52	5	159	U
52	5	270	A
52	5	340	A
52	5	410	A
52	5	419	A
52	5	425	G
52	5	493	A
52	5	561	A
52	5	808	C
52	5	893	C
52	5	1017	A

*Continued on next page...*

*Continued from previous page...*

Mol	Chain	Res	Type
52	5	1083	A
52	5	1115	G
52	5	1133	A
52	5	1135	U
52	5	1156	G
52	5	1336	C
52	5	1480	G
53	7	16	G
53	7	57	C
53	7	71	A
53	8	16	G
53	8	57	C
53	8	71	A

#### 5.4 Non-standard residues in protein, DNA, RNA chains [i](#)

There are no non-standard protein/DNA/RNA residues in this entry.

#### 5.5 Carbohydrates [i](#)

There are no monosaccharides in this entry.

#### 5.6 Ligand geometry [i](#)

There are no ligands in this entry.

#### 5.7 Other polymers [i](#)

There are no such residues in this entry.

#### 5.8 Polymer linkage issues [i](#)

There are no chain breaks in this entry.



## 6 Map visualisation [i](#)

This section contains visualisations of the EMDB entry EMD-13434. These allow visual inspection of the internal detail of the map and identification of artifacts.

Images derived from a raw map, generated by summing the deposited half-maps, are presented below the corresponding image components of the primary map to allow further visual inspection and comparison with those of the primary map.

### 6.1 Orthogonal projections [i](#)

#### 6.1.1 Primary map

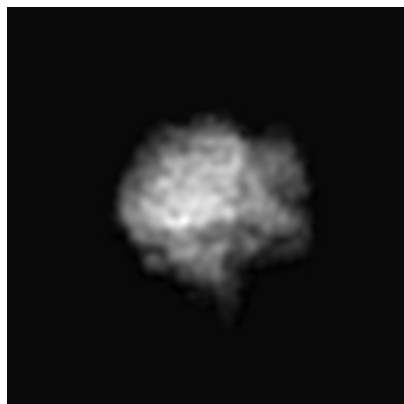

X

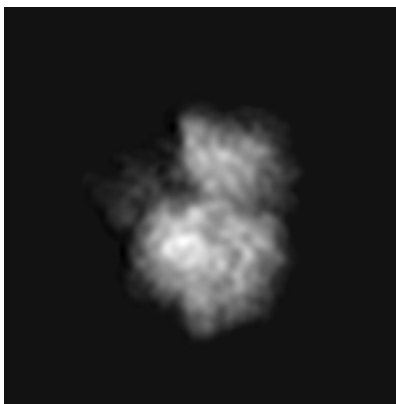

Y

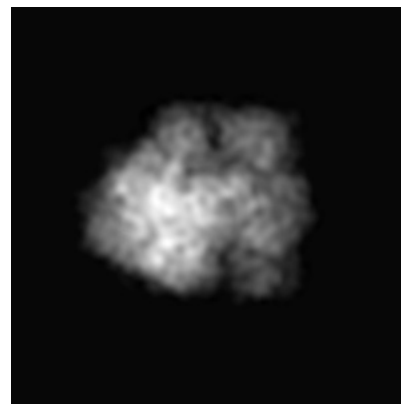

Z

#### 6.1.2 Raw map

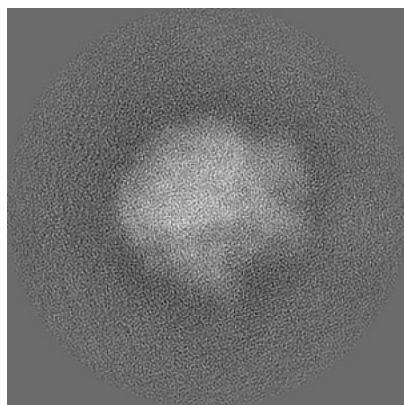

X

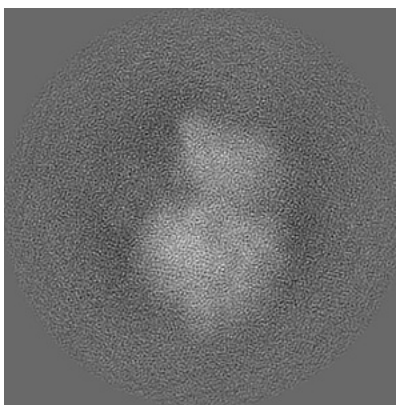

Y

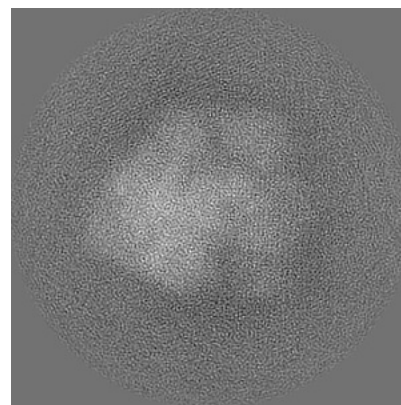

Z

The images above show the map projected in three orthogonal directions.

## 6.2 Central slices [i](#)

### 6.2.1 Primary map

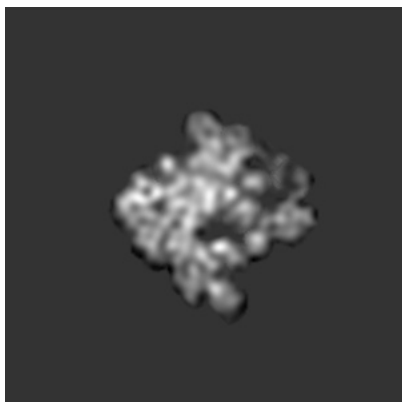

X Index: 128

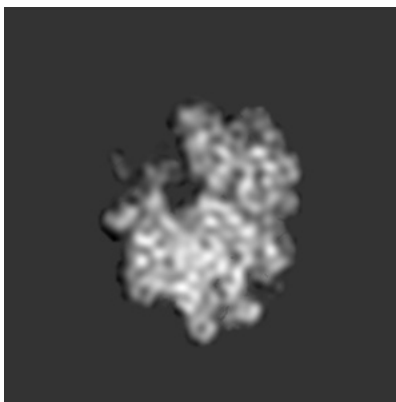

Y Index: 128

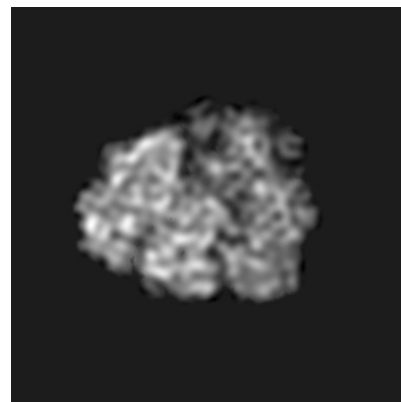

Z Index: 128

### 6.2.2 Raw map

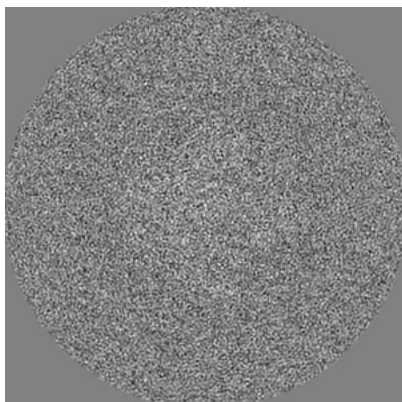

X Index: 128

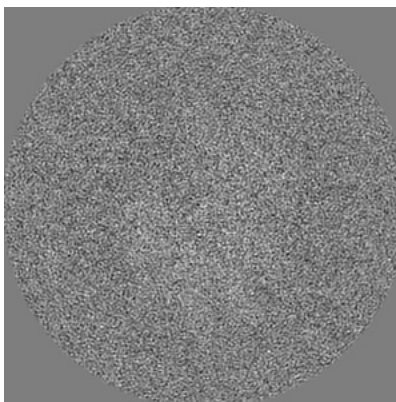

Y Index: 128

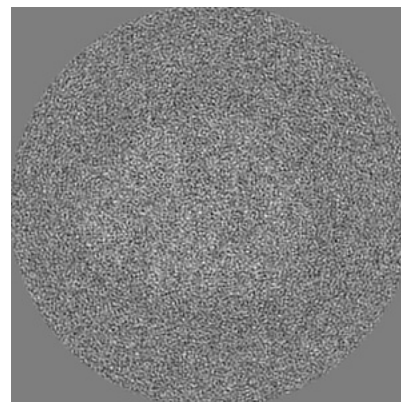

Z Index: 128

The images above show central slices of the map in three orthogonal directions.

## 6.3 Largest variance slices [i](#)

### 6.3.1 Primary map



X Index: 102

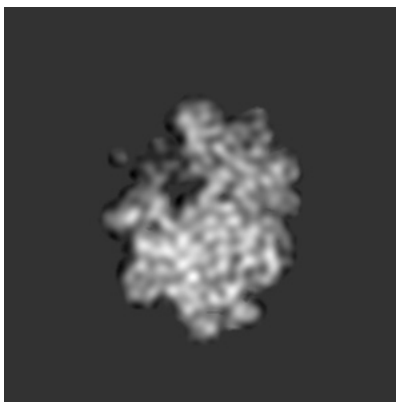

Y Index: 124

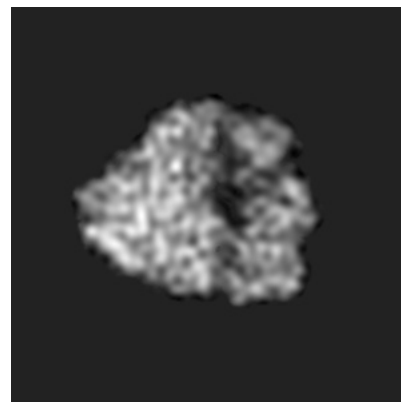

Z Index: 121

### 6.3.2 Raw map

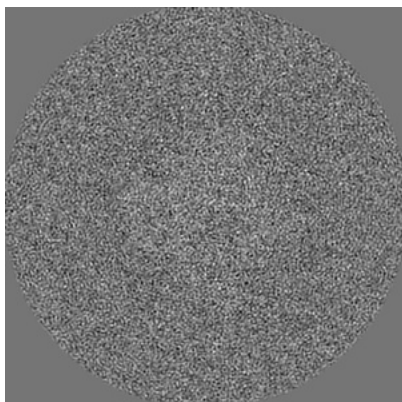

X Index: 130

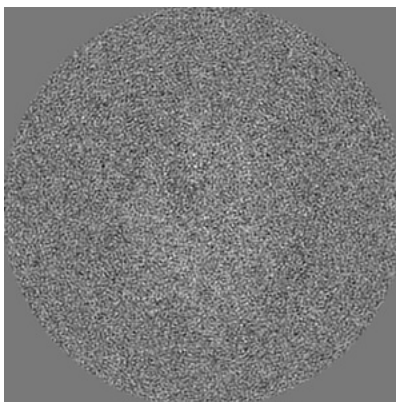

Y Index: 124

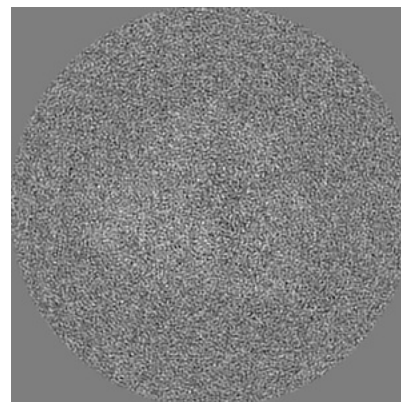

Z Index: 120

The images above show the largest variance slices of the map in three orthogonal directions.

## 6.4 Orthogonal surface views [i](#)

### 6.4.1 Primary map

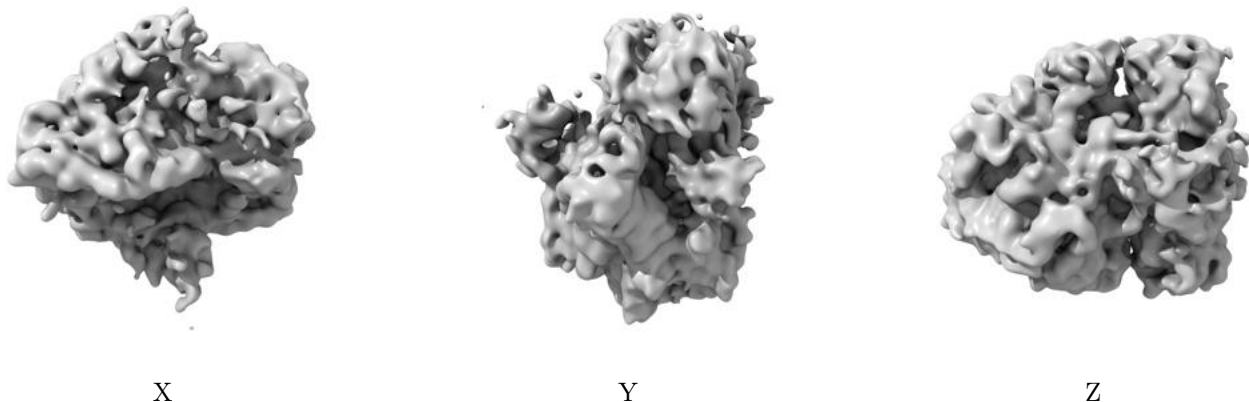

The images above show the 3D surface view of the map at the recommended contour level 0.22. These images, in conjunction with the slice images, may facilitate assessment of whether an appropriate contour level has been provided.

### 6.4.2 Raw map

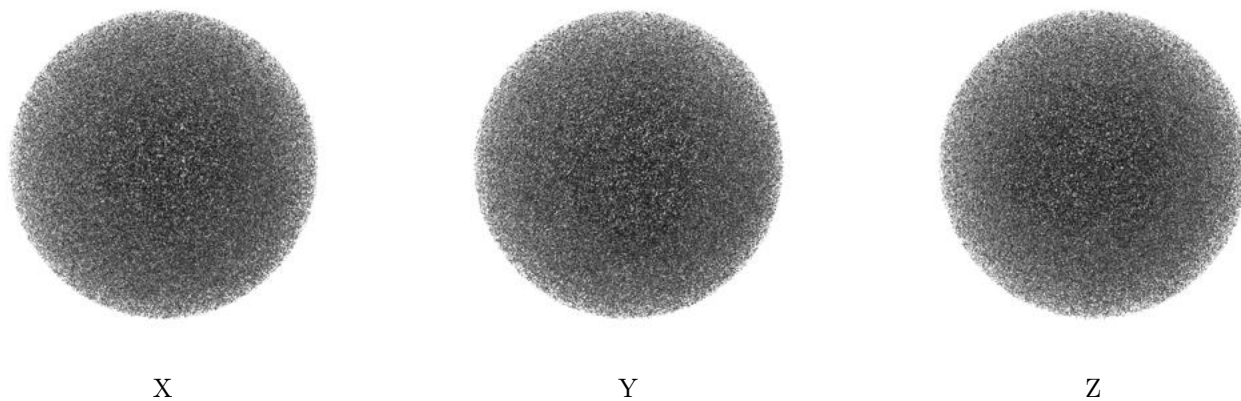

These images show the 3D surface of the raw map. The raw map's contour level was selected so that its surface encloses the same volume as the primary map does at its recommended contour level.

## 6.5 Mask visualisation [i](#)

This section shows the 3D surface view of the primary map at 50% transparency overlaid with the specified mask at 0% transparency

A mask typically either:

- Encompasses the whole structure
- Separates out a domain, a functional unit, a monomer or an area of interest from a larger structure

### 6.5.1 emd\_13434\_msk\_1.map [i](#)

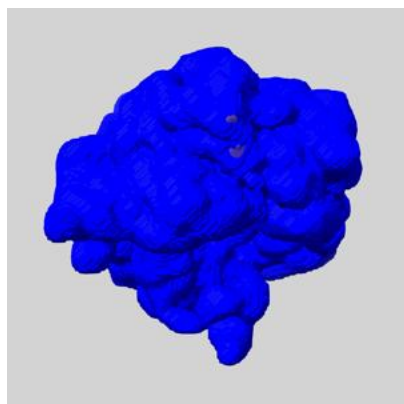

X

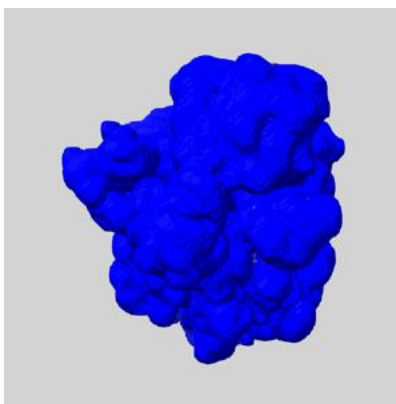

Y

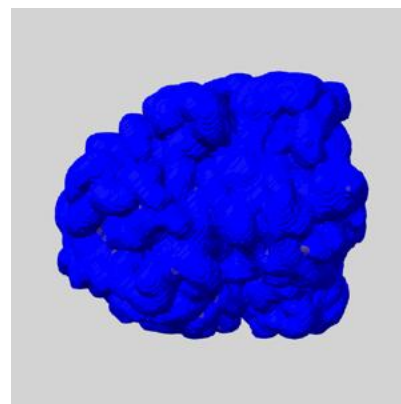

Z

## 7 Map analysis [i](#)

This section contains the results of statistical analysis of the map.

### 7.1 Map-value distribution [i](#)

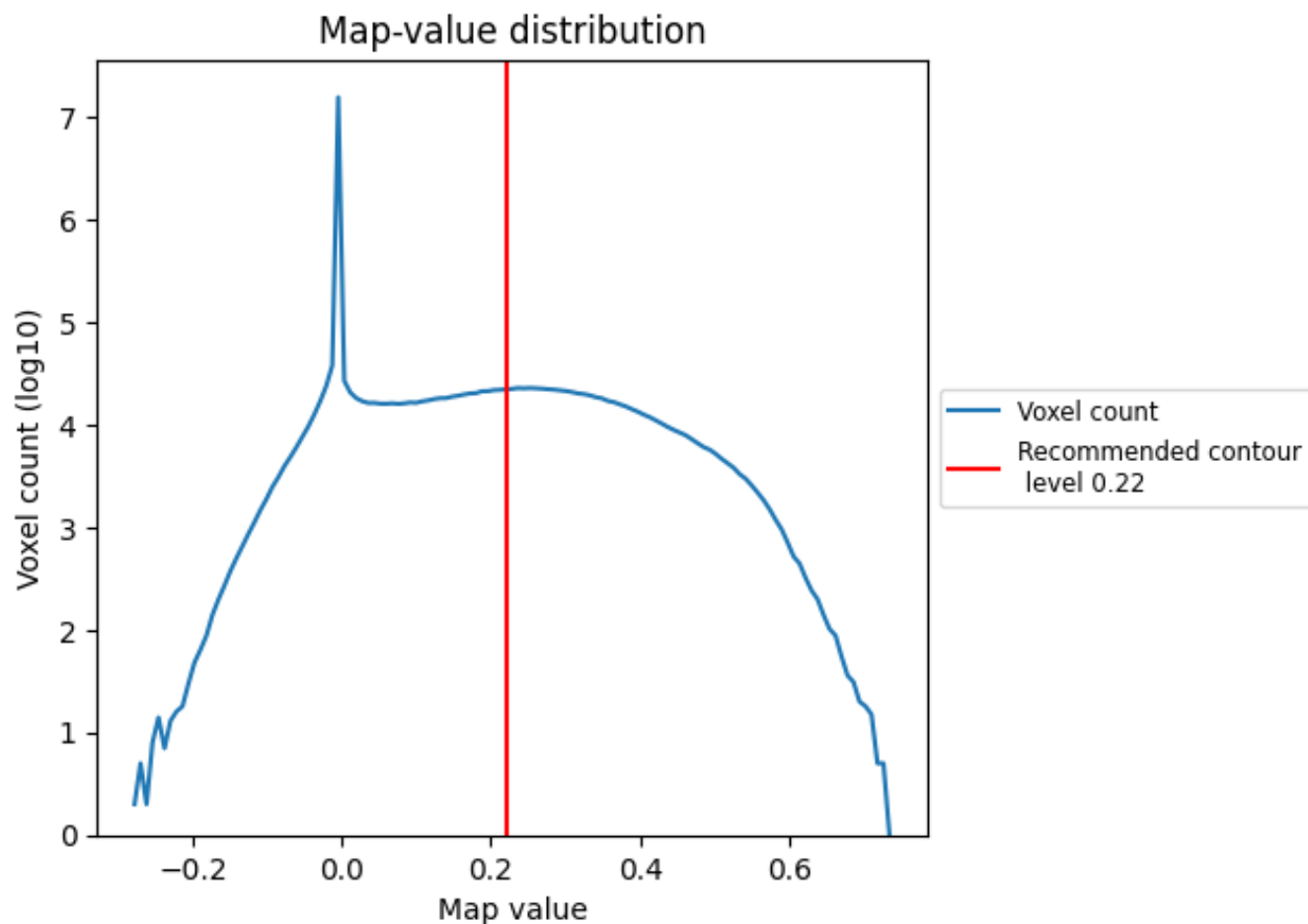

The map-value distribution is plotted in 128 intervals along the x-axis. The y-axis is logarithmic. A spike in this graph at zero usually indicates that the volume has been masked.

## 7.2 Volume estimate [i](#)

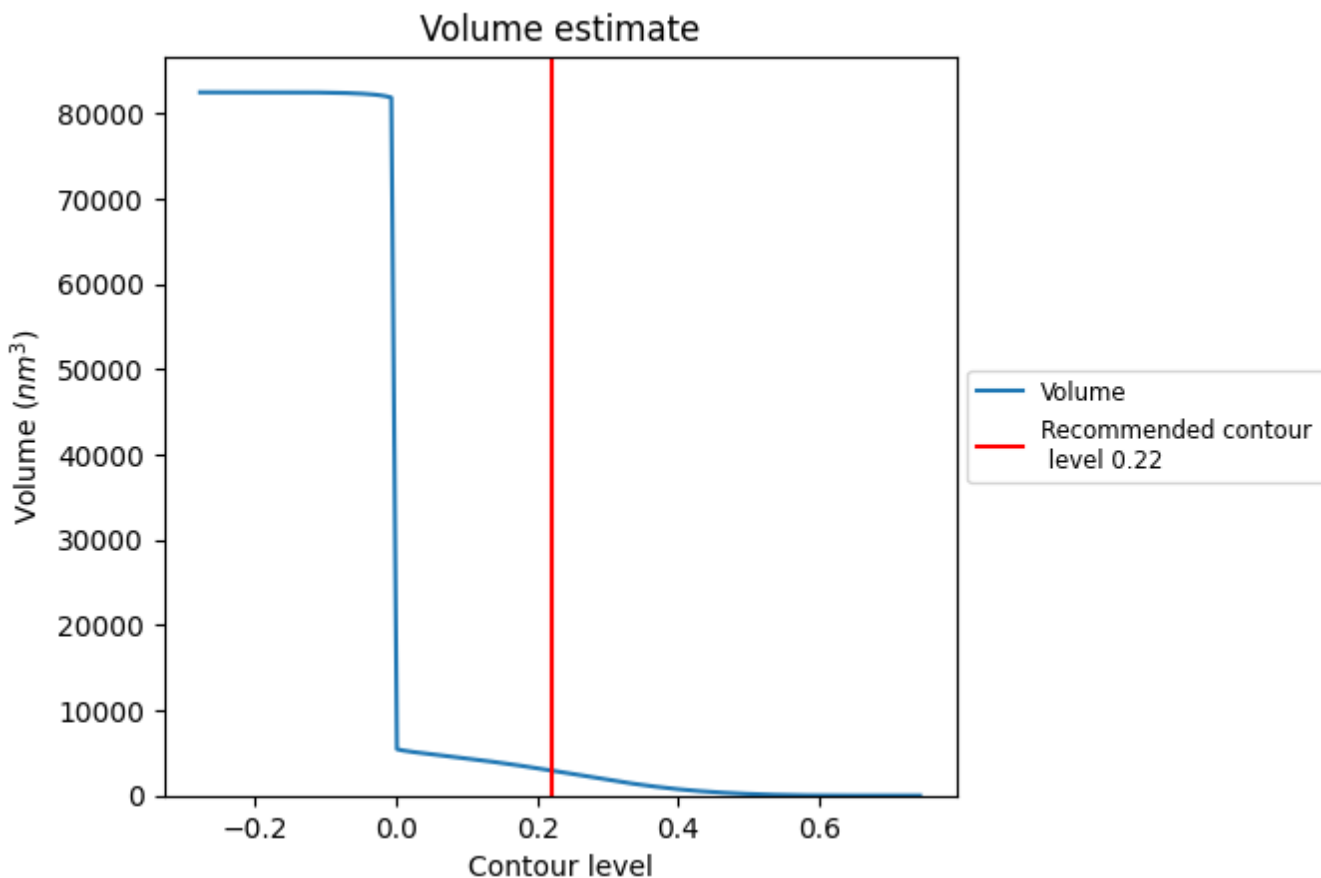

The volume at the recommended contour level is 2941 nm<sup>3</sup>; this corresponds to an approximate mass of 2657 kDa.

The volume estimate graph shows how the enclosed volume varies with the contour level. The recommended contour level is shown as a vertical line and the intersection between the line and the curve gives the volume of the enclosed surface at the given level.

### 7.3 Rotationally averaged power spectrum i

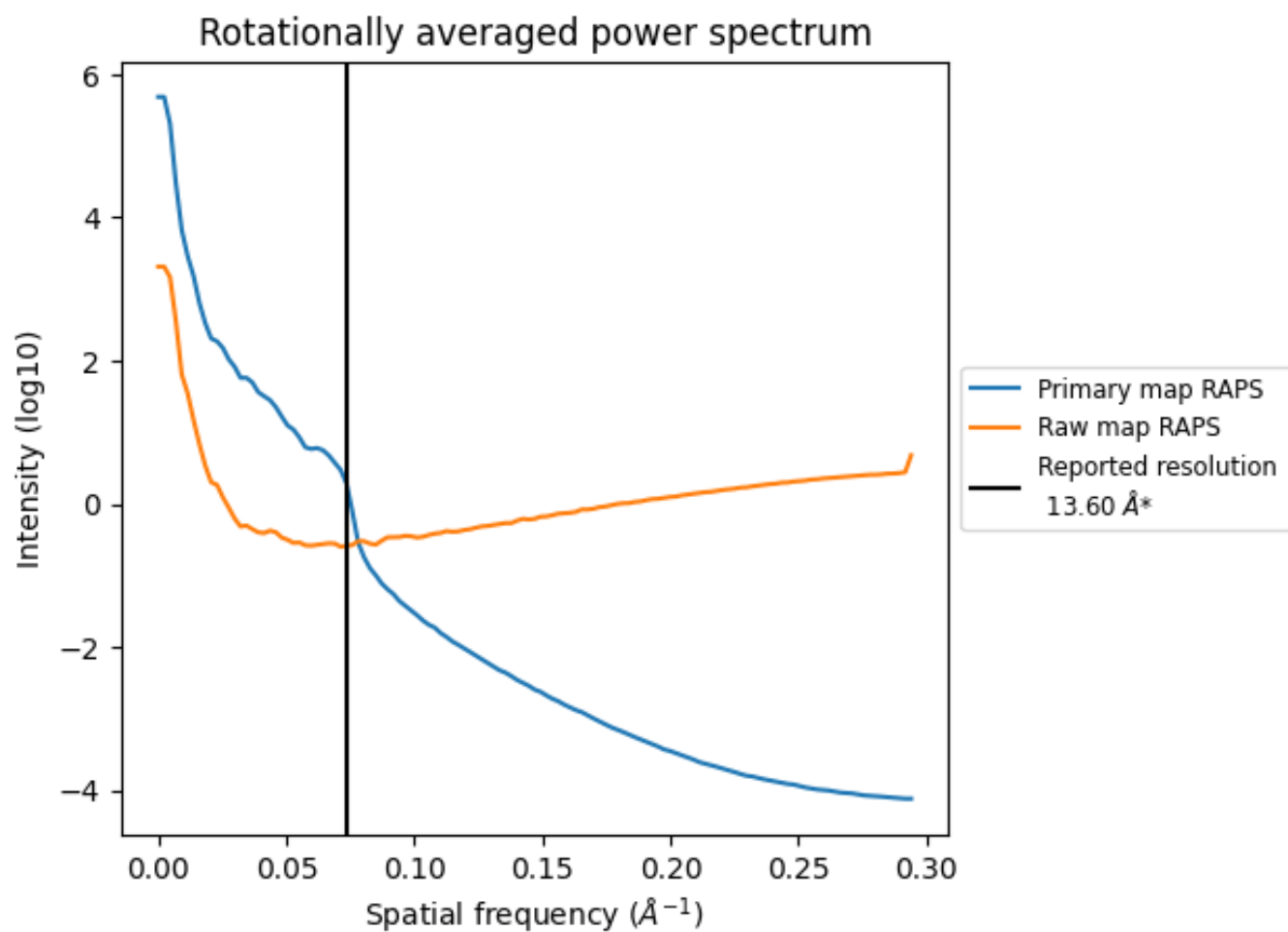

\*Reported resolution corresponds to spatial frequency of 0.074 Å<sup>-1</sup>



## 8 Fourier-Shell correlation [i](#)

Fourier-Shell Correlation (FSC) is the most commonly used method to estimate the resolution of single-particle and subtomogram-averaged maps. The shape of the curve depends on the imposed symmetry, mask and whether or not the two 3D reconstructions used were processed from a common reference. The reported resolution is shown as a black line. A curve is displayed for the half-bit criterion in addition to lines showing the 0.143 gold standard cut-off and 0.5 cut-off.

### 8.1 FSC [i](#)

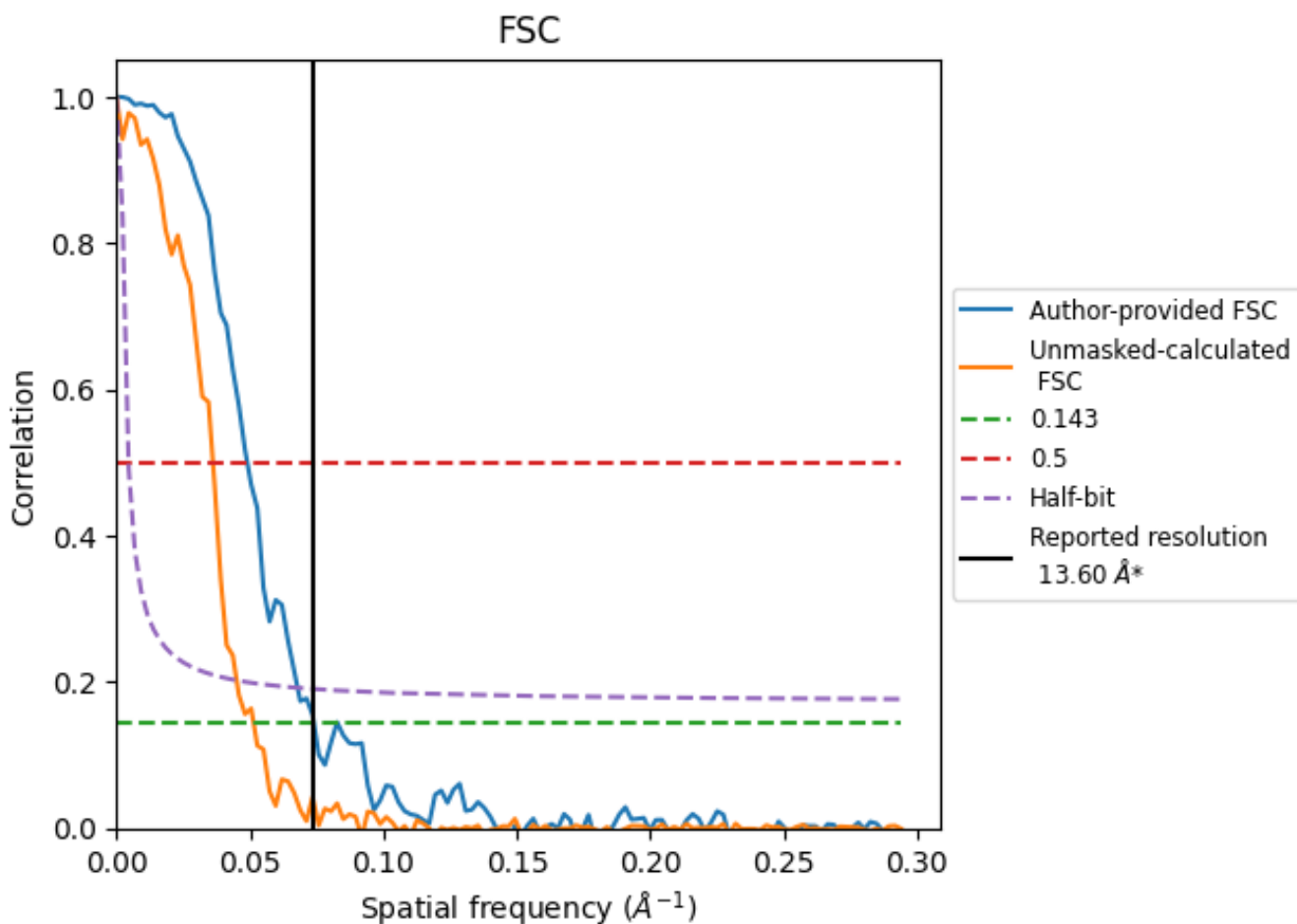

\*Reported resolution corresponds to spatial frequency of 0.074 Å<sup>-1</sup>

## 8.2 Resolution estimates [i](#)

Resolution estimate (Å)	Estimation criterion (FSC cut-off)		
	0.143	0.5	Half-bit
Reported by author	13.60	-	-
Author-provided FSC curve	13.51	20.37	14.73
Unmasked-calculated*	19.46	27.70	22.17

\*Resolution estimate based on FSC curve calculated by comparison of deposited half-maps. The value from deposited half-maps intersecting FSC 0.143 CUT-OFF 19.46 differs from the reported value 13.6 by more than 10 %

## 9 Map-model fit [i](#)

This section contains information regarding the fit between EMDB map EMD-13434 and PDB model 7PIA. Per-residue inclusion information can be found in section 3 on page 13.

### 9.1 Map-model overlay [i](#)

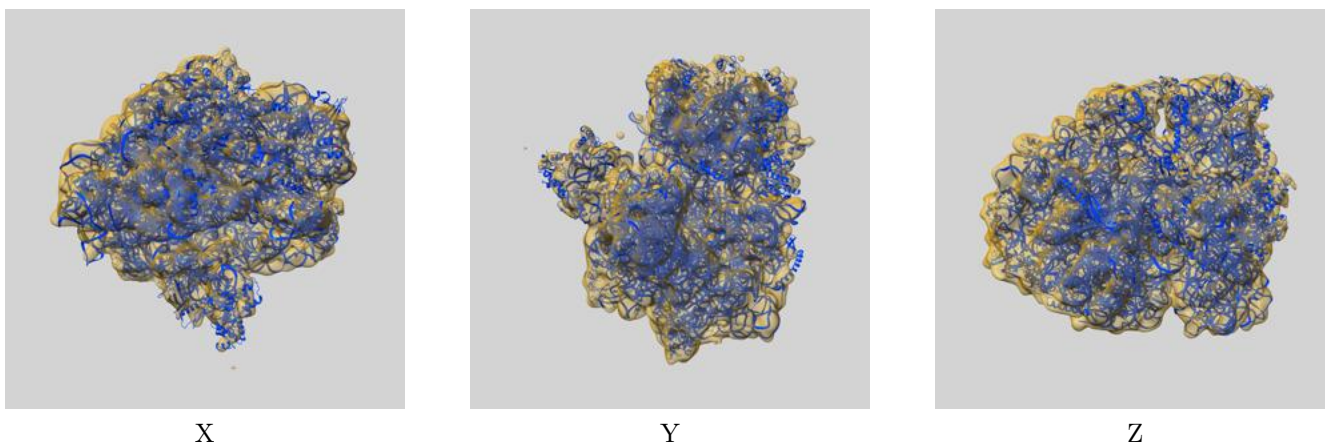

The images above show the 3D surface view of the map at the recommended contour level 0.22 at 50% transparency in yellow overlaid with a ribbon representation of the model coloured in blue. These images allow for the visual assessment of the quality of fit between the atomic model and the map.

## 9.2 Q-score mapped to coordinate model [\(i\)](#)

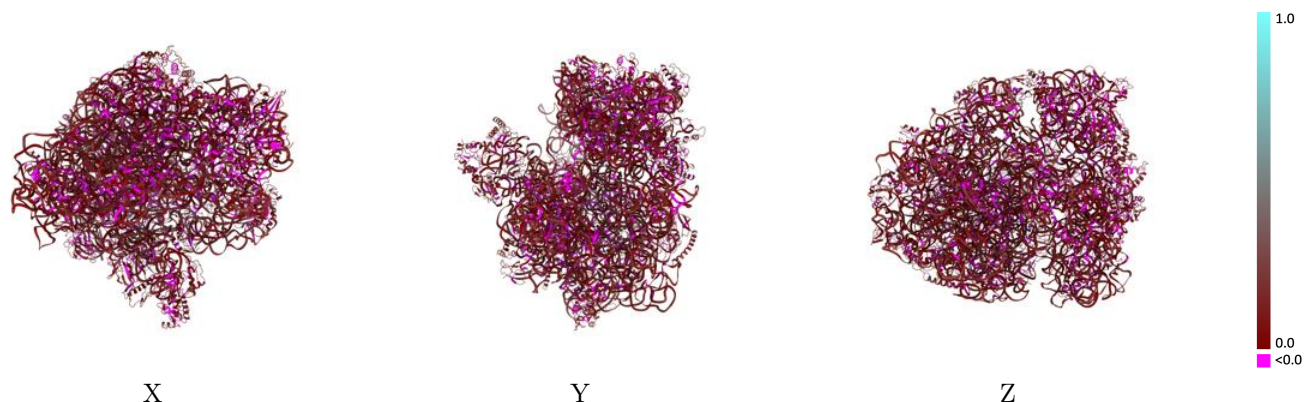

The images above show the model with each residue coloured according to its Q-score. This shows their resolvability in the map with higher Q-score values reflecting better resolvability. Please note: Q-score is calculating the resolvability of atoms, and thus high values are only expected at resolutions at which atoms can be resolved. Low Q-score values may therefore be expected for many entries.

## 9.3 Atom inclusion mapped to coordinate model [\(i\)](#)

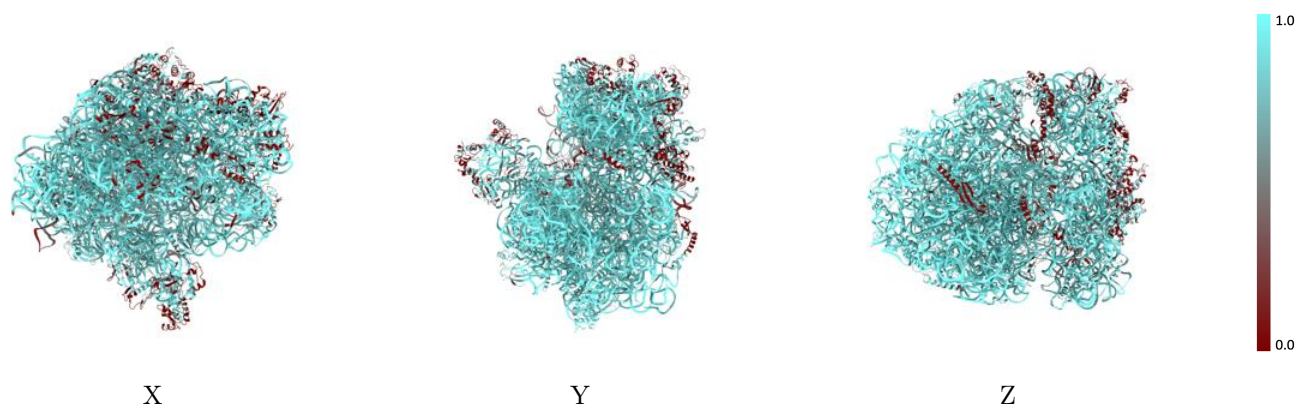

The images above show the model with each residue coloured according to its atom inclusion. This shows to what extent they are inside the map at the recommended contour level (0.22).



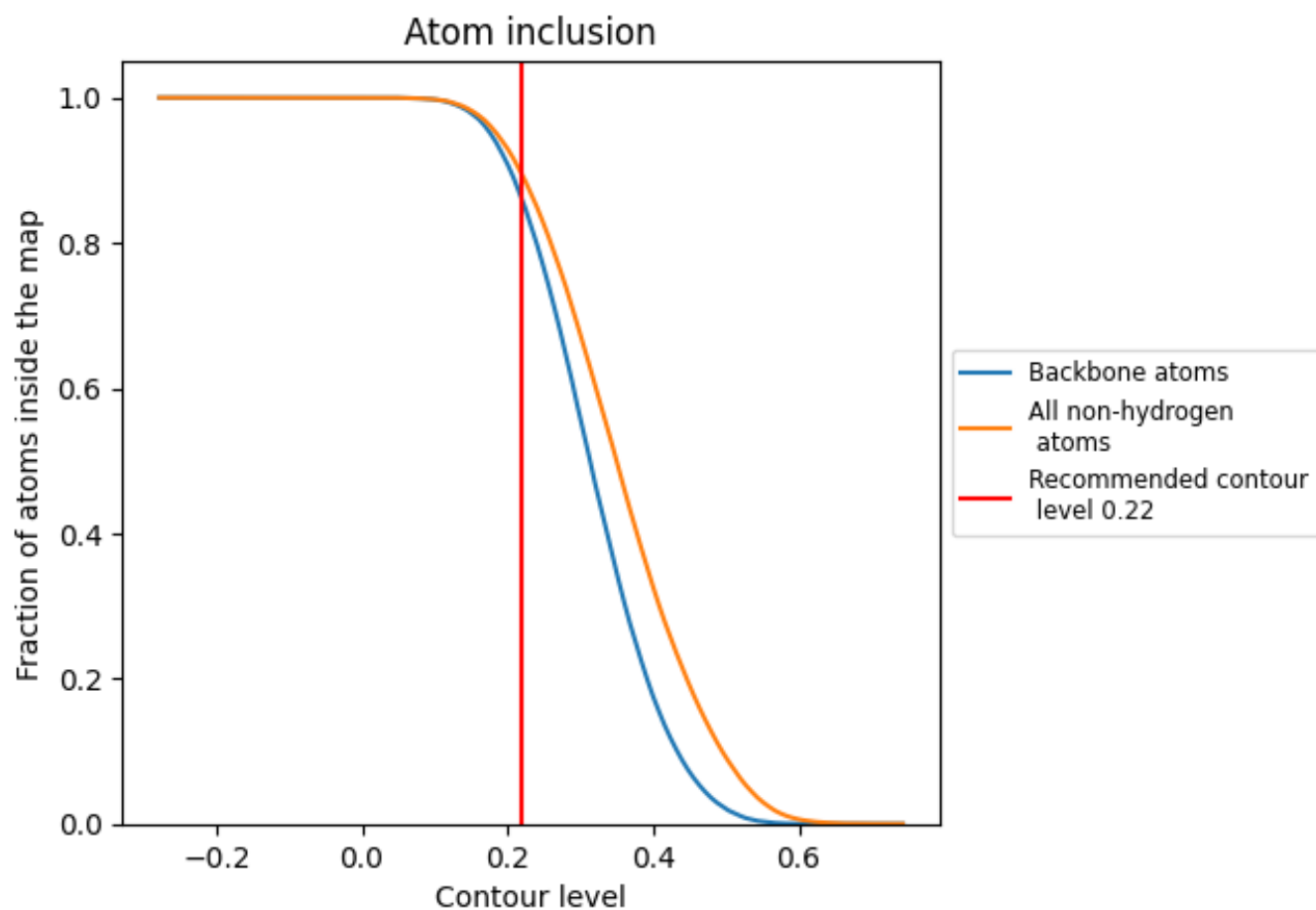



































































## 9.4 Atom inclusion [i](#)



At the recommended contour level, 86% of all backbone atoms, 89% of all non-hydrogen atoms, are inside the map.

## 9.5 Map-model fit summary









































The table lists the average atom inclusion at the recommended contour level (0.22) and Q-score for the entire model and for each chain.

Chain	Atom inclusion	Q-score
All	 0.8942	 0.0870
0	 0.9808	 0.0300
1	 1.0000	 0.0060
2	 0.9426	 0.0510
3	 0.9820	 0.1010
4	 0.9669	 0.1070
5	 0.9464	 0.0960
7	 0.7849	 0.0600
8	 0.9129	 0.1020
A	 0.4834	 0.0800
B	 0.5682	 0.0600
C	 0.6777	 0.0520
D	 0.5397	 0.0560
E	 0.4790	 0.1070
F	 0.4198	 0.0660
G	 0.5096	 0.0510
H	 0.5355	 0.0430
I	 0.6352	 0.0390
J	 0.5471	 0.0530
K	 0.7069	 0.0370
L	 0.5185	 0.0550
M	 0.9670	 0.0460
N	 0.5785	 0.0620
O	 0.7202	 0.0290
P	 0.6560	 0.0700
Q	 0.7035	 0.0290
R	 0.7522	 0.0580
S	 0.8344	 0.0550
T	 0.6786	 0.1220
a	 0.9599	 0.0510
b	 0.9286	 0.0500
c	 0.9748	 0.0580
d	 0.7946	 0.0780
e	 0.5138	 0.0830
f	 0.4868	 0.0920



*Continued on next page...*

*Continued from previous page...*

Chain	Atom inclusion	Q-score
g	 0.4189	 0.0810
h	 0.3626	 0.0820
i	 0.9299	 0.0490
j	 0.7152	 0.0640
k	 0.9762	 0.0540
l	 0.9327	 0.0530
m	 0.9850	 0.0500
n	 0.9112	 0.0630
o	 0.7267	 0.0480
p	 0.9486	 0.0590
q	 0.8949	 0.0780
r	 0.9943	 0.0750
s	 0.9647	 0.0740
t	 0.9605	 0.0770
u	 0.9828	 0.0480
v	 0.9960	 0.0550
w	 0.9176	 0.0840
x	 0.7172	 0.1250
y	 0.9539	 0.0400
z	 0.9975	 0.0340