



Full wwPDB EM Validation Report ⓘ

Nov 20, 2022 – 12:33 pm GMT

PDB ID : 6Q9B
EMDB ID : EMD-4479
Title : CI Membrane Arm focused refinement from Ovine respiratory SC I+III2
Authors : Letts, J.A.; Sazanov, L.A.
Deposited on : 2018-12-17
Resolution : 3.90 Å (reported)
Based on initial model : 1LNK

This is a Full wwPDB EM Validation Report for a publicly released PDB entry.

We welcome your comments at validation@mail.wwpdb.org

A user guide is available at

<https://www.wwpdb.org/validation/2017/EMValidationReportHelp>

with specific help available everywhere you see the ⓘ symbol.

The types of validation reports are described at

<http://www.wwpdb.org/validation/2017/FAQs#types>.

The following versions of software and data (see [references ⓘ](#)) were used in the production of this report:

EMDB validation analysis : 0.0.1.dev43
Mogul : 1.8.4, CSD as541be (2020)
MolProbity : 4.02b-467
buster-report : 1.1.7 (2018)
Percentile statistics : 20191225.v01 (using entries in the PDB archive December 25th 2019)
MapQ : 1.9.9
Ideal geometry (proteins) : Engh & Huber (2001)
Ideal geometry (DNA, RNA) : Parkinson et al. (1996)
Validation Pipeline (wwPDB-VP) : 2.31.2

1 Overall quality at a glance

The following experimental techniques were used to determine the structure:

ELECTRON MICROSCOPY

The reported resolution of this entry is 3.90 Å.

Percentile scores (ranging between 0-100) for global validation metrics of the entry are shown in the following graphic. The table shows the number of entries on which the scores are based.

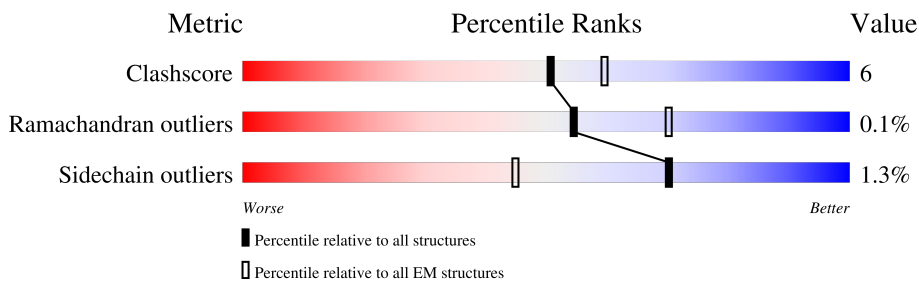

Metric	Whole archive (#Entries)	EM structures (#Entries)
Clashscore	158937	4297
Ramachandran outliers	154571	4023
Sidechain outliers	154315	3826

The table below summarises the geometric issues observed across the polymeric chains and their fit to the map. The red, orange, yellow and green segments of the bar indicate the fraction of residues that contain outliers for ≥ 3 , 2, 1 and 0 types of geometric quality criteria respectively. A grey segment represents the fraction of residues that are not modelled. The numeric value for each fraction is indicated below the corresponding segment, with a dot representing fractions $\leq 5\%$. The upper red bar (where present) indicates the fraction of residues that have poor fit to the EM map (all-atom inclusion $< 40\%$). The numeric value is given above the bar.

Mol	Chain	Length	Quality of chain
1	S2	430	
2	D3	115	
3	D1	318	
4	D6	175	
5	4L	98	
6	D5	606	
7	D4	459	
8	D2	347	

Continued on next page...

Continued from previous page...

Mol	Chain	Length	Quality of chain
9	AK	140	29% 84% 16% .
10	B5	143	9% 85% 11% ..
11	AB	88	13% 90% 9% .
12	A8	171	13% 80% 19% .
13	BJ	175	10% 85% 12% ..
14	AJ	320	17% 80% 19% .
15	S5	105	16% 83% 11% 6%
16	A3	83	25% 78% 10% . 11%
17	B3	97	15% 70% 25%
18	C2	120	12% 90% 8% ..
19	B4	128	12% 81% 18% .
20	AM	143	6% 59% 20% 20%
21	B6	127	11% 61% 13% . 25%
22	B7	136	15% 69% 17% . 12%
23	B9	178	8% 79% 19% ..
24	B2	72	26% 74% 17% 10%
25	B8	158	19% 78% 20% ..
26	BK	125	11% 67% 14% 18%
27	C1	49	14% 86% 8% 6%
28	B1	57	25% 81% 11% 9%
29	A1	70	16% 89% 11%

2 Entry composition i

There are 33 unique types of molecules in this entry. The entry contains 38012 atoms, of which 0 are hydrogens and 0 are deuteriums.

In the tables below, the AltConf column contains the number of residues with at least one atom in alternate conformation and the Trace column contains the number of residues modelled with at most 2 atoms.

- Molecule 1 is a protein called NADH:ubiquinone oxidoreductase core subunit S2,NADH:ubiquinone oxidoreductase core subunit S2.

Mol	Chain	Residues	Atoms					AltConf	Trace
			Total	C	N	O	S		
1	S2	39	325	211	54	59	1	0	0

There are 18 discrepancies between the modelled and reference sequences:

Chain	Residue	Modelled	Actual	Comment	Reference
S2	1	ALA	-	insertion	UNP W5PJ73
S2	2	ARG	-	insertion	UNP W5PJ73
S2	3	GLN	-	expression tag	UNP W5PJ73
S2	4	TRP	-	expression tag	UNP W5PJ73
S2	5	GLN	-	expression tag	UNP W5PJ73
S2	6	PRO	-	expression tag	UNP W5PJ73
S2	7	ASP	-	expression tag	UNP W5PJ73
S2	8	VAL	-	expression tag	UNP W5PJ73
S2	9	GLU	-	expression tag	UNP W5PJ73
S2	10	TRP	-	expression tag	UNP W5PJ73
S2	11	ALA	-	expression tag	UNP W5PJ73
S2	12	GLU	-	expression tag	UNP W5PJ73
S2	13	GLN	-	expression tag	UNP W5PJ73
S2	14	TYR	-	expression tag	UNP W5PJ73
S2	15	GLY	-	expression tag	UNP W5PJ73
S2	16	GLY	-	expression tag	UNP W5PJ73
S2	17	ALA	-	expression tag	UNP W5PJ73
S2	18	VAL	-	expression tag	UNP W5PJ73

- Molecule 2 is a protein called NADH-ubiquinone oxidoreductase chain 3.

Mol	Chain	Residues	Atoms					AltConf	Trace
			Total	C	N	O	S		
2	D3	90	728	500	103	120	5	0	0

- Molecule 3 is a protein called NADH-ubiquinone oxidoreductase chain 1.

Mol	Chain	Residues	Atoms					AltConf	Trace
			Total	C	N	O	S		
3	D1	301	2400	1623	366	392	19	0	0

- Molecule 4 is a protein called NADH-ubiquinone oxidoreductase chain 6.

Mol	Chain	Residues	Atoms					AltConf	Trace
			Total	C	N	O	S		
4	D6	171	1308	878	187	230	13	0	0

- Molecule 5 is a protein called NADH-ubiquinone oxidoreductase chain 4L.

Mol	Chain	Residues	Atoms					AltConf	Trace
			Total	C	N	O	S		
5	4L	98	748	489	112	132	15	0	0

- Molecule 6 is a protein called NADH-ubiquinone oxidoreductase chain 5.

Mol	Chain	Residues	Atoms					AltConf	Trace
			Total	C	N	O	S		
6	D5	606	4805	3187	746	828	44	0	0

- Molecule 7 is a protein called NADH-ubiquinone oxidoreductase chain 4.

Mol	Chain	Residues	Atoms					AltConf	Trace
			Total	C	N	O	S		
7	D4	459	3646	2428	571	607	40	0	0

- Molecule 8 is a protein called NADH-ubiquinone oxidoreductase chain 2.

Mol	Chain	Residues	Atoms					AltConf	Trace
			Total	C	N	O	S		
8	D2	347	2724	1808	416	460	40	0	0

- Molecule 9 is a protein called NADH dehydrogenase [ubiquinone] 1 alpha subcomplex subunit 11.

Mol	Chain	Residues	Atoms					AltConf	Trace
			Total	C	N	O	S		
9	AK	140	1025	654	175	190	6	0	0

- Molecule 10 is a protein called NADH:ubiquinone oxidoreductase subunit B5.

Mol	Chain	Residues	Atoms					AltConf	Trace
			Total	C	N	O	S		
10	B5	139	1156	761	194	199	2	0	0

- Molecule 11 is a protein called Acyl carrier protein.

Mol	Chain	Residues	Atoms					AltConf	Trace
			Total	C	N	O	S		
11	AB	87	702	451	103	143	5	0	0

- Molecule 12 is a protein called NADH dehydrogenase [ubiquinone] 1 alpha subcomplex subunit 8.

Mol	Chain	Residues	Atoms					AltConf	Trace
			Total	C	N	O	S		
12	A8	171	1404	889	253	252	10	0	0

- Molecule 13 is a protein called NADH:ubiquinone oxidoreductase subunit B10.

Mol	Chain	Residues	Atoms					AltConf	Trace
			Total	C	N	O	S		
13	BJ	171	1441	905	266	262	8	0	0

- Molecule 14 is a protein called NADH dehydrogenase [ubiquinone] 1 alpha subcomplex subunit 10, mitochondrial.

Mol	Chain	Residues	Atoms					AltConf	Trace
			Total	C	N	O	S		
14	AJ	319	2583	1653	430	490	10	0	0

- Molecule 15 is a protein called NADH:ubiquinone oxidoreductase subunit S5.

Mol	Chain	Residues	Atoms					AltConf	Trace
			Total	C	N	O	S		
15	S5	99	822	520	154	142	6	0	0

- Molecule 16 is a protein called NADH:ubiquinone oxidoreductase subunit A3.

Mol	Chain	Residues	Atoms					AltConf	Trace
			Total	C	N	O	S		
16	A3	74	582	379	96	105	2	0	0

- Molecule 17 is a protein called NADH:ubiquinone oxidoreductase subunit B3.

Mol	Chain	Residues	Atoms					AltConf	Trace
			Total	C	N	O	S		
17	B3	73	578	378	100	98	2	0	0

- Molecule 18 is a protein called NADH dehydrogenase [ubiquinone] 1 subunit C2.

Mol	Chain	Residues	Atoms					AltConf	Trace
			Total	C	N	O	S		
18	C2	119	997	647	174	172	4	0	0

- Molecule 19 is a protein called NADH:ubiquinone oxidoreductase subunit B4.

Mol	Chain	Residues	Atoms					AltConf	Trace
			Total	C	N	O	S		
19	B4	128	1059	675	189	194	1	0	0

- Molecule 20 is a protein called NADH dehydrogenase [ubiquinone] 1 alpha subcomplex subunit 13.

Mol	Chain	Residues	Atoms					AltConf	Trace
			Total	C	N	O	S		
20	AM	114	945	607	162	168	8	0	0

- Molecule 21 is a protein called NADH dehydrogenase [ubiquinone] 1 beta subcomplex subunit 6.

Mol	Chain	Residues	Atoms					AltConf	Trace
			Total	C	N	O	S		
21	B6	95	804	530	135	138	1	0	0

- Molecule 22 is a protein called NADH:ubiquinone oxidoreductase subunit B7.

Mol	Chain	Residues	Atoms					AltConf	Trace
			Total	C	N	O	S		
22	B7	119	1026	641	196	181	8	0	0

- Molecule 23 is a protein called NADH:ubiquinone oxidoreductase subunit B9.

Mol	Chain	Residues	Atoms					AltConf	Trace
			Total	C	N	O	S		
23	B9	176	1515	970	278	261	6	0	0

- Molecule 24 is a protein called NADH:ubiquinone oxidoreductase subunit B2.

Mol	Chain	Residues	Atoms					AltConf	Trace
			Total	C	N	O	S		
24	B2	65	563	372	93	97	1	0	0

- Molecule 25 is a protein called NADH dehydrogenase [ubiquinone] 1 beta subcomplex subunit 8, mitochondrial.

Mol	Chain	Residues	Atoms					AltConf	Trace
			Total	C	N	O	S		
25	B8	157	1324	855	217	243	9	0	0

- Molecule 26 is a protein called NADH dehydrogenase [ubiquinone] 1 beta subcomplex subunit 11, mitochondrial.

Mol	Chain	Residues	Atoms					AltConf	Trace
			Total	C	N	O	S		
26	BK	102	853	547	141	161	4	0	0

- Molecule 27 is a protein called NADH dehydrogenase [ubiquinone] 1 subunit C1, mitochondrial.

Mol	Chain	Residues	Atoms				AltConf	Trace
			Total	C	N	O		
27	C1	46	391	258	67	66	0	0

- Molecule 28 is a protein called NADH dehydrogenase [ubiquinone] 1 beta subcomplex subunit 1.

Mol	Chain	Residues	Atoms				AltConf	Trace
			Total	C	N	O		
28	B1	52	449	296	79	74	0	0

There are 3 discrepancies between the modelled and reference sequences:

Chain	Residue	Modelled	Actual	Comment	Reference
B1	16	VAL	GLY	conflict	UNP W5QG39
B1	35	ALA	THR	conflict	UNP W5QG39
B1	38	ARG	TRP	conflict	UNP W5QG39

- Molecule 29 is a protein called NADH dehydrogenase [ubiquinone] 1 alpha subcomplex subunit 1.

Mol	Chain	Residues	Atoms					AltConf	Trace
			Total	C	N	O	S		
29	A1	70	577	369	106	97	5	0	0

- Molecule 30 is 1,2-DIACYL-SN-GLYCERO-3-PHOSPHOETHANOLAMINE (three-letter code: 3PE) (formula: $C_{41}H_{82}NO_8P$).

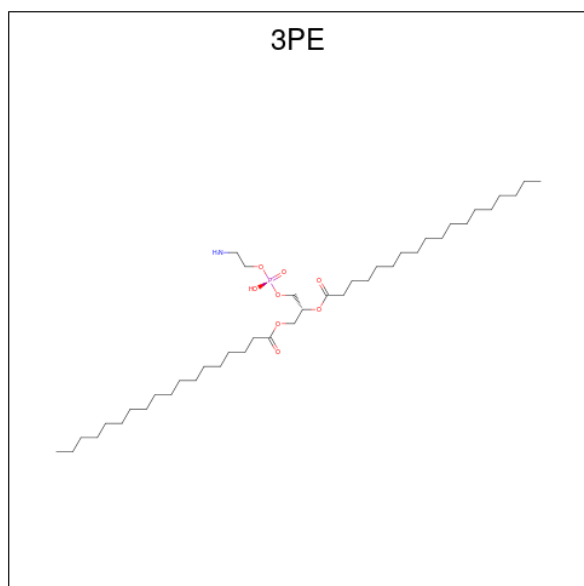

Mol	Chain	Residues	Atoms					AltConf
			Total	C	N	O	P	
30	D6	1	32	22	1	8	1	0
30	D5	1	78	58	2	16	2	0
30	D5	1	78	58	2	16	2	0
30	D4	1	25	15	1	8	1	0
30	A8	1	25	15	1	8	1	0
30	B4	1	27	18	8	1	1	0

- Molecule 31 is CARDIOLIPIN (three-letter code: CDL) (formula: $C_{81}H_{156}O_{17}P_2$).



Mol	Chain	Residues	Atoms				AltConf
			Total	C	O	P	
31	D5	1	122	84	34	4	0
31	D5	1	122	84	34	4	0
31	AK	1	64	45	17	2	0
31	B5	1	65	46	17	2	0

- Molecule 32 is 1,2-DIACYL-SN-GLYCERO-3-PHOSPHOCHOLINE (three-letter code: PC1) (formula: $C_{44}H_{88}NO_8P$).

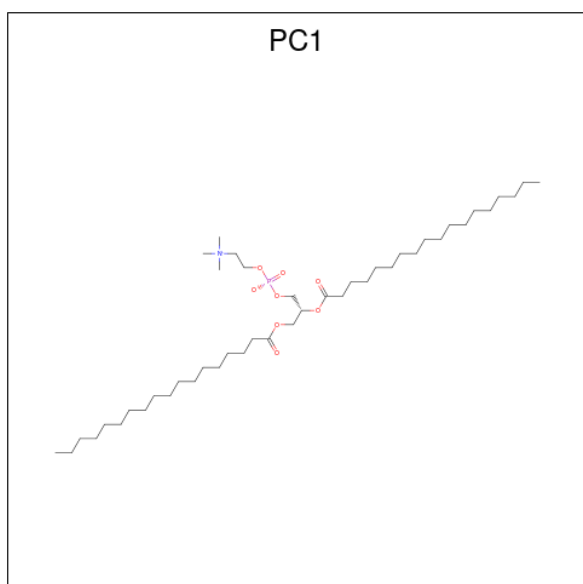

Mol	Chain	Residues	Atoms					AltConf
			Total	C	N	O	P	
32	D4	1	63	43	2	16	2	0
32	D4	1	63	43	2	16	2	0

- Molecule 33 is S-[2-({N-[(2S)-2-hydroxy-3,3-dimethyl-4-(phosphonoxy)butanoyl]-beta-alanyl}amino)ethyl] tetradecanethioate (three-letter code: ZMP) (formula: C₂₅H₄₉N₂O₈PS).

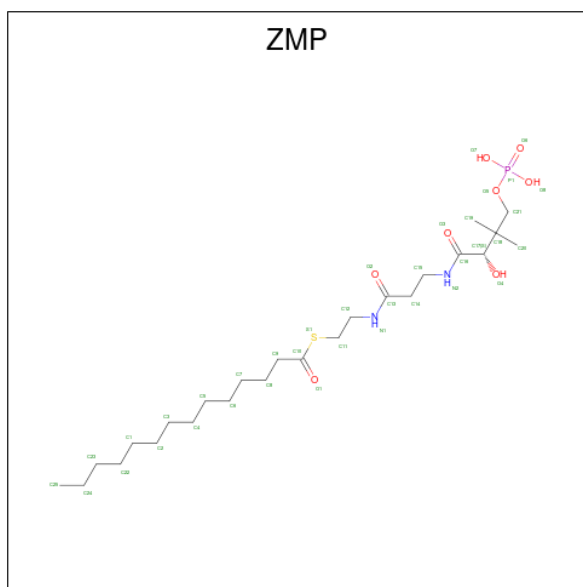

Mol	Chain	Residues	Atoms						AltConf
			Total	C	N	O	P	S	
33	AB	1	31	20	2	7	1	1	0

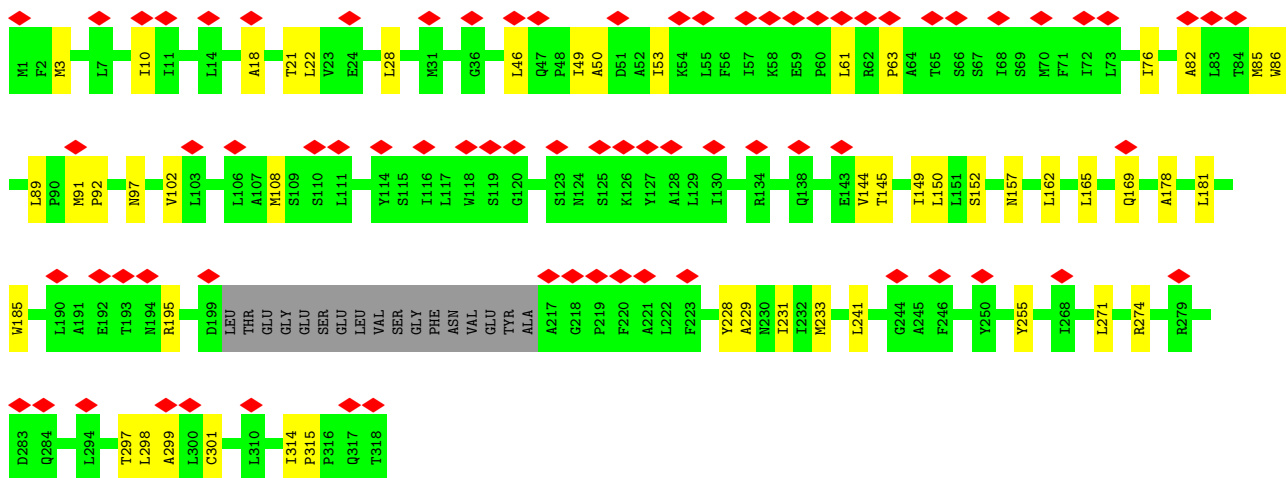

- Molecule 4: NADH-ubiquinone oxidoreductase chain 6

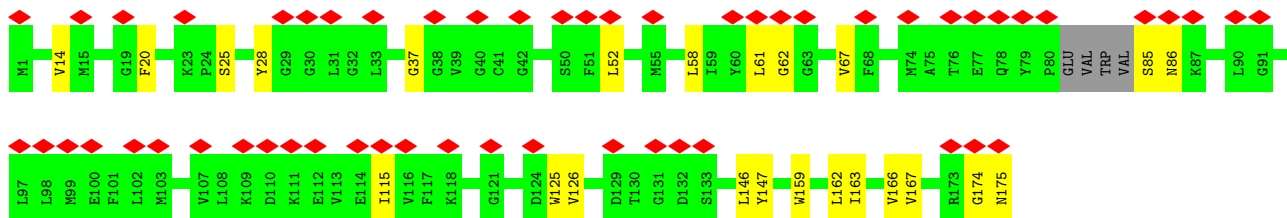
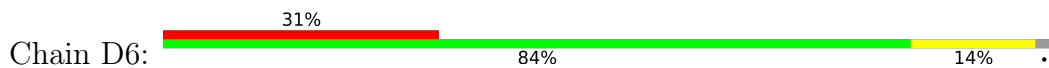

- Molecule 5: NADH-ubiquinone oxidoreductase chain 4L

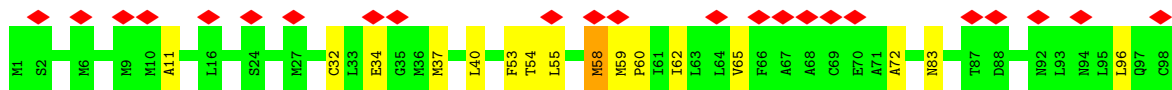
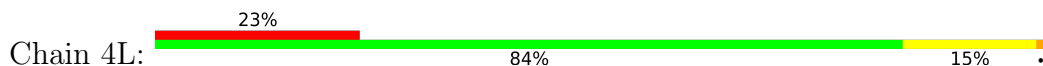

- Molecule 6: NADH-ubiquinone oxidoreductase chain 5

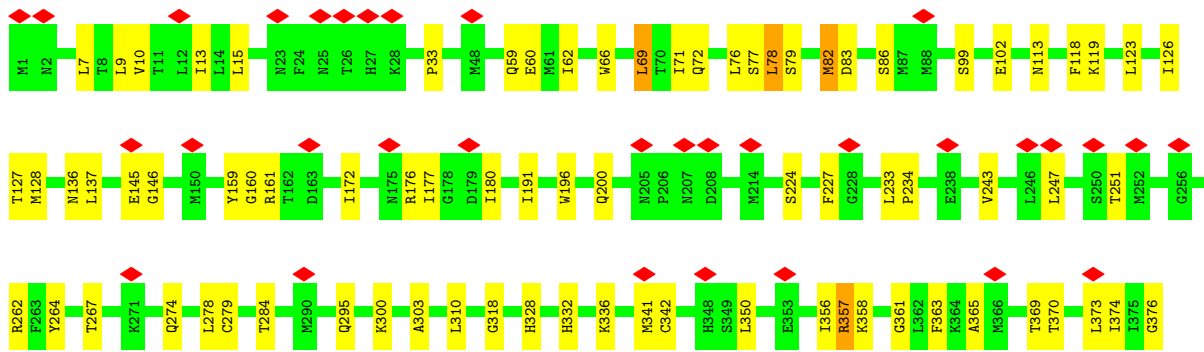
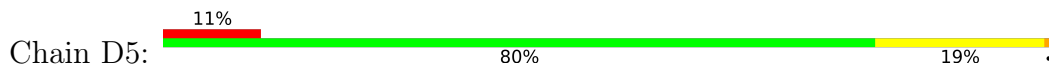

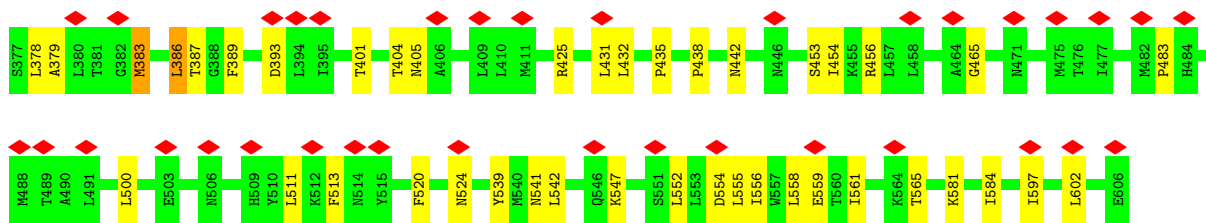

• Molecule 7: NADH-ubiquinone oxidoreductase chain 4

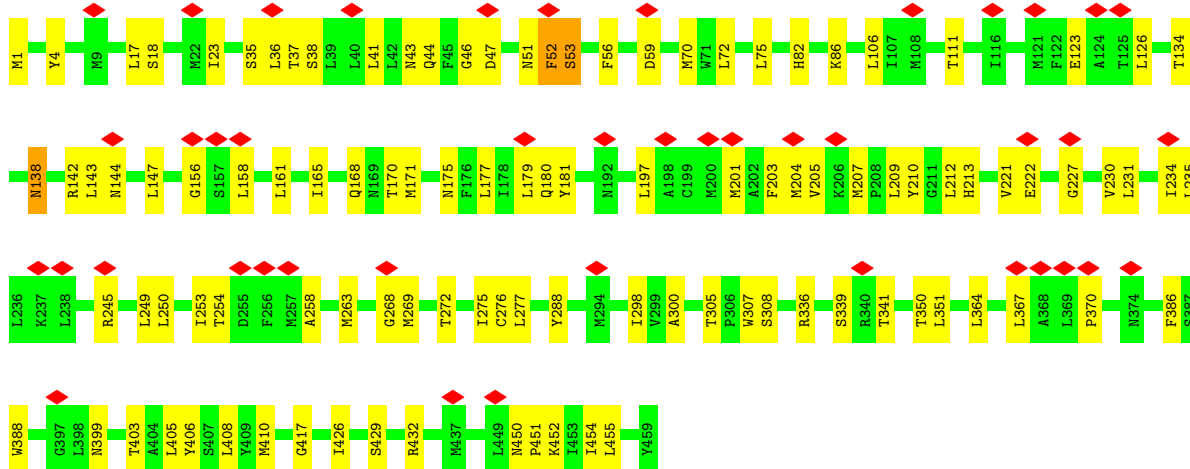
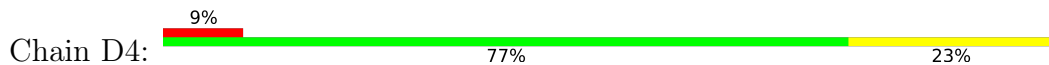

• Molecule 8: NADH-ubiquinone oxidoreductase chain 2

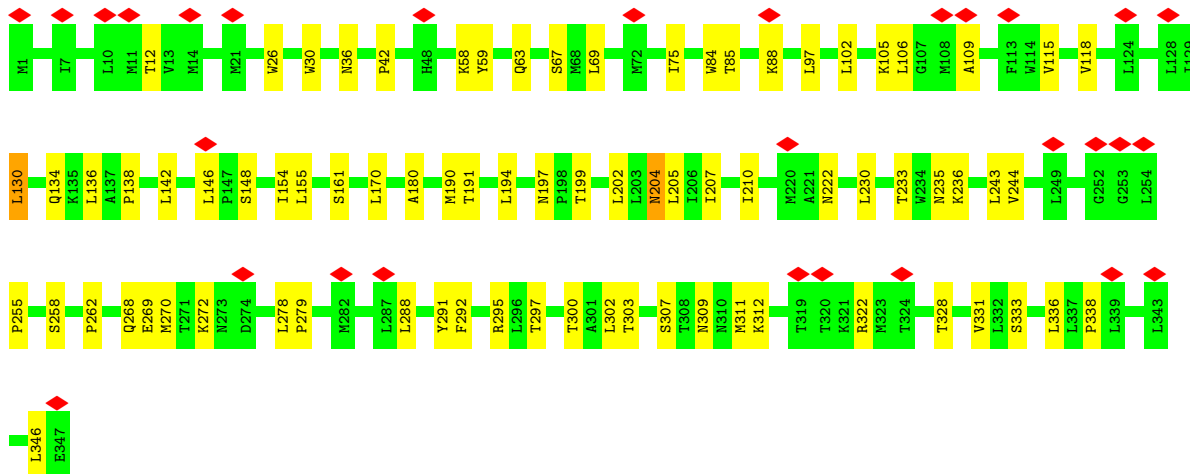
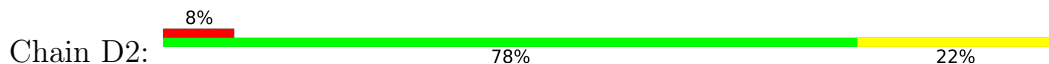

• Molecule 9: NADH dehydrogenase [ubiquinone] 1 alpha subcomplex subunit 11

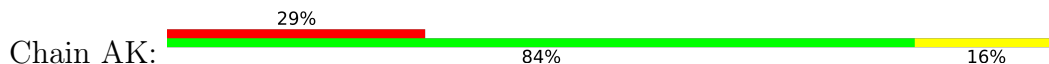

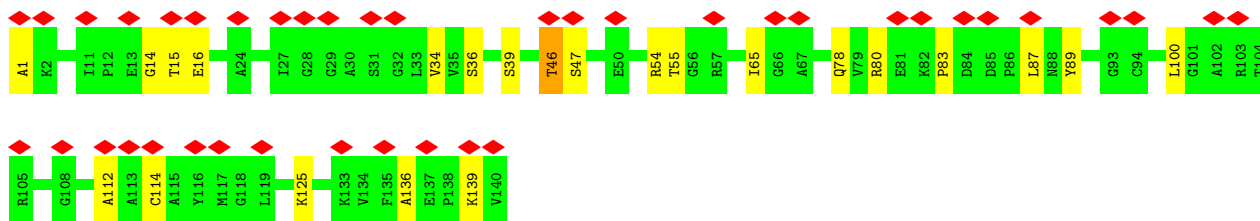

- Molecule 10: NADH:ubiquinone oxidoreductase subunit B5

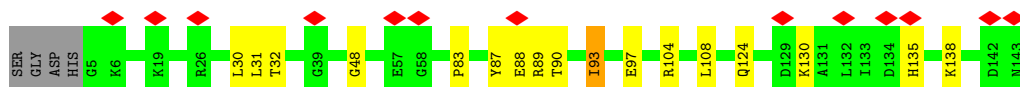
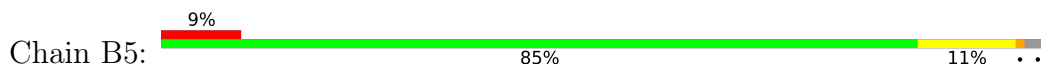

- Molecule 11: Acyl carrier protein

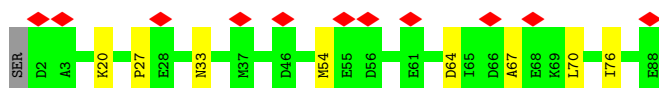
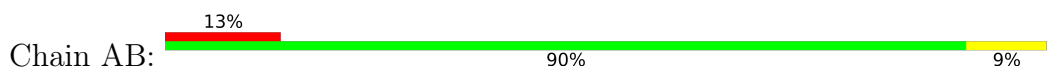

- Molecule 12: NADH dehydrogenase [ubiquinone] 1 alpha subcomplex subunit 8

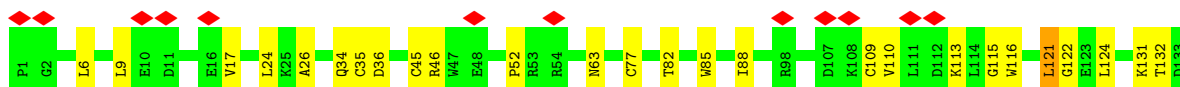
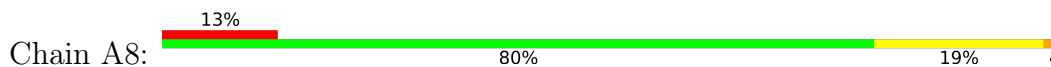

- Molecule 13: NADH:ubiquinone oxidoreductase subunit B10

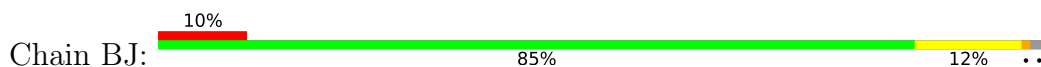

- Molecule 14: NADH dehydrogenase [ubiquinone] 1 alpha subcomplex subunit 10, mitochondrial

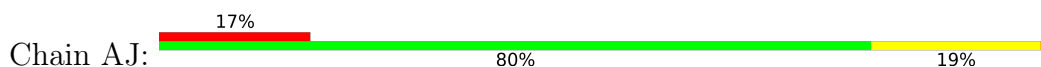

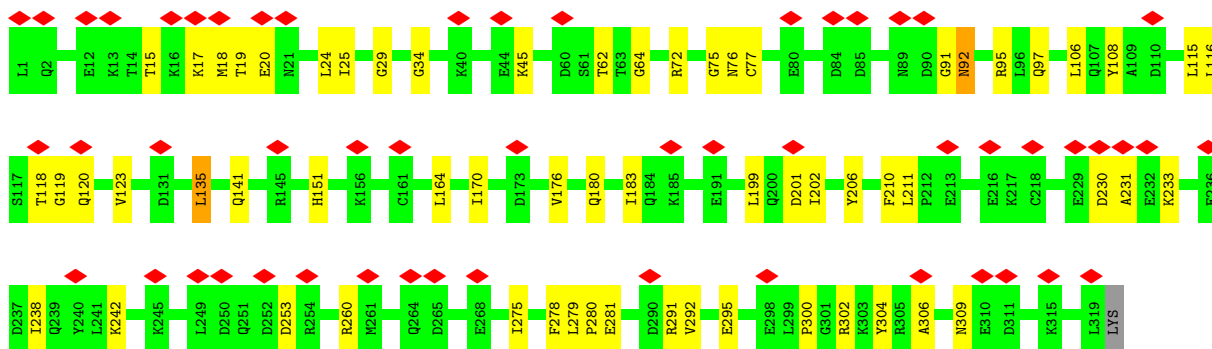

• Molecule 15: NADH:ubiquinone oxidoreductase subunit S5

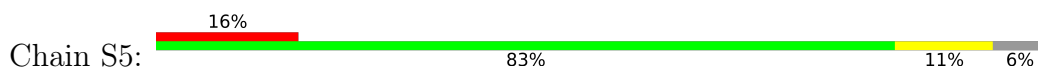

• Molecule 16: NADH:ubiquinone oxidoreductase subunit A3

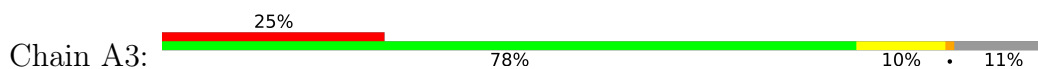

• Molecule 17: NADH:ubiquinone oxidoreductase subunit B3

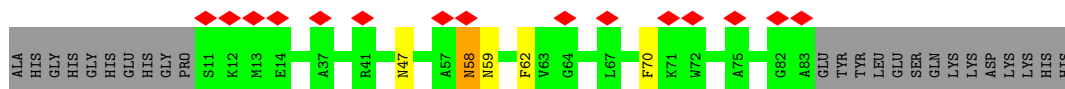

• Molecule 18: NADH dehydrogenase [ubiquinone] 1 subunit C2

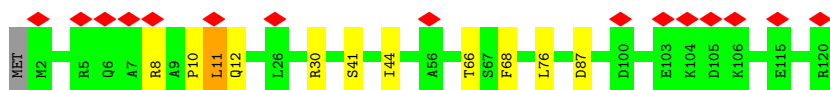

• Molecule 19: NADH:ubiquinone oxidoreductase subunit B4

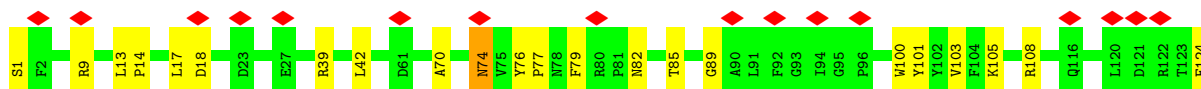
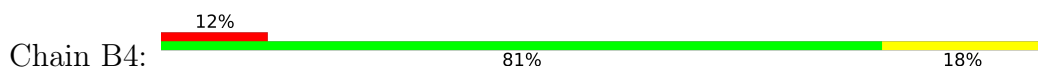

M125
I126
S127
Y128

- Molecule 20: NADH dehydrogenase [ubiquinone] 1 alpha subcomplex subunit 13

Chain AM: 

ALA A94 I95 I96 M97 K98 D99 W103 K104 M104 E107 F110 T113 V116 M119 M120 G121 E122 ASN L123 L124 G126 L126 R127 T128 S30 M34 F35 A36 G40 R54 R57 Q60 E65 A66 R67 L70 L73 D79 Q84 R85 L86 N89 E93

A94 I95 I96 M97 K98 D99 W103 K104 M104 E107 F110 T113 V116 M119 M120 G121 E122 ASN L123 L124 G126 L126 R127 T128 S30 M34 F35 A36 G40 R54 R57 Q60 E65 A66 R67 L70 L73 D79 Q84 R85 L86 N89 E93

- Molecule 21: NADH dehydrogenase [ubiquinone] 1 beta subcomplex subunit 6

Chain B6: 

S1 E7 R10 L11 L17 Q25 E26 L27 S28 P29 R30 E31 F36 ARG M120 VAL SER PRO VAL PHE TRP ASN LYS PHE LEU GLN ASP GLY ALA LEU TRP LYS ASN VAL ILE TYR THR TYR ARG HIS S67 F68 F69 A70 F71 L75 V78 I81

L85 V89 K99 R102 G106 L110 E111 T112 G113 K120 E122 P123 D124 Q125 HIS HIS

- Molecule 22: NADH:ubiquinone oxidoreductase subunit B7

Chain B7: 

G1 A2 H3 L4 A5 R6 R7 Y8 L9 G10 D11 A12 E15 F16 E17 F18 L19 R20 R21 P22 D27 F30 F31 E32 R33 K34 E35 R36 E37 Q42 D47 A48 Q49 R55 R64 R67 D71 S72 R75 A78 C79 R80 H81 E82 Q83 F96 R103

L108 K112 R117 E118 A119 ASP MET ALA LYS GLY LEU PRO GLY GLU VAL ALA PRO GLU VAL ALA LEU

- Molecule 23: NADH:ubiquinone oxidoreductase subunit B9

Chain B9: 

ALA F2 L3 A6 A7 Y8 Y15 Y19 R24 E27 S28 R29 R44 F47 H50 K51 L63 A66 H72 G73 Q74 Q77 E83 T88 E91 R92 Y93 E94 E100 W101 C102 L103 D104 H107 Y117 R121 E133 R134 K137

Q138 E142 G146 G147 R157 K158 Q159 G160 D161 L162 I169 R172 P173 R174 E175 R176 F177 MET

- Molecule 24: NADH:ubiquinone oxidoreductase subunit B2

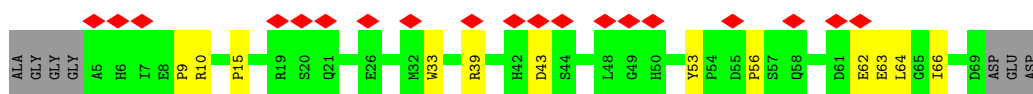
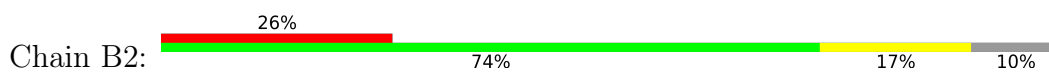

- Molecule 25: NADH dehydrogenase [ubiquinone] 1 beta subcomplex subunit 8, mitochondrial

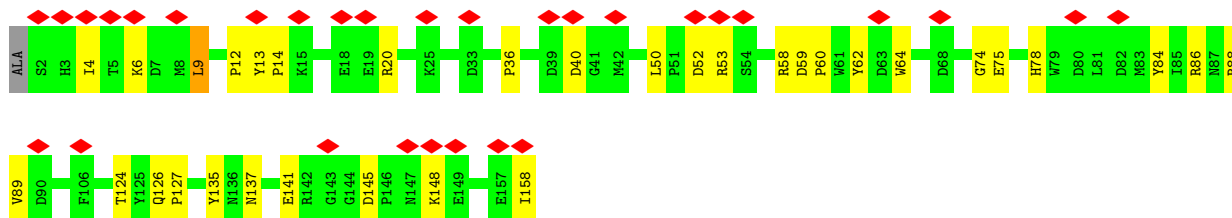
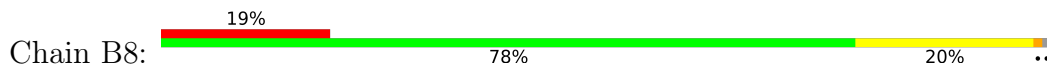

- Molecule 26: NADH dehydrogenase [ubiquinone] 1 beta subcomplex subunit 11, mitochondrial

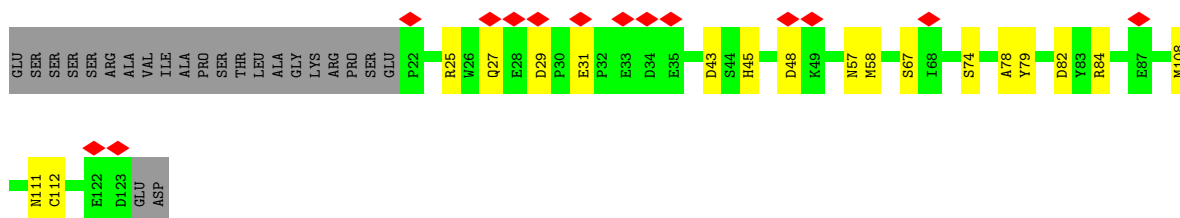

- Molecule 27: NADH dehydrogenase [ubiquinone] 1 subunit C1, mitochondrial

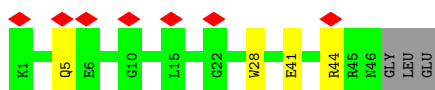
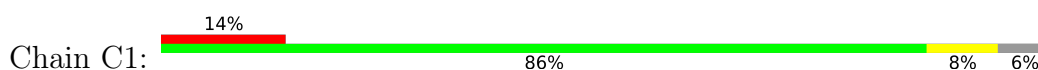

- Molecule 28: NADH dehydrogenase [ubiquinone] 1 beta subcomplex subunit 1

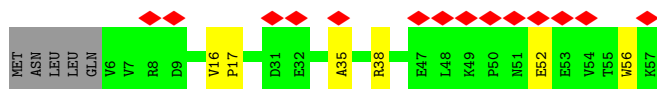
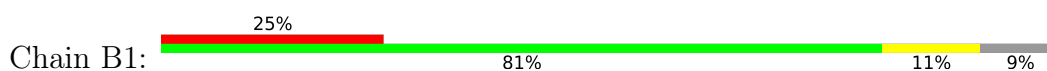

- Molecule 29: NADH dehydrogenase [ubiquinone] 1 alpha subcomplex subunit 1

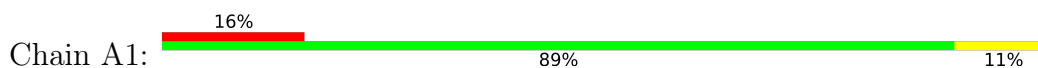



4 Experimental information

Property	Value	Source
EM reconstruction method	SINGLE PARTICLE	Depositor
Imposed symmetry	POINT, C1	Depositor
Number of particles used	174334	Depositor
Resolution determination method	FSC 0.143 CUT-OFF	Depositor
CTF correction method	PHASE FLIPPING AND AMPLITUDE CORRECTION	Depositor
Microscope	FEI TITAN KRIOS	Depositor
Voltage (kV)	300	Depositor
Electron dose ($e^-/\text{\AA}^2$)	51	Depositor
Minimum defocus (nm)	Not provided	
Maximum defocus (nm)	Not provided	
Magnification	Not provided	
Image detector	FEI FALCON II (4k x 4k)	Depositor
Maximum map value	0.584	Depositor
Minimum map value	-0.318	Depositor
Average map value	0.000	Depositor
Map value standard deviation	0.013	Depositor
Recommended contour level	0.14	Depositor
Map size (Å)	716.8, 716.8, 716.8	wwPDB
Map dimensions	512, 512, 512	wwPDB
Map angles (°)	90.0, 90.0, 90.0	wwPDB
Pixel spacing (Å)	1.4, 1.4, 1.4	Depositor

5 Model quality i

5.1 Standard geometry i

Bond lengths and bond angles in the following residue types are not validated in this section: PC1, 3PE, CDL, ZMP

The Z score for a bond length (or angle) is the number of standard deviations the observed value is removed from the expected value. A bond length (or angle) with $|Z| > 5$ is considered an outlier worth inspection. RMSZ is the root-mean-square of all Z scores of the bond lengths (or angles).

Mol	Chain	Bond lengths		Bond angles	
		RMSZ	# $ Z > 5$	RMSZ	# $ Z > 5$
1	S2	0.32	0/342	0.46	0/474
2	D3	0.31	0/747	0.66	0/1022
3	D1	0.38	0/2472	0.68	2/3380 (0.1%)
4	D6	0.36	0/1339	0.66	1/1810 (0.1%)
5	4L	0.36	0/758	0.74	1/1024 (0.1%)
6	D5	0.38	0/4933	0.72	5/6710 (0.1%)
7	D4	0.38	0/3740	0.71	4/5095 (0.1%)
8	D2	0.38	0/2788	0.67	2/3795 (0.1%)
9	AK	0.32	0/1046	0.66	0/1419
10	B5	0.35	0/1189	0.59	2/1607 (0.1%)
11	AB	0.37	0/714	0.62	0/963
12	A8	0.35	0/1441	0.65	1/1942 (0.1%)
13	BJ	0.35	0/1475	0.57	1/1989 (0.1%)
14	AJ	0.36	0/2644	0.63	4/3579 (0.1%)
15	S5	0.36	0/843	0.62	0/1128
16	A3	0.32	0/602	0.70	1/828 (0.1%)
17	B3	0.36	0/595	0.65	0/803
18	C2	0.36	0/1028	0.61	1/1388 (0.1%)
19	B4	0.35	0/1085	0.64	1/1467 (0.1%)
20	AM	0.36	0/968	0.63	1/1303 (0.1%)
21	B6	0.37	0/830	0.72	2/1130 (0.2%)
22	B7	0.36	0/1051	0.64	2/1408 (0.1%)
23	B9	0.36	0/1568	0.60	1/2123 (0.0%)
24	B2	0.34	0/590	0.61	0/810
25	B8	0.38	0/1379	0.65	1/1884 (0.1%)
26	BK	0.37	0/880	0.61	0/1196
27	C1	0.32	0/404	0.57	0/548
28	B1	0.32	0/462	0.58	0/624
29	A1	0.32	0/592	0.64	1/795 (0.1%)
All	All	0.36	0/38505	0.66	34/52244 (0.1%)

Chiral center outliers are detected by calculating the chiral volume of a chiral center and verifying if the center is modelled as a planar moiety or with the opposite hand. A planarity outlier is detected by checking planarity of atoms in a peptide group, atoms in a mainchain group or atoms of a sidechain that are expected to be planar.

Mol	Chain	#Chirality outliers	#Planarity outliers
3	D1	0	3
4	D6	0	1
6	D5	0	3
7	D4	0	3
9	AK	0	3
12	A8	0	1
13	BJ	0	2
14	AJ	0	1
15	S5	0	1
18	C2	0	2
19	B4	0	1
20	AM	0	1
21	B6	0	1
22	B7	0	1
24	B2	0	1
26	BK	0	1
28	B1	0	1
29	A1	0	1
All	All	0	28

There are no bond length outliers.

All (34) bond angle outliers are listed below:

Mol	Chain	Res	Type	Atoms	Z	Observed(°)	Ideal(°)
6	D5	69	LEU	CA-CB-CG	7.78	133.19	115.30
7	D4	36	LEU	CA-CB-CG	7.42	132.36	115.30
22	B7	27	ASP	CB-CG-OD1	7.40	124.96	118.30
22	B7	19	LEU	CA-CB-CG	6.93	131.24	115.30
3	D1	162	LEU	CA-CB-CG	6.78	130.88	115.30
20	AM	126	LEU	CA-CB-CG	6.65	130.59	115.30
6	D5	78	LEU	CA-CB-CG	6.63	130.54	115.30
4	D6	146	LEU	CA-CB-CG	6.62	130.53	115.30
19	B4	17	LEU	CA-CB-CG	6.42	130.07	115.30
29	A1	47	LEU	CA-CB-CG	5.98	129.05	115.30
21	B6	99	LYS	C-N-CA	5.85	136.32	121.70
6	D5	511	LEU	CA-CB-CG	5.84	128.73	115.30
5	4L	96	LEU	CA-CB-CG	5.78	128.59	115.30
7	D4	158	LEU	CA-CB-CG	5.72	128.46	115.30

Continued on next page...

Continued from previous page...

Mol	Chain	Res	Type	Atoms	Z	Observed(°)	Ideal(°)
14	AJ	275	ILE	C-N-CD	-5.70	108.06	120.60
8	D2	130	LEU	CA-CB-CG	5.65	128.30	115.30
13	BJ	25	LEU	C-N-CD	-5.62	108.22	120.60
6	D5	350	LEU	CA-CB-CG	5.55	128.08	115.30
14	AJ	304	TYR	CA-CB-CG	5.52	123.89	113.40
3	D1	22	LEU	CA-CB-CG	5.49	127.93	115.30
16	A3	27	LEU	CA-CB-CG	5.48	127.90	115.30
7	D4	126	LEU	CA-CB-CG	5.38	127.68	115.30
25	B8	86	ARG	C-N-CA	5.29	134.93	121.70
7	D4	230	VAL	CG1-CB-CG2	-5.28	102.45	110.90
23	B9	103	LEU	CA-CB-CG	5.28	127.44	115.30
14	AJ	230	ASP	CB-CG-OD2	5.22	123.00	118.30
18	C2	11	LEU	CA-CB-CG	5.21	127.28	115.30
12	A8	121	LEU	CA-CB-CG	5.17	127.20	115.30
10	B5	108	LEU	CA-CB-CG	5.09	127.00	115.30
10	B5	30	LEU	CA-CB-CG	5.08	126.99	115.30
21	B6	27	LEU	CA-CB-CG	5.07	126.96	115.30
14	AJ	135	LEU	CA-CB-CG	-5.07	103.65	115.30
8	D2	146	LEU	CA-CB-CG	5.01	126.83	115.30
6	D5	500	LEU	CA-CB-CG	5.00	126.81	115.30

There are no chirality outliers.

All (28) planarity outliers are listed below:

Mol	Chain	Res	Type	Group
29	A1	63	SER	Peptide
12	A8	52	PRO	Peptide
14	AJ	278	PHE	Peptide
9	AK	136	ALA	Peptide
9	AK	16	GLU	Peptide
9	AK	46	THR	Peptide
20	AM	141	TRP	Peptide
28	B1	52	GLU	Peptide
24	B2	56	PRO	Peptide
19	B4	76	TYR	Peptide
21	B6	122	PHE	Peptide
22	B7	30	PHE	Peptide
13	BJ	150	SER	Peptide
13	BJ	26	PRO	Peptide
26	BK	48	ASP	Peptide
18	C2	11	LEU	Peptide
18	C2	8	ARG	Peptide

Continued on next page...

Continued from previous page...

Mol	Chain	Res	Type	Group
3	D1	61	LEU	Peptide
3	D1	63	PRO	Peptide
3	D1	91	MET	Peptide
7	D4	17	LEU	Peptide
7	D4	52	PHE	Peptide,Mainchain
6	D5	159	TYR	Peptide
6	D5	365	ALA	Peptide
6	D5	383	MET	Peptide
4	D6	115	ILE	Peptide
15	S5	92	THR	Peptide

5.2 Too-close contacts [i](#)

In the following table, the Non-H and H(model) columns list the number of non-hydrogen atoms and hydrogen atoms in the chain respectively. The H(added) column lists the number of hydrogen atoms added and optimized by MolProbity. The Clashes column lists the number of clashes within the asymmetric unit, whereas Symm-Clashes lists symmetry-related clashes.

Mol	Chain	Non-H	H(model)	H(added)	Clashes	Symm-Clashes
1	S2	325	0	291	4	0
2	D3	728	0	773	14	0
3	D1	2400	0	2524	29	0
4	D6	1308	0	1329	17	0
5	4L	748	0	794	14	0
6	D5	4805	0	4950	82	0
7	D4	3646	0	3850	71	0
8	D2	2724	0	2930	53	0
9	AK	1025	0	1033	11	0
10	B5	1156	0	1177	14	0
11	AB	702	0	692	3	0
12	A8	1404	0	1384	25	0
13	BJ	1441	0	1417	15	0
14	AJ	2583	0	2547	37	0
15	S5	822	0	820	9	0
16	A3	582	0	583	11	0
17	B3	578	0	570	3	0
18	C2	997	0	983	8	0
19	B4	1059	0	1062	18	0
20	AM	945	0	932	19	0
21	B6	804	0	824	12	0
22	B7	1026	0	995	16	0
23	B9	1515	0	1469	29	0

Continued on next page...

Continued from previous page...

Mol	Chain	Non-H	H(model)	H(added)	Clashes	Symm-Clashes
24	B2	563	0	509	7	0
25	B8	1324	0	1219	23	0
26	BK	853	0	800	15	0
27	C1	391	0	391	4	0
28	B1	449	0	453	3	0
29	A1	577	0	570	2	0
30	A8	25	0	24	0	0
30	B4	27	0	27	0	0
30	D4	25	0	24	0	0
30	D5	78	0	104	2	0
30	D6	32	0	38	1	0
31	AK	64	0	72	0	0
31	B5	65	0	74	1	0
31	D5	122	0	132	4	0
32	D4	63	0	74	2	0
33	AB	31	0	34	9	0
All	All	38012	0	38474	448	0

The all-atom clashscore is defined as the number of clashes found per 1000 atoms (including hydrogen atoms). The all-atom clashscore for this structure is 6.

All (448) close contacts within the same asymmetric unit are listed below, sorted by their clash magnitude.

Atom-1	Atom-2	Interatomic distance (Å)	Clash overlap (Å)
33:AB:101:ZMP:O1	23:B9:50:HIS:CE1	1.98	1.16
33:AB:101:ZMP:O1	23:B9:50:HIS:HE1	1.32	1.08
7:D4:52:PHE:O	7:D4:56:PHE:HB2	1.64	0.98
33:AB:101:ZMP:C10	23:B9:50:HIS:HE1	1.87	0.87
33:AB:101:ZMP:H20	23:B9:51:LYS:HD3	1.71	0.73
6:D5:547:LYS:O	6:D5:552:LEU:HB2	1.89	0.73
18:C2:66:THR:HG1	27:C1:28:TRP:HE1	1.38	0.70
4:D6:58:LEU:O	4:D6:62:GLY:HA3	1.90	0.70
33:AB:101:ZMP:C20	23:B9:51:LYS:HD3	2.22	0.69
26:BK:74:SER:O	26:BK:78:ALA:HB2	1.92	0.69
30:D5:903:3PE:H291	8:D2:288:LEU:HD23	1.76	0.67
7:D4:46:GLY:H	26:BK:84:ARG:HA	1.59	0.67
12:A8:24:LEU:HG	20:AM:70:LEU:HD11	1.77	0.66
6:D5:541:ASN:HD22	30:D5:902:3PE:H362	1.61	0.65
9:AK:15:THR:HG21	9:AK:78:GLN:HE21	1.63	0.64
7:D4:450:ASN:HD21	7:D4:452:LYS:HE3	1.63	0.64
6:D5:597:ILE:HD11	9:AK:34:VAL:HG22	1.79	0.64

Continued on next page...

Continued from previous page...

Atom-1	Atom-2	Interatomic distance (Å)	Clash overlap (Å)
23:B9:91:GLU:HB3	23:B9:94:GLU:HB2	1.80	0.63
7:D4:221:VAL:HG23	7:D4:222:GLU:HG3	1.81	0.63
2:D3:98:LEU:HD22	3:D1:298:LEU:HD21	1.81	0.63
12:A8:77:CYS:HB2	12:A8:113:LYS:HD2	1.80	0.63
16:A3:77:LEU:HD13	16:A3:80:LEU:HD23	1.81	0.62
3:D1:102:VAL:HB	3:D1:150:LEU:HD21	1.81	0.62
6:D5:279:CYS:SG	6:D5:405:ASN:ND2	2.72	0.62
7:D4:231:LEU:O	7:D4:235:LEU:HB2	1.99	0.62
6:D5:386:LEU:HD23	6:D5:387:THR:H	1.65	0.62
6:D5:137:LEU:HB3	6:D5:196:TRP:HB2	1.81	0.62
11:AB:70:LEU:HD23	11:AB:76:ILE:HG12	1.81	0.62
1:S2:17:ALA:HB3	1:S2:28:TRP:HB3	1.81	0.62
5:4L:55:LEU:HD13	15:S5:25:PRO:HD3	1.81	0.62
7:D4:177:LEU:O	7:D4:180:GLN:C	2.38	0.61
8:D2:142:LEU:HB3	8:D2:194:LEU:HD21	1.82	0.61
13:BJ:145:LEU:HD13	13:BJ:149:TYR:HB3	1.82	0.61
6:D5:82:MET:SD	6:D5:82:MET:N	2.74	0.61
6:D5:267:THR:O	6:D5:274:GLN:NE2	2.34	0.61
12:A8:45:CYS:HA	12:A8:134:ARG:HH22	1.66	0.60
6:D5:9:LEU:HB3	21:B6:81:ILE:HD13	1.83	0.60
8:D2:88:LYS:HG3	8:D2:148:SER:HB3	1.82	0.60
6:D5:358:LYS:HE2	6:D5:438:PRO:HD3	1.84	0.60
3:D1:195:ARG:HE	3:D1:274:ARG:HD3	1.67	0.60
4:D6:167:VAL:HG22	8:D2:42:PRO:HG2	1.82	0.60
30:D6:501:3PE:N	20:AM:143:THR:OXT	2.35	0.60
3:D1:149:ILE:HG23	3:D1:181:LEU:HG	1.83	0.60
3:D1:271:LEU:HD23	3:D1:274:ARG:HH21	1.67	0.60
22:B7:6:ARG:NH1	22:B7:15:GLU:OE2	2.36	0.59
14:AJ:116:LEU:O	14:AJ:260:ARG:NH2	2.35	0.59
6:D5:123:LEU:HA	6:D5:126:ILE:HD12	1.85	0.59
6:D5:602:LEU:HD23	9:AK:1:ALA:HA	1.85	0.58
33:AB:101:ZMP:H9	23:B9:66:ALA:HB2	1.85	0.58
6:D5:442:ASN:HB3	24:B2:9:PRO:HB3	1.84	0.58
4:D6:159:TRP:HE1	8:D2:12:THR:HG22	1.68	0.58
7:D4:254:THR:O	7:D4:258:ALA:HB3	2.03	0.58
6:D5:123:LEU:HD21	31:D5:901:CDL:H731	1.86	0.58
7:D4:38:SER:OG	7:D4:70:MET:SD	2.58	0.58
22:B7:17:GLU:OE1	22:B7:20:ARG:NH2	2.37	0.58
25:B8:13:TYR:HB3	25:B8:36:PRO:HG3	1.86	0.58
23:B9:102:CYS:SG	23:B9:103:LEU:N	2.75	0.58
25:B8:145:ASP:HB3	25:B8:148:LYS:HB2	1.86	0.58

Continued on next page...

Continued from previous page...

Atom-1	Atom-2	Interatomic distance (Å)	Clash overlap (Å)
1:S2:19:MET:HG2	8:D2:295:ARG:HH12	1.66	0.57
2:D3:81:THR:H	16:A3:45:ASN:HD21	1.51	0.57
12:A8:148:GLU:OE1	15:S5:50:ARG:NH1	2.37	0.57
14:AJ:141:GLN:NE2	14:AJ:201:ASP:OD2	2.36	0.57
13:BJ:161:ARG:NH2	26:BK:111:ASN:OD1	2.38	0.57
19:B4:74:ASN:ND2	19:B4:77:PRO:O	2.38	0.57
5:4L:54:THR:HG21	15:S5:28:ILE:HD11	1.87	0.57
7:D4:177:LEU:O	7:D4:180:GLN:O	2.22	0.57
6:D5:295:GLN:H	6:D5:425:ARG:HH22	1.53	0.57
6:D5:520:PHE:O	6:D5:524:ASN:HB2	2.04	0.57
6:D5:341:MET:HE3	6:D5:454:ILE:HD13	1.86	0.57
7:D4:388:TRP:O	19:B4:108:ARG:NH2	2.38	0.57
6:D5:555:LEU:O	6:D5:559:GLU:HB2	2.05	0.57
7:D4:147:LEU:HD21	8:D2:291:TYR:HE1	1.70	0.56
2:D3:84:LEU:HD11	16:A3:45:ASN:HD22	1.69	0.56
6:D5:547:LYS:O	6:D5:552:LEU:CB	2.53	0.56
7:D4:170:THR:HG23	7:D4:171:MET:HG3	1.87	0.56
8:D2:233:THR:HA	8:D2:236:LYS:HG2	1.86	0.56
14:AJ:91:GLY:O	14:AJ:95:ARG:NH2	2.38	0.56
25:B8:13:TYR:HB2	25:B8:20:ARG:HE	1.70	0.56
25:B8:50:LEU:HB2	25:B8:78:HIS:HD2	1.71	0.56
14:AJ:17:LYS:HG2	14:AJ:118:THR:HA	1.88	0.56
6:D5:102:GLU:HG3	6:D5:456:ARG:HH12	1.71	0.56
7:D4:204:MET:HB3	7:D4:209:LEU:HD22	1.88	0.56
28:B1:35:ALA:HB1	28:B1:38:ARG:HD3	1.88	0.56
7:D4:175:ASN:ND2	10:B5:97:GLU:OE1	2.36	0.56
8:D2:170:LEU:HD22	8:D2:291:TYR:HD2	1.70	0.56
7:D4:82:HIS:HB2	7:D4:432:ARG:HH12	1.71	0.56
23:B9:24:ARG:NH1	23:B9:27:GLU:OE1	2.39	0.56
7:D4:4:TYR:HE2	7:D4:41:LEU:HD12	1.71	0.56
14:AJ:19:THR:HG23	14:AJ:20:GLU:HG3	1.88	0.56
6:D5:539:TYR:OH	19:B4:9:ARG:NH2	2.39	0.55
25:B8:52:ASP:OD1	25:B8:78:HIS:NE2	2.39	0.55
7:D4:207:MET:HG3	7:D4:298:ILE:HD11	1.88	0.55
14:AJ:77:CYS:O	14:AJ:92:ASN:ND2	2.35	0.55
9:AK:80:ARG:HH12	9:AK:87:LEU:HB3	1.70	0.55
22:B7:34:LYS:HE3	22:B7:36:ARG:HB2	1.88	0.55
8:D2:331:VAL:HG21	18:C2:41:SER:HB2	1.88	0.55
2:D3:97:LEU:HD21	4:D6:162:LEU:HB2	1.88	0.55
8:D2:69:LEU:HD11	8:D2:97:LEU:HD22	1.89	0.55
14:AJ:15:THR:OG1	14:AJ:253:ASP:OD1	2.24	0.55

Continued on next page...

Continued from previous page...

Atom-1	Atom-2	Interatomic distance (Å)	Clash overlap (Å)
3:D1:157:ASN:HD21	3:D1:165:LEU:HD13	1.70	0.55
6:D5:584:ILE:HD11	8:D2:58:LYS:HE2	1.89	0.55
6:D5:278:LEU:HB3	6:D5:318:GLY:HA3	1.89	0.55
13:BJ:98:ASP:OD2	13:BJ:141:ARG:NH2	2.39	0.55
8:D2:154:ILE:HG23	8:D2:191:THR:HG22	1.88	0.55
7:D4:134:THR:O	7:D4:142:ARG:NH1	2.40	0.55
25:B8:53:ARG:NH2	25:B8:84:TYR:OH	2.40	0.54
6:D5:60:GLU:HB2	21:B6:99:LYS:HB3	1.89	0.54
21:B6:71:PHE:O	21:B6:75:LEU:HB2	2.07	0.54
8:D2:230:LEU:HB3	8:D2:300:THR:HG22	1.88	0.54
8:D2:292:PHE:HA	8:D2:295:ARG:HG2	1.89	0.54
12:A8:17:VAL:HG21	20:AM:73:LEU:HD21	1.88	0.54
3:D1:82:ALA:HB1	3:D1:229:ALA:HB3	1.89	0.54
7:D4:53:SER:N	7:D4:56:PHE:O	2.41	0.54
8:D2:26:TRP:NE1	8:D2:85:THR:O	2.40	0.54
22:B7:36:ARG:HH22	22:B7:96:LYS:HD3	1.72	0.54
7:D4:4:TYR:HE1	7:D4:37:THR:HG22	1.72	0.54
4:D6:58:LEU:O	4:D6:62:GLY:CA	2.56	0.54
13:BJ:22:GLN:HB2	22:B7:72:SER:HB3	1.90	0.54
19:B4:42:LEU:HD13	25:B8:74:GLY:HA3	1.89	0.54
6:D5:342:CYS:SG	6:D5:369:THR:OG1	2.59	0.53
6:D5:161:ARG:NH1	23:B9:88:THR:O	2.41	0.53
8:D2:270:MET:HG2	8:D2:279:PRO:HG3	1.90	0.53
12:A8:9:LEU:HD21	20:AM:84:GLN:HG3	1.91	0.53
16:A3:48:THR:HG21	20:AM:57:ARG:HH21	1.74	0.53
18:C2:10:PRO:HG2	18:C2:12:GLN:HB2	1.88	0.53
8:D2:102:LEU:HD22	8:D2:138:PRO:HB3	1.91	0.53
8:D2:130:LEU:O	8:D2:134:GLN:HB2	2.07	0.53
16:A3:83:LEU:O	20:AM:54:ARG:NH2	2.42	0.53
6:D5:77:SER:OG	6:D5:79:SER:OG	2.26	0.53
12:A8:131:LYS:HA	16:A3:58:ASP:HB3	1.90	0.53
23:B9:29:ARG:NH2	23:B9:74:GLN:O	2.41	0.53
12:A8:46:ARG:NH1	20:AM:79:ASP:OD2	2.42	0.53
23:B9:169:ILE:O	23:B9:172:ARG:NH1	2.41	0.53
24:B2:39:ARG:NH2	24:B2:43:ASP:OD2	2.39	0.53
6:D5:357:ARG:NH2	23:B9:77:GLN:O	2.40	0.53
10:B5:104:ARG:NH2	12:A8:166:LEU:O	2.42	0.53
6:D5:341:MET:SD	6:D5:453:SER:OG	2.62	0.53
21:B6:25:GLN:NE2	23:B9:117:TYR:OH	2.40	0.53
12:A8:132:THR:OG1	16:A3:57:ARG:NH1	2.42	0.53
7:D4:168:GLN:OE1	10:B5:104:ARG:NH1	2.41	0.52

Continued on next page...

Continued from previous page...

Atom-1	Atom-2	Interatomic distance (Å)	Clash overlap (Å)
14:AJ:291:ARG:NE	26:BK:29:ASP:OD2	2.42	0.52
10:B5:83:PRO:O	10:B5:87:TYR:HB2	2.08	0.52
7:D4:450:ASN:ND2	32:D4:701:PC1:O14	2.42	0.52
12:A8:124:LEU:HB2	20:AM:65:GLU:HG2	1.92	0.52
14:AJ:306:ALA:HA	14:AJ:309:ASN:HB2	1.91	0.52
1:S2:2:ARG:O	7:D4:138:ASN:ND2	2.41	0.52
14:AJ:202:ILE:O	14:AJ:206:TYR:HB2	2.08	0.52
4:D6:25:SER:HB3	4:D6:28:TYR:HD2	1.75	0.52
7:D4:351:LEU:HD13	7:D4:426:ILE:HD11	1.90	0.52
9:AK:36:SER:HB2	9:AK:55:THR:HG22	1.92	0.52
8:D2:197:ASN:ND2	8:D2:269:GLU:OE1	2.39	0.52
5:4L:58:MET:HB3	5:4L:62:ILE:HD12	1.91	0.52
6:D5:378:LEU:HG	6:D5:383:MET:HG3	1.91	0.52
32:D4:701:PC1:H132	26:BK:79:TYR:HB3	1.92	0.52
9:AK:14:GLY:H	9:AK:83:PRO:HB3	1.75	0.52
6:D5:357:ARG:NH1	23:B9:28:SER:O	2.43	0.52
14:AJ:95:ARG:NH1	14:AJ:281:GLU:O	2.43	0.52
6:D5:233:LEU:HG	6:D5:303:ALA:HB1	1.93	0.51
6:D5:172:ILE:HG21	7:D4:408:LEU:HD23	1.91	0.51
22:B7:27:ASP:HA	22:B7:30:PHE:HB2	1.92	0.51
27:C1:41:GLU:OE2	27:C1:44:ARG:NH2	2.43	0.51
10:B5:138:LYS:HB3	15:S5:29:PRO:HD3	1.93	0.51
25:B8:4:ILE:HG22	25:B8:6:LYS:H	1.75	0.51
3:D1:165:LEU:HD21	3:D1:241:LEU:HA	1.91	0.51
6:D5:387:THR:HG23	6:D5:465:GLY:HA3	1.93	0.51
19:B4:39:ARG:NH1	25:B8:62:TYR:OH	2.44	0.51
23:B9:15:VAL:HG22	23:B9:63:LEU:HD13	1.91	0.51
6:D5:234:PRO:HB3	6:D5:300:LYS:HG2	1.93	0.51
19:B4:13:LEU:HD22	19:B4:14:PRO:HD2	1.93	0.51
5:4L:34:GLU:HA	5:4L:37:MET:HE3	1.93	0.51
14:AJ:62:THR:O	27:C1:5:GLN:NE2	2.42	0.51
6:D5:554:ASP:O	6:D5:558:LEU:HB3	2.11	0.51
7:D4:123:GLU:HB2	8:D2:255:PRO:HG2	1.93	0.51
12:A8:35:CYS:SG	12:A8:36:ASP:N	2.82	0.51
14:AJ:72:ARG:NH1	14:AJ:295:GLU:OE1	2.44	0.51
3:D1:145:THR:HG23	3:D1:297:THR:HG21	1.92	0.51
6:D5:145:GLU:HB2	7:D4:370:PRO:HG3	1.92	0.51
6:D5:86:SER:OG	6:D5:262:ARG:NH2	2.43	0.50
7:D4:165:ILE:HG21	8:D2:268:GLN:HA	1.93	0.50
8:D2:106:LEU:HD23	8:D2:138:PRO:HB2	1.93	0.50
8:D2:235:ASN:ND2	8:D2:307:SER:OG	2.43	0.50

Continued on next page...

Continued from previous page...

Atom-1	Atom-2	Interatomic distance (Å)	Clash overlap (Å)
13:BJ:158:GLN:HE22	26:BK:111:ASN:HA	1.73	0.50
23:B9:107:HIS:NE2	26:BK:43:ASP:OD1	2.38	0.50
14:AJ:25:ILE:O	14:AJ:123:VAL:HA	2.11	0.50
3:D1:169:GLN:NE2	3:D1:241:LEU:O	2.42	0.50
8:D2:109:ALA:HB2	8:D2:161:SER:HA	1.92	0.50
7:D4:300:ALA:O	7:D4:308:SER:OG	2.27	0.50
15:S5:14:ASP:O	15:S5:18:THR:OG1	2.30	0.50
6:D5:361:GLY:H	6:D5:435:PRO:HA	1.76	0.50
11:AB:64:ASP:HA	11:AB:67:ALA:HB3	1.94	0.50
13:BJ:143:HIS:NE2	19:B4:125:ASN:O	2.44	0.50
5:4L:62:ILE:HA	5:4L:65:VAL:HG12	1.94	0.49
3:D1:149:ILE:HG21	3:D1:185:TRP:HB2	1.94	0.49
6:D5:10:VAL:HG11	21:B6:78:VAL:HG22	1.93	0.49
8:D2:338:PRO:O	12:A8:169:TRP:NE1	2.45	0.49
6:D5:69:LEU:HD23	7:D4:451:PRO:HG2	1.94	0.49
6:D5:119:LYS:NZ	31:D5:901:CDL:OB7	2.45	0.49
13:BJ:69:ARG:NH1	13:BJ:90:GLN:OE1	2.45	0.49
20:AM:110:PHE:HE2	20:AM:116:VAL:HG21	1.76	0.49
13:BJ:134:VAL:HG23	26:BK:108:MET:HB3	1.94	0.49
6:D5:76:LEU:HB2	6:D5:136:ASN:HD21	1.76	0.49
10:B5:135:HIS:HB3	15:S5:37:LYS:HE3	1.94	0.49
29:A1:1:MET:HG3	29:A1:3:PHE:H	1.78	0.49
14:AJ:176:VAL:HG13	14:AJ:199:LEU:HD23	1.94	0.49
3:D1:46:LEU:HA	3:D1:49:ILE:HG22	1.96	0.48
3:D1:228:TYR:HD1	3:D1:231:ILE:HD12	1.77	0.48
8:D2:190:MET:HG2	8:D2:204:ASN:HB3	1.94	0.48
20:AM:104:LYS:N	20:AM:107:GLU:OE2	2.44	0.48
3:D1:18:ALA:O	3:D1:21:THR:OG1	2.25	0.48
18:C2:66:THR:OG1	27:C1:28:TRP:NE1	2.37	0.48
6:D5:160:GLY:H	7:D4:417:GLY:HA2	1.77	0.48
8:D2:59:TYR:HB2	8:D2:118:VAL:HG21	1.95	0.48
2:D3:69:ILE:HD11	3:D1:144:VAL:HG13	1.95	0.48
4:D6:14:VAL:HG22	5:4L:11:ALA:HB2	1.95	0.48
6:D5:243:VAL:O	6:D5:247:LEU:HB2	2.14	0.48
7:D4:179:LEU:HD21	7:D4:249:LEU:HD23	1.95	0.48
7:D4:210:TYR:O	7:D4:213:HIS:ND1	2.37	0.48
14:AJ:170:ILE:HD11	14:AJ:238:ILE:HD11	1.95	0.48
6:D5:7:LEU:HA	6:D5:10:VAL:HG22	1.95	0.48
6:D5:565:THR:HB	31:D5:904:CDL:H151	1.96	0.48
22:B7:108:LEU:O	22:B7:112:LYS:HB2	2.13	0.48
7:D4:269:MET:SD	7:D4:399:ASN:ND2	2.87	0.48

Continued on next page...

Continued from previous page...

Atom-1	Atom-2	Interatomic distance (Å)	Clash overlap (Å)
13:BJ:3:SER:OG	13:BJ:4:TRP:N	2.47	0.48
15:S5:93:PRO:HB2	15:S5:95:PRO:HD2	1.95	0.48
6:D5:33:PRO:HB3	6:D5:118:PHE:HE2	1.79	0.48
6:D5:83:ASP:H	6:D5:86:SER:HB2	1.79	0.48
6:D5:373:LEU:HD12	6:D5:431:LEU:HD21	1.96	0.48
7:D4:231:LEU:HA	7:D4:235:LEU:HD13	1.96	0.48
12:A8:141:TYR:HE2	15:S5:37:LYS:HD3	1.78	0.48
7:D4:59:ASP:OD2	7:D4:245:ARG:NH1	2.47	0.47
21:B6:85:LEU:HD23	21:B6:89:VAL:HG21	1.96	0.47
7:D4:254:THR:O	7:D4:258:ALA:CB	2.62	0.47
8:D2:115:VAL:HG12	8:D2:180:ALA:HB1	1.95	0.47
12:A8:45:CYS:SG	12:A8:134:ARG:NH1	2.86	0.47
2:D3:67:LEU:HB3	5:4L:65:VAL:HG23	1.97	0.47
5:4L:53:PHE:HE2	8:D2:84:TRP:HE1	1.60	0.47
7:D4:156:GLY:HA3	7:D4:205:VAL:HG21	1.95	0.47
7:D4:277:LEU:HD11	7:D4:405:LEU:HD22	1.95	0.47
7:D4:336:ARG:HH21	7:D4:429:SER:HA	1.79	0.47
33:AB:101:ZMP:C8	23:B9:50:HIS:CE1	2.97	0.47
12:A8:121:LEU:HA	12:A8:122:GLY:HA2	1.64	0.47
20:AM:93:GLU:HA	20:AM:96:ILE:HG22	1.96	0.47
19:B4:124:PHE:HB2	19:B4:126:ILE:HD11	1.96	0.47
7:D4:403:THR:HA	7:D4:406:TYR:CE1	2.50	0.47
8:D2:63:GLN:HE22	8:D2:105:LYS:HE2	1.79	0.47
10:B5:32:THR:OG1	26:BK:67:SER:O	2.28	0.47
20:AM:124:TYR:HB3	20:AM:132:ILE:HG22	1.96	0.47
6:D5:401:THR:HG22	25:B8:126:GLN:HE22	1.79	0.47
9:AK:39:SER:HB2	9:AK:54:ARG:HH22	1.79	0.47
12:A8:165:ARG:NH2	18:C2:87:ASP:OD1	2.41	0.47
14:AJ:24:LEU:HG	14:AJ:115:LEU:HD22	1.96	0.47
8:D2:30:TRP:NE1	8:D2:67:SER:OG	2.48	0.47
22:B7:3:HIS:CE1	25:B8:127:PRO:HD3	2.50	0.47
7:D4:44:GLN:HE22	7:D4:59:ASP:HA	1.80	0.47
14:AJ:19:THR:OG1	14:AJ:20:GLU:N	2.42	0.47
1:S2:1:ALA:N	26:BK:31:GLU:OE1	2.38	0.47
6:D5:227:PHE:H	6:D5:284:THR:HG22	1.80	0.46
19:B4:82:ASN:ND2	25:B8:40:ASP:O	2.48	0.46
14:AJ:64:GLY:HA3	14:AJ:302:ARG:HH22	1.81	0.46
6:D5:224:SER:HB2	6:D5:310:LEU:HD23	1.97	0.46
3:D1:85:MET:SD	3:D1:108:MET:HG3	2.55	0.46
31:D5:904:CDL:H142	9:AK:112:ALA:HB1	1.97	0.46
7:D4:364:LEU:HD22	7:D4:367:LEU:HD22	1.97	0.46

Continued on next page...

Continued from previous page...

Atom-1	Atom-2	Interatomic distance (Å)	Clash overlap (Å)
10:B5:88:GLU:OE1	28:B1:56:TRP:NE1	2.45	0.46
20:AM:94:ALA:HA	20:AM:103:TRP:HH2	1.80	0.46
25:B8:58:ARG:NH1	25:B8:75:GLU:OE2	2.48	0.46
6:D5:278:LEU:HD11	6:D5:405:ASN:HB2	1.98	0.46
8:D2:269:GLU:HG2	8:D2:272:LYS:HE3	1.96	0.46
9:AK:65:ILE:HD11	9:AK:100:LEU:HD23	1.97	0.46
10:B5:124:GLN:NE2	12:A8:150:ASN:OD1	2.49	0.46
14:AJ:119:GLY:HA3	14:AJ:120:GLN:HA	1.74	0.46
17:B3:70:PHE:HB3	24:B2:33:TRP:CD1	2.50	0.46
21:B6:17:LEU:HD11	23:B9:162:LEU:HD22	1.98	0.46
6:D5:71:ILE:HG13	6:D5:72:GLN:H	1.81	0.46
8:D2:312:LYS:HE3	14:AJ:292:VAL:HG11	1.97	0.46
9:AK:89:TYR:CD2	9:AK:125:LYS:HB2	2.51	0.46
8:D2:328:THR:HG23	18:C2:68:PHE:HZ	1.80	0.46
7:D4:350:THR:OG1	7:D4:351:LEU:N	2.49	0.46
8:D2:136:LEU:HA	8:D2:205:LEU:HD21	1.98	0.46
8:D2:202:LEU:HB3	8:D2:346:LEU:HD11	1.97	0.46
22:B7:4:LEU:HG	25:B8:124:THR:HG22	1.97	0.46
3:D1:92:PRO:HG3	3:D1:255:TYR:HD2	1.81	0.45
4:D6:52:LEU:HD21	5:4L:60:PRO:HB2	1.98	0.45
33:AB:101:ZMP:O4	23:B9:51:LYS:CG	2.64	0.45
23:B9:138:GLN:O	23:B9:142:GLU:HB2	2.16	0.45
5:4L:40:LEU:HD22	8:D2:75:ILE:HD12	1.97	0.45
8:D2:222:ASN:OD1	8:D2:222:ASN:N	2.46	0.45
12:A8:142:HIS:ND1	20:AM:113:THR:O	2.49	0.45
6:D5:15:LEU:HB3	6:D5:126:ILE:HG12	1.97	0.45
6:D5:332:HIS:CE1	6:D5:336:LYS:HD2	2.51	0.45
7:D4:298:ILE:HD13	7:D4:298:ILE:HA	1.70	0.45
25:B8:62:TYR:HD2	25:B8:64:TRP:HE3	1.64	0.45
2:D3:80:GLN:HA	16:A3:45:ASN:HD21	1.81	0.45
3:D1:97:ASN:HB2	20:AM:143:THR:HG23	1.97	0.45
7:D4:197:LEU:O	7:D4:201:MET:CB	2.65	0.45
8:D2:309:ASN:HD21	14:AJ:95:ARG:HG3	1.82	0.45
6:D5:10:VAL:HA	6:D5:13:ILE:HG22	1.99	0.45
2:D3:59:ALA:HB1	4:D6:67:VAL:HG22	1.99	0.45
7:D4:205:VAL:HG22	7:D4:212:LEU:HD13	1.99	0.45
14:AJ:300:PRO:O	14:AJ:309:ASN:ND2	2.47	0.45
4:D6:163:ILE:HA	4:D6:166:VAL:HG12	1.99	0.45
22:B7:30:PHE:HZ	25:B8:158:ILE:HG12	1.82	0.45
24:B2:62:GLU:H	24:B2:66:ILE:HD11	1.80	0.45
3:D1:86:TRP:HA	3:D1:89:LEU:HD12	1.99	0.45

Continued on next page...

Continued from previous page...

Atom-1	Atom-2	Interatomic distance (Å)	Clash overlap (Å)
4:D6:85:SER:OG	4:D6:86:ASN:N	2.50	0.45
12:A8:34:GLN:OE1	12:A8:116:TRP:NE1	2.49	0.45
13:BJ:141:ARG:HD2	26:BK:112:CYS:H	1.82	0.45
14:AJ:210:PHE:HD2	14:AJ:211:LEU:HD22	1.82	0.45
6:D5:200:GLN:OE1	13:BJ:106:GLN:NE2	2.42	0.45
6:D5:558:LEU:HA	6:D5:561:ILE:HG22	1.98	0.45
24:B2:63:GLU:HG2	24:B2:64:LEU:HD12	1.99	0.45
4:D6:37:GLY:HA3	4:D6:61:LEU:HD11	1.98	0.44
6:D5:376:GLY:O	6:D5:379:ALA:N	2.50	0.44
8:D2:207:ILE:HD13	8:D2:262:PRO:HD3	1.99	0.44
14:AJ:108:TYR:OH	14:AJ:164:LEU:O	2.34	0.44
15:S5:81:GLN:HA	15:S5:84:LYS:HG2	2.00	0.44
6:D5:556:ILE:HD11	19:B4:79:PHE:HB2	1.99	0.44
4:D6:125:TRP:CD1	4:D6:126:VAL:HG13	2.53	0.44
6:D5:66:TRP:HE3	6:D5:78:LEU:HD23	1.82	0.44
6:D5:513:PHE:HE1	23:B9:29:ARG:HG2	1.82	0.44
6:D5:542:LEU:HD21	7:D4:277:LEU:HD22	2.00	0.44
3:D1:50:ALA:HA	3:D1:53:ILE:HG22	2.00	0.44
7:D4:203:PHE:O	7:D4:207:MET:HG2	2.18	0.44
7:D4:410:MET:HE2	7:D4:410:MET:HB3	1.85	0.44
6:D5:432:LEU:O	17:B3:59:ASN:ND2	2.50	0.44
14:AJ:18:MET:HB3	14:AJ:19:THR:HB	1.99	0.44
2:D3:10:ASN:HD21	3:D1:10:ILE:HG21	1.83	0.44
5:4L:59:MET:HG3	8:D2:84:TRP:CZ2	2.53	0.44
21:B6:29:PRO:HB2	21:B6:31:GLU:HG3	2.00	0.44
7:D4:35:SER:OG	7:D4:70:MET:O	2.33	0.44
7:D4:72:LEU:HD12	7:D4:75:LEU:HD23	2.00	0.44
19:B4:1:SER:O	23:B9:72:HIS:ND1	2.50	0.44
25:B8:12:PRO:HG2	25:B8:14:PRO:HD2	1.99	0.44
7:D4:263:MET:HE1	19:B4:100:TRP:HB2	1.99	0.43
8:D2:199:THR:HG23	8:D2:346:LEU:HD22	2.00	0.43
23:B9:19:TYR:HB2	23:B9:47:PHE:HE2	1.83	0.43
6:D5:374:ILE:O	6:D5:378:LEU:HB2	2.19	0.43
10:B5:31:LEU:HD23	10:B5:32:THR:HG23	1.99	0.43
12:A8:82:THR:HA	12:A8:85:TRP:CD1	2.53	0.43
12:A8:110:VAL:O	12:A8:115:GLY:N	2.50	0.43
14:AJ:75:GLY:HA3	14:AJ:76:ASN:HA	1.66	0.43
19:B4:13:LEU:HD11	19:B4:18:ASP:HA	2.00	0.43
7:D4:18:SER:HB2	7:D4:23:ILE:HG22	2.00	0.43
7:D4:339:SER:OG	7:D4:341:THR:OG1	2.36	0.43
3:D1:89:LEU:HD11	3:D1:233:MET:HG3	2.01	0.43

Continued on next page...

Continued from previous page...

Atom-1	Atom-2	Interatomic distance (Å)	Clash overlap (Å)
22:B7:42:GLN:HB2	25:B8:135:TYR:HE2	1.84	0.43
2:D3:67:LEU:HD22	5:4L:65:VAL:HG23	2.00	0.43
4:D6:20:PHE:HE2	5:4L:32:CYS:HA	1.82	0.43
6:D5:127:THR:HG21	6:D5:146:GLY:HA3	2.01	0.43
6:D5:363:PHE:HA	6:D5:370:THR:HG21	2.01	0.43
9:AK:46:THR:HA	9:AK:47:SER:HA	1.68	0.43
14:AJ:151:HIS:CD2	14:AJ:279:LEU:HD11	2.53	0.43
22:B7:55:ARG:NH1	25:B8:141:GLU:OE2	2.52	0.43
23:B9:100:GLU:O	23:B9:121:ARG:NH2	2.52	0.43
26:BK:82:ASP:OD1	26:BK:82:ASP:N	2.52	0.43
8:D2:243:LEU:HD21	18:C2:44:ILE:HD11	1.99	0.43
16:A3:24:ILE:HD12	16:A3:27:LEU:HD21	2.00	0.43
6:D5:128:MET:HG3	6:D5:251:THR:HB	2.00	0.43
13:BJ:88:GLU:OE1	13:BJ:150:SER:OG	2.33	0.43
6:D5:172:ILE:O	6:D5:176:ARG:HG2	2.19	0.43
7:D4:143:LEU:HD11	8:D2:303:THR:HG21	2.01	0.43
2:D3:63:LEU:HD22	5:4L:72:ALA:HB2	2.01	0.42
6:D5:177:ILE:HA	6:D5:180:ILE:HG22	2.00	0.42
6:D5:191:ILE:HD12	7:D4:386:PHE:HD2	1.84	0.42
8:D2:258:SER:HB2	8:D2:336:LEU:H	1.84	0.42
25:B8:59:ASP:HA	25:B8:60:PRO:HD3	1.75	0.42
7:D4:250:LEU:HB3	7:D4:253:ILE:HD11	2.01	0.42
8:D2:244:VAL:HG11	8:D2:300:THR:HG21	2.01	0.42
25:B8:50:LEU:HB2	25:B8:78:HIS:CD2	2.53	0.42
10:B5:48:GLY:HA2	13:BJ:55:HIS:ND1	2.34	0.42
7:D4:210:TYR:HB2	7:D4:268:GLY:HA3	2.02	0.42
6:D5:483:PRO:HG3	24:B2:53:TYR:CZ	2.54	0.42
8:D2:210:ILE:HG22	8:D2:333:SER:HB3	1.99	0.42
2:D3:81:THR:H	16:A3:45:ASN:ND2	2.16	0.42
12:A8:150:ASN:HD22	12:A8:151:PRO:HD2	1.83	0.42
2:D3:10:ASN:ND2	3:D1:10:ILE:HG21	2.35	0.42
6:D5:99:SER:OG	6:D5:453:SER:OG	2.32	0.42
6:D5:552:LEU:HD11	19:B4:89:GLY:HA2	2.01	0.42
21:B6:106:GLY:HA3	22:B7:67:LYS:HE3	2.02	0.42
3:D1:178:ALA:HB1	3:D1:181:LEU:HB3	2.01	0.42
6:D5:356:ILE:HD13	6:D5:356:ILE:HA	1.89	0.42
7:D4:1:MET:HG2	7:D4:111:THR:HG21	2.00	0.42
7:D4:106:LEU:HD23	7:D4:106:LEU:HA	1.89	0.42
14:AJ:62:THR:HG21	14:AJ:106:LEU:HD21	2.02	0.42
21:B6:7:GLU:O	21:B6:11:LEU:HB2	2.19	0.42
12:A8:26:ALA:HB2	12:A8:88:ILE:HG21	2.00	0.42

Continued on next page...

Continued from previous page...

Atom-1	Atom-2	Interatomic distance (Å)	Clash overlap (Å)
19:B4:82:ASN:N	19:B4:85:THR:OG1	2.52	0.42
23:B9:133:GLU:O	23:B9:137:LYS:HB2	2.19	0.42
7:D4:106:LEU:HD13	7:D4:234:ILE:HG21	2.01	0.42
8:D2:297:THR:HG22	8:D2:302:LEU:HD13	2.01	0.42
14:AJ:64:GLY:HA3	14:AJ:302:ARG:NH2	2.35	0.42
20:AM:139:PHE:HB2	29:A1:45:TRP:CD1	2.55	0.42
2:D3:87:MET:HG3	4:D6:147:TYR:HB3	2.01	0.41
20:AM:119:MET:HG3	20:AM:121:GLY:H	1.85	0.41
33:AB:101:ZMP:H20A	23:B9:51:LYS:HD3	1.99	0.41
13:BJ:5:ASP:HB2	13:BJ:8:VAL:HG12	2.01	0.41
18:C2:30:ARG:HE	18:C2:76:LEU:HD11	1.84	0.41
7:D4:47:ASP:OD1	7:D4:47:ASP:N	2.53	0.41
7:D4:408:LEU:HD12	7:D4:408:LEU:HA	1.87	0.41
10:B5:87:TYR:O	10:B5:90:THR:OG1	2.35	0.41
8:D2:155:LEU:HD21	8:D2:278:LEU:HD22	2.03	0.41
20:AM:96:ILE:HG23	20:AM:97:MET:HG2	2.01	0.41
23:B9:138:GLN:O	23:B9:142:GLU:CB	2.68	0.41
24:B2:10:ARG:HD2	24:B2:15:PRO:HA	2.02	0.41
6:D5:432:LEU:HD21	17:B3:62:PHE:HA	2.03	0.41
31:B5:201:CDL:H112	31:B5:201:CDL:H551	2.01	0.41
12:A8:6:LEU:HD13	20:AM:86:LEU:HB3	2.01	0.41
4:D6:163:ILE:HG13	8:D2:12:THR:HG21	2.02	0.41
7:D4:161:LEU:O	7:D4:165:ILE:HG12	2.21	0.41
7:D4:305:THR:HG22	7:D4:307:TRP:H	1.86	0.41
3:D1:152:SER:OG	3:D1:301:CYS:SG	2.66	0.41
3:D1:314:ILE:HA	3:D1:315:PRO:HD3	1.89	0.41
8:D2:243:LEU:HD23	8:D2:243:LEU:HA	1.78	0.41
19:B4:100:TRP:HA	19:B4:103:VAL:HG22	2.01	0.41
19:B4:101:TYR:CZ	19:B4:105:LYS:HE2	2.56	0.41
25:B8:88:ARG:HG3	25:B8:89:VAL:HG23	2.03	0.41
7:D4:51:ASN:ND2	10:B5:90:THR:HG22	2.35	0.41
7:D4:272:THR:HA	7:D4:275:ILE:HG22	2.03	0.41
19:B4:70:ALA:HB2	25:B8:9:LEU:HD21	2.03	0.41
3:D1:28:LEU:HG	3:D1:271:LEU:HD21	2.03	0.41
6:D5:264:TYR:HA	6:D5:267:THR:HG22	2.03	0.41
14:AJ:97:GLN:HG2	14:AJ:135:LEU:HD13	2.02	0.41
14:AJ:280:PRO:HB3	26:BK:25:ARG:HG2	2.02	0.41
21:B6:102:ARG:HG2	22:B7:49:GLN:HB2	2.02	0.41
3:D1:299:ALA:HB1	16:A3:24:ILE:HG23	2.03	0.41
6:D5:389:PHE:O	6:D5:393:ASP:HB2	2.21	0.41
10:B5:89:ARG:O	10:B5:93:ILE:HB	2.20	0.41

Continued on next page...

Continued from previous page...

Atom-1	Atom-2	Interatomic distance (Å)	Clash overlap (Å)
22:B7:64:ARG:NH2	22:B7:82:GLU:OE2	2.54	0.41
26:BK:74:SER:O	26:BK:78:ALA:CB	2.65	0.41
4:D6:174:GLY:HA2	4:D6:175:ASN:HA	1.78	0.40
6:D5:404:THR:HG22	6:D5:405:ASN:H	1.86	0.40
14:AJ:29:GLY:HA3	14:AJ:34:GLY:HA3	2.02	0.40
14:AJ:202:ILE:O	14:AJ:206:TYR:CB	2.68	0.40
8:D2:30:TRP:HE1	8:D2:67:SER:HG	1.68	0.40
13:BJ:23:THR:OG1	22:B7:75:ASN:ND2	2.54	0.40
14:AJ:233:LYS:HD3	14:AJ:233:LYS:HA	1.92	0.40
6:D5:328:HIS:O	6:D5:332:HIS:HB3	2.21	0.40
7:D4:454:ILE:HD12	7:D4:455:LEU:HD12	2.02	0.40
11:AB:20:LYS:HG3	11:AB:27:PRO:HB3	2.03	0.40
14:AJ:45:LYS:HG3	14:AJ:231:ALA:HB1	2.04	0.40
7:D4:227:GLY:O	7:D4:231:LEU:HB2	2.21	0.40
21:B6:17:LEU:HD23	21:B6:17:LEU:HA	1.91	0.40
26:BK:45:HIS:CD2	26:BK:58:MET:HG3	2.57	0.40
3:D1:76:ILE:HD12	3:D1:76:ILE:HA	1.89	0.40
7:D4:276:CYS:HB3	7:D4:288:TYR:HB2	2.03	0.40
14:AJ:180:GLN:HA	14:AJ:183:ILE:HG22	2.04	0.40
23:B9:3:LEU:HD11	23:B9:6:ALA:HB3	2.02	0.40
28:B1:16:VAL:HG23	28:B1:17:PRO:HD3	2.04	0.40

There are no symmetry-related clashes.

5.3 Torsion angles [i](#)

5.3.1 Protein backbone [i](#)

In the following table, the Percentiles column shows the percent Ramachandran outliers of the chain as a percentile score with respect to all PDB entries followed by that with respect to all EM entries.

The Analysed column shows the number of residues for which the backbone conformation was analysed, and the total number of residues.

Mol	Chain	Analysed	Favoured	Allowed	Outliers	Percentiles	
1	S2	37/430 (9%)	32 (86%)	5 (14%)	0	100	100
2	D3	86/115 (75%)	81 (94%)	5 (6%)	0	100	100
3	D1	297/318 (93%)	270 (91%)	27 (9%)	0	100	100
4	D6	167/175 (95%)	143 (86%)	24 (14%)	0	100	100

Continued on next page...

Continued from previous page...

Mol	Chain	Analysed	Favoured	Allowed	Outliers	Percentiles	
5	4L	96/98 (98%)	90 (94%)	6 (6%)	0	100	100
6	D5	604/606 (100%)	544 (90%)	60 (10%)	0	100	100
7	D4	457/459 (100%)	418 (92%)	37 (8%)	2 (0%)	34	71
8	D2	345/347 (99%)	320 (93%)	25 (7%)	0	100	100
9	AK	138/140 (99%)	127 (92%)	11 (8%)	0	100	100
10	B5	137/143 (96%)	126 (92%)	11 (8%)	0	100	100
11	AB	85/88 (97%)	75 (88%)	10 (12%)	0	100	100
12	A8	169/171 (99%)	142 (84%)	27 (16%)	0	100	100
13	BJ	169/175 (97%)	158 (94%)	11 (6%)	0	100	100
14	AJ	317/320 (99%)	280 (88%)	37 (12%)	0	100	100
15	S5	97/105 (92%)	78 (80%)	19 (20%)	0	100	100
16	A3	72/83 (87%)	61 (85%)	11 (15%)	0	100	100
17	B3	71/97 (73%)	59 (83%)	11 (16%)	1 (1%)	11	46
18	C2	117/120 (98%)	104 (89%)	13 (11%)	0	100	100
19	B4	126/128 (98%)	110 (87%)	16 (13%)	0	100	100
20	AM	112/143 (78%)	104 (93%)	8 (7%)	0	100	100
21	B6	91/127 (72%)	77 (85%)	14 (15%)	0	100	100
22	B7	117/136 (86%)	99 (85%)	18 (15%)	0	100	100
23	B9	174/178 (98%)	145 (83%)	29 (17%)	0	100	100
24	B2	63/72 (88%)	52 (82%)	11 (18%)	0	100	100
25	B8	155/158 (98%)	119 (77%)	36 (23%)	0	100	100
26	BK	100/125 (80%)	81 (81%)	19 (19%)	0	100	100
27	C1	44/49 (90%)	41 (93%)	3 (7%)	0	100	100
28	B1	50/57 (88%)	42 (84%)	8 (16%)	0	100	100
29	A1	68/70 (97%)	64 (94%)	4 (6%)	0	100	100
All	All	4561/5233 (87%)	4042 (89%)	516 (11%)	3 (0%)	54	84

All (3) Ramachandran outliers are listed below:

Mol	Chain	Res	Type
7	D4	53	SER
17	B3	58	ASN
7	D4	181	TYR

5.3.2 Protein sidechains [i](#)

In the following table, the Percentiles column shows the percent sidechain outliers of the chain as a percentile score with respect to all PDB entries followed by that with respect to all EM entries.

The Analysed column shows the number of residues for which the sidechain conformation was analysed, and the total number of residues.

Mol	Chain	Analysed	Rotameric	Outliers	Percentiles	
1	S2	33/371 (9%)	32 (97%)	1 (3%)	41	64
2	D3	81/103 (79%)	80 (99%)	1 (1%)	71	83
3	D1	264/278 (95%)	263 (100%)	1 (0%)	91	94
4	D6	140/144 (97%)	140 (100%)	0	100	100
5	4L	87/87 (100%)	85 (98%)	2 (2%)	50	71
6	D5	539/539 (100%)	532 (99%)	7 (1%)	69	82
7	D4	412/412 (100%)	408 (99%)	4 (1%)	76	86
8	D2	315/315 (100%)	311 (99%)	4 (1%)	69	82
9	AK	101/101 (100%)	99 (98%)	2 (2%)	55	74
10	B5	122/125 (98%)	120 (98%)	2 (2%)	62	79
11	AB	80/81 (99%)	78 (98%)	2 (2%)	47	69
12	A8	154/154 (100%)	150 (97%)	4 (3%)	46	68
13	BJ	155/157 (99%)	153 (99%)	2 (1%)	69	82
14	AJ	283/284 (100%)	281 (99%)	2 (1%)	84	90
15	S5	88/94 (94%)	88 (100%)	0	100	100
16	A3	65/71 (92%)	65 (100%)	0	100	100
17	B3	55/75 (73%)	53 (96%)	2 (4%)	35	61
18	C2	106/107 (99%)	106 (100%)	0	100	100
19	B4	114/114 (100%)	113 (99%)	1 (1%)	78	87
20	AM	98/121 (81%)	95 (97%)	3 (3%)	40	64
21	B6	91/121 (75%)	90 (99%)	1 (1%)	73	84
22	B7	108/119 (91%)	105 (97%)	3 (3%)	43	66
23	B9	159/160 (99%)	156 (98%)	3 (2%)	57	75
24	B2	59/62 (95%)	59 (100%)	0	100	100
25	B8	142/142 (100%)	140 (99%)	2 (1%)	67	81
26	BK	93/112 (83%)	91 (98%)	2 (2%)	52	71

Continued on next page...

Continued from previous page...

Mol	Chain	Analysed	Rotameric	Outliers	Percentiles	
27	C1	42/44 (96%)	42 (100%)	0	100	100
28	B1	48/53 (91%)	48 (100%)	0	100	100
29	A1	59/59 (100%)	56 (95%)	3 (5%)	24	53
All	All	4093/4605 (89%)	4039 (99%)	54 (1%)	70	82

All (54) residues with a non-rotameric sidechain are listed below:

Mol	Chain	Res	Type
1	S2	34	ASN
2	D3	1	MET
3	D1	3	MET
5	4L	58	MET
5	4L	83	ASN
6	D5	59	GLN
6	D5	62	ILE
6	D5	82	MET
6	D5	113	ASN
6	D5	357	ARG
6	D5	386	LEU
6	D5	581	LYS
7	D4	43	ASN
7	D4	86	LYS
7	D4	138	ASN
7	D4	144	ASN
8	D2	36	ASN
8	D2	204	ASN
8	D2	311	MET
8	D2	322	ARG
9	AK	114	CYS
9	AK	139	LYS
10	B5	93	ILE
10	B5	130	LYS
11	AB	33	ASN
11	AB	54	MET
12	A8	63	ASN
12	A8	109	CYS
12	A8	134	ARG
12	A8	150	ASN
13	BJ	79	LYS
13	BJ	90	GLN
14	AJ	92	ASN

Continued on next page...

Continued from previous page...

Mol	Chain	Res	Type
14	AJ	242	LYS
17	B3	47	ASN
17	B3	58	ASN
19	B4	74	ASN
20	AM	60	GLN
20	AM	67	ARG
20	AM	89	ASN
21	B6	10	ARG
22	B7	7	ARG
22	B7	83	GLN
22	B7	103	ARG
23	B9	44	ARG
23	B9	157	ARG
23	B9	174	ARG
25	B8	9	LEU
25	B8	137	ASN
26	BK	27	GLN
26	BK	57	ASN
29	A1	50	ARG
29	A1	58	ASN
29	A1	68	ASN

Sometimes sidechains can be flipped to improve hydrogen bonding and reduce clashes. All (56) such sidechains are listed below:

Mol	Chain	Res	Type
1	S2	34	ASN
3	D1	194	ASN
5	4L	83	ASN
6	D5	113	ASN
6	D5	116	GLN
6	D5	248	HIS
6	D5	332	HIS
6	D5	405	ASN
6	D5	506	ASN
6	D5	534	HIS
6	D5	541	ASN
6	D5	580	GLN
7	D4	144	ASN
7	D4	192	ASN
7	D4	220	HIS
7	D4	293	HIS
7	D4	319	HIS

Continued on next page...

Continued from previous page...

Mol	Chain	Res	Type
7	D4	421	HIS
7	D4	450	ASN
8	D2	36	ASN
8	D2	63	GLN
8	D2	204	ASN
8	D2	235	ASN
8	D2	316	GLN
9	AK	78	GLN
10	B5	124	GLN
11	AB	33	ASN
12	A8	150	ASN
13	BJ	113	GLN
14	AJ	151	HIS
14	AJ	200	GLN
14	AJ	204	ASN
14	AJ	251	GLN
15	S5	6	GLN
16	A3	45	ASN
17	B3	47	ASN
17	B3	58	ASN
18	C2	59	HIS
20	AM	60	GLN
20	AM	75	GLN
20	AM	89	ASN
21	B6	25	GLN
22	B7	75	ASN
22	B7	83	GLN
22	B7	91	HIS
23	B9	32	HIS
23	B9	50	HIS
23	B9	168	HIS
24	B2	16	GLN
25	B8	104	HIS
25	B8	137	ASN
26	BK	27	GLN
26	BK	45	HIS
26	BK	57	ASN
29	A1	58	ASN
29	A1	68	ASN

5.3.3 RNA [i](#)

There are no RNA molecules in this entry.

5.4 Non-standard residues in protein, DNA, RNA chains [i](#)

There are no non-standard protein/DNA/RNA residues in this entry.

5.5 Carbohydrates [i](#)

There are no monosaccharides in this entry.

5.6 Ligand geometry [i](#)

13 ligands are modelled in this entry.

In the following table, the Counts columns list the number of bonds (or angles) for which Mogul statistics could be retrieved, the number of bonds (or angles) that are observed in the model and the number of bonds (or angles) that are defined in the Chemical Component Dictionary. The Link column lists molecule types, if any, to which the group is linked. The Z score for a bond length (or angle) is the number of standard deviations the observed value is removed from the expected value. A bond length (or angle) with $|Z| > 2$ is considered an outlier worth inspection. RMSZ is the root-mean-square of all Z scores of the bond lengths (or angles).

Mol	Type	Chain	Res	Link	Bond lengths			Bond angles		
					Counts	RMSZ	# Z > 2	Counts	RMSZ	# Z > 2
30	3PE	D4	702	-	24,24,50	0.42	0	27,29,55	0.42	0
33	ZMP	AB	101	11	24,30,36	0.70	0	29,37,45	1.02	2 (6%)
31	CDL	D5	904	-	61,61,99	0.38	0	67,73,111	0.49	1 (1%)
31	CDL	B5	201	-	64,64,99	0.38	0	70,76,111	0.51	1 (1%)
32	PC1	D4	701	-	34,34,53	0.35	0	40,42,61	0.38	0
30	3PE	A8	301	-	24,24,50	0.43	0	27,29,55	0.34	0
30	3PE	D5	903	-	39,39,50	0.33	0	42,44,55	0.31	0
30	3PE	B4	201	-	26,26,50	0.48	0	30,31,55	0.54	1 (3%)
32	PC1	D4	703	-	27,27,53	0.39	0	33,35,61	0.40	0
30	3PE	D6	501	-	31,31,50	0.37	0	34,36,55	0.40	0
30	3PE	D5	902	-	37,37,50	0.34	0	40,42,55	0.36	0
31	CDL	D5	901	-	59,59,99	0.38	0	65,71,111	0.53	1 (1%)
31	CDL	AK	501	-	63,63,99	0.36	0	69,75,111	0.30	0

In the following table, the Chirals column lists the number of chiral outliers, the number of chiral centers analysed, the number of these observed in the model and the number defined in the

Chemical Component Dictionary. Similar counts are reported in the Torsion and Rings columns. '-' means no outliers of that kind were identified.

Mol	Type	Chain	Res	Link	Chirals	Torsions	Rings
30	3PE	D4	702	-	-	9/28/28/54	-
33	ZMP	AB	101	11	-	11/35/37/43	-
31	CDL	D5	904	-	-	21/72/72/110	-
31	CDL	B5	201	-	-	19/75/75/110	-
32	PC1	D4	701	-	-	7/38/38/57	-
30	3PE	A8	301	-	-	4/28/28/54	-
30	3PE	D5	903	-	-	9/43/43/54	-
30	3PE	B4	201	-	-	2/27/27/54	-
32	PC1	D4	703	-	-	12/31/31/57	-
30	3PE	D6	501	-	-	8/35/35/54	-
30	3PE	D5	902	-	-	9/41/41/54	-
31	CDL	D5	901	-	-	18/70/70/110	-
31	CDL	AK	501	-	-	22/74/74/110	-

There are no bond length outliers.

All (6) bond angle outliers are listed below:

Mol	Chain	Res	Type	Atoms	Z	Observed(°)	Ideal(°)
33	AB	101	ZMP	O1-C10-C9	-2.45	121.10	123.99
33	AB	101	ZMP	C11-C12-N1	-2.35	107.48	112.42
31	D5	904	CDL	CA4-OA6-CA5	2.26	123.35	117.79
31	D5	901	CDL	CB4-OB6-CB5	2.19	123.19	117.79
31	B5	201	CDL	CB4-OB6-CB5	2.18	123.16	117.79
30	B4	201	3PE	O12-P-O14	2.13	119.03	110.68

There are no chirality outliers.

All (151) torsion outliers are listed below:

Mol	Chain	Res	Type	Atoms
30	D6	501	3PE	C1-O11-P-O12
30	D6	501	3PE	C11-O13-P-O12
30	D6	501	3PE	O13-C11-C12-N
30	D5	902	3PE	C11-O13-P-O12
30	D5	902	3PE	C11-O13-P-O14
30	D5	902	3PE	O21-C2-C3-O31
30	D5	903	3PE	O13-C11-C12-N

Continued on next page...

Continued from previous page...

Mol	Chain	Res	Type	Atoms
30	D4	702	3PE	C1-O11-P-O14
30	D4	702	3PE	C11-O13-P-O12
30	A8	301	3PE	C11-O13-P-O12
30	A8	301	3PE	C11-O13-P-O14
30	B4	201	3PE	C1-O11-P-O12
30	B4	201	3PE	C1-O11-P-O13
31	D5	901	CDL	CA2-OA2-PA1-OA4
31	D5	901	CDL	CA2-OA2-PA1-OA5
31	D5	901	CDL	CA3-OA5-PA1-OA3
31	D5	901	CDL	CB2-OB2-PB2-OB4
31	D5	901	CDL	CB3-OB5-PB2-OB4
31	D5	904	CDL	CA2-OA2-PA1-OA3
31	D5	904	CDL	CA3-OA5-PA1-OA2
31	D5	904	CDL	CA3-OA5-PA1-OA3
31	D5	904	CDL	CA3-OA5-PA1-OA4
31	D5	904	CDL	CB2-OB2-PB2-OB3
31	D5	904	CDL	CB3-OB5-PB2-OB3
31	AK	501	CDL	CA2-OA2-PA1-OA3
31	AK	501	CDL	CA2-OA2-PA1-OA4
31	AK	501	CDL	CA2-OA2-PA1-OA5
31	AK	501	CDL	CB2-OB2-PB2-OB3
31	AK	501	CDL	CB2-OB2-PB2-OB4
31	AK	501	CDL	CB3-OB5-PB2-OB2
31	AK	501	CDL	CB3-OB5-PB2-OB3
31	AK	501	CDL	CB3-OB5-PB2-OB4
31	B5	201	CDL	CB2-OB2-PB2-OB3
31	B5	201	CDL	CB2-OB2-PB2-OB4
32	D4	703	PC1	C11-O13-P-O14
33	AB	101	ZMP	C12-C11-S1-C10
33	AB	101	ZMP	O1-C10-S1-C11
33	AB	101	ZMP	C9-C10-S1-C11
33	AB	101	ZMP	C14-C13-N1-C12
33	AB	101	ZMP	O2-C13-N1-C12
31	AK	501	CDL	CB5-C51-C52-C53
30	D5	902	3PE	C11-O13-P-O11
30	D5	903	3PE	C1-O11-P-O13
30	D5	903	3PE	C11-O13-P-O11
30	D4	702	3PE	C11-O13-P-O11
30	A8	301	3PE	C11-O13-P-O11
31	D5	901	CDL	CA3-OA5-PA1-OA2
31	D5	901	CDL	CB2-OB2-PB2-OB5
31	D5	901	CDL	CB3-OB5-PB2-OB2

Continued on next page...

Continued from previous page...

Mol	Chain	Res	Type	Atoms
31	D5	904	CDL	CA2-OA2-PA1-OA5
31	D5	904	CDL	CB3-OB5-PB2-OB2
31	AK	501	CDL	CA3-OA5-PA1-OA2
31	AK	501	CDL	CB2-OB2-PB2-OB5
31	B5	201	CDL	CB2-OB2-PB2-OB5
31	B5	201	CDL	CB3-OB5-PB2-OB2
32	D4	701	PC1	C11-O13-P-O11
32	D4	703	PC1	C11-O13-P-O11
30	D6	501	3PE	C21-C22-C23-C24
30	D5	902	3PE	O13-C11-C12-N
31	B5	201	CDL	C51-C52-C53-C54
31	B5	201	CDL	C1-CB2-OB2-PB2
30	D6	501	3PE	C1-O11-P-O13
30	D6	501	3PE	C11-O13-P-O11
30	D4	702	3PE	C1-O11-P-O13
32	D4	703	PC1	C1-O11-P-O13
31	B5	201	CDL	O1-C1-CA2-OA2
30	A8	301	3PE	O13-C11-C12-N
31	D5	904	CDL	C1-CA2-OA2-PA1
31	D5	901	CDL	CA3-CA4-CA6-OA8
30	D4	702	3PE	O31-C31-C32-C33
30	D5	903	3PE	C35-C36-C37-C38
32	D4	703	PC1	O11-C1-C2-O21
30	D5	902	3PE	C34-C35-C36-C37
31	D5	901	CDL	OA6-CA4-CA6-OA8
32	D4	703	PC1	C2-C1-O11-P
30	D5	902	3PE	C1-C2-C3-O31
31	D5	904	CDL	CA3-CA4-CA6-OA8
31	AK	501	CDL	OB5-CB3-CB4-OB6
31	AK	501	CDL	C56-C57-C58-C59
30	D5	902	3PE	C23-C24-C25-C26
30	D6	501	3PE	C1-O11-P-O14
30	D6	501	3PE	C11-O13-P-O14
30	D5	903	3PE	C1-O11-P-O12
30	D5	903	3PE	C1-O11-P-O14
30	D5	903	3PE	C11-O13-P-O14
30	D4	702	3PE	C1-O11-P-O12
30	D4	702	3PE	C11-O13-P-O14
31	D5	901	CDL	CA2-OA2-PA1-OA3
31	D5	901	CDL	CA3-OA5-PA1-OA4
31	D5	904	CDL	CA2-OA2-PA1-OA4
31	AK	501	CDL	CA3-OA5-PA1-OA3

Continued on next page...

Continued from previous page...

Mol	Chain	Res	Type	Atoms
31	AK	501	CDL	CA3-OA5-PA1-OA4
31	B5	201	CDL	CB3-OB5-PB2-OB3
31	B5	201	CDL	CB3-OB5-PB2-OB4
32	D4	701	PC1	C11-O13-P-O12
32	D4	701	PC1	C11-O13-P-O14
32	D4	703	PC1	C11-O13-P-O12
32	D4	703	PC1	C1-O11-P-O12
31	AK	501	CDL	OB5-CB3-CB4-CB6
32	D4	703	PC1	O11-C1-C2-C3
30	D5	903	3PE	C34-C35-C36-C37
32	D4	701	PC1	O13-C11-C12-N
32	D4	703	PC1	O13-C11-C12-N
31	B5	201	CDL	C32-C33-C34-C35
33	AB	101	ZMP	C6-C7-C8-C9
33	AB	101	ZMP	O3-C16-C17-O4
32	D4	701	PC1	C38-C39-C3A-C3B
30	D5	902	3PE	C22-C23-C24-C25
30	D5	903	3PE	C25-C26-C27-C28
31	D5	904	CDL	CB2-OB2-PB2-OB5
31	B5	201	CDL	CA3-OA5-PA1-OA2
32	D4	701	PC1	C1-O11-P-O13
33	AB	101	ZMP	O4-C17-C18-C20
31	AK	501	CDL	C59-C60-C61-C62
32	D4	703	PC1	C31-C32-C33-C34
31	AK	501	CDL	C51-C52-C53-C54
31	D5	901	CDL	C1-CB2-OB2-PB2
31	D5	901	CDL	CB6-CB4-OB6-CB5
31	D5	901	CDL	CB5-C51-C52-C53
31	D5	904	CDL	CB7-C71-C72-C73
31	D5	901	CDL	C12-C11-CA5-OA6
30	D4	702	3PE	O32-C31-C32-C33
31	B5	201	CDL	CB2-C1-CA2-OA2
33	AB	101	ZMP	C16-C17-C18-C19
33	AB	101	ZMP	C16-C17-C18-C20
31	D5	904	CDL	C74-C75-C76-C77
31	D5	901	CDL	OA5-CA3-CA4-CA6
31	B5	201	CDL	OB5-CB3-CB4-CB6
31	D5	904	CDL	C52-C51-CB5-OB6
31	AK	501	CDL	C32-C31-CA7-OA8
32	D4	703	PC1	O31-C31-C32-C33
31	D5	904	CDL	C1-CB2-OB2-PB2
31	B5	201	CDL	C52-C51-CB5-OB6

Continued on next page...

Continued from previous page...

Mol	Chain	Res	Type	Atoms
31	AK	501	CDL	C55-C56-C57-C58
31	D5	901	CDL	C12-C11-CA5-OA7
31	D5	904	CDL	CB4-CB3-OB5-PB2
31	AK	501	CDL	C32-C31-CA7-OA9
31	D5	904	CDL	CB3-OB5-PB2-OB4
31	B5	201	CDL	CA3-OA5-PA1-OA3
32	D4	701	PC1	C1-O11-P-O14
31	D5	904	CDL	C52-C51-CB5-OB7
30	D4	702	3PE	C12-C11-O13-P
31	D5	904	CDL	CA3-CA4-OA6-CA5
31	B5	201	CDL	C52-C51-CB5-OB7
31	AK	501	CDL	C54-C55-C56-C57
33	AB	101	ZMP	C16-C17-C18-C21
31	B5	201	CDL	C32-C31-CA7-OA8
32	D4	703	PC1	O32-C31-C32-C33
31	D5	904	CDL	C32-C31-CA7-OA8
31	B5	201	CDL	C32-C31-CA7-OA9
31	B5	201	CDL	CB7-C71-C72-C73

There are no ring outliers.

8 monomers are involved in 19 short contacts:

Mol	Chain	Res	Type	Clashes	Symm-Clashes
33	AB	101	ZMP	9	0
31	D5	904	CDL	2	0
31	B5	201	CDL	1	0
32	D4	701	PC1	2	0
30	D5	903	3PE	1	0
30	D6	501	3PE	1	0
30	D5	902	3PE	1	0
31	D5	901	CDL	2	0

The following is a two-dimensional graphical depiction of Mogul quality analysis of bond lengths, bond angles, torsion angles, and ring geometry for all instances of the Ligand of Interest. In addition, ligands with molecular weight > 250 and outliers as shown on the validation Tables will also be included. For torsion angles, if less than 5% of the Mogul distribution of torsion angles is within 10 degrees of the torsion angle in question, then that torsion angle is considered an outlier. Any bond that is central to one or more torsion angles identified as an outlier by Mogul will be highlighted in the graph. For rings, the root-mean-square deviation (RMSD) between the ring in question and similar rings identified by Mogul is calculated over all ring torsion angles. If the average RMSD is greater than 60 degrees and the minimal RMSD between the ring in question and any Mogul-identified rings is also greater than 60 degrees, then that ring is considered an outlier.

The outliers are highlighted in purple. The color gray indicates Mogul did not find sufficient equivalents in the CSD to analyse the geometry.

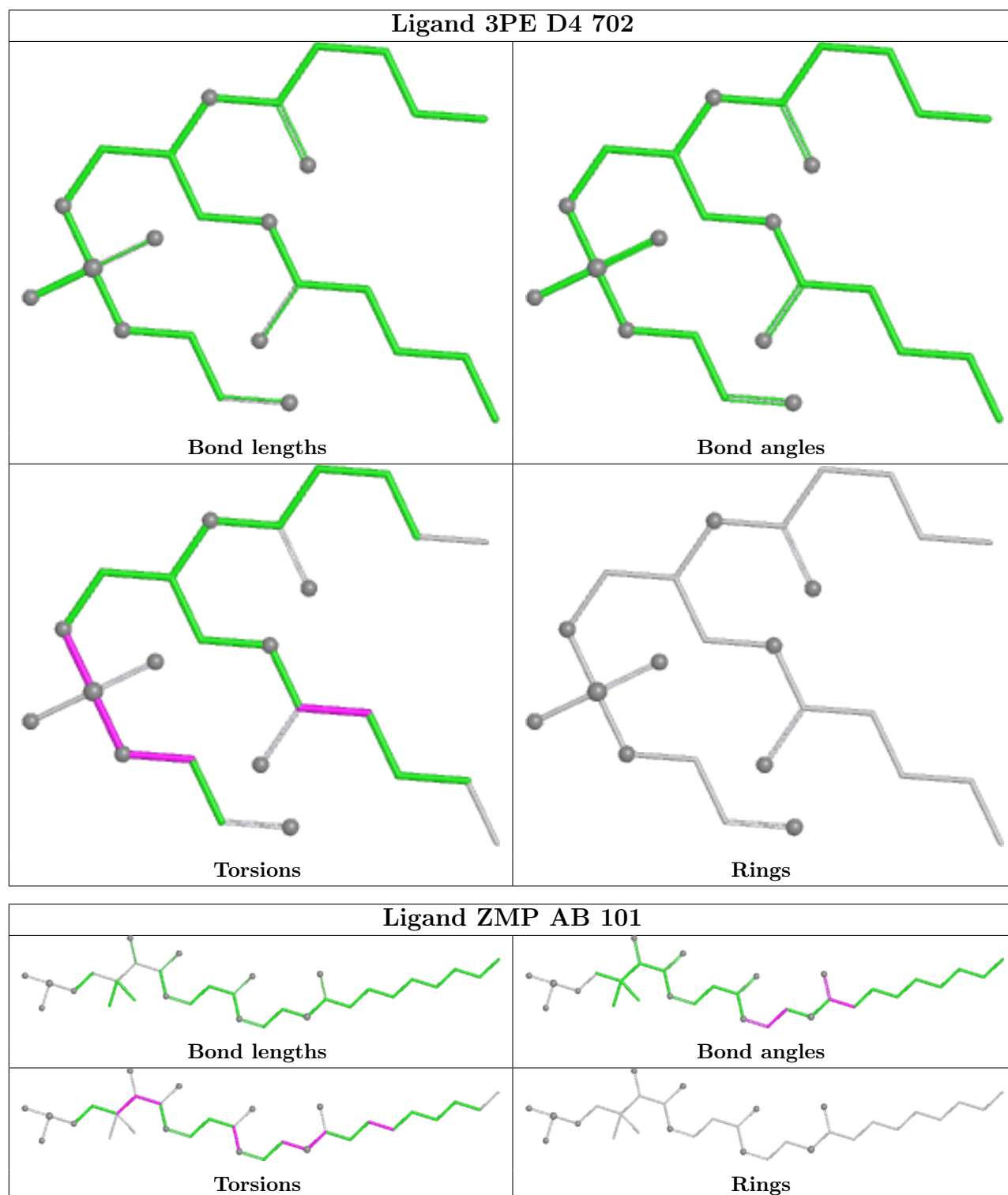

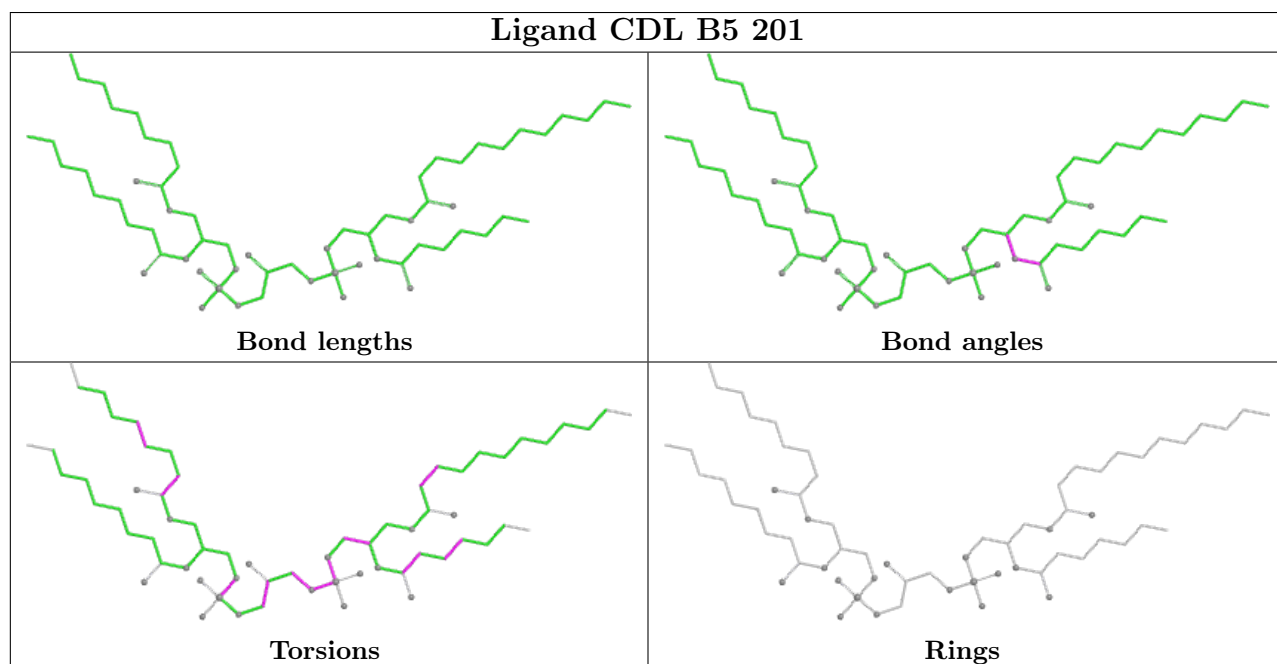
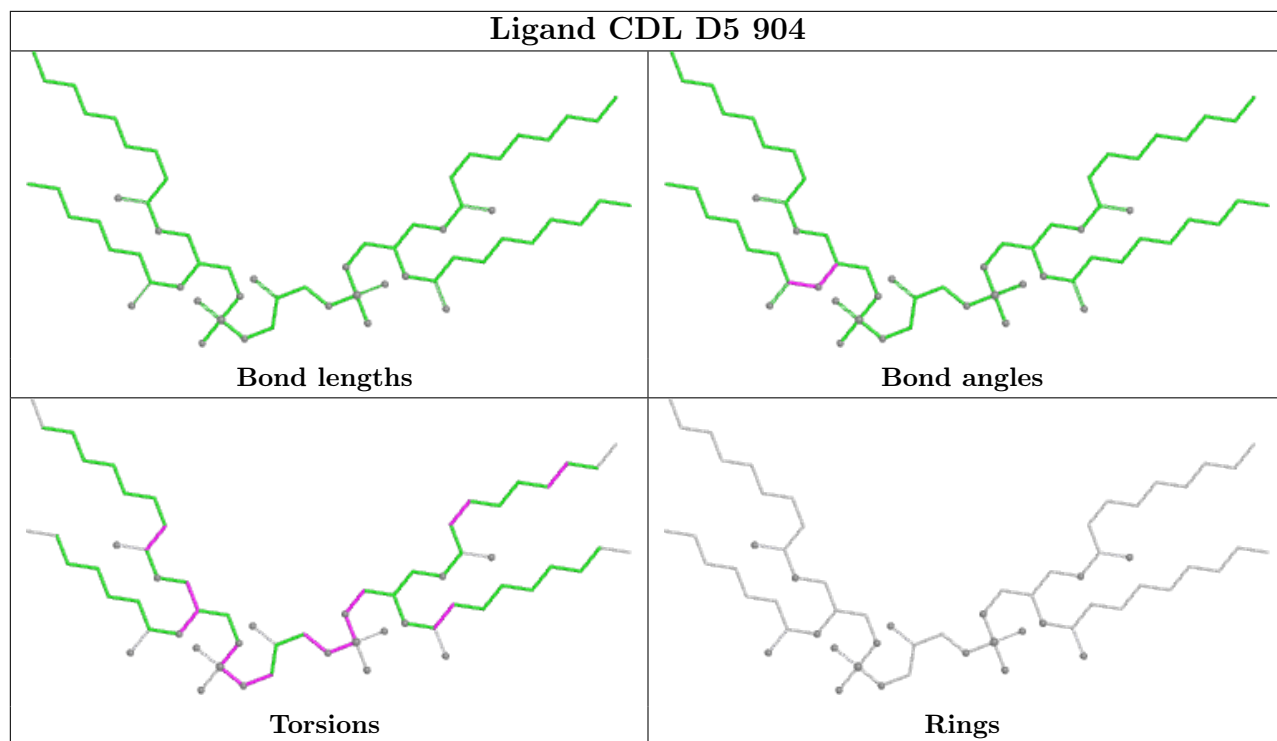

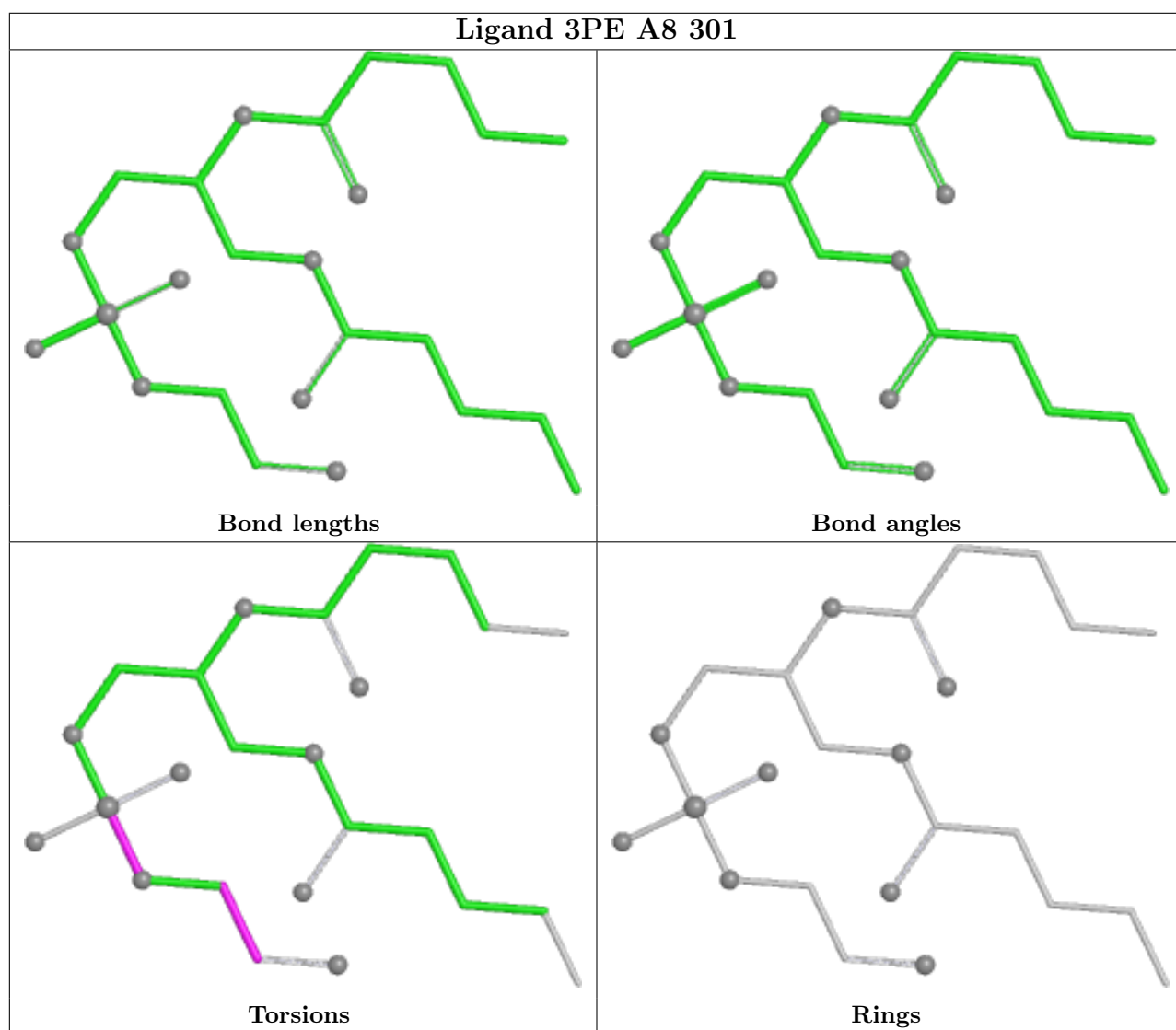
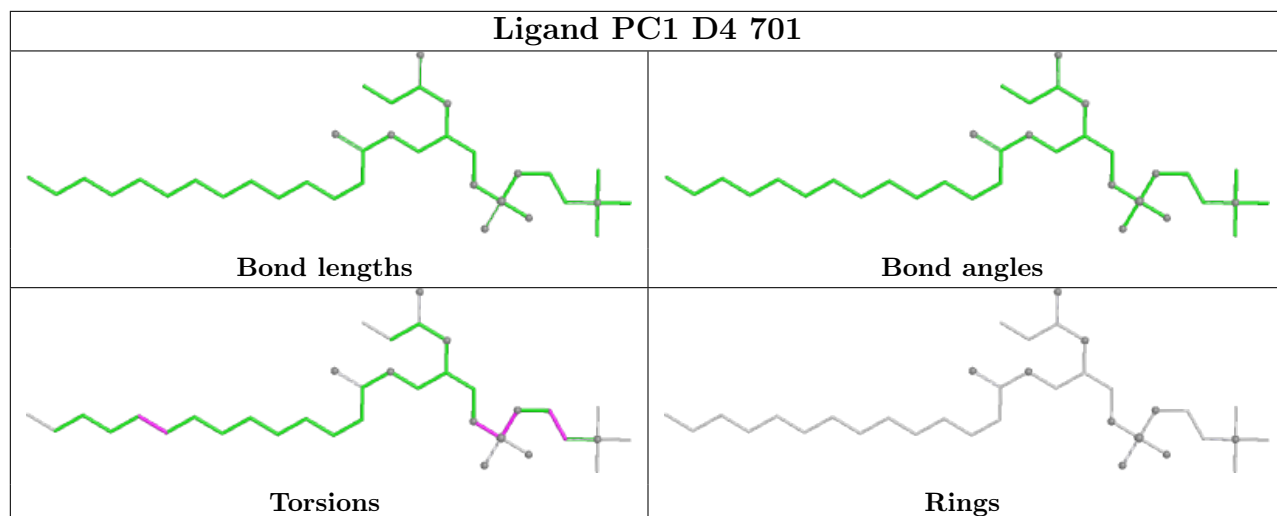

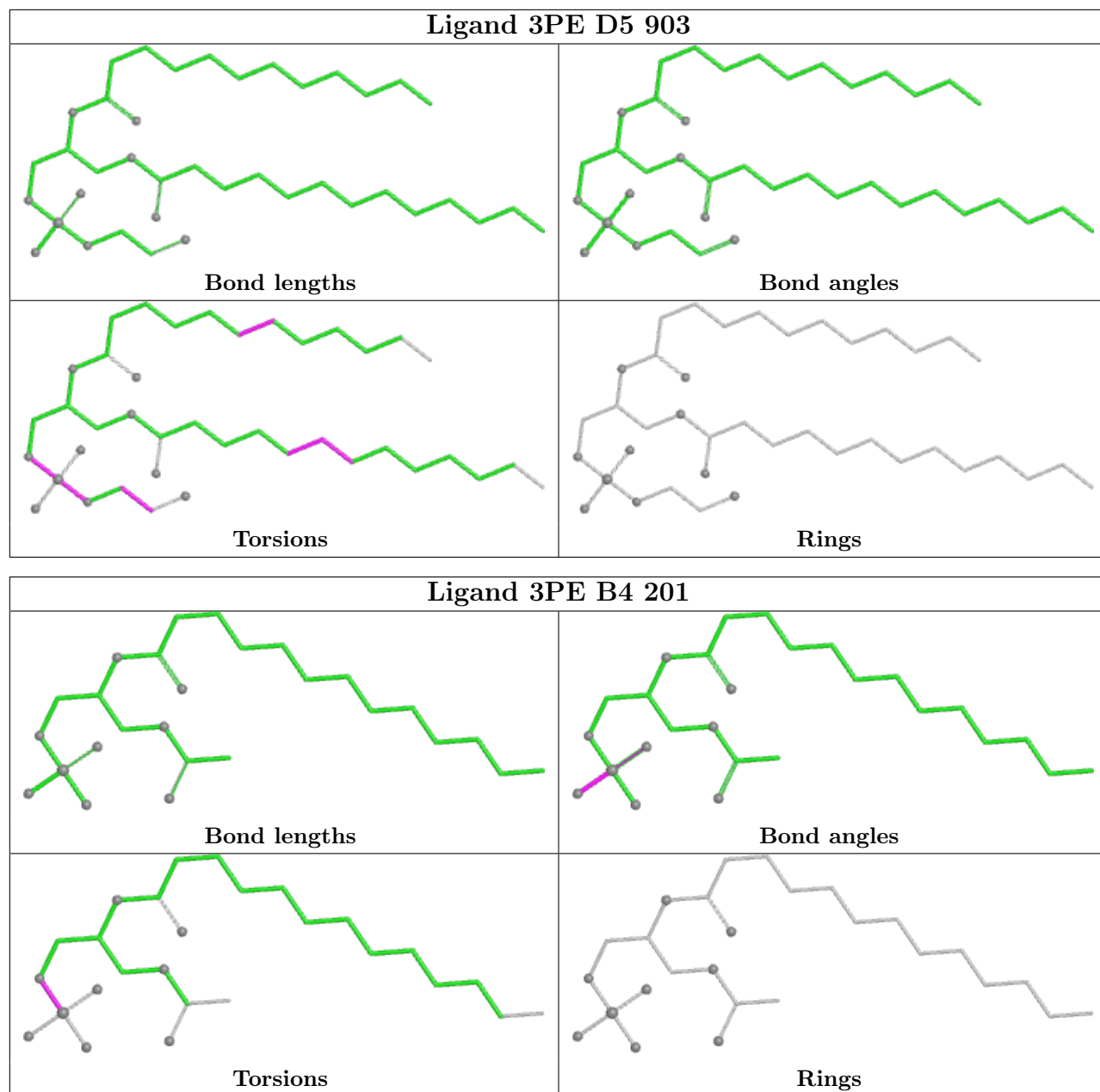

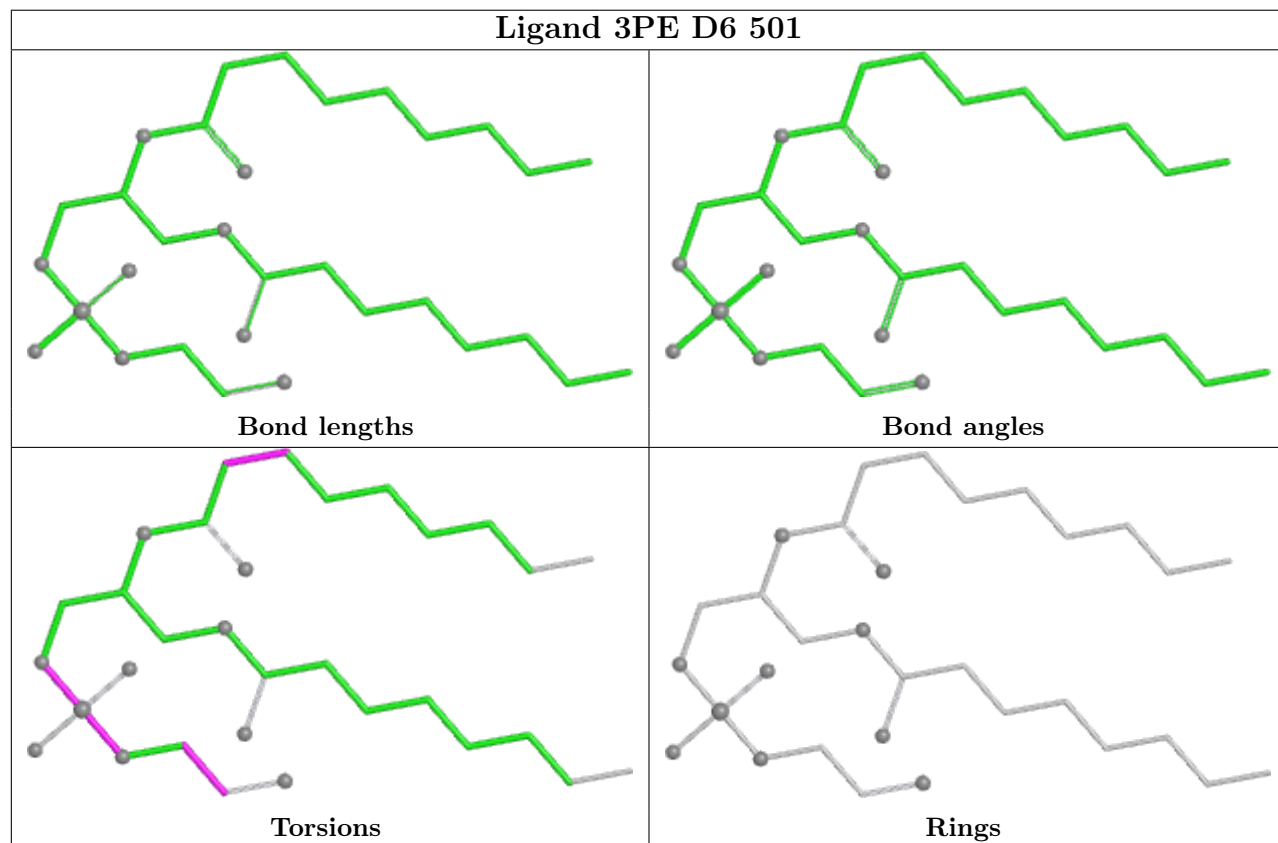
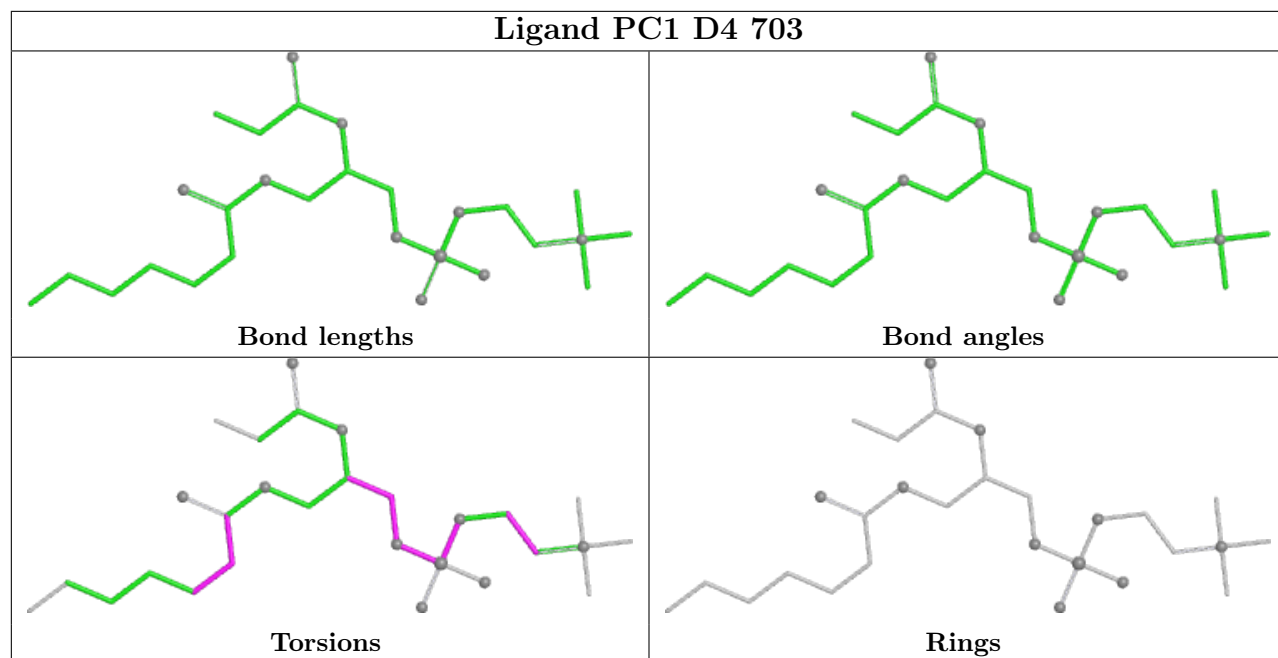

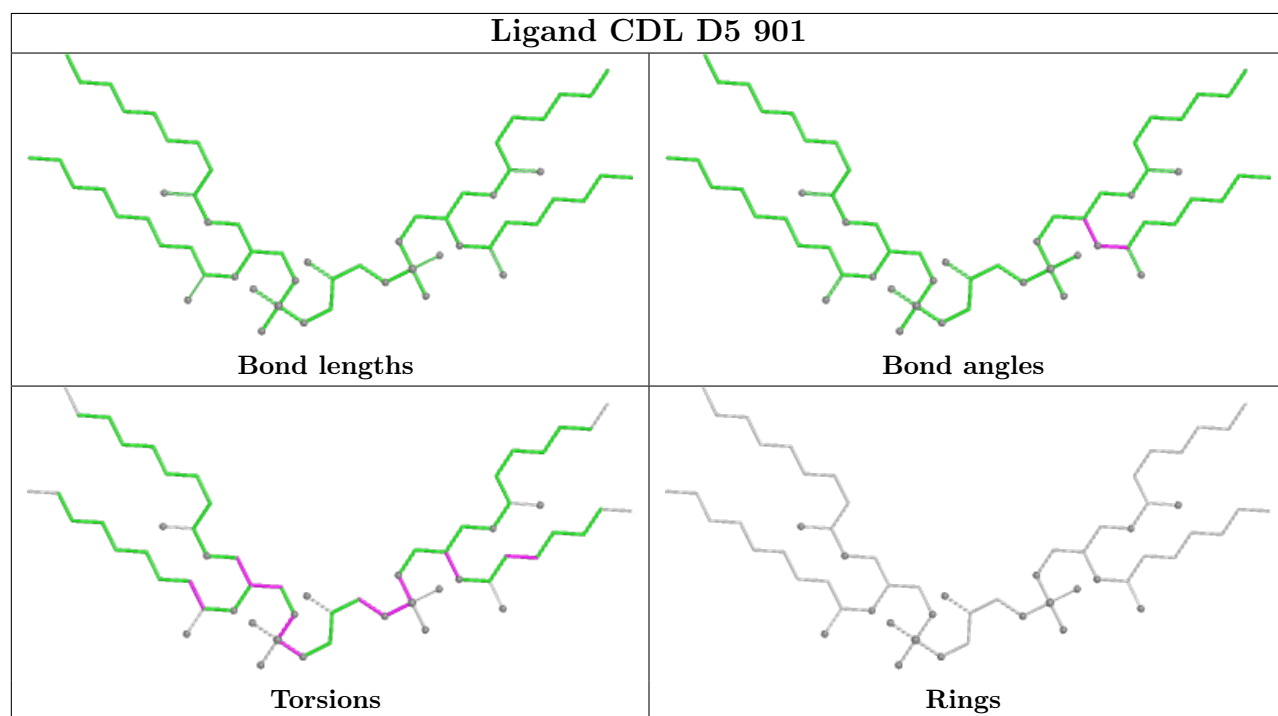
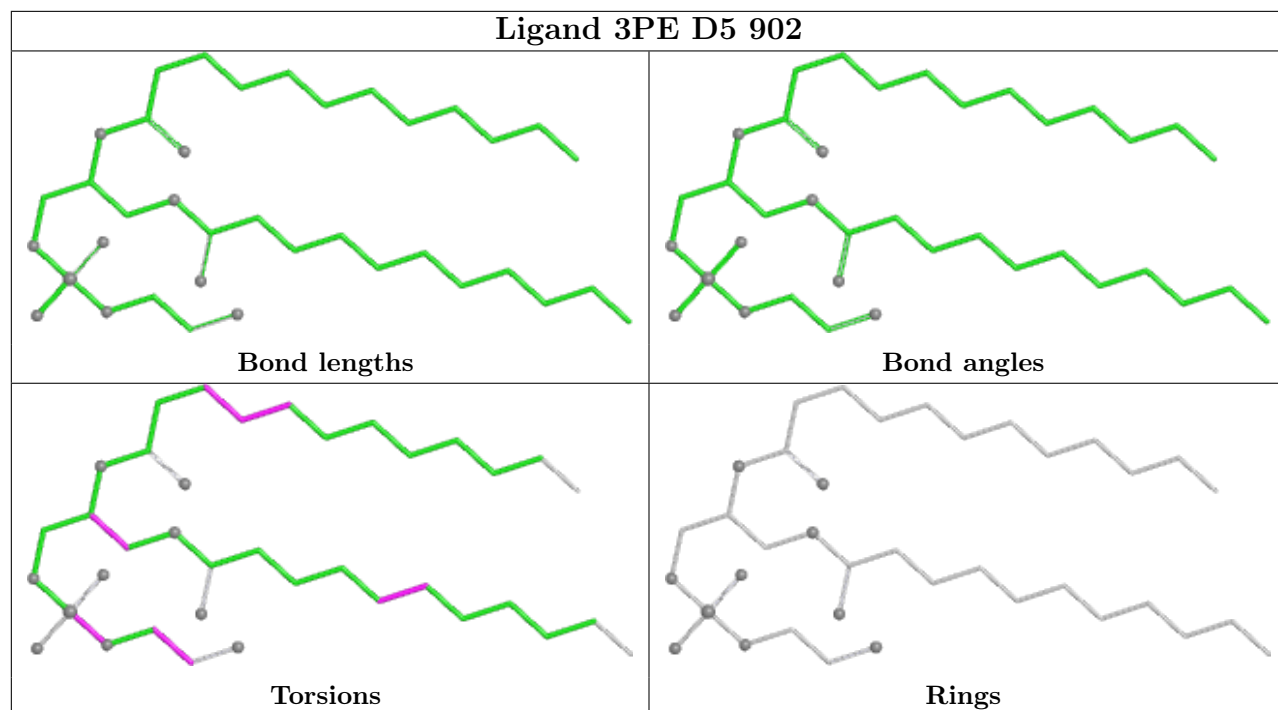

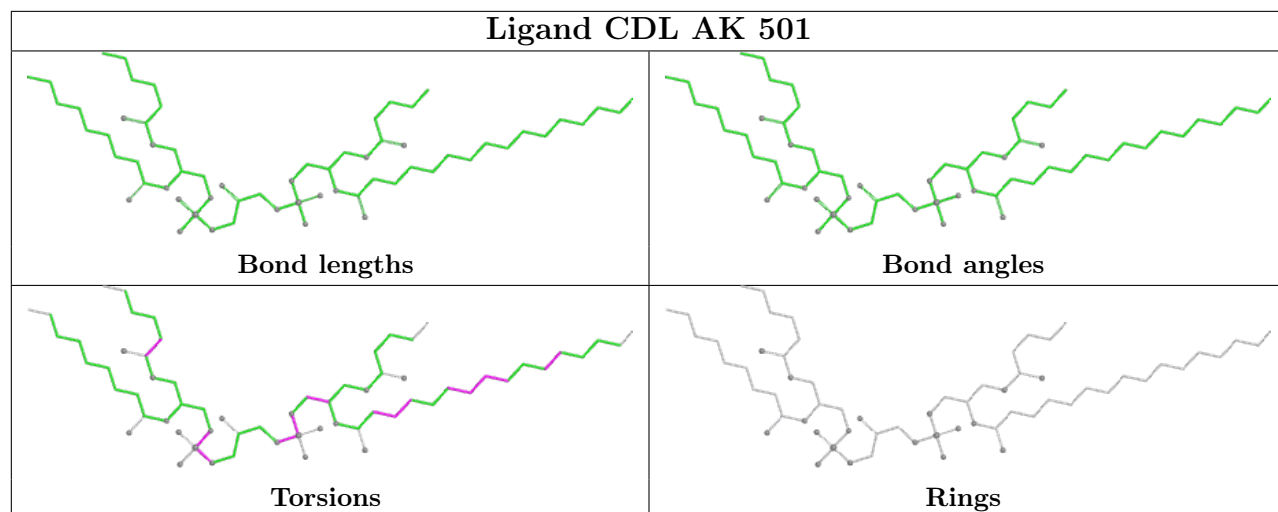

5.7 Other polymers [i](#)

There are no such residues in this entry.

5.8 Polymer linkage issues [i](#)

There are no chain breaks in this entry.

6 Map visualisation [i](#)

This section contains visualisations of the EMDB entry EMD-4479. These allow visual inspection of the internal detail of the map and identification of artifacts.

Images derived from a raw map, generated by summing the deposited half-maps, are presented below the corresponding image components of the primary map to allow further visual inspection and comparison with those of the primary map.

6.1 Orthogonal projections [i](#)

6.1.1 Primary map

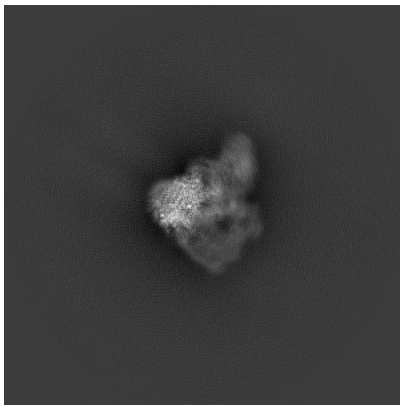

X

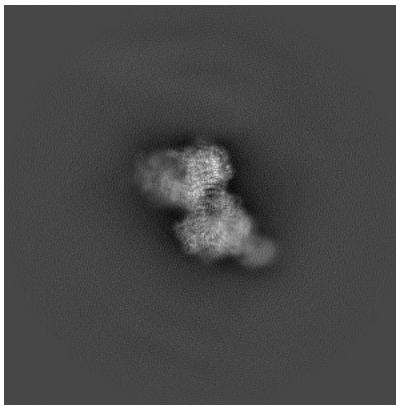

Y

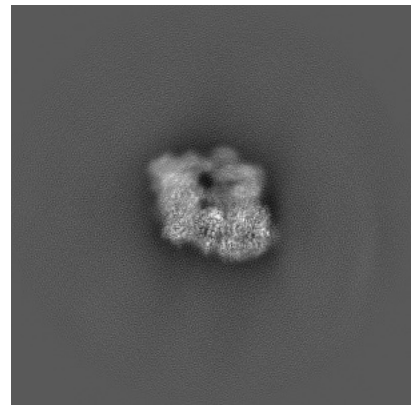

Z

6.1.2 Raw map

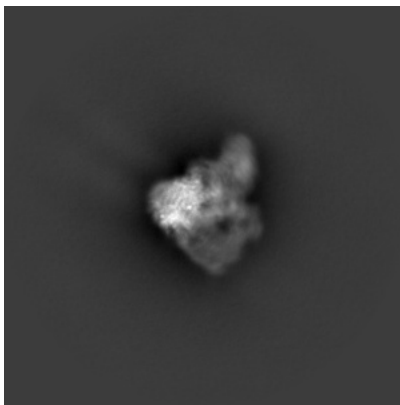

X

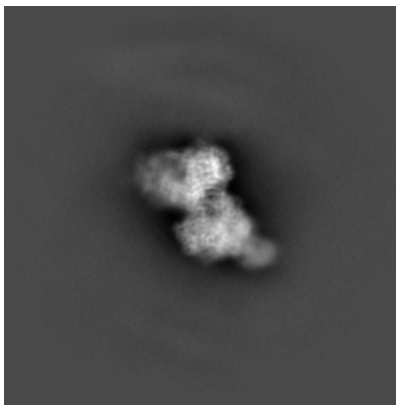

Y

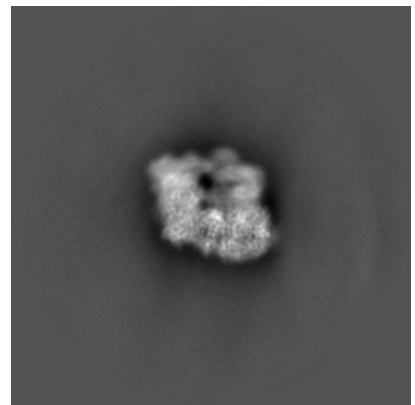

Z

The images above show the map projected in three orthogonal directions.

6.2 Central slices [i](#)

6.2.1 Primary map

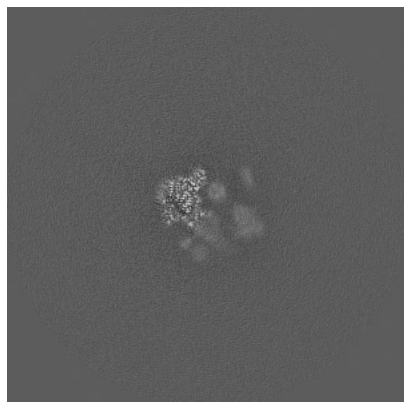

X Index: 256

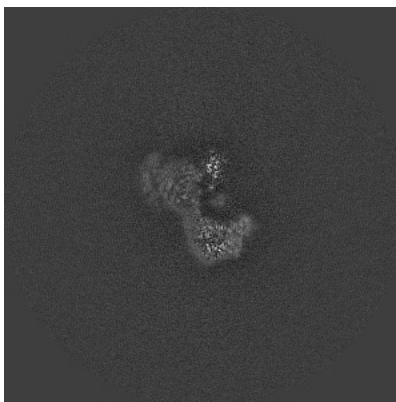

Y Index: 256

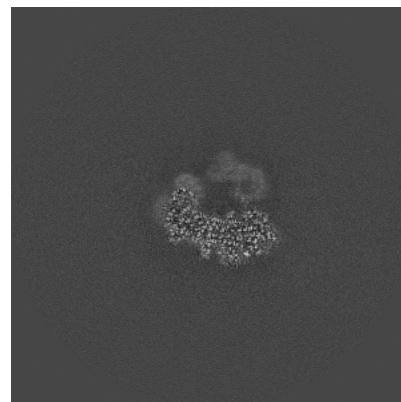

Z Index: 256

6.2.2 Raw map

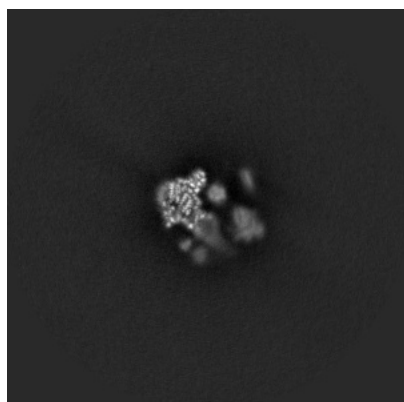

X Index: 256

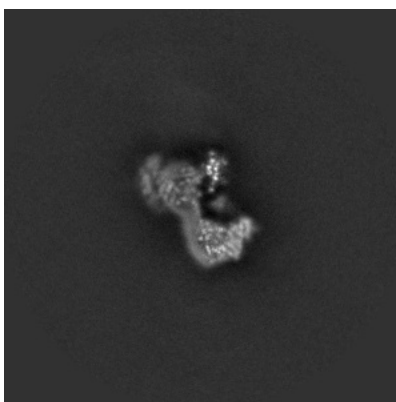

Y Index: 256

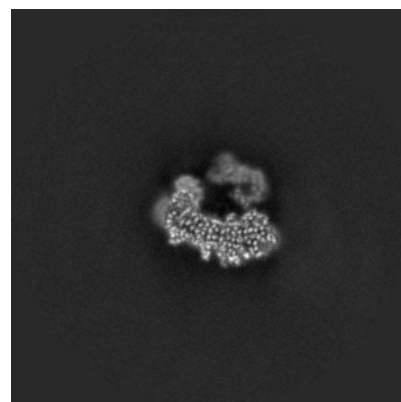

Z Index: 256

The images above show central slices of the map in three orthogonal directions.

6.3 Largest variance slices [i](#)

6.3.1 Primary map

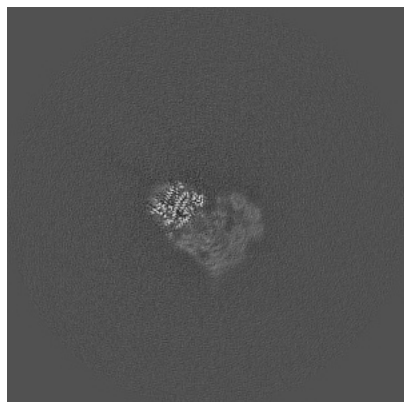

X Index: 285

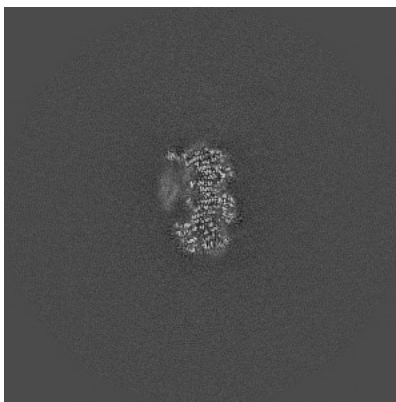

Y Index: 229

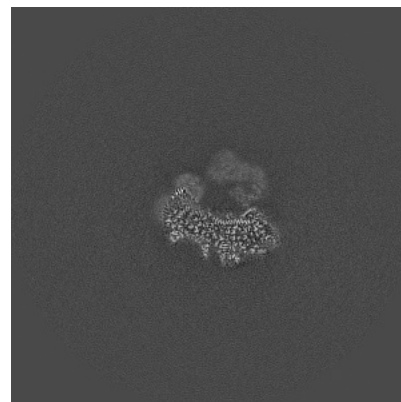

Z Index: 254

6.3.2 Raw map

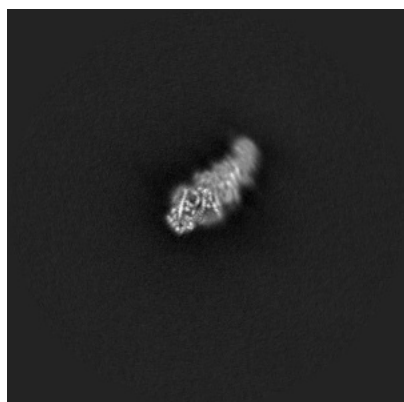

X Index: 207

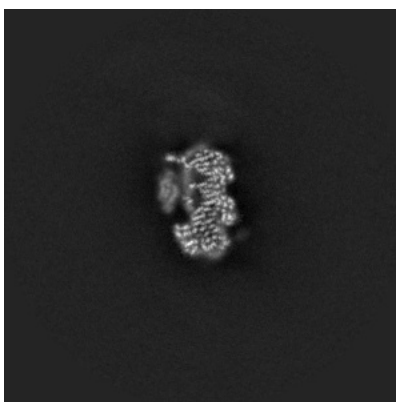

Y Index: 230

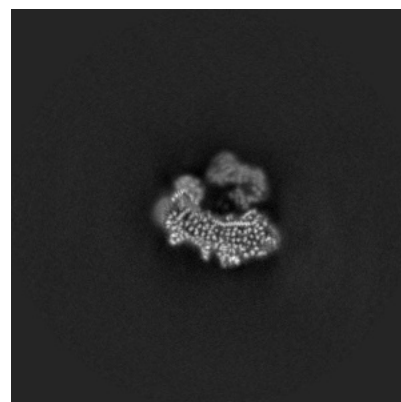

Z Index: 254

The images above show the largest variance slices of the map in three orthogonal directions.

6.4 Orthogonal surface views [i](#)

6.4.1 Primary map



The images above show the 3D surface view of the map at the recommended contour level 0.14. These images, in conjunction with the slice images, may facilitate assessment of whether an appropriate contour level has been provided.

6.4.2 Raw map



These images show the 3D surface of the raw map. The raw map's contour level was selected so that its surface encloses the same volume as the primary map does at its recommended contour level.

6.5 Mask visualisation [i](#)

This section shows the 3D surface view of the primary map at 50% transparency overlaid with the specified mask at 0% transparency

A mask typically either:

- Encompasses the whole structure
- Separates out a domain, a functional unit, a monomer or an area of interest from a larger structure

6.5.1 emd_4479_msk_1.map [i](#)

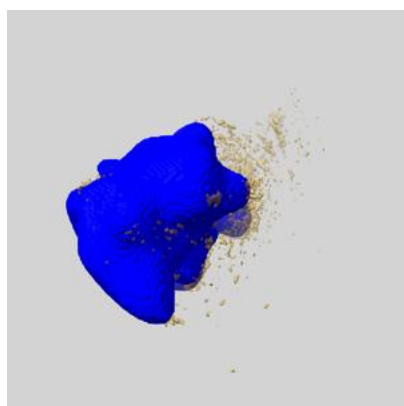

X

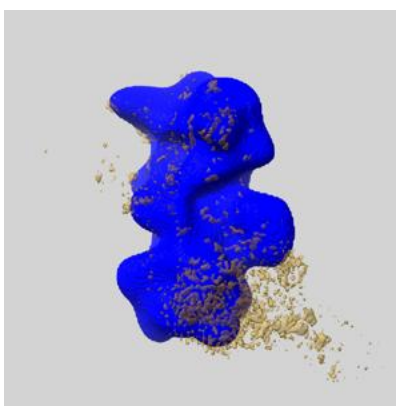

Y

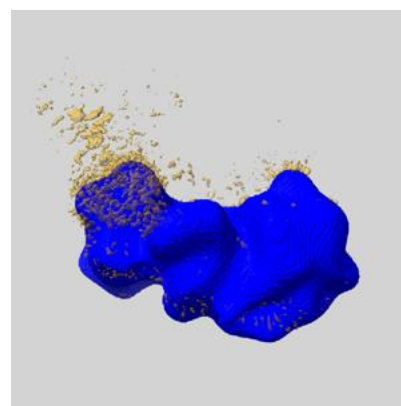

Z

7 Map analysis [i](#)

This section contains the results of statistical analysis of the map.

7.1 Map-value distribution [i](#)

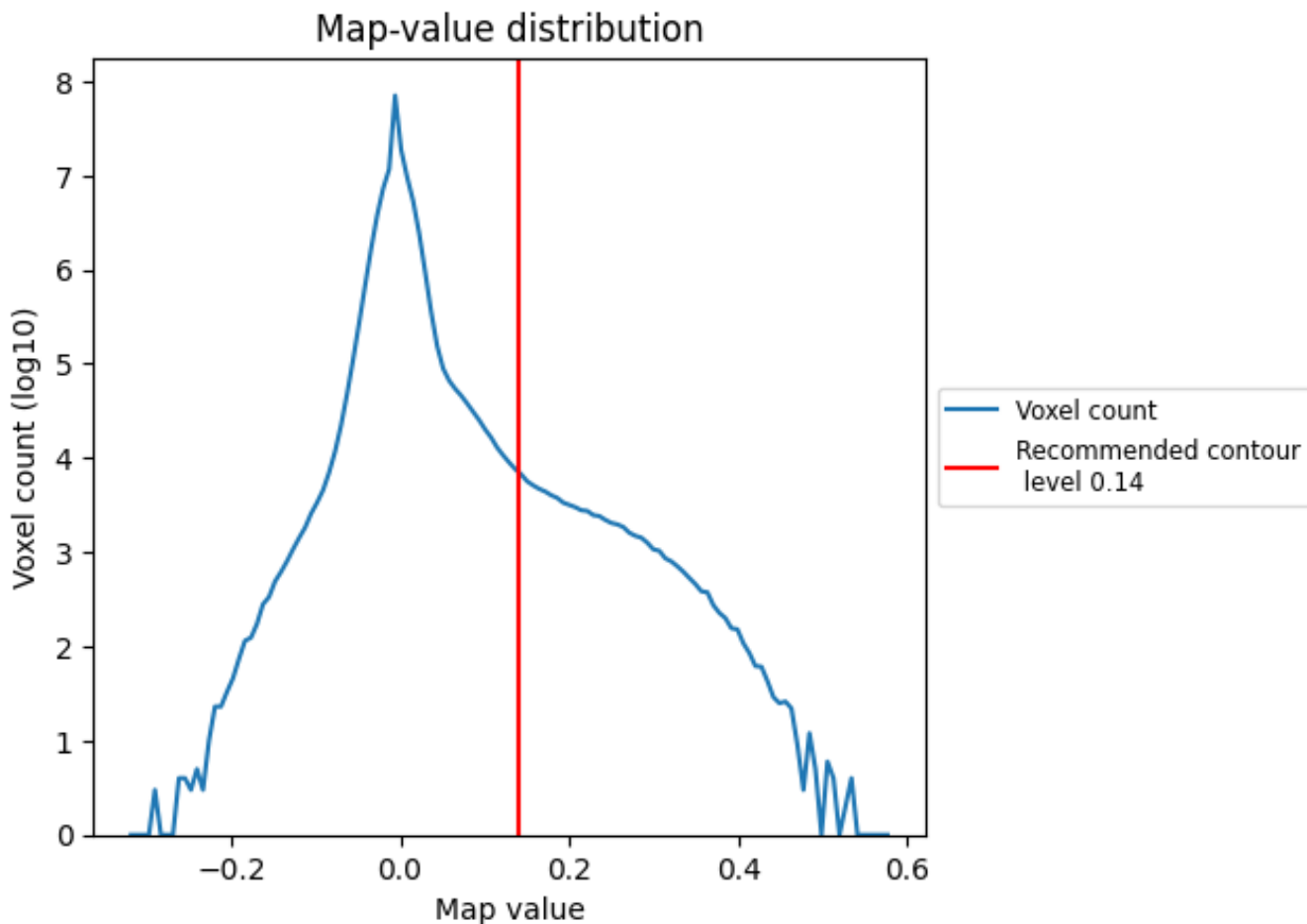

The map-value distribution is plotted in 128 intervals along the x-axis. The y-axis is logarithmic. A spike in this graph at zero usually indicates that the volume has been masked.

7.2 Volume estimate [i](#)

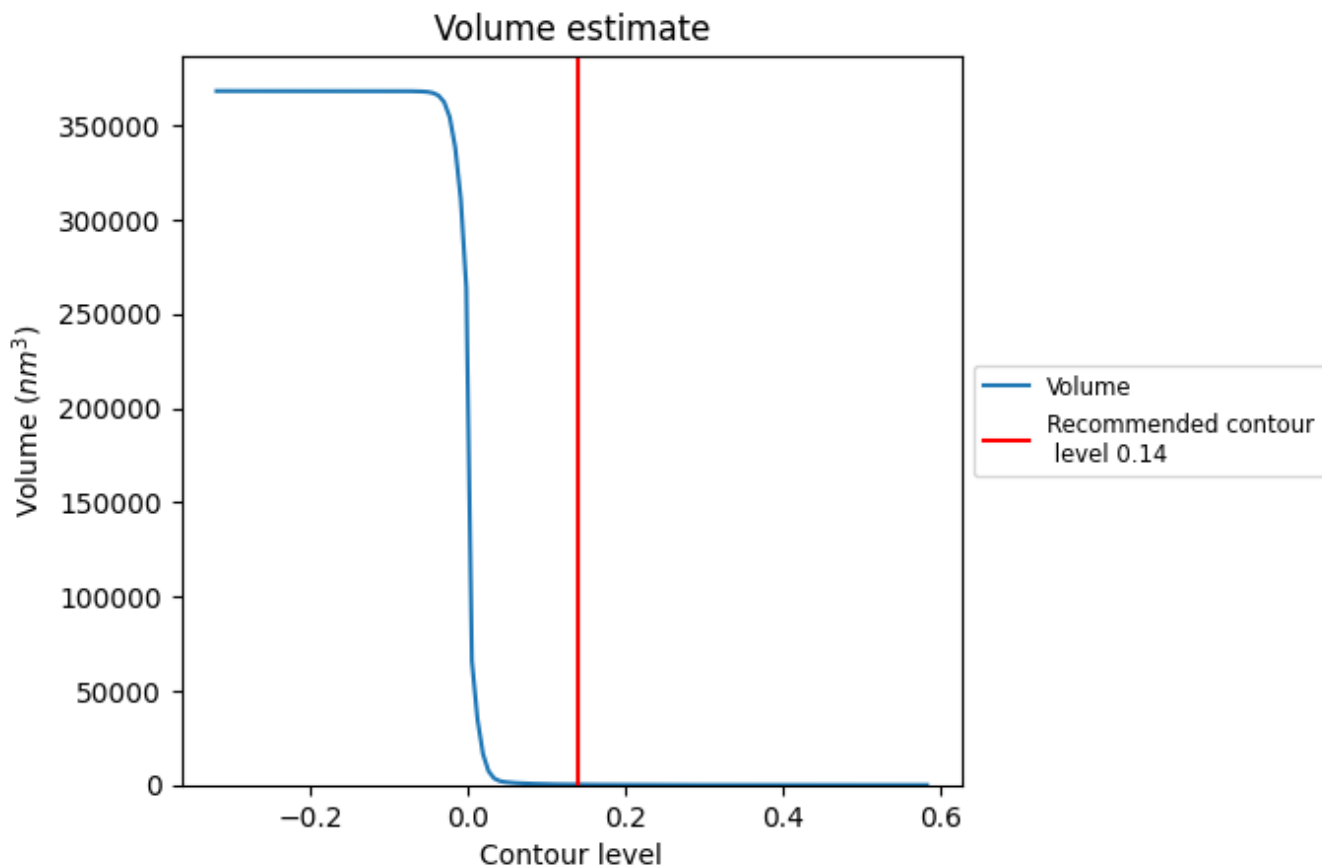

The volume at the recommended contour level is 220 nm³; this corresponds to an approximate mass of 199 kDa.

The volume estimate graph shows how the enclosed volume varies with the contour level. The recommended contour level is shown as a vertical line and the intersection between the line and the curve gives the volume of the enclosed surface at the given level.

7.3 Rotationally averaged power spectrum i

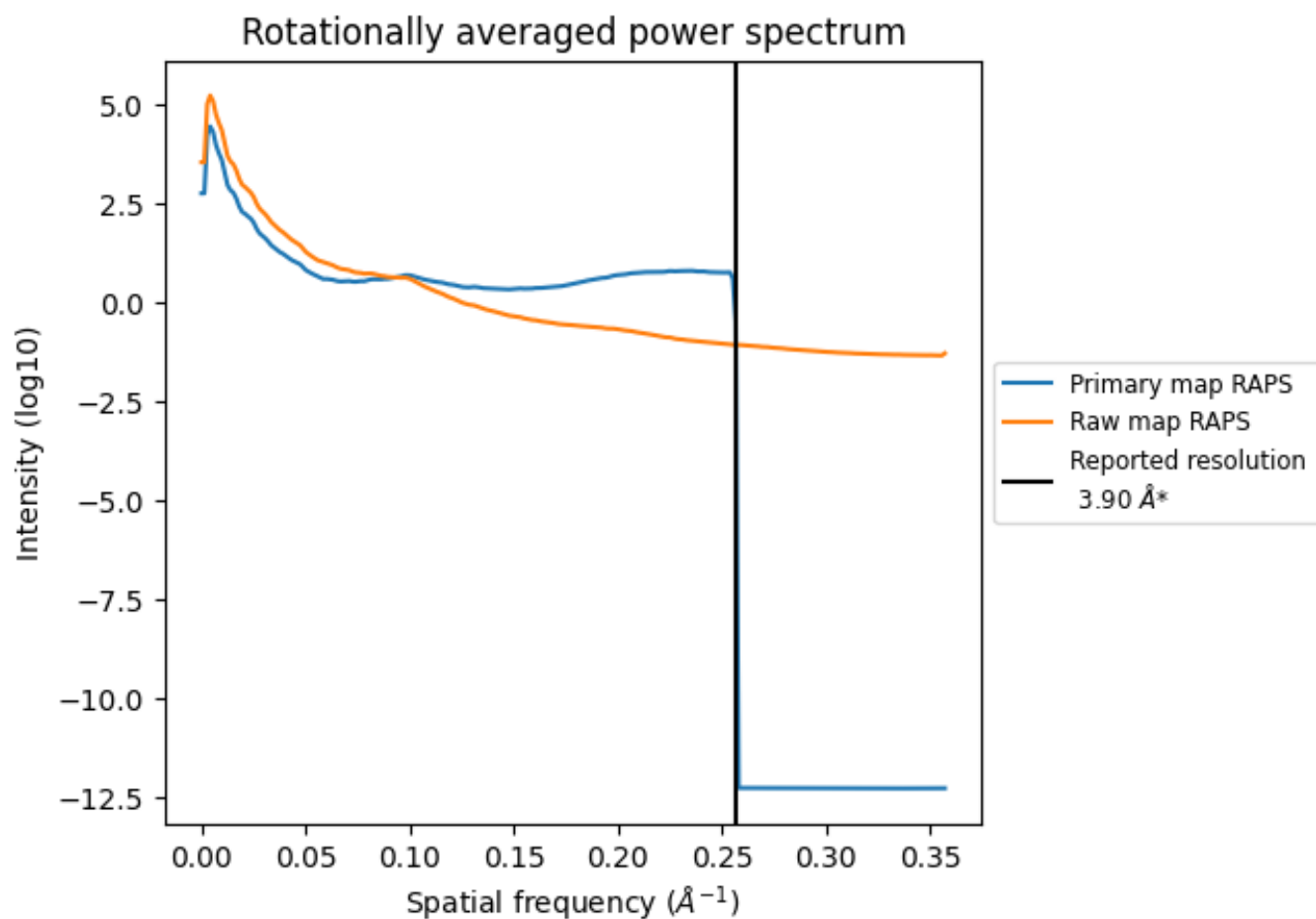

*Reported resolution corresponds to spatial frequency of 0.256 Å⁻¹

8 Fourier-Shell correlation [i](#)

Fourier-Shell Correlation (FSC) is the most commonly used method to estimate the resolution of single-particle and subtomogram-averaged maps. The shape of the curve depends on the imposed symmetry, mask and whether or not the two 3D reconstructions used were processed from a common reference. The reported resolution is shown as a black line. A curve is displayed for the half-bit criterion in addition to lines showing the 0.143 gold standard cut-off and 0.5 cut-off.

8.1 FSC [i](#)

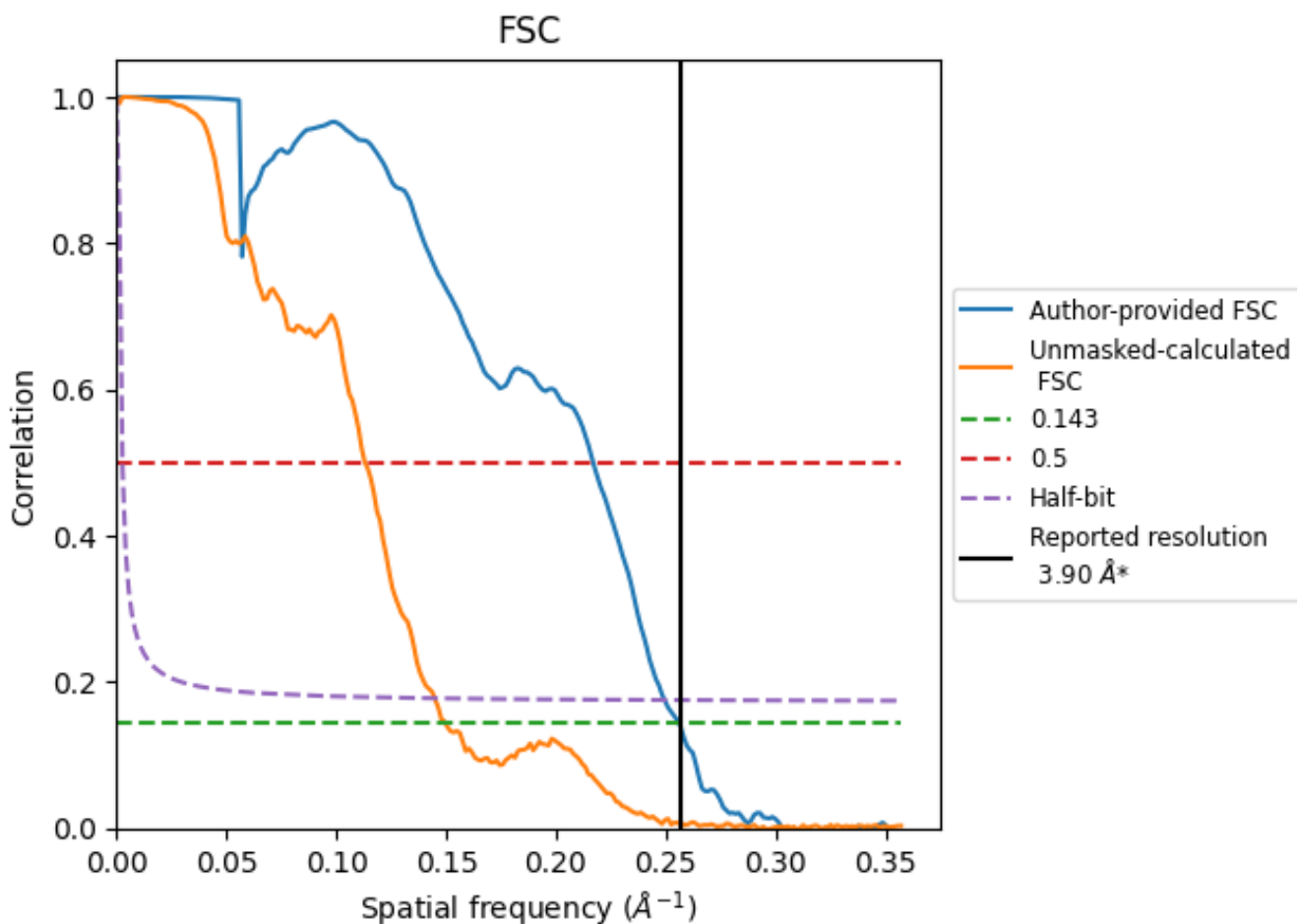

*Reported resolution corresponds to spatial frequency of 0.256 Å⁻¹

8.2 Resolution estimates [i](#)

Resolution estimate (Å)	Estimation criterion (FSC cut-off)		
	0.143	0.5	Half-bit
Reported by author	3.90	-	-
Author-provided FSC curve	3.91	4.61	4.01
Unmasked-calculated*	6.68	8.84	6.91

*Resolution estimate based on FSC curve calculated by comparison of deposited half-maps. The value from deposited half-maps intersecting FSC 0.143 CUT-OFF 6.68 differs from the reported value 3.9 by more than 10 %

9 Map-model fit [i](#)

This section contains information regarding the fit between EMDB map EMD-4479 and PDB model 6Q9B. Per-residue inclusion information can be found in section 3 on page 12.

9.1 Map-model overlay [i](#)

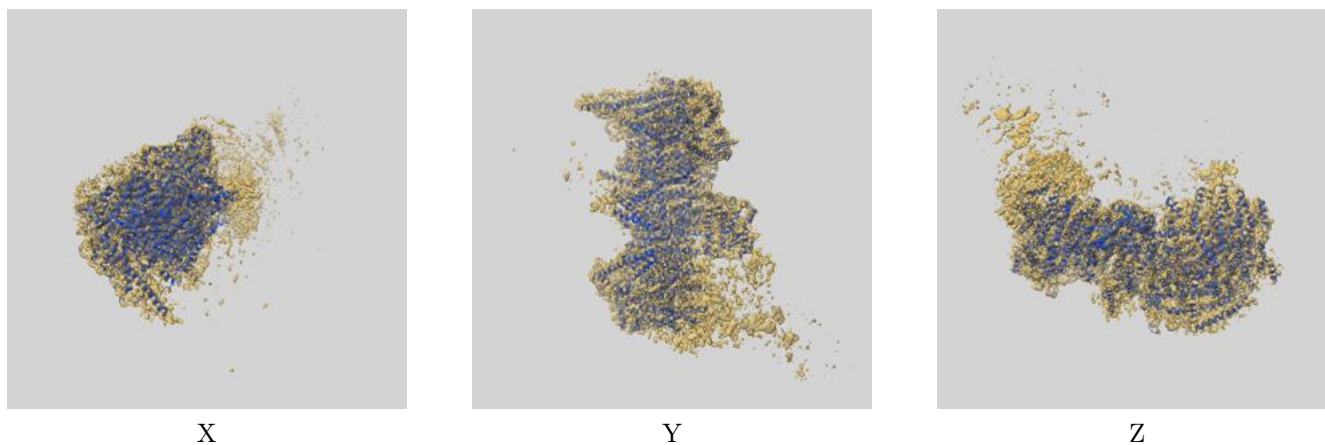

The images above show the 3D surface view of the map at the recommended contour level 0.14 at 50% transparency in yellow overlaid with a ribbon representation of the model coloured in blue. These images allow for the visual assessment of the quality of fit between the atomic model and the map.

9.2 Q-score mapped to coordinate model [i](#)

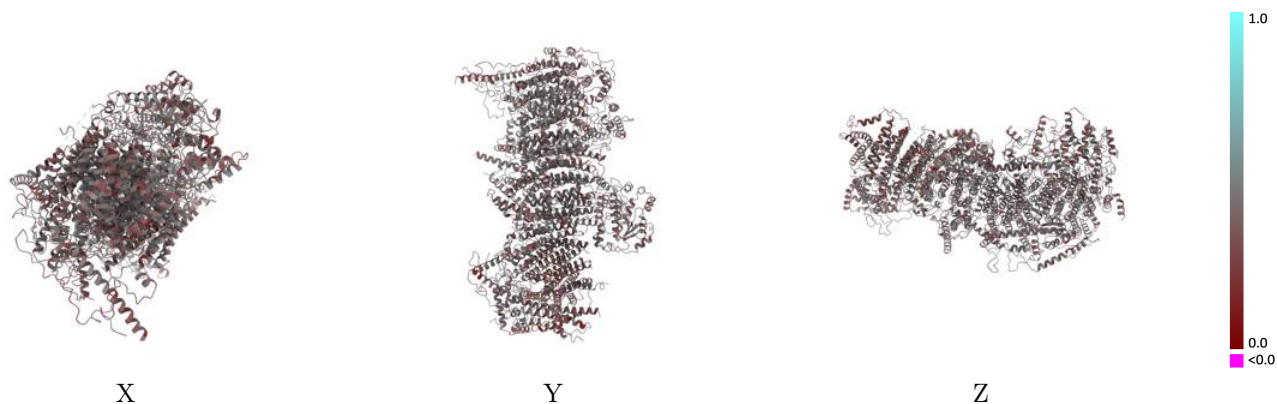

The images above show the model with each residue coloured according to its Q-score. This shows their resolvability in the map with higher Q-score values reflecting better resolvability. Please note: Q-score is calculating the resolvability of atoms, and thus high values are only expected at resolutions at which atoms can be resolved. Low Q-score values may therefore be expected for many entries.

9.3 Atom inclusion mapped to coordinate model [i](#)

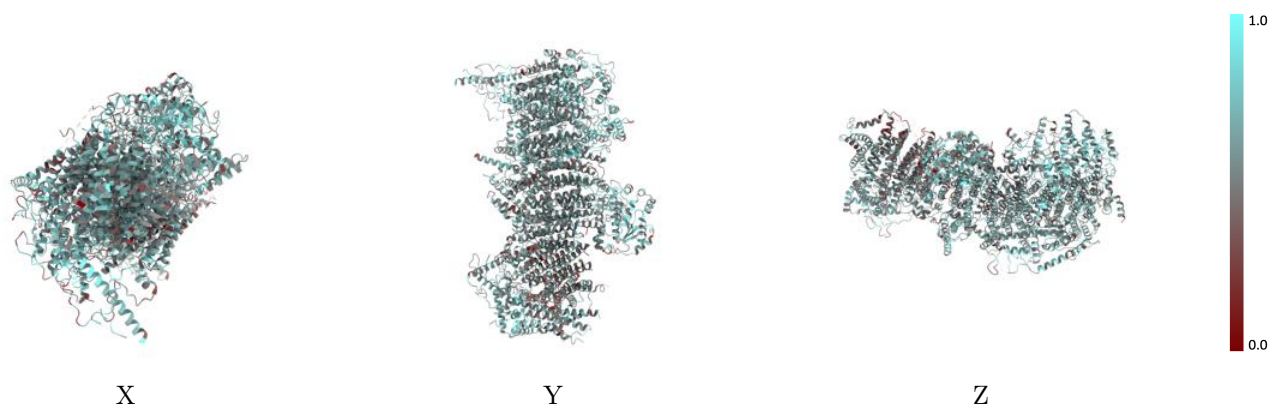

The images above show the model with each residue coloured according to its atom inclusion. This shows to what extent they are inside the map at the recommended contour level (0.14).



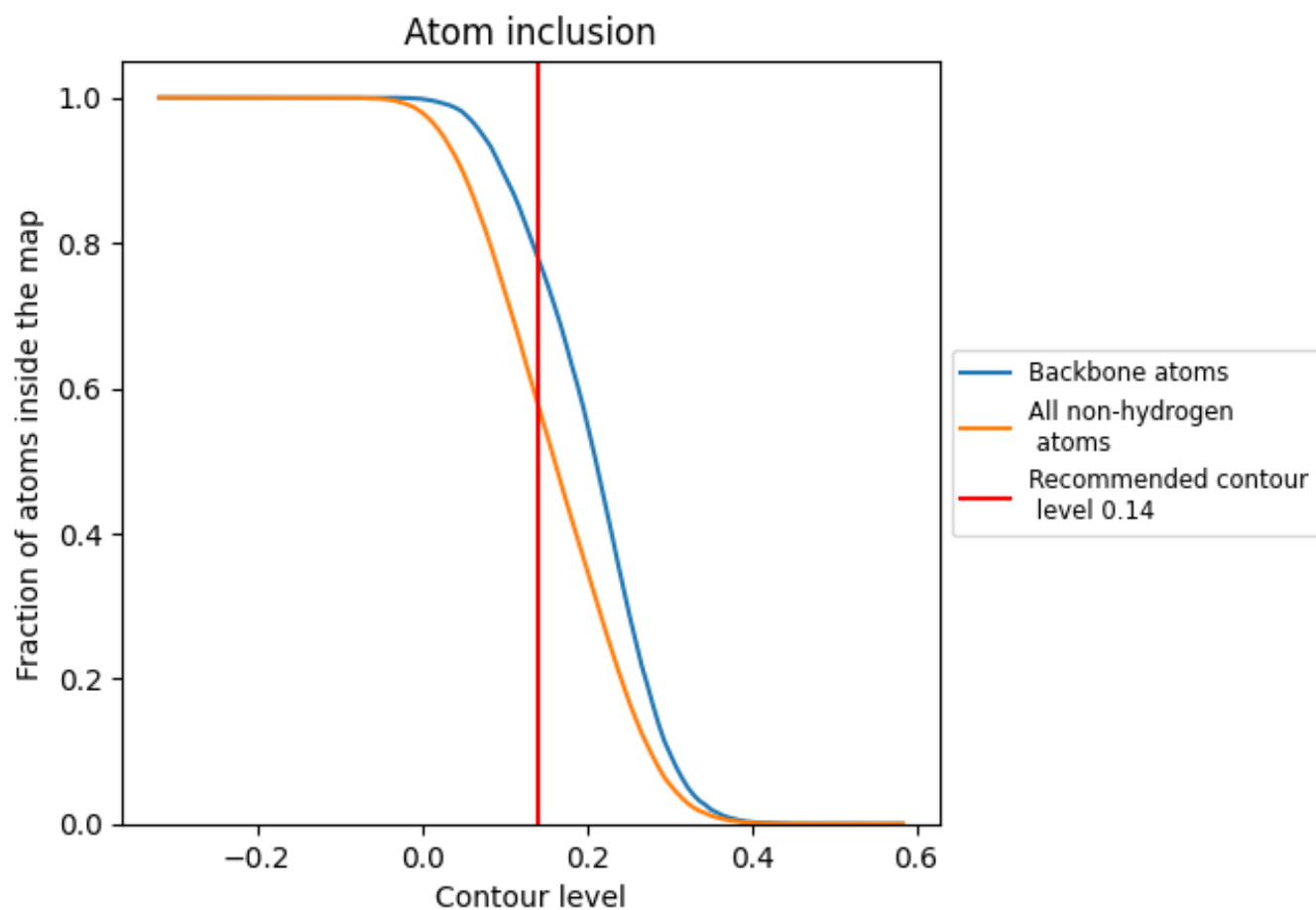

























































9.4 Atom inclusion [i](#)



At the recommended contour level, 78% of all backbone atoms, 58% of all non-hydrogen atoms, are inside the map.

9.5 Map-model fit summary

The table lists the average atom inclusion at the recommended contour level (0.14) and Q-score for the entire model and for each chain.

Chain	Atom inclusion	Q-score
All	 0.5803	 0.4030
4L	 0.5121	 0.3970
A1	 0.6264	 0.4180
A3	 0.5351	 0.3850
A8	 0.6188	 0.4020
AB	 0.6176	 0.3880
AJ	 0.6062	 0.3990
AK	 0.4785	 0.3970
AM	 0.6254	 0.3910
B1	 0.5275	 0.3780
B2	 0.5839	 0.3750
B3	 0.5940	 0.3840
B4	 0.5897	 0.4140
B5	 0.6200	 0.4210
B6	 0.6207	 0.3980
B7	 0.6322	 0.3700
B8	 0.6087	 0.4110
B9	 0.6724	 0.4110
BJ	 0.6450	 0.4060
BK	 0.5981	 0.3960
C1	 0.6073	 0.4100
C2	 0.6141	 0.4060
D1	 0.5258	 0.3730
D2	 0.5704	 0.4200
D3	 0.4703	 0.3790
D4	 0.5817	 0.4290
D5	 0.5609	 0.4160
D6	 0.4687	 0.3780
S2	 0.5110	 0.4090
S5	 0.6077	 0.3920

