



Full wwPDB EM Validation Report ⓘ

Jan 29, 2022 – 06:16 am GMT

PDB ID : 7QJ8
EMDB ID : EMD-14013
Title : Structure of recombinant human gamma-Tubulin Ring Complex 12-spoked assembly intermediate (spokes 3-14, substoichiometric spokes 1-2)
Authors : Zupa, E.; Pfeffer, S.
Deposited on : 2021-12-16
Resolution : 8.70 Å (reported)
Based on initial models : 6X0U, 6L81, 6V6S, 7AS4

This is a Full wwPDB EM Validation Report for a publicly released PDB entry.

We welcome your comments at validation@mail.wwpdb.org

A user guide is available at

<https://www.wwpdb.org/validation/2017/EMValidationReportHelp>

with specific help available everywhere you see the ⓘ symbol.

The following versions of software and data (see [references ⓘ](#)) were used in the production of this report:

EMDB validation analysis : 0.0.0.dev97
MolProbity : 4.02b-467
Percentile statistics : 20191225.v01 (using entries in the PDB archive December 25th 2019)
Ideal geometry (proteins) : Engh & Huber (2001)
Ideal geometry (DNA, RNA) : Parkinson et al. (1996)
Validation Pipeline (wwPDB-VP) : 2.26

1 Overall quality at a glance

The following experimental techniques were used to determine the structure:

ELECTRON MICROSCOPY

The reported resolution of this entry is 8.70 Å.

Percentile scores (ranging between 0-100) for global validation metrics of the entry are shown in the following graphic. The table shows the number of entries on which the scores are based.

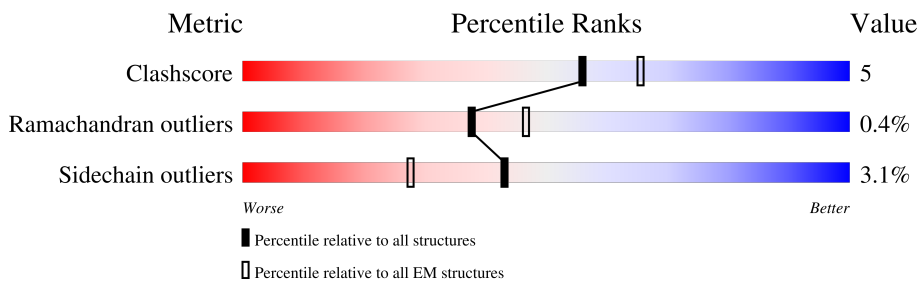

Metric	Whole archive (#Entries)	EM structures (#Entries)
Clashscore	158937	4297
Ramachandran outliers	154571	4023
Sidechain outliers	154315	3826

The table below summarises the geometric issues observed across the polymeric chains and their fit to the map. The red, orange, yellow and green segments of the bar indicate the fraction of residues that contain outliers for ≥ 3 , 2, 1 and 0 types of geometric quality criteria respectively. A grey segment represents the fraction of residues that are not modelled. The numeric value for each fraction is indicated below the corresponding segment, with a dot representing fractions $\leq 5\%$. The upper red bar (where present) indicates the fraction of residues that have poor fit to the EM map (all-atom inclusion $< 40\%$). The numeric value is given above the bar.

Mol	Chain	Length	Quality of chain
1	J	1024	
1	l	1024	
2	1	451	
2	2	451	
2	Q	451	
2	R	451	
2	S	451	
2	T	451	



Continued on next page...

Continued from previous page...

Mol	Chain	Length	Quality of chain
2	U	451	70% 21% 7%
2	V	451	71% 21% 7%
2	W	451	71% 20% 7%
2	X	451	71% 21% 7%
2	Y	451	69% 22% 7%
2	Z	451	70% 21% 7%
3	e	375	46% 95%
4	b	82	9% 79% 21%
4	d	82	17% 71% 28%
4	i	82	13% 78% 21%
4	k	82	5% 79% 21%
4	m	82	79% 21%
5	D	907	58% 6% 36%
5	F	907	57% 8% 34%
5	H	907	61% 5% 35%
5	N	907	59% 6% 35%
5	a	907	13% 87%
5	h	907	11% 89%
5	j	907	12% 88%
6	C	902	60% 8% 31%
6	E	902	61% 9% 29%
6	G	902	66% 5% 29%
6	M	902	62% 8% 29%
7	I	667	70% 7% 22%
7	K	667	76% 8% 16%

Continued on next page...

Continued from previous page...

Mol	Chain	Length	Quality of chain
8	L	1819	 28% 69%
8	c	1819	 9% 91%

2 Entry composition [i](#)

There are 9 unique types of molecules in this entry. The entry contains 108354 atoms, of which 0 are hydrogens and 0 are deuteriums.

In the tables below, the AltConf column contains the number of residues with at least one atom in alternate conformation and the Trace column contains the number of residues modelled with at most 2 atoms.

- Molecule 1 is a protein called Gamma-tubulin complex component 5.

Mol	Chain	Residues	Atoms					AltConf	Trace
			Total	C	N	O	S		
1	I	108	847	539	150	157	1	0	0
1	J	534	4429	2893	737	776	23	0	0

- Molecule 2 is a protein called Tubulin gamma-1 chain.

Mol	Chain	Residues	Atoms					AltConf	Trace
			Total	C	N	O	S		
2	1	420	3373	2134	586	638	15	0	0
2	2	420	3373	2134	586	638	15	0	0
2	Q	420	3373	2134	586	638	15	0	0
2	R	420	3373	2134	586	638	15	0	0
2	S	420	3373	2134	586	638	15	0	0
2	T	420	3373	2134	586	638	15	0	0
2	U	420	3373	2134	586	638	15	0	0
2	V	420	3373	2134	586	638	15	0	0
2	W	420	3373	2134	586	638	15	0	0
2	X	420	3373	2134	586	638	15	0	0
2	Y	420	3373	2134	586	638	15	0	0
2	Z	420	3373	2134	586	638	15	0	0

- Molecule 3 is a protein called actin, cytoplasmic 1.

Mol	Chain	Residues	Atoms					AltConf	Trace
			Total	C	N	O	S		
3	e	364	2847	1803	476	548	20	0	0

- Molecule 4 is a protein called Mitotic-spindle organizing protein 1.

Mol	Chain	Residues	Atoms					AltConf	Trace
			Total	C	N	O	S		
4	b	65	484	299	85	96	4	0	0
4	i	65	484	299	85	96	4	0	0
4	k	65	484	299	85	96	4	0	0
4	m	65	484	299	85	96	4	0	0
4	d	59	454	281	79	90	4	0	0

- Molecule 5 is a protein called Gamma-tubulin complex component 3.

Mol	Chain	Residues	Atoms					AltConf	Trace
			Total	C	N	O	S		
5	a	116	933	591	171	169	2	0	0
5	D	581	4796	3061	842	868	25	0	0
5	F	599	4941	3151	871	894	25	0	0
5	H	594	4907	3130	864	888	25	0	0
5	N	594	4907	3130	864	888	25	0	0
5	h	99	803	509	148	144	2	0	0
5	j	107	843	533	156	152	2	0	0

- Molecule 6 is a protein called Gamma-tubulin complex component 2.

Mol	Chain	Residues	Atoms					AltConf	Trace
			Total	C	N	O	S		
6	C	620	5044	3257	845	910	32	0	0
6	E	638	5202	3354	873	942	33	0	0

Continued on next page...

Continued from previous page...

Mol	Chain	Residues	Atoms					AltConf	Trace
6	G	636	Total	C	N	O	S	0	0
			5186	3342	871	940	33		
6	M	636	Total	C	N	O	S	0	0
			5186	3342	871	940	33		

- Molecule 7 is a protein called Gamma-tubulin complex component 4.

Mol	Chain	Residues	Atoms					AltConf	Trace
7	I	521	Total	C	N	O	S	0	0
			4225	2737	720	750	18		
7	K	562	Total	C	N	O	S	0	0
			4579	2964	781	816	18		

- Molecule 8 is a protein called Gamma-tubulin complex component 6.

Mol	Chain	Residues	Atoms					AltConf	Trace
8	L	566	Total	C	N	O	S	0	0
			4587	3000	773	789	25		
8	c	158	Total	C	N	O	S	0	0
			1220	771	209	232	8		

- Molecule 9 is water.

Mol	Chain	Residues	Atoms		AltConf
9	l	5	Total	O	0
			5	5	
9	m	1	Total	O	0
			1	1	

3 Residue-property plots [i](#)

These plots are drawn for all protein, RNA, DNA and oligosaccharide chains in the entry. The first graphic for a chain summarises the proportions of the various outlier classes displayed in the second graphic. The second graphic shows the sequence view annotated by issues in geometry and atom inclusion in map density. Residues are color-coded according to the number of geometric quality criteria for which they contain at least one outlier: green = 0, yellow = 1, orange = 2 and red = 3 or more. A red diamond above a residue indicates a poor fit to the EM map for this residue (all-atom inclusion < 40%). Stretches of 2 or more consecutive residues without any outlier are shown as a green connector. Residues present in the sample, but not in the model, are shown in grey.

- Molecule 1: Gamma-tubulin complex component 5

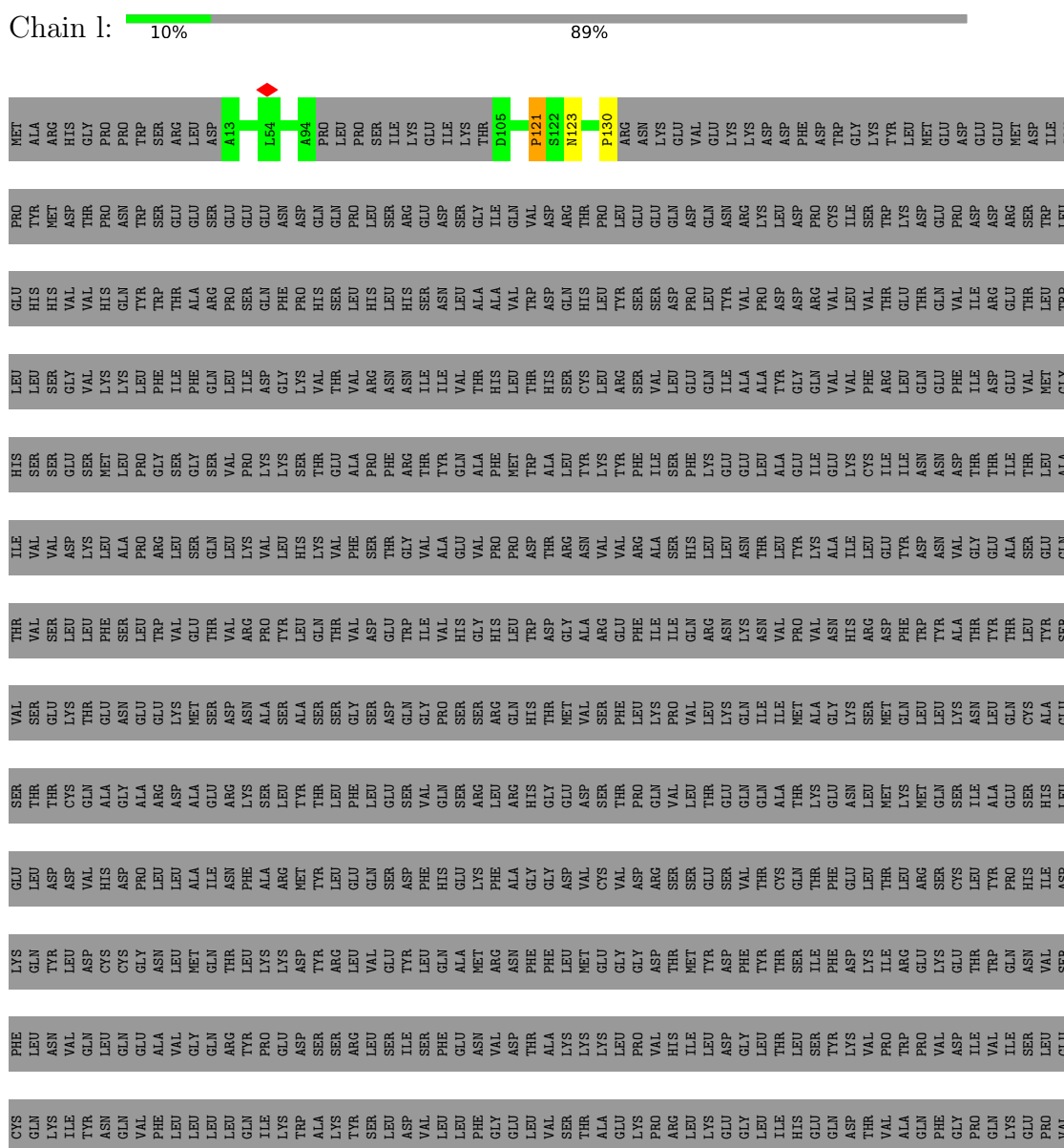

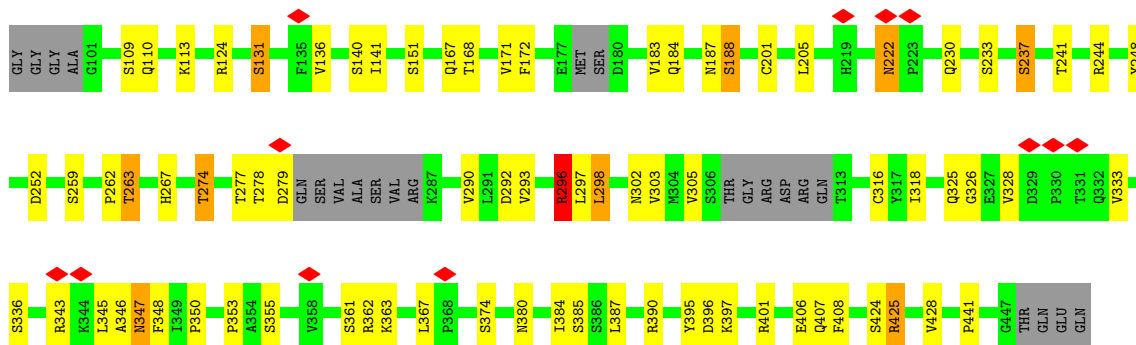

• Molecule 2: Tubulin gamma-1 chain

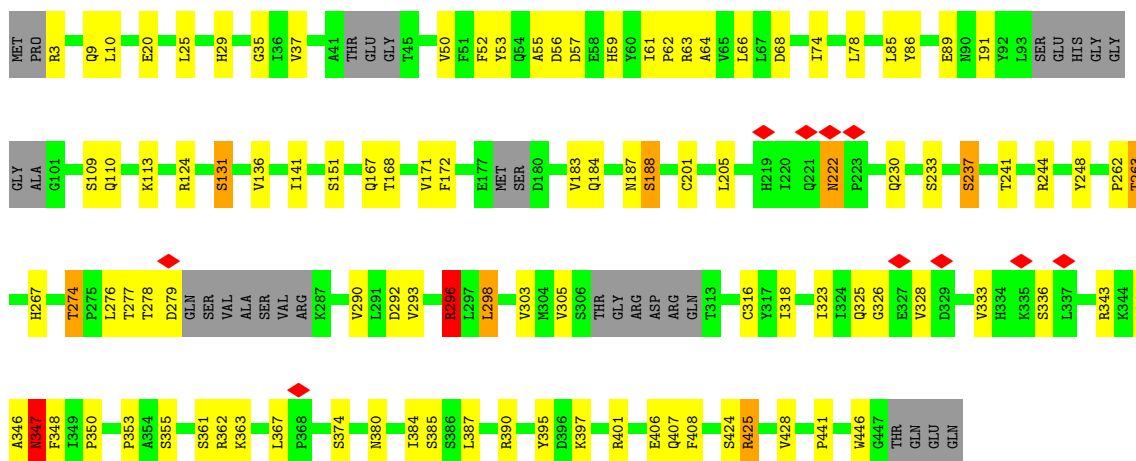

• Molecule 2: Tubulin gamma-1 chain

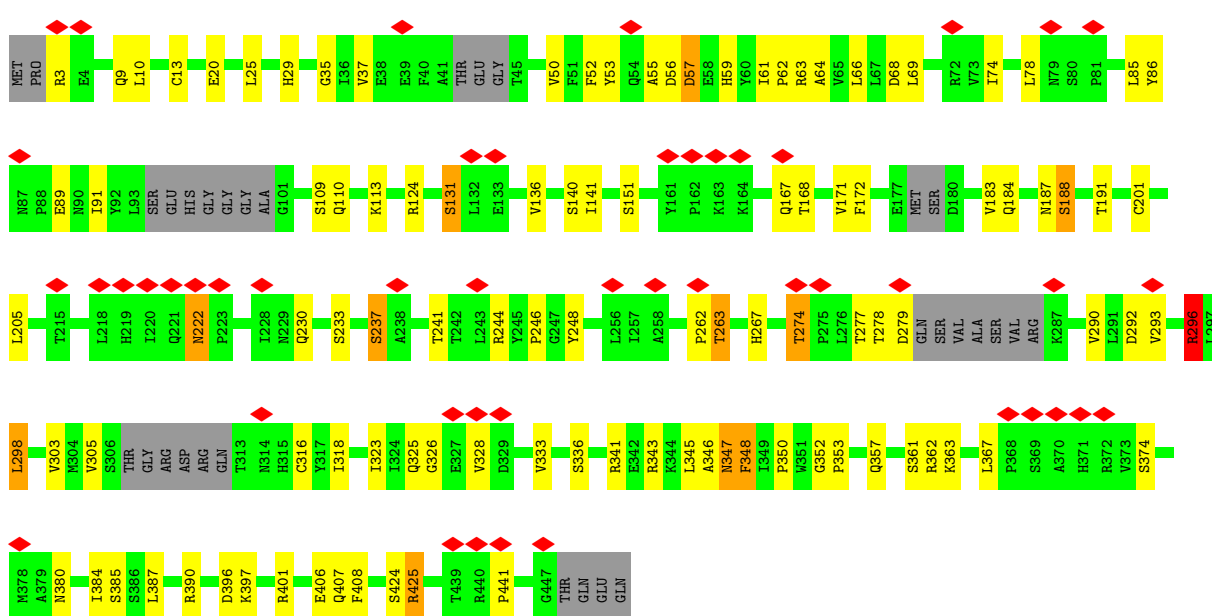

• Molecule 2: Tubulin gamma-1 chain

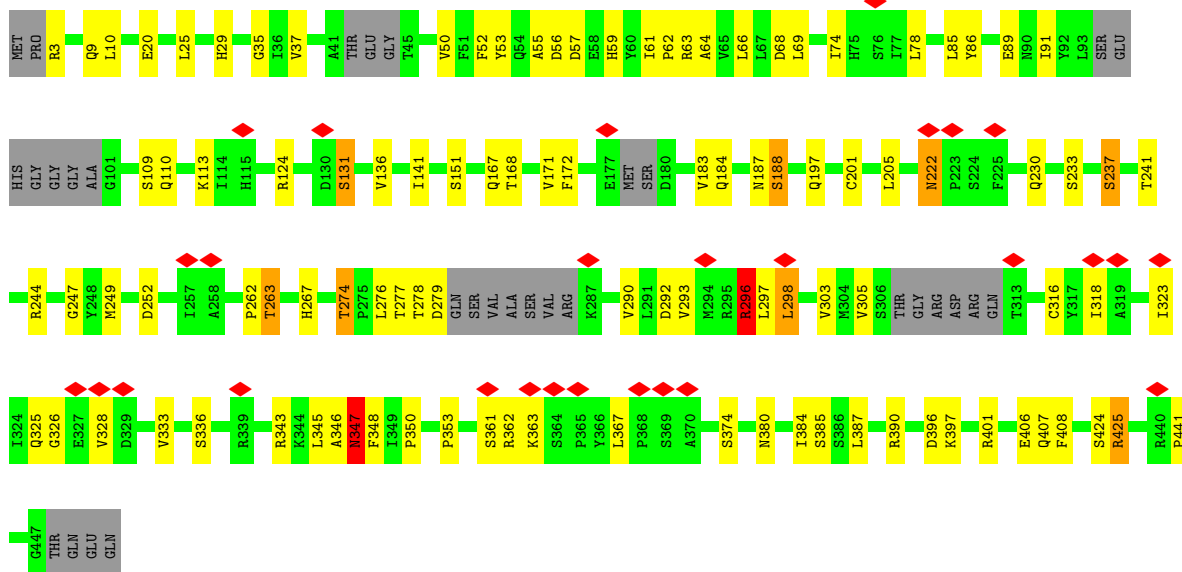

• Molecule 2: Tubulin gamma-1 chain

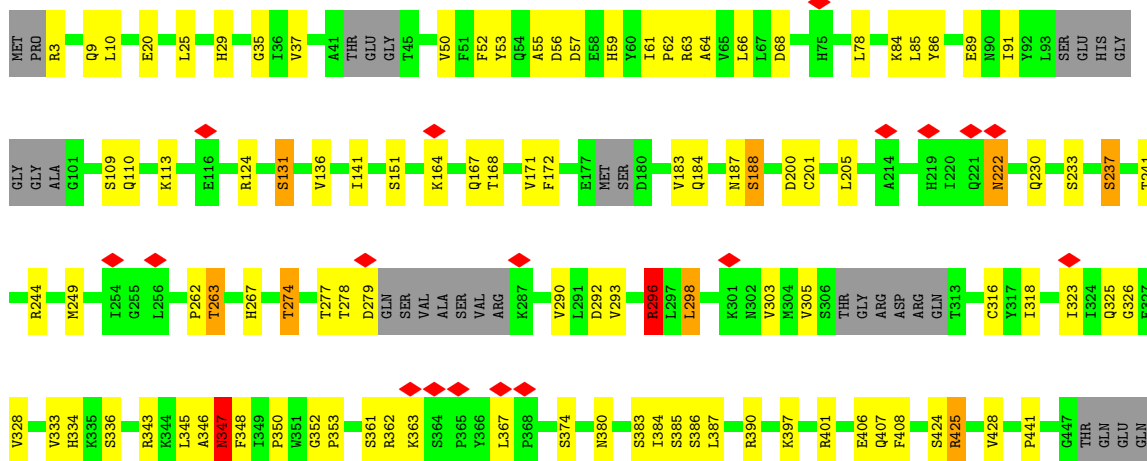

• Molecule 2: Tubulin gamma-1 chain

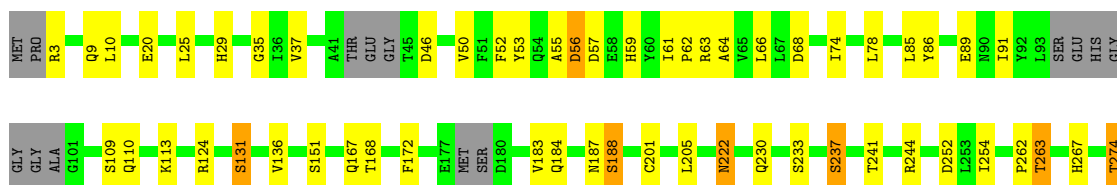

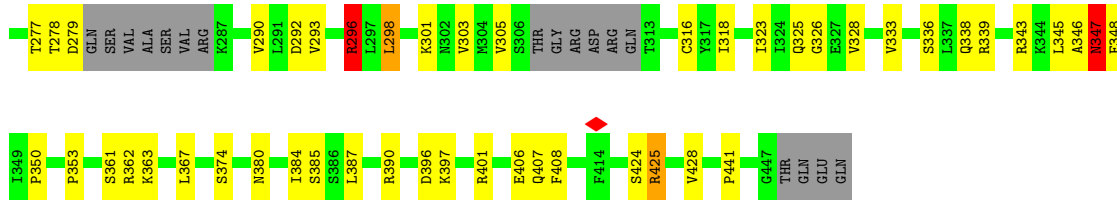

• Molecule 2: Tubulin gamma-1 chain

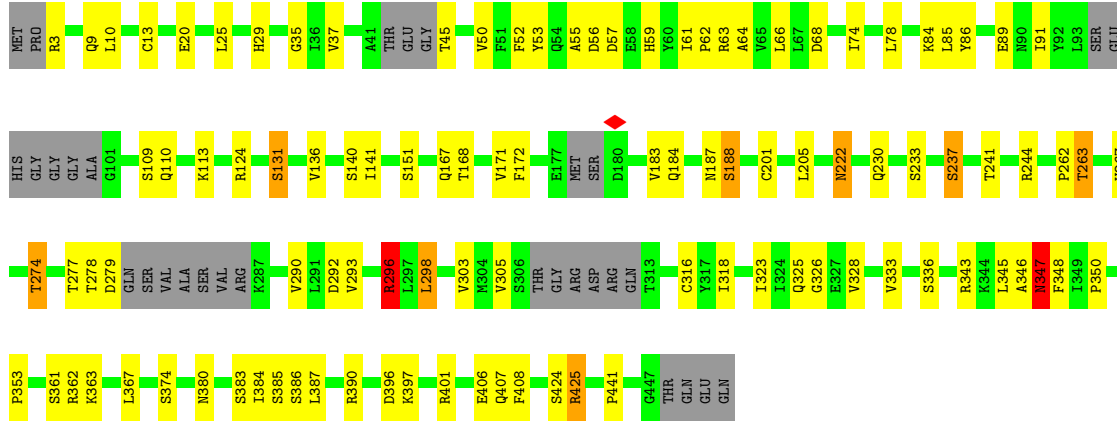

• Molecule 2: Tubulin gamma-1 chain

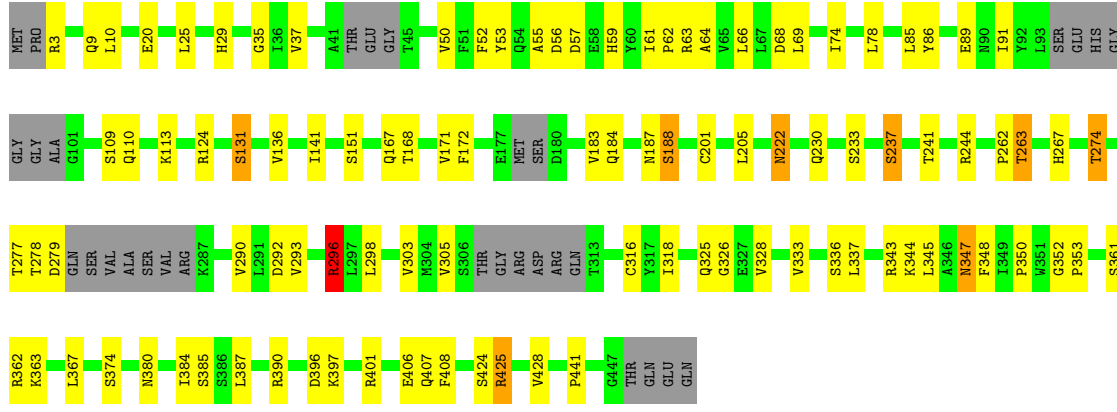

• Molecule 2: Tubulin gamma-1 chain

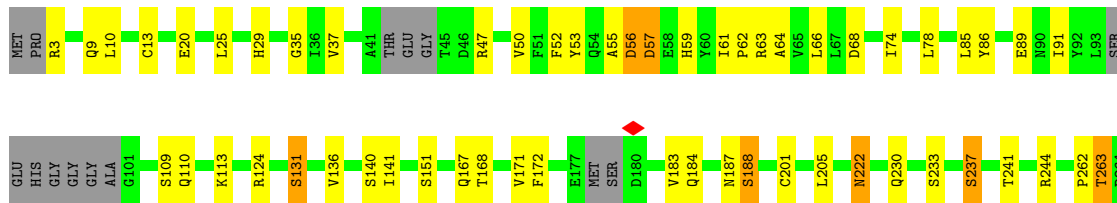

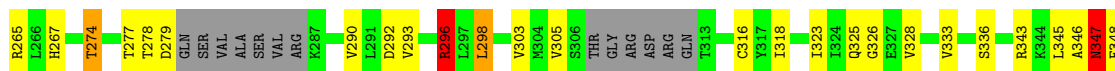

• Molecule 2: Tubulin gamma-1 chain

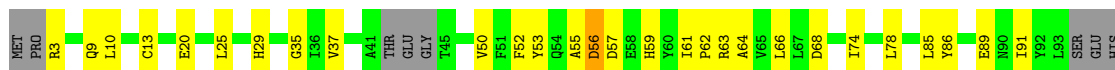

• Molecule 2: Tubulin gamma-1 chain

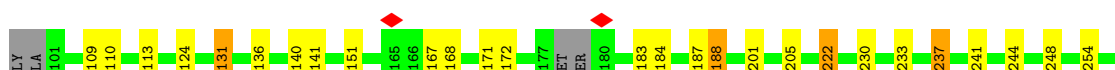

• Molecule 2: Tubulin gamma-1 chain



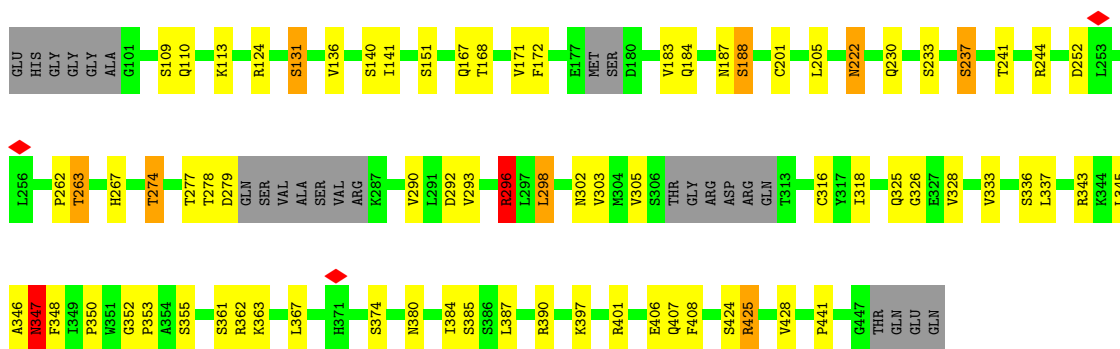

• Molecule 3: actin, cytoplasmic 1

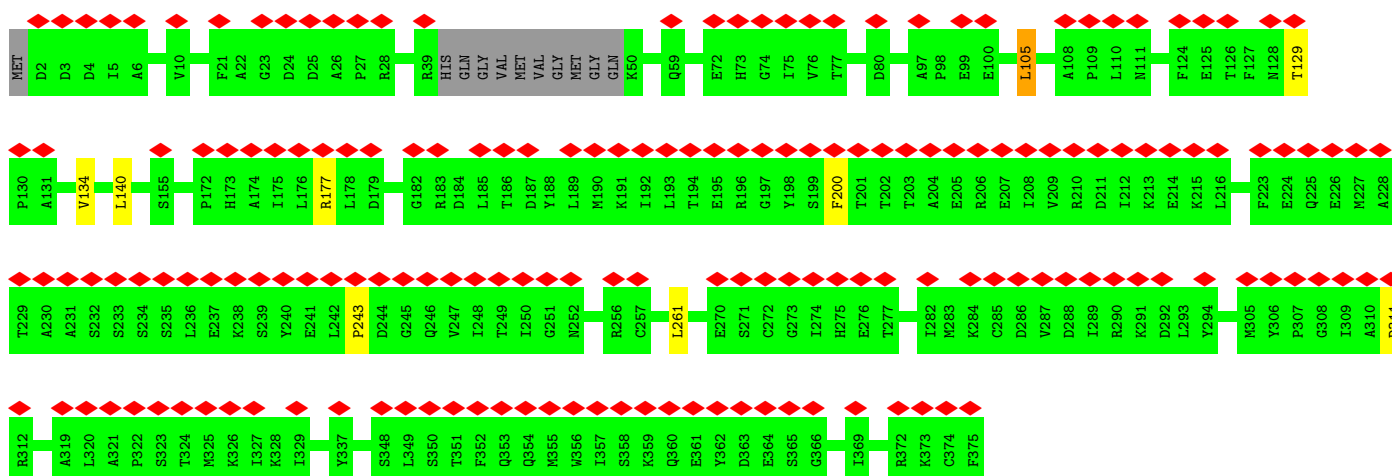

• Molecule 4: Mitotic-spindle organizing protein 1

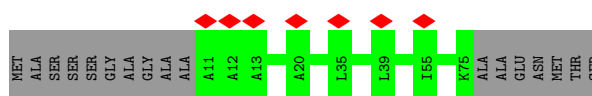
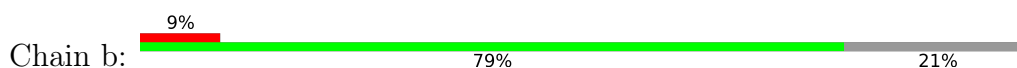

• Molecule 4: Mitotic-spindle organizing protein 1

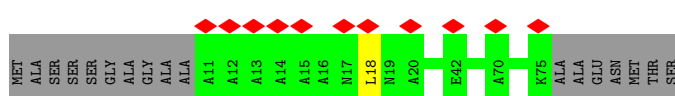
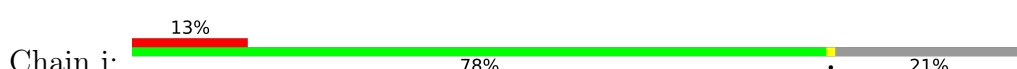

• Molecule 4: Mitotic-spindle organizing protein 1



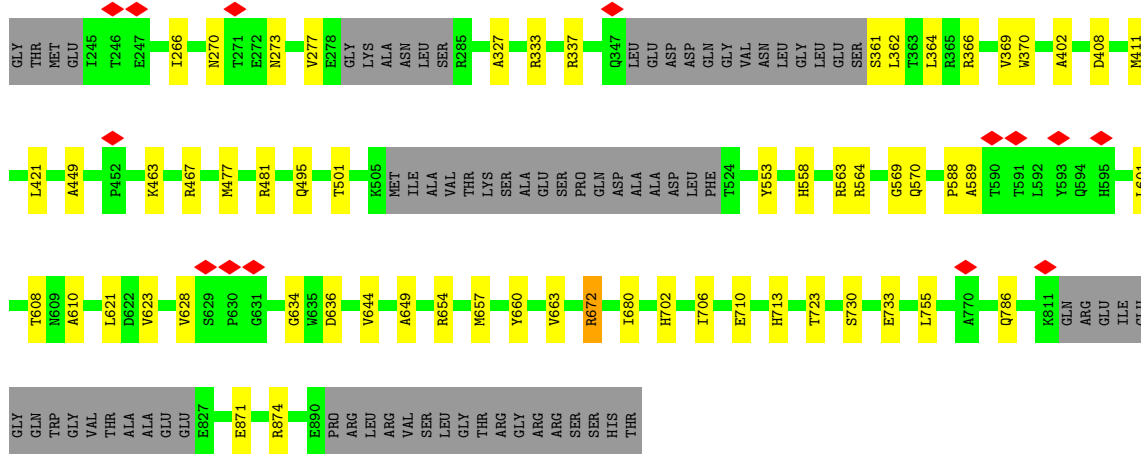

● Molecule 5: Gamma-tubulin complex component 3

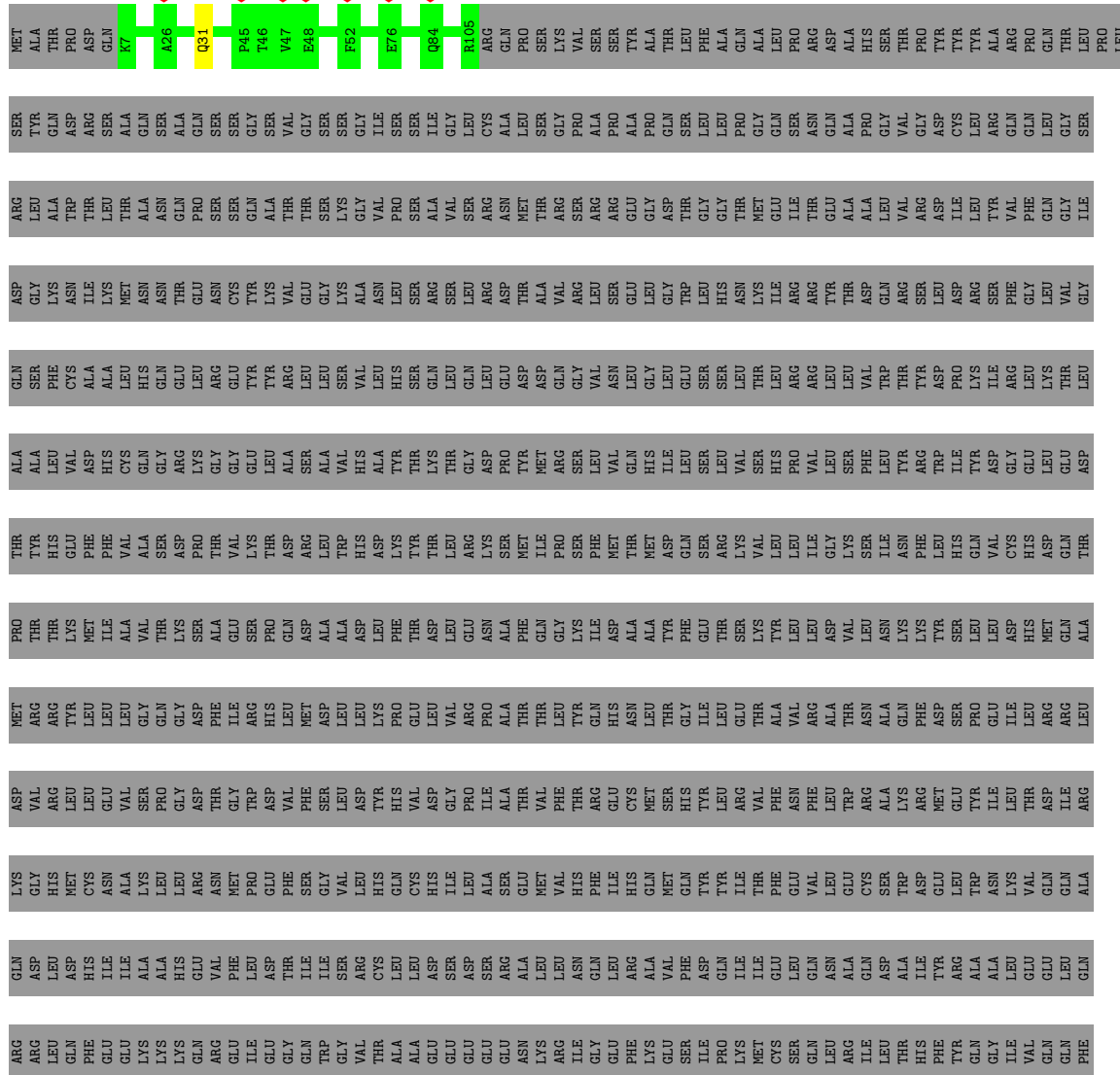

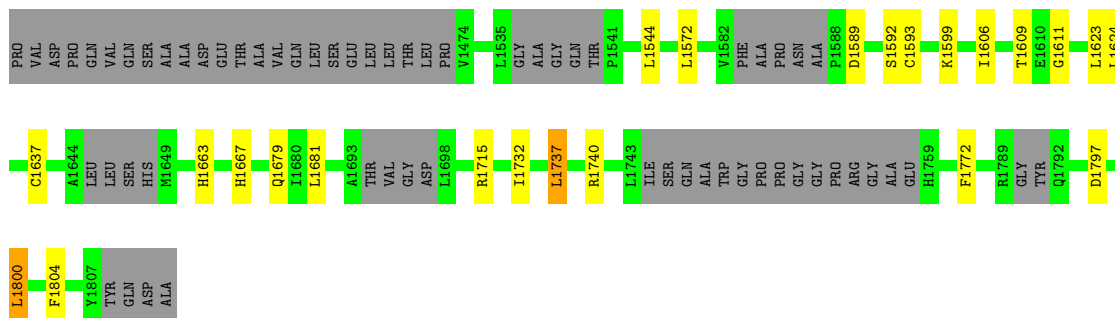

• Molecule 8: Gamma-tubulin complex component 6

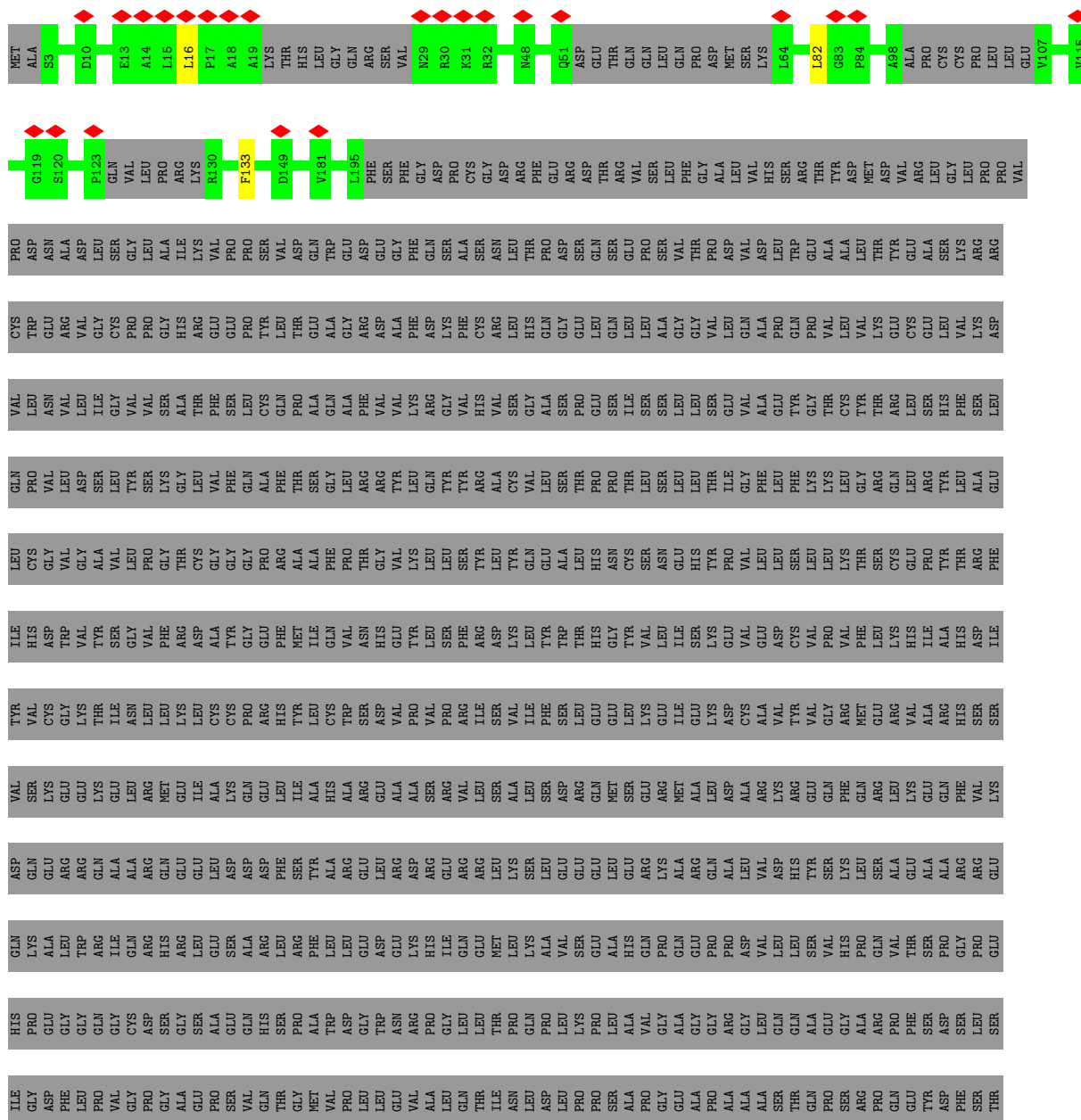

4 Experimental information

Property	Value	Source
EM reconstruction method	SINGLE PARTICLE	Depositor
Imposed symmetry	POINT, Not provided	
Number of particles used	5443	Depositor
Resolution determination method	FSC 0.143 CUT-OFF	Depositor
CTF correction method	PHASE FLIPPING AND AMPLITUDE CORRECTION	Depositor
Microscope	FEI TITAN KRIOS	Depositor
Voltage (kV)	300	Depositor
Electron dose ($e^-/\text{\AA}^2$)	35	Depositor
Minimum defocus (nm)	2000	Depositor
Maximum defocus (nm)	2500	Depositor
Magnification	Not provided	
Image detector	GATAN K3 (6k x 4k)	Depositor
Maximum map value	0.160	Depositor
Minimum map value	-0.013	Depositor
Average map value	0.002	Depositor
Map value standard deviation	0.009	Depositor
Recommended contour level	0.0357	Depositor
Map size (Å)	532.0, 532.0, 532.0	wwPDB
Map dimensions	200, 200, 200	wwPDB
Map angles (°)	90.0, 90.0, 90.0	wwPDB
Pixel spacing (Å)	2.66, 2.66, 2.66	Depositor

5 Model quality [i](#)

5.1 Standard geometry [i](#)

The Z score for a bond length (or angle) is the number of standard deviations the observed value is removed from the expected value. A bond length (or angle) with $|Z| > 5$ is considered an outlier worth inspection. RMSZ is the root-mean-square of all Z scores of the bond lengths (or angles).

Mol	Chain	Bond lengths		Bond angles	
		RMSZ	# Z >5	RMSZ	# Z >5
1	J	0.39	0/4525	0.68	5/6119 (0.1%)
1	l	0.33	0/863	0.63	2/1166 (0.2%)
2	1	0.30	0/3441	0.54	1/4661 (0.0%)
2	2	0.30	0/3441	0.54	1/4661 (0.0%)
2	Q	0.30	0/3441	0.54	1/4661 (0.0%)
2	R	0.30	0/3441	0.54	1/4661 (0.0%)
2	S	0.30	0/3441	0.54	1/4661 (0.0%)
2	T	0.30	0/3441	0.54	1/4661 (0.0%)
2	U	0.30	0/3441	0.54	1/4661 (0.0%)
2	V	0.30	0/3441	0.54	1/4661 (0.0%)
2	W	0.30	0/3441	0.54	1/4661 (0.0%)
2	X	0.30	0/3441	0.54	1/4661 (0.0%)
2	Y	0.30	0/3441	0.54	1/4661 (0.0%)
2	Z	0.30	0/3441	0.54	1/4661 (0.0%)
3	e	0.53	1/2908 (0.0%)	0.76	5/3938 (0.1%)
4	b	0.35	0/484	0.69	0/653
4	d	0.37	0/454	0.68	0/611
4	i	0.30	0/484	0.58	1/653 (0.2%)
4	k	0.31	0/484	0.59	0/653
4	m	0.32	0/484	0.61	0/653
5	D	0.38	0/4897	0.66	4/6610 (0.1%)
5	F	0.37	1/5044 (0.0%)	0.65	4/6809 (0.1%)
5	H	0.35	0/5009	0.59	1/6761 (0.0%)
5	N	0.35	0/5009	0.63	3/6761 (0.0%)
5	a	0.32	0/948	0.60	0/1277
5	h	0.33	0/815	0.57	0/1096
5	j	0.32	0/855	0.60	0/1152
6	C	0.42	3/5151 (0.1%)	0.68	4/6955 (0.1%)
6	E	0.50	8/5311 (0.2%)	0.71	6/7169 (0.1%)
6	G	0.37	0/5295	0.62	1/7147 (0.0%)
6	M	0.41	1/5295 (0.0%)	0.69	3/7147 (0.0%)
7	I	0.44	3/4322 (0.1%)	0.67	7/5853 (0.1%)
7	K	0.39	1/4683 (0.0%)	0.67	5/6338 (0.1%)
8	L	0.38	1/4697 (0.0%)	0.68	7/6348 (0.1%)

Mol	Chain	Bond lengths		Bond angles	
		RMSZ	# Z >5	RMSZ	# Z >5
8	c	0.36	0/1235	0.72	2/1664 (0.1%)
All	All	0.36	19/110544 (0.0%)	0.62	72/149465 (0.0%)

Chiral center outliers are detected by calculating the chiral volume of a chiral center and verifying if the center is modelled as a planar moiety or with the opposite hand. A planarity outlier is detected by checking planarity of atoms in a peptide group, atoms in a mainchain group or atoms of a sidechain that are expected to be planar.

Mol	Chain	#Chirality outliers	#Planarity outliers
1	J	0	2
1	l	0	1
2	1	0	4
2	2	0	4
2	Q	0	4
2	R	0	4
2	S	0	4
2	T	0	4
2	U	0	4
2	V	0	4
2	W	0	4
2	X	0	4
2	Y	0	4
2	Z	0	4
5	D	0	2
5	F	0	2
5	N	0	1
5	j	0	1
6	C	0	2
6	E	0	4
6	G	0	3
6	M	0	4
7	I	0	4
7	K	0	1
8	L	0	1
8	c	0	1
All	All	0	77

All (19) bond length outliers are listed below:

Mol	Chain	Res	Type	Atoms	Z	Observed(Å)	Ideal(Å)
3	e	243	PRO	N-CD	17.57	1.72	1.47
6	E	624	TRP	CB-CG	8.40	1.65	1.50

Continued on next page...

Continued from previous page...

Mol	Chain	Res	Type	Atoms	Z	Observed(Å)	Ideal(Å)
6	E	624	TRP	CE3-CZ3	-8.22	1.24	1.38
6	E	624	TRP	CD1-NE1	-8.03	1.24	1.38
6	E	624	TRP	CG-CD1	7.80	1.47	1.36
7	I	361	TYR	CD2-CE2	-7.53	1.28	1.39
7	I	124	TYR	CD1-CE1	-7.48	1.28	1.39
7	I	530	TYR	CD2-CE2	-7.12	1.28	1.39
6	M	182	TYR	CD1-CE1	-6.92	1.28	1.39
6	E	624	TRP	CZ2-CH2	-6.65	1.24	1.37
8	L	406	CYS	CB-SG	-5.62	1.72	1.81
5	F	575	ARG	CG-CD	5.61	1.66	1.51
6	C	638	TYR	CB-CG	-5.61	1.43	1.51
6	E	624	TRP	CZ3-CH2	-5.44	1.31	1.40
6	E	624	TRP	CE2-CZ2	5.38	1.48	1.39
6	E	415	ARG	CG-CD	5.36	1.65	1.51
7	K	651	TYR	CD1-CE1	5.33	1.47	1.39
6	C	864	PHE	CB-CG	-5.02	1.42	1.51
6	C	638	TYR	CD2-CE2	-5.01	1.31	1.39

All (72) bond angle outliers are listed below:

Mol	Chain	Res	Type	Atoms	Z	Observed(°)	Ideal(°)
6	E	624	TRP	CE3-CZ3-CH2	9.79	131.97	121.20
5	D	692	ARG	NE-CZ-NH2	-9.52	115.54	120.30
8	c	82	LEU	CA-CB-CG	9.46	137.05	115.30
7	I	361	TYR	CB-CG-CD2	-9.07	115.56	121.00
1	J	236	LEU	CA-CB-CG	8.80	135.53	115.30
5	D	368	LEU	CA-CB-CG	8.09	133.92	115.30
5	N	621	LEU	CB-CG-CD1	-7.67	97.96	111.00
8	L	1681	LEU	CB-CG-CD1	-7.66	97.97	111.00
3	e	105	LEU	CB-CG-CD2	-7.37	98.47	111.00
5	F	581	LEU	CA-CB-CG	7.35	132.21	115.30
6	E	624	TRP	CG-CD2-CE3	7.23	140.40	133.90
1	l	121	PRO	N-CA-CB	6.93	111.62	103.30
7	K	651	TYR	CB-CG-CD2	-6.91	116.85	121.00
3	e	105	LEU	CB-CG-CD1	6.88	122.69	111.00
5	F	790	ASP	CB-CG-OD2	6.84	124.45	118.30
8	L	1544	LEU	CA-CB-CG	6.82	130.98	115.30
6	E	624	TRP	CB-CG-CD2	6.81	135.45	126.60
6	E	415	ARG	NE-CZ-NH2	6.75	123.68	120.30
7	I	361	TYR	CB-CG-CD1	6.75	125.05	121.00
8	L	1624	LEU	CA-CB-CG	6.75	130.82	115.30
7	I	361	TYR	CZ-CE2-CD2	6.31	125.48	119.80

Continued on next page...

Continued from previous page...

Mol	Chain	Res	Type	Atoms	Z	Observed(°)	Ideal(°)
2	X	296	ARG	NE-CZ-NH1	-6.29	117.15	120.30
2	1	296	ARG	NE-CZ-NH1	-6.23	117.18	120.30
2	R	296	ARG	NE-CZ-NH1	-6.22	117.19	120.30
2	Z	296	ARG	NE-CZ-NH1	-6.22	117.19	120.30
2	U	296	ARG	NE-CZ-NH1	-6.20	117.20	120.30
2	W	296	ARG	NE-CZ-NH1	-6.20	117.20	120.30
2	2	296	ARG	NE-CZ-NH1	-6.19	117.20	120.30
8	c	16	LEU	CB-CG-CD1	-6.18	100.49	111.00
2	S	296	ARG	NE-CZ-NH1	-6.17	117.22	120.30
2	Q	296	ARG	NE-CZ-NH1	-6.16	117.22	120.30
2	T	296	ARG	NE-CZ-NH1	-6.15	117.22	120.30
1	l	130	PRO	N-CA-CB	6.13	110.66	103.30
2	V	296	ARG	NE-CZ-NH1	-6.11	117.25	120.30
2	Y	296	ARG	NE-CZ-NH1	-6.06	117.27	120.30
5	H	621	LEU	CA-CB-CG	6.04	129.19	115.30
5	N	672	ARG	NE-CZ-NH1	-6.04	117.28	120.30
1	J	235	SER	C-N-CA	6.04	136.79	121.70
1	J	400	ASP	CB-CG-OD2	6.02	123.72	118.30
7	I	475	TYR	CA-CB-CG	5.95	124.70	113.40
5	F	287	LEU	CA-CB-CG	5.92	128.91	115.30
7	K	651	TYR	CA-CB-CG	5.91	124.63	113.40
8	L	287	LEU	CB-CG-CD1	-5.87	101.01	111.00
6	M	182	TYR	CB-CG-CD1	-5.79	117.52	121.00
7	I	498	LEU	CA-CB-CG	5.69	128.38	115.30
6	C	464	GLY	C-N-CA	5.68	135.90	121.70
7	K	12	TYR	CB-CG-CD2	-5.63	117.62	121.00
6	C	522	MET	CG-SD-CE	5.56	109.09	100.20
3	e	134	VAL	CG1-CB-CG2	-5.54	102.04	110.90
8	L	282	LEU	CA-CB-CG	5.50	127.95	115.30
8	L	1800	LEU	CB-CG-CD1	-5.50	101.66	111.00
8	L	1737	LEU	CB-CG-CD1	-5.40	101.81	111.00
7	K	646	LEU	CB-CG-CD2	5.34	120.08	111.00
6	E	299	LEU	CB-CG-CD2	-5.34	101.92	111.00
6	C	315	ARG	NE-CZ-NH1	-5.31	117.64	120.30
6	M	674	GLN	C-N-CA	5.25	134.83	121.70
6	M	156	LEU	CA-CB-CG	5.24	127.35	115.30
6	E	744	LEU	CA-CB-CG	5.19	127.23	115.30
5	N	621	LEU	CB-CG-CD2	5.13	119.72	111.00
5	F	253	ASP	CB-CG-OD2	5.12	122.91	118.30
4	i	18	LEU	CA-CB-CG	5.12	127.08	115.30
5	D	592	LEU	CA-CB-CG	5.12	127.07	115.30
6	C	682	LEU	CB-CG-CD2	-5.10	102.33	111.00

Continued on next page...

Continued from previous page...

Mol	Chain	Res	Type	Atoms	Z	Observed(°)	Ideal(°)
7	I	361	TYR	CD1-CE1-CZ	-5.06	115.25	119.80
1	J	885	LEU	CA-CB-CG	-5.05	103.67	115.30
5	D	366	ARG	NE-CZ-NH1	-5.05	117.78	120.30
1	J	796	LEU	CA-CB-CG	5.05	126.91	115.30
3	e	140	LEU	CA-CB-CG	5.04	126.90	115.30
7	I	404	LEU	CB-CG-CD2	-5.03	102.44	111.00
3	e	311	ASP	CB-CG-OD2	5.02	122.82	118.30
6	G	500	LEU	CA-CB-CG	5.01	126.81	115.30
7	K	583	LEU	CA-CB-CG	5.00	126.80	115.30

There are no chirality outliers.

All (77) planarity outliers are listed below:

Mol	Chain	Res	Type	Group
2	1	347	ASN	Peptide
2	1	406	GLU	Peptide
2	1	55	ALA	Peptide
2	1	86	TYR	Peptide
2	2	347	ASN	Peptide
2	2	406	GLU	Peptide
2	2	55	ALA	Peptide
2	2	86	TYR	Peptide
6	C	238	LEU	Peptide
6	C	464	GLY	Peptide
5	D	481	ARG	Peptide
5	D	501	THR	Peptide
6	E	424	ASN	Peptide
6	E	425	ASP	Peptide
6	E	484	TYR	Peptide
6	E	580	HIS	Peptide
5	F	272	GLU	Peptide
5	F	609	ASN	Peptide
6	G	240	GLY	Peptide
6	G	580	HIS	Peptide
6	G	581	ASP	Mainchain
7	I	407	ASP	Peptide
7	I	600	ASN	Peptide
7	I	601	LEU	Mainchain
7	I	602	GLY	Peptide
1	J	210	PRO	Peptide
1	J	255	PRO	Peptide
7	K	410	LEU	Peptide

Continued on next page...

Continued from previous page...

Mol	Chain	Res	Type	Group
8	L	306	HIS	Peptide
6	M	239	ALA	Peptide
6	M	240	GLY	Peptide
6	M	242	GLN	Peptide
6	M	866	THR	Peptide
5	N	501	THR	Peptide
2	Q	347	ASN	Peptide
2	Q	406	GLU	Peptide
2	Q	55	ALA	Peptide
2	Q	86	TYR	Peptide
2	R	347	ASN	Peptide
2	R	406	GLU	Peptide
2	R	55	ALA	Peptide
2	R	86	TYR	Peptide
2	S	347	ASN	Peptide
2	S	406	GLU	Peptide
2	S	55	ALA	Peptide
2	S	86	TYR	Peptide
2	T	347	ASN	Peptide
2	T	406	GLU	Peptide
2	T	55	ALA	Peptide
2	T	86	TYR	Peptide
2	U	347	ASN	Peptide
2	U	406	GLU	Peptide
2	U	55	ALA	Peptide
2	U	86	TYR	Peptide
2	V	347	ASN	Peptide
2	V	406	GLU	Peptide
2	V	55	ALA	Peptide
2	V	86	TYR	Peptide
2	W	347	ASN	Peptide
2	W	406	GLU	Peptide
2	W	55	ALA	Peptide
2	W	86	TYR	Peptide
2	X	347	ASN	Peptide
2	X	406	GLU	Peptide
2	X	55	ALA	Peptide
2	X	86	TYR	Peptide
2	Y	347	ASN	Peptide
2	Y	406	GLU	Peptide
2	Y	55	ALA	Peptide
2	Y	86	TYR	Peptide

Continued on next page...

Continued from previous page...

Mol	Chain	Res	Type	Group
2	Z	347	ASN	Peptide
2	Z	406	GLU	Peptide
2	Z	55	ALA	Peptide
2	Z	86	TYR	Peptide
8	c	133	PHE	Peptide
5	j	107	GLN	Peptide
1	l	123	ASN	Peptide

5.2 Too-close contacts [\(i\)](#)

In the following table, the Non-H and H(model) columns list the number of non-hydrogen atoms and hydrogen atoms in the chain respectively. The H(added) column lists the number of hydrogen atoms added and optimized by MolProbity. The Clashes column lists the number of clashes within the asymmetric unit, whereas Symm-Clashes lists symmetry-related clashes.

Mol	Chain	Non-H	H(model)	H(added)	Clashes	Symm-Clashes
1	J	4429	0	4482	25	0
1	l	847	0	789	0	0
2	1	3373	0	3325	60	0
2	2	3373	0	3325	54	0
2	Q	3373	0	3325	59	0
2	R	3373	0	3325	56	0
2	S	3373	0	3325	56	0
2	T	3373	0	3325	57	0
2	U	3373	0	3325	56	0
2	V	3373	0	3325	53	0
2	W	3373	0	3325	56	0
2	X	3373	0	3325	55	0
2	Y	3373	0	3325	55	0
2	Z	3373	0	3325	57	0
3	e	2847	0	2810	0	0
4	b	484	0	512	0	0
4	d	454	0	482	0	0
4	i	484	0	512	0	0
4	k	484	0	512	0	0
4	m	484	0	512	0	0
5	D	4796	0	4775	39	0
5	F	4941	0	4935	46	0
5	H	4907	0	4896	24	0
5	N	4907	0	4896	33	0
5	a	933	0	953	0	0
5	h	803	0	831	0	0

Continued on next page...

Continued from previous page...

Mol	Chain	Non-H	H(model)	H(added)	Clashes	Symm-Clashes
5	j	843	0	846	0	0
6	C	5044	0	5081	46	0
6	E	5202	0	5241	57	0
6	G	5186	0	5219	24	0
6	M	5186	0	5219	41	0
7	I	4225	0	4259	32	0
7	K	4579	0	4586	34	0
8	L	4587	0	4636	26	0
8	c	1220	0	1231	0	0
9	l	5	0	0	0	0
9	m	1	0	0	0	0
All	All	108354	0	108115	1019	0

The all-atom clashscore is defined as the number of clashes found per 1000 atoms (including hydrogen atoms). The all-atom clashscore for this structure is 5.

All (1019) close contacts within the same asymmetric unit are listed below, sorted by their clash magnitude.

Atom-1	Atom-2	Interatomic distance (Å)	Clash overlap (Å)
2:T:56:ASP:OD1	2:U:296:ARG:NH1	1.96	0.98
7:I:48:LEU:HD21	7:I:130:GLN:HG2	1.64	0.79
7:K:646:LEU:HG	2:Y:338:GLN:HE22	1.44	0.79
7:I:361:TYR:HE2	7:I:475:TYR:HB3	1.48	0.79
7:I:357:ILE:O	7:I:361:TYR:HB3	1.84	0.77
5:D:692:ARG:HH22	2:R:197:GLN:HA	1.51	0.76
6:M:304:LEU:HB3	5:N:369:VAL:HG12	1.67	0.75
6:C:522:MET:SD	2:Q:248:TYR:OH	2.45	0.73
5:F:616:GLU:HG3	5:F:619:ARG:HH11	1.54	0.73
1:J:684:GLU:H	1:J:687:LEU:HB3	1.56	0.71
2:W:56:ASP:O	2:X:295:ARG:NH1	2.24	0.71
7:K:649:LEU:HB3	2:Y:341:ARG:HH21	1.56	0.70
7:I:361:TYR:CE2	7:I:475:TYR:HB3	2.26	0.70
5:F:553:TYR:HB3	5:F:648:ILE:HD11	1.74	0.69
2:2:136:VAL:HG23	2:2:167:GLN:HB3	1.75	0.69
2:Q:136:VAL:HG23	2:Q:167:GLN:HB3	1.75	0.69
2:W:136:VAL:HG23	2:W:167:GLN:HB3	1.75	0.69
6:C:696:TYR:O	6:C:700:GLU:HB2	1.93	0.69
2:T:136:VAL:HG23	2:T:167:GLN:HB3	1.75	0.69
2:V:136:VAL:HG23	2:V:167:GLN:HB3	1.75	0.69
5:N:563:ARG:HH22	5:N:569:GLY:HA3	1.58	0.69
8:L:527:THR:HA	8:L:530:GLU:HG2	1.75	0.68

Continued on next page...

Continued from previous page...

Atom-1	Atom-2	Interatomic distance (Å)	Clash overlap (Å)
2:R:136:VAL:HG23	2:R:167:GLN:HB3	1.75	0.68
2:W:56:ASP:C	2:X:296:ARG:HH12	1.95	0.68
2:U:136:VAL:HG23	2:U:167:GLN:HB3	1.75	0.68
2:X:136:VAL:HG23	2:X:167:GLN:HB3	1.75	0.68
2:S:136:VAL:HG23	2:S:167:GLN:HB3	1.75	0.68
2:Z:136:VAL:HG23	2:Z:167:GLN:HB3	1.75	0.68
2:1:136:VAL:HG23	2:1:167:GLN:HB3	1.75	0.67
2:Y:136:VAL:HG23	2:Y:167:GLN:HB3	1.75	0.67
5:F:259:GLN:NE2	6:G:322:GLN:OE1	2.28	0.67
2:1:248:TYR:OH	6:M:522:MET:SD	2.51	0.67
5:D:322:GLN:HG2	6:E:333:ARG:HH22	1.61	0.66
2:W:56:ASP:O	2:X:296:ARG:NH1	2.20	0.66
6:E:581:ASP:O	6:E:643:ARG:NH1	2.29	0.65
5:N:601:LEU:HD22	5:N:623:VAL:HG13	1.78	0.65
5:H:307:TYR:HA	5:H:310:GLN:HE21	1.62	0.65
6:M:158:ARG:HH12	6:M:176:ILE:HG21	1.61	0.65
6:C:315:ARG:HH12	5:D:366:ARG:HB3	1.61	0.64
7:K:532:LEU:HD22	7:K:644:GLN:HG2	1.80	0.64
5:D:266:ILE:HG12	5:D:277:VAL:HB	1.79	0.64
6:C:395:ILE:HD11	6:C:450:ILE:HG23	1.81	0.63
7:I:132:LEU:HG	7:I:167:PRO:HB3	1.81	0.63
5:F:878:PHE:HD2	2:T:338:GLN:HE22	1.47	0.63
5:F:620:ARG:HH21	5:F:644:VAL:HA	1.63	0.63
8:L:1663:HIS:CG	2:Z:262:PRO:HA	2.34	0.62
6:C:533:ASP:OD2	2:Q:3:ARG:NH2	2.32	0.62
2:W:3:ARG:N	2:W:131:SER:HG	1.98	0.62
5:F:304:ILE:HD12	5:F:381:LEU:HD13	1.79	0.62
5:F:865:LEU:HD11	5:F:873:LEU:HD22	1.81	0.62
8:L:1797:ASP:HA	8:L:1800:LEU:HD23	1.81	0.62
6:C:644:HIS:HB2	6:C:739:LEU:HD21	1.82	0.62
5:F:736:ASN:HA	5:F:739:GLN:HE21	1.64	0.62
2:X:3:ARG:N	2:X:131:SER:HG	1.98	0.62
2:1:3:ARG:NH1	6:M:529:VAL:O	2.33	0.62
5:F:401:HIS:HD2	5:F:419:LEU:HD21	1.65	0.62
6:G:221:LEU:HD11	6:G:260:VAL:HG22	1.82	0.62
6:C:187:LEU:HD22	5:D:379:LYS:HE3	1.82	0.61
2:S:3:ARG:N	2:S:131:SER:HG	1.98	0.61
7:K:192:LEU:HD11	7:K:307:PHE:HB2	1.81	0.61
2:Y:3:ARG:N	2:Y:131:SER:HG	1.98	0.61
5:D:570:GLN:NE2	2:R:247:GLY:O	2.33	0.61
2:T:3:ARG:N	2:T:131:SER:HG	1.98	0.61

Continued on next page...

Continued from previous page...

Atom-1	Atom-2	Interatomic distance (Å)	Clash overlap (Å)
2:W:292:ASP:O	2:W:296:ARG:HB2	2.01	0.61
5:D:486:ILE:HG23	5:D:541:THR:HG21	1.82	0.61
2:Q:292:ASP:O	2:Q:296:ARG:HB2	2.01	0.61
2:1:292:ASP:O	2:1:296:ARG:HB2	2.01	0.61
8:L:283:TRP:O	8:L:287:LEU:HB2	1.99	0.61
2:2:3:ARG:N	2:2:131:SER:HG	1.98	0.61
2:Y:318:ILE:HB	2:Y:380:ASN:HB3	1.83	0.61
6:M:585:GLN:OE1	6:M:637:ARG:NH2	2.34	0.61
2:Z:318:ILE:HB	2:Z:380:ASN:HB3	1.83	0.61
2:R:3:ARG:N	2:R:131:SER:HG	1.98	0.60
2:R:292:ASP:O	2:R:296:ARG:HB2	2.01	0.60
2:S:292:ASP:O	2:S:296:ARG:HB2	2.01	0.60
2:1:3:ARG:N	2:1:131:SER:HG	1.98	0.60
2:2:292:ASP:O	2:2:296:ARG:HB2	2.01	0.60
8:L:1732:ILE:HG23	8:L:1772:PHE:HE1	1.64	0.60
2:Q:3:ARG:N	2:Q:131:SER:HG	1.98	0.60
2:U:3:ARG:N	2:U:131:SER:HG	1.98	0.60
2:X:292:ASP:O	2:X:296:ARG:HB2	2.01	0.60
2:T:292:ASP:O	2:T:296:ARG:HB2	2.01	0.60
2:V:292:ASP:O	2:V:296:ARG:HB2	2.01	0.60
2:Z:292:ASP:O	2:Z:296:ARG:HB2	2.01	0.60
2:V:3:ARG:N	2:V:131:SER:HG	1.99	0.60
2:W:318:ILE:HB	2:W:380:ASN:HB3	1.83	0.60
2:Y:292:ASP:O	2:Y:296:ARG:HB2	2.01	0.60
2:T:318:ILE:HB	2:T:380:ASN:HB3	1.83	0.60
5:N:477:MET:HG3	5:N:481:ARG:HE	1.65	0.60
2:Z:3:ARG:N	2:Z:131:SER:HG	1.99	0.60
7:K:397:GLN:HE22	7:K:411:LEU:HB3	1.66	0.60
2:U:318:ILE:HB	2:U:380:ASN:HB3	1.83	0.60
2:2:318:ILE:HB	2:2:380:ASN:HB3	1.83	0.60
5:F:304:ILE:HA	5:F:385:VAL:HG11	1.84	0.60
7:I:272:VAL:HG13	7:I:329:VAL:HG11	1.83	0.60
6:M:696:TYR:O	6:M:700:GLU:HB3	2.01	0.60
2:R:318:ILE:HB	2:R:380:ASN:HB3	1.83	0.59
2:U:292:ASP:O	2:U:296:ARG:HB2	2.01	0.59
2:Q:318:ILE:HB	2:Q:380:ASN:HB3	1.83	0.59
2:1:3:ARG:N	2:1:131:SER:OG	2.36	0.59
2:1:318:ILE:HB	2:1:380:ASN:HB3	1.83	0.59
7:I:404:LEU:HD11	2:W:47:ARG:HG3	1.85	0.59
2:S:3:ARG:N	2:S:131:SER:OG	2.36	0.59
2:2:3:ARG:N	2:2:131:SER:OG	2.36	0.59

Continued on next page...

Continued from previous page...

Atom-1	Atom-2	Interatomic distance (Å)	Clash overlap (Å)
2:S:318:ILE:HB	2:S:380:ASN:HB3	1.83	0.59
6:G:577:LEU:HG	6:G:579:PRO:HD3	1.84	0.59
2:T:3:ARG:N	2:T:131:SER:OG	2.36	0.59
2:V:318:ILE:HB	2:V:380:ASN:HB3	1.83	0.59
7:I:404:LEU:HD21	2:W:47:ARG:HA	1.85	0.59
6:M:547:THR:HG22	6:M:549:PRO:HD2	1.84	0.59
2:Y:3:ARG:N	2:Y:131:SER:OG	2.36	0.59
2:V:3:ARG:N	2:V:131:SER:OG	2.36	0.58
2:X:318:ILE:HB	2:X:380:ASN:HB3	1.83	0.58
6:E:556:GLU:HG2	2:T:339:ARG:HE	1.68	0.58
5:F:504:THR:HG21	5:F:537:ALA:HA	1.85	0.58
2:Q:3:ARG:N	2:Q:131:SER:OG	2.36	0.58
2:V:326:GLY:HA2	2:V:363:LYS:HD3	1.85	0.58
2:W:3:ARG:N	2:W:131:SER:OG	2.36	0.58
2:Z:66:LEU:HB3	2:Z:91:ILE:HA	1.85	0.58
6:E:188:ILE:HG22	6:E:244:ARG:HH22	1.67	0.58
6:M:285:TYR:O	6:M:289:ASN:ND2	2.36	0.58
2:R:3:ARG:N	2:R:131:SER:OG	2.36	0.58
2:X:3:ARG:N	2:X:131:SER:OG	2.36	0.58
2:Z:3:ARG:N	2:Z:131:SER:OG	2.36	0.58
2:S:66:LEU:HB3	2:S:91:ILE:HA	1.85	0.58
1:J:255:PRO:HD2	1:J:257:TYR:H	1.68	0.58
2:T:66:LEU:HB3	2:T:91:ILE:HA	1.85	0.58
6:E:174:LEU:HD11	5:F:405:LYS:HD2	1.85	0.58
5:F:270:ASN:HD21	5:F:302:ASN:HD22	1.52	0.58
2:U:3:ARG:N	2:U:131:SER:OG	2.36	0.58
5:F:609:ASN:ND2	2:T:46:ASP:O	2.36	0.58
2:U:66:LEU:HB3	2:U:91:ILE:HA	1.85	0.58
6:E:314:HIS:HB2	6:E:319:LEU:HD23	1.85	0.58
5:F:682:LYS:HB2	2:T:254:ILE:HD11	1.85	0.58
8:L:438:ARG:NH1	8:L:441:GLN:OE1	2.37	0.58
2:R:326:GLY:HA2	2:R:363:LYS:HD3	1.85	0.58
2:W:66:LEU:HB3	2:W:91:ILE:HA	1.85	0.58
2:1:353:PRO:HG2	6:M:685:ARG:HG2	1.85	0.57
2:U:326:GLY:HA2	2:U:363:LYS:HD3	1.85	0.57
2:X:326:GLY:HA2	2:X:363:LYS:HD3	1.85	0.57
2:2:66:LEU:HB3	2:2:91:ILE:HA	1.85	0.57
6:C:614:GLU:HA	6:C:643:ARG:HH12	1.69	0.57
6:M:478:THR:OG1	6:M:481:GLU:O	2.22	0.57
2:Q:66:LEU:HB3	2:Q:91:ILE:HA	1.85	0.57
2:V:66:LEU:HB3	2:V:91:ILE:HA	1.85	0.57

Continued on next page...

Continued from previous page...

Atom-1	Atom-2	Interatomic distance (Å)	Clash overlap (Å)
2:Y:66:LEU:HB3	2:Y:91:ILE:HA	1.85	0.57
2:S:326:GLY:HA2	2:S:363:LYS:HD3	1.85	0.57
2:Y:326:GLY:HA2	2:Y:363:LYS:HD3	1.85	0.57
5:H:308:THR:O	5:H:312:SER:OG	2.21	0.57
2:T:326:GLY:HA2	2:T:363:LYS:HD3	1.85	0.57
2:X:66:LEU:HB3	2:X:91:ILE:HA	1.85	0.57
2:2:326:GLY:HA2	2:2:363:LYS:HD3	1.85	0.57
2:Q:326:GLY:HA2	2:Q:363:LYS:HD3	1.85	0.57
7:I:92:GLY:HA3	7:I:175:ILE:HG12	1.86	0.57
7:K:48:LEU:HD21	7:K:130:GLN:HA	1.87	0.57
5:F:555:LEU:HD13	5:F:651:VAL:HG21	1.87	0.57
5:H:883:ASN:HD21	2:V:350:PRO:HA	1.68	0.57
8:L:324:CYS:HA	8:L:327:HIS:CE1	2.40	0.57
2:W:326:GLY:HA2	2:W:363:LYS:HD3	1.85	0.57
2:Z:326:GLY:HA2	2:Z:363:LYS:HD3	1.85	0.56
2:1:66:LEU:HB3	2:1:91:ILE:HA	1.85	0.56
2:R:66:LEU:HB3	2:R:91:ILE:HA	1.85	0.56
2:1:233:SER:O	2:1:237:SER:OG	2.24	0.56
2:1:326:GLY:HA2	2:1:363:LYS:HD3	1.85	0.56
6:G:395:ILE:HD11	6:G:450:ILE:HG23	1.88	0.56
2:V:303:VAL:HG12	2:V:305:VAL:H	1.71	0.56
2:2:303:VAL:HG12	2:2:305:VAL:H	1.71	0.56
8:L:1589:ASP:H	8:L:1737:LEU:HD13	1.69	0.56
5:F:432:ARG:HH12	5:F:440:GLU:H	1.52	0.56
2:R:233:SER:O	2:R:237:SER:OG	2.24	0.56
2:S:233:SER:O	2:S:237:SER:OG	2.24	0.56
2:Y:233:SER:O	2:Y:237:SER:OG	2.24	0.56
2:2:233:SER:O	2:2:237:SER:OG	2.24	0.56
2:U:303:VAL:HG12	2:U:305:VAL:H	1.71	0.56
2:1:303:VAL:HG12	2:1:305:VAL:H	1.71	0.56
6:C:738:MET:HG3	6:C:745:LEU:HD13	1.88	0.56
5:F:464:TYR:HB3	5:F:484:LEU:HD11	1.88	0.56
6:E:439:ILE:HG22	6:E:441:SER:H	1.71	0.56
2:S:303:VAL:HG12	2:S:305:VAL:H	1.71	0.56
6:E:277:ILE:HD11	6:E:296:MET:HG3	1.87	0.55
2:R:303:VAL:HG12	2:R:305:VAL:H	1.71	0.55
2:X:303:VAL:HG12	2:X:305:VAL:H	1.71	0.55
2:Z:52:PHE:HA	2:Z:62:PRO:HA	1.88	0.55
6:M:696:TYR:O	6:M:700:GLU:CB	2.55	0.55
2:S:52:PHE:HA	2:S:62:PRO:HA	1.89	0.55
2:U:233:SER:O	2:U:237:SER:OG	2.24	0.55

Continued on next page...

Continued from previous page...

Atom-1	Atom-2	Interatomic distance (Å)	Clash overlap (Å)
2:X:52:PHE:HA	2:X:62:PRO:HA	1.89	0.55
2:Z:233:SER:O	2:Z:237:SER:OG	2.24	0.55
8:L:1592:SER:OG	8:L:1593:CYS:N	2.38	0.55
2:T:303:VAL:HG12	2:T:305:VAL:H	1.71	0.55
2:U:52:PHE:HA	2:U:62:PRO:HA	1.89	0.55
2:Z:303:VAL:HG12	2:Z:305:VAL:H	1.71	0.55
5:D:550:ASN:HD21	5:D:556:LEU:HD22	1.72	0.55
2:R:52:PHE:HA	2:R:62:PRO:HA	1.88	0.55
2:T:52:PHE:HA	2:T:62:PRO:HA	1.89	0.55
2:V:52:PHE:HA	2:V:62:PRO:HA	1.88	0.55
2:2:446:TRP:HB3	5:N:702:HIS:CG	2.42	0.55
5:D:254:ILE:HG13	5:D:366:ARG:HH22	1.72	0.55
5:D:666:PHE:HA	5:D:669:ARG:HE	1.72	0.55
2:W:52:PHE:HA	2:W:62:PRO:HA	1.88	0.55
5:F:378:LEU:HD13	5:F:381:LEU:HD11	1.88	0.55
1:J:881:HIS:CE1	2:X:446:TRP:HD1	2.25	0.55
2:Q:233:SER:O	2:Q:237:SER:OG	2.24	0.55
2:V:233:SER:O	2:V:237:SER:OG	2.24	0.55
8:L:1800:LEU:HD11	2:Z:337:LEU:HG	1.90	0.54
2:W:233:SER:O	2:W:237:SER:OG	2.24	0.54
2:X:233:SER:O	2:X:237:SER:OG	2.24	0.54
6:C:520:PHE:HB3	6:C:642:PHE:HB2	1.89	0.54
6:M:682:LEU:HD13	6:M:685:ARG:HH11	1.72	0.54
2:Q:52:PHE:HA	2:Q:62:PRO:HA	1.88	0.54
2:Q:303:VAL:HG12	2:Q:305:VAL:H	1.71	0.54
2:T:233:SER:O	2:T:237:SER:OG	2.24	0.54
2:1:259:SER:HB3	6:M:691:GLN:HE22	1.72	0.54
5:D:427:LEU:HA	5:D:430:LEU:HD12	1.89	0.54
5:D:601:LEU:HD21	5:D:621:LEU:HD21	1.90	0.54
6:G:271:SER:OG	6:G:275:ARG:NH2	2.41	0.54
2:1:52:PHE:HA	2:1:62:PRO:HA	1.89	0.54
2:2:355:SER:HB2	5:N:713:HIS:NE2	2.23	0.54
5:N:266:ILE:HG12	5:N:277:VAL:HG22	1.89	0.54
2:Q:57:ASP:OD2	2:R:276:LEU:HB3	2.08	0.54
2:Y:303:VAL:HG12	2:Y:305:VAL:H	1.71	0.54
2:2:52:PHE:HA	2:2:62:PRO:HA	1.89	0.54
7:K:534:VAL:HG21	2:Y:248:TYR:HE2	1.71	0.54
2:Y:52:PHE:HA	2:Y:62:PRO:HA	1.88	0.54
6:C:445:LYS:HD3	6:C:482:ARG:HH12	1.73	0.54
7:I:188:SER:O	7:I:192:LEU:HB2	2.08	0.54
5:F:419:LEU:HA	5:F:422:VAL:HG22	1.90	0.54

Continued on next page...

Continued from previous page...

Atom-1	Atom-2	Interatomic distance (Å)	Clash overlap (Å)
2:1:222:ASN:OD1	2:1:222:ASN:N	2.41	0.54
6:C:834:LEU:HD13	6:C:868:ARG:HH11	1.73	0.54
5:H:608:THR:HG23	5:H:610:ALA:H	1.72	0.54
2:W:303:VAL:HG12	2:W:305:VAL:H	1.71	0.54
2:Y:222:ASN:N	2:Y:222:ASN:OD1	2.41	0.54
7:K:618:GLY:O	7:K:622:GLN:NE2	2.41	0.54
2:U:222:ASN:OD1	2:U:222:ASN:N	2.41	0.53
2:W:241:THR:HB	2:W:325:GLN:HE22	1.74	0.53
2:Z:222:ASN:OD1	2:Z:222:ASN:N	2.41	0.53
5:N:636:ASP:OD1	5:N:672:ARG:NH1	2.42	0.53
2:U:241:THR:HB	2:U:325:GLN:HE22	1.74	0.53
2:W:66:LEU:HD22	2:W:91:ILE:HG23	1.91	0.53
2:X:237:SER:O	2:X:241:THR:OG1	2.25	0.53
2:1:241:THR:HB	2:1:325:GLN:HE22	1.73	0.53
5:D:885:HIS:CG	2:R:353:PRO:HA	2.43	0.53
6:E:214:GLU:OE2	6:E:320:SER:OG	2.26	0.53
5:H:664:PHE:O	5:H:668:TRP:HB2	2.09	0.53
2:Q:241:THR:HB	2:Q:325:GLN:HE22	1.73	0.53
2:T:241:THR:HB	2:T:325:GLN:HE22	1.73	0.53
2:X:66:LEU:HD22	2:X:91:ILE:HG23	1.91	0.53
2:1:66:LEU:HD22	2:1:91:ILE:HG23	1.91	0.53
2:2:241:THR:HB	2:2:325:GLN:HE22	1.73	0.53
2:S:66:LEU:HD22	2:S:91:ILE:HG23	1.91	0.53
2:S:241:THR:HB	2:S:325:GLN:HE22	1.73	0.53
2:X:222:ASN:OD1	2:X:222:ASN:N	2.41	0.53
2:Z:241:THR:HB	2:Z:325:GLN:HE22	1.73	0.53
2:2:66:LEU:HD22	2:2:91:ILE:HG23	1.91	0.53
5:F:653:THR:HG1	5:F:656:CYS:HG	1.56	0.53
2:V:222:ASN:OD1	2:V:222:ASN:N	2.41	0.53
7:I:5:LEU:HD11	7:I:122:VAL:HG21	1.90	0.53
2:Q:222:ASN:OD1	2:Q:222:ASN:N	2.41	0.53
2:T:66:LEU:HD22	2:T:91:ILE:HG23	1.91	0.53
2:Y:241:THR:HB	2:Y:325:GLN:HE22	1.73	0.53
2:Z:184:GLN:O	2:Z:188:SER:OG	2.27	0.53
2:2:222:ASN:N	2:2:222:ASN:OD1	2.41	0.53
2:R:66:LEU:HD22	2:R:91:ILE:HG23	1.91	0.53
2:U:66:LEU:HD22	2:U:91:ILE:HG23	1.91	0.53
2:W:222:ASN:N	2:W:222:ASN:OD1	2.41	0.53
6:C:757:MET:HA	6:C:761:CYS:HB3	1.91	0.53
2:Q:184:GLN:O	2:Q:188:SER:OG	2.27	0.53
2:X:241:THR:HB	2:X:325:GLN:HE22	1.74	0.53

Continued on next page...

Continued from previous page...

Atom-1	Atom-2	Interatomic distance (Å)	Clash overlap (Å)
5:H:554:SER:O	5:H:558:HIS:ND1	2.33	0.53
2:R:222:ASN:N	2:R:222:ASN:OD1	2.41	0.53
2:U:184:GLN:O	2:U:188:SER:OG	2.27	0.53
2:Y:37:VAL:HG12	2:Y:59:HIS:HD2	1.74	0.53
2:Y:66:LEU:HD22	2:Y:91:ILE:HG23	1.91	0.53
2:2:184:GLN:O	2:2:188:SER:OG	2.27	0.52
6:E:559:LEU:HD21	6:E:570:LYS:HD2	1.91	0.52
1:J:889:LYS:HA	2:X:353:PRO:HG2	1.91	0.52
8:L:568:TYR:HB3	8:L:1606:ILE:HD13	1.91	0.52
2:S:37:VAL:HG12	2:S:59:HIS:HD2	1.74	0.52
7:K:143:ILE:HA	7:K:148:ILE:HD12	1.91	0.52
6:M:737:CYS:SG	6:M:738:MET:N	2.81	0.52
2:V:184:GLN:O	2:V:188:SER:OG	2.27	0.52
2:Y:361:SER:OG	2:Y:362:ARG:N	2.43	0.52
2:2:37:VAL:HG12	2:2:59:HIS:HD2	1.74	0.52
5:D:261:ILE:HG21	6:E:255:SER:HB3	1.92	0.52
6:E:387:TYR:HE2	6:E:407:PHE:HD1	1.56	0.52
7:K:66:VAL:HG13	7:K:68:GLN:H	1.74	0.52
5:D:286:SER:OG	5:D:287:LEU:N	2.39	0.52
2:S:361:SER:OG	2:S:362:ARG:N	2.43	0.52
2:T:361:SER:OG	2:T:362:ARG:N	2.43	0.52
6:E:585:GLN:HE21	6:E:744:LEU:HD21	1.74	0.52
2:Q:37:VAL:HG12	2:Q:59:HIS:HD2	1.74	0.52
2:V:37:VAL:HG12	2:V:59:HIS:HD2	1.74	0.52
2:1:184:GLN:O	2:1:188:SER:OG	2.27	0.52
5:H:419:LEU:HA	5:H:422:VAL:HG22	1.92	0.52
7:I:408:ASP:HB2	7:I:410:LEU:H	1.74	0.52
2:1:37:VAL:HG12	2:1:59:HIS:HD2	1.74	0.52
6:E:448:ASP:N	6:E:448:ASP:OD2	2.43	0.52
5:F:619:ARG:HH12	5:F:620:ARG:HH11	1.57	0.52
2:T:222:ASN:N	2:T:222:ASN:OD1	2.41	0.52
2:X:37:VAL:HG12	2:X:59:HIS:HD2	1.74	0.52
2:1:353:PRO:HG3	6:M:865:TYR:CD2	2.45	0.52
6:C:180:TRP:HA	6:C:183:GLU:HB2	1.92	0.52
2:R:184:GLN:O	2:R:188:SER:OG	2.27	0.52
2:R:241:THR:HB	2:R:325:GLN:HE22	1.74	0.52
2:W:361:SER:OG	2:W:362:ARG:N	2.43	0.52
2:2:361:SER:OG	2:2:362:ARG:N	2.43	0.52
7:K:199:GLN:NE2	8:L:510:LEU:O	2.43	0.52
2:S:222:ASN:OD1	2:S:222:ASN:N	2.41	0.52
2:U:37:VAL:HG12	2:U:59:HIS:HD2	1.74	0.52

Continued on next page...

Continued from previous page...

Atom-1	Atom-2	Interatomic distance (Å)	Clash overlap (Å)
2:X:361:SER:OG	2:X:362:ARG:N	2.43	0.52
2:Y:184:GLN:O	2:Y:188:SER:OG	2.27	0.52
2:2:290:VAL:HG23	2:2:336:SER:HB2	1.92	0.52
2:R:37:VAL:HG12	2:R:59:HIS:HD2	1.74	0.52
2:V:66:LEU:HD22	2:V:91:ILE:HG23	1.91	0.52
2:Y:290:VAL:HG23	2:Y:336:SER:HB2	1.92	0.52
2:Z:66:LEU:HD22	2:Z:91:ILE:HG23	1.91	0.52
2:Q:66:LEU:HD22	2:Q:91:ILE:HG23	1.91	0.51
2:S:290:VAL:HG23	2:S:336:SER:HB2	1.92	0.51
2:U:361:SER:OG	2:U:362:ARG:N	2.43	0.51
7:K:192:LEU:HD22	7:K:304:GLU:HG2	1.92	0.51
2:R:290:VAL:HG23	2:R:336:SER:HB2	1.92	0.51
2:V:241:THR:HB	2:V:325:GLN:HE22	1.74	0.51
2:W:184:GLN:O	2:W:188:SER:OG	2.27	0.51
6:G:428:TRP:CD1	6:G:628:LEU:HB3	2.46	0.51
2:U:290:VAL:HG23	2:U:336:SER:HB2	1.92	0.51
2:X:184:GLN:O	2:X:188:SER:OG	2.27	0.51
5:F:433:TRP:HZ2	5:F:484:LEU:HD12	1.75	0.51
7:I:37:SER:O	7:I:40:SER:OG	2.29	0.51
7:K:353:GLN:HG3	7:K:463:LEU:HD13	1.93	0.51
2:T:37:VAL:HG12	2:T:59:HIS:HD2	1.74	0.51
2:W:53:TYR:HB2	2:W:63:ARG:HG2	1.93	0.51
6:C:763:GLN:HG3	6:C:766:THR:H	1.75	0.51
2:T:53:TYR:HB2	2:T:63:ARG:HG2	1.93	0.51
2:V:361:SER:OG	2:V:362:ARG:N	2.43	0.51
2:X:290:VAL:HG23	2:X:336:SER:HB2	1.92	0.51
2:Z:290:VAL:HG23	2:Z:336:SER:HB2	1.92	0.51
8:L:1609:THR:HG22	8:L:1611:GLY:H	1.76	0.51
2:Y:53:TYR:HB2	2:Y:63:ARG:HG2	1.93	0.51
2:Z:361:SER:OG	2:Z:362:ARG:N	2.43	0.51
2:1:361:SER:OG	2:1:362:ARG:N	2.43	0.51
2:2:53:TYR:HB2	2:2:63:ARG:HG2	1.93	0.51
5:D:726:VAL:HG13	5:D:761:ARG:HB2	1.93	0.51
2:Q:361:SER:OG	2:Q:362:ARG:N	2.43	0.51
2:R:53:TYR:HB2	2:R:63:ARG:HG2	1.93	0.51
2:W:37:VAL:HG12	2:W:59:HIS:HD2	1.74	0.51
2:Z:37:VAL:HG12	2:Z:59:HIS:HD2	1.74	0.51
2:T:184:GLN:O	2:T:188:SER:OG	2.27	0.51
2:Z:53:TYR:HB2	2:Z:63:ARG:HG2	1.93	0.51
2:1:53:TYR:HB2	2:1:63:ARG:HG2	1.93	0.51
2:1:290:VAL:HG23	2:1:336:SER:HB2	1.92	0.51

Continued on next page...

Continued from previous page...

Atom-1	Atom-2	Interatomic distance (Å)	Clash overlap (Å)
6:C:439:ILE:HD12	6:C:444:GLN:HE22	1.76	0.51
5:F:449:ALA:HB2	5:F:467:ARG:HB2	1.92	0.51
2:T:237:SER:O	2:T:241:THR:OG1	2.25	0.51
2:U:53:TYR:HB2	2:U:63:ARG:HG2	1.93	0.51
5:H:631:GLY:HA3	5:H:637:VAL:HG23	1.93	0.50
1:J:316:GLN:NE2	1:J:320:TYR:OH	2.31	0.50
1:J:899:ASN:O	1:J:903:THR:OG1	2.28	0.50
7:K:176:LEU:HG	7:K:180:HIS:CE1	2.46	0.50
2:S:184:GLN:O	2:S:188:SER:OG	2.27	0.50
2:X:35:GLY:HA2	2:X:85:LEU:HD12	1.94	0.50
7:I:345:VAL:HG23	7:I:346:GLU:HG3	1.92	0.50
2:Q:290:VAL:HG23	2:Q:336:SER:HB2	1.92	0.50
2:Y:35:GLY:HA2	2:Y:85:LEU:HD12	1.94	0.50
6:C:266:VAL:HG21	6:C:328:ILE:HD12	1.93	0.50
2:V:290:VAL:HG23	2:V:336:SER:HB2	1.92	0.50
2:Q:53:TYR:HB2	2:Q:63:ARG:HG2	1.93	0.50
2:V:53:TYR:HB2	2:V:63:ARG:HG2	1.93	0.50
2:R:361:SER:OG	2:R:362:ARG:N	2.43	0.50
2:W:35:GLY:HA2	2:W:85:LEU:HD12	1.93	0.50
2:T:35:GLY:HA2	2:T:85:LEU:HD12	1.94	0.50
2:T:290:VAL:HG23	2:T:336:SER:HB2	1.92	0.50
2:V:35:GLY:HA2	2:V:85:LEU:HD12	1.93	0.50
6:E:695:TYR:HE1	2:S:249:MET:HG3	1.76	0.49
7:I:397:GLN:HB3	7:I:409:ASN:HD22	1.75	0.49
6:M:377:LEU:O	6:M:380:THR:OG1	2.31	0.49
5:N:608:THR:HG23	5:N:610:ALA:H	1.77	0.49
2:S:53:TYR:HB2	2:S:63:ARG:HG2	1.93	0.49
2:U:35:GLY:HA2	2:U:85:LEU:HD12	1.94	0.49
2:W:290:VAL:HG23	2:W:336:SER:HB2	1.92	0.49
5:D:613:ASP:HB2	5:D:617:ILE:HD11	1.93	0.49
1:J:220:VAL:HG13	8:L:311:TYR:HA	1.94	0.49
2:Z:35:GLY:HA2	2:Z:85:LEU:HD12	1.94	0.49
2:2:35:GLY:HA2	2:2:85:LEU:HD12	1.94	0.49
2:S:124:ARG:HG3	2:T:301:LYS:NZ	2.27	0.49
2:X:53:TYR:HB2	2:X:63:ARG:HG2	1.93	0.49
6:C:563:THR:HG21	2:Q:246:PRO:HG3	1.94	0.49
6:E:280:LYS:HD2	6:E:289:ASN:HD21	1.76	0.49
2:1:35:GLY:HA2	2:1:85:LEU:HD12	1.94	0.49
5:F:259:GLN:HG2	5:F:336:TYR:HE1	1.76	0.49
5:F:279:GLY:HA3	5:F:287:LEU:HD11	1.94	0.49
5:N:564:ARG:HB3	5:N:570:GLN:HB2	1.94	0.49

Continued on next page...

Continued from previous page...

Atom-1	Atom-2	Interatomic distance (Å)	Clash overlap (Å)
2:Q:35:GLY:HA2	2:Q:85:LEU:HD12	1.94	0.49
2:1:237:SER:O	2:1:241:THR:OG1	2.25	0.49
5:D:333:ARG:HG3	6:E:329:GLN:HG3	1.95	0.49
6:E:432:TYR:OH	6:E:458:ASN:ND2	2.36	0.49
5:H:884:GLU:OE2	2:V:344:LYS:NZ	2.45	0.49
5:N:270:ASN:HD22	5:N:273:ASN:HB2	1.78	0.49
5:F:710:GLU:HG2	2:T:353:PRO:HG2	1.94	0.49
7:K:192:LEU:HD21	7:K:307:PHE:HD2	1.77	0.49
7:K:540:GLN:HE21	7:K:564:PHE:HA	1.78	0.49
2:R:35:GLY:HA2	2:R:85:LEU:HD12	1.94	0.49
2:2:248:TYR:HD2	5:N:723:THR:HG23	1.78	0.49
5:D:720:TYR:HE1	2:R:249:MET:HG3	1.78	0.49
7:K:176:LEU:O	7:K:180:HIS:ND1	2.45	0.49
6:M:277:ILE:HD11	6:M:296:MET:HB3	1.95	0.49
2:T:262:PRO:HG3	2:T:318:ILE:HG21	1.95	0.49
6:E:837:LEU:HD22	6:E:856:ILE:HG12	1.94	0.49
5:F:432:ARG:NH1	5:F:440:GLU:OE1	2.45	0.49
7:I:282:SER:HB3	7:I:340:LEU:HD11	1.95	0.49
6:M:834:LEU:HD11	6:M:868:ARG:HB2	1.94	0.49
2:X:262:PRO:HG3	2:X:318:ILE:HG21	1.95	0.49
2:Z:262:PRO:HG3	2:Z:318:ILE:HG21	1.95	0.49
2:Q:387:LEU:HA	2:Q:390:ARG:HD3	1.95	0.49
2:W:387:LEU:HA	2:W:390:ARG:HD3	1.95	0.49
7:I:508:ASN:C	7:I:510:THR:H	2.17	0.48
6:C:221:LEU:HD11	6:C:260:VAL:HG22	1.95	0.48
6:G:526:ASP:HA	6:G:529:VAL:HG12	1.95	0.48
2:U:262:PRO:HG3	2:U:318:ILE:HG21	1.95	0.48
2:W:262:PRO:HG3	2:W:318:ILE:HG21	1.95	0.48
5:F:554:SER:O	5:F:554:SER:OG	2.31	0.48
6:G:578:MET:HG3	6:G:643:ARG:HD3	1.94	0.48
5:H:627:GLU:HB2	5:H:630:PRO:HG2	1.94	0.48
2:S:35:GLY:HA2	2:S:85:LEU:HD12	1.94	0.48
2:Y:387:LEU:HA	2:Y:390:ARG:HD3	1.95	0.48
2:1:56:ASP:HB3	2:2:276:LEU:HD22	1.94	0.48
5:F:317:PHE:HB3	5:F:322:GLN:HE21	1.77	0.48
1:J:398:VAL:HA	1:J:401:LYS:HE2	1.94	0.48
2:Q:262:PRO:HG3	2:Q:318:ILE:HG21	1.95	0.48
2:V:262:PRO:HG3	2:V:318:ILE:HG21	1.95	0.48
2:Z:387:LEU:HA	2:Z:390:ARG:HD3	1.95	0.48
2:2:237:SER:O	2:2:241:THR:OG1	2.25	0.48
6:G:566:THR:HG22	2:U:45:THR:HG21	1.95	0.48

Continued on next page...

Continued from previous page...

Atom-1	Atom-2	Interatomic distance (Å)	Clash overlap (Å)
5:H:554:SER:O	5:H:554:SER:OG	2.30	0.48
6:M:175:PRO:HG3	5:N:402:ALA:HB1	1.94	0.48
2:X:387:LEU:HA	2:X:390:ARG:HD3	1.95	0.48
2:Y:262:PRO:HG3	2:Y:318:ILE:HG21	1.95	0.48
6:G:305:ILE:HG22	6:G:309:GLN:HE21	1.78	0.48
8:L:1572:LEU:HD22	8:L:1599:LYS:H	1.79	0.48
2:S:347:ASN:OD1	2:S:347:ASN:N	2.47	0.48
2:T:347:ASN:OD1	2:T:347:ASN:N	2.47	0.48
2:U:387:LEU:HA	2:U:390:ARG:HD3	1.95	0.48
5:H:887:LYS:HA	5:H:890:GLU:HB2	1.96	0.48
2:V:407:GLN:NE2	2:V:408:PHE:O	2.47	0.48
6:C:175:PRO:HB3	5:D:402:ALA:HB1	1.95	0.48
6:C:187:LEU:HA	5:D:379:LYS:HE2	1.96	0.48
5:D:406:THR:HG23	5:D:412:ARG:HG2	1.96	0.48
2:R:237:SER:O	2:R:241:THR:OG1	2.25	0.48
2:1:387:LEU:HA	2:1:390:ARG:HD3	1.95	0.48
2:Z:237:SER:O	2:Z:241:THR:OG1	2.25	0.48
6:C:302:GLU:HA	6:C:305:ILE:HD12	1.96	0.47
5:F:568:LEU:HD22	5:F:667:LEU:HG	1.95	0.47
8:L:1667:HIS:CE1	2:Z:355:SER:H	2.32	0.47
2:U:347:ASN:OD1	2:U:347:ASN:N	2.47	0.47
2:1:262:PRO:HG3	2:1:318:ILE:HG21	1.95	0.47
2:2:407:GLN:NE2	2:2:408:PHE:O	2.47	0.47
7:K:283:VAL:O	7:K:287:GLU:HB2	2.14	0.47
2:1:237:SER:O	2:1:244:ARG:NH2	2.48	0.47
6:C:862:ASN:HB2	6:C:864:PHE:CZ	2.49	0.47
2:Z:237:SER:O	2:Z:244:ARG:NH2	2.48	0.47
2:1:407:GLN:NE2	2:1:408:PHE:O	2.47	0.47
2:2:387:LEU:HA	2:2:390:ARG:HD3	1.95	0.47
6:G:446:MET:SD	6:G:446:MET:N	2.87	0.47
2:V:237:SER:O	2:V:244:ARG:NH2	2.48	0.47
2:W:407:GLN:NE2	2:W:408:PHE:O	2.47	0.47
2:2:262:PRO:HG3	2:2:318:ILE:HG21	1.95	0.47
5:D:587:ARG:HH12	5:D:592:LEU:HB2	1.79	0.47
6:M:533:ASP:OD2	6:M:653:ARG:NH2	2.48	0.47
5:N:333:ARG:HE	5:N:337:ARG:HH11	1.62	0.47
2:Q:237:SER:O	2:Q:244:ARG:NH2	2.48	0.47
2:V:387:LEU:HA	2:V:390:ARG:HD3	1.95	0.47
2:Y:407:GLN:NE2	2:Y:408:PHE:O	2.47	0.47
2:Z:347:ASN:OD1	2:Z:347:ASN:N	2.47	0.47
6:C:559:LEU:HD21	6:C:570:LYS:HB2	1.97	0.47

Continued on next page...

Continued from previous page...

Atom-1	Atom-2	Interatomic distance (Å)	Clash overlap (Å)
6:C:644:HIS:HE1	6:C:738:MET:HB2	1.79	0.47
6:E:416:LYS:H	6:E:419:ILE:HB	1.80	0.47
2:T:387:LEU:HA	2:T:390:ARG:HD3	1.95	0.47
2:T:407:GLN:NE2	2:T:408:PHE:O	2.47	0.47
2:2:68:ASP:OD2	2:2:68:ASP:N	2.48	0.47
6:C:482:ARG:HD2	6:C:485:VAL:HG21	1.97	0.47
6:E:517:LYS:HZ2	6:E:706:TRP:HE1	1.62	0.47
5:F:302:ASN:O	5:F:306:ARG:HB2	2.15	0.47
6:G:238:LEU:HD11	6:G:241:ARG:HH21	1.79	0.47
6:M:223:TYR:OH	5:N:366:ARG:NH2	2.47	0.47
6:M:713:LEU:HD22	6:M:722:VAL:HG13	1.96	0.47
2:R:68:ASP:OD2	2:R:68:ASP:N	2.48	0.47
2:S:262:PRO:HG3	2:S:318:ILE:HG21	1.95	0.47
2:S:387:LEU:HA	2:S:390:ARG:HD3	1.95	0.47
2:U:237:SER:O	2:U:241:THR:OG1	2.25	0.47
2:U:407:GLN:NE2	2:U:408:PHE:O	2.47	0.47
2:2:347:ASN:OD1	2:2:347:ASN:N	2.47	0.47
2:R:387:LEU:HA	2:R:390:ARG:HD3	1.95	0.47
6:E:442:PHE:CE1	6:E:484:TYR:HE1	2.33	0.47
2:Y:384:ILE:HD12	2:Y:387:LEU:HD12	1.97	0.47
6:C:857:SER:O	2:Q:341:ARG:NE	2.48	0.47
2:R:237:SER:O	2:R:244:ARG:NH2	2.48	0.47
2:W:68:ASP:OD2	2:W:68:ASP:N	2.48	0.47
2:Z:407:GLN:NE2	2:Z:408:PHE:O	2.47	0.47
2:1:384:ILE:HD12	2:1:387:LEU:HD12	1.97	0.46
2:2:89:GLU:O	2:2:124:ARG:NH2	2.48	0.46
6:C:234:SER:HG	5:D:286:SER:N	2.13	0.46
5:N:361:SER:OG	5:N:362:LEU:N	2.48	0.46
2:R:407:GLN:NE2	2:R:408:PHE:O	2.47	0.46
2:S:89:GLU:O	2:S:124:ARG:NH2	2.48	0.46
2:X:68:ASP:OD2	2:X:68:ASP:N	2.48	0.46
2:Y:89:GLU:O	2:Y:124:ARG:NH2	2.49	0.46
2:2:274:THR:HG21	2:2:293:VAL:HG12	1.97	0.46
6:M:559:LEU:HD11	6:M:570:LYS:HB2	1.97	0.46
2:Q:68:ASP:OD2	2:Q:68:ASP:N	2.48	0.46
2:R:262:PRO:HG3	2:R:318:ILE:HG21	1.95	0.46
2:W:237:SER:O	2:W:244:ARG:NH2	2.48	0.46
2:1:68:ASP:OD2	2:1:68:ASP:N	2.48	0.46
2:2:384:ILE:HD12	2:2:387:LEU:HD12	1.97	0.46
7:I:511:ASP:H	7:I:514:LYS:HG2	1.80	0.46
6:M:581:ASP:HB2	6:M:615:ALA:HB2	1.97	0.46

Continued on next page...

Continued from previous page...

Atom-1	Atom-2	Interatomic distance (Å)	Clash overlap (Å)
2:S:384:ILE:HD12	2:S:387:LEU:HD12	1.97	0.46
2:U:274:THR:HG21	2:U:293:VAL:HG12	1.97	0.46
2:W:292:ASP:HA	2:W:296:ARG:HH21	1.81	0.46
2:X:89:GLU:O	2:X:124:ARG:NH2	2.48	0.46
2:Y:68:ASP:OD2	2:Y:68:ASP:N	2.48	0.46
2:1:274:THR:HG21	2:1:293:VAL:HG12	1.97	0.46
7:K:647:LEU:HD22	2:Y:337:LEU:HD23	1.97	0.46
2:Q:89:GLU:O	2:Q:124:ARG:NH2	2.49	0.46
2:T:68:ASP:OD2	2:T:68:ASP:N	2.48	0.46
2:U:237:SER:O	2:U:244:ARG:NH2	2.48	0.46
2:W:274:THR:HG21	2:W:293:VAL:HG12	1.97	0.46
2:X:407:GLN:NE2	2:X:408:PHE:O	2.47	0.46
2:1:172:PHE:N	2:1:205:LEU:O	2.49	0.46
5:D:689:LYS:HA	5:D:692:ARG:NE	2.31	0.46
6:E:427:TYR:OH	6:E:455:LYS:O	2.31	0.46
2:U:292:ASP:HA	2:U:296:ARG:HH21	1.81	0.46
2:V:89:GLU:O	2:V:124:ARG:NH2	2.49	0.46
2:W:89:GLU:O	2:W:124:ARG:NH2	2.49	0.46
2:X:384:ILE:HD12	2:X:387:LEU:HD12	1.97	0.46
2:Z:89:GLU:O	2:Z:124:ARG:NH2	2.48	0.46
2:1:89:GLU:O	2:1:124:ARG:NH2	2.49	0.46
6:G:162:ARG:O	6:G:166:ASN:ND2	2.48	0.46
1:J:902:MET:HG3	2:X:248:TYR:CE2	2.51	0.46
7:K:341:TRP:CE2	7:K:552:ARG:HA	2.51	0.46
8:L:533:THR:O	8:L:537:HIS:HB2	2.15	0.46
6:M:761:CYS:SG	6:M:762:MET:N	2.89	0.46
2:R:89:GLU:O	2:R:124:ARG:NH2	2.48	0.46
2:R:292:ASP:HA	2:R:296:ARG:HH21	1.81	0.46
2:T:323:ILE:HD12	2:T:323:ILE:HA	1.81	0.46
6:E:628:LEU:H	6:E:628:LEU:HG	1.56	0.46
2:T:172:PHE:N	2:T:205:LEU:O	2.49	0.46
2:X:56:ASP:OD1	2:Y:287:LYS:HD2	2.16	0.46
2:Y:292:ASP:HA	2:Y:296:ARG:HH21	1.81	0.46
2:2:172:PHE:N	2:2:205:LEU:O	2.49	0.46
2:2:353:PRO:HD2	5:N:710:GLU:HG2	1.97	0.46
6:E:529:VAL:O	2:S:3:ARG:NH1	2.49	0.46
7:I:357:ILE:O	7:I:361:TYR:CB	2.62	0.46
7:I:498:LEU:HA	7:I:502:ARG:HB2	1.97	0.46
2:Q:292:ASP:HA	2:Q:296:ARG:HH21	1.81	0.46
2:R:384:ILE:HD12	2:R:387:LEU:HD12	1.97	0.46
2:S:237:SER:O	2:S:241:THR:OG1	2.25	0.46

Continued on next page...

Continued from previous page...

Atom-1	Atom-2	Interatomic distance (Å)	Clash overlap (Å)
2:S:292:ASP:HA	2:S:296:ARG:HH21	1.81	0.46
2:T:237:SER:O	2:T:244:ARG:NH2	2.48	0.46
2:U:68:ASP:N	2:U:68:ASP:OD2	2.48	0.46
2:V:274:THR:HG21	2:V:293:VAL:HG12	1.97	0.46
2:X:292:ASP:HA	2:X:296:ARG:HH21	1.81	0.46
6:E:457:LEU:HD22	6:E:467:VAL:HG12	1.97	0.46
5:H:730:SER:HA	5:H:733:GLU:HG3	1.98	0.46
2:Q:384:ILE:HD12	2:Q:387:LEU:HD12	1.97	0.46
2:S:274:THR:HG21	2:S:293:VAL:HG12	1.97	0.46
2:T:274:THR:HG21	2:T:293:VAL:HG12	1.97	0.46
2:U:89:GLU:O	2:U:124:ARG:NH2	2.48	0.46
2:V:68:ASP:OD2	2:V:68:ASP:N	2.48	0.46
2:Y:172:PHE:N	2:Y:205:LEU:O	2.49	0.46
2:Z:384:ILE:HD12	2:Z:387:LEU:HD12	1.97	0.46
6:E:238:LEU:HD23	6:E:244:ARG:H	1.80	0.46
2:U:172:PHE:N	2:U:205:LEU:O	2.49	0.46
2:U:323:ILE:HD12	2:U:323:ILE:HA	1.81	0.46
5:D:425:PRO:O	5:D:428:SER:OG	2.33	0.45
5:F:397:ALA:O	5:F:473:SER:OG	2.33	0.45
5:H:482:LYS:HD2	5:H:538:TYR:CZ	2.51	0.45
1:J:275:LEU:HA	1:J:379:LEU:HD12	1.97	0.45
1:J:879:GLN:HB3	1:J:880:ILE:HD12	1.98	0.45
2:T:89:GLU:O	2:T:124:ARG:NH2	2.48	0.45
2:X:237:SER:O	2:X:244:ARG:NH2	2.48	0.45
2:2:237:SER:O	2:2:244:ARG:NH2	2.48	0.45
6:E:338:LEU:HD11	6:E:375:LEU:HD21	1.97	0.45
7:K:176:LEU:HG	7:K:180:HIS:HE1	1.81	0.45
6:M:705:THR:HA	6:M:708:ILE:HG22	1.98	0.45
2:W:347:ASN:OD1	2:W:347:ASN:N	2.47	0.45
2:Y:237:SER:O	2:Y:244:ARG:NH2	2.48	0.45
2:Z:274:THR:HG21	2:Z:293:VAL:HG12	1.97	0.45
2:2:292:ASP:HA	2:2:296:ARG:HH21	1.81	0.45
5:D:254:ILE:HB	5:D:366:ARG:HH12	1.81	0.45
6:E:427:TYR:CD2	6:E:431:ARG:HD3	2.51	0.45
5:N:364:LEU:HD13	5:N:370:TRP:HE1	1.81	0.45
2:T:292:ASP:HA	2:T:296:ARG:HH21	1.81	0.45
2:T:384:ILE:HD12	2:T:387:LEU:HD12	1.97	0.45
2:V:384:ILE:HD12	2:V:387:LEU:HD12	1.97	0.45
2:Y:274:THR:HG21	2:Y:293:VAL:HG12	1.97	0.45
6:E:241:ARG:HH21	6:E:242:GLN:NE2	2.15	0.45
1:J:879:GLN:N	1:J:879:GLN:OE1	2.48	0.45

Continued on next page...

Continued from previous page...

Atom-1	Atom-2	Interatomic distance (Å)	Clash overlap (Å)
1:J:882:ARG:NH2	1:J:984:GLU:OE2	2.50	0.45
7:K:577:LYS:O	7:K:581:HIS:HB2	2.15	0.45
2:Q:407:GLN:NE2	2:Q:408:PHE:O	2.47	0.45
2:S:323:ILE:HD12	2:S:323:ILE:HA	1.81	0.45
2:W:384:ILE:HD12	2:W:387:LEU:HD12	1.97	0.45
2:X:274:THR:HG21	2:X:293:VAL:HG12	1.97	0.45
2:Z:68:ASP:N	2:Z:68:ASP:OD2	2.48	0.45
6:E:427:TYR:HB3	6:E:624:TRP:HZ2	1.80	0.45
5:F:480:SER:HA	5:F:483:VAL:HG22	1.98	0.45
8:L:322:LYS:HG3	8:L:325:ARG:NH2	2.31	0.45
2:S:68:ASP:OD2	2:S:68:ASP:N	2.48	0.45
6:M:654:GLN:HB3	6:M:759:THR:HG21	1.98	0.45
2:Q:274:THR:HG21	2:Q:293:VAL:HG12	1.97	0.45
2:R:274:THR:HG21	2:R:293:VAL:HG12	1.97	0.45
2:U:384:ILE:HD12	2:U:387:LEU:HD12	1.97	0.45
6:C:865:TYR:CD1	2:Q:353:PRO:HG3	2.52	0.45
5:H:321:GLY:HA2	5:H:324:PHE:HB3	1.99	0.45
8:L:1679:GLN:HB3	8:L:1715:ARG:HB3	1.99	0.45
6:M:499:LEU:HD23	6:M:719:ILE:HG13	1.98	0.45
2:S:237:SER:O	2:S:244:ARG:NH2	2.48	0.45
5:F:406:THR:HG22	5:F:408:ASP:H	1.81	0.45
7:I:256:GLN:HB3	7:I:257:PHE:H	1.67	0.45
7:I:397:GLN:HB3	7:I:409:ASN:ND2	2.32	0.45
2:U:343:ARG:HG3	2:U:345:LEU:HB2	1.99	0.45
2:V:172:PHE:N	2:V:205:LEU:O	2.49	0.45
2:W:29:HIS:HE1	2:W:244:ARG:HD2	1.82	0.45
2:1:296:ARG:HH11	2:1:296:ARG:HD3	1.59	0.45
2:1:343:ARG:HG3	2:1:345:LEU:HB2	1.99	0.45
7:I:504:HIS:HD2	2:W:265:ARG:HH12	1.65	0.45
6:M:157:LYS:HG2	6:M:284:GLU:HG3	1.99	0.45
5:N:680:ILE:HD11	5:N:786:GLN:HA	1.98	0.45
2:Z:292:ASP:HA	2:Z:296:ARG:HH21	1.81	0.45
2:1:292:ASP:HA	2:1:296:ARG:HH21	1.81	0.45
6:C:551:LEU:HA	6:C:551:LEU:HD12	1.80	0.45
6:E:241:ARG:HH21	6:E:242:GLN:HE22	1.63	0.45
2:R:343:ARG:HG3	2:R:345:LEU:HB2	1.99	0.45
2:W:343:ARG:HG3	2:W:345:LEU:HB2	1.99	0.45
6:C:218:VAL:HG13	6:C:314:HIS:NE2	2.31	0.44
6:G:276:PHE:CE1	6:G:280:LYS:HG3	2.51	0.44
6:M:456:TYR:HA	6:M:459:VAL:HG22	1.98	0.44
2:S:262:PRO:HG2	2:S:263:THR:HG22	2.00	0.44

Continued on next page...

Continued from previous page...

Atom-1	Atom-2	Interatomic distance (Å)	Clash overlap (Å)
2:V:29:HIS:HE1	2:V:244:ARG:HD2	1.82	0.44
2:V:296:ARG:HH11	2:V:296:ARG:HD3	1.59	0.44
2:Y:343:ARG:HG3	2:Y:345:LEU:HB2	1.99	0.44
2:2:29:HIS:HE1	2:2:244:ARG:HD2	1.82	0.44
2:2:343:ARG:HG3	2:2:345:LEU:HB2	1.99	0.44
5:F:388:CYS:HA	5:F:391:ARG:HE	1.82	0.44
6:G:529:VAL:HG22	2:U:3:ARG:HH12	1.82	0.44
6:M:208:LEU:O	6:M:213:GLN:NE2	2.50	0.44
2:R:347:ASN:OD1	2:R:347:ASN:N	2.47	0.44
2:W:57:ASP:HA	2:X:296:ARG:NH1	2.32	0.44
2:X:183:VAL:HG13	2:X:187:ASN:HD21	1.83	0.44
2:X:343:ARG:HG3	2:X:345:LEU:HB2	1.99	0.44
2:Z:172:PHE:N	2:Z:205:LEU:O	2.49	0.44
1:J:391:THR:N	8:L:307:ARG:HH12	2.16	0.44
2:Q:29:HIS:HE1	2:Q:244:ARG:HD2	1.82	0.44
2:R:172:PHE:N	2:R:205:LEU:O	2.49	0.44
2:S:183:VAL:HG13	2:S:187:ASN:HD21	1.83	0.44
2:V:277:THR:HG22	2:V:279:ASP:H	1.83	0.44
2:W:277:THR:HG22	2:W:279:ASP:H	1.83	0.44
6:C:719:ILE:HG22	6:C:723:LEU:HD23	1.99	0.44
5:D:277:VAL:HG13	5:D:288:ARG:HD2	2.00	0.44
6:E:296:MET:HE2	6:E:300:VAL:HG23	2.00	0.44
7:K:328:VAL:HG23	7:K:331:ARG:HH21	1.81	0.44
2:Q:277:THR:HG22	2:Q:279:ASP:H	1.83	0.44
2:S:407:GLN:NE2	2:S:408:PHE:O	2.47	0.44
2:T:277:THR:HG22	2:T:279:ASP:H	1.83	0.44
2:V:292:ASP:HA	2:V:296:ARG:HH21	1.81	0.44
2:W:183:VAL:HG13	2:W:187:ASN:HD21	1.83	0.44
6:C:611:SER:OG	6:C:612:GLY:N	2.50	0.44
2:Q:262:PRO:HG2	2:Q:263:THR:HG22	2.00	0.44
2:R:262:PRO:HG2	2:R:263:THR:HG22	2.00	0.44
2:1:277:THR:HG22	2:1:279:ASP:H	1.83	0.44
6:C:516:ILE:HG23	6:C:638:TYR:CE2	2.53	0.44
6:C:520:PHE:CZ	6:C:618:PHE:HB2	2.52	0.44
6:E:288:VAL:HG11	6:E:356:LEU:HD12	2.00	0.44
6:M:548:PRO:HA	6:M:551:LEU:HD12	1.99	0.44
2:R:277:THR:HG22	2:R:279:ASP:H	1.83	0.44
2:U:396:ASP:OD2	2:U:425:ARG:NH2	2.47	0.44
2:Y:350:PRO:HG2	2:Y:441:PRO:HG3	2.00	0.44
6:E:158:ARG:HB3	6:E:162:ARG:HH21	1.82	0.44
5:N:327:ALA:HB2	5:N:421:LEU:HD23	1.99	0.44

Continued on next page...

Continued from previous page...

Atom-1	Atom-2	Interatomic distance (Å)	Clash overlap (Å)
2:Q:183:VAL:HG13	2:Q:187:ASN:HD21	1.83	0.44
2:T:262:PRO:HG2	2:T:263:THR:HG22	2.00	0.44
2:U:29:HIS:HE1	2:U:244:ARG:HD2	1.82	0.44
2:W:350:PRO:HG2	2:W:441:PRO:HG3	2.00	0.44
2:X:172:PHE:N	2:X:205:LEU:O	2.49	0.44
2:X:262:PRO:HG2	2:X:263:THR:HG22	2.00	0.44
8:L:1804:PHE:CD1	2:Z:355:SER:HB3	2.52	0.44
2:R:323:ILE:HD12	2:R:323:ILE:HA	1.81	0.44
2:T:343:ARG:HG3	2:T:345:LEU:HB2	1.99	0.44
2:U:262:PRO:HG2	2:U:263:THR:HG22	2.00	0.44
2:Z:29:HIS:HE1	2:Z:244:ARG:HD2	1.82	0.44
2:1:183:VAL:HG13	2:1:187:ASN:HD21	1.83	0.44
2:1:355:SER:OG	6:M:861:PHE:HB3	2.18	0.44
2:2:262:PRO:HG2	2:2:263:THR:HG22	1.99	0.44
6:E:663:LYS:NZ	2:S:164:LYS:O	2.40	0.44
6:E:663:LYS:NZ	2:S:200:ASP:OD1	2.51	0.44
5:H:361:SER:OG	5:H:362:LEU:N	2.50	0.44
2:T:396:ASP:OD2	2:T:425:ARG:NH2	2.47	0.44
2:V:183:VAL:HG13	2:V:187:ASN:HD21	1.83	0.44
2:Z:262:PRO:HG2	2:Z:263:THR:HG22	2.00	0.44
2:1:29:HIS:HE1	2:1:244:ARG:HD2	1.82	0.43
2:1:350:PRO:HG2	2:1:441:PRO:HG3	2.00	0.43
2:2:323:ILE:HD12	2:2:323:ILE:HA	1.81	0.43
6:G:359:LEU:HB3	6:G:380:THR:HG22	2.00	0.43
2:R:183:VAL:HG13	2:R:187:ASN:HD21	1.83	0.43
2:S:29:HIS:HE1	2:S:244:ARG:HD2	1.82	0.43
2:T:29:HIS:HE1	2:T:244:ARG:HD2	1.82	0.43
5:D:337:ARG:HB2	6:E:326:PHE:CE1	2.53	0.43
5:D:581:LEU:HD21	5:D:597:LEU:HD23	2.00	0.43
6:G:529:VAL:O	2:U:3:ARG:NH1	2.51	0.43
7:K:275:LYS:HB3	7:K:333:ARG:HG3	2.00	0.43
7:K:497:ALA:HB2	2:Y:254:ILE:HD11	1.99	0.43
2:W:172:PHE:N	2:W:205:LEU:O	2.49	0.43
2:W:262:PRO:HG2	2:W:263:THR:HG22	2.00	0.43
2:X:347:ASN:OD1	2:X:347:ASN:N	2.47	0.43
2:2:183:VAL:HG13	2:2:187:ASN:HD21	1.83	0.43
7:I:448:SER:OG	7:I:449:GLY:N	2.50	0.43
1:J:283:LYS:HD2	1:J:283:LYS:HA	1.78	0.43
7:K:11:GLY:HA2	7:K:53:ILE:HG12	2.00	0.43
6:M:610:LEU:HB3	6:M:613:LEU:HD13	2.00	0.43
2:Q:343:ARG:HG3	2:Q:345:LEU:HB2	1.99	0.43

Continued on next page...

Continued from previous page...

Atom-1	Atom-2	Interatomic distance (Å)	Clash overlap (Å)
2:R:29:HIS:HE1	2:R:244:ARG:HD2	1.82	0.43
2:T:296:ARG:HH11	2:T:296:ARG:HD3	1.59	0.43
2:Y:277:THR:HG22	2:Y:279:ASP:H	1.83	0.43
2:Z:183:VAL:HG13	2:Z:187:ASN:HD21	1.83	0.43
2:Z:277:THR:HG22	2:Z:279:ASP:H	1.83	0.43
5:D:688:ALA:O	5:D:692:ARG:HG3	2.17	0.43
5:N:654:ARG:HA	5:N:657:MET:HG2	2.00	0.43
2:R:20:GLU:OE1	2:R:230:GLN:NE2	2.52	0.43
2:R:69:LEU:HD12	2:R:69:LEU:HA	1.88	0.43
2:S:20:GLU:OE1	2:S:230:GLN:NE2	2.52	0.43
2:S:277:THR:HG22	2:S:279:ASP:H	1.83	0.43
2:T:183:VAL:HG13	2:T:187:ASN:HD21	1.83	0.43
2:V:396:ASP:OD2	2:V:425:ARG:NH2	2.47	0.43
2:W:20:GLU:OE1	2:W:230:GLN:NE2	2.52	0.43
2:Y:237:SER:O	2:Y:241:THR:OG1	2.25	0.43
2:1:297:LEU:HD12	2:1:297:LEU:HA	1.91	0.43
6:E:821:THR:HA	6:E:824:LYS:HG2	2.00	0.43
7:I:498:LEU:HD11	7:I:517:LEU:HD22	2.00	0.43
8:L:350:CYS:HB2	8:L:453:THR:HG21	1.99	0.43
2:U:183:VAL:HG13	2:U:187:ASN:HD21	1.83	0.43
2:V:343:ARG:HG3	2:V:345:LEU:HB2	1.99	0.43
2:1:262:PRO:HG2	2:1:263:THR:HG22	2.00	0.43
6:E:180:TRP:O	6:E:184:ARG:HG2	2.18	0.43
6:E:713:LEU:HD22	6:E:722:VAL:HG13	2.00	0.43
6:G:449:LYS:O	6:G:453:THR:OG1	2.30	0.43
2:Z:343:ARG:HG3	2:Z:345:LEU:HB2	1.99	0.43
2:1:110:GLN:HA	2:1:113:LYS:HE3	2.01	0.43
2:2:277:THR:HG22	2:2:279:ASP:H	1.83	0.43
6:C:692:ASN:HD22	6:C:859:LEU:HD23	1.82	0.43
5:D:409:PRO:HA	5:D:412:ARG:HB2	2.01	0.43
6:E:320:SER:OG	6:E:321:LEU:N	2.51	0.43
6:E:674:GLN:HB2	6:E:675:TRP:H	1.62	0.43
5:F:400:VAL:HG11	5:F:422:VAL:HG21	1.99	0.43
8:L:469:GLN:HA	8:L:517:HIS:CE1	2.53	0.43
2:Q:110:GLN:HA	2:Q:113:LYS:HE3	2.01	0.43
2:S:172:PHE:N	2:S:205:LEU:O	2.49	0.43
2:T:110:GLN:HA	2:T:113:LYS:HE3	2.01	0.43
2:U:110:GLN:HA	2:U:113:LYS:HE3	2.01	0.43
2:U:277:THR:HG22	2:U:279:ASP:H	1.83	0.43
2:X:29:HIS:HE1	2:X:244:ARG:HD2	1.82	0.43
2:Z:110:GLN:HA	2:Z:113:LYS:HE3	2.01	0.43

Continued on next page...

Continued from previous page...

Atom-1	Atom-2	Interatomic distance (Å)	Clash overlap (Å)
2:T:350:PRO:HG2	2:T:441:PRO:HG3	2.00	0.43
2:Y:29:HIS:HE1	2:Y:244:ARG:HD2	1.82	0.43
2:Y:262:PRO:HG2	2:Y:263:THR:HG22	1.99	0.43
2:Z:350:PRO:HG2	2:Z:441:PRO:HG3	2.00	0.43
2:2:350:PRO:HG2	2:2:441:PRO:HG3	2.00	0.43
6:C:695:TYR:HE2	2:Q:357:GLN:HB3	1.84	0.43
6:E:578:MET:HG2	6:E:584:THR:HG21	2.00	0.43
5:N:408:ASP:HB3	5:N:411:MET:HB2	2.01	0.43
2:Q:350:PRO:HG2	2:Q:441:PRO:HG3	2.00	0.43
2:X:277:THR:HG22	2:X:279:ASP:H	1.83	0.43
6:E:585:GLN:HB2	6:E:739:LEU:HD12	2.01	0.43
6:E:623:LYS:O	6:E:627:SER:N	2.52	0.43
5:H:658:SER:O	5:H:662:ARG:HG3	2.19	0.43
5:N:660:TYR:HA	5:N:663:VAL:HG22	2.01	0.43
2:Q:69:LEU:HD12	2:Q:69:LEU:HA	1.88	0.43
2:U:20:GLU:OE1	2:U:230:GLN:NE2	2.52	0.43
2:V:262:PRO:HG2	2:V:263:THR:HG22	2.00	0.43
2:W:237:SER:O	2:W:241:THR:OG1	2.25	0.43
6:C:280:LYS:HD2	6:C:285:TYR:CE2	2.54	0.42
6:C:448:ASP:OD1	6:C:448:ASP:N	2.52	0.42
6:E:427:TYR:HD1	6:E:628:LEU:HD22	1.84	0.42
6:E:679:ALA:HB2	6:E:818:PHE:CE2	2.53	0.42
1:J:311:ARG:O	1:J:315:GLU:HB2	2.19	0.42
7:K:282:SER:HB2	7:K:340:LEU:HD21	2.01	0.42
5:N:589:ALA:HB1	5:N:628:VAL:HG12	2.00	0.42
5:N:755:LEU:HA	5:N:755:LEU:HD13	1.86	0.42
2:Q:172:PHE:N	2:Q:205:LEU:O	2.49	0.42
2:R:110:GLN:HA	2:R:113:LYS:HE3	2.01	0.42
2:V:69:LEU:HD12	2:V:69:LEU:HA	1.88	0.42
2:X:350:PRO:HG2	2:X:441:PRO:HG3	2.00	0.42
6:C:178:PRO:HB3	6:C:180:TRP:CE2	2.54	0.42
6:G:180:TRP:HA	6:G:183:GLU:HB2	2.01	0.42
8:L:1804:PHE:HD1	2:Z:355:SER:HB3	1.82	0.42
6:M:660:ILE:HA	6:M:663:LYS:HA	2.01	0.42
6:M:711:LYS:HA	6:M:714:LYS:HG2	2.01	0.42
5:N:449:ALA:HB2	5:N:467:ARG:HD2	2.00	0.42
5:N:730:SER:HA	5:N:733:GLU:HG3	2.01	0.42
2:S:350:PRO:HG2	2:S:441:PRO:HG3	2.00	0.42
5:D:587:ARG:HH22	5:D:591:THR:HB	1.84	0.42
2:S:110:GLN:HA	2:S:113:LYS:HE3	2.01	0.42
2:S:343:ARG:HG3	2:S:345:LEU:HB2	1.99	0.42

Continued on next page...

Continued from previous page...

Atom-1	Atom-2	Interatomic distance (Å)	Clash overlap (Å)
2:S:352:GLY:HA2	2:S:353:PRO:HD3	1.88	0.42
2:V:237:SER:O	2:V:241:THR:OG1	2.25	0.42
2:V:350:PRO:HG2	2:V:441:PRO:HG3	2.00	0.42
2:W:110:GLN:HA	2:W:113:LYS:HE3	2.01	0.42
6:E:442:PHE:HE1	6:E:484:TYR:HE1	1.66	0.42
5:F:468:LYS:HA	5:F:471:ILE:HG13	2.01	0.42
6:G:818:PHE:O	6:G:822:ILE:HG12	2.20	0.42
7:I:118:SER:OG	7:I:119:ILE:N	2.53	0.42
5:N:463:LYS:HE2	5:N:495:GLN:HE22	1.83	0.42
2:R:350:PRO:HG2	2:R:441:PRO:HG3	2.00	0.42
2:X:141:ILE:H	2:X:171:VAL:HG22	1.85	0.42
2:Z:20:GLU:OE1	2:Z:230:GLN:NE2	2.52	0.42
2:1:141:ILE:H	2:1:171:VAL:HG22	1.84	0.42
2:2:9:GLN:HE21	2:2:64:ALA:HB1	1.85	0.42
2:2:110:GLN:HA	2:2:113:LYS:HE3	2.01	0.42
5:D:797:LEU:HA	5:D:800:LEU:HG	2.01	0.42
6:M:395:ILE:HD11	6:M:450:ILE:HG23	2.02	0.42
2:U:350:PRO:HG2	2:U:441:PRO:HG3	2.00	0.42
5:F:319:LEU:O	5:F:323:SER:OG	2.37	0.42
1:J:237:HIS:O	1:J:239:HIS:N	2.53	0.42
2:Q:20:GLU:OE1	2:Q:230:GLN:NE2	2.52	0.42
2:U:141:ILE:H	2:U:171:VAL:HG22	1.85	0.42
2:Y:9:GLN:HE21	2:Y:64:ALA:HB1	1.85	0.42
2:Y:323:ILE:HD12	2:Y:323:ILE:HA	1.81	0.42
5:F:334:GLU:O	5:F:338:LEU:HD13	2.19	0.42
5:H:763:LEU:HD12	5:H:775:LEU:HD22	2.02	0.42
5:H:869:SER:HB3	5:H:873:LEU:HD13	2.01	0.42
7:I:172:LEU:HD23	7:I:175:ILE:HD12	2.01	0.42
6:M:739:LEU:HD13	6:M:739:LEU:HA	1.83	0.42
2:Q:237:SER:O	2:Q:241:THR:OG1	2.25	0.42
2:V:141:ILE:H	2:V:171:VAL:HG22	1.85	0.42
2:W:141:ILE:H	2:W:171:VAL:HG22	1.85	0.42
2:Y:141:ILE:H	2:Y:171:VAL:HG22	1.85	0.42
2:Y:183:VAL:HG13	2:Y:187:ASN:HD21	1.83	0.42
2:Z:9:GLN:HE21	2:Z:64:ALA:HB1	1.85	0.42
2:Z:37:VAL:HG12	2:Z:59:HIS:CD2	2.54	0.42
7:I:59:ILE:HD11	7:I:93:LEU:HG	2.00	0.42
2:R:9:GLN:HE21	2:R:64:ALA:HB1	1.85	0.42
2:S:383:SER:O	2:S:386:SER:OG	2.29	0.42
2:T:20:GLU:OE1	2:T:230:GLN:NE2	2.52	0.42
2:T:37:VAL:HG12	2:T:59:HIS:CD2	2.54	0.42

Continued on next page...

Continued from previous page...

Atom-1	Atom-2	Interatomic distance (Å)	Clash overlap (Å)
2:U:397:LYS:HE2	2:U:401:ARG:HH11	1.85	0.42
2:Y:110:GLN:HA	2:Y:113:LYS:HE3	2.01	0.42
2:Y:397:LYS:HE2	2:Y:401:ARG:HH11	1.85	0.42
5:D:653:THR:HG22	5:D:655:GLU:H	1.85	0.42
6:E:577:LEU:HD13	6:E:611:SER:HB2	2.01	0.42
5:H:485:LEU:HD12	5:H:485:LEU:HA	1.93	0.42
7:K:305:ASP:N	7:K:305:ASP:OD2	2.53	0.42
5:N:871:GLU:HG2	5:N:874:ARG:NH2	2.34	0.42
2:Q:396:ASP:OD2	2:Q:425:ARG:NH2	2.47	0.42
2:Z:141:ILE:H	2:Z:171:VAL:HG22	1.85	0.42
2:S:37:VAL:HG12	2:S:59:HIS:CD2	2.54	0.42
2:W:397:LYS:HE2	2:W:401:ARG:HH11	1.85	0.42
2:Z:397:LYS:HE2	2:Z:401:ARG:HH11	1.85	0.42
2:1:298:LEU:HD21	2:1:346:ALA:HB2	2.02	0.41
5:F:644:VAL:HG11	5:F:652:PHE:HB2	2.02	0.41
6:G:304:LEU:HB3	5:H:369:VAL:HG22	2.01	0.41
7:K:264:LEU:HD12	7:K:265:PRO:HD2	2.01	0.41
2:R:141:ILE:H	2:R:171:VAL:HG22	1.84	0.41
2:W:9:GLN:HE21	2:W:64:ALA:HB1	1.85	0.41
2:X:20:GLU:OE1	2:X:230:GLN:NE2	2.52	0.41
2:X:323:ILE:HD12	2:X:323:ILE:HA	1.81	0.41
2:2:141:ILE:H	2:2:171:VAL:HG22	1.85	0.41
6:C:520:PHE:HB2	6:C:638:TYR:CZ	2.55	0.41
6:E:427:TYR:HE1	6:E:628:LEU:HD13	1.85	0.41
7:I:586:ILE:HD13	7:I:622:GLN:HE21	1.85	0.41
1:J:886:LEU:HA	1:J:886:LEU:HD13	1.68	0.41
2:Q:66:LEU:HD21	2:Q:74:ILE:HG12	2.03	0.41
2:R:298:LEU:HD21	2:R:346:ALA:HB2	2.03	0.41
2:S:141:ILE:H	2:S:171:VAL:HG22	1.85	0.41
2:T:66:LEU:HD21	2:T:74:ILE:HG12	2.03	0.41
2:W:66:LEU:HD21	2:W:74:ILE:HG12	2.03	0.41
2:X:110:GLN:HA	2:X:113:LYS:HE3	2.01	0.41
2:Y:20:GLU:OE1	2:Y:230:GLN:NE2	2.52	0.41
2:Z:66:LEU:HD21	2:Z:74:ILE:HG12	2.03	0.41
2:1:66:LEU:HD21	2:1:74:ILE:HG12	2.02	0.41
2:Q:37:VAL:HG12	2:Q:59:HIS:CD2	2.54	0.41
2:Q:352:GLY:HA2	2:Q:353:PRO:HD3	1.88	0.41
2:R:37:VAL:HG12	2:R:59:HIS:CD2	2.54	0.41
2:U:298:LEU:HD21	2:U:346:ALA:HB2	2.02	0.41
2:V:20:GLU:OE1	2:V:230:GLN:NE2	2.52	0.41
2:V:110:GLN:HA	2:V:113:LYS:HE3	2.01	0.41

Continued on next page...

Continued from previous page...

Atom-1	Atom-2	Interatomic distance (Å)	Clash overlap (Å)
2:W:298:LEU:HD21	2:W:346:ALA:HB2	2.03	0.41
2:2:66:LEU:HD21	2:2:74:ILE:HG12	2.03	0.41
6:E:466:ASP:OD1	6:E:466:ASP:N	2.49	0.41
6:G:685:ARG:HD3	2:U:353:PRO:HG2	2.02	0.41
7:I:404:LEU:HD23	7:I:404:LEU:HA	1.76	0.41
6:M:439:ILE:HG22	6:M:441:SER:H	1.84	0.41
2:R:396:ASP:OD2	2:R:425:ARG:NH2	2.47	0.41
2:R:397:LYS:HE2	2:R:401:ARG:HH11	1.85	0.41
2:S:9:GLN:HE21	2:S:64:ALA:HB1	1.85	0.41
2:U:13:CYS:HB2	2:U:140:SER:HB3	2.03	0.41
2:X:66:LEU:HD21	2:X:74:ILE:HG12	2.03	0.41
6:C:277:ILE:HG12	6:C:293:ALA:HB1	2.01	0.41
5:H:336:TYR:HB2	7:I:124:TYR:CD1	2.55	0.41
1:J:275:LEU:O	1:J:279:SER:OG	2.35	0.41
2:Q:397:LYS:HE2	2:Q:401:ARG:HH11	1.85	0.41
2:R:66:LEU:HD21	2:R:74:ILE:HG12	2.02	0.41
2:W:53:TYR:N	2:W:61:ILE:O	2.54	0.41
2:X:13:CYS:HB2	2:X:140:SER:HB3	2.03	0.41
2:Y:296:ARG:HB2	2:Y:296:ARG:HE	1.72	0.41
5:D:609:ASN:HD22	5:D:609:ASN:HA	1.63	0.41
1:J:762:LEU:HD22	1:J:801:LEU:HD11	2.03	0.41
2:Q:53:TYR:N	2:Q:61:ILE:O	2.54	0.41
2:Q:298:LEU:HD21	2:Q:346:ALA:HB2	2.02	0.41
2:R:53:TYR:N	2:R:61:ILE:O	2.54	0.41
2:R:297:LEU:HD12	2:R:297:LEU:HA	1.91	0.41
2:U:383:SER:O	2:U:386:SER:OG	2.29	0.41
2:V:397:LYS:HE2	2:V:401:ARG:HH11	1.85	0.41
2:W:425:ARG:HA	2:W:428:VAL:HG12	2.03	0.41
2:Y:298:LEU:HD21	2:Y:346:ALA:HB2	2.02	0.41
2:1:20:GLU:OE1	2:1:230:GLN:NE2	2.52	0.41
2:2:296:ARG:HB2	2:2:296:ARG:HE	1.72	0.41
6:E:700:GLU:OE1	2:S:334:HIS:HB3	2.20	0.41
1:J:493:ILE:HG13	1:J:494:ILE:HG12	2.03	0.41
7:K:648:ARG:HG3	7:K:649:LEU:HD23	2.02	0.41
2:S:53:TYR:N	2:S:61:ILE:O	2.54	0.41
2:S:425:ARG:HA	2:S:428:VAL:HG12	2.03	0.41
2:U:84:LYS:HB2	2:U:84:LYS:HE3	1.90	0.41
2:X:53:TYR:N	2:X:61:ILE:O	2.54	0.41
2:1:425:ARG:HA	2:1:428:VAL:HG12	2.03	0.41
6:C:840:LEU:HB2	6:C:856:ILE:HD11	2.02	0.41
6:E:547:THR:HA	6:E:548:PRO:HD3	1.93	0.41

Continued on next page...

Continued from previous page...

Atom-1	Atom-2	Interatomic distance (Å)	Clash overlap (Å)
5:F:679:ASP:HA	5:F:682:LYS:HB3	2.03	0.41
5:F:836:PHE:O	5:F:840:ILE:HG12	2.20	0.41
6:M:238:LEU:HA	6:M:238:LEU:HD12	1.68	0.41
2:Q:141:ILE:H	2:Q:171:VAL:HG22	1.85	0.41
2:1:53:TYR:N	2:1:61:ILE:O	2.54	0.41
2:1:396:ASP:OD2	2:1:425:ARG:NH2	2.47	0.41
2:2:397:LYS:HE2	2:2:401:ARG:HH11	1.85	0.41
2:2:425:ARG:HA	2:2:428:VAL:HG12	2.03	0.41
6:C:864:PHE:CZ	2:Q:348:PHE:HD1	2.39	0.41
5:D:327:ALA:HB1	5:D:418:ILE:HA	2.03	0.41
5:F:619:ARG:HH12	5:F:620:ARG:NH1	2.18	0.41
1:J:884:PHE:O	1:J:888:VAL:HG23	2.21	0.41
7:K:190:TRP:CH2	7:K:280:GLY:HA3	2.56	0.41
6:M:356:LEU:HG	6:M:440:PRO:HB3	2.03	0.41
5:N:644:VAL:HG11	5:N:649:ALA:HB2	2.02	0.41
2:Q:187:ASN:O	2:Q:191:THR:OG1	2.33	0.41
2:T:53:TYR:N	2:T:61:ILE:O	2.54	0.41
2:V:425:ARG:HA	2:V:428:VAL:HG12	2.03	0.41
2:W:37:VAL:HG12	2:W:59:HIS:CD2	2.54	0.41
2:X:9:GLN:HE21	2:X:64:ALA:HB1	1.85	0.41
2:X:37:VAL:HG12	2:X:59:HIS:CD2	2.54	0.41
2:X:397:LYS:HE2	2:X:401:ARG:HH11	1.85	0.41
2:Y:396:ASP:OD2	2:Y:425:ARG:NH2	2.47	0.41
2:Y:425:ARG:HA	2:Y:428:VAL:HG12	2.03	0.41
2:Z:53:TYR:N	2:Z:61:ILE:O	2.54	0.41
2:Z:298:LEU:HD21	2:Z:346:ALA:HB2	2.02	0.41
2:1:9:GLN:HE21	2:1:64:ALA:HB1	1.85	0.41
2:1:37:VAL:HG12	2:1:59:HIS:CD2	2.54	0.41
2:2:298:LEU:HD21	2:2:346:ALA:HB2	2.03	0.41
6:E:384:SER:OG	6:E:477:TYR:HB3	2.21	0.41
6:G:652:GLU:HG2	6:G:694:GLN:HE22	1.86	0.41
1:J:719:TYR:HD1	1:J:809:VAL:HG21	1.85	0.41
7:K:181:GLY:HA2	7:K:315:LYS:HG3	2.02	0.41
2:T:425:ARG:HA	2:T:428:VAL:HG12	2.03	0.41
2:U:9:GLN:HE21	2:U:64:ALA:HB1	1.85	0.41
2:U:53:TYR:N	2:U:61:ILE:O	2.54	0.41
2:V:352:GLY:HA2	2:V:353:PRO:HD3	1.88	0.41
2:Y:13:CYS:HB2	2:Y:140:SER:HB3	2.03	0.41
6:C:767:GLN:HE21	6:C:814:LEU:HG	1.85	0.40
6:E:180:TRP:O	6:E:184:ARG:NH1	2.54	0.40
5:H:874:ARG:O	5:H:877:SER:OG	2.29	0.40

Continued on next page...

Continued from previous page...

Atom-1	Atom-2	Interatomic distance (Å)	Clash overlap (Å)
7:I:518:ARG:HD3	7:I:616:VAL:HG12	2.01	0.40
2:S:397:LYS:HE2	2:S:401:ARG:HH11	1.85	0.40
2:U:37:VAL:HG12	2:U:59:HIS:CD2	2.54	0.40
2:V:37:VAL:HG12	2:V:59:HIS:CD2	2.54	0.40
2:Z:84:LYS:HB2	2:Z:84:LYS:HE3	1.90	0.40
2:1:395:TYR:HE2	2:1:425:ARG:HG3	1.87	0.40
2:2:20:GLU:OE1	2:2:230:GLN:NE2	2.52	0.40
6:E:838:ALA:HB3	6:E:871:ARG:HH21	1.86	0.40
6:G:557:LEU:HD21	2:V:343:ARG:HD3	2.03	0.40
5:N:706:ILE:O	5:N:710:GLU:HG3	2.21	0.40
2:T:298:LEU:HD21	2:T:346:ALA:HB2	2.03	0.40
2:W:13:CYS:HB2	2:W:140:SER:HB3	2.03	0.40
2:1:397:LYS:HE2	2:1:401:ARG:HH11	1.85	0.40
2:2:53:TYR:N	2:2:61:ILE:O	2.54	0.40
1:J:216:LEU:HD22	1:J:222:HIS:NE2	2.36	0.40
8:L:1623:LEU:HD12	8:L:1623:LEU:HA	1.94	0.40
5:N:588:PRO:HA	5:N:634:GLY:H	1.86	0.40
2:Q:9:GLN:HE21	2:Q:64:ALA:HB1	1.85	0.40
2:S:298:LEU:HD21	2:S:346:ALA:HB2	2.03	0.40
2:T:9:GLN:HE21	2:T:64:ALA:HB1	1.85	0.40
2:T:252:ASP:OD1	2:T:252:ASP:N	2.55	0.40
2:U:66:LEU:HD21	2:U:74:ILE:HG12	2.02	0.40
2:V:9:GLN:HE21	2:V:64:ALA:HB1	1.85	0.40
2:V:337:LEU:HD12	2:V:337:LEU:HA	1.94	0.40
2:Y:53:TYR:N	2:Y:61:ILE:O	2.54	0.40
2:Z:252:ASP:OD1	2:Z:252:ASP:N	2.55	0.40
2:1:296:ARG:HG3	2:1:302:ASN:ND2	2.37	0.40
5:D:689:LYS:HA	5:D:692:ARG:HE	1.86	0.40
5:F:293:ARG:HD3	5:F:368:LEU:HD22	2.03	0.40
7:K:411:LEU:HD13	7:K:414:LEU:HD12	2.03	0.40
8:L:346:LEU:HD13	8:L:347:VAL:HA	2.02	0.40
5:N:553:TYR:O	5:N:558:HIS:HE1	2.04	0.40
2:Q:13:CYS:HB2	2:Q:140:SER:HB3	2.03	0.40
2:Q:323:ILE:HD12	2:Q:323:ILE:HA	1.81	0.40
2:R:252:ASP:OD1	2:R:252:ASP:N	2.55	0.40
2:V:53:TYR:N	2:V:61:ILE:O	2.54	0.40
2:V:66:LEU:HD21	2:V:74:ILE:HG12	2.03	0.40
2:Y:296:ARG:HG3	2:Y:302:ASN:ND2	2.37	0.40
2:Z:296:ARG:HG3	2:Z:302:ASN:ND2	2.37	0.40
2:Z:425:ARG:HA	2:Z:428:VAL:HG12	2.03	0.40
2:1:13:CYS:HB2	2:1:140:SER:HB3	2.02	0.40

Continued on next page...

Continued from previous page...

Atom-1	Atom-2	Interatomic distance (Å)	Clash overlap (Å)
2:1:252:ASP:OD1	2:1:252:ASP:N	2.55	0.40
2:2:395:TYR:HE2	2:2:425:ARG:HG3	1.87	0.40
6:C:217:VAL:HG12	6:C:321:LEU:HD21	2.03	0.40
5:D:391:ARG:HH21	5:D:399:ALA:HB2	1.85	0.40
5:F:572:ASP:O	5:F:575:ARG:HG3	2.22	0.40
5:H:799:GLU:HG2	5:H:802:ARG:HH11	1.85	0.40
1:J:998:LEU:HD11	1:J:1010:LEU:HB3	2.03	0.40
7:K:255:LYS:HD2	7:K:255:LYS:HA	1.87	0.40
2:S:84:LYS:HE3	2:S:84:LYS:HB2	1.90	0.40
2:T:397:LYS:HE2	2:T:401:ARG:HH11	1.85	0.40
2:W:323:ILE:HD12	2:W:323:ILE:HA	1.81	0.40
2:Z:13:CYS:HB2	2:Z:140:SER:HB3	2.03	0.40
2:Z:352:GLY:HA2	2:Z:353:PRO:HD3	1.88	0.40

There are no symmetry-related clashes.

5.3 Torsion angles [i](#)

5.3.1 Protein backbone [i](#)

In the following table, the Percentiles column shows the percent Ramachandran outliers of the chain as a percentile score with respect to all PDB entries followed by that with respect to all EM entries.

The Analysed column shows the number of residues for which the backbone conformation was analysed, and the total number of residues.

Mol	Chain	Analysed	Favoured	Allowed	Outliers	Percentiles	
1	J	506/1024 (49%)	467 (92%)	35 (7%)	4 (1%)	19	60
1	l	104/1024 (10%)	94 (90%)	9 (9%)	1 (1%)	15	55
2	1	408/451 (90%)	385 (94%)	21 (5%)	2 (0%)	29	69
2	2	408/451 (90%)	385 (94%)	21 (5%)	2 (0%)	29	69
2	Q	408/451 (90%)	385 (94%)	21 (5%)	2 (0%)	29	69
2	R	408/451 (90%)	385 (94%)	21 (5%)	2 (0%)	29	69
2	S	408/451 (90%)	385 (94%)	21 (5%)	2 (0%)	29	69
2	T	408/451 (90%)	385 (94%)	21 (5%)	2 (0%)	29	69
2	U	408/451 (90%)	385 (94%)	21 (5%)	2 (0%)	29	69
2	V	408/451 (90%)	385 (94%)	21 (5%)	2 (0%)	29	69

Continued on next page...

Continued from previous page...

Mol	Chain	Analysed	Favoured	Allowed	Outliers	Percentiles	
2	W	408/451 (90%)	385 (94%)	21 (5%)	2 (0%)	29	69
2	X	408/451 (90%)	385 (94%)	21 (5%)	2 (0%)	29	69
2	Y	408/451 (90%)	385 (94%)	21 (5%)	2 (0%)	29	69
2	Z	408/451 (90%)	385 (94%)	21 (5%)	2 (0%)	29	69
3	e	360/375 (96%)	339 (94%)	21 (6%)	0	100	100
4	b	63/82 (77%)	62 (98%)	1 (2%)	0	100	100
4	d	57/82 (70%)	57 (100%)	0	0	100	100
4	i	63/82 (77%)	62 (98%)	1 (2%)	0	100	100
4	k	63/82 (77%)	61 (97%)	2 (3%)	0	100	100
4	m	63/82 (77%)	62 (98%)	1 (2%)	0	100	100
5	D	571/907 (63%)	547 (96%)	24 (4%)	0	100	100
5	F	591/907 (65%)	556 (94%)	32 (5%)	3 (0%)	29	69
5	H	584/907 (64%)	565 (97%)	19 (3%)	0	100	100
5	N	584/907 (64%)	565 (97%)	19 (3%)	0	100	100
5	a	112/907 (12%)	108 (96%)	3 (3%)	1 (1%)	17	57
5	h	97/907 (11%)	95 (98%)	2 (2%)	0	100	100
5	j	105/907 (12%)	97 (92%)	7 (7%)	1 (1%)	15	55
6	C	606/902 (67%)	577 (95%)	26 (4%)	3 (0%)	29	69
6	E	626/902 (69%)	577 (92%)	47 (8%)	2 (0%)	41	77
6	G	624/902 (69%)	589 (94%)	32 (5%)	3 (0%)	29	69
6	M	624/902 (69%)	591 (95%)	28 (4%)	5 (1%)	19	60
7	I	511/667 (77%)	473 (93%)	32 (6%)	6 (1%)	13	50
7	K	548/667 (82%)	526 (96%)	21 (4%)	1 (0%)	47	81
8	L	540/1819 (30%)	493 (91%)	44 (8%)	3 (1%)	25	66
8	c	148/1819 (8%)	139 (94%)	9 (6%)	0	100	100
All	All	13046/23174 (56%)	12322 (94%)	667 (5%)	57 (0%)	38	72

All (57) Ramachandran outliers are listed below:

Mol	Chain	Res	Type
1	l	121	PRO
6	C	239	ALA
6	C	465	HIS

Continued on next page...

Continued from previous page...

Mol	Chain	Res	Type
6	E	425	ASP
6	G	241	ARG
6	G	581	ASP
7	I	408	ASP
7	I	509	GLN
7	I	601	LEU
1	J	237	HIS
1	J	238	LEU
6	M	241	ARG
6	M	243	SER
5	j	108	PRO
2	1	347	ASN
2	1	348	PHE
2	2	347	ASN
2	2	348	PHE
6	E	426	LYS
5	F	270	ASN
7	I	510	THR
8	L	307	ARG
6	M	676	PHE
2	Q	347	ASN
2	Q	348	PHE
2	R	347	ASN
2	R	348	PHE
2	S	347	ASN
2	S	348	PHE
2	T	347	ASN
2	T	348	PHE
2	U	347	ASN
2	U	348	PHE
2	V	347	ASN
2	V	348	PHE
2	W	347	ASN
2	W	348	PHE
2	X	347	ASN
2	X	348	PHE
2	Y	347	ASN
2	Y	348	PHE
2	Z	347	ASN
2	Z	348	PHE
6	G	582	LEU
7	I	259	LEU

Continued on next page...

Continued from previous page...

Mol	Chain	Res	Type
1	J	255	PRO
8	L	345	VAL
5	a	44	ALA
6	M	238	LEU
6	M	242	GLN
6	C	240	GLY
7	I	508	ASN
7	K	409	ASN
8	L	343	GLN
5	F	501	THR
1	J	713	ASP
5	F	502	PRO

5.3.2 Protein sidechains [i](#)

In the following table, the Percentiles column shows the percent sidechain outliers of the chain as a percentile score with respect to all PDB entries followed by that with respect to all EM entries.

The Analysed column shows the number of residues for which the sidechain conformation was analysed, and the total number of residues.

Mol	Chain	Analysed	Rotameric	Outliers	Percentiles	
1	J	498/933 (53%)	495 (99%)	3 (1%)	86	92
1	l	84/933 (9%)	84 (100%)	0	100	100
2	1	376/400 (94%)	348 (93%)	28 (7%)	13	38
2	2	376/400 (94%)	348 (93%)	28 (7%)	13	38
2	Q	376/400 (94%)	348 (93%)	28 (7%)	13	38
2	R	376/400 (94%)	348 (93%)	28 (7%)	13	38
2	S	376/400 (94%)	348 (93%)	28 (7%)	13	38
2	T	376/400 (94%)	348 (93%)	28 (7%)	13	38
2	U	376/400 (94%)	348 (93%)	28 (7%)	13	38
2	V	376/400 (94%)	348 (93%)	28 (7%)	13	38
2	W	376/400 (94%)	348 (93%)	28 (7%)	13	38
2	X	376/400 (94%)	348 (93%)	28 (7%)	13	38
2	Y	376/400 (94%)	348 (93%)	28 (7%)	13	38
2	Z	376/400 (94%)	348 (93%)	28 (7%)	13	38

Continued on next page...

Continued from previous page...

Mol	Chain	Analysed	Rotameric	Outliers	Percentiles	
3	e	310/318 (98%)	305 (98%)	5 (2%)	62	79
4	b	53/62 (86%)	53 (100%)	0	100	100
4	d	53/62 (86%)	52 (98%)	1 (2%)	57	75
4	i	53/62 (86%)	53 (100%)	0	100	100
4	k	53/62 (86%)	53 (100%)	0	100	100
4	m	53/62 (86%)	53 (100%)	0	100	100
5	D	525/798 (66%)	524 (100%)	1 (0%)	93	96
5	F	542/798 (68%)	539 (99%)	3 (1%)	86	92
5	H	539/798 (68%)	538 (100%)	1 (0%)	93	96
5	N	539/798 (68%)	539 (100%)	0	100	100
5	a	101/798 (13%)	101 (100%)	0	100	100
5	h	88/798 (11%)	87 (99%)	1 (1%)	73	84
5	j	88/798 (11%)	88 (100%)	0	100	100
6	C	556/791 (70%)	553 (100%)	3 (0%)	88	93
6	E	574/791 (73%)	567 (99%)	7 (1%)	71	83
6	G	572/791 (72%)	570 (100%)	2 (0%)	92	95
6	M	572/791 (72%)	570 (100%)	2 (0%)	92	95
7	I	472/594 (80%)	471 (100%)	1 (0%)	93	96
7	K	509/594 (86%)	506 (99%)	3 (1%)	86	92
8	L	501/1546 (32%)	498 (99%)	3 (1%)	86	92
8	c	135/1546 (9%)	135 (100%)	0	100	100
All	All	11982/20324 (59%)	11610 (97%)	372 (3%)	43	62

All (372) residues with a non-rotameric sidechain are listed below:

Mol	Chain	Res	Type
2	1	10	LEU
2	1	25	LEU
2	1	50	VAL
2	1	56	ASP
2	1	57	ASP
2	1	78	LEU
2	1	109	SER
2	1	131	SER
2	1	151	SER

Continued on next page...

Continued from previous page...

Mol	Chain	Res	Type
2	1	168	THR
2	1	188	SER
2	1	201	CYS
2	1	222	ASN
2	1	237	SER
2	1	263	THR
2	1	267	HIS
2	1	274	THR
2	1	278	THR
2	1	296	ARG
2	1	298	LEU
2	1	316	CYS
2	1	328	VAL
2	1	333	VAL
2	1	367	LEU
2	1	374	SER
2	1	385	SER
2	1	424	SER
2	1	425	ARG
2	2	10	LEU
2	2	25	LEU
2	2	50	VAL
2	2	56	ASP
2	2	57	ASP
2	2	78	LEU
2	2	109	SER
2	2	131	SER
2	2	151	SER
2	2	168	THR
2	2	188	SER
2	2	201	CYS
2	2	222	ASN
2	2	237	SER
2	2	263	THR
2	2	267	HIS
2	2	274	THR
2	2	278	THR
2	2	296	ARG
2	2	298	LEU
2	2	316	CYS
2	2	328	VAL
2	2	333	VAL

Continued on next page...

Continued from previous page...

Mol	Chain	Res	Type
2	2	367	LEU
2	2	374	SER
2	2	385	SER
2	2	424	SER
2	2	425	ARG
3	e	105	LEU
3	e	129	THR
3	e	177	ARG
3	e	200	PHE
3	e	261	LEU
6	C	288	VAL
6	C	547	THR
6	C	827	LYS
5	D	277	VAL
6	E	255	SER
6	E	467	VAL
6	E	468	THR
6	E	562	SER
6	E	628	LEU
6	E	674	GLN
6	E	675	TRP
5	F	285	ARG
5	F	304	ILE
5	F	404	THR
6	G	467	VAL
6	G	628	LEU
5	H	629	SER
7	I	475	TYR
1	J	220	VAL
1	J	222	HIS
1	J	254	ASP
7	K	537	LEU
7	K	647	LEU
7	K	651	TYR
8	L	346	LEU
8	L	1637	CYS
8	L	1740	ARG
6	M	243	SER
6	M	563	THR
2	Q	10	LEU
2	Q	25	LEU
2	Q	50	VAL

Continued on next page...

Continued from previous page...

Mol	Chain	Res	Type
2	Q	56	ASP
2	Q	57	ASP
2	Q	78	LEU
2	Q	109	SER
2	Q	131	SER
2	Q	151	SER
2	Q	168	THR
2	Q	188	SER
2	Q	201	CYS
2	Q	222	ASN
2	Q	237	SER
2	Q	263	THR
2	Q	267	HIS
2	Q	274	THR
2	Q	278	THR
2	Q	296	ARG
2	Q	298	LEU
2	Q	316	CYS
2	Q	328	VAL
2	Q	333	VAL
2	Q	367	LEU
2	Q	374	SER
2	Q	385	SER
2	Q	424	SER
2	Q	425	ARG
2	R	10	LEU
2	R	25	LEU
2	R	50	VAL
2	R	56	ASP
2	R	57	ASP
2	R	78	LEU
2	R	109	SER
2	R	131	SER
2	R	151	SER
2	R	168	THR
2	R	188	SER
2	R	201	CYS
2	R	222	ASN
2	R	237	SER
2	R	263	THR
2	R	267	HIS
2	R	274	THR

Continued on next page...

Continued from previous page...

Mol	Chain	Res	Type
2	R	278	THR
2	R	296	ARG
2	R	298	LEU
2	R	316	CYS
2	R	328	VAL
2	R	333	VAL
2	R	367	LEU
2	R	374	SER
2	R	385	SER
2	R	424	SER
2	R	425	ARG
2	S	10	LEU
2	S	25	LEU
2	S	50	VAL
2	S	56	ASP
2	S	57	ASP
2	S	78	LEU
2	S	109	SER
2	S	131	SER
2	S	151	SER
2	S	168	THR
2	S	188	SER
2	S	201	CYS
2	S	222	ASN
2	S	237	SER
2	S	263	THR
2	S	267	HIS
2	S	274	THR
2	S	278	THR
2	S	296	ARG
2	S	298	LEU
2	S	316	CYS
2	S	328	VAL
2	S	333	VAL
2	S	367	LEU
2	S	374	SER
2	S	385	SER
2	S	424	SER
2	S	425	ARG
2	T	10	LEU
2	T	25	LEU
2	T	50	VAL

Continued on next page...

Continued from previous page...

Mol	Chain	Res	Type
2	T	56	ASP
2	T	57	ASP
2	T	78	LEU
2	T	109	SER
2	T	131	SER
2	T	151	SER
2	T	168	THR
2	T	188	SER
2	T	201	CYS
2	T	222	ASN
2	T	237	SER
2	T	263	THR
2	T	267	HIS
2	T	274	THR
2	T	278	THR
2	T	296	ARG
2	T	298	LEU
2	T	316	CYS
2	T	328	VAL
2	T	333	VAL
2	T	367	LEU
2	T	374	SER
2	T	385	SER
2	T	424	SER
2	T	425	ARG
2	U	10	LEU
2	U	25	LEU
2	U	50	VAL
2	U	56	ASP
2	U	57	ASP
2	U	78	LEU
2	U	109	SER
2	U	131	SER
2	U	151	SER
2	U	168	THR
2	U	188	SER
2	U	201	CYS
2	U	222	ASN
2	U	237	SER
2	U	263	THR
2	U	267	HIS
2	U	274	THR

Continued on next page...

Continued from previous page...

Mol	Chain	Res	Type
2	U	278	THR
2	U	296	ARG
2	U	298	LEU
2	U	316	CYS
2	U	328	VAL
2	U	333	VAL
2	U	367	LEU
2	U	374	SER
2	U	385	SER
2	U	424	SER
2	U	425	ARG
2	V	10	LEU
2	V	25	LEU
2	V	50	VAL
2	V	56	ASP
2	V	57	ASP
2	V	78	LEU
2	V	109	SER
2	V	131	SER
2	V	151	SER
2	V	168	THR
2	V	188	SER
2	V	201	CYS
2	V	222	ASN
2	V	237	SER
2	V	263	THR
2	V	267	HIS
2	V	274	THR
2	V	278	THR
2	V	296	ARG
2	V	298	LEU
2	V	316	CYS
2	V	328	VAL
2	V	333	VAL
2	V	367	LEU
2	V	374	SER
2	V	385	SER
2	V	424	SER
2	V	425	ARG
2	W	10	LEU
2	W	25	LEU
2	W	50	VAL

Continued on next page...

Continued from previous page...

Mol	Chain	Res	Type
2	W	56	ASP
2	W	57	ASP
2	W	78	LEU
2	W	109	SER
2	W	131	SER
2	W	151	SER
2	W	168	THR
2	W	188	SER
2	W	201	CYS
2	W	222	ASN
2	W	237	SER
2	W	263	THR
2	W	267	HIS
2	W	274	THR
2	W	278	THR
2	W	296	ARG
2	W	298	LEU
2	W	316	CYS
2	W	328	VAL
2	W	333	VAL
2	W	367	LEU
2	W	374	SER
2	W	385	SER
2	W	424	SER
2	W	425	ARG
2	X	10	LEU
2	X	25	LEU
2	X	50	VAL
2	X	56	ASP
2	X	57	ASP
2	X	78	LEU
2	X	109	SER
2	X	131	SER
2	X	151	SER
2	X	168	THR
2	X	188	SER
2	X	201	CYS
2	X	222	ASN
2	X	237	SER
2	X	263	THR
2	X	267	HIS
2	X	274	THR

Continued on next page...

Continued from previous page...

Mol	Chain	Res	Type
2	X	278	THR
2	X	296	ARG
2	X	298	LEU
2	X	316	CYS
2	X	328	VAL
2	X	333	VAL
2	X	367	LEU
2	X	374	SER
2	X	385	SER
2	X	424	SER
2	X	425	ARG
2	Y	10	LEU
2	Y	25	LEU
2	Y	50	VAL
2	Y	56	ASP
2	Y	57	ASP
2	Y	78	LEU
2	Y	109	SER
2	Y	131	SER
2	Y	151	SER
2	Y	168	THR
2	Y	188	SER
2	Y	201	CYS
2	Y	222	ASN
2	Y	237	SER
2	Y	263	THR
2	Y	267	HIS
2	Y	274	THR
2	Y	278	THR
2	Y	296	ARG
2	Y	298	LEU
2	Y	316	CYS
2	Y	328	VAL
2	Y	333	VAL
2	Y	367	LEU
2	Y	374	SER
2	Y	385	SER
2	Y	424	SER
2	Y	425	ARG
2	Z	10	LEU
2	Z	25	LEU
2	Z	50	VAL

Continued on next page...

Continued from previous page...

Mol	Chain	Res	Type
2	Z	56	ASP
2	Z	57	ASP
2	Z	78	LEU
2	Z	109	SER
2	Z	131	SER
2	Z	151	SER
2	Z	168	THR
2	Z	188	SER
2	Z	201	CYS
2	Z	222	ASN
2	Z	237	SER
2	Z	263	THR
2	Z	267	HIS
2	Z	274	THR
2	Z	278	THR
2	Z	296	ARG
2	Z	298	LEU
2	Z	316	CYS
2	Z	328	VAL
2	Z	333	VAL
2	Z	367	LEU
2	Z	374	SER
2	Z	385	SER
2	Z	424	SER
2	Z	425	ARG
5	h	31	GLN
4	d	46	ILE

Sometimes sidechains can be flipped to improve hydrogen bonding and reduce clashes. All (179) such sidechains are listed below:

Mol	Chain	Res	Type
2	1	29	HIS
2	1	59	HIS
2	1	167	GLN
2	1	229	ASN
2	1	325	GLN
2	1	338	GLN
2	2	29	HIS
2	2	59	HIS
2	2	167	GLN
2	2	229	ASN
2	2	251	ASN

Continued on next page...

Continued from previous page...

Mol	Chain	Res	Type
2	2	325	GLN
2	2	334	HIS
2	2	338	GLN
3	e	12	ASN
3	e	88	HIS
3	e	111	ASN
3	e	115	ASN
3	e	296	ASN
5	a	120	GLN
6	C	151	GLN
6	C	444	GLN
6	C	524	GLN
6	C	585	GLN
6	C	644	HIS
6	C	694	GLN
6	C	823	ASN
5	D	259	GLN
5	D	343	HIS
5	D	401	HIS
5	D	444	HIS
5	D	494	HIS
5	D	576	HIS
5	D	609	ASN
5	D	684	HIS
5	D	687	ASN
5	D	883	ASN
6	E	236	GLN
6	E	242	GLN
6	E	289	ASN
6	E	309	GLN
6	E	412	HIS
6	E	438	GLN
6	E	565	ASN
6	E	585	GLN
6	E	631	ASN
6	E	741	ASN
5	F	269	ASN
5	F	302	ASN
5	F	322	GLN
5	F	330	GLN
5	F	609	ASN
5	F	713	HIS

Continued on next page...

Continued from previous page...

Mol	Chain	Res	Type
5	F	739	GLN
5	F	781	GLN
5	F	855	GLN
6	G	166	ASN
6	G	309	GLN
6	G	329	GLN
6	G	438	GLN
6	G	694	GLN
6	G	741	ASN
6	G	862	ASN
5	H	310	GLN
5	H	774	GLN
5	H	805	GLN
5	H	859	GLN
5	H	883	ASN
7	I	123	ASN
7	I	186	GLN
7	I	316	GLN
7	I	327	GLN
7	I	370	GLN
7	I	398	GLN
7	I	476	ASN
7	I	504	HIS
7	I	571	GLN
7	I	622	GLN
1	J	269	GLN
1	J	328	GLN
1	J	362	GLN
1	J	456	GLN
1	J	567	GLN
1	J	879	GLN
1	J	881	HIS
1	J	892	HIS
1	J	895	ASN
7	K	65	HIS
7	K	68	GLN
7	K	121	HIS
7	K	378	HIS
7	K	397	GLN
7	K	409	ASN
7	K	476	ASN
7	K	540	GLN

Continued on next page...

Continued from previous page...

Mol	Chain	Res	Type
8	L	327	HIS
8	L	340	GLN
8	L	507	GLN
8	L	512	ASN
8	L	517	HIS
8	L	603	ASN
8	L	1568	HIS
8	L	1657	GLN
8	L	1659	GLN
8	L	1679	GLN
8	L	1742	GLN
8	L	1770	ASN
6	M	465	HIS
6	M	493	ASN
6	M	688	ASN
6	M	691	GLN
6	M	760	ASN
5	N	479	GLN
5	N	531	GLN
5	N	687	ASN
5	N	702	HIS
2	Q	29	HIS
2	Q	59	HIS
2	Q	167	GLN
2	Q	229	ASN
2	Q	251	ASN
2	Q	325	GLN
2	Q	334	HIS
2	R	29	HIS
2	R	59	HIS
2	R	167	GLN
2	R	229	ASN
2	R	325	GLN
2	S	29	HIS
2	S	59	HIS
2	S	167	GLN
2	S	229	ASN
2	S	325	GLN
2	S	338	GLN
2	T	29	HIS
2	T	59	HIS
2	T	167	GLN

Continued on next page...

Continued from previous page...

Mol	Chain	Res	Type
2	T	219	HIS
2	T	229	ASN
2	T	325	GLN
2	T	338	GLN
2	U	29	HIS
2	U	59	HIS
2	U	167	GLN
2	U	229	ASN
2	U	325	GLN
2	V	29	HIS
2	V	59	HIS
2	V	167	GLN
2	V	229	ASN
2	V	325	GLN
2	W	29	HIS
2	W	59	HIS
2	W	167	GLN
2	W	197	GLN
2	W	229	ASN
2	W	325	GLN
2	X	29	HIS
2	X	59	HIS
2	X	167	GLN
2	X	229	ASN
2	X	251	ASN
2	X	325	GLN
2	Y	29	HIS
2	Y	59	HIS
2	Y	167	GLN
2	Y	229	ASN
2	Y	325	GLN
2	Y	338	GLN
2	Z	29	HIS
2	Z	59	HIS
2	Z	167	GLN
2	Z	229	ASN
2	Z	325	GLN
2	Z	338	GLN
4	d	53	GLN
8	c	29	ASN
8	c	161	GLN
5	j	84	GLN

5.3.3 RNA [i](#)

There are no RNA molecules in this entry.

5.4 Non-standard residues in protein, DNA, RNA chains [i](#)

There are no non-standard protein/DNA/RNA residues in this entry.

5.5 Carbohydrates [i](#)

There are no monosaccharides in this entry.

5.6 Ligand geometry [i](#)

There are no ligands in this entry.

5.7 Other polymers [i](#)

There are no such residues in this entry.

5.8 Polymer linkage issues [i](#)

There are no chain breaks in this entry.

6 Map visualisation [i](#)

This section contains visualisations of the EMDB entry EMD-14013. These allow visual inspection of the internal detail of the map and identification of artifacts.

No raw map or half-maps were deposited for this entry and therefore no images, graphs, etc. pertaining to the raw map can be shown.

6.1 Orthogonal projections [i](#)

6.1.1 Primary map

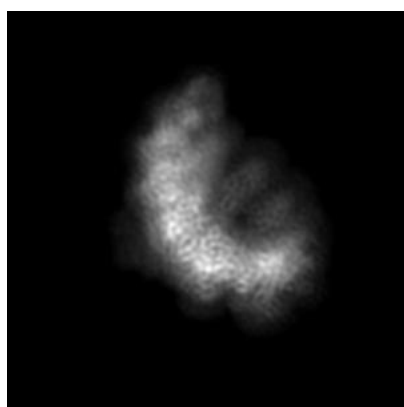

X

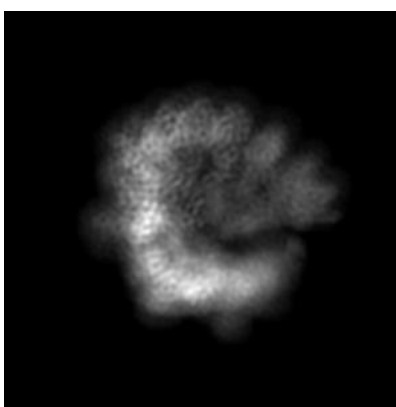

Y

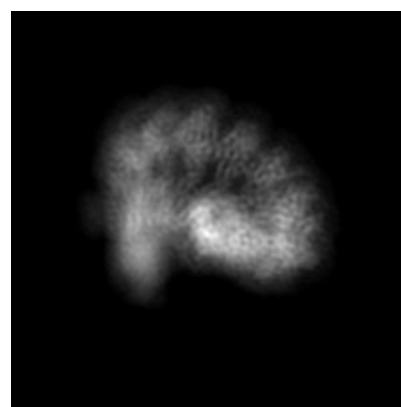

Z

The images above show the map projected in three orthogonal directions.

6.2 Central slices [i](#)

6.2.1 Primary map

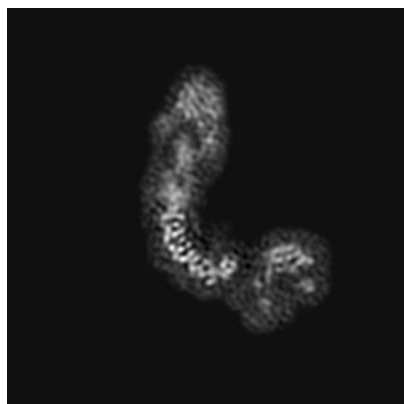

X Index: 100

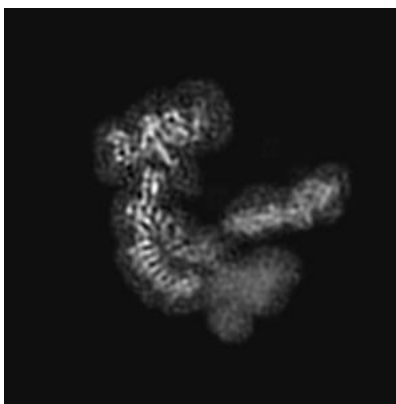

Y Index: 100

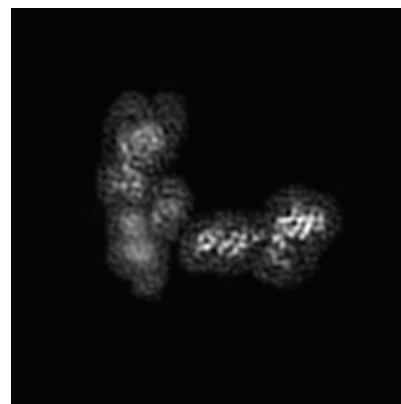

Z Index: 100

The images above show central slices of the map in three orthogonal directions.

6.3 Largest variance slices [i](#)

6.3.1 Primary map

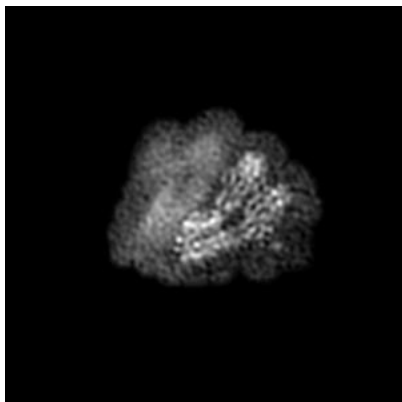

X Index: 63

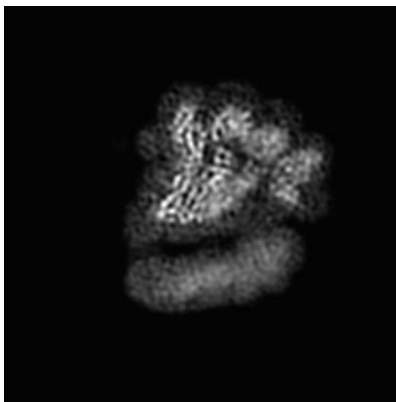

Y Index: 82

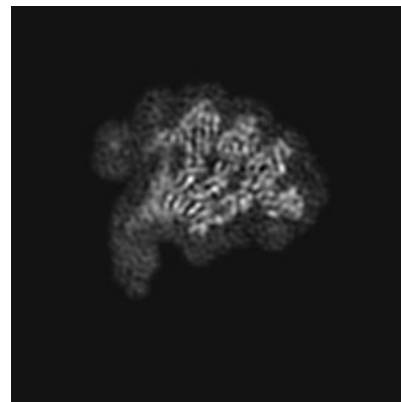

Z Index: 71

The images above show the largest variance slices of the map in three orthogonal directions.

6.4 Orthogonal surface views [i](#)

6.4.1 Primary map



X

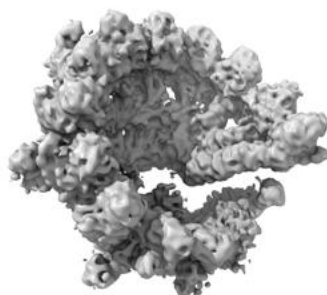

Y

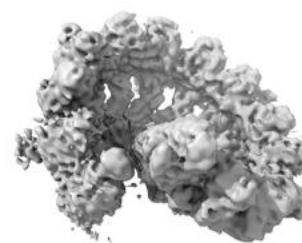

Z

The images above show the 3D surface view of the map at the recommended contour level 0.0357. These images, in conjunction with the slice images, may facilitate assessment of whether an appropriate contour level has been provided.

6.5 Mask visualisation

This section was not generated. No masks/segmentation were deposited.

7 Map analysis [i](#)

This section contains the results of statistical analysis of the map.

7.1 Map-value distribution [i](#)

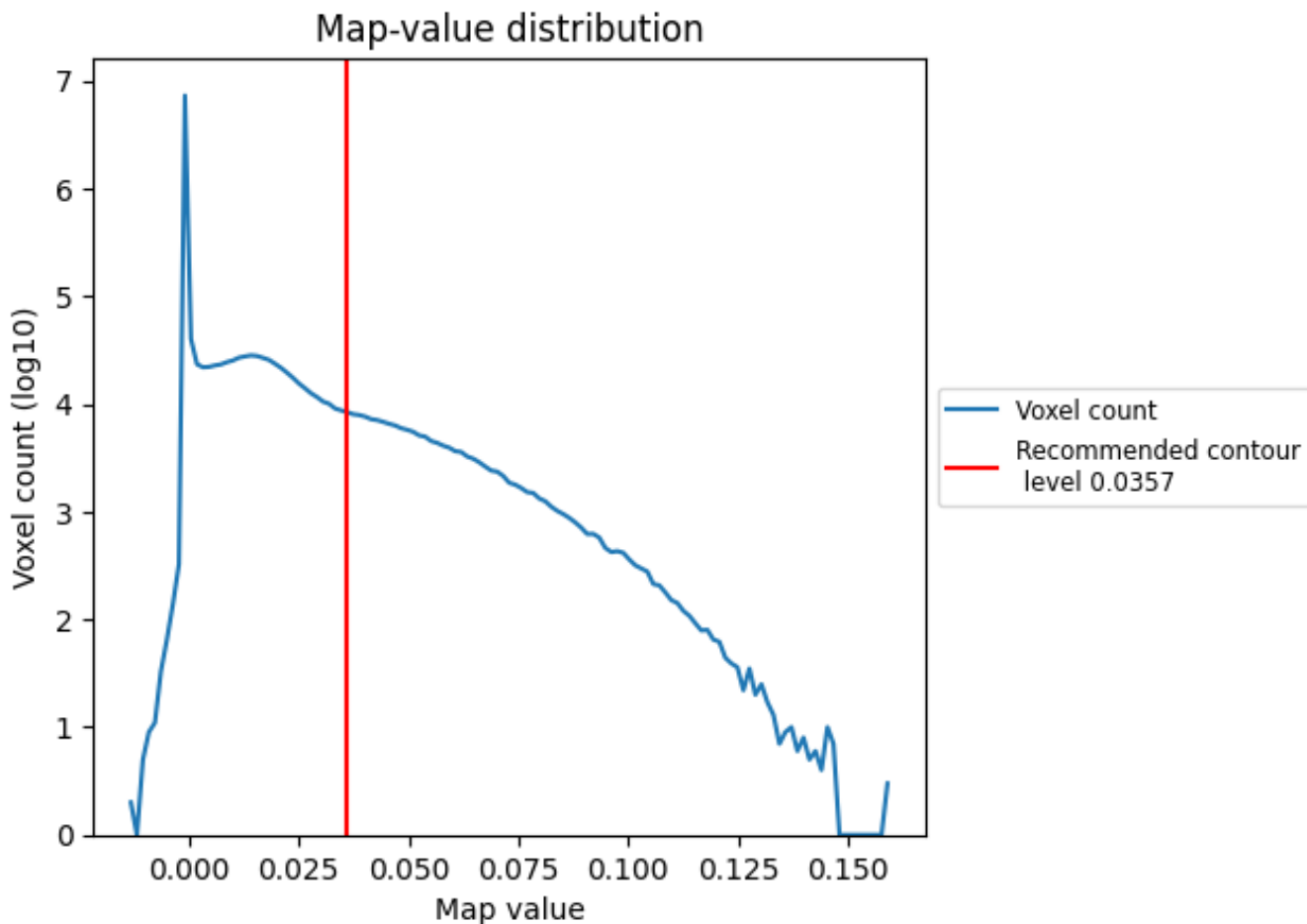

The map-value distribution is plotted in 128 intervals along the x-axis. The y-axis is logarithmic. A spike in this graph at zero usually indicates that the volume has been masked.

7.2 Volume estimate [\(i\)](#)

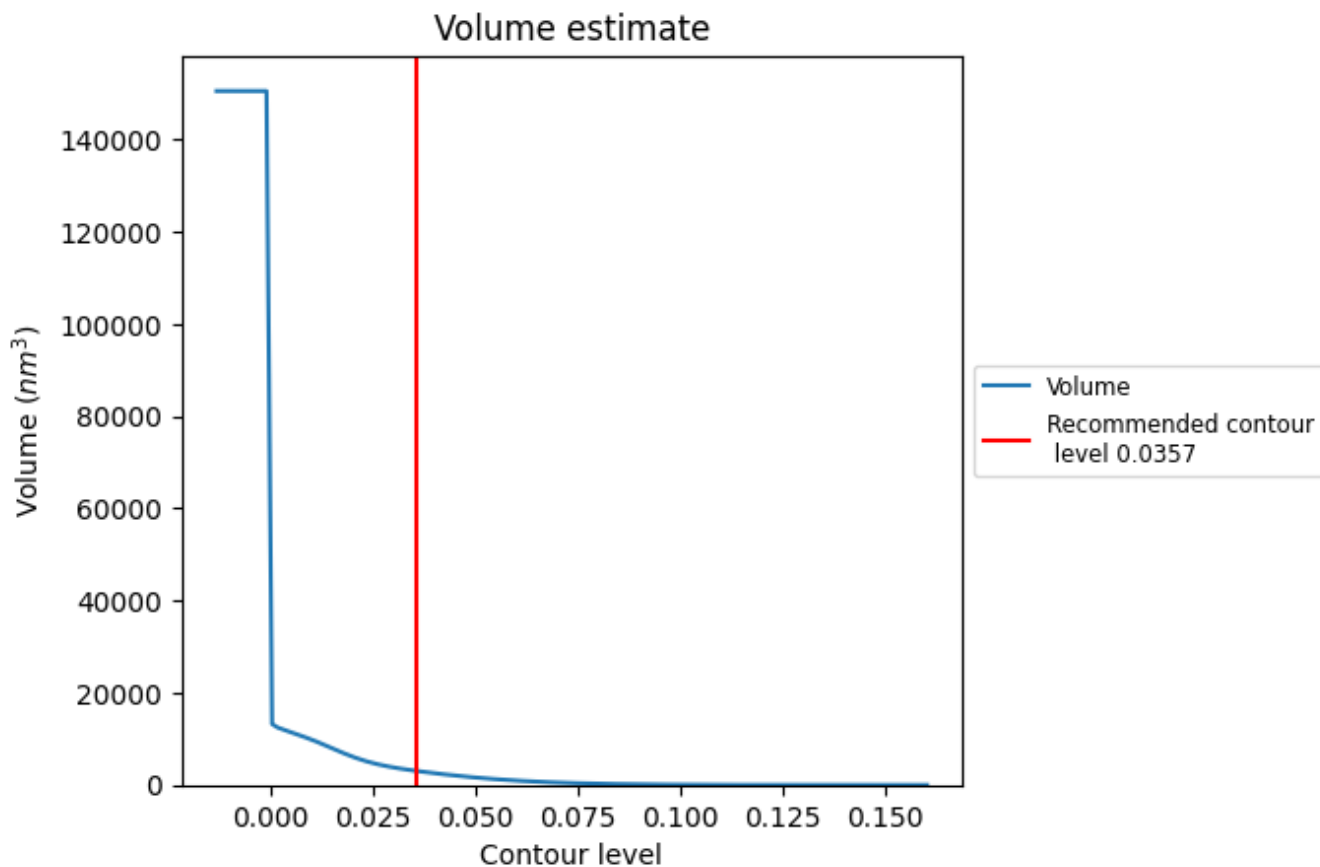

The volume at the recommended contour level is 3032 nm^3 ; this corresponds to an approximate mass of 2739 kDa.

The volume estimate graph shows how the enclosed volume varies with the contour level. The recommended contour level is shown as a vertical line and the intersection between the line and the curve gives the volume of the enclosed surface at the given level.

7.3 Rotationally averaged power spectrum [i](#)

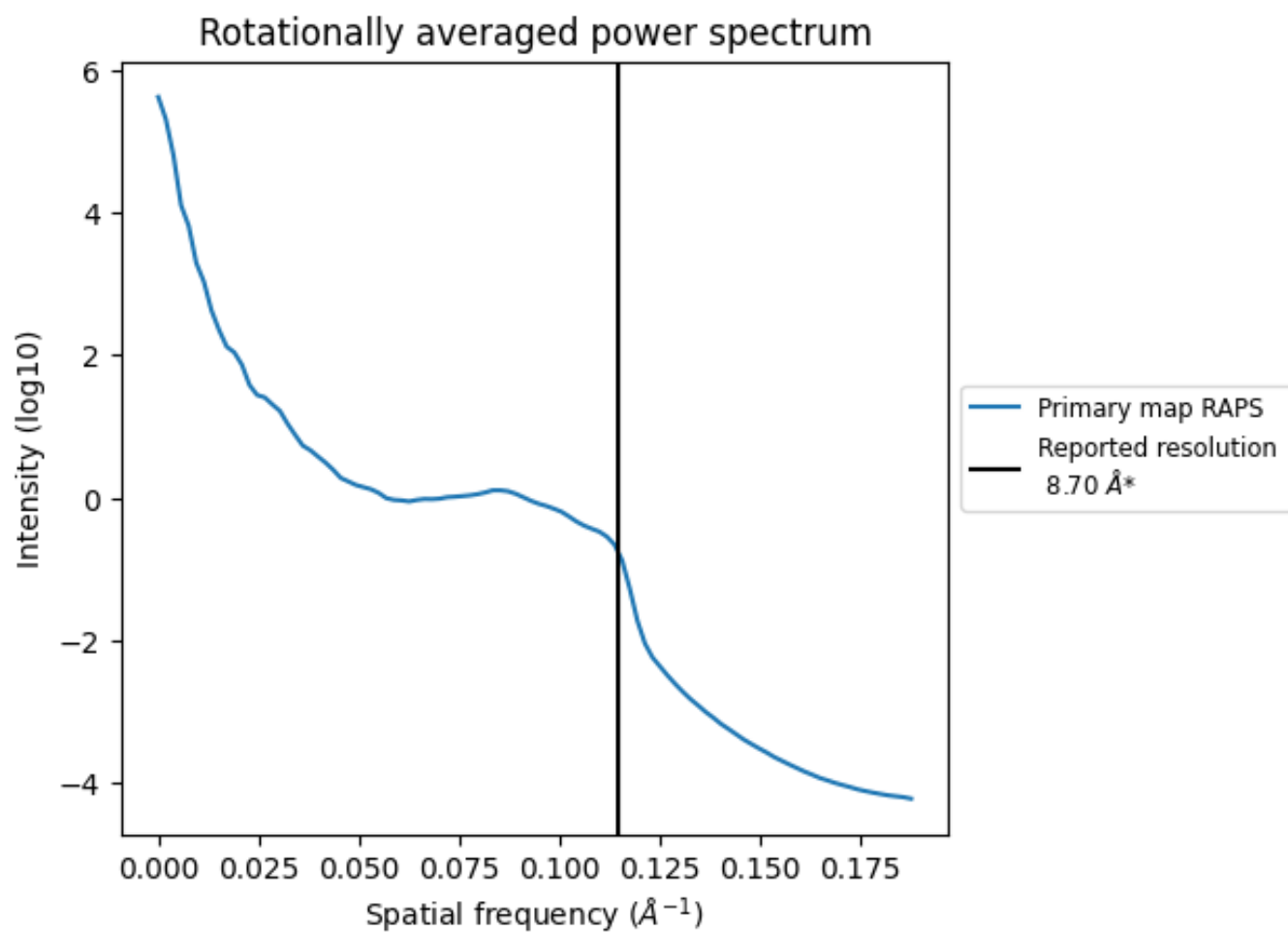

*Reported resolution corresponds to spatial frequency of 0.115\AA^{-1}

8 Fourier-Shell correlation

This section was not generated. No FSC curve or half-maps provided.

9 Map-model fit [i](#)

This section contains information regarding the fit between EMDB map EMD-14013 and PDB model 7QJ8. Per-residue inclusion information can be found in section 3 on page 8.

9.1 Map-model overlay [i](#)

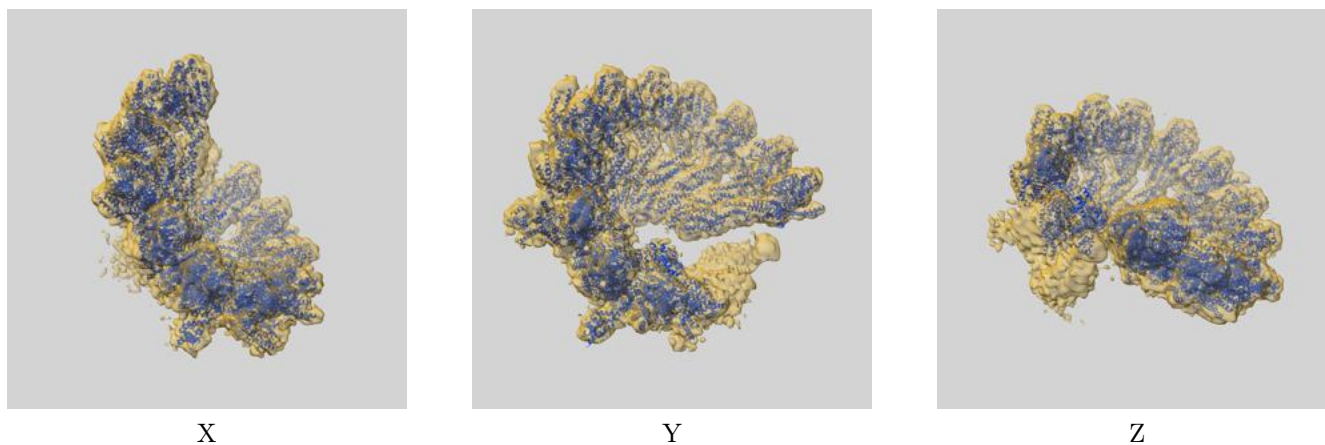

The images above show the 3D surface view of the map at the recommended contour level 0.0357 at 50% transparency in yellow overlaid with a ribbon representation of the model coloured in blue. These images allow for the visual assessment of the quality of fit between the atomic model and the map.

9.2 Atom inclusion [i](#)

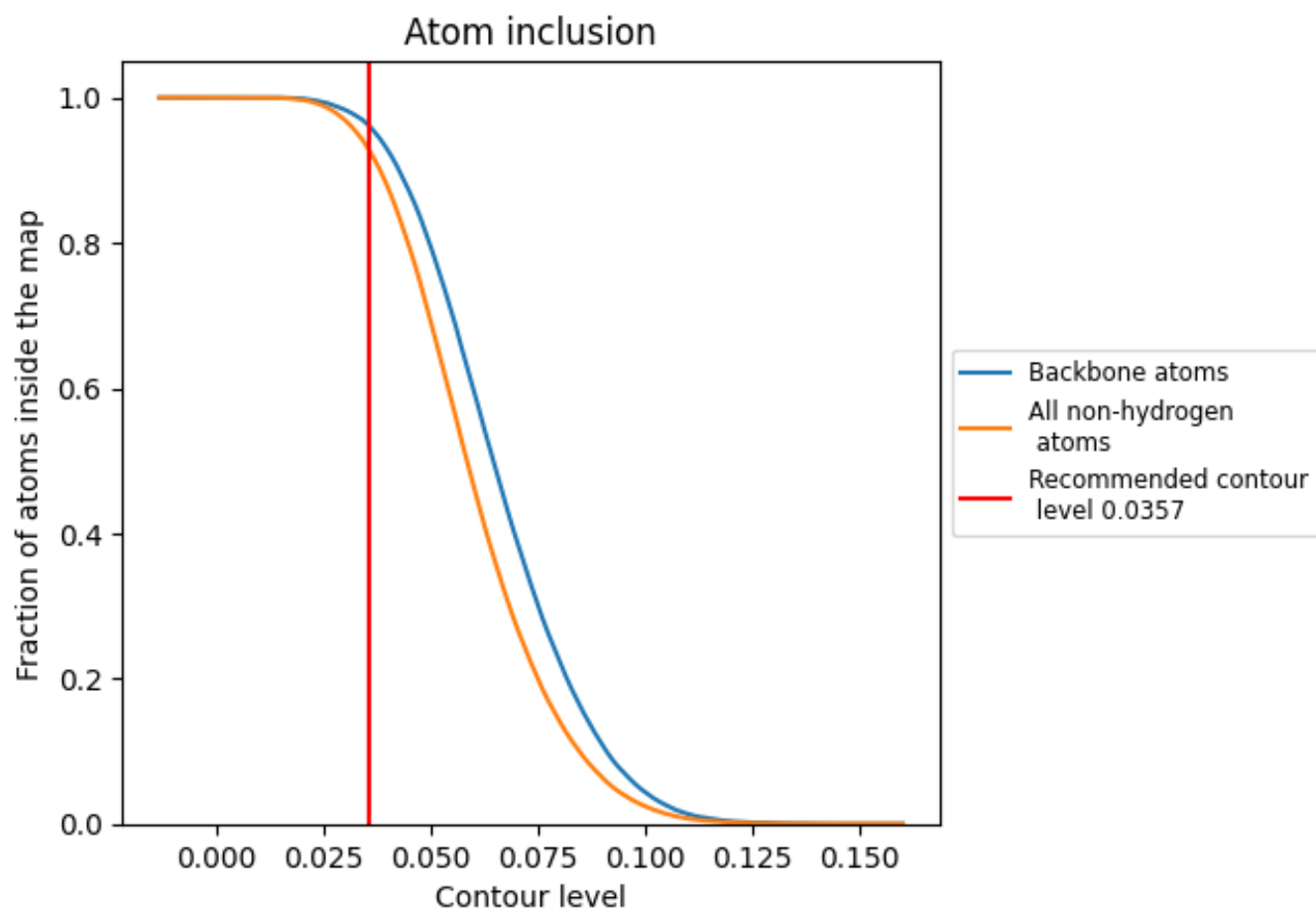

At the recommended contour level, 96% of all backbone atoms, 93% of all non-hydrogen atoms, are inside the map.