



wwPDB EM Validation Summary Report ⓘ

Jan 29, 2022 – 06:18 am GMT

PDB ID : 7QJA
EMDB ID : EMD-14015
Title : Structure of recombinant human gamma-Tubulin Ring Complex 12-spoked assembly intermediate (spokes 1-12, homogeneous dataset)
Authors : Zupa, E.; Pfeffer, S.
Deposited on : 2021-12-16
Resolution : 9.20 Å (reported)
Based on initial models : 6X0U, 6V6S, 6L81, 7AS4

This is a wwPDB EM Validation Summary Report for a publicly released PDB entry.

We welcome your comments at validation@mail.wwpdb.org

A user guide is available at

<https://www.wwpdb.org/validation/2017/EMValidationReportHelp>

with specific help available everywhere you see the ⓘ symbol.

The following versions of software and data (see [references ⓘ](#)) were used in the production of this report:

EMDB validation analysis : 0.0.0.dev97
MolProbity : 4.02b-467
Percentile statistics : 20191225.v01 (using entries in the PDB archive December 25th 2019)
Ideal geometry (proteins) : Engh & Huber (2001)
Ideal geometry (DNA, RNA) : Parkinson et al. (1996)
Validation Pipeline (wwPDB-VP) : 2.26

1 Overall quality at a glance

The following experimental techniques were used to determine the structure:
ELECTRON MICROSCOPY

The reported resolution of this entry is 9.20 Å.

Percentile scores (ranging between 0-100) for global validation metrics of the entry are shown in the following graphic. The table shows the number of entries on which the scores are based.

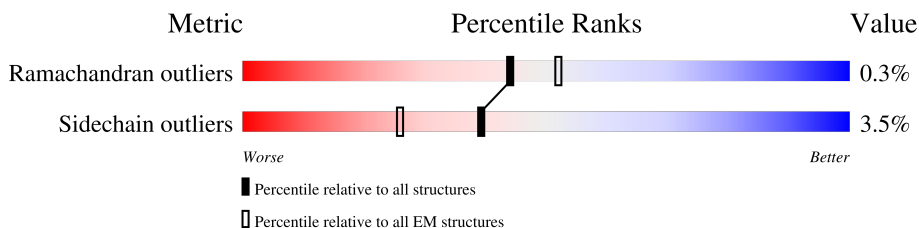

Metric	Whole archive (#Entries)	EM structures (#Entries)
Ramachandran outliers	154571	4023
Sidechain outliers	154315	3826

The table below summarises the geometric issues observed across the polymeric chains and their fit to the map. The red, orange, yellow and green segments of the bar indicate the fraction of residues that contain outliers for ≥ 3 , 2, 1 and 0 types of geometric quality criteria respectively. A grey segment represents the fraction of residues that are not modelled. The numeric value for each fraction is indicated below the corresponding segment, with a dot representing fractions $\leq 5\%$. The upper red bar (where present) indicates the fraction of residues that have poor fit to the EM map (all-atom inclusion $< 40\%$). The numeric value is given above the bar.

Mol	Chain	Length	Quality of chain
1	e	375	
2	J	1024	
2	l	1024	
3	B	907	
3	D	907	
3	F	907	
3	H	907	
3	a	907	
3	f	907	



Continued on next page...

Continued from previous page...

Mol	Chain	Length	Quality of chain
3	h	907	11% 89%
3	j	907	11% 88%
4	A	902	6% 67% 32%
4	C	902	6% 68% 31%
4	E	902	6% 68% 29%
4	G	902	6% 70% 29%
5	I	667	6% 76% 22%
5	K	667	6% 83% 16%
6	L	1819	30% 69%
6	c	1819	9% 91%
7	b	82	9% 78% 21%
7	d	82	28% 72% 28%
7	g	82	22% 79% 21%
7	i	82	24% 79% 21%
7	k	82	13% 79% 21%
7	m	82	5% 77% 21%
8	O	451	18% 86% 7% 7%
8	P	451	25% 86% 7% 7%
8	Q	451	21% 86% 7% 7%
8	R	451	12% 86% 7% 7%
8	S	451	8% 86% 7% 7%
8	T	451	6% 86% 7% 7%
8	U	451	6% 86% 7% 7%
8	V	451	86% 7% 7%
8	W	451	6% 86% 7% 7%

Continued on next page...

Continued from previous page...

Mol	Chain	Length	Quality of chain
8	X	451	 86% 7% 7%
8	Y	451	 7% 86% 7% 7%
8	Z	451	 14% 86% 7% 7%

2 Entry composition [i](#)

There are 8 unique types of molecules in this entry. The entry contains 109569 atoms, of which 0 are hydrogens and 0 are deuteriums.

In the tables below, the AltConf column contains the number of residues with at least one atom in alternate conformation and the Trace column contains the number of residues modelled with at most 2 atoms.

- Molecule 1 is a protein called actin, cytoplasmic 1.

Mol	Chain	Residues	Atoms					AltConf	Trace
			Total	C	N	O	S		
1	e	364	2847	1803	476	548	20	0	0

- Molecule 2 is a protein called Gamma-tubulin complex component 5.

Mol	Chain	Residues	Atoms					AltConf	Trace
			Total	C	N	O	S		
2	I	108	847	539	150	157	1	0	0
2	J	534	4429	2893	737	776	23	0	0

- Molecule 3 is a protein called Gamma-tubulin complex component 3.

Mol	Chain	Residues	Atoms					AltConf	Trace
			Total	C	N	O	S		
3	B	610	5029	3203	888	913	25	0	0
3	D	581	4796	3061	842	868	25	0	0
3	F	599	4941	3151	871	894	25	0	0
3	H	594	4907	3130	864	888	25	0	0
3	a	116	933	591	171	169	2	0	0
3	f	99	803	509	148	144	2	0	0
3	h	99	803	509	148	144	2	0	0
3	j	107	843	533	156	152	2	0	0

- Molecule 4 is a protein called Gamma-tubulin complex component 2.

Mol	Chain	Residues	Atoms					AltConf	Trace
4	C	620	Total	C	N	O	S	0	0
			5044	3257	845	910	32		
4	E	638	Total	C	N	O	S	0	0
			5202	3354	873	942	33		
4	G	640	Total	C	N	O	S	0	0
			5206	3354	875	944	33		
4	A	613	Total	C	N	O	S	0	0
			4978	3212	831	903	32		

- Molecule 5 is a protein called Gamma-tubulin complex component 4.

Mol	Chain	Residues	Atoms					AltConf	Trace
5	I	521	Total	C	N	O	S	0	0
			4225	2737	720	750	18		
5	K	562	Total	C	N	O	S	0	0
			4579	2964	781	816	18		

- Molecule 6 is a protein called Gamma-tubulin complex component 6.

Mol	Chain	Residues	Atoms					AltConf	Trace
6	L	566	Total	C	N	O	S	0	0
			4587	3000	773	789	25		
6	c	158	Total	C	N	O	S	0	0
			1220	771	209	232	8		

- Molecule 7 is a protein called Mitotic-spindle organizing protein 1.

Mol	Chain	Residues	Atoms					AltConf	Trace
7	b	65	Total	C	N	O	S	0	0
			484	299	85	96	4		
7	g	65	Total	C	N	O	S	0	0
			484	299	85	96	4		
7	i	65	Total	C	N	O	S	0	0
			484	299	85	96	4		
7	k	65	Total	C	N	O	S	0	0
			484	299	85	96	4		
7	m	65	Total	C	N	O	S	0	0
			484	299	85	96	4		
7	d	59	Total	C	N	O	S	0	0
			454	281	79	90	4		

- Molecule 8 is a protein called Tubulin gamma-1 chain.

Mol	Chain	Residues	Atoms					AltConf	Trace
8	O	420	Total 3373	C 2134	N 586	O 638	S 15	0	0
8	P	420	Total 3373	C 2134	N 586	O 638	S 15	0	0
8	Q	420	Total 3373	C 2134	N 586	O 638	S 15	0	0
8	R	420	Total 3373	C 2134	N 586	O 638	S 15	0	0
8	S	420	Total 3373	C 2134	N 586	O 638	S 15	0	0
8	T	420	Total 3373	C 2134	N 586	O 638	S 15	0	0
8	U	420	Total 3373	C 2134	N 586	O 638	S 15	0	0
8	V	420	Total 3373	C 2134	N 586	O 638	S 15	0	0
8	W	420	Total 3373	C 2134	N 586	O 638	S 15	0	0
8	X	420	Total 3373	C 2134	N 586	O 638	S 15	0	0
8	Y	420	Total 3373	C 2134	N 586	O 638	S 15	0	0
8	Z	420	Total 3373	C 2134	N 586	O 638	S 15	0	0

3 Residue-property plots [i](#)

These plots are drawn for all protein, RNA, DNA and oligosaccharide chains in the entry. The first graphic for a chain summarises the proportions of the various outlier classes displayed in the second graphic. The second graphic shows the sequence view annotated by issues in geometry and atom inclusion in map density. Residues are color-coded according to the number of geometric quality criteria for which they contain at least one outlier: green = 0, yellow = 1, orange = 2 and red = 3 or more. A red diamond above a residue indicates a poor fit to the EM map for this residue (all-atom inclusion < 40%). Stretches of 2 or more consecutive residues without any outlier are shown as a green connector. Residues present in the sample, but not in the model, are shown in grey.

- Molecule 1: actin, cytoplasmic 1

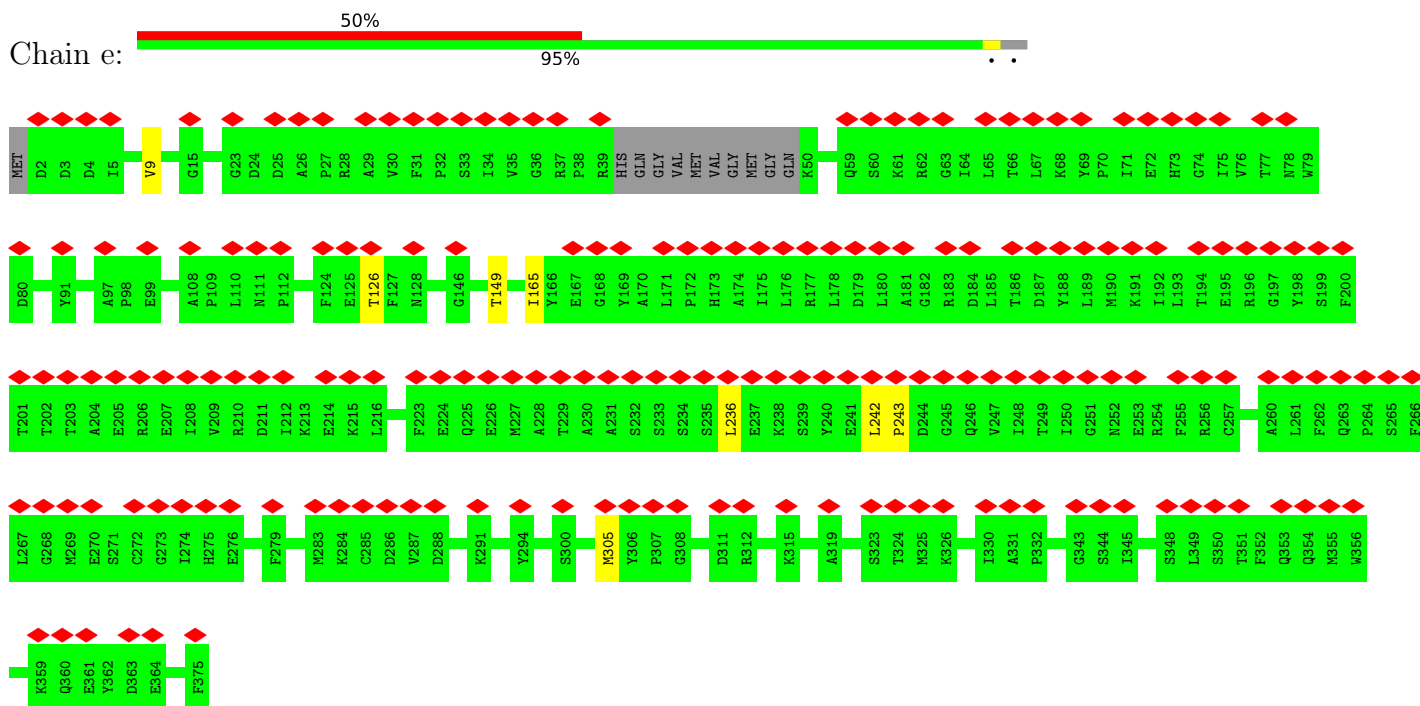

- Molecule 2: Gamma-tubulin complex component 5

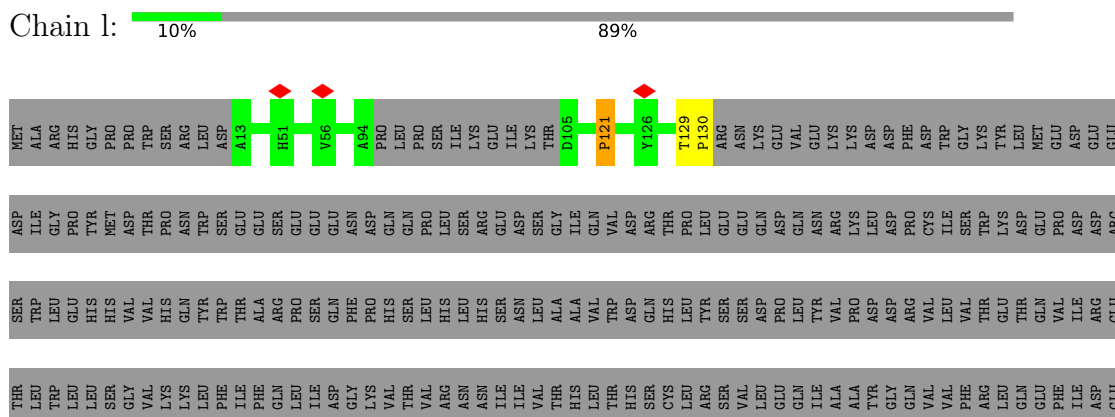

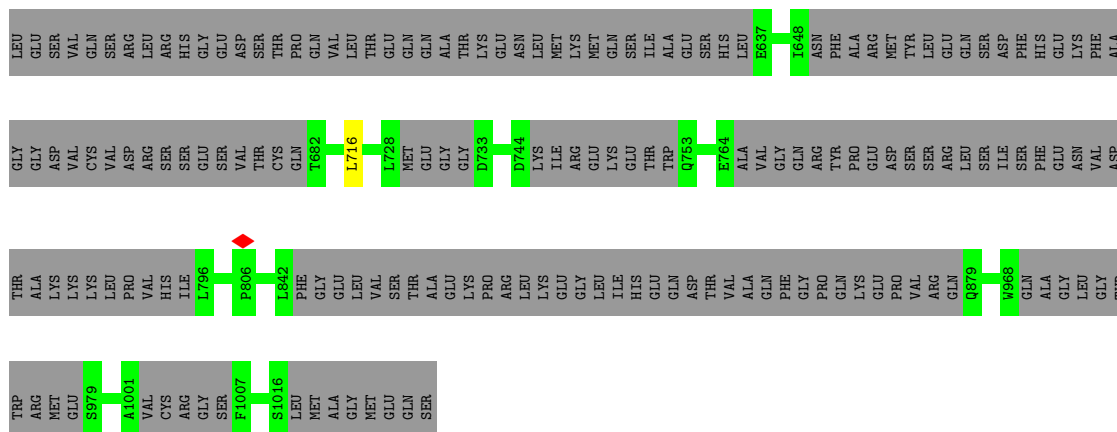

• Molecule 3: Gamma-tubulin complex component 3

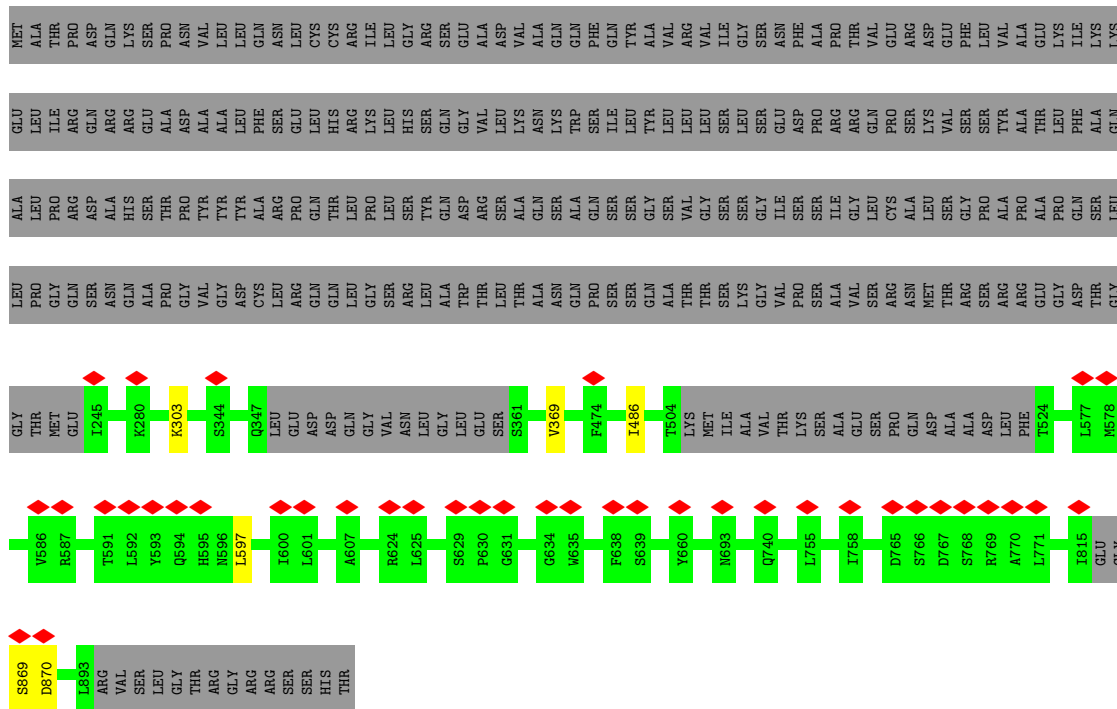

• Molecule 3: Gamma-tubulin complex component 3

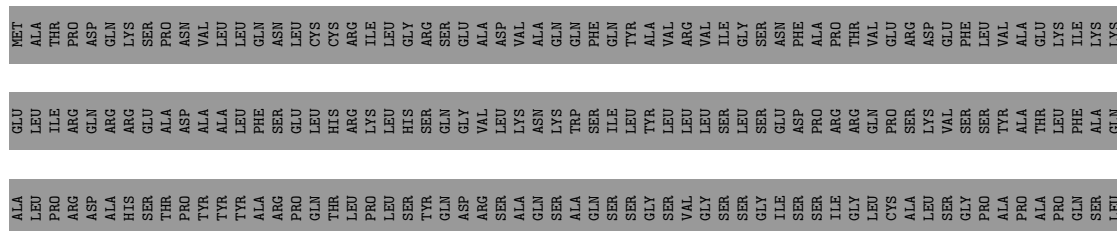

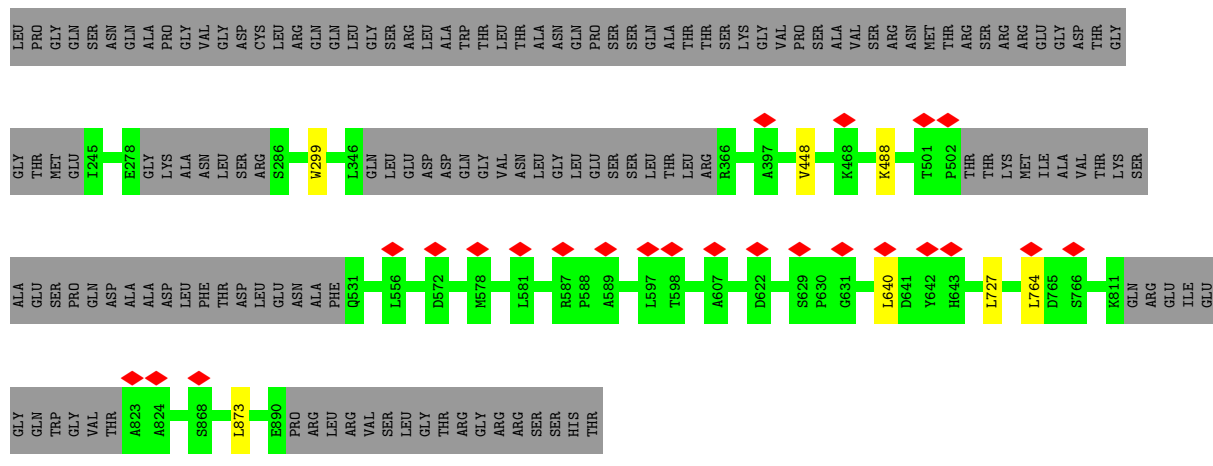

• Molecule 3: Gamma-tubulin complex component 3

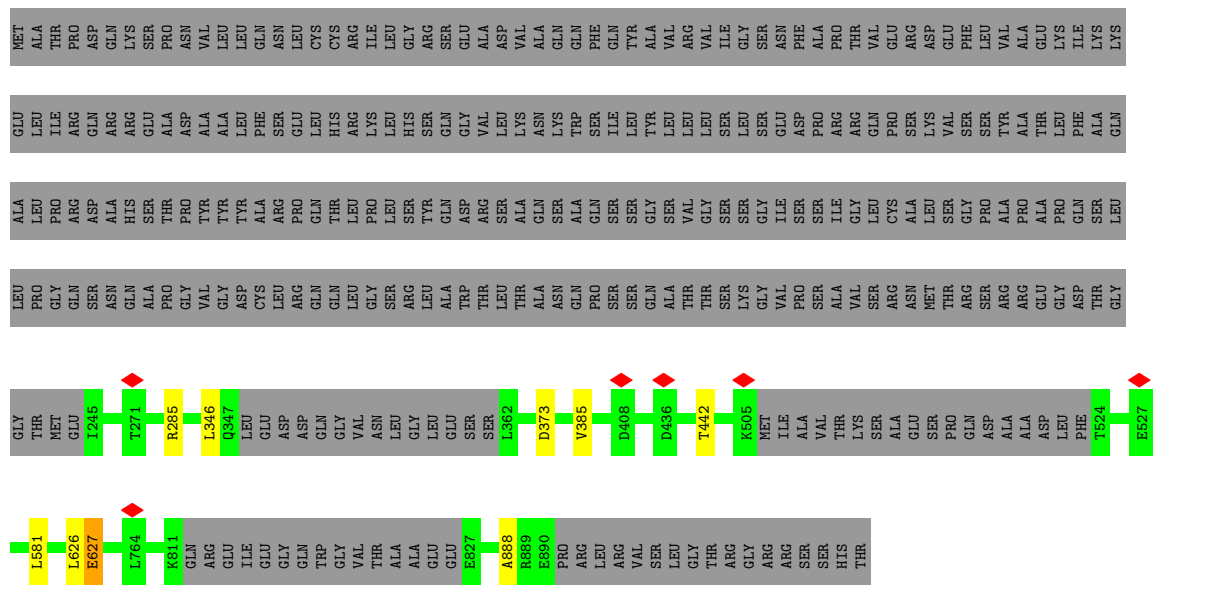

• Molecule 3: Gamma-tubulin complex component 3

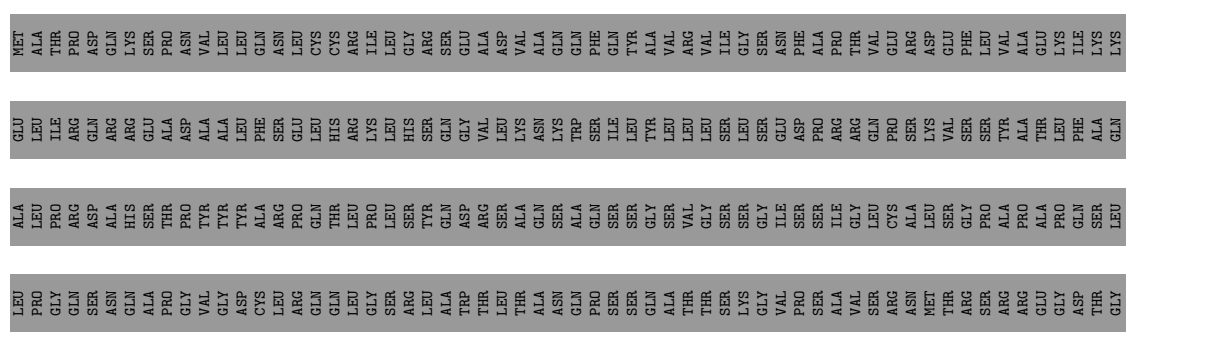

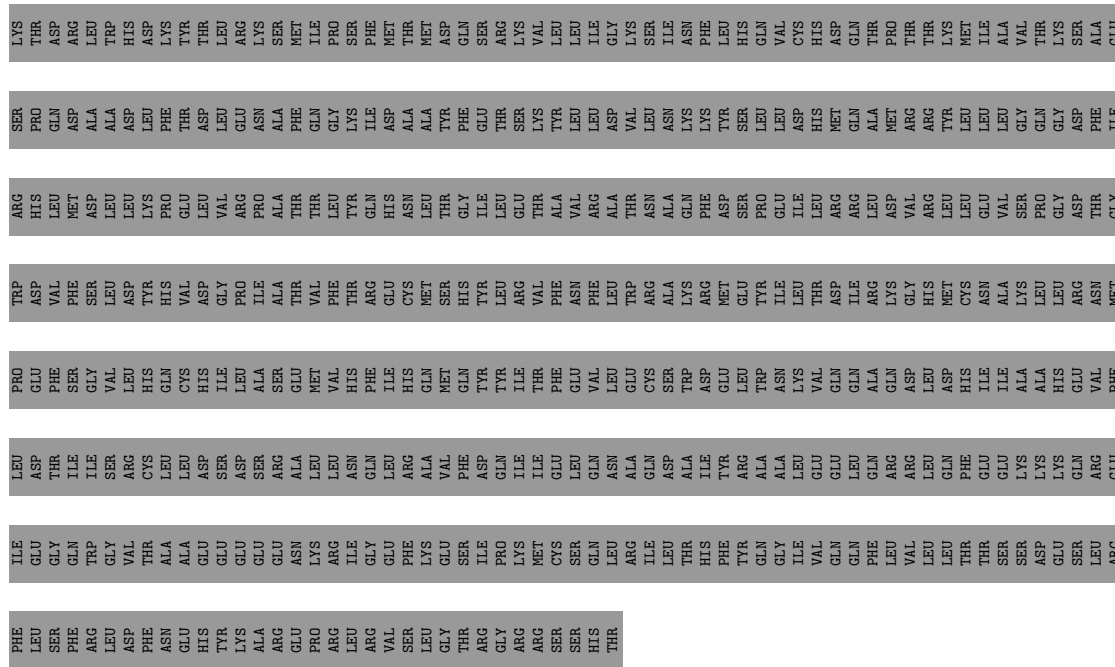

● Molecule 4: Gamma-tubulin complex component 2

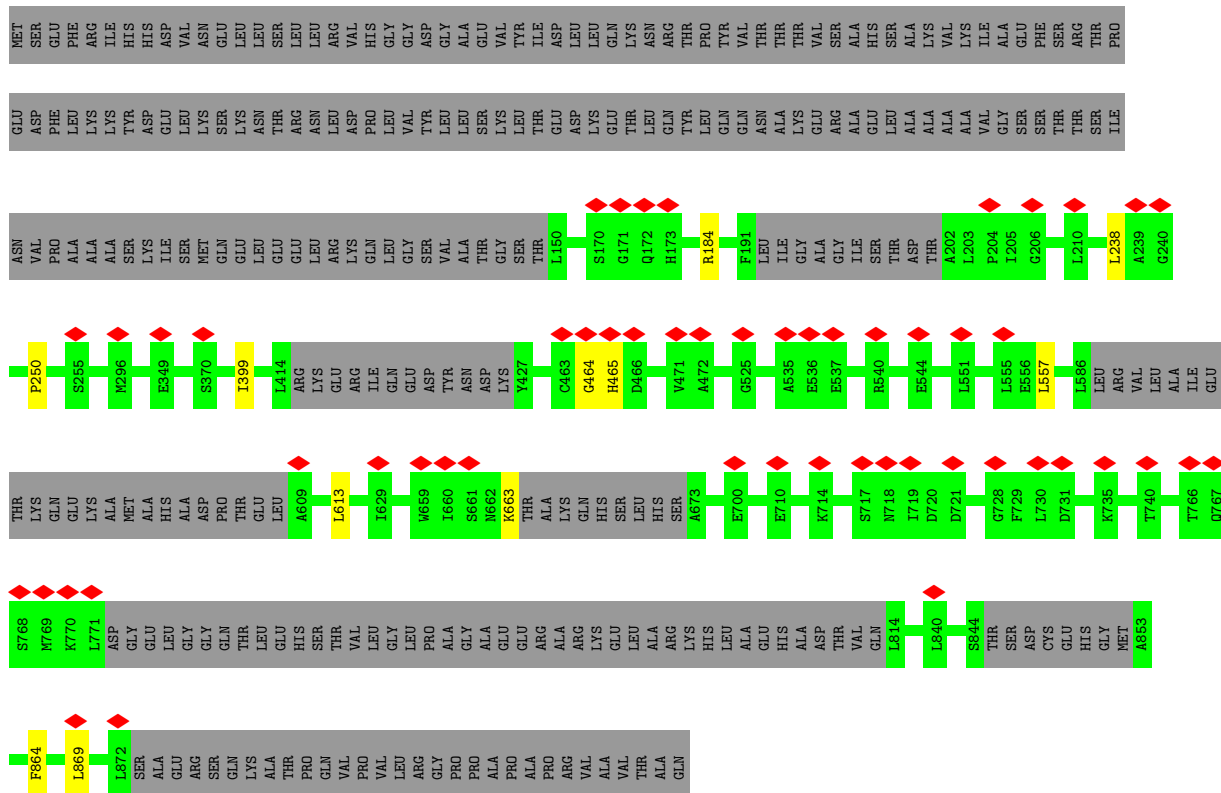

● Molecule 4: Gamma-tubulin complex component 2



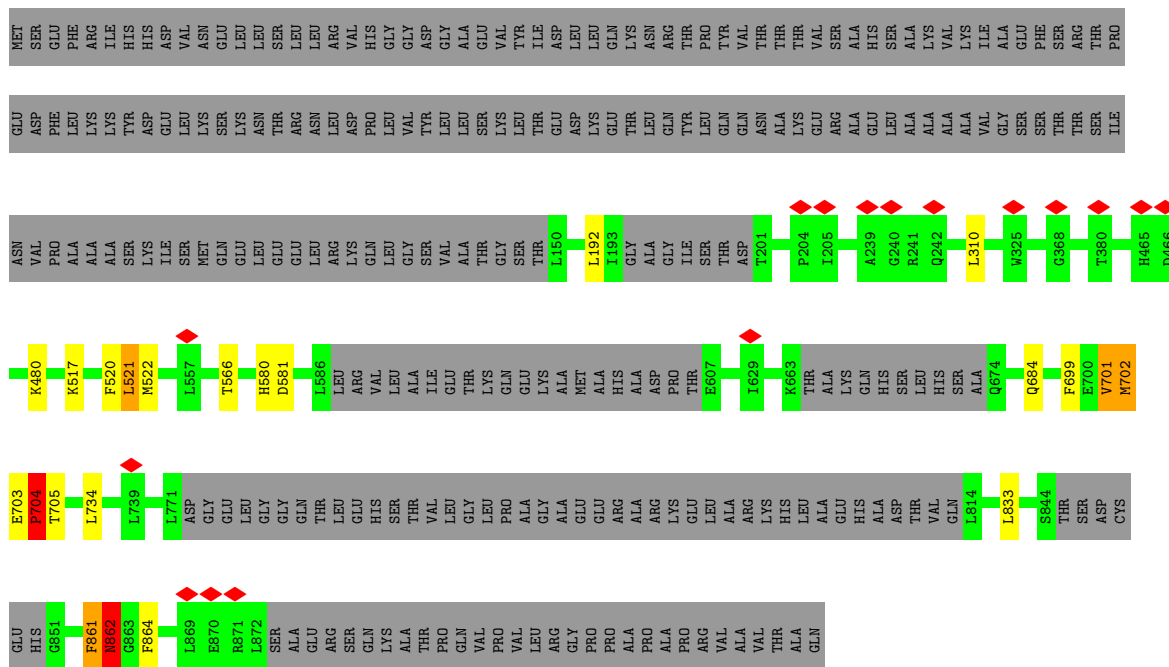

• Molecule 4: Gamma-tubulin complex component 2

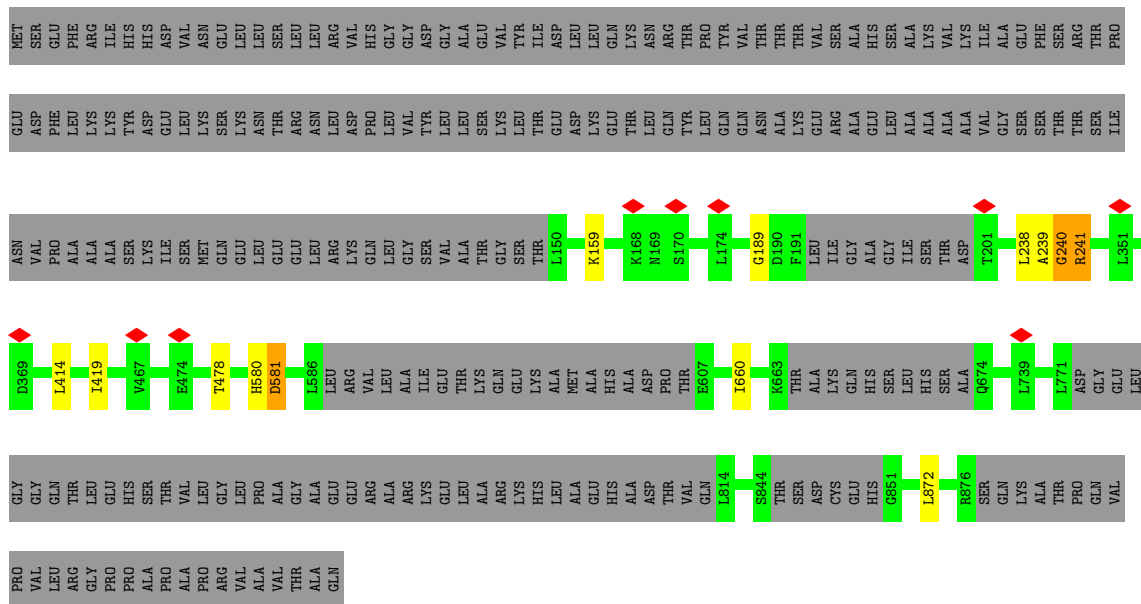

• Molecule 4: Gamma-tubulin complex component 2

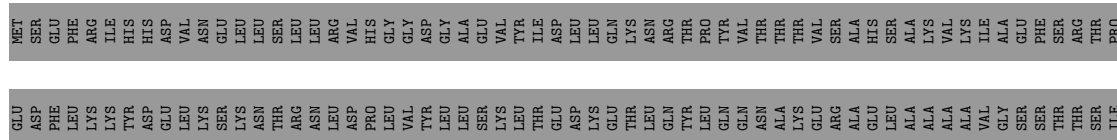

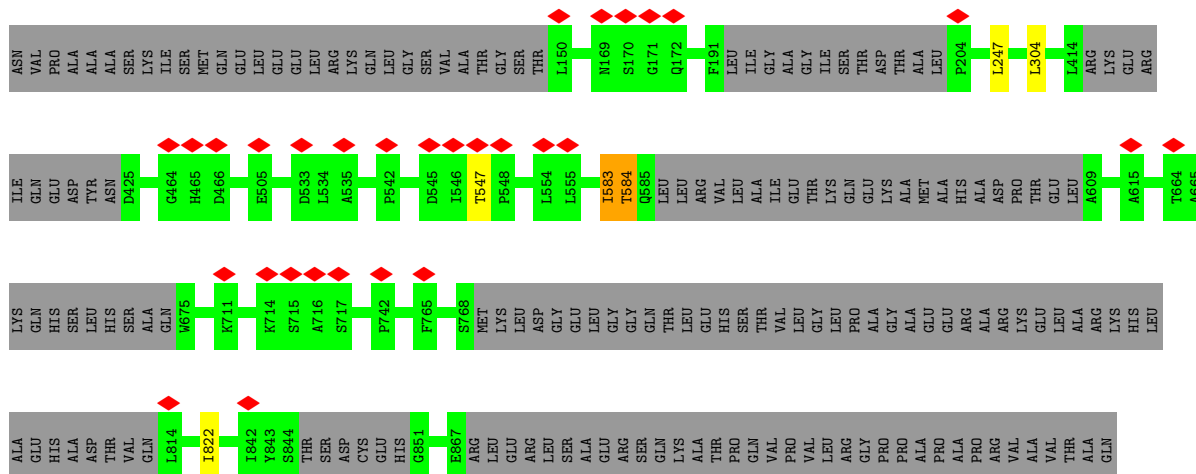

• Molecule 5: Gamma-tubulin complex component 4

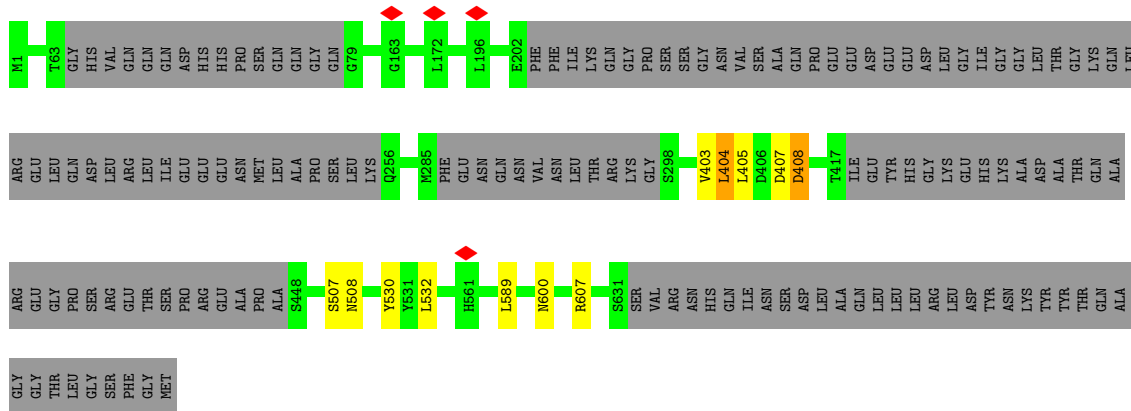
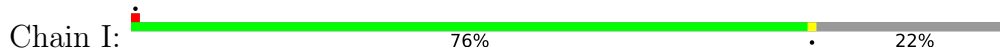

• Molecule 5: Gamma-tubulin complex component 4

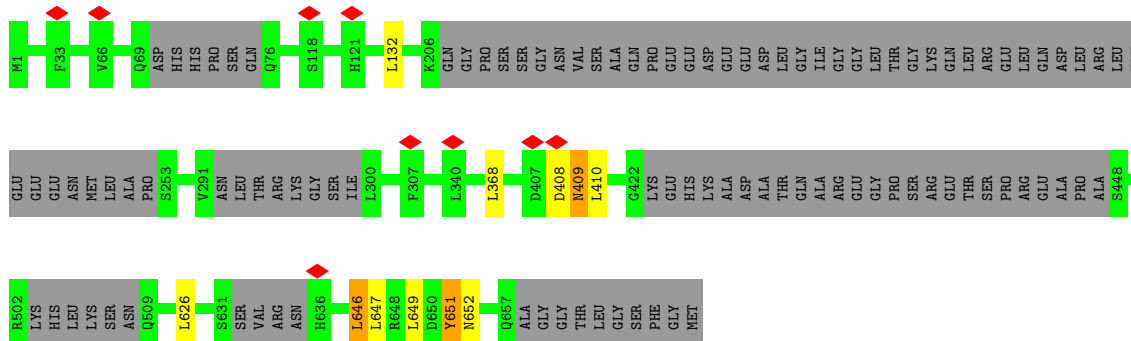
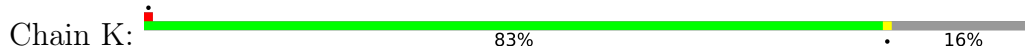

• Molecule 6: Gamma-tubulin complex component 6



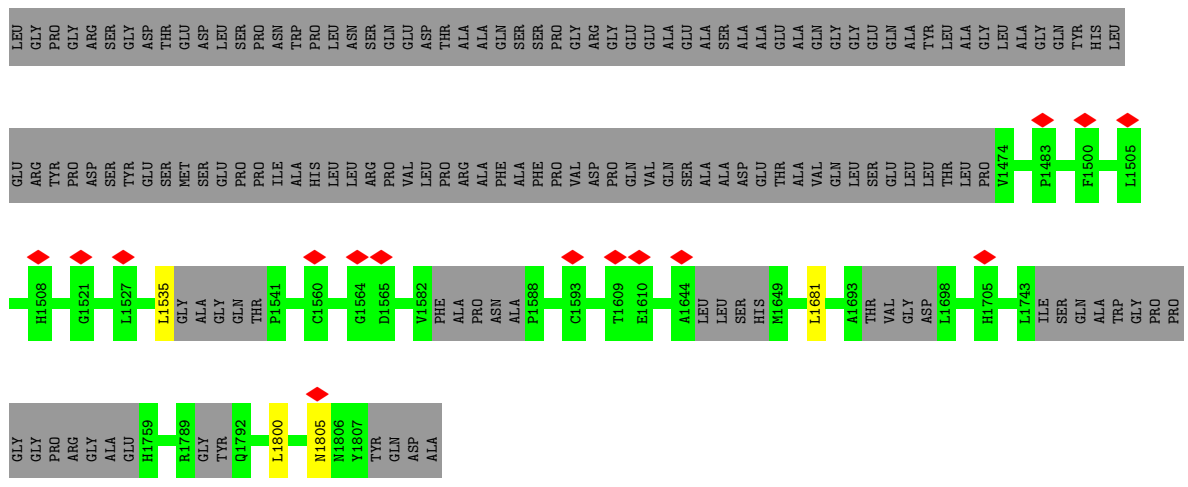

• Molecule 6: Gamma-tubulin complex component 6

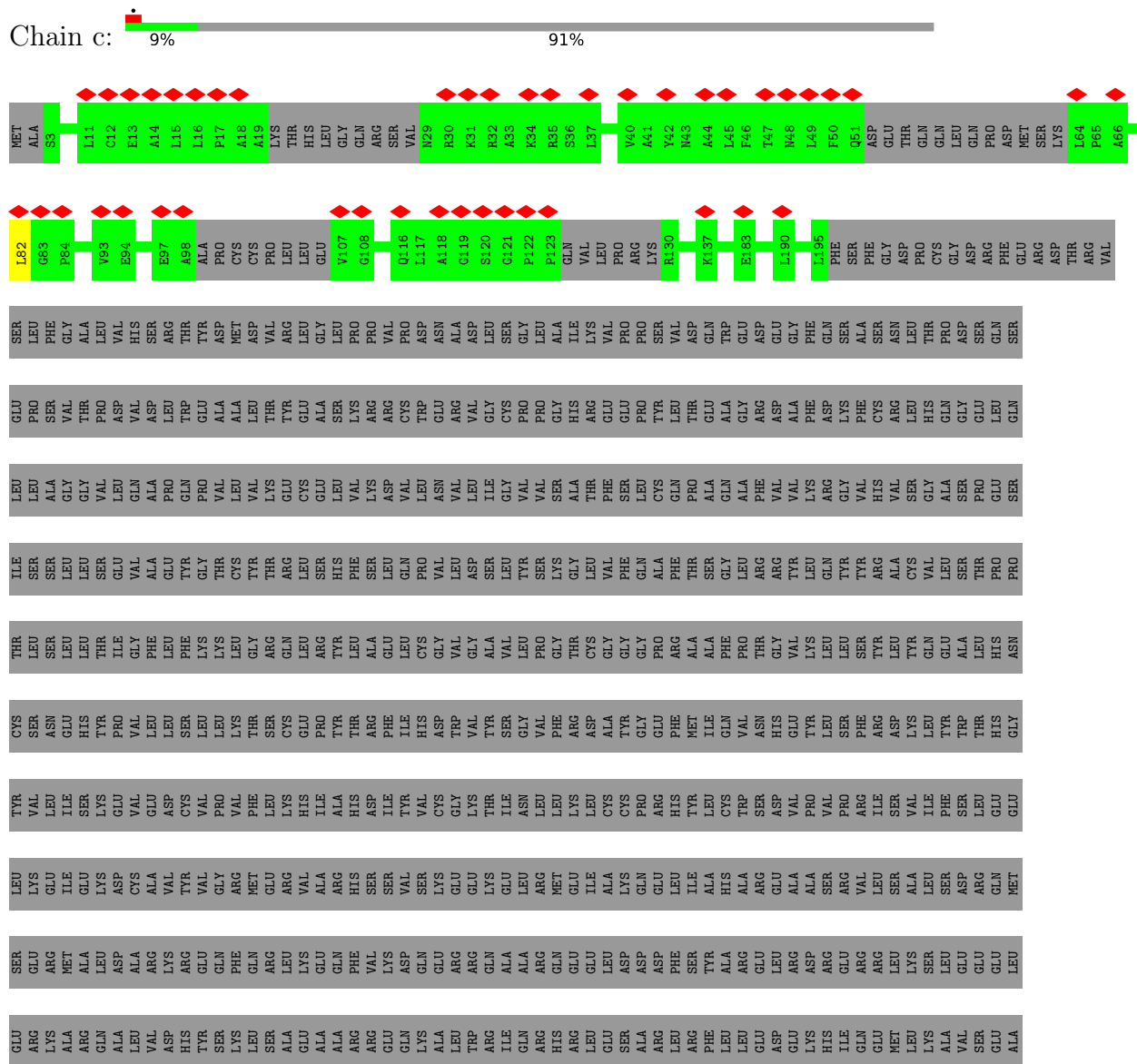

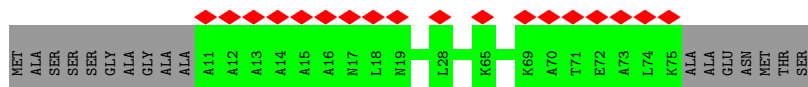
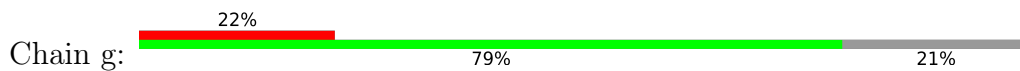

• Molecule 7: Mitotic-spindle organizing protein 1

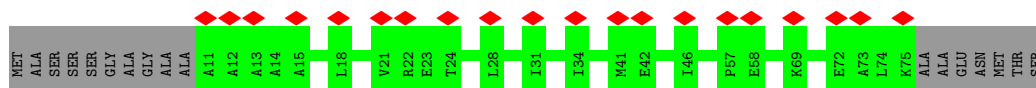
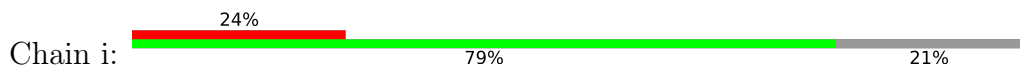

• Molecule 7: Mitotic-spindle organizing protein 1

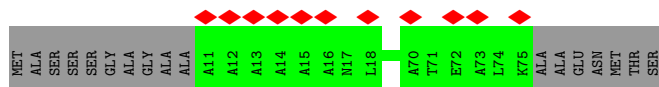
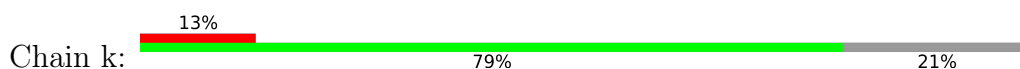

• Molecule 7: Mitotic-spindle organizing protein 1

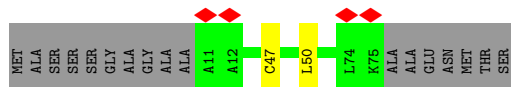
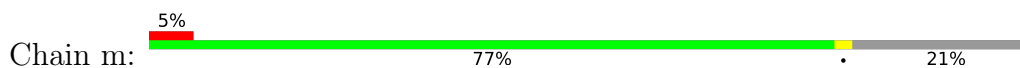

• Molecule 7: Mitotic-spindle organizing protein 1

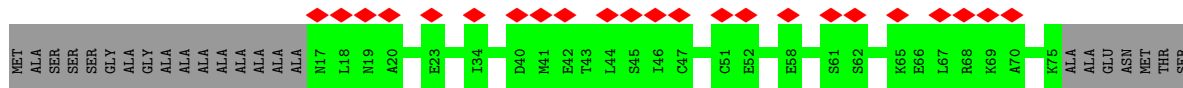

• Molecule 8: Tubulin gamma-1 chain

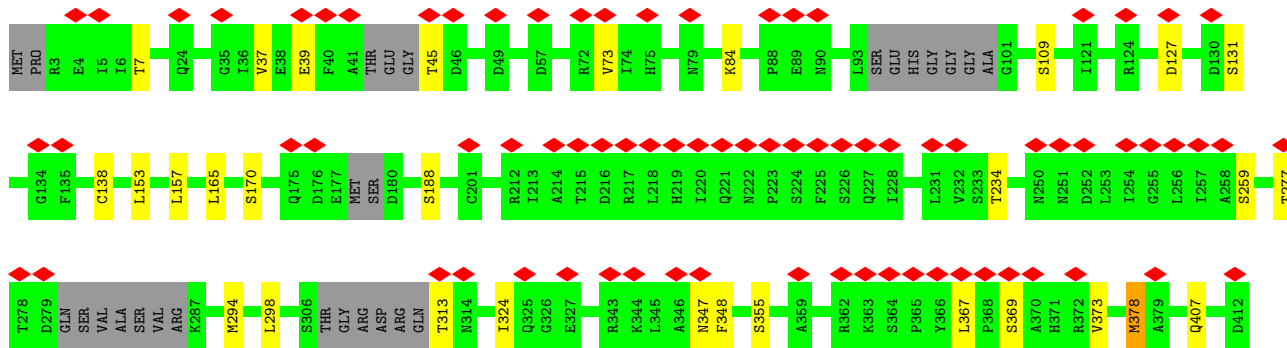
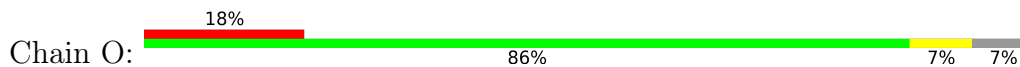

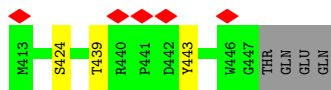

• Molecule 8: Tubulin gamma-1 chain

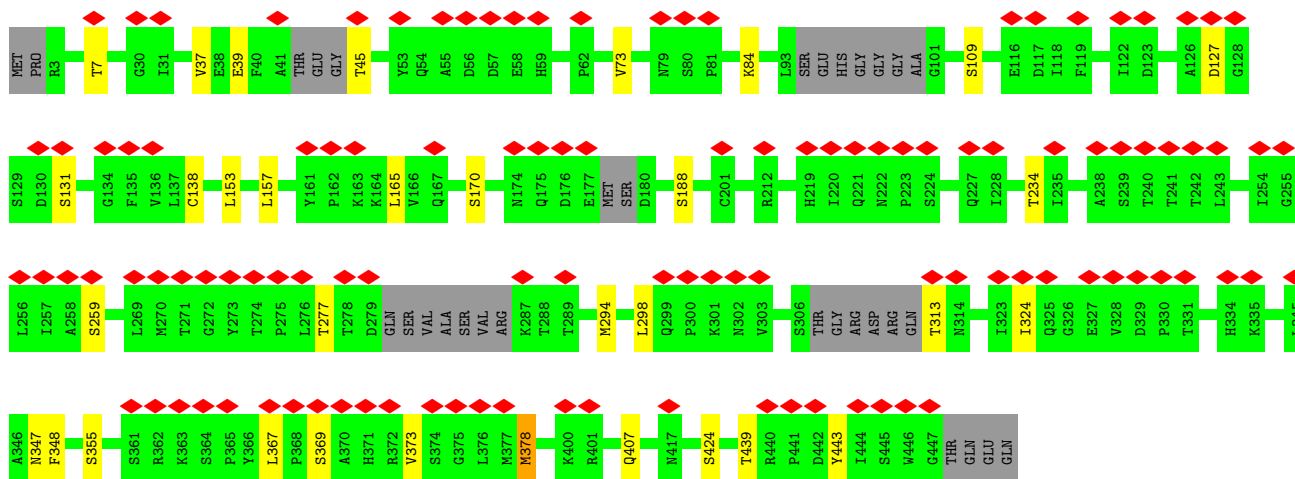
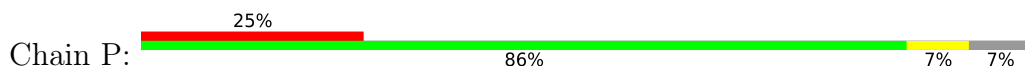

• Molecule 8: Tubulin gamma-1 chain

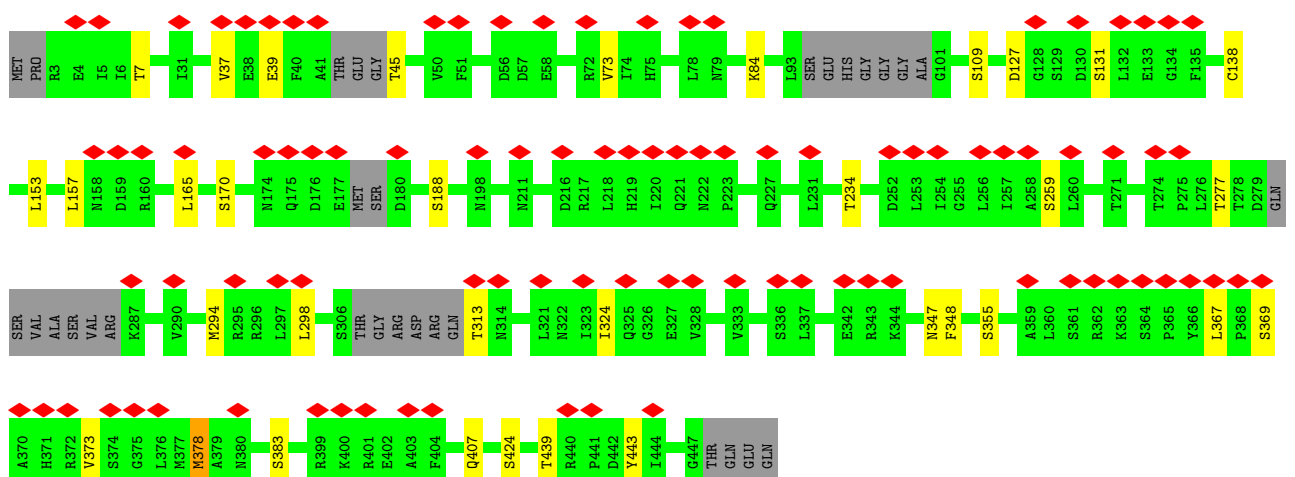
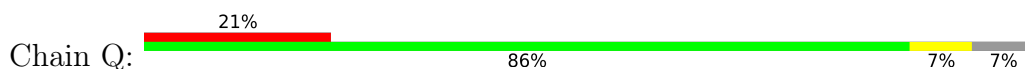

• Molecule 8: Tubulin gamma-1 chain

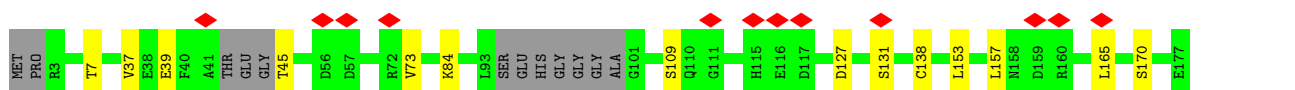
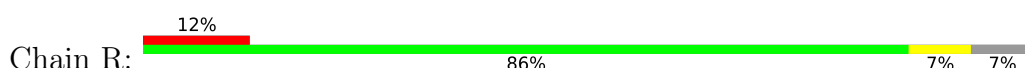

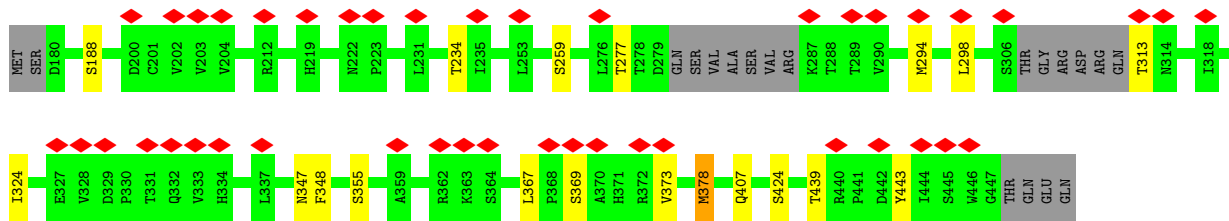

• Molecule 8: Tubulin gamma-1 chain

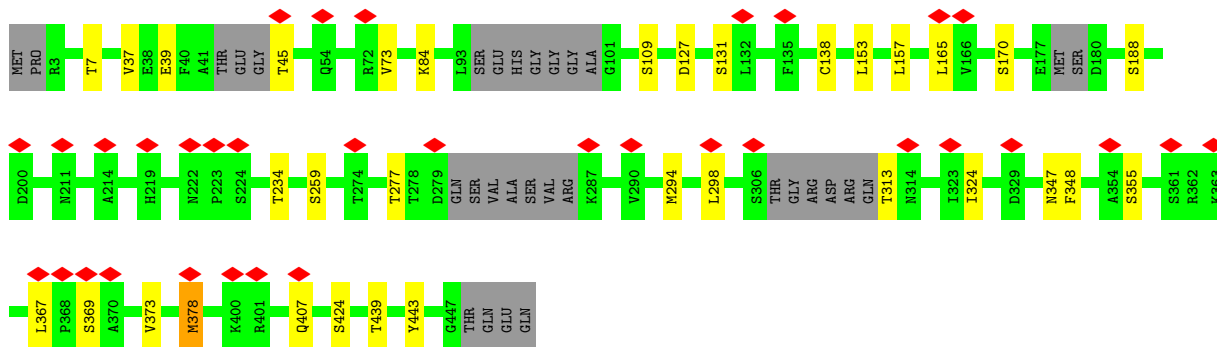
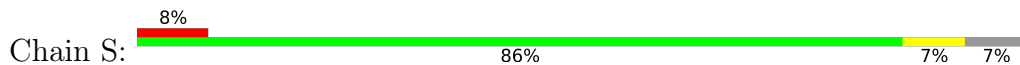

• Molecule 8: Tubulin gamma-1 chain

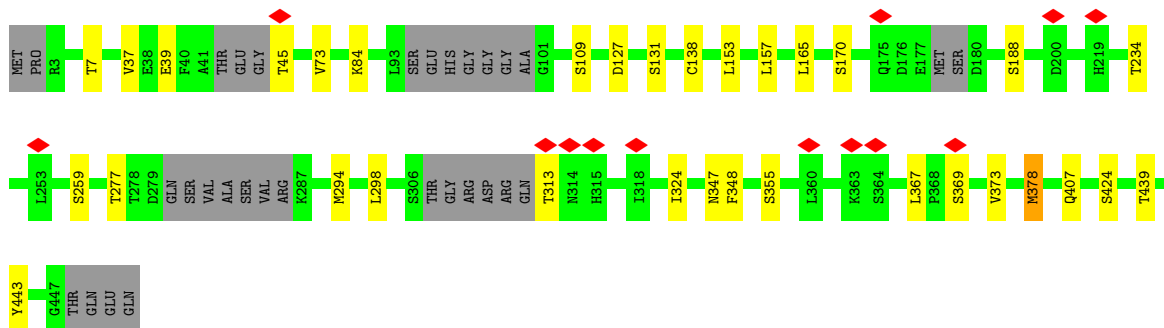
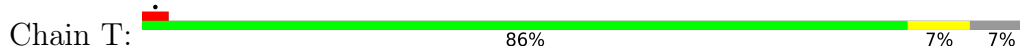

• Molecule 8: Tubulin gamma-1 chain

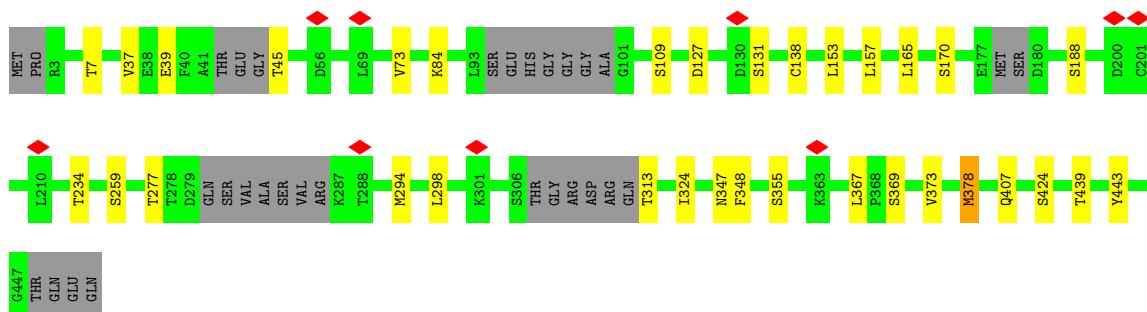

• Molecule 8: Tubulin gamma-1 chain

Chain V:  86% 7% 7%

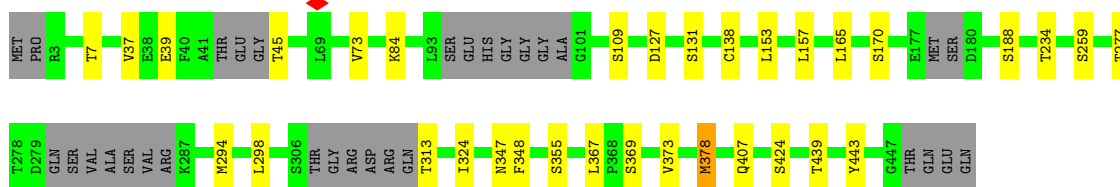

• Molecule 8: Tubulin gamma-1 chain

Chain W:  86% 7% 7%



• Molecule 8: Tubulin gamma-1 chain

Chain X:  86% 7% 7%

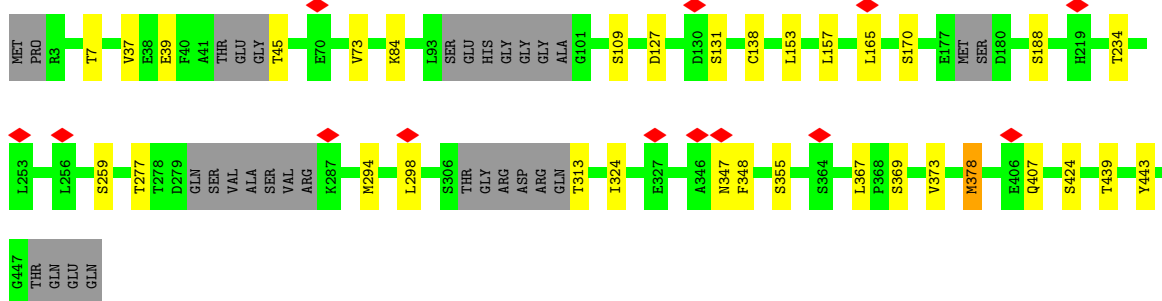

• Molecule 8: Tubulin gamma-1 chain

Chain Y:  7% 86% 7% 7%

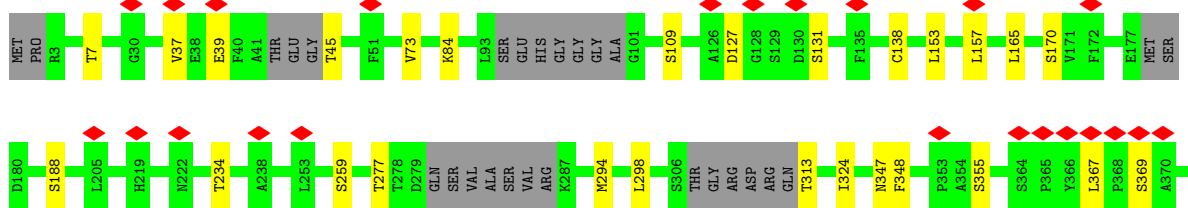

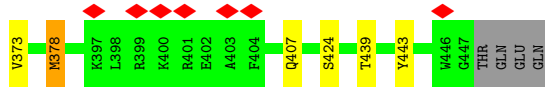

• Molecule 8: Tubulin gamma-1 chain

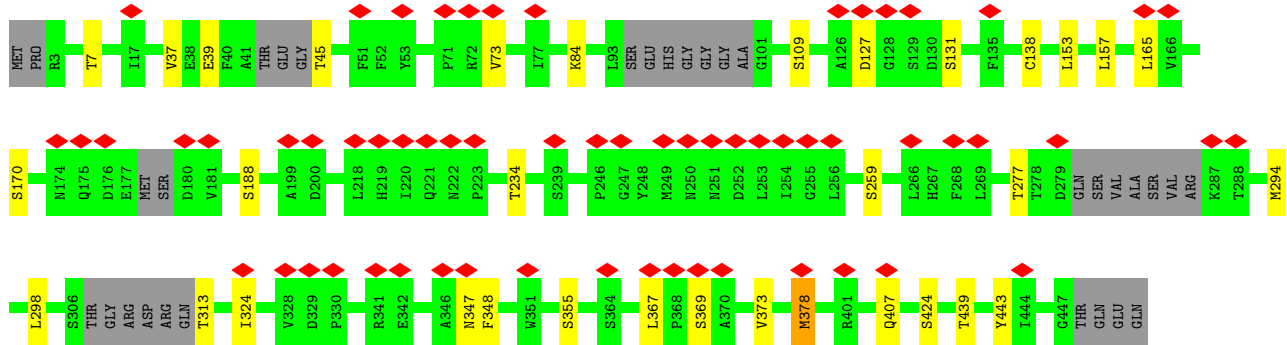
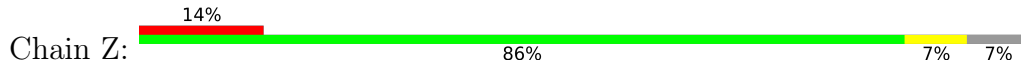

4 Experimental information

Property	Value	Source
EM reconstruction method	SINGLE PARTICLE	Depositor
Imposed symmetry	POINT, Not provided	
Number of particles used	5376	Depositor
Resolution determination method	FSC 0.143 CUT-OFF	Depositor
CTF correction method	PHASE FLIPPING AND AMPLITUDE CORRECTION	Depositor
Microscope	FEI TITAN KRIOS	Depositor
Voltage (kV)	300	Depositor
Electron dose ($e^-/\text{\AA}^2$)	35	Depositor
Minimum defocus (nm)	2000	Depositor
Maximum defocus (nm)	2500	Depositor
Magnification	Not provided	
Image detector	GATAN K3 (6k x 4k)	Depositor
Maximum map value	0.169	Depositor
Minimum map value	-0.027	Depositor
Average map value	0.002	Depositor
Map value standard deviation	0.009	Depositor
Recommended contour level	0.0432	Depositor
Map size (\AA)	532.0, 532.0, 532.0	wwPDB
Map dimensions	200, 200, 200	wwPDB
Map angles ($^\circ$)	90.0, 90.0, 90.0	wwPDB
Pixel spacing (\AA)	2.66, 2.66, 2.66	Depositor

5 Model quality i

5.1 Standard geometry i

The Z score for a bond length (or angle) is the number of standard deviations the observed value is removed from the expected value. A bond length (or angle) with $|Z| > 5$ is considered an outlier worth inspection. RMSZ is the root-mean-square of all Z scores of the bond lengths (or angles).

Mol	Chain	Bond lengths		Bond angles	
		RMSZ	# Z >5	RMSZ	# Z >5
1	e	0.63	1/2908 (0.0%)	0.67	3/3938 (0.1%)
2	J	0.40	0/4525	0.71	6/6119 (0.1%)
2	l	0.33	0/863	0.66	2/1166 (0.2%)
3	B	0.34	0/5133	0.60	1/6930 (0.0%)
3	D	0.35	0/4897	0.63	2/6610 (0.0%)
3	F	0.37	0/5044	0.64	2/6809 (0.0%)
3	H	0.37	1/5009 (0.0%)	0.63	4/6761 (0.1%)
3	a	0.35	0/948	0.61	0/1277
3	f	0.30	0/815	0.55	0/1096
3	h	0.29	0/815	0.54	0/1096
3	j	0.28	0/855	0.69	4/1152 (0.3%)
4	A	0.32	0/5085	0.58	2/6866 (0.0%)
4	C	0.38	1/5151 (0.0%)	0.66	5/6955 (0.1%)
4	E	0.43	1/5311 (0.0%)	0.74	8/7169 (0.1%)
4	G	0.37	0/5315	0.65	6/7175 (0.1%)
5	I	0.41	2/4322 (0.0%)	0.64	2/5853 (0.0%)
5	K	0.43	2/4683 (0.0%)	0.70	9/6338 (0.1%)
6	L	0.35	0/4697	0.66	6/6348 (0.1%)
6	c	0.35	0/1235	0.63	1/1664 (0.1%)
7	b	0.36	0/484	0.65	0/653
7	d	0.36	0/454	0.63	0/611
7	g	0.32	0/484	0.58	0/653
7	i	0.31	0/484	0.60	0/653
7	k	0.30	0/484	0.52	0/653
7	m	0.33	0/484	0.68	1/653 (0.2%)
8	O	0.32	0/3441	0.57	3/4661 (0.1%)
8	P	0.32	0/3441	0.57	3/4661 (0.1%)
8	Q	0.32	0/3441	0.57	3/4661 (0.1%)
8	R	0.32	0/3441	0.57	3/4661 (0.1%)
8	S	0.32	0/3441	0.57	3/4661 (0.1%)
8	T	0.32	0/3441	0.57	3/4661 (0.1%)
8	U	0.32	0/3441	0.57	3/4661 (0.1%)
8	V	0.32	0/3441	0.57	3/4661 (0.1%)
8	W	0.32	0/3441	0.57	3/4661 (0.1%)

Mol	Chain	Bond lengths		Bond angles	
		RMSZ	# Z >5	RMSZ	# Z >5
8	X	0.32	0/3441	0.57	3/4661 (0.1%)
8	Y	0.32	0/3441	0.57	3/4661 (0.1%)
8	Z	0.32	0/3441	0.57	3/4661 (0.1%)
All	All	0.36	8/111777 (0.0%)	0.62	100/151130 (0.1%)

Chiral center outliers are detected by calculating the chiral volume of a chiral center and verifying if the center is modelled as a planar moiety or with the opposite hand. A planarity outlier is detected by checking planarity of atoms in a peptide group, atoms in a mainchain group or atoms of a sidechain that are expected to be planar.

Mol	Chain	#Chirality outliers	#Planarity outliers
2	J	0	2
3	B	0	1
3	D	0	1
3	F	0	1
3	h	0	2
3	j	0	1
4	A	0	2
4	C	0	2
4	E	0	3
4	G	0	5
5	I	0	6
5	K	0	3
6	L	0	3
8	O	0	1
8	P	0	1
8	Q	0	1
8	R	0	1
8	S	0	1
8	T	0	1
8	U	0	1
8	V	0	1
8	W	0	1
8	X	0	1
8	Y	0	1
8	Z	0	1
All	All	0	44

The worst 5 of 8 bond length outliers are listed below:

Mol	Chain	Res	Type	Atoms	Z	Observed(Å)	Ideal(Å)
1	e	243	PRO	N-CD	28.08	1.87	1.47

Continued on next page...

Continued from previous page...

Mol	Chain	Res	Type	Atoms	Z	Observed(Å)	Ideal(Å)
5	I	530	TYR	CD1-CE1	-7.84	1.27	1.39
5	K	651	TYR	CG-CD2	-7.50	1.29	1.39
5	K	646	LEU	CG-CD1	-6.75	1.26	1.51
4	C	864	PHE	CA-CB	-6.44	1.39	1.53

The worst 5 of 100 bond angle outliers are listed below:

Mol	Chain	Res	Type	Atoms	Z	Observed(°)	Ideal(°)
6	L	1681	LEU	CB-CG-CD1	-11.22	91.93	111.00
4	E	521	LEU	CA-CB-CG	9.76	137.74	115.30
4	C	557	LEU	CA-CB-CG	-9.25	94.02	115.30
6	c	82	LEU	CA-CB-CG	8.60	135.09	115.30
6	L	1800	LEU	CA-CB-CG	8.49	134.84	115.30

There are no chirality outliers.

5 of 44 planarity outliers are listed below:

Mol	Chain	Res	Type	Group
3	B	869	SER	Peptide
4	C	238	LEU	Peptide
4	C	464	GLY	Peptide
3	D	873	LEU	Peptide
4	E	520	PHE	Peptide

5.2 Too-close contacts [i](#)

Due to software issues we are unable to calculate clashes - this section is therefore empty.

5.3 Torsion angles [i](#)

5.3.1 Protein backbone [i](#)

In the following table, the Percentiles column shows the percent Ramachandran outliers of the chain as a percentile score with respect to all PDB entries followed by that with respect to all EM entries.

The Analysed column shows the number of residues for which the backbone conformation was analysed, and the total number of residues.

Mol	Chain	Analysed	Favoured	Allowed	Outliers	Percentiles	
1	e	360/375 (96%)	341 (95%)	19 (5%)	0	100	100
2	J	506/1024 (49%)	465 (92%)	38 (8%)	3 (1%)	25	66
2	l	104/1024 (10%)	99 (95%)	3 (3%)	2 (2%)	8	38
3	B	602/907 (66%)	571 (95%)	30 (5%)	1 (0%)	47	81
3	D	571/907 (63%)	548 (96%)	23 (4%)	0	100	100
3	F	591/907 (65%)	559 (95%)	31 (5%)	1 (0%)	47	81
3	H	584/907 (64%)	562 (96%)	22 (4%)	0	100	100
3	a	112/907 (12%)	105 (94%)	5 (4%)	2 (2%)	8	40
3	f	97/907 (11%)	92 (95%)	5 (5%)	0	100	100
3	h	97/907 (11%)	95 (98%)	2 (2%)	0	100	100
3	j	105/907 (12%)	97 (92%)	5 (5%)	3 (3%)	4	29
4	A	599/902 (66%)	578 (96%)	20 (3%)	1 (0%)	47	81
4	C	606/902 (67%)	573 (95%)	31 (5%)	2 (0%)	41	77
4	E	626/902 (69%)	576 (92%)	43 (7%)	7 (1%)	14	52
4	G	628/902 (70%)	594 (95%)	31 (5%)	3 (0%)	29	69
5	I	511/667 (77%)	486 (95%)	21 (4%)	4 (1%)	19	60
5	K	548/667 (82%)	529 (96%)	17 (3%)	2 (0%)	34	72
6	L	540/1819 (30%)	512 (95%)	25 (5%)	3 (1%)	25	66
6	c	148/1819 (8%)	140 (95%)	8 (5%)	0	100	100
7	b	63/82 (77%)	62 (98%)	1 (2%)	0	100	100
7	d	57/82 (70%)	57 (100%)	0	0	100	100
7	g	63/82 (77%)	63 (100%)	0	0	100	100
7	i	63/82 (77%)	61 (97%)	2 (3%)	0	100	100
7	k	63/82 (77%)	62 (98%)	1 (2%)	0	100	100
7	m	63/82 (77%)	61 (97%)	2 (3%)	0	100	100
8	O	408/451 (90%)	387 (95%)	21 (5%)	0	100	100
8	P	408/451 (90%)	387 (95%)	21 (5%)	0	100	100
8	Q	408/451 (90%)	386 (95%)	22 (5%)	0	100	100
8	R	408/451 (90%)	386 (95%)	22 (5%)	0	100	100
8	S	408/451 (90%)	386 (95%)	22 (5%)	0	100	100
8	T	408/451 (90%)	387 (95%)	21 (5%)	0	100	100
8	U	408/451 (90%)	387 (95%)	21 (5%)	0	100	100

Continued on next page...

Continued from previous page...

Mol	Chain	Analysed	Favoured	Allowed	Outliers	Percentiles	
8	V	408/451 (90%)	386 (95%)	22 (5%)	0	100	100
8	W	408/451 (90%)	386 (95%)	22 (5%)	0	100	100
8	X	408/451 (90%)	387 (95%)	21 (5%)	0	100	100
8	Y	408/451 (90%)	386 (95%)	22 (5%)	0	100	100
8	Z	408/451 (90%)	387 (95%)	21 (5%)	0	100	100
All	All	13203/24163 (55%)	12526 (95%)	643 (5%)	34 (0%)	44	77

5 of 34 Ramachandran outliers are listed below:

Mol	Chain	Res	Type
2	l	121	PRO
3	B	870	ASP
4	C	465	HIS
4	E	522	MET
4	E	701	VAL

5.3.2 Protein sidechains [i](#)

In the following table, the Percentiles column shows the percent sidechain outliers of the chain as a percentile score with respect to all PDB entries followed by that with respect to all EM entries.

The Analysed column shows the number of residues for which the sidechain conformation was analysed, and the total number of residues.

Mol	Chain	Analysed	Rotameric	Outliers	Percentiles	
1	e	310/318 (98%)	305 (98%)	5 (2%)	62	79
2	J	498/933 (53%)	497 (100%)	1 (0%)	93	96
2	l	84/933 (9%)	84 (100%)	0	100	100
3	B	551/798 (69%)	548 (100%)	3 (0%)	88	93
3	D	525/798 (66%)	521 (99%)	4 (1%)	81	89
3	F	542/798 (68%)	536 (99%)	6 (1%)	73	84
3	H	539/798 (68%)	535 (99%)	4 (1%)	84	90
3	a	101/798 (13%)	99 (98%)	2 (2%)	55	74
3	f	88/798 (11%)	88 (100%)	0	100	100
3	h	88/798 (11%)	88 (100%)	0	100	100
3	j	88/798 (11%)	88 (100%)	0	100	100

Continued on next page...

Continued from previous page...

Mol	Chain	Analysed	Rotameric	Outliers	Percentiles	
4	A	549/791 (69%)	546 (100%)	3 (0%)	88	93
4	C	556/791 (70%)	554 (100%)	2 (0%)	91	94
4	E	574/791 (73%)	562 (98%)	12 (2%)	53	72
4	G	572/791 (72%)	569 (100%)	3 (0%)	88	93
5	I	472/594 (80%)	471 (100%)	1 (0%)	93	96
5	K	509/594 (86%)	508 (100%)	1 (0%)	93	96
6	L	501/1546 (32%)	500 (100%)	1 (0%)	93	96
6	c	135/1546 (9%)	135 (100%)	0	100	100
7	b	53/62 (86%)	52 (98%)	1 (2%)	57	75
7	d	53/62 (86%)	53 (100%)	0	100	100
7	g	53/62 (86%)	53 (100%)	0	100	100
7	i	53/62 (86%)	53 (100%)	0	100	100
7	k	53/62 (86%)	53 (100%)	0	100	100
7	m	53/62 (86%)	52 (98%)	1 (2%)	57	75
8	O	376/400 (94%)	345 (92%)	31 (8%)	11	34
8	P	376/400 (94%)	345 (92%)	31 (8%)	11	34
8	Q	376/400 (94%)	344 (92%)	32 (8%)	10	33
8	R	376/400 (94%)	345 (92%)	31 (8%)	11	34
8	S	376/400 (94%)	345 (92%)	31 (8%)	11	34
8	T	376/400 (94%)	345 (92%)	31 (8%)	11	34
8	U	376/400 (94%)	345 (92%)	31 (8%)	11	34
8	V	376/400 (94%)	345 (92%)	31 (8%)	11	34
8	W	376/400 (94%)	345 (92%)	31 (8%)	11	34
8	X	376/400 (94%)	345 (92%)	31 (8%)	11	34
8	Y	376/400 (94%)	345 (92%)	31 (8%)	11	34
8	Z	376/400 (94%)	345 (92%)	31 (8%)	11	34
All	All	12112/21184 (57%)	11689 (96%)	423 (4%)	39	59

5 of 423 residues with a non-rotameric sidechain are listed below:

Mol	Chain	Res	Type
8	U	7	THR
8	V	369	SER

Continued on next page...

Continued from previous page...

Mol	Chain	Res	Type
8	Z	188	SER
8	U	127	ASP
8	U	439	THR

Sometimes sidechains can be flipped to improve hydrogen bonding and reduce clashes. 5 of 150 such sidechains are listed below:

Mol	Chain	Res	Type
8	V	16	GLN
4	A	261	HIS
8	W	16	GLN
8	Y	325	GLN
4	G	438	GLN

5.3.3 RNA [i](#)

There are no RNA molecules in this entry.

5.4 Non-standard residues in protein, DNA, RNA chains [i](#)

There are no non-standard protein/DNA/RNA residues in this entry.

5.5 Carbohydrates [i](#)

There are no monosaccharides in this entry.

5.6 Ligand geometry [i](#)

There are no ligands in this entry.

5.7 Other polymers [i](#)

There are no such residues in this entry.

5.8 Polymer linkage issues [i](#)

There are no chain breaks in this entry.

6 Map visualisation [i](#)

This section contains visualisations of the EMDB entry EMD-14015. These allow visual inspection of the internal detail of the map and identification of artifacts.

No raw map or half-maps were deposited for this entry and therefore no images, graphs, etc. pertaining to the raw map can be shown.

6.1 Orthogonal projections [i](#)

6.1.1 Primary map

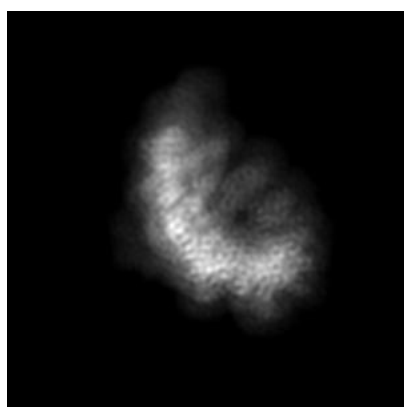

X

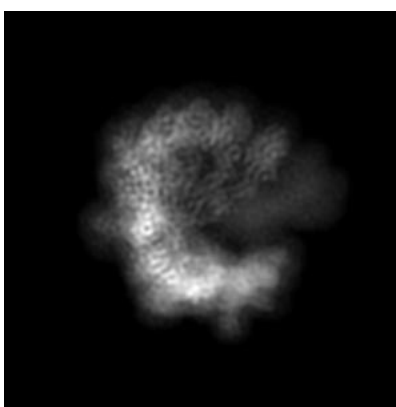

Y

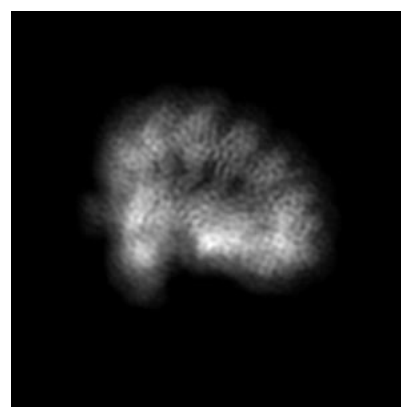

Z

The images above show the map projected in three orthogonal directions.

6.2 Central slices [i](#)

6.2.1 Primary map



X Index: 100

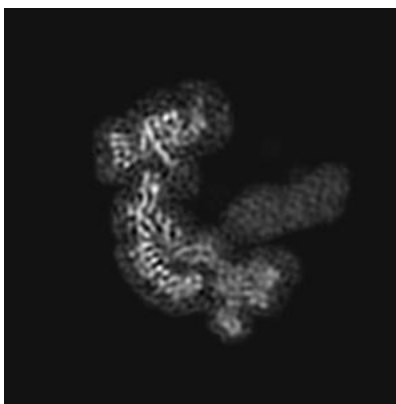

Y Index: 100



Z Index: 100

The images above show central slices of the map in three orthogonal directions.

6.3 Largest variance slices [i](#)

6.3.1 Primary map

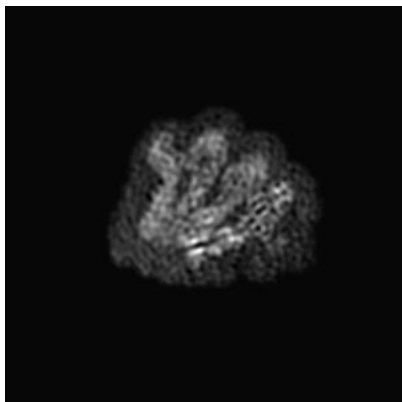

X Index: 64

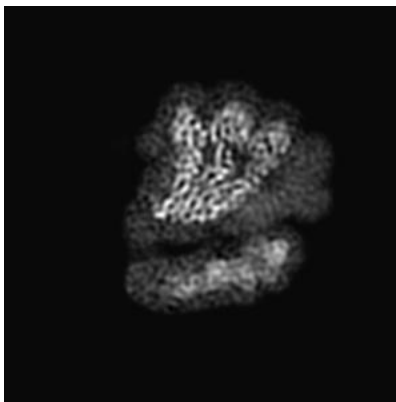

Y Index: 82

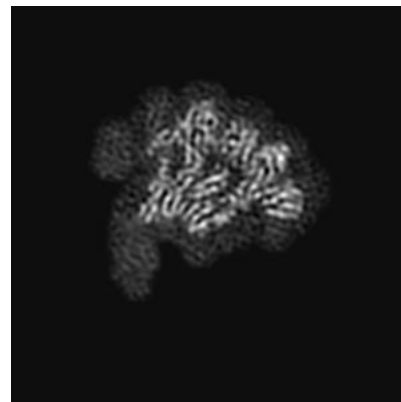

Z Index: 72

The images above show the largest variance slices of the map in three orthogonal directions.

6.4 Orthogonal surface views [i](#)

6.4.1 Primary map

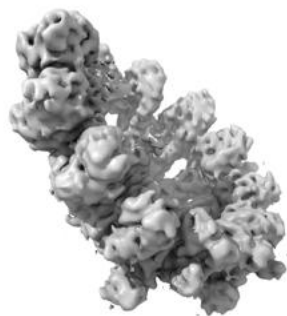

X

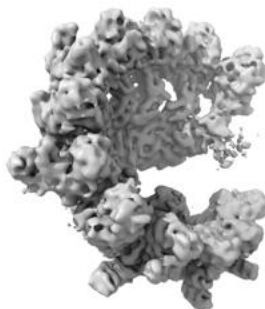

Y

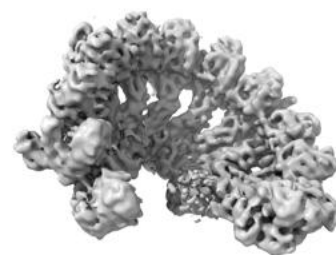

Z

The images above show the 3D surface view of the map at the recommended contour level 0.0432. These images, in conjunction with the slice images, may facilitate assessment of whether an appropriate contour level has been provided.

6.5 Mask visualisation

This section was not generated. No masks/segmentation were deposited.

7 Map analysis [i](#)

This section contains the results of statistical analysis of the map.

7.1 Map-value distribution [i](#)

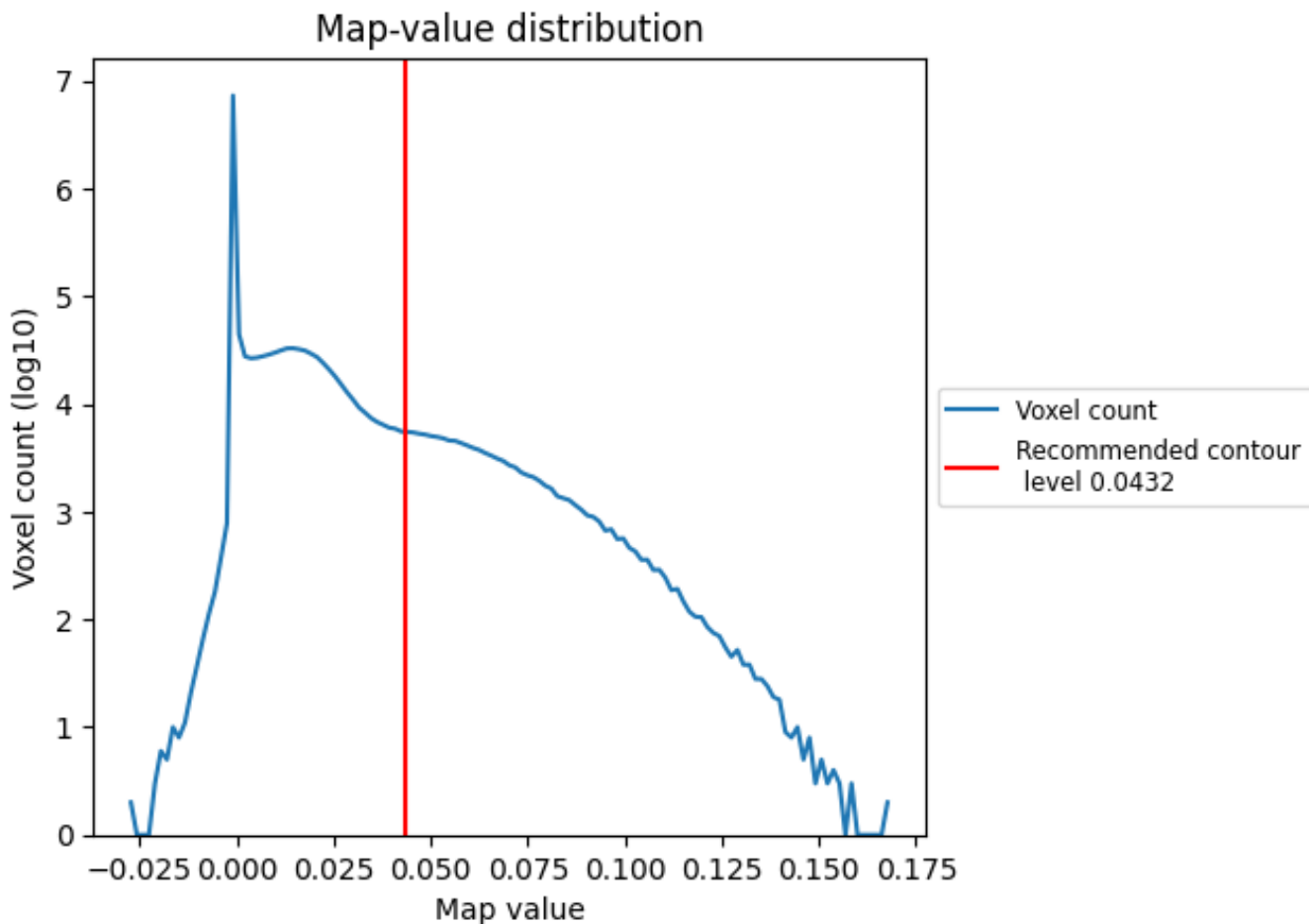

The map-value distribution is plotted in 128 intervals along the x-axis. The y-axis is logarithmic. A spike in this graph at zero usually indicates that the volume has been masked.

7.2 Volume estimate [\(i\)](#)

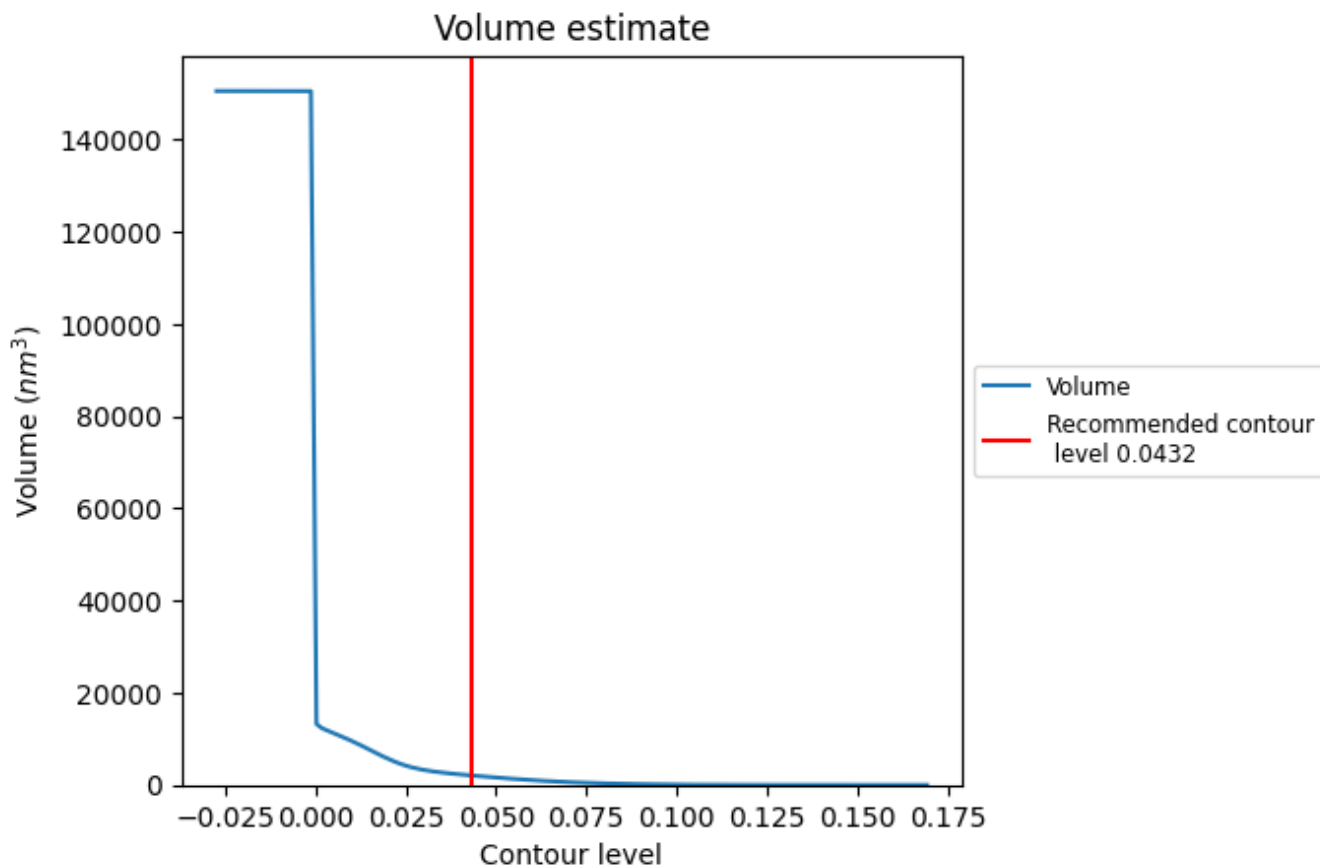

The volume at the recommended contour level is 2056 nm³; this corresponds to an approximate mass of 1857 kDa.

The volume estimate graph shows how the enclosed volume varies with the contour level. The recommended contour level is shown as a vertical line and the intersection between the line and the curve gives the volume of the enclosed surface at the given level.

7.3 Rotationally averaged power spectrum [i](#)

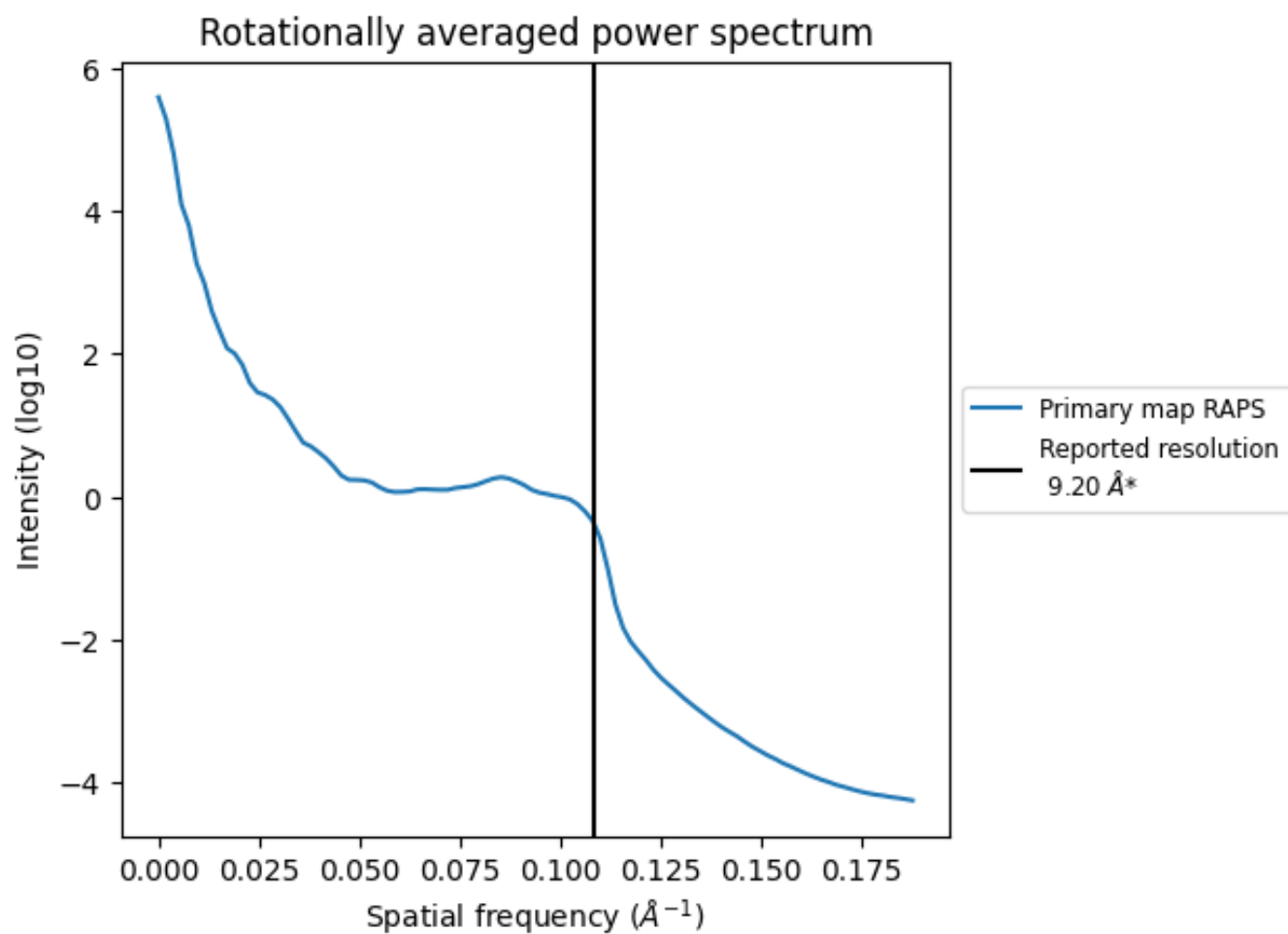

*Reported resolution corresponds to spatial frequency of 0.109 Å⁻¹

8 Fourier-Shell correlation

This section was not generated. No FSC curve or half-maps provided.

9 Map-model fit [i](#)

This section contains information regarding the fit between EMDB map EMD-14015 and PDB model 7QJA. Per-residue inclusion information can be found in section 3 on page 8.

9.1 Map-model overlay [i](#)

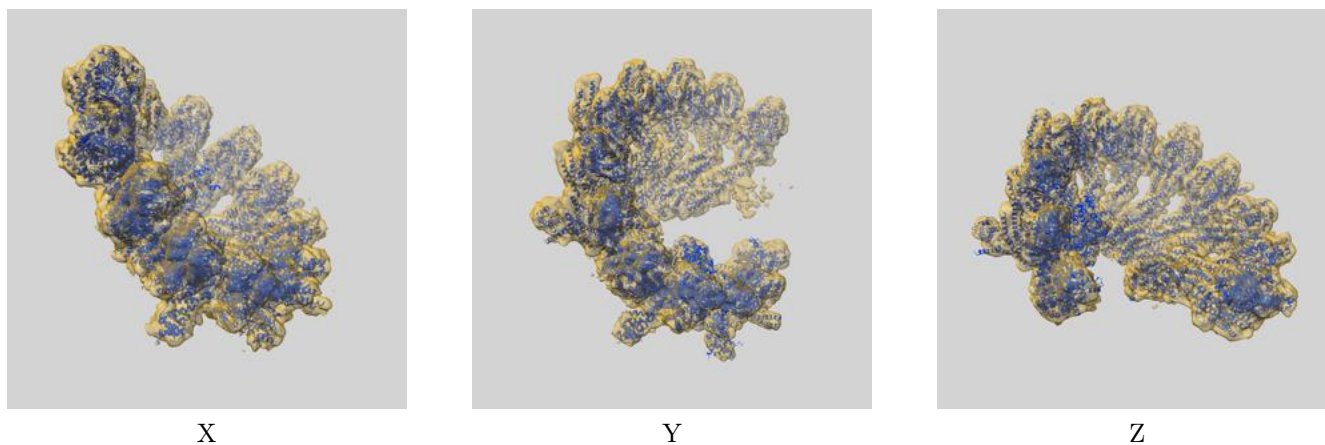

The images above show the 3D surface view of the map at the recommended contour level 0.0432 at 50% transparency in yellow overlaid with a ribbon representation of the model coloured in blue. These images allow for the visual assessment of the quality of fit between the atomic model and the map.

9.2 Atom inclusion [i](#)

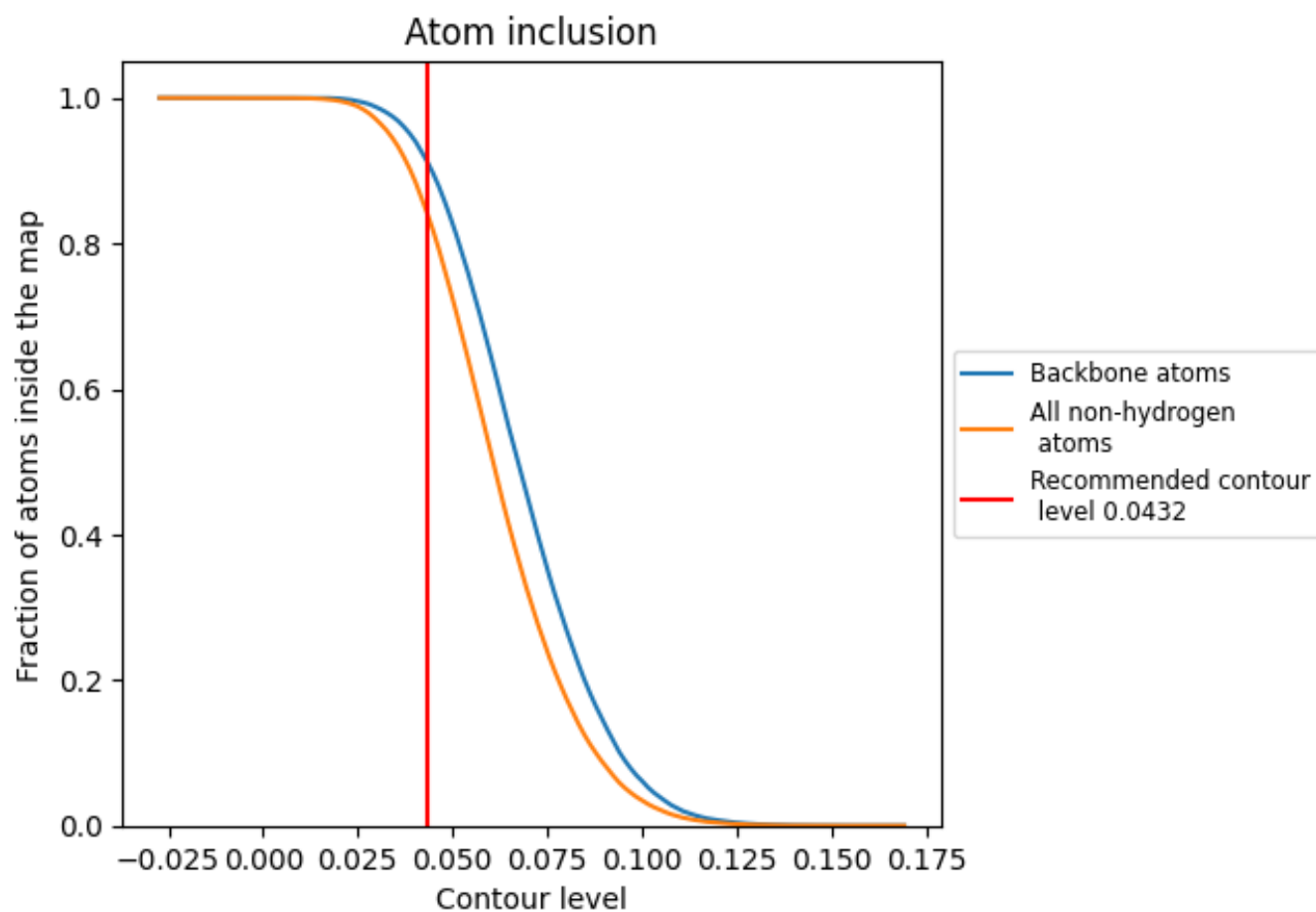

At the recommended contour level, 91% of all backbone atoms, 84% of all non-hydrogen atoms, are inside the map.