



wwPDB EM Validation Summary Report ⓘ

Jan 29, 2022 – 06:22 am GMT

PDB ID : 7QJC
EMDB ID : EMD-14017
Title : Structure of recombinant human gamma-Tubulin Ring Complex (spokes 1-14, homogeneous dataset)
Authors : Zupa, E.; Pfeffer, S.
Deposited on : 2021-12-16
Resolution : 16.10 Å (reported)
Based on initial models : 6L81, 6X0U, 6V6S, 7AS4

This is a wwPDB EM Validation Summary Report for a publicly released PDB entry.

We welcome your comments at validation@mail.wwpdb.org

A user guide is available at

<https://www.wwpdb.org/validation/2017/EMValidationReportHelp>

with specific help available everywhere you see the ⓘ symbol.

The following versions of software and data (see [references ⓘ](#)) were used in the production of this report:

EMDB validation analysis : 0.0.0.dev97
MolProbity : 4.02b-467
Percentile statistics : 20191225.v01 (using entries in the PDB archive December 25th 2019)
Ideal geometry (proteins) : Engh & Huber (2001)
Ideal geometry (DNA, RNA) : Parkinson et al. (1996)
Validation Pipeline (wwPDB-VP) : 2.26

1 Overall quality at a glance

The following experimental techniques were used to determine the structure:
ELECTRON MICROSCOPY

The reported resolution of this entry is 16.10 Å.

Percentile scores (ranging between 0-100) for global validation metrics of the entry are shown in the following graphic. The table shows the number of entries on which the scores are based.

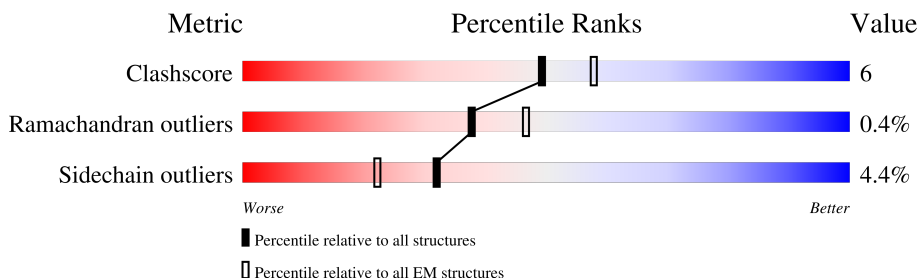

Metric	Whole archive (#Entries)	EM structures (#Entries)
Clashscore	158937	4297
Ramachandran outliers	154571	4023
Sidechain outliers	154315	3826

The table below summarises the geometric issues observed across the polymeric chains and their fit to the map. The red, orange, yellow and green segments of the bar indicate the fraction of residues that contain outliers for ≥ 3 , 2, 1 and 0 types of geometric quality criteria respectively. A grey segment represents the fraction of residues that are not modelled. The numeric value for each fraction is indicated below the corresponding segment, with a dot representing fractions $\leq 5\%$. The upper red bar (where present) indicates the fraction of residues that have poor fit to the EM map (all-atom inclusion $< 40\%$). The numeric value is given above the bar.

Mol	Chain	Length	Quality of chain
1	e	375	
2	A	902	
2	C	902	
2	E	902	
2	G	902	
2	M	902	
3	B	907	
3	D	907	

Continued on next page...

Continued from previous page...

Mol	Chain	Length	Quality of chain
3	F	907	48% 16% 34%
3	H	907	47% 16% 35%
3	N	907	47% 16% 35%
3	a	907	13% 87%
3	f	907	11% 89%
3	h	907	11% 89%
3	j	907	11% 88%
4	I	667	61% 14% 22%
4	K	667	64% 17% 16%
5	J	1024	43% 9% 48%
5	l	1024	10% 89%
6	L	1819	27% 69%
6	c	1819	8% 91%
7	1	451	83% 10% 7%
7	2	451	7% 81% 12% 7%
7	O	451	6% 77% 16% 7%
7	P	451	9% 80% 13% 7%
7	Q	451	11% 79% 14% 7%
7	R	451	12% 78% 14% 7%
7	S	451	5% 78% 15% 7%
7	T	451	85% 8% 7%
7	U	451	82% 11% 7%
7	V	451	84% 9% 7%
7	W	451	79% 14% 7%
7	X	451	79% 14% 7%

Continued on next page...

Continued from previous page...

Mol	Chain	Length	Quality of chain
7	Y	451	<p>78% 15% 7%</p>
7	Z	451	<p>77% 16% 7%</p>
8	b	82	<p>16% 79% 21%</p>
8	d	82	<p>21% 72% 28%</p>
8	g	82	<p>26% 78% 21%</p>
8	i	82	<p>12% 79% 21%</p>
8	k	82	<p>10% 79% 21%</p>
8	m	82	<p>11% 78% 21%</p>

2 Entry composition [i](#)

There are 8 unique types of molecules in this entry. The entry contains 125323 atoms, of which 0 are hydrogens and 0 are deuteriums.

In the tables below, the AltConf column contains the number of residues with at least one atom in alternate conformation and the Trace column contains the number of residues modelled with at most 2 atoms.

- Molecule 1 is a protein called actin, cytoplasmic 1.

Mol	Chain	Residues	Atoms					AltConf	Trace
			Total	C	N	O	S		
1	e	364	1818	1083	364	370	1	0	0

- Molecule 2 is a protein called Gamma-tubulin complex component 2.

Mol	Chain	Residues	Atoms					AltConf	Trace
			Total	C	N	O	S		
2	A	613	4978	3212	831	903	32	0	0
2	C	620	5044	3257	845	910	32	0	0
2	E	638	5202	3354	873	942	33	0	0
2	G	640	5217	3359	878	947	33	0	0
2	M	636	5186	3342	871	940	33	0	0

- Molecule 3 is a protein called Gamma-tubulin complex component 3.

Mol	Chain	Residues	Atoms					AltConf	Trace
			Total	C	N	O	S		
3	B	610	5021	3198	888	910	25	0	0
3	D	581	4796	3061	842	868	25	0	0
3	F	599	4933	3146	871	891	25	0	0
3	H	594	4899	3125	864	885	25	0	0
3	a	116	933	591	171	169	2	0	0
3	f	99	803	509	148	144	2	0	0
3	h	99	803	509	148	144	2	0	0

Continued on next page...

Continued from previous page...

Mol	Chain	Residues	Atoms					AltConf	Trace
3	j	107	Total	C	N	O	S	0	0
			864	545	161	156	2		
3	N	594	Total	C	N	O	S	0	0
			4899	3125	864	885	25		

- Molecule 4 is a protein called Gamma-tubulin complex component 4.

Mol	Chain	Residues	Atoms					AltConf	Trace
4	I	521	Total	C	N	O	S	0	0
			4222	2734	720	750	18		
4	K	562	Total	C	N	O	S	0	0
			4579	2964	781	816	18		

- Molecule 5 is a protein called Gamma-tubulin complex component 5.

Mol	Chain	Residues	Atoms					AltConf	Trace
5	J	534	Total	C	N	O	S	0	0
			4406	2879	733	771	23		
5	l	108	Total	C	N	O	S	0	0
			876	556	151	168	1		

- Molecule 6 is a protein called Gamma-tubulin complex component 6.

Mol	Chain	Residues	Atoms					AltConf	Trace
6	L	566	Total	C	N	O	S	0	0
			4556	2977	767	788	24		
6	c	158	Total	C	N	O	S	0	0
			1220	771	209	232	8		

- Molecule 7 is a protein called Tubulin gamma-1 chain.

Mol	Chain	Residues	Atoms					AltConf	Trace
7	O	420	Total	C	N	O	S	0	0
			3371	2133	586	637	15		
7	P	420	Total	C	N	O	S	0	0
			3371	2133	586	637	15		
7	Q	420	Total	C	N	O	S	0	0
			3371	2133	586	637	15		
7	R	420	Total	C	N	O	S	0	0
			3371	2133	586	637	15		
7	S	420	Total	C	N	O	S	0	0
			3371	2133	586	637	15		

Continued on next page...

Continued from previous page...

Mol	Chain	Residues	Atoms					AltConf	Trace
7	T	420	Total	C	N	O	S	0	0
			3371	2133	586	637	15		
7	U	420	Total	C	N	O	S	0	0
			3371	2133	586	637	15		
7	V	420	Total	C	N	O	S	0	0
			3371	2133	586	637	15		
7	W	420	Total	C	N	O	S	0	0
			3371	2133	586	637	15		
7	X	420	Total	C	N	O	S	0	0
			3371	2133	586	637	15		
7	Y	420	Total	C	N	O	S	0	0
			3371	2133	586	637	15		
7	Z	420	Total	C	N	O	S	0	0
			3371	2133	586	637	15		
7	1	420	Total	C	N	O	S	0	0
			3371	2133	586	637	15		
7	2	420	Total	C	N	O	S	0	0
			3371	2133	586	637	15		

- Molecule 8 is a protein called Mitotic-spindle organizing protein 1.

Mol	Chain	Residues	Atoms					AltConf	Trace
8	b	65	Total	C	N	O	S	0	0
			484	299	85	96	4		
8	g	65	Total	C	N	O	S	0	0
			484	299	85	96	4		
8	i	65	Total	C	N	O	S	0	0
			484	299	85	96	4		
8	k	65	Total	C	N	O	S	0	0
			484	299	85	96	4		
8	m	65	Total	C	N	O	S	0	0
			484	299	85	96	4		
8	d	59	Total	C	N	O	S	0	0
			454	281	79	90	4		

3 Residue-property plots

These plots are drawn for all protein, RNA, DNA and oligosaccharide chains in the entry. The first graphic for a chain summarises the proportions of the various outlier classes displayed in the second graphic. The second graphic shows the sequence view annotated by issues in geometry and atom inclusion in map density. Residues are color-coded according to the number of geometric quality criteria for which they contain at least one outlier: green = 0, yellow = 1, orange = 2 and red = 3 or more. A red diamond above a residue indicates a poor fit to the EM map for this residue (all-atom inclusion < 40%). Stretches of 2 or more consecutive residues without any outlier are shown as a green connector. Residues present in the sample, but not in the model, are shown in grey.

- Molecule 1: actin, cytoplasmic 1



- Molecule 2: Gamma-tubulin complex component 2

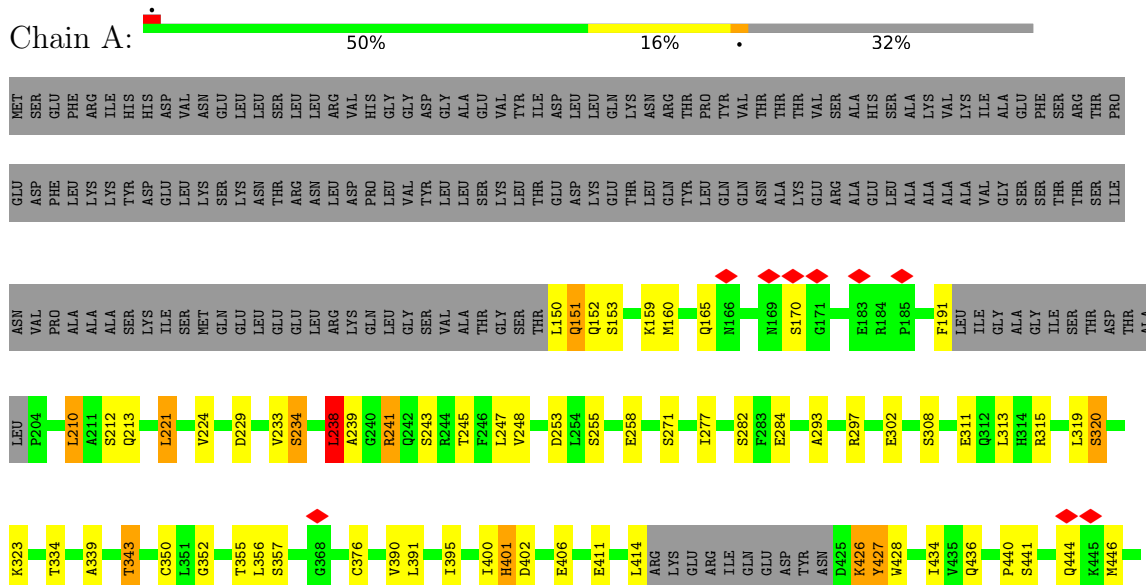

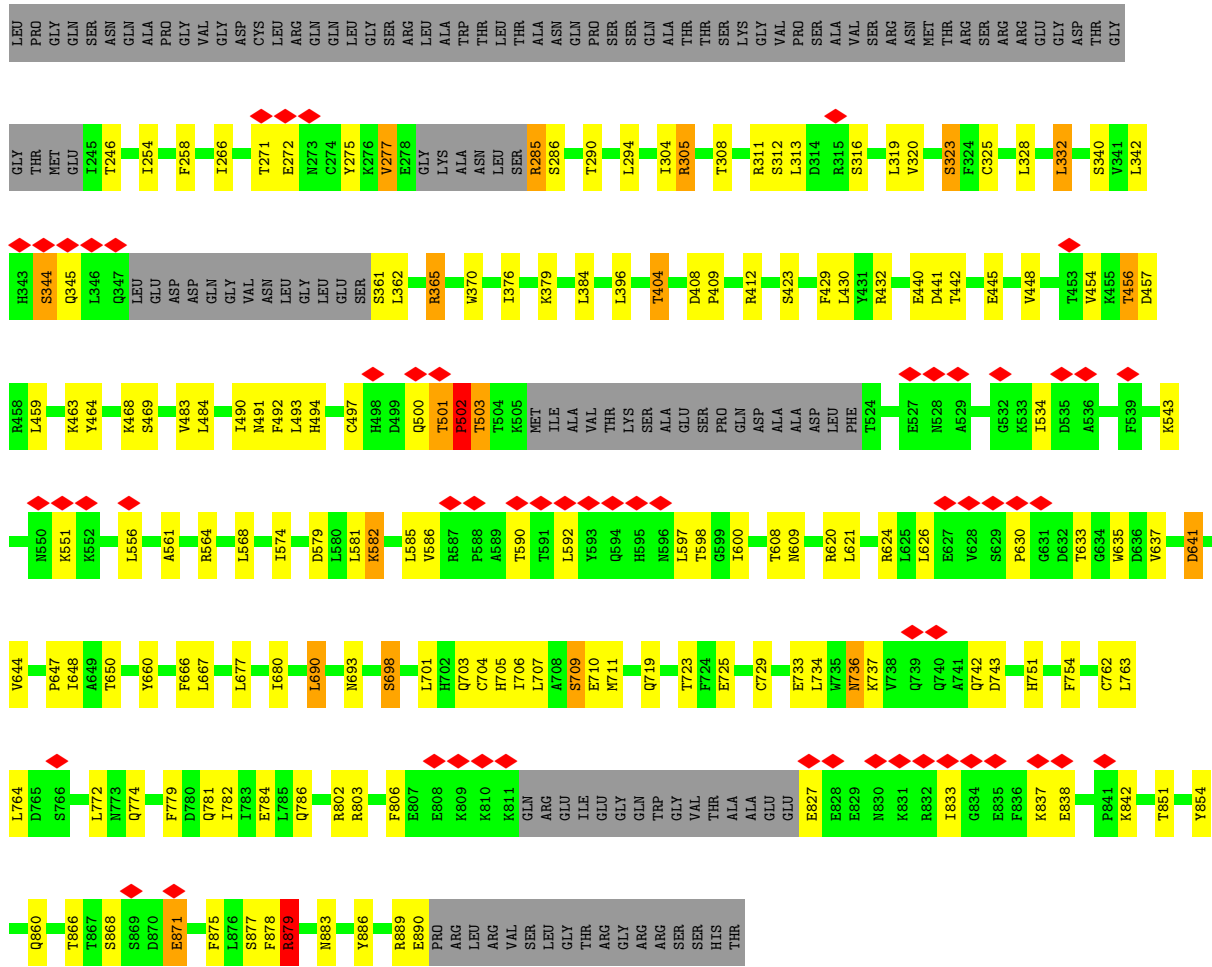

• Molecule 4: Gamma-tubulin complex component 4

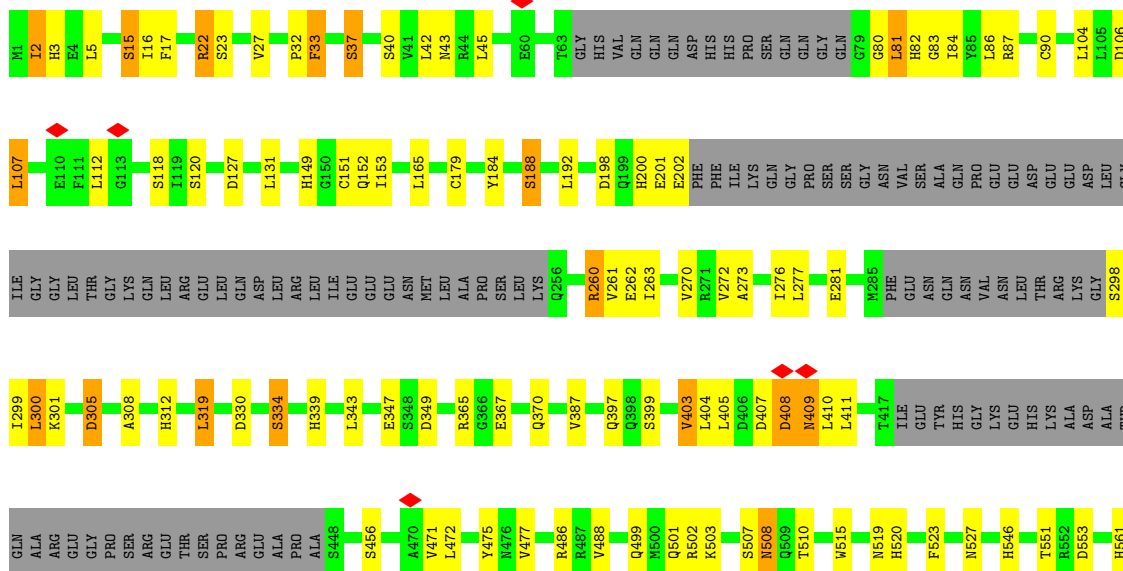

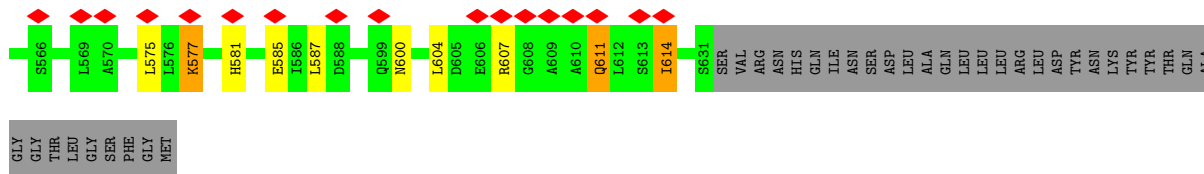

• Molecule 4: Gamma-tubulin complex component 4

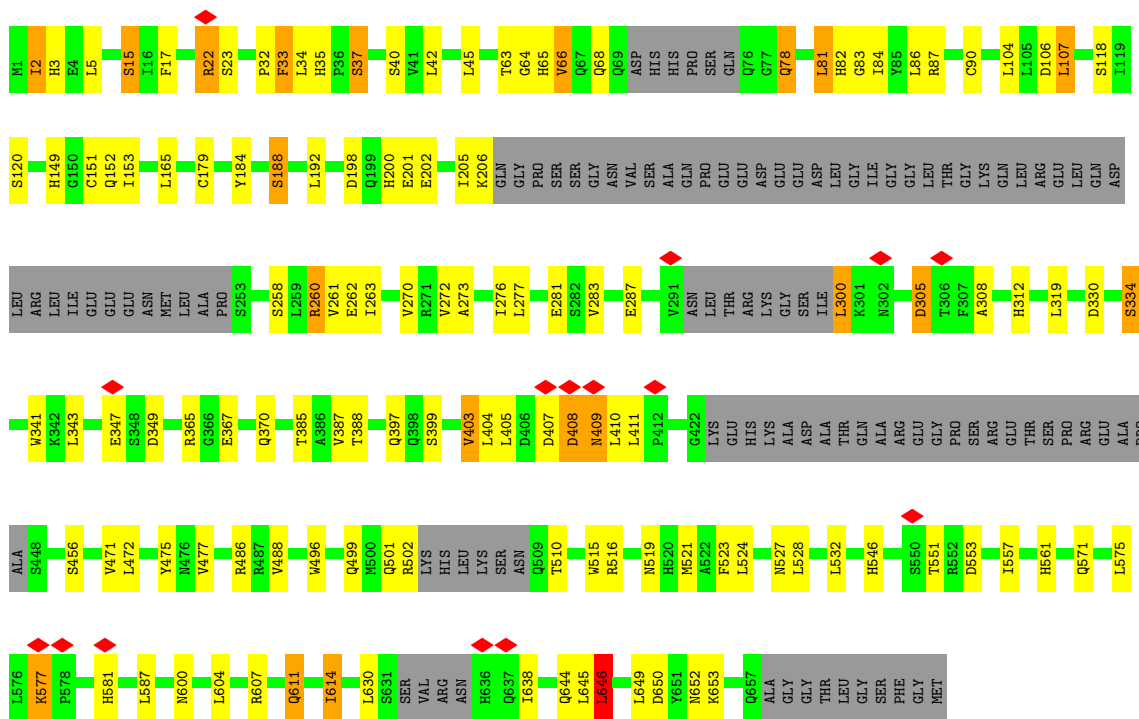

• Molecule 5: Gamma-tubulin complex component 5

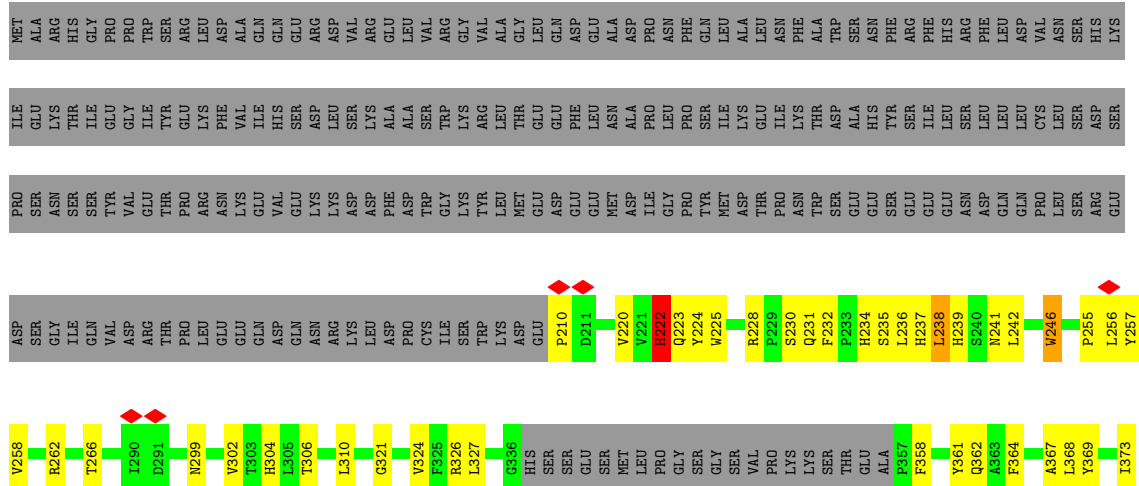

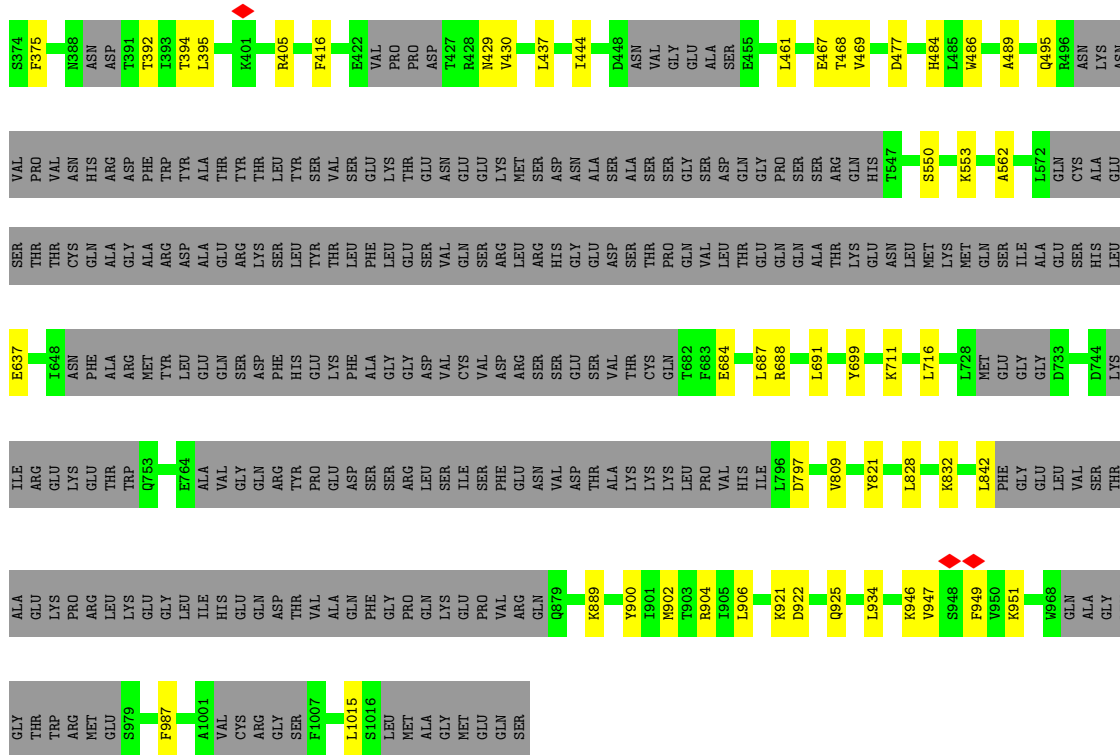

● Molecule 5: Gamma-tubulin complex component 5

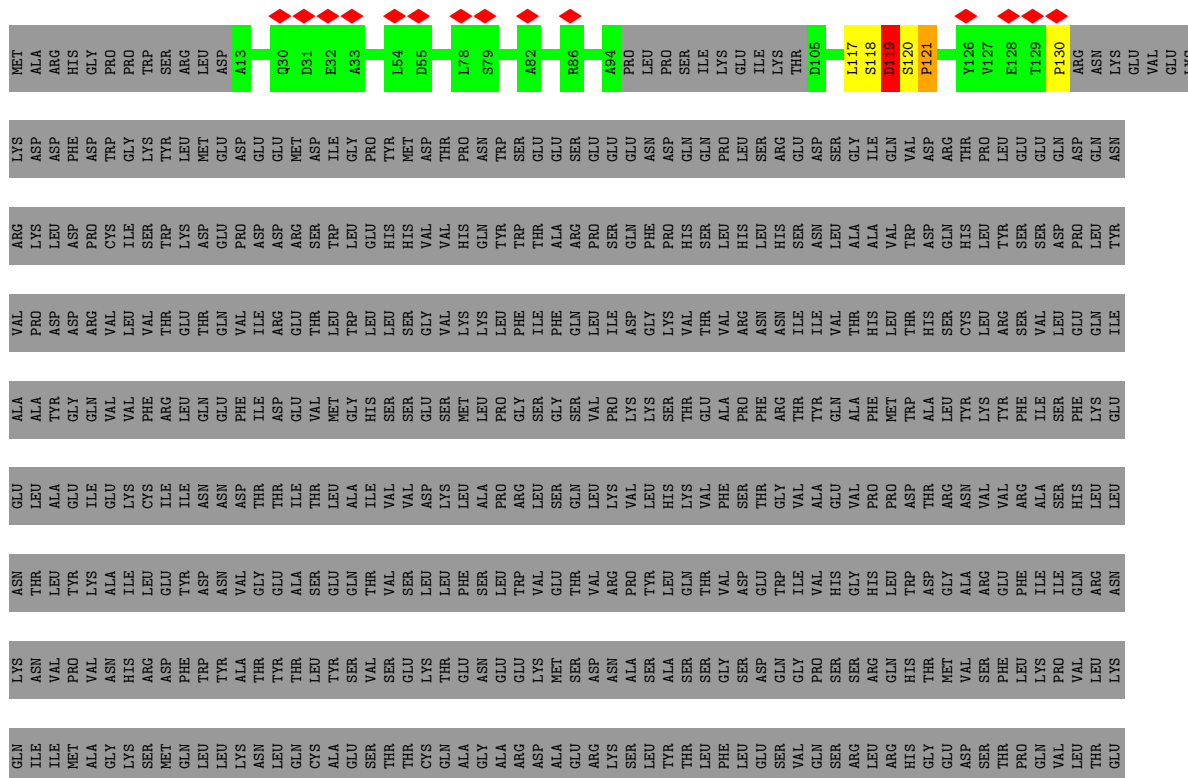

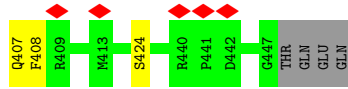

• Molecule 7: Tubulin gamma-1 chain

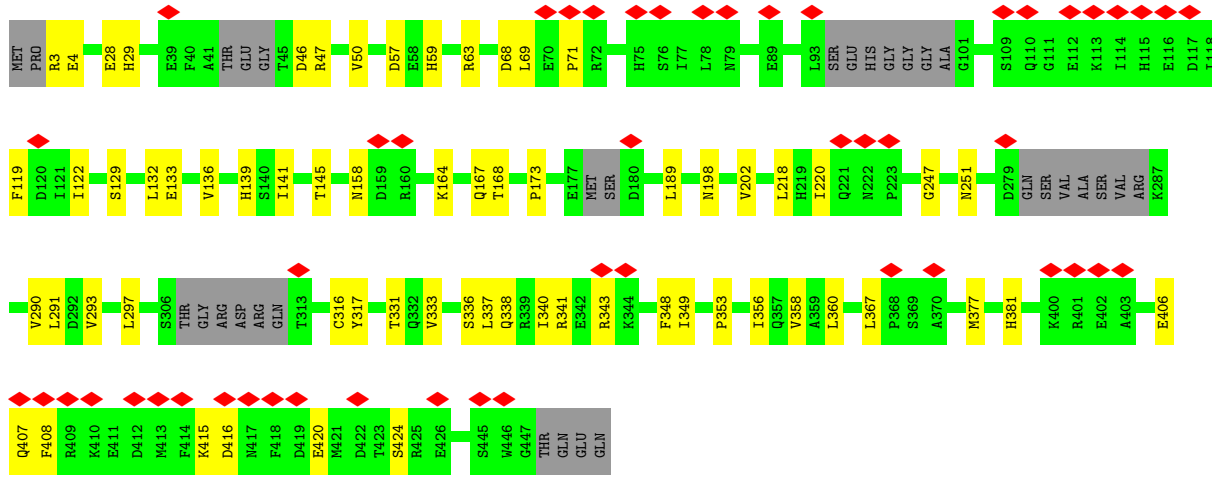
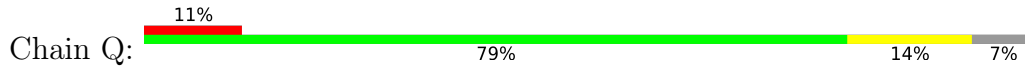

• Molecule 7: Tubulin gamma-1 chain

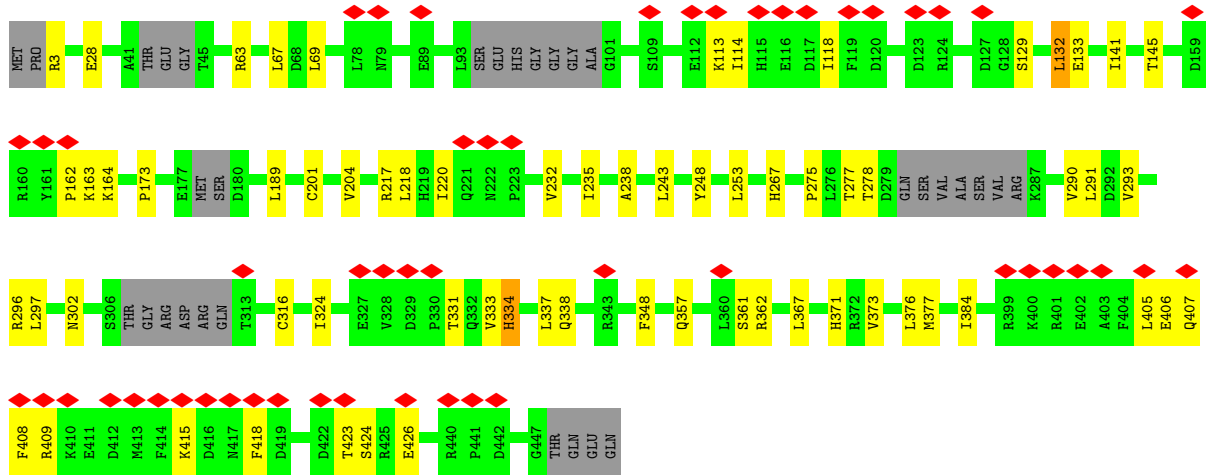
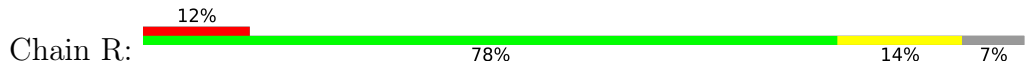

• Molecule 7: Tubulin gamma-1 chain

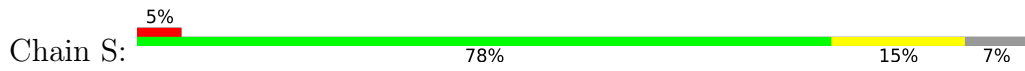

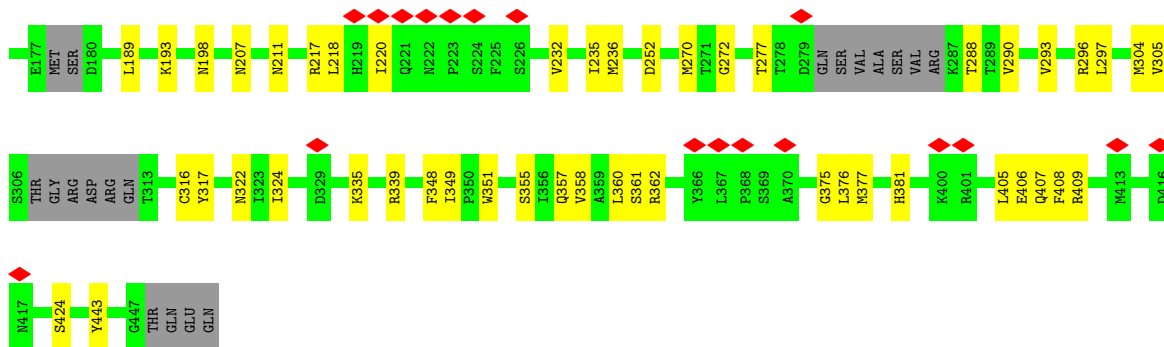

• Molecule 7: Tubulin gamma-1 chain

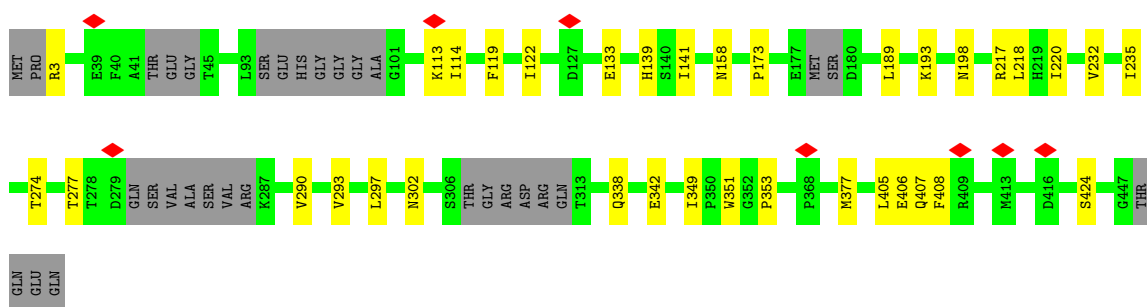
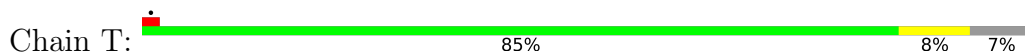

• Molecule 7: Tubulin gamma-1 chain

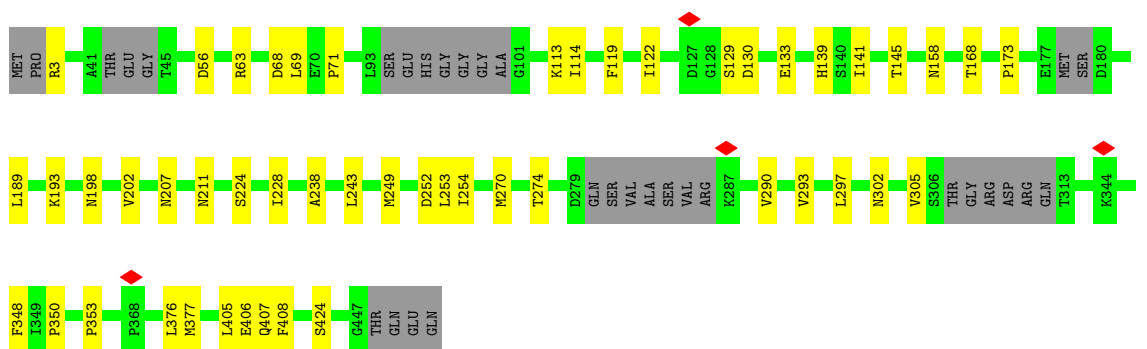
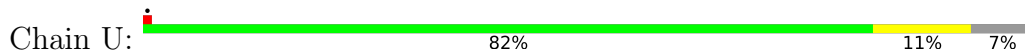

• Molecule 7: Tubulin gamma-1 chain

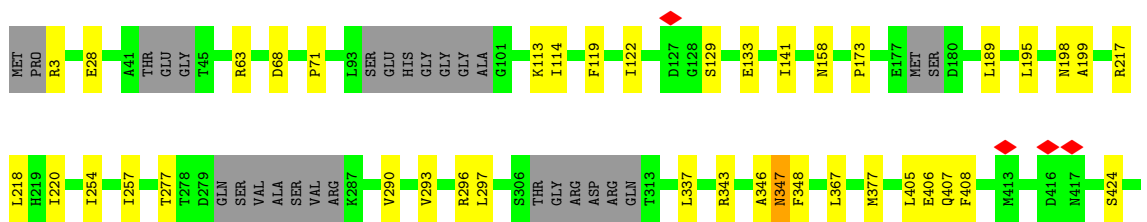
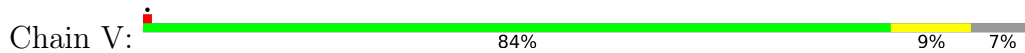

G447
THR
GLN
GLU
GLN

• Molecule 7: Tubulin gamma-1 chain

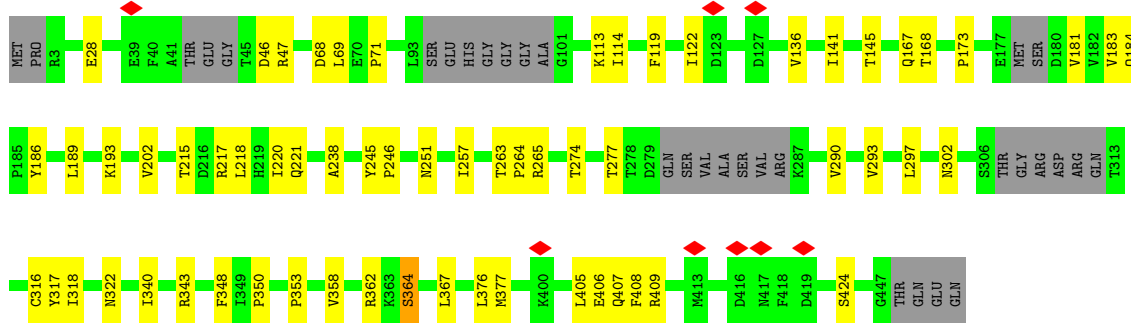
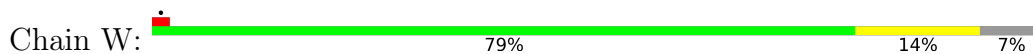

• Molecule 7: Tubulin gamma-1 chain

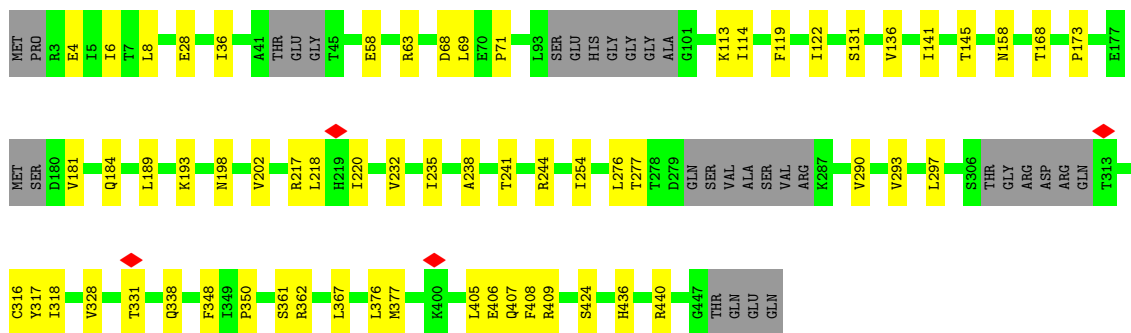
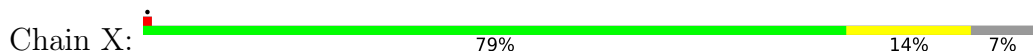

• Molecule 7: Tubulin gamma-1 chain

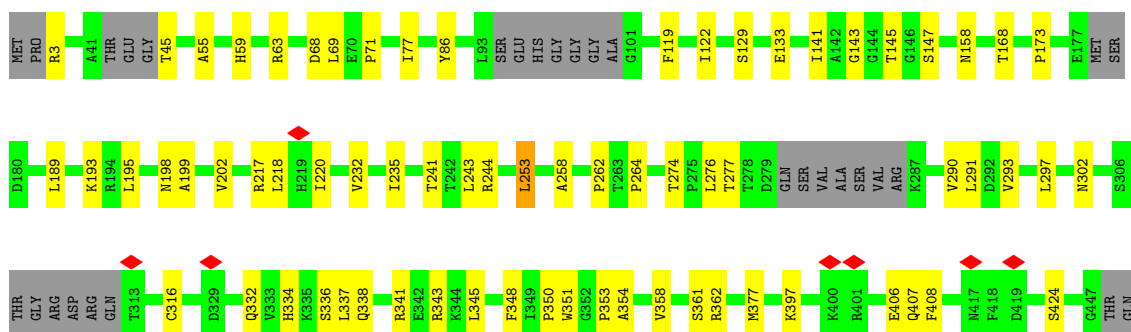
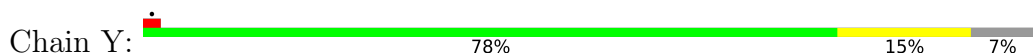

GLN

• Molecule 7: Tubulin gamma-1 chain

Chain Z: 77% 16% 7%

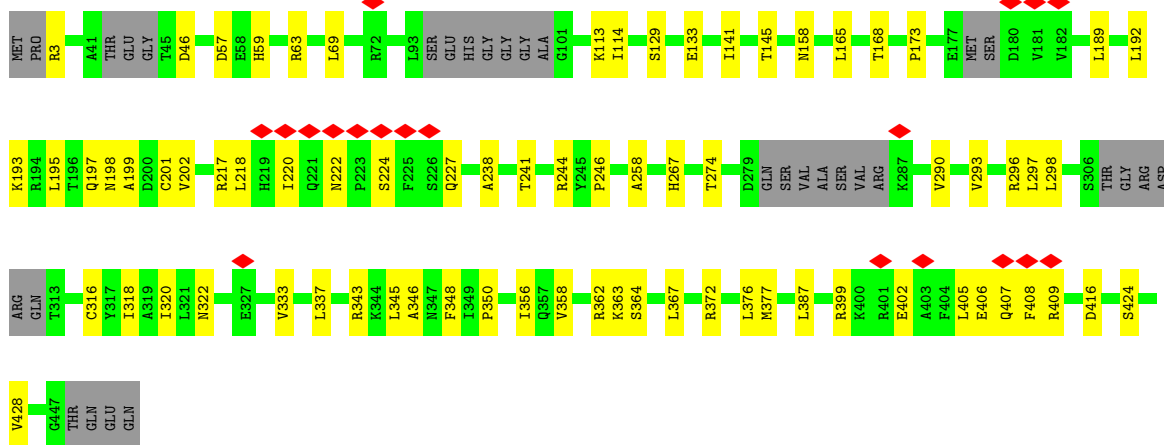

• Molecule 7: Tubulin gamma-1 chain

Chain 1: 83% 10% 7%

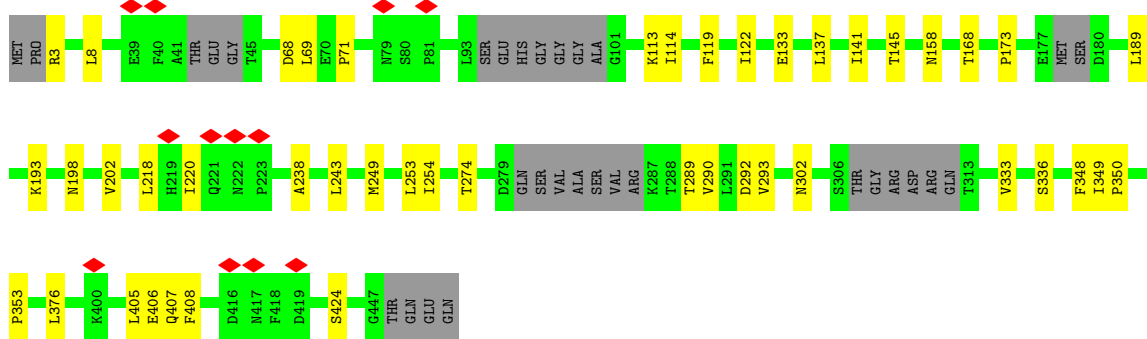

• Molecule 7: Tubulin gamma-1 chain

Chain 2: 7% 81% 12% 7%

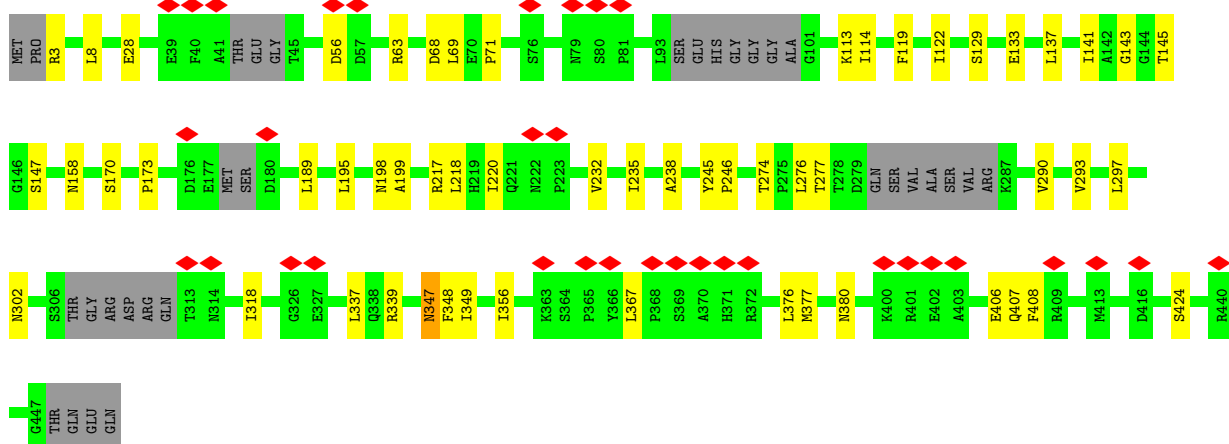

• Molecule 8: Mitotic-spindle organizing protein 1

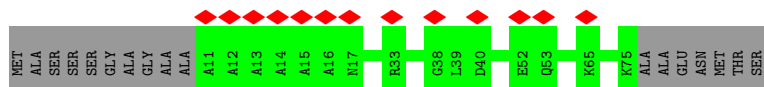
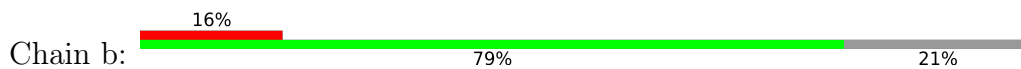

• Molecule 8: Mitotic-spindle organizing protein 1

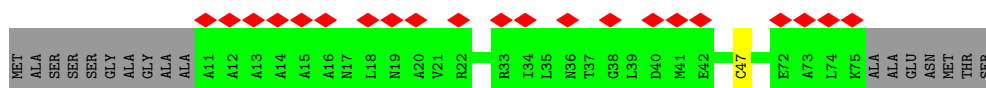
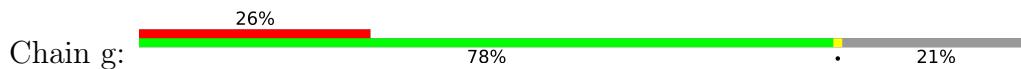

• Molecule 8: Mitotic-spindle organizing protein 1

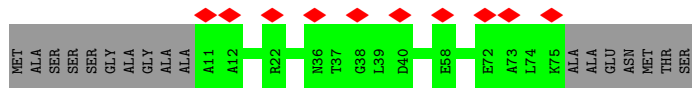
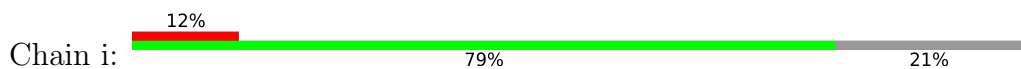

• Molecule 8: Mitotic-spindle organizing protein 1

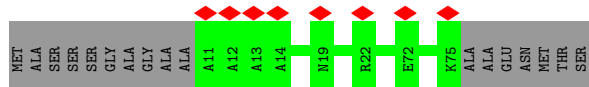
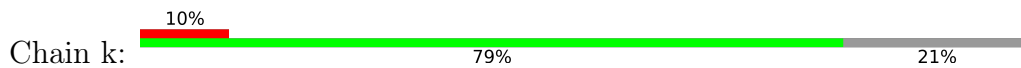

• Molecule 8: Mitotic-spindle organizing protein 1

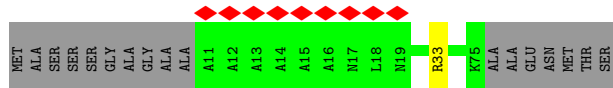
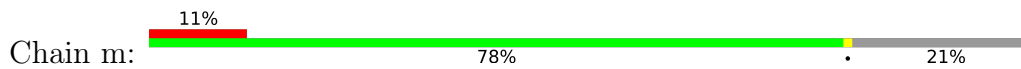

• Molecule 8: Mitotic-spindle organizing protein 1

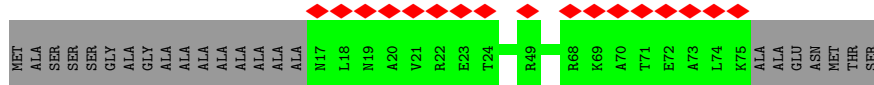
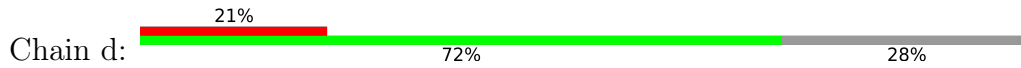

4 Experimental information

Property	Value	Source
EM reconstruction method	SINGLE PARTICLE	Depositor
Imposed symmetry	POINT, Not provided	
Number of particles used	2645	Depositor
Resolution determination method	FSC 0.143 CUT-OFF	Depositor
CTF correction method	PHASE FLIPPING AND AMPLITUDE CORRECTION	Depositor
Microscope	FEI TITAN KRIOS	Depositor
Voltage (kV)	300	Depositor
Electron dose ($e^-/\text{\AA}^2$)	35	Depositor
Minimum defocus (nm)	2000	Depositor
Maximum defocus (nm)	2500	Depositor
Magnification	Not provided	
Image detector	GATAN K3 (6k x 4k)	Depositor
Maximum map value	0.091	Depositor
Minimum map value	-0.035	Depositor
Average map value	0.001	Depositor
Map value standard deviation	0.008	Depositor
Recommended contour level	0.0319	Depositor
Map size (Å)	532.0, 532.0, 532.0	wwPDB
Map dimensions	200, 200, 200	wwPDB
Map angles (°)	90.0, 90.0, 90.0	wwPDB
Pixel spacing (Å)	2.66, 2.66, 2.66	Depositor

5 Model quality i

5.1 Standard geometry i

The Z score for a bond length (or angle) is the number of standard deviations the observed value is removed from the expected value. A bond length (or angle) with $|Z| > 5$ is considered an outlier worth inspection. RMSZ is the root-mean-square of all Z scores of the bond lengths (or angles).

Mol	Chain	Bond lengths		Bond angles	
		RMSZ	# Z >5	RMSZ	# Z >5
1	e	0.49	1/1818 (0.1%)	0.47	0/2525
2	A	0.34	0/5085	0.61	4/6866 (0.1%)
2	C	0.34	0/5151	0.62	6/6955 (0.1%)
2	E	0.34	0/5311	0.62	4/7169 (0.1%)
2	G	0.34	0/5326	0.63	5/7188 (0.1%)
2	M	0.34	0/5295	0.61	4/7147 (0.1%)
3	B	0.33	0/5125	0.62	5/6919 (0.1%)
3	D	0.32	0/4897	0.60	4/6610 (0.1%)
3	F	0.33	0/5036	0.61	4/6798 (0.1%)
3	H	0.33	0/5001	0.62	6/6750 (0.1%)
3	N	0.34	0/5001	0.62	5/6750 (0.1%)
3	a	0.32	0/948	0.57	0/1277
3	f	0.31	0/815	0.58	0/1096
3	h	0.30	0/815	0.56	0/1096
3	j	0.44	0/877	0.75	4/1179 (0.3%)
4	I	0.35	0/4319	0.66	6/5849 (0.1%)
4	K	0.36	0/4683	0.67	7/6338 (0.1%)
5	J	0.39	2/4501 (0.0%)	0.66	4/6089 (0.1%)
5	l	0.36	0/895	0.68	3/1210 (0.2%)
6	L	0.41	2/4666 (0.0%)	0.69	9/6310 (0.1%)
6	c	0.38	0/1235	0.72	3/1664 (0.2%)
7	1	0.34	0/3439	0.62	1/4658 (0.0%)
7	2	0.34	0/3439	0.60	1/4658 (0.0%)
7	O	0.36	0/3439	0.64	1/4658 (0.0%)
7	P	0.37	0/3439	0.68	5/4658 (0.1%)
7	Q	0.36	0/3439	0.66	1/4658 (0.0%)
7	R	0.35	0/3439	0.65	3/4658 (0.1%)
7	S	0.35	0/3439	0.67	4/4658 (0.1%)
7	T	0.34	0/3439	0.60	1/4658 (0.0%)
7	U	0.34	0/3439	0.61	1/4658 (0.0%)
7	V	0.33	0/3439	0.60	2/4658 (0.0%)
7	W	0.33	0/3439	0.60	1/4658 (0.0%)
7	X	0.33	0/3439	0.60	1/4658 (0.0%)
7	Y	0.35	0/3439	0.64	2/4658 (0.0%)

Mol	Chain	Bond lengths		Bond angles	
		RMSZ	# Z >5	RMSZ	# Z >5
7	Z	0.35	0/3439	0.61	1/4658 (0.0%)
8	b	0.36	0/484	0.63	0/653
8	d	0.35	0/454	0.59	0/611
8	g	0.30	0/484	0.57	0/653
8	i	0.30	0/484	0.56	0/653
8	k	0.30	0/484	0.56	0/653
8	m	0.39	0/484	0.69	0/653
All	All	0.35	5/127820 (0.0%)	0.63	108/172873 (0.1%)

Chiral center outliers are detected by calculating the chiral volume of a chiral center and verifying if the center is modelled as a planar moiety or with the opposite hand. A planarity outlier is detected by checking planarity of atoms in a peptide group, atoms in a mainchain group or atoms of a sidechain that are expected to be planar.

Mol	Chain	#Chirality outliers	#Planarity outliers
2	A	0	9
2	C	0	7
2	E	0	7
2	G	0	10
2	M	0	8
3	B	0	3
3	D	0	3
3	F	0	5
3	H	0	7
3	N	0	6
3	j	0	1
4	I	0	7
4	K	0	7
5	J	0	1
5	l	0	3
6	L	0	1
7	2	0	1
7	P	0	2
7	V	0	2
All	All	0	90

All (5) bond length outliers are listed below:

Mol	Chain	Res	Type	Atoms	Z	Observed(Å)	Ideal(Å)
1	e	243	PRO	N-CD	17.75	1.72	1.47
6	L	323	PHE	CD1-CE1	-6.57	1.26	1.39
6	L	297	TRP	CB-CG	-5.91	1.39	1.50

Continued on next page...

Continued from previous page...

Mol	Chain	Res	Type	Atoms	Z	Observed(Å)	Ideal(Å)
5	J	220	VAL	CB-CG1	-5.15	1.42	1.52
5	J	246	TRP	CB-CG	-5.03	1.41	1.50

The worst 5 of 108 bond angle outliers are listed below:

Mol	Chain	Res	Type	Atoms	Z	Observed(°)	Ideal(°)
7	Q	360	LEU	CA-CB-CG	9.23	136.54	115.30
6	L	346	LEU	CA-CB-CG	8.96	135.91	115.30
6	c	82	LEU	CA-CB-CG	8.69	135.29	115.30
6	L	287	LEU	CA-CB-CG	8.54	134.95	115.30
3	D	879	ARG	NE-CZ-NH1	-8.39	116.10	120.30

There are no chirality outliers.

5 of 90 planarity outliers are listed below:

Mol	Chain	Res	Type	Group
2	A	238	LEU	Peptide
2	A	239	ALA	Peptide
2	A	426	LYS	Peptide
2	A	467	VAL	Peptide
2	A	580	HIS	Peptide

5.2 Too-close contacts [i](#)

In the following table, the Non-H and H(model) columns list the number of non-hydrogen atoms and hydrogen atoms in the chain respectively. The H(added) column lists the number of hydrogen atoms added and optimized by MolProbity. The Clashes column lists the number of clashes within the asymmetric unit, whereas Symm-Clashes lists symmetry-related clashes.

Mol	Chain	Non-H	H(model)	H(added)	Clashes	Symm-Clashes
1	e	1818	0	860	0	0
2	A	4978	0	4996	77	0
2	C	5044	0	5081	89	0
2	E	5202	0	5241	75	0
2	G	5217	0	5248	80	0
2	M	5186	0	5219	80	0
3	B	5021	0	5002	82	0
3	D	4796	0	4775	92	0
3	F	4933	0	4919	86	0
3	H	4899	0	4880	81	0
3	N	4899	0	4880	78	0

Continued on next page...

Continued from previous page...

Mol	Chain	Non-H	H(model)	H(added)	Clashes	Symm-Clashes
3	a	933	0	953	0	0
3	f	803	0	831	0	0
3	h	803	0	831	0	0
3	j	864	0	894	0	0
4	I	4222	0	4250	54	0
4	K	4579	0	4586	58	0
5	J	4406	0	4452	53	0
5	l	876	0	842	0	0
6	L	4556	0	4559	40	0
6	c	1220	0	1231	0	0
7	1	3371	0	3320	25	0
7	2	3371	0	3320	28	0
7	O	3371	0	3320	40	0
7	P	3371	0	3320	31	0
7	Q	3371	0	3320	40	0
7	R	3371	0	3320	42	0
7	S	3371	0	3320	34	0
7	T	3371	0	3320	20	0
7	U	3371	0	3320	28	0
7	V	3371	0	3320	19	0
7	W	3371	0	3320	34	0
7	X	3371	0	3320	33	0
7	Y	3371	0	3320	42	0
7	Z	3371	0	3320	38	0
8	b	484	0	512	0	0
8	d	454	0	482	0	0
8	g	484	0	512	0	0
8	i	484	0	512	0	0
8	k	484	0	512	0	0
8	m	484	0	512	0	0
All	All	125323	0	124052	1379	0

The all-atom clashscore is defined as the number of clashes found per 1000 atoms (including hydrogen atoms). The all-atom clashscore for this structure is 6.

The worst 5 of 1379 close contacts within the same asymmetric unit are listed below, sorted by their clash magnitude.

Atom-1	Atom-2	Interatomic distance (Å)	Clash overlap (Å)
3:B:890:GLU:HA	3:B:893:LEU:HD12	1.61	0.80
3:N:345:GLN:HB2	3:N:362:LEU:HD22	1.65	0.77
7:U:270:MET:HG2	7:U:305:VAL:HG21	1.69	0.75

Continued on next page...

Continued from previous page...

Atom-1	Atom-2	Interatomic distance (Å)	Clash overlap (Å)
3:D:879:ARG:HE	7:R:334:HIS:CE1	2.05	0.73
7:R:3:ARG:HB2	7:R:133:GLU:HB2	1.69	0.73

There are no symmetry-related clashes.

5.3 Torsion angles [i](#)

5.3.1 Protein backbone [i](#)

In the following table, the Percentiles column shows the percent Ramachandran outliers of the chain as a percentile score with respect to all PDB entries followed by that with respect to all EM entries.

The Analysed column shows the number of residues for which the backbone conformation was analysed, and the total number of residues.

Mol	Chain	Analysed	Favoured	Allowed	Outliers	Percentiles	
1	e	360/375 (96%)	345 (96%)	15 (4%)	0	100	100
2	A	599/902 (66%)	567 (95%)	31 (5%)	1 (0%)	47	81
2	C	606/902 (67%)	573 (95%)	30 (5%)	3 (0%)	29	69
2	E	626/902 (69%)	587 (94%)	36 (6%)	3 (0%)	29	69
2	G	628/902 (70%)	594 (95%)	33 (5%)	1 (0%)	47	81
2	M	624/902 (69%)	592 (95%)	31 (5%)	1 (0%)	47	81
3	B	602/907 (66%)	568 (94%)	31 (5%)	3 (0%)	29	69
3	D	571/907 (63%)	546 (96%)	25 (4%)	0	100	100
3	F	591/907 (65%)	561 (95%)	29 (5%)	1 (0%)	47	81
3	H	584/907 (64%)	550 (94%)	32 (6%)	2 (0%)	41	77
3	N	584/907 (64%)	551 (94%)	31 (5%)	2 (0%)	41	77
3	a	112/907 (12%)	106 (95%)	6 (5%)	0	100	100
3	f	97/907 (11%)	92 (95%)	5 (5%)	0	100	100
3	h	97/907 (11%)	92 (95%)	5 (5%)	0	100	100
3	j	105/907 (12%)	94 (90%)	11 (10%)	0	100	100
4	I	511/667 (77%)	483 (94%)	23 (4%)	5 (1%)	15	55
4	K	548/667 (82%)	515 (94%)	27 (5%)	6 (1%)	14	52
5	J	506/1024 (49%)	476 (94%)	25 (5%)	5 (1%)	15	55

Continued on next page...

Continued from previous page...

Mol	Chain	Analysed	Favoured	Allowed	Outliers	Percentiles	
5	l	104/1024 (10%)	95 (91%)	6 (6%)	3 (3%)	4	29
6	L	540/1819 (30%)	506 (94%)	29 (5%)	5 (1%)	17	57
6	c	148/1819 (8%)	141 (95%)	7 (5%)	0	100	100
7	1	408/451 (90%)	389 (95%)	18 (4%)	1 (0%)	47	81
7	2	408/451 (90%)	388 (95%)	18 (4%)	2 (0%)	29	69
7	O	408/451 (90%)	392 (96%)	14 (3%)	2 (0%)	29	69
7	P	408/451 (90%)	396 (97%)	11 (3%)	1 (0%)	47	81
7	Q	408/451 (90%)	391 (96%)	16 (4%)	1 (0%)	47	81
7	R	408/451 (90%)	390 (96%)	17 (4%)	1 (0%)	47	81
7	S	408/451 (90%)	391 (96%)	15 (4%)	2 (0%)	29	69
7	T	408/451 (90%)	393 (96%)	14 (3%)	1 (0%)	47	81
7	U	408/451 (90%)	390 (96%)	17 (4%)	1 (0%)	47	81
7	V	408/451 (90%)	389 (95%)	17 (4%)	2 (0%)	29	69
7	W	408/451 (90%)	386 (95%)	21 (5%)	1 (0%)	47	81
7	X	408/451 (90%)	393 (96%)	14 (3%)	1 (0%)	47	81
7	Y	408/451 (90%)	391 (96%)	16 (4%)	1 (0%)	47	81
7	Z	408/451 (90%)	396 (97%)	11 (3%)	1 (0%)	47	81
8	b	63/82 (77%)	62 (98%)	1 (2%)	0	100	100
8	d	57/82 (70%)	56 (98%)	1 (2%)	0	100	100
8	g	63/82 (77%)	63 (100%)	0	0	100	100
8	i	63/82 (77%)	62 (98%)	1 (2%)	0	100	100
8	k	63/82 (77%)	62 (98%)	1 (2%)	0	100	100
8	m	63/82 (77%)	61 (97%)	2 (3%)	0	100	100
All	All	15227/26874 (57%)	14475 (95%)	693 (5%)	59 (0%)	38	72

5 of 59 Ramachandran outliers are listed below:

Mol	Chain	Res	Type
3	B	891	PRO
2	E	425	ASP
3	H	503	THR
4	I	404	LEU
5	J	236	LEU

5.3.2 Protein sidechains [i](#)

In the following table, the Percentiles column shows the percent sidechain outliers of the chain as a percentile score with respect to all PDB entries followed by that with respect to all EM entries.

The Analysed column shows the number of residues for which the sidechain conformation was analysed, and the total number of residues.

Mol	Chain	Analysed	Rotameric	Outliers	Percentiles	
1	e	8/318 (2%)	8 (100%)	0	100	100
2	A	549/791 (69%)	498 (91%)	51 (9%)	9	28
2	C	556/791 (70%)	506 (91%)	50 (9%)	9	30
2	E	574/791 (73%)	524 (91%)	50 (9%)	10	31
2	G	575/791 (73%)	522 (91%)	53 (9%)	9	29
2	M	572/791 (72%)	522 (91%)	50 (9%)	10	31
3	B	548/798 (69%)	497 (91%)	51 (9%)	9	28
3	D	525/798 (66%)	478 (91%)	47 (9%)	9	30
3	F	539/798 (68%)	491 (91%)	48 (9%)	9	30
3	H	536/798 (67%)	489 (91%)	47 (9%)	10	31
3	N	536/798 (67%)	487 (91%)	49 (9%)	9	29
3	a	101/798 (13%)	101 (100%)	0	100	100
3	f	88/798 (11%)	88 (100%)	0	100	100
3	h	88/798 (11%)	88 (100%)	0	100	100
3	j	96/798 (12%)	94 (98%)	2 (2%)	53	72
4	I	471/594 (79%)	435 (92%)	36 (8%)	13	37
4	K	509/594 (86%)	468 (92%)	41 (8%)	11	35
5	J	493/933 (53%)	492 (100%)	1 (0%)	93	96
5	l	96/933 (10%)	96 (100%)	0	100	100
6	L	492/1546 (32%)	485 (99%)	7 (1%)	67	80
6	c	135/1546 (9%)	134 (99%)	1 (1%)	84	90
7	1	375/400 (94%)	375 (100%)	0	100	100
7	2	375/400 (94%)	374 (100%)	1 (0%)	92	95
7	O	375/400 (94%)	374 (100%)	1 (0%)	92	95
7	P	375/400 (94%)	374 (100%)	1 (0%)	92	95
7	Q	375/400 (94%)	375 (100%)	0	100	100

Continued on next page...

Continued from previous page...

Mol	Chain	Analysed	Rotameric	Outliers	Percentiles	
7	R	375/400 (94%)	373 (100%)	2 (0%)	88	93
7	S	375/400 (94%)	374 (100%)	1 (0%)	92	95
7	T	375/400 (94%)	375 (100%)	0	100	100
7	U	375/400 (94%)	375 (100%)	0	100	100
7	V	375/400 (94%)	375 (100%)	0	100	100
7	W	375/400 (94%)	372 (99%)	3 (1%)	81	89
7	X	375/400 (94%)	374 (100%)	1 (0%)	92	95
7	Y	375/400 (94%)	374 (100%)	1 (0%)	92	95
7	Z	375/400 (94%)	369 (98%)	6 (2%)	62	79
8	b	53/62 (86%)	53 (100%)	0	100	100
8	d	53/62 (86%)	53 (100%)	0	100	100
8	g	53/62 (86%)	52 (98%)	1 (2%)	57	75
8	i	53/62 (86%)	53 (100%)	0	100	100
8	k	53/62 (86%)	53 (100%)	0	100	100
8	m	53/62 (86%)	52 (98%)	1 (2%)	57	75
All	All	13655/23573 (58%)	13052 (96%)	603 (4%)	32	53

5 of 603 residues with a non-rotameric sidechain are listed below:

Mol	Chain	Res	Type
4	K	456	SER
3	N	469	SER
6	L	309	GLU
4	K	408	ASP
2	M	308	SER

Sometimes sidechains can be flipped to improve hydrogen bonding and reduce clashes. 5 of 175 such sidechains are listed below:

Mol	Chain	Res	Type
7	U	380	ASN
8	m	36	ASN
7	W	54	GLN
7	Y	198	ASN
3	j	42	ASN

5.3.3 RNA [i](#)

There are no RNA molecules in this entry.

5.4 Non-standard residues in protein, DNA, RNA chains [i](#)

There are no non-standard protein/DNA/RNA residues in this entry.

5.5 Carbohydrates [i](#)

There are no monosaccharides in this entry.

5.6 Ligand geometry [i](#)

There are no ligands in this entry.

5.7 Other polymers [i](#)

There are no such residues in this entry.

5.8 Polymer linkage issues [i](#)

There are no chain breaks in this entry.

6 Map visualisation [i](#)

This section contains visualisations of the EMDB entry EMD-14017. These allow visual inspection of the internal detail of the map and identification of artifacts.

No raw map or half-maps were deposited for this entry and therefore no images, graphs, etc. pertaining to the raw map can be shown.

6.1 Orthogonal projections [i](#)

6.1.1 Primary map

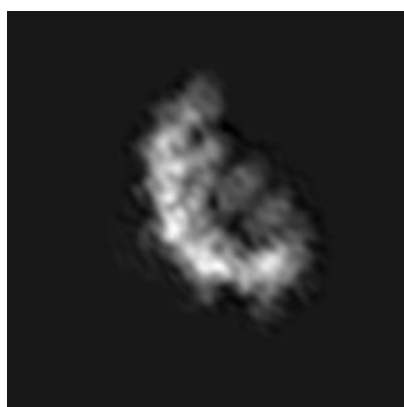

X

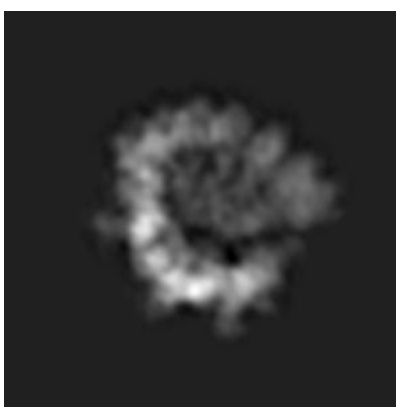

Y



Z

The images above show the map projected in three orthogonal directions.

6.2 Central slices [i](#)

6.2.1 Primary map



X Index: 100



Y Index: 100



Z Index: 100

The images above show central slices of the map in three orthogonal directions.

6.3 Largest variance slices [i](#)

6.3.1 Primary map



X Index: 63



Y Index: 81



Z Index: 71

The images above show the largest variance slices of the map in three orthogonal directions.

6.4 Orthogonal surface views [i](#)

6.4.1 Primary map

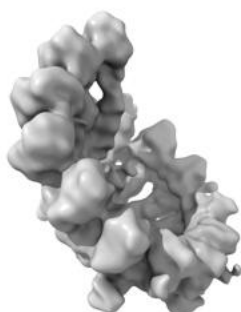

X

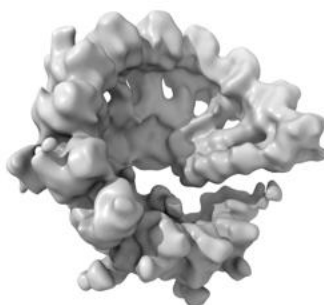

Y

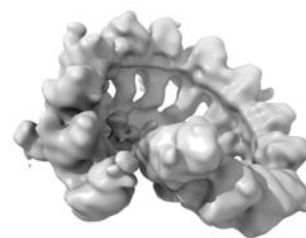

Z

The images above show the 3D surface view of the map at the recommended contour level 0.0319. These images, in conjunction with the slice images, may facilitate assessment of whether an appropriate contour level has been provided.

6.5 Mask visualisation

This section was not generated. No masks/segmentation were deposited.

7 Map analysis [i](#)

This section contains the results of statistical analysis of the map.

7.1 Map-value distribution [i](#)

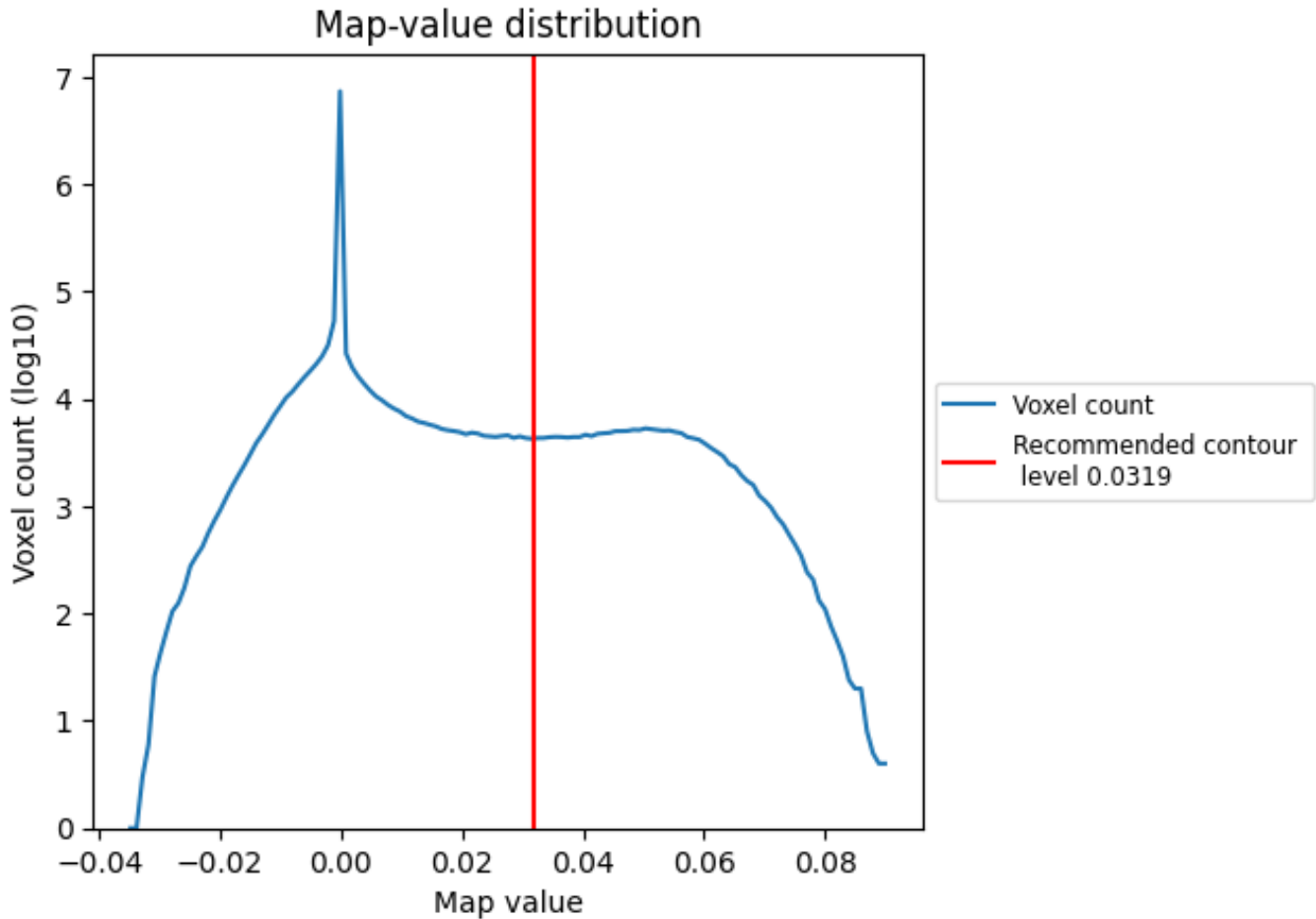

The map-value distribution is plotted in 128 intervals along the x-axis. The y-axis is logarithmic. A spike in this graph at zero usually indicates that the volume has been masked.

7.2 Volume estimate [\(i\)](#)

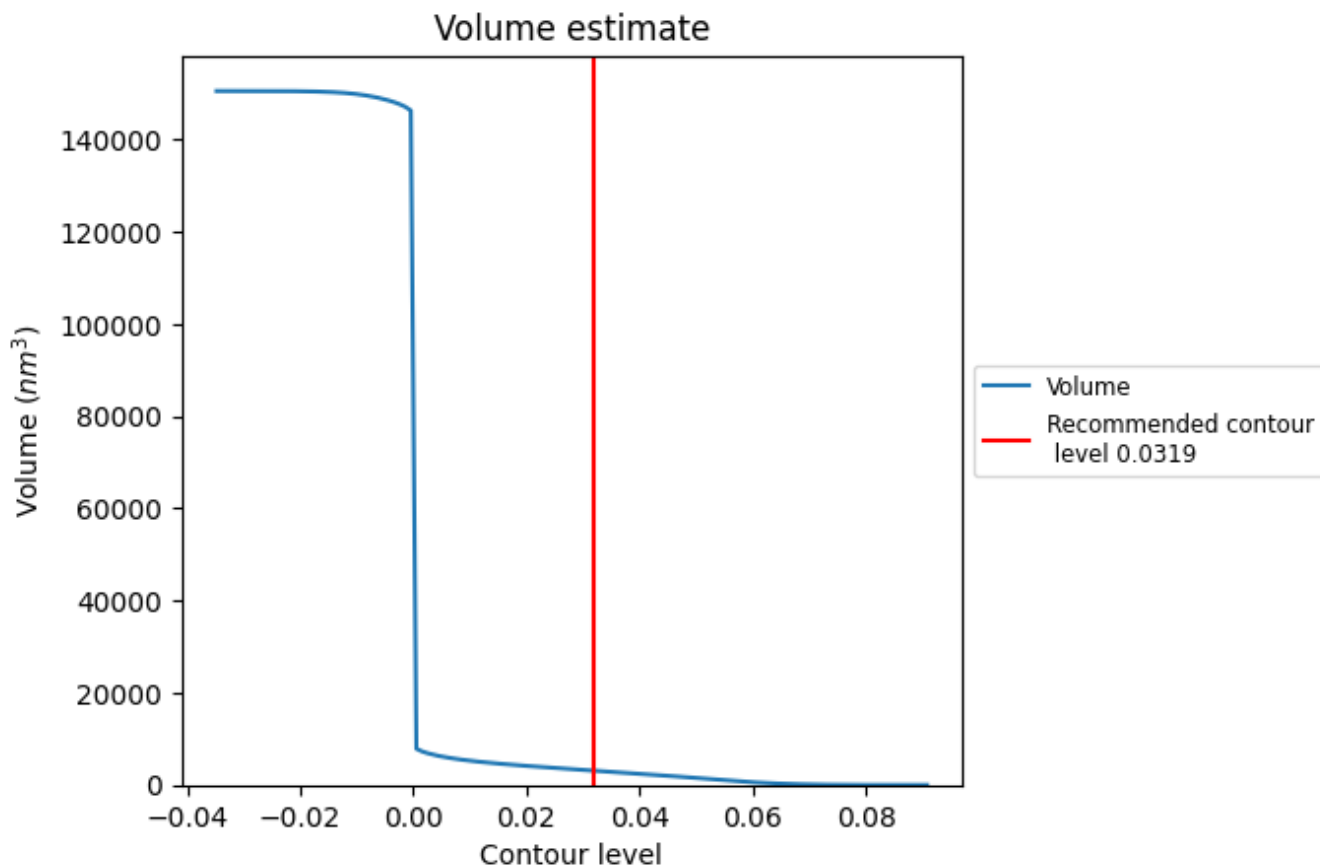

The volume at the recommended contour level is 3109 nm³; this corresponds to an approximate mass of 2809 kDa.

The volume estimate graph shows how the enclosed volume varies with the contour level. The recommended contour level is shown as a vertical line and the intersection between the line and the curve gives the volume of the enclosed surface at the given level.

7.3 Rotationally averaged power spectrum [i](#)

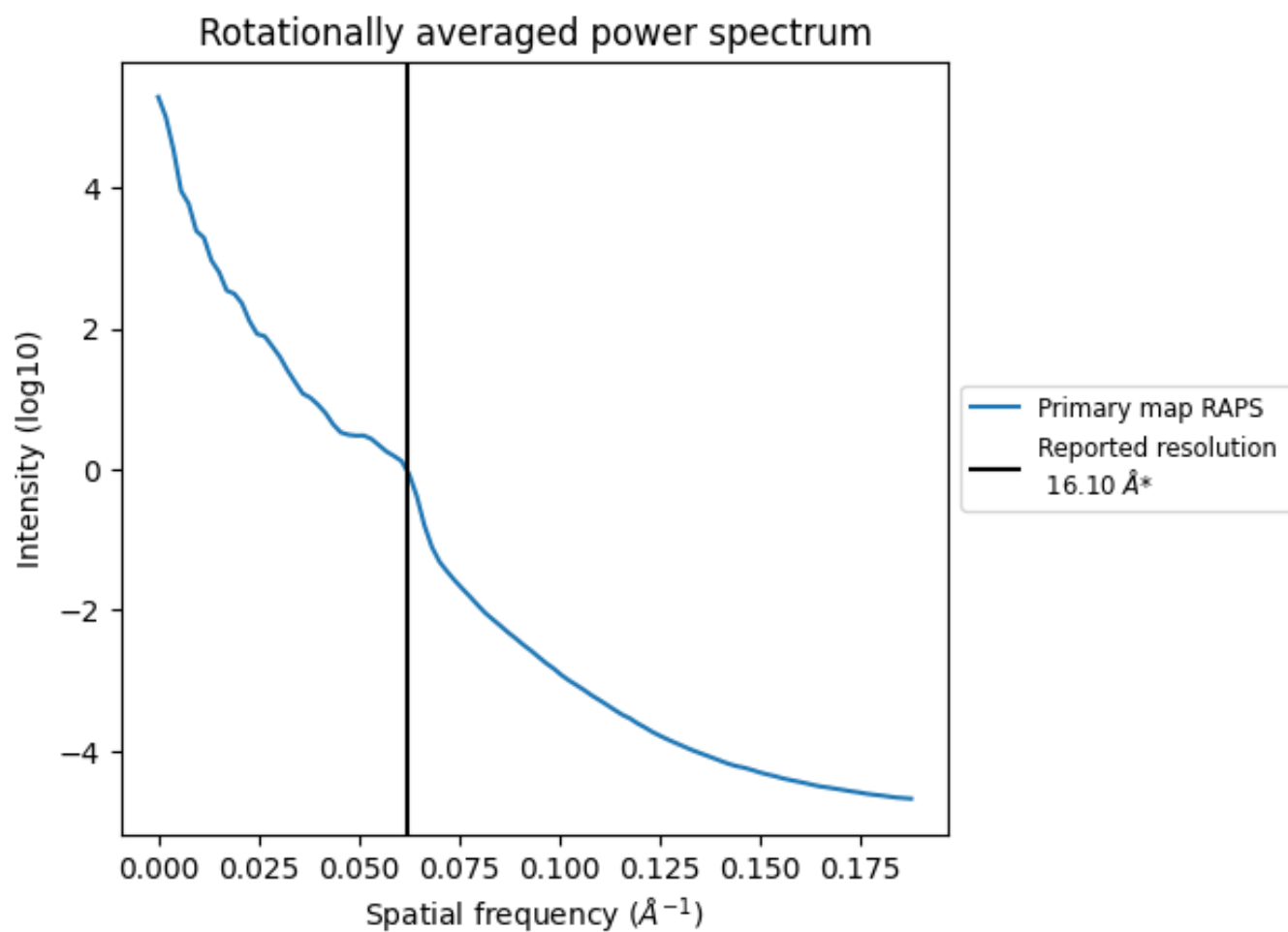

*Reported resolution corresponds to spatial frequency of 0.062 Å⁻¹

8 Fourier-Shell correlation

This section was not generated. No FSC curve or half-maps provided.

9 Map-model fit [i](#)

This section contains information regarding the fit between EMDB map EMD-14017 and PDB model 7QJC. Per-residue inclusion information can be found in section 3 on page 8.

9.1 Map-model overlay [i](#)

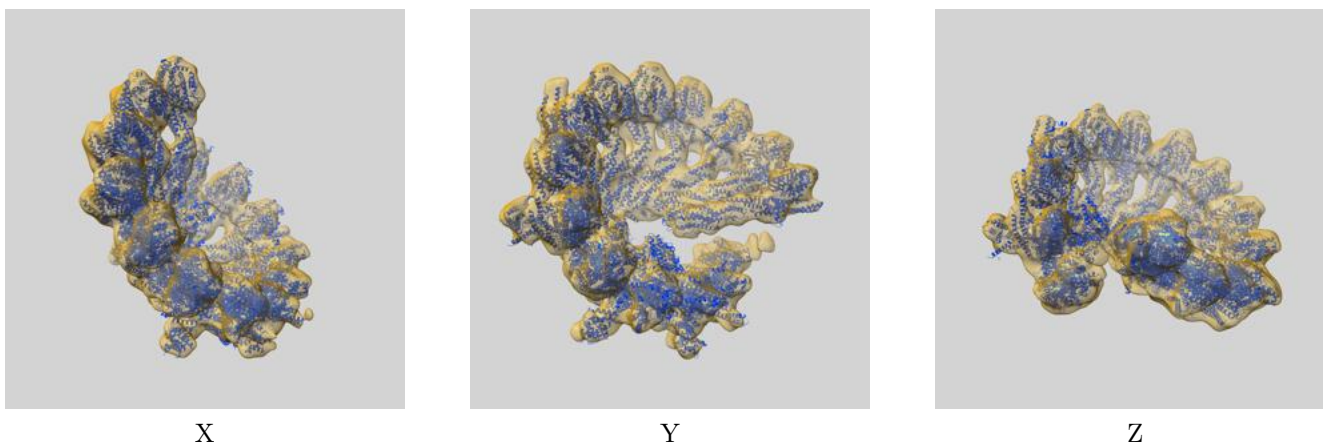

The images above show the 3D surface view of the map at the recommended contour level 0.0319 at 50% transparency in yellow overlaid with a ribbon representation of the model coloured in blue. These images allow for the visual assessment of the quality of fit between the atomic model and the map.

9.2 Atom inclusion [i](#)

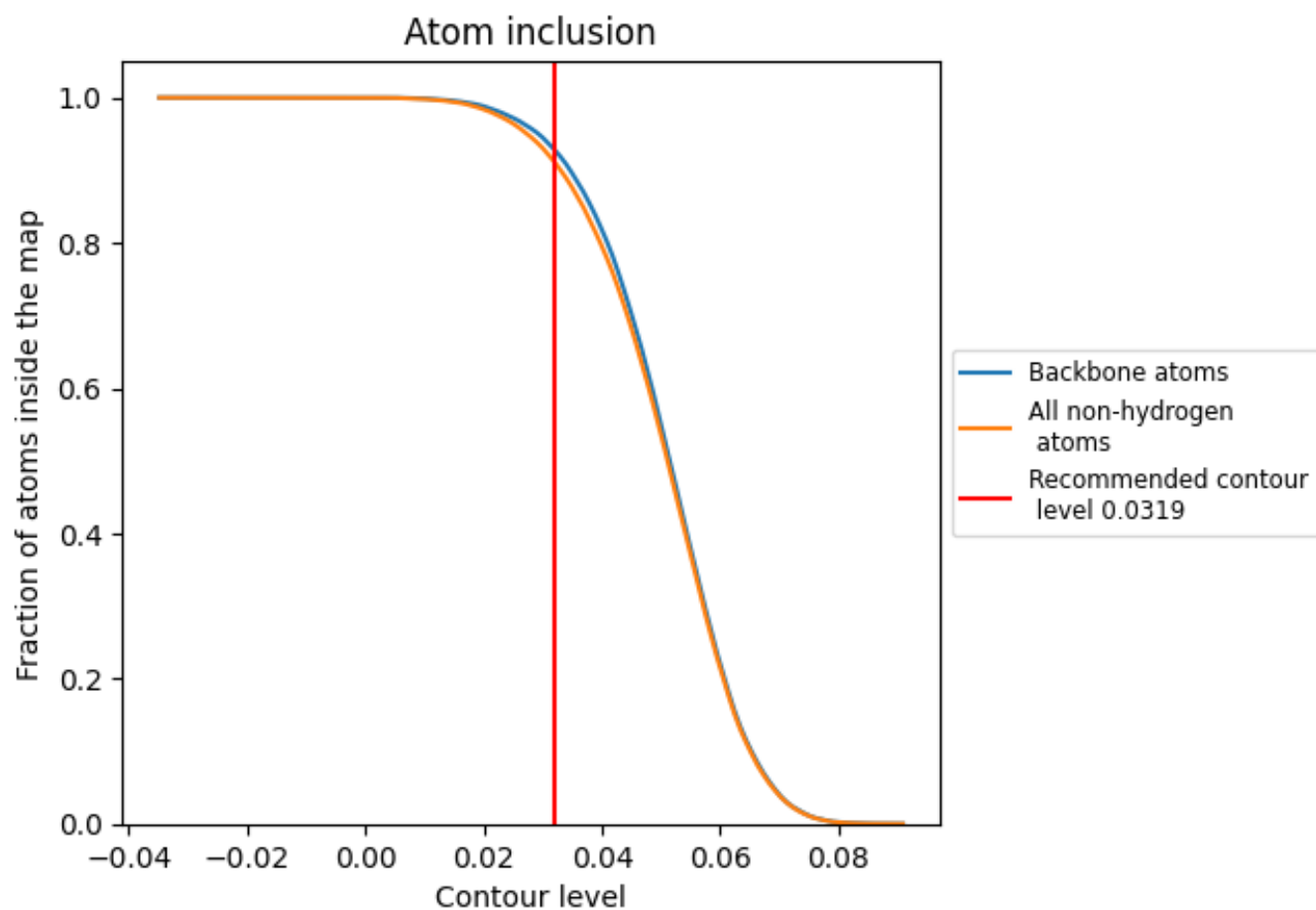

At the recommended contour level, 93% of all backbone atoms, 91% of all non-hydrogen atoms, are inside the map.