



wwPDB EM Validation Summary Report ⓘ

Dec 31, 2024 – 10:54 PM EST

PDB ID : 8QO9
EMDB ID : EMD-18529
Title : Cryo-EM structure of a human spliceosomal B complex protomer
Authors : Zhang, Z.; Kumar, V.; Dybkov, O.; Will, C.L.; Urlaub, H.; Stark, H.;
Luehrmann, R.
Deposited on : 2023-09-28
Resolution : 5.29 Å(reported)

This is a wwPDB EM Validation Summary Report for a publicly released PDB entry.

We welcome your comments at validation@mail.wwpdb.org

A user guide is available at

<https://www.wwpdb.org/validation/2017/EMValidationReportHelp>

with specific help available everywhere you see the ⓘ symbol.

The types of validation reports are described at

<http://www.wwpdb.org/validation/2017/FAQs#types>.

The following versions of software and data (see [references ⓘ](#)) were used in the production of this report:

EMDB validation analysis : 0.0.1.dev113
MolProbity : 4.02b-467
Percentile statistics : 20231227.v01 (using entries in the PDB archive December 27th 2023)
MapQ : 1.9.13
Ideal geometry (proteins) : Engh & Huber (2001)
Ideal geometry (DNA, RNA) : Parkinson et al. (1996)
Validation Pipeline (wwPDB-VP) : 2.40

1 Overall quality at a glance

The following experimental techniques were used to determine the structure:
ELECTRON MICROSCOPY

The reported resolution of this entry is 5.29 Å.

Percentile scores (ranging between 0-100) for global validation metrics of the entry are shown in the following graphic. The table shows the number of entries on which the scores are based.

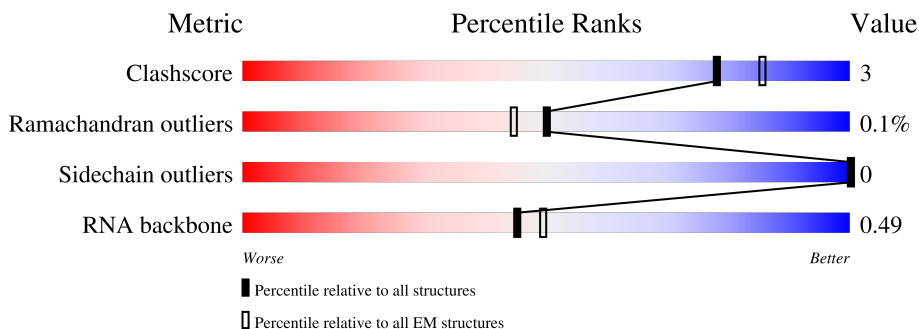











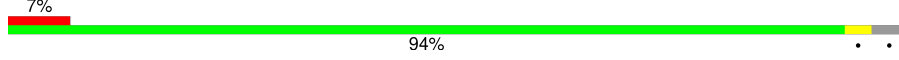



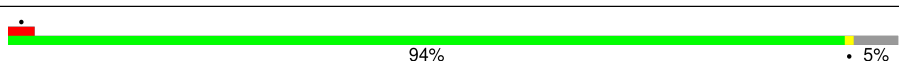
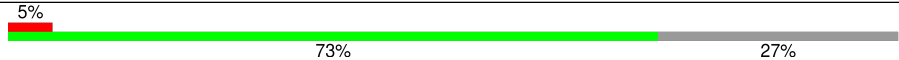



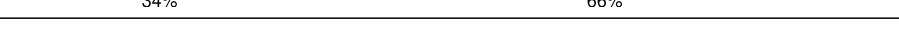

Metric	Whole archive (#Entries)	EM structures (#Entries)
Clashscore	210492	15764
Ramachandran outliers	207382	16835
Sidechain outliers	206894	16415
RNA backbone	6643	2191

The table below summarises the geometric issues observed across the polymeric chains and their fit to the map. The red, orange, yellow and green segments of the bar indicate the fraction of residues that contain outliers for ≥ 3 , 2, 1 and 0 types of geometric quality criteria respectively. A grey segment represents the fraction of residues that are not modelled. The numeric value for each fraction is indicated below the corresponding segment, with a dot representing fractions $\leq 5\%$. The upper red bar (where present) indicates the fraction of residues that have poor fit to the EM map (all-atom inclusion $< 40\%$). The numeric value is given above the bar.

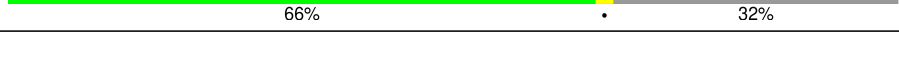
Mol	Chain	Length	Quality of chain
1	B4	424	
2	8	464	
2	G	464	
3	9	501	
3	H	501	
4	B2	895	
5	B5	86	

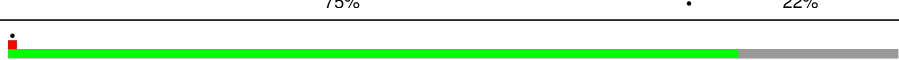
Continued on next page...

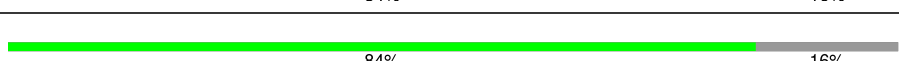
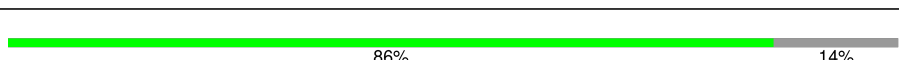
Continued from previous page...

Mol	Chain	Length	Quality of chain
6	2	188	
7	B3	1217	
8	BP	110	
9	B1	1304	
10	B6	125	
11	62	95	
12	63	102	
13	64	139	
14	65	91	
15	66	80	
16	67	103	
17	68	96	
18	2b	240	
18	4b	240	
18	5b	240	
19	21	119	
19	41	119	
19	51	119	
20	22	118	
20	42	118	
20	52	118	
21	2f	86	
21	4f	86	
21	5f	86	
22	2e	92	

Continued on next page...

Continued from previous page...

Mol	Chain	Length	Quality of chain
22	4e	92	83% 17%
22	5e	92	86% 14%
23	2g	76	22% 96%
23	4g	76	97%
23	5g	76	97%
24	23	126	63% 34%
24	43	126	66% 34%
24	53	126	61% 39%
25	2B	225	11% 40% 59%
26	2A	255	11% 62% 36%
27	7	793	14% 26% 74%
28	E	357	83% 16%
29	B	2136	78% 21%
30	x	557	7% 93%
30	y	557	6% 93%
31	v	513	5% 97%
31	w	513	13% 96%
32	z	248	30% 70%
33	W	177	86% 10% 5%
34	5	117	27% 51% 18%
35	Q	144	97%
36	D	142	98%
37	X	376	21% 78%
38	K	439	48% 52%
39	Z	347	6% 5% 87%

Continued on next page...

Continued from previous page...

Mol	Chain	Length	Quality of chain
40	L	499	 74% 25%
41	F	522	 80% 17%
42	N	941	 81% 16%
43	A	2335	 94%
44	I	312	 57% 41%
45	S	800	 21% 79%
46	C	972	 85% 13%
47	M	128	 94%
48	T	1098	 37% 62%
49	4	144	 42% 36% 10% 12%
50	6	106	 33% 40% 15% 11%
51	r	199	 57% 43%
52	J	683	 38% 62%
53	s	73	 100%

2 Entry composition [i](#)

There are 53 unique types of molecules in this entry. The entry contains 87322 atoms, of which 0 are hydrogens and 0 are deuteriums.

In the tables below, the AltConf column contains the number of residues with at least one atom in alternate conformation and the Trace column contains the number of residues modelled with at most 2 atoms.

- Molecule 1 is a protein called Splicing factor 3B subunit 4.

Mol	Chain	Residues	Atoms				AltConf	Trace
			Total	C	N	O		
1	B4	78	391	235	78	78	0	0

- Molecule 2 is a protein called Splicing factor 3A subunit 2.

Mol	Chain	Residues	Atoms				AltConf	Trace
			Total	C	N	O		
2	8	100	510	310	100	100	0	0
2	G	44	219	131	44	44	0	0

- Molecule 3 is a protein called Splicing factor 3A subunit 3.

Mol	Chain	Residues	Atoms				AltConf	Trace
			Total	C	N	O		
3	9	313	1569	943	313	313	0	0
3	H	70	351	211	70	70	0	0

- Molecule 4 is a protein called Splicing factor 3B subunit 2.

Mol	Chain	Residues	Atoms				AltConf	Trace
			Total	C	N	O		
4	B2	208	1072	656	208	208	0	0

- Molecule 5 is a protein called Splicing factor 3B subunit 5.

Mol	Chain	Residues	Atoms				AltConf	Trace
			Total	C	N	O		
5	B5	69	347	209	69	69	0	0

- Molecule 6 is a RNA chain called U2 snRNA.

Mol	Chain	Residues	Atoms					AltConf	Trace
			Total	C	N	O	P		
6	2	98	2071	926	349	698	98	0	0

There is a discrepancy between the modelled and reference sequences:

Chain	Residue	Modelled	Actual	Comment	Reference
2	97	A	G	conflict	GB 36516

- Molecule 7 is a protein called Splicing factor 3B subunit 3.

Mol	Chain	Residues	Atoms				AltConf	Trace
			Total	C	N	O		
7	B3	1174	5908	3560	1174	1174	0	0

- Molecule 8 is a protein called PHD finger-like domain-containing protein 5A.

Mol	Chain	Residues	Atoms				AltConf	Trace
			Total	C	N	O		
8	BP	100	498	298	100	100	0	0

- Molecule 9 is a protein called Splicing factor 3B subunit 1.

Mol	Chain	Residues	Atoms				AltConf	Trace
			Total	C	N	O		
9	B1	870	4383	2643	870	870	0	0

- Molecule 10 is a protein called Splicing factor 3B subunit 6.

Mol	Chain	Residues	Atoms				AltConf	Trace
			Total	C	N	O		
10	B6	90	455	275	90	90	0	0

- Molecule 11 is a protein called U6 snRNA-associated Sm-like protein LSm2.

Mol	Chain	Residues	Atoms				AltConf	Trace
			Total	C	N	O		
11	62	90	360	180	90	90	0	0

- Molecule 12 is a protein called U6 snRNA-associated Sm-like protein LSm3.

Mol	Chain	Residues	Atoms				AltConf	Trace
			Total	C	N	O		
12	63	74	296	148	74	74	0	0

- Molecule 13 is a protein called U6 snRNA-associated Sm-like protein LSm4.

Mol	Chain	Residues	Atoms				AltConf	Trace
			Total	C	N	O		
13	64	74	296	148	74	74	0	0

- Molecule 14 is a protein called U6 snRNA-associated Sm-like protein LSm5.

Mol	Chain	Residues	Atoms				AltConf	Trace
			Total	C	N	O		
14	65	72	288	144	72	72	0	0

- Molecule 15 is a protein called U6 snRNA-associated Sm-like protein LSm6.

Mol	Chain	Residues	Atoms				AltConf	Trace
			Total	C	N	O		
15	66	70	280	140	70	70	0	0

- Molecule 16 is a protein called U6 snRNA-associated Sm-like protein LSm7.

Mol	Chain	Residues	Atoms				AltConf	Trace
			Total	C	N	O		
16	67	65	260	130	65	65	0	0

- Molecule 17 is a protein called U6 snRNA-associated Sm-like protein LSm8.

Mol	Chain	Residues	Atoms				AltConf	Trace
			Total	C	N	O		
17	68	61	244	122	61	61	0	0

- Molecule 18 is a protein called Small nuclear ribonucleoprotein-associated proteins B and B'.

Mol	Chain	Residues	Atoms				AltConf	Trace
			Total	C	N	O		
18	5b	86	344	172	86	86	0	0
18	2b	82	413	249	82	82	0	0

Continued on next page...

Continued from previous page...

Mol	Chain	Residues	Atoms				AltConf	Trace
			Total	C	N	O		
18	4b	82	413	249	82	82	0	0

- Molecule 19 is a protein called Small nuclear ribonucleoprotein Sm D1.

Mol	Chain	Residues	Atoms				AltConf	Trace
			Total	C	N	O		
19	51	82	328	164	82	82	0	0
19	21	80	402	242	80	80	0	0
19	41	81	407	245	81	81	0	0

- Molecule 20 is a protein called Small nuclear ribonucleoprotein Sm D2.

Mol	Chain	Residues	Atoms				AltConf	Trace
			Total	C	N	O		
20	52	97	388	194	97	97	0	0
20	22	95	482	292	95	95	0	0
20	42	92	463	279	92	92	0	0

- Molecule 21 is a protein called Small nuclear ribonucleoprotein F.

Mol	Chain	Residues	Atoms				AltConf	Trace
			Total	C	N	O		
21	5f	74	296	148	74	74	0	0
21	2f	72	359	215	72	72	0	0
21	4f	72	359	215	72	72	0	0

- Molecule 22 is a protein called Small nuclear ribonucleoprotein E.

Mol	Chain	Residues	Atoms				AltConf	Trace
			Total	C	N	O		
22	5e	79	316	158	79	79	0	0
22	2e	81	403	241	81	81	0	0
22	4e	76	378	226	76	76	0	0

- Molecule 23 is a protein called Small nuclear ribonucleoprotein G.

Mol	Chain	Residues	Atoms				AltConf	Trace
23	5g	74	Total	C	N	O	0	0
			296	148	74	74		
23	2g	73	Total	C	N	O	0	0
			364	218	73	73		
23	4g	74	Total	C	N	O	0	0
			369	221	74	74		

- Molecule 24 is a protein called Small nuclear ribonucleoprotein Sm D3.

Mol	Chain	Residues	Atoms				AltConf	Trace
24	53	77	Total	C	N	O	0	0
			308	154	77	77		
24	23	83	Total	C	N	O	0	0
			415	249	83	83		
24	43	83	Total	C	N	O	0	0
			415	249	83	83		

- Molecule 25 is a protein called U2 small nuclear ribonucleoprotein B'.

Mol	Chain	Residues	Atoms				AltConf	Trace
25	2B	92	Total	C	N	O	0	0
			461	277	92	92		

- Molecule 26 is a protein called U2 small nuclear ribonucleoprotein A'.

Mol	Chain	Residues	Atoms				AltConf	Trace
26	2A	162	Total	C	N	O	0	0
			816	492	162	162		

- Molecule 27 is a protein called Splicing factor 3A subunit 1.

Mol	Chain	Residues	Atoms				AltConf	Trace
27	7	204	Total	C	N	O	0	0
			1028	620	204	204		

- Molecule 28 is a protein called U5 small nuclear ribonucleoprotein 40 kDa protein.

Mol	Chain	Residues	Atoms				AltConf	Trace
28	E	299	Total	C	N	O	0	0
			1196	598	299	299		

- Molecule 29 is a protein called U5 small nuclear ribonucleoprotein 200 kDa helicase.

Mol	Chain	Residues	Atoms				AltConf	Trace
			Total	C	N	O		
29	B	1693	8538	5154	1693	1691	0	0

- Molecule 30 is a protein called Protein Red.

Mol	Chain	Residues	Atoms				AltConf	Trace
			Total	C	N	O		
30	x	39	197	119	39	39	0	0
30	y	37	187	113	37	37	0	0

- Molecule 31 is a protein called WD40 repeat-containing protein SMU1.

Mol	Chain	Residues	Atoms				AltConf	Trace
			Total	C	N	O		
31	v	496	2478	1486	496	496	0	0
31	w	495	2474	1484	495	495	0	0

- Molecule 32 is a protein called Serine/arginine-rich splicing factor 1.

Mol	Chain	Residues	Atoms				AltConf	Trace
			Total	C	N	O		
32	z	74	368	220	74	74	0	0

- Molecule 33 is a protein called Peptidyl-prolyl cis-trans isomerase H.

Mol	Chain	Residues	Atoms				AltConf	Trace
			Total	C	N	O		
33	W	169	844	506	169	169	0	0

- Molecule 34 is a RNA chain called U5 snRNA.

Mol	Chain	Residues	Atoms					AltConf	Trace
			Total	C	N	O	P		
34	5	115	2420	1084	403	818	115	0	0

- Molecule 35 is a protein called Protein BUD31 homolog.

Mol	Chain	Residues	Atoms			AltConf	Trace	
35	Q	142	Total	C	N	O	0	0
			713	429	142	142		

- Molecule 36 is a protein called Thioredoxin-like protein 4A.

Mol	Chain	Residues	Atoms			AltConf	Trace	
36	D	141	Total	C	N	O	0	0
			708	426	141	141		

- Molecule 37 is a protein called WW domain-binding protein 4.

Mol	Chain	Residues	Atoms			AltConf	Trace	
37	X	81	Total	C	N	O	0	0
			408	246	81	81		

- Molecule 38 is a protein called Microfibrillar-associated protein 1.

Mol	Chain	Residues	Atoms			AltConf	Trace	
38	K	212	Total	C	N	O	0	0
			1057	633	212	212		

- Molecule 39 is a RNA chain called MINX pre-mRNA.

Mol	Chain	Residues	Atoms				AltConf	Trace	
39	Z	46	Total	C	N	O	P	0	0
			977	438	175	319	45		

- Molecule 40 is a protein called U4/U6 small nuclear ribonucleoprotein Prp31.

Mol	Chain	Residues	Atoms			AltConf	Trace	
40	L	373	Total	C	N	O	0	0
			1873	1127	373	373		

- Molecule 41 is a protein called U4/U6 small nuclear ribonucleoprotein Prp4.

Mol	Chain	Residues	Atoms			AltConf	Trace	
41	F	431	Total	C	N	O	0	0
			2155	1293	431	431		

- Molecule 42 is a protein called Pre-mRNA-processing factor 6.

Mol	Chain	Residues	Atoms				AltConf	Trace
42	N	791	Total	C	N	O	0	0
			3990	2408	791	791		

- Molecule 43 is a protein called Pre-mRNA-processing-splicing factor 8.

Mol	Chain	Residues	Atoms				AltConf	Trace
43	A	2234	Total	C	N	O	0	0
			11052	6584	2234	2234		

- Molecule 44 is a protein called Pre-mRNA-splicing factor 38A.

Mol	Chain	Residues	Atoms				AltConf	Trace
44	I	184	Total	C	N	O	0	0
			925	557	184	184		

- Molecule 45 is a protein called U4/U6.U5 tri-snRNP-associated protein 1.

Mol	Chain	Residues	Atoms				AltConf	Trace
45	S	171	Total	C	N	O	0	0
			854	512	171	171		

- Molecule 46 is a protein called 116 kDa U5 small nuclear ribonucleoprotein component.

Mol	Chain	Residues	Atoms				AltConf	Trace
46	C	843	Total	C	N	O	0	0
			4260	2574	843	843		

- Molecule 47 is a protein called NHP2-like protein 1, N-terminally processed.

Mol	Chain	Residues	Atoms				AltConf	Trace
47	M	124	Total	C	N	O	0	0
			627	379	124	124		

- Molecule 48 is a protein called Transcription elongation regulator 1.

Mol	Chain	Residues	Atoms				AltConf	Trace
48	T	412	Total	C	N	O	0	0
			2071	1247	412	412		

- Molecule 49 is a RNA chain called U4 snRNA.

Mol	Chain	Residues	Atoms					AltConf	Trace
			Total	C	N	O	P		
49	4	127	2692	1203	467	895	127	0	0

- Molecule 50 is a RNA chain called U6 snRNA.

Mol	Chain	Residues	Atoms					AltConf	Trace
			Total	C	N	O	P		
50	6	94	1995	891	362	648	94	0	0

- Molecule 51 is a protein called Zinc finger matrin-type protein 2.

Mol	Chain	Residues	Atoms				AltConf	Trace
			Total	C	N	O		
51	r	114	568	340	114	114	0	0

- Molecule 52 is a protein called U4/U6 small nuclear ribonucleoprotein Prp3.

Mol	Chain	Residues	Atoms				AltConf	Trace
			Total	C	N	O		
52	J	260	1314	794	260	260	0	0

- Molecule 53 is a protein called Ubiquitin-like protein 5.

Mol	Chain	Residues	Atoms				AltConf	Trace
			Total	C	N	O		
53	s	73	360	214	73	73	0	0

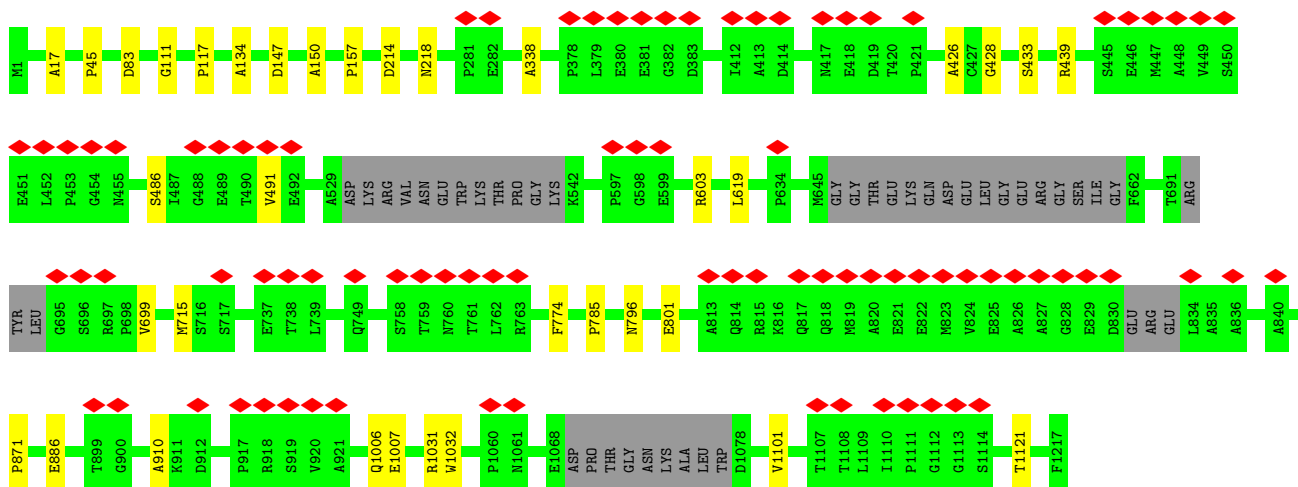

• Molecule 8: PHD finger-like domain-containing protein 5A

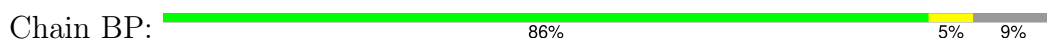

• Molecule 9: Splicing factor 3B subunit 1

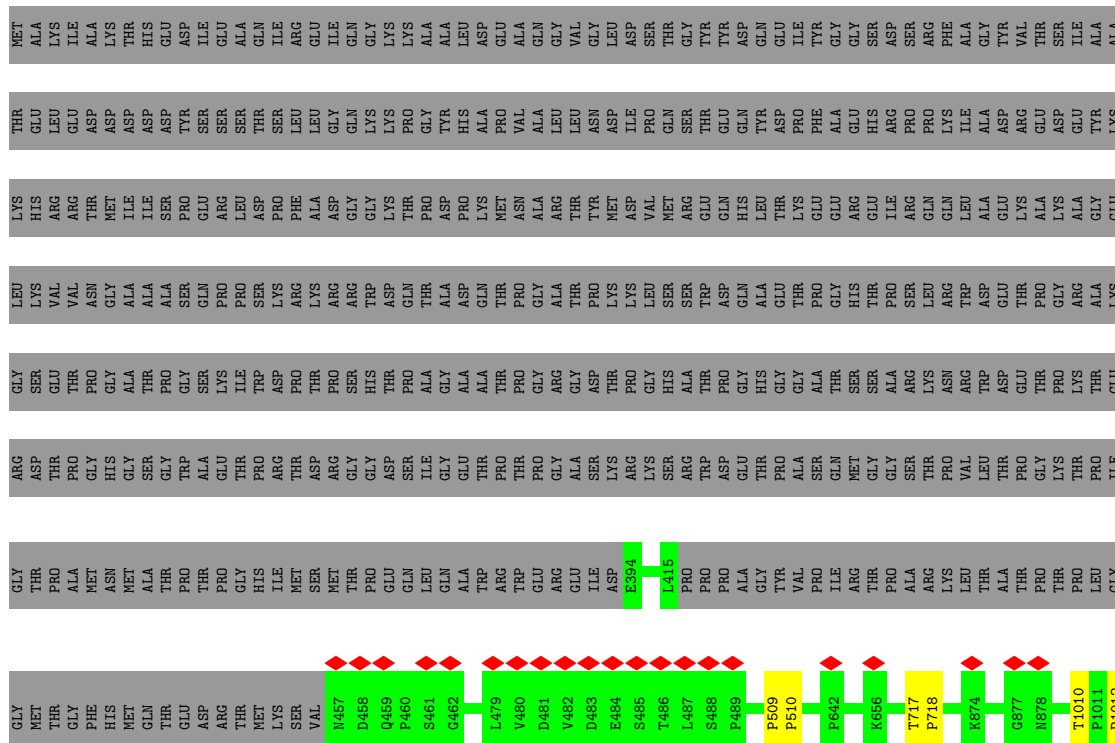

- Molecule 10: Splicing factor 3B subunit 6

Chain B6:  70% 28%

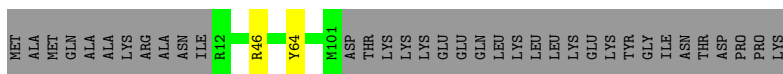

- Molecule 11: U6 snRNA-associated Sm-like protein LSm2

Chain 62:  94% 5%

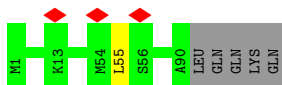

- Molecule 12: U6 snRNA-associated Sm-like protein LSm3

Chain 63:  73% 27% 5%

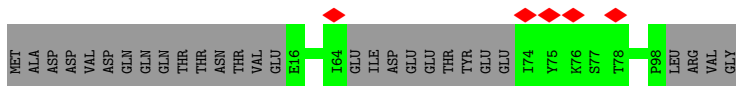

- Molecule 13: U6 snRNA-associated Sm-like protein LSm4

Chain 64:  53% 47% 18%

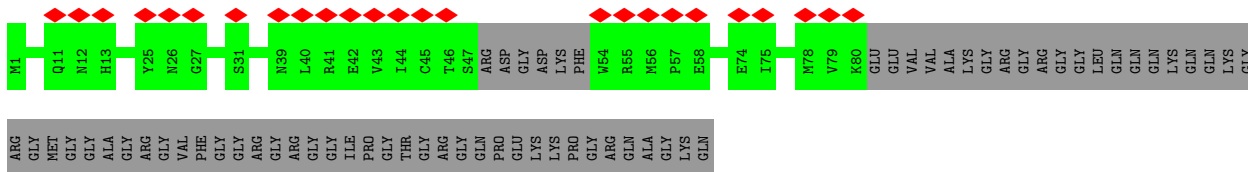

- Molecule 14: U6 snRNA-associated Sm-like protein LSm5

Chain 65:  77% 21% 25%

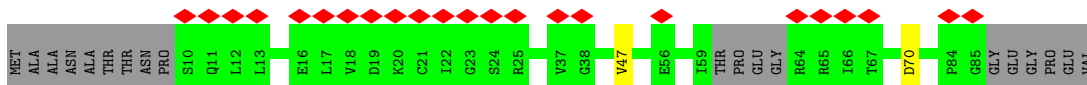

- Molecule 15: U6 snRNA-associated Sm-like protein LSm6

Chain 66:  85% 12% 9%

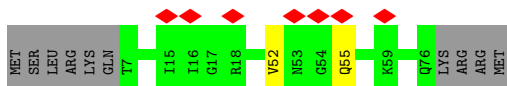

- Molecule 16: U6 snRNA-associated Sm-like protein LSm7

Chain 67:  61% 37% 35%

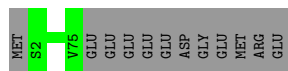
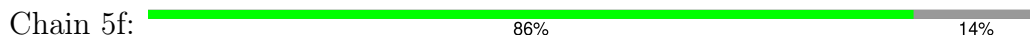

- Molecule 21: Small nuclear ribonucleoprotein F

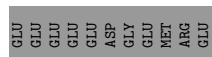
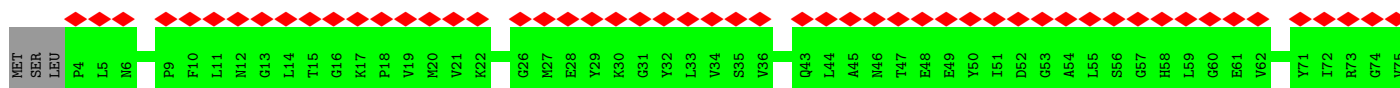
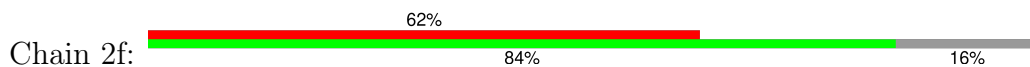

- Molecule 21: Small nuclear ribonucleoprotein F

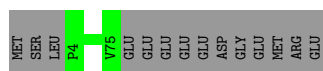
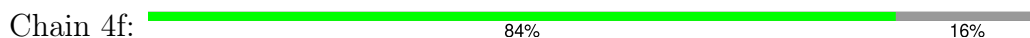

- Molecule 22: Small nuclear ribonucleoprotein E

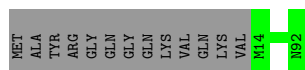
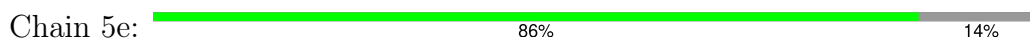

- Molecule 22: Small nuclear ribonucleoprotein E

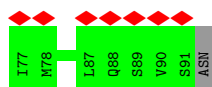
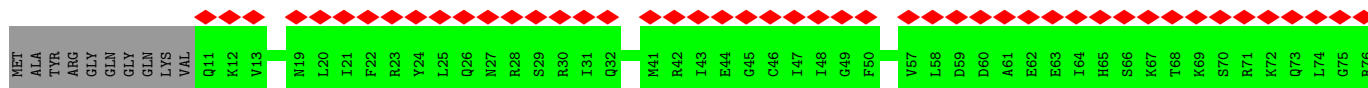
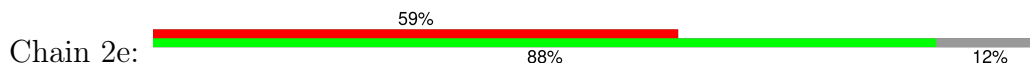

- Molecule 22: Small nuclear ribonucleoprotein E

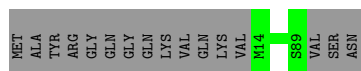
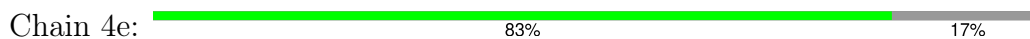

- Molecule 23: Small nuclear ribonucleoprotein G



- Molecule 36: Thioredoxin-like protein 4A



- Molecule 37: WW domain-binding protein 4

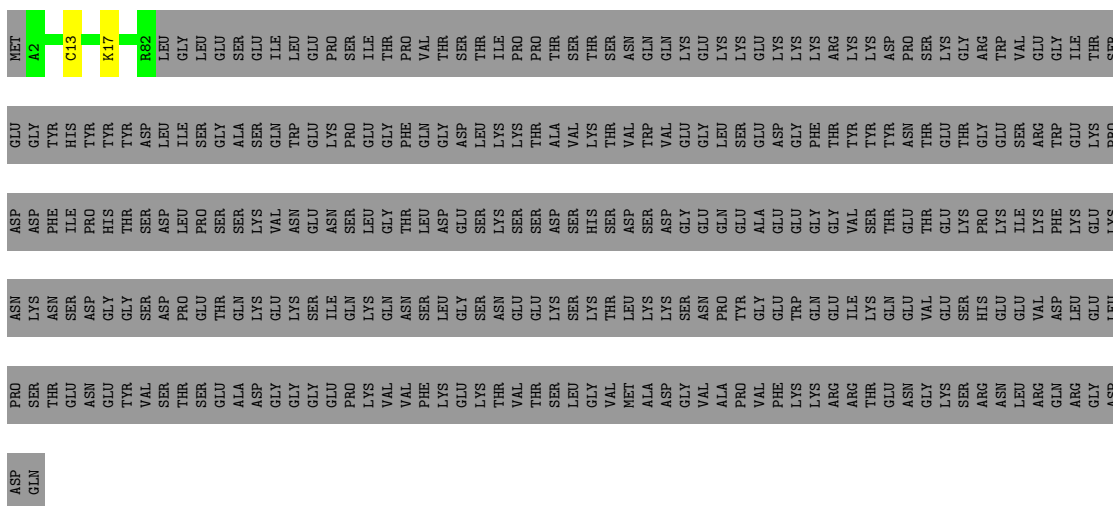

- Molecule 38: Microfibrillar-associated protein 1

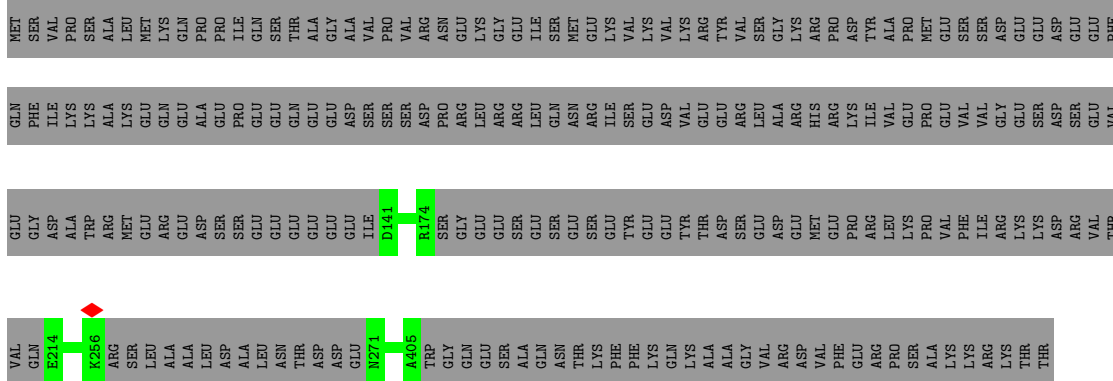

- Molecule 39: MINX pre-mRNA

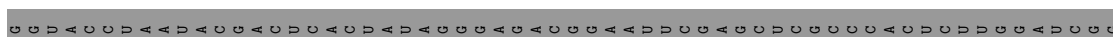

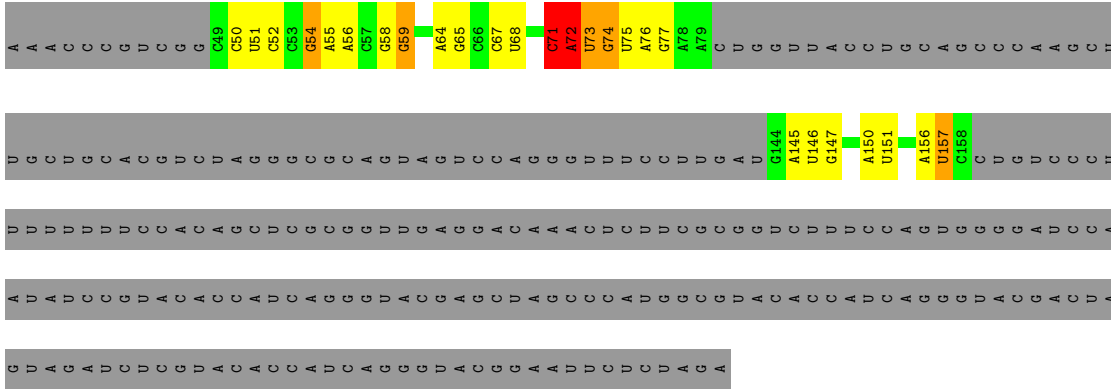

• Molecule 40: U4/U6 small nuclear ribonucleoprotein Prp31

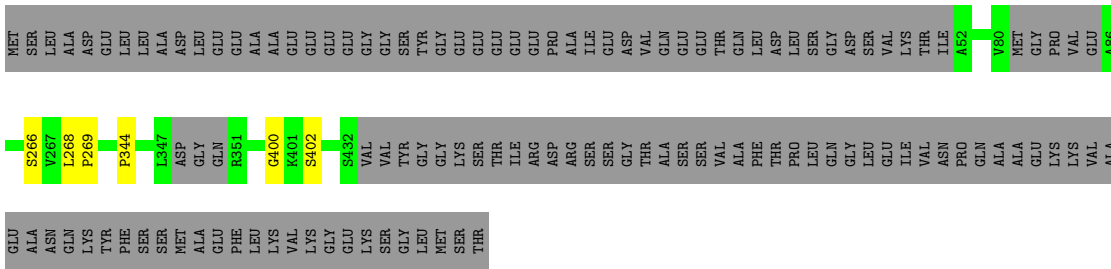

• Molecule 41: U4/U6 small nuclear ribonucleoprotein Prp4

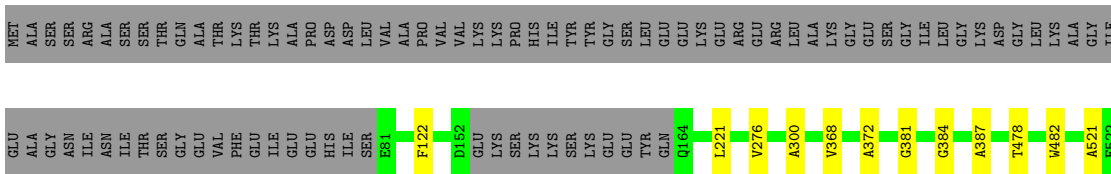
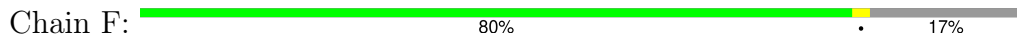

• Molecule 42: Pre-mRNA-processing factor 6

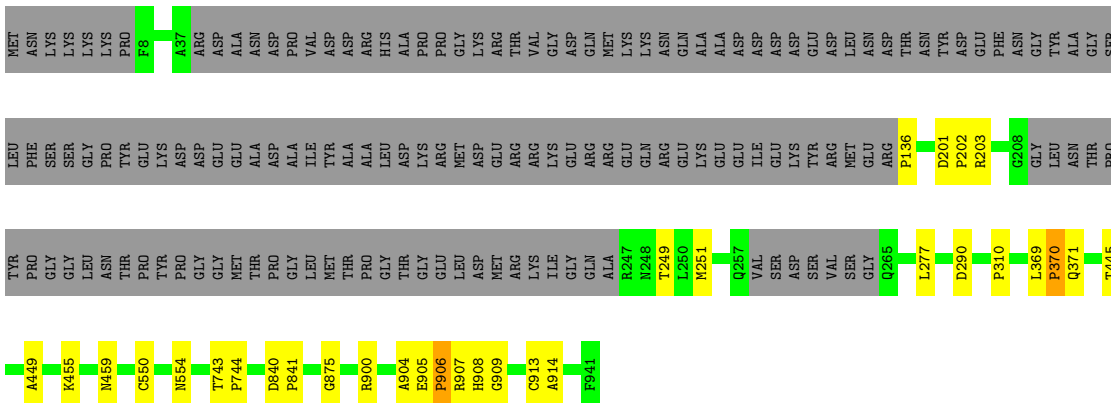
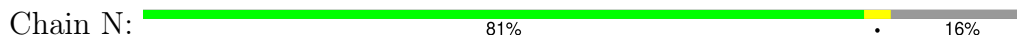

• Molecule 43: Pre-mRNA-processing-splicing factor 8

Chain A:  94%

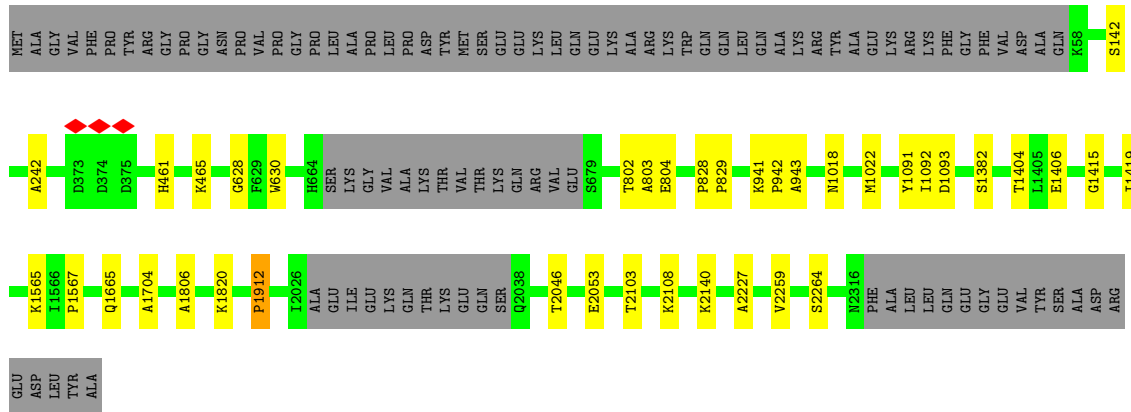

• Molecule 44: Pre-mRNA-splicing factor 38A

Chain I:  57%

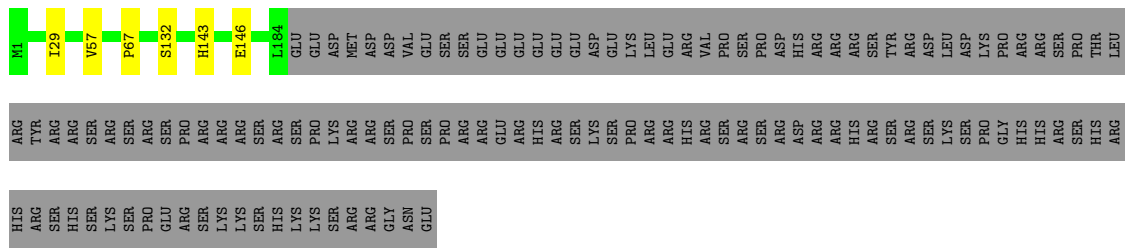

• Molecule 45: U4/U6.U5 tri-snRNP-associated protein 1

Chain S:  21%

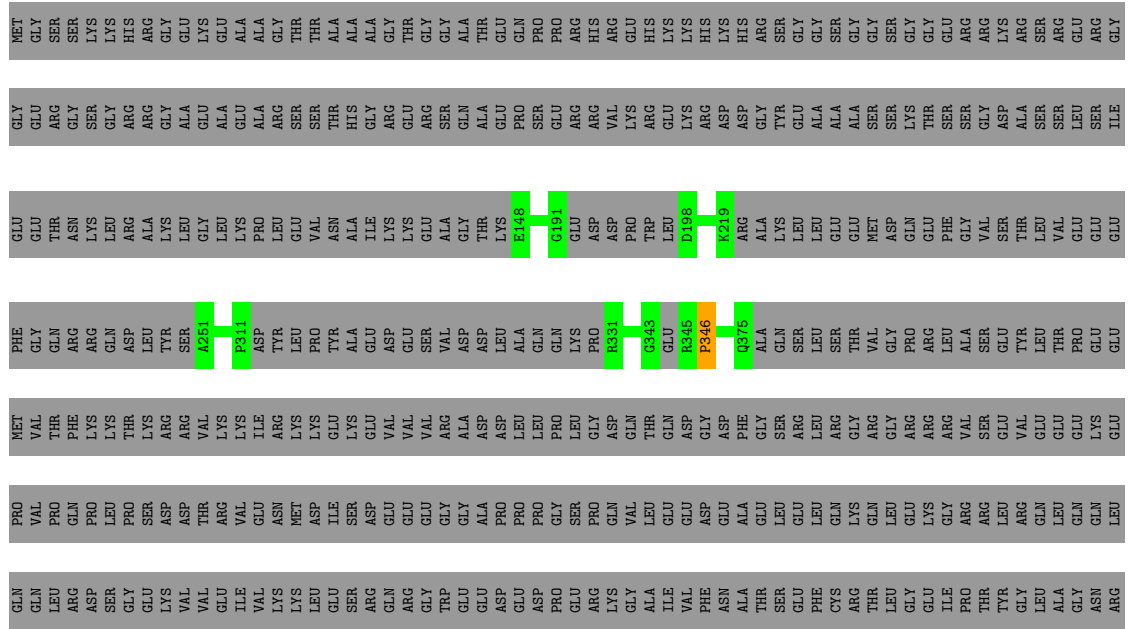

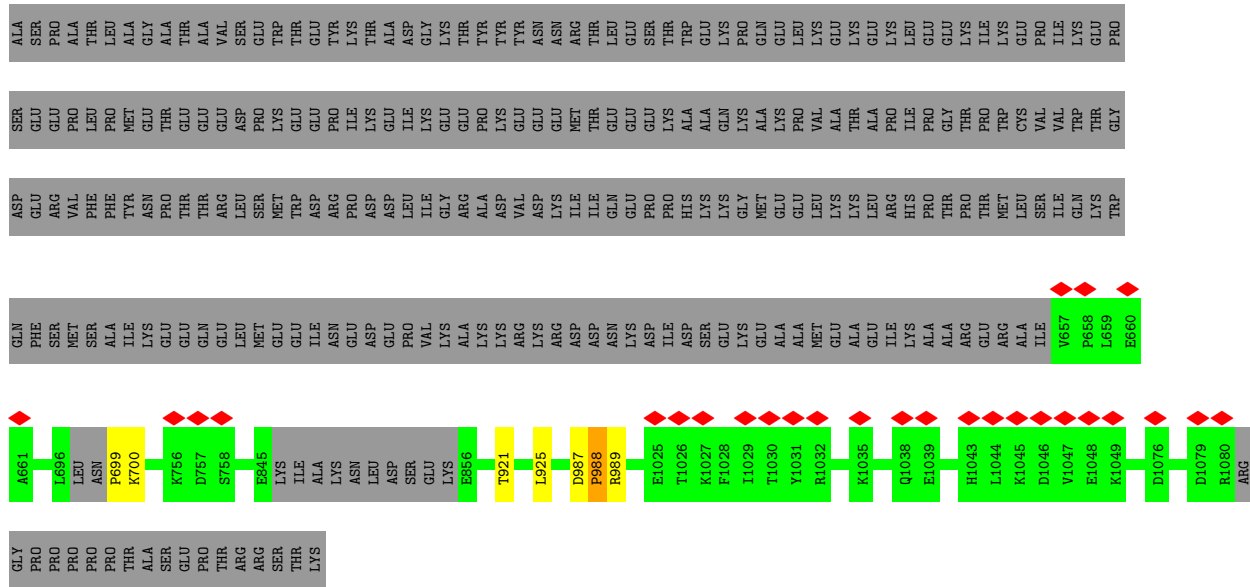

• Molecule 49: U4 snRNA

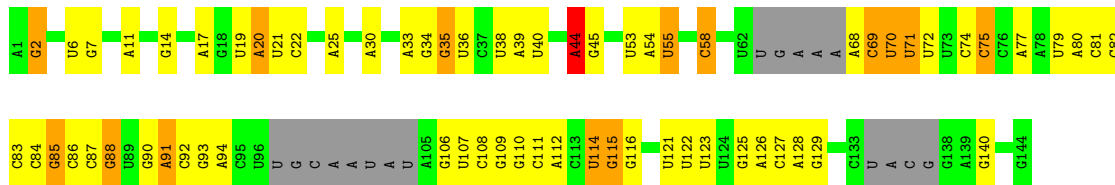

• Molecule 50: U6 snRNA

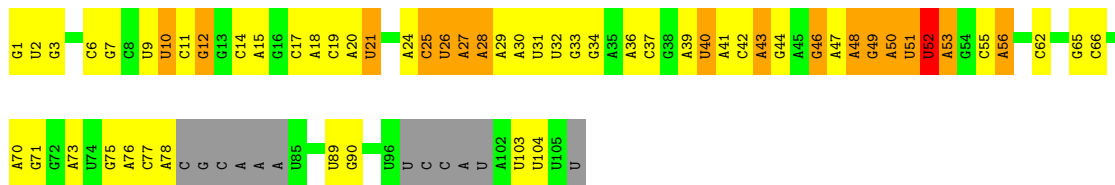
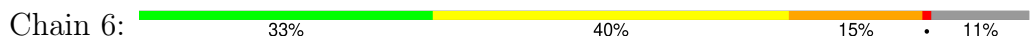

• Molecule 51: Zinc finger matrin-type protein 2

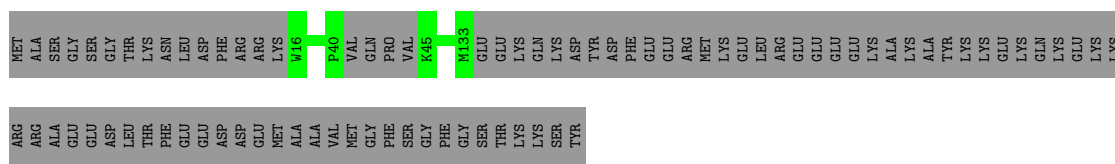

• Molecule 52: U4/U6 small nuclear ribonucleoprotein Prp3



4 Experimental information

Property	Value	Source
EM reconstruction method	SINGLE PARTICLE	Depositor
Imposed symmetry	POINT, Not provided	
Number of particles used	50321	Depositor
Resolution determination method	FSC 0.143 CUT-OFF	Depositor
CTF correction method	PHASE FLIPPING AND AMPLITUDE CORRECTION	Depositor
Microscope	FEI TITAN KRIOS	Depositor
Voltage (kV)	300	Depositor
Electron dose ($e^-/\text{\AA}^2$)	45	Depositor
Minimum defocus (nm)	1500	Depositor
Maximum defocus (nm)	5000	Depositor
Magnification	Not provided	
Image detector	FEI FALCON III (4k x 4k)	Depositor
Maximum map value	0.141	Depositor
Minimum map value	-0.034	Depositor
Average map value	-0.000	Depositor
Map value standard deviation	0.009	Depositor
Recommended contour level	0.02	Depositor
Map size (Å)	603.2, 603.2, 603.2	wwPDB
Map dimensions	260, 260, 260	wwPDB
Map angles (°)	90.0, 90.0, 90.0	wwPDB
Pixel spacing (Å)	2.32, 2.32, 2.32	Depositor

5 Model quality i

5.1 Standard geometry i

The Z score for a bond length (or angle) is the number of standard deviations the observed value is removed from the expected value. A bond length (or angle) with $|Z| > 5$ is considered an outlier worth inspection. RMSZ is the root-mean-square of all Z scores of the bond lengths (or angles).

Mol	Chain	Bond lengths		Bond angles	
		RMSZ	# Z >5	RMSZ	# Z >5
1	B4	0.25	0/394	0.43	0/549
2	8	0.24	0/515	0.47	0/721
2	G	0.23	0/219	0.39	0/304
3	9	0.24	0/1575	0.39	0/2201
3	H	0.83	1/353 (0.3%)	1.14	3/491 (0.6%)
4	B2	0.25	0/1092	0.46	0/1536
5	B5	0.23	0/349	0.35	0/487
6	2	0.22	0/2307	0.81	3/3582 (0.1%)
7	B3	0.25	0/5961	0.47	1/8335 (0.0%)
8	BP	0.24	0/501	0.43	0/697
9	B1	0.24	0/4421	0.43	2/6190 (0.0%)
10	B6	0.24	0/459	0.43	0/642
11	62	0.23	0/359	0.45	0/447
12	63	0.23	0/294	0.50	0/364
13	64	0.23	0/294	0.45	0/364
14	65	0.23	0/286	0.48	0/354
15	66	0.24	0/279	0.49	0/347
16	67	0.24	0/258	0.53	0/319
17	68	0.22	0/242	0.50	0/299
18	2b	0.24	0/416	0.46	0/581
18	4b	0.24	0/416	0.46	0/581
18	5b	0.25	0/343	0.51	0/427
19	21	0.23	0/404	0.47	0/564
19	41	0.23	0/409	0.47	0/571
19	51	0.24	0/327	0.51	0/407
20	22	0.23	0/485	0.43	0/677
20	42	0.24	0/466	0.47	0/651
20	52	0.24	0/387	0.49	0/482
21	2f	0.25	0/362	0.45	0/502
21	4f	0.25	0/362	0.46	0/502
21	5f	0.25	0/295	0.51	0/367
22	2e	0.23	0/403	0.43	0/561
22	4e	0.23	0/378	0.45	0/526
22	5e	0.23	0/315	0.50	0/392

Mol	Chain	Bond lengths		Bond angles	
		RMSZ	# Z >5	RMSZ	# Z >5
23	2g	0.24	0/366	0.47	0/509
23	4g	0.23	0/371	0.45	0/516
23	5g	0.24	0/295	0.52	0/367
24	23	0.24	0/417	0.44	0/581
24	43	0.25	0/417	0.50	0/581
24	53	0.24	0/307	0.52	0/382
25	2B	0.24	0/463	0.39	0/646
26	2A	0.23	0/821	0.43	0/1149
27	7	0.26	0/1034	0.41	0/1446
28	E	0.24	0/1195	0.51	0/1492
29	B	0.25	0/8614	0.42	0/12072
30	x	0.23	0/196	0.58	1/270 (0.4%)
30	y	0.26	0/186	0.57	1/256 (0.4%)
31	v	0.25	0/2491	0.44	0/3477
31	w	0.24	0/2486	0.45	1/3469 (0.0%)
32	z	0.26	0/369	0.46	0/513
33	W	0.28	0/853	0.49	0/1188
34	5	1.31	14/2698 (0.5%)	1.08	4/4195 (0.1%)
35	Q	0.31	0/718	0.51	0/1003
36	D	0.40	0/712	0.56	0/995
37	X	0.29	0/409	0.45	0/572
38	K	0.30	0/1056	0.45	0/1471
39	Z	1.37	8/1089 (0.7%)	1.22	8/1692 (0.5%)
40	L	0.36	0/1884	0.49	0/2632
41	F	0.27	0/2170	0.44	0/3028
42	N	0.34	3/4021 (0.1%)	0.51	3/5630 (0.1%)
43	A	0.42	1/11156 (0.0%)	0.58	2/15500 (0.0%)
44	I	0.36	0/931	0.53	0/1302
45	S	0.52	3/853 (0.4%)	0.72	3/1184 (0.3%)
46	C	0.35	0/4308	0.51	1/6037 (0.0%)
47	M	0.29	0/632	0.46	0/885
48	T	0.43	2/2075 (0.1%)	0.91	6/2903 (0.2%)
49	4	1.20	9/3002 (0.3%)	0.99	6/4666 (0.1%)
50	6	1.18	7/2230 (0.3%)	1.03	3/3468 (0.1%)
51	r	0.32	0/568	0.46	0/790
52	J	0.29	0/1323	0.45	0/1848
53	s	0.43	0/359	0.68	0/498
All	All	0.50	48/89001 (0.1%)	0.60	48/125233 (0.0%)

The worst 5 of 48 bond length outliers are listed below:

Continued on next page...

Continued from previous page...

Mol	Chain	Res	Type	Atoms	Z	Observed(Å)	Ideal(Å)
3	H	419	PRO	CG-CD	-14.09	1.04	1.50
48	T	988	PRO	N-CA	11.15	1.66	1.47
48	T	988	PRO	N-CD	-7.73	1.37	1.47
45	S	346	PRO	N-CD	7.68	1.58	1.47
49	4	20	A	N9-C4	-7.17	1.33	1.37

The worst 5 of 48 bond angle outliers are listed below:

Mol	Chain	Res	Type	Atoms	Z	Observed(°)	Ideal(°)
48	T	988	PRO	N-CD-CG	-25.99	64.22	103.20
48	T	988	PRO	CA-CB-CG	-25.11	56.29	104.00
48	T	988	PRO	CB-CG-CD	18.84	179.99	106.50
3	H	419	PRO	N-CD-CG	-16.46	78.51	103.20
45	S	346	PRO	CA-N-CD	-14.44	91.28	111.50

There are no chirality outliers.

There are no planarity outliers.

5.2 Too-close contacts [i](#)

In the following table, the Non-H and H(model) columns list the number of non-hydrogen atoms and hydrogen atoms in the chain respectively. The H(added) column lists the number of hydrogen atoms added and optimized by MolProbity. The Clashes column lists the number of clashes within the asymmetric unit, whereas Symm-Clashes lists symmetry-related clashes.

Mol	Chain	Non-H	H(model)	H(added)	Clashes	Symm-Clashes
1	B4	391	0	197	0	0
2	8	510	0	255	1	0
2	G	219	0	101	2	0
3	9	1569	0	721	1	0
3	H	351	0	181	2	0
4	B2	1072	0	563	1	0
5	B5	347	0	171	1	0
6	2	2071	0	1049	39	0
7	B3	5908	0	2954	18	0
8	BP	498	0	241	3	0
9	B1	4383	0	2195	4	0
10	B6	455	0	227	1	0
11	62	360	0	95	0	0

Continued on next page...

Continued from previous page...

Mol	Chain	Non-H	H(model)	H(added)	Clashes	Symm-Clashes
12	63	296	0	76	0	0
13	64	296	0	77	0	0
14	65	288	0	78	0	0
15	66	280	0	81	0	0
16	67	260	0	75	1	0
17	68	244	0	71	0	0
18	2b	413	0	194	0	0
18	4b	413	0	194	0	0
18	5b	344	0	93	0	0
19	21	402	0	184	0	0
19	41	407	0	183	1	0
19	51	328	0	89	1	0
20	22	482	0	220	3	0
20	42	463	0	211	2	0
20	52	388	0	102	0	0
21	2f	359	0	179	0	0
21	4f	359	0	179	0	0
21	5f	296	0	87	0	0
22	2e	403	0	173	0	0
22	4e	378	0	163	0	0
22	5e	316	0	85	0	0
23	2g	364	0	176	0	0
23	4g	369	0	178	0	0
23	5g	296	0	84	0	0
24	23	415	0	198	2	0
24	43	415	0	198	0	0
24	53	308	0	86	0	0
25	2B	461	0	218	2	0
26	2A	816	0	386	2	0
27	7	1028	0	487	0	0
28	E	1196	0	337	0	0
29	B	8538	0	4146	20	0
30	x	197	0	90	0	0
30	y	187	0	86	0	0
31	v	2478	0	1181	0	0
31	w	2474	0	1177	0	0
32	z	368	0	175	0	0
33	W	844	0	426	9	0
34	5	2420	0	1226	46	0
35	Q	713	0	337	1	0
36	D	708	0	328	1	0
37	X	408	0	205	1	0

Continued on next page...

Continued from previous page...

Mol	Chain	Non-H	H(model)	H(added)	Clashes	Symm-Clashes
38	K	1057	0	480	0	0
39	Z	977	0	498	16	0
40	L	1873	0	926	5	0
41	F	2155	0	1069	7	0
42	N	3990	0	2055	19	0
43	A	11052	0	5147	20	0
44	I	925	0	438	3	0
45	S	854	0	405	3	0
46	C	4260	0	2118	7	0
47	M	627	0	315	2	0
48	T	2071	0	935	6	0
49	4	2692	0	1367	32	0
50	6	1995	0	1006	34	0
51	r	568	0	245	0	0
52	J	1314	0	651	2	0
53	s	360	0	159	0	0
All	All	87322	0	41283	301	0

The all-atom clashscore is defined as the number of clashes found per 1000 atoms (including hydrogen atoms). The all-atom clashscore for this structure is 3.

The worst 5 of 301 close contacts within the same asymmetric unit are listed below, sorted by their clash magnitude.

Atom-1	Atom-2	Interatomic distance (Å)	Clash overlap (Å)
42:N:370:PRO:CG	42:N:370:PRO:CB	1.81	1.46
45:S:346:PRO:CG	45:S:346:PRO:CB	1.82	1.40
48:T:988:PRO:HD2	48:T:989:ARG:H	1.20	1.06
48:T:988:PRO:HD2	48:T:989:ARG:N	1.84	0.92
3:H:419:PRO:HG2	3:H:420:LYS:N	1.87	0.89

There are no symmetry-related clashes.

5.3 Torsion angles [i](#)

5.3.1 Protein backbone [i](#)

In the following table, the Percentiles column shows the percent Ramachandran outliers of the chain as a percentile score with respect to all PDB entries followed by that with respect to all EM entries.

The Analysed column shows the number of residues for which the backbone conformation was analysed, and the total number of residues.

Mol	Chain	Analysed	Favoured	Allowed	Outliers	Percentiles	
1	B4	76/424 (18%)	76 (100%)	0	0	100	100
2	8	96/464 (21%)	91 (95%)	5 (5%)	0	100	100
2	G	42/464 (9%)	42 (100%)	0	0	100	100
3	9	309/501 (62%)	302 (98%)	6 (2%)	1 (0%)	37	72
3	H	68/501 (14%)	67 (98%)	1 (2%)	0	100	100
4	B2	204/895 (23%)	194 (95%)	10 (5%)	0	100	100
5	B5	67/86 (78%)	65 (97%)	2 (3%)	0	100	100
7	B3	1162/1217 (96%)	1117 (96%)	45 (4%)	0	100	100
8	BP	98/110 (89%)	94 (96%)	4 (4%)	0	100	100
9	B1	866/1304 (66%)	834 (96%)	32 (4%)	0	100	100
10	B6	88/125 (70%)	86 (98%)	2 (2%)	0	100	100
11	62	88/95 (93%)	86 (98%)	1 (1%)	1 (1%)	12	46
12	63	70/102 (69%)	65 (93%)	5 (7%)	0	100	100
13	64	70/139 (50%)	68 (97%)	2 (3%)	0	100	100
14	65	68/91 (75%)	63 (93%)	3 (4%)	2 (3%)	3	23
15	66	68/80 (85%)	64 (94%)	2 (3%)	2 (3%)	3	23
16	67	61/103 (59%)	58 (95%)	3 (5%)	0	100	100
17	68	57/96 (59%)	55 (96%)	1 (2%)	1 (2%)	7	33
18	2b	80/240 (33%)	76 (95%)	4 (5%)	0	100	100
18	4b	80/240 (33%)	77 (96%)	3 (4%)	0	100	100
18	5b	84/240 (35%)	80 (95%)	4 (5%)	0	100	100
19	21	78/119 (66%)	77 (99%)	1 (1%)	0	100	100
19	41	79/119 (66%)	76 (96%)	3 (4%)	0	100	100
19	51	80/119 (67%)	75 (94%)	5 (6%)	0	100	100
20	22	91/118 (77%)	89 (98%)	2 (2%)	0	100	100
20	42	90/118 (76%)	88 (98%)	2 (2%)	0	100	100
20	52	95/118 (80%)	91 (96%)	4 (4%)	0	100	100
21	2f	70/86 (81%)	70 (100%)	0	0	100	100
21	4f	70/86 (81%)	68 (97%)	2 (3%)	0	100	100
21	5f	72/86 (84%)	68 (94%)	4 (6%)	0	100	100

Continued on next page...

Continued from previous page...

Mol	Chain	Analysed	Favoured	Allowed	Outliers	Percentiles	
22	2e	79/92 (86%)	78 (99%)	1 (1%)	0	100	100
22	4e	74/92 (80%)	72 (97%)	2 (3%)	0	100	100
22	5e	77/92 (84%)	74 (96%)	3 (4%)	0	100	100
23	2g	71/76 (93%)	70 (99%)	1 (1%)	0	100	100
23	4g	72/76 (95%)	69 (96%)	3 (4%)	0	100	100
23	5g	72/76 (95%)	71 (99%)	1 (1%)	0	100	100
24	23	81/126 (64%)	79 (98%)	2 (2%)	0	100	100
24	43	81/126 (64%)	78 (96%)	3 (4%)	0	100	100
24	53	75/126 (60%)	73 (97%)	2 (3%)	0	100	100
25	2B	90/225 (40%)	89 (99%)	1 (1%)	0	100	100
26	2A	160/255 (63%)	155 (97%)	5 (3%)	0	100	100
27	7	200/793 (25%)	187 (94%)	13 (6%)	0	100	100
28	E	297/357 (83%)	280 (94%)	16 (5%)	1 (0%)	37	72
29	B	1691/2136 (79%)	1622 (96%)	68 (4%)	1 (0%)	48	83
30	x	33/557 (6%)	27 (82%)	6 (18%)	0	100	100
30	y	31/557 (6%)	29 (94%)	2 (6%)	0	100	100
31	v	492/513 (96%)	477 (97%)	15 (3%)	0	100	100
31	w	489/513 (95%)	475 (97%)	14 (3%)	0	100	100
32	z	72/248 (29%)	66 (92%)	6 (8%)	0	100	100
33	W	167/177 (94%)	157 (94%)	10 (6%)	0	100	100
35	Q	140/144 (97%)	125 (89%)	15 (11%)	0	100	100
36	D	139/142 (98%)	132 (95%)	7 (5%)	0	100	100
37	X	79/376 (21%)	79 (100%)	0	0	100	100
38	K	206/439 (47%)	189 (92%)	17 (8%)	0	100	100
40	L	367/499 (74%)	342 (93%)	24 (6%)	1 (0%)	37	72
41	F	427/522 (82%)	411 (96%)	16 (4%)	0	100	100
42	N	783/941 (83%)	682 (87%)	100 (13%)	1 (0%)	48	83
43	A	2228/2335 (95%)	2044 (92%)	181 (8%)	3 (0%)	48	83
44	I	182/312 (58%)	173 (95%)	9 (5%)	0	100	100
45	S	161/800 (20%)	152 (94%)	9 (6%)	0	100	100
46	C	841/972 (86%)	794 (94%)	47 (6%)	0	100	100

Continued on next page...

Continued from previous page...

Mol	Chain	Analysed	Favoured	Allowed	Outliers	Percentiles	
47	M	122/128 (95%)	119 (98%)	3 (2%)	0	100	100
48	T	406/1098 (37%)	386 (95%)	20 (5%)	0	100	100
51	r	110/199 (55%)	104 (94%)	6 (6%)	0	100	100
52	J	252/683 (37%)	236 (94%)	16 (6%)	0	100	100
53	s	71/73 (97%)	66 (93%)	5 (7%)	0	100	100
All	All	15445/25362 (61%)	14624 (95%)	807 (5%)	14 (0%)	50	83

5 of 14 Ramachandran outliers are listed below:

Mol	Chain	Res	Type
3	9	78	PRO
11	62	55	LEU
14	65	70	ASP
15	66	52	VAL
15	66	55	GLN

5.3.2 Protein sidechains [i](#)

In the following table, the Percentiles column shows the percent sidechain outliers of the chain as a percentile score with respect to all PDB entries followed by that with respect to all EM entries.

The Analysed column shows the number of residues for which the sidechain conformation was analysed, and the total number of residues.

Mol	Chain	Analysed	Rotameric	Outliers	Percentiles	
1	B4	4/336 (1%)	4 (100%)	0	100	100
2	8	7/382 (2%)	7 (100%)	0	100	100
2	G	1/382 (0%)	1 (100%)	0	100	100
3	9	8/446 (2%)	8 (100%)	0	100	100
3	H	3/446 (1%)	3 (100%)	0	100	100
4	B2	22/776 (3%)	22 (100%)	0	100	100
5	B5	3/77 (4%)	3 (100%)	0	100	100
7	B3	59/1051 (6%)	59 (100%)	0	100	100
8	BP	4/95 (4%)	4 (100%)	0	100	100
9	B1	40/1104 (4%)	40 (100%)	0	100	100
10	B6	5/109 (5%)	5 (100%)	0	100	100

Continued on next page...

Continued from previous page...

Mol	Chain	Analysed	Rotameric	Outliers	Percentiles	
18	2b	4/177 (2%)	4 (100%)	0	100	100
18	4b	4/177 (2%)	4 (100%)	0	100	100
19	21	3/101 (3%)	3 (100%)	0	100	100
19	41	3/101 (3%)	3 (100%)	0	100	100
20	22	5/110 (4%)	5 (100%)	0	100	100
20	42	4/110 (4%)	4 (100%)	0	100	100
21	2f	4/74 (5%)	4 (100%)	0	100	100
21	4f	4/74 (5%)	4 (100%)	0	100	100
22	2e	1/84 (1%)	1 (100%)	0	100	100
22	4e	1/84 (1%)	1 (100%)	0	100	100
23	2g	3/66 (4%)	3 (100%)	0	100	100
23	4g	3/66 (4%)	3 (100%)	0	100	100
24	23	3/101 (3%)	3 (100%)	0	100	100
24	43	3/101 (3%)	3 (100%)	0	100	100
25	2B	3/195 (2%)	3 (100%)	0	100	100
26	2A	6/218 (3%)	6 (100%)	0	100	100
27	7	8/709 (1%)	8 (100%)	0	100	100
29	B	77/1908 (4%)	77 (100%)	0	100	100
30	x	2/498 (0%)	2 (100%)	0	100	100
30	y	2/498 (0%)	2 (100%)	0	100	100
31	v	15/450 (3%)	15 (100%)	0	100	100
31	w	15/450 (3%)	15 (100%)	0	100	100
32	z	2/203 (1%)	2 (100%)	0	100	100
33	W	10/148 (7%)	10 (100%)	0	100	100
35	Q	6/130 (5%)	6 (100%)	0	100	100
36	D	5/130 (4%)	5 (100%)	0	100	100
37	X	2/333 (1%)	2 (100%)	0	100	100
38	K	2/395 (0%)	2 (100%)	0	100	100
40	L	14/424 (3%)	14 (100%)	0	100	100
41	F	17/442 (4%)	17 (100%)	0	100	100
42	N	35/792 (4%)	35 (100%)	0	100	100

Continued on next page...

Continued from previous page...

Mol	Chain	Analysed	Rotameric	Outliers	Percentiles	
43	A	107/2108 (5%)	107 (100%)	0	100	100
44	I	7/293 (2%)	7 (100%)	0	100	100
45	S	4/681 (1%)	4 (100%)	0	100	100
46	C	49/866 (6%)	49 (100%)	0	100	100
47	M	6/111 (5%)	6 (100%)	0	100	100
48	T	7/956 (1%)	7 (100%)	0	100	100
51	r	2/181 (1%)	2 (100%)	0	100	100
52	J	13/599 (2%)	13 (100%)	0	100	100
All	All	617/20348 (3%)	617 (100%)	0	100	100

There are no protein residues with a non-rotameric sidechain to report.

Sometimes sidechains can be flipped to improve hydrogen bonding and reduce clashes. There are no such sidechains identified.

5.3.3 RNA [i](#)

Mol	Chain	Analysed	Backbone Outliers	Pucker Outliers
34	5	114/117 (97%)	46 (40%)	2 (1%)
39	Z	44/347 (12%)	12 (27%)	1 (2%)
49	4	123/144 (85%)	38 (30%)	3 (2%)
50	6	90/106 (84%)	26 (28%)	4 (4%)
6	2	94/188 (50%)	22 (23%)	4 (4%)
All	All	465/902 (51%)	144 (30%)	14 (3%)

5 of 144 RNA backbone outliers are listed below:

Mol	Chain	Res	Type
6	2	31	G
6	2	38	A
6	2	40	C
6	2	45	C
6	2	46	U

5 of 14 RNA pucker outliers are listed below:

Mol	Chain	Res	Type
49	4	44	A

Continued on next page...

Continued from previous page...

Mol	Chain	Res	Type
49	4	80	A
50	6	77	C
50	6	39	A
50	6	52	U

5.4 Non-standard residues in protein, DNA, RNA chains [i](#)

There are no non-standard protein/DNA/RNA residues in this entry.

5.5 Carbohydrates [i](#)

There are no oligosaccharides in this entry.

5.6 Ligand geometry [i](#)

There are no ligands in this entry.

5.7 Other polymers [i](#)

There are no such residues in this entry.

5.8 Polymer linkage issues [i](#)

The following chains have linkage breaks:

Mol	Chain	Number of breaks
43	A	1

All chain breaks are listed below:

Model	Chain	Residue-1	Atom-1	Residue-2	Atom-2	Distance (Å)
1	A	461:HIS	C	462:ARG	N	1.18

6 Map visualisation [i](#)

This section contains visualisations of the EMDB entry EMD-18529. These allow visual inspection of the internal detail of the map and identification of artifacts.

Images derived from a raw map, generated by summing the deposited half-maps, are presented below the corresponding image components of the primary map to allow further visual inspection and comparison with those of the primary map.

6.1 Orthogonal projections [i](#)

6.1.1 Primary map

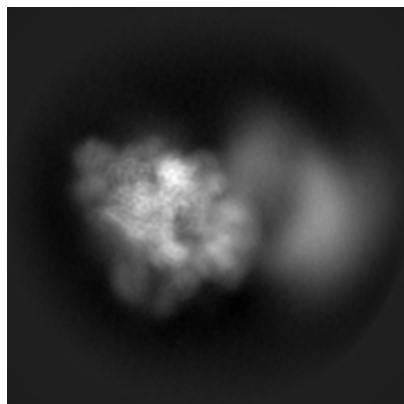

X

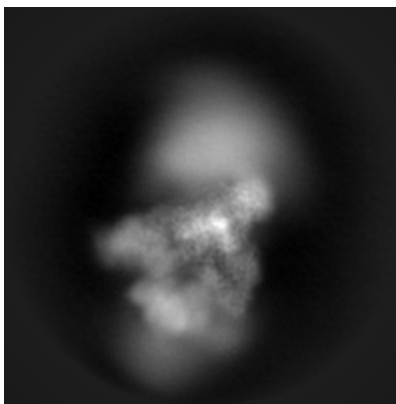

Y

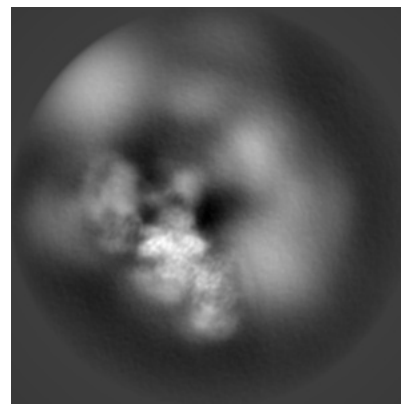

Z

6.1.2 Raw map

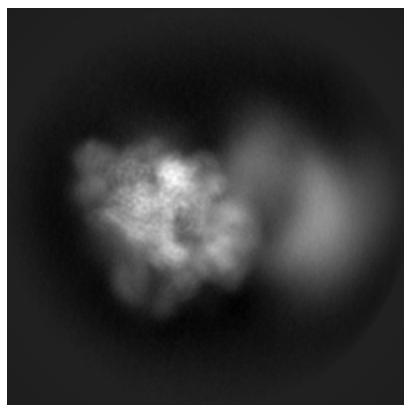

X

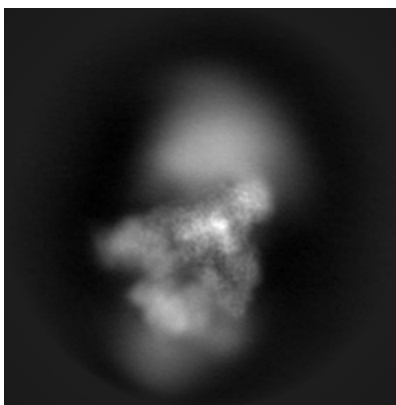

Y

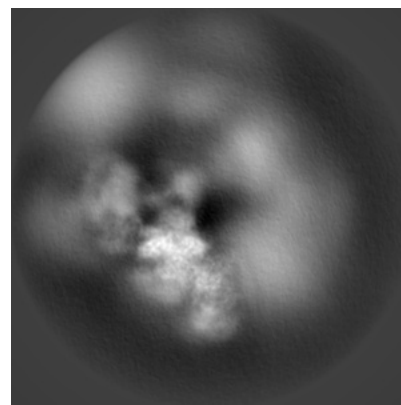

Z

The images above show the map projected in three orthogonal directions.

6.2 Central slices [i](#)

6.2.1 Primary map

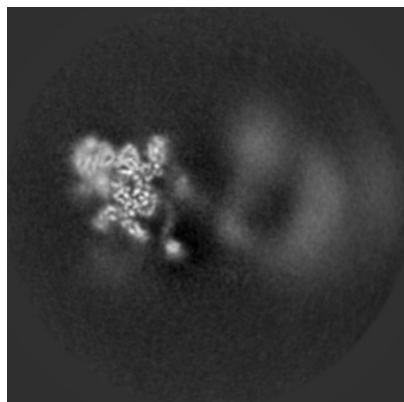

X Index: 130

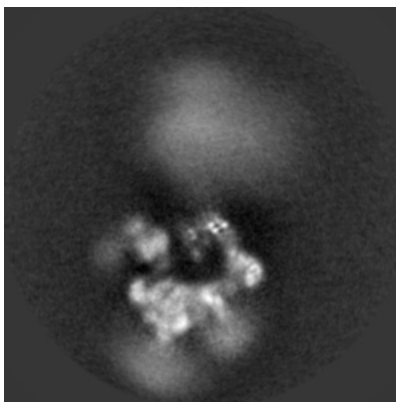

Y Index: 130

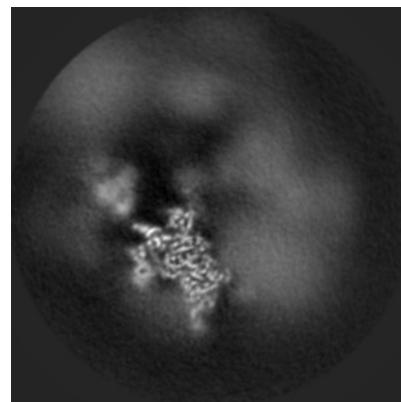

Z Index: 130

6.2.2 Raw map

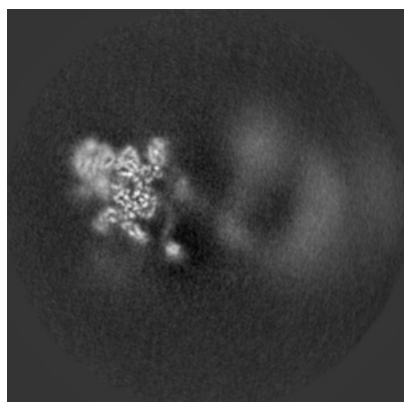

X Index: 130

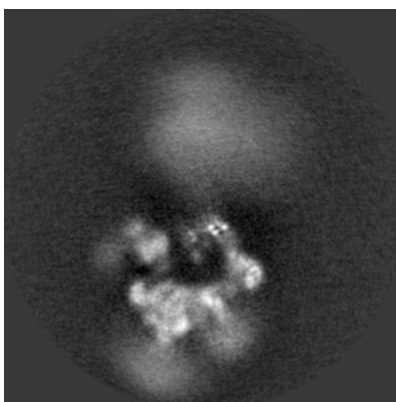

Y Index: 130

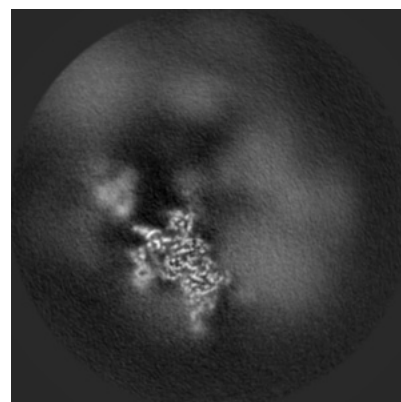

Z Index: 130

The images above show central slices of the map in three orthogonal directions.

6.3 Largest variance slices [i](#)

6.3.1 Primary map

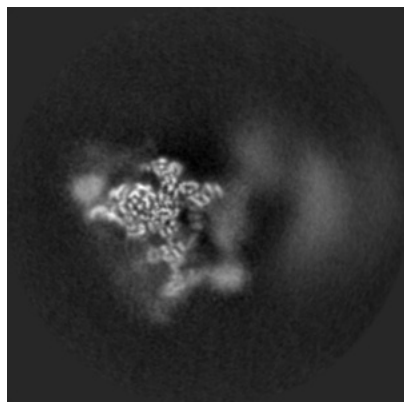

X Index: 118

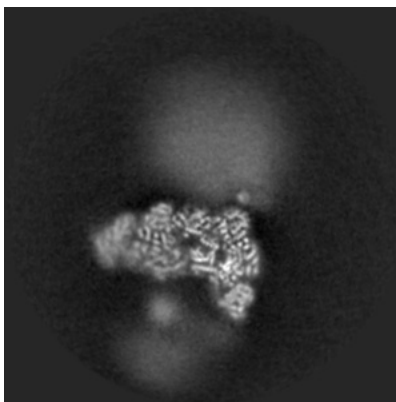

Y Index: 106

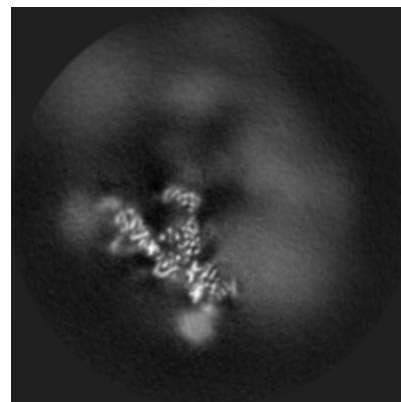

Z Index: 141

6.3.2 Raw map

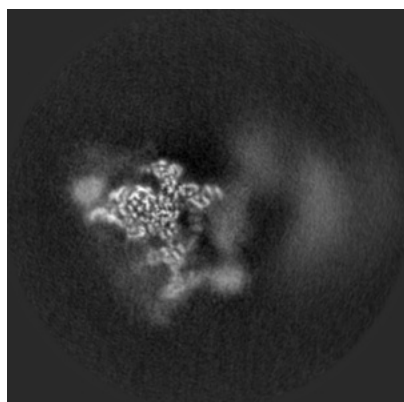

X Index: 118

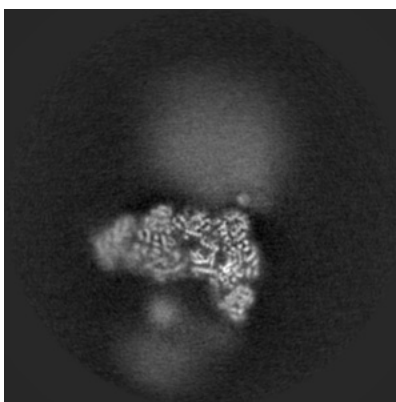

Y Index: 106

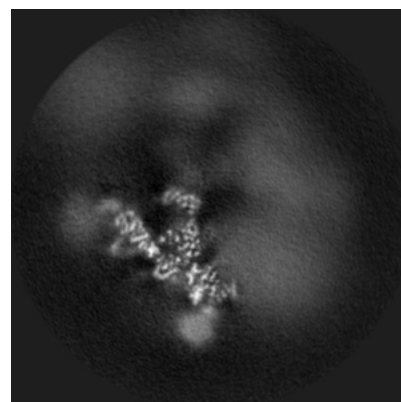

Z Index: 141

The images above show the largest variance slices of the map in three orthogonal directions.

6.4 Orthogonal standard-deviation projections (False-color) [i](#)

6.4.1 Primary map

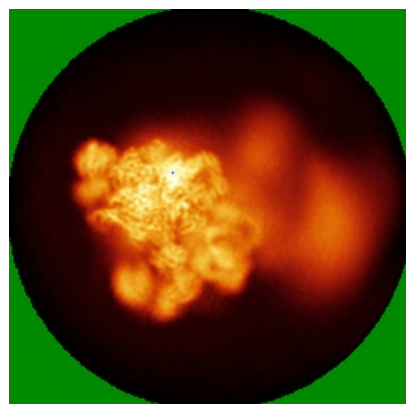

X

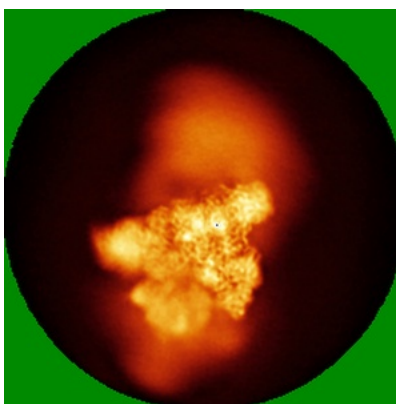

Y

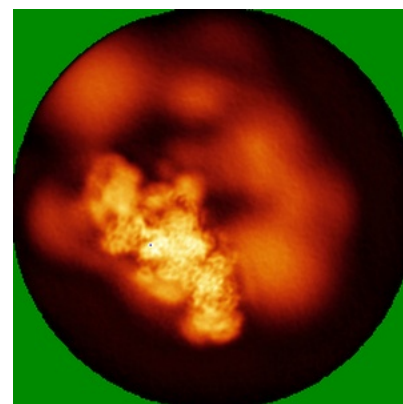

Z

6.4.2 Raw map

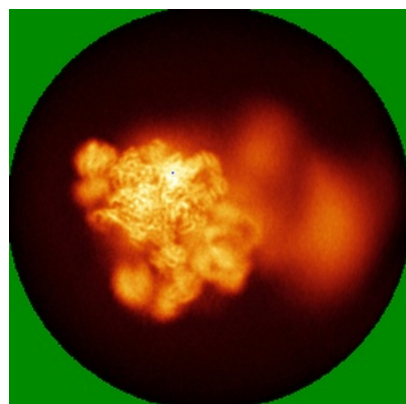

X

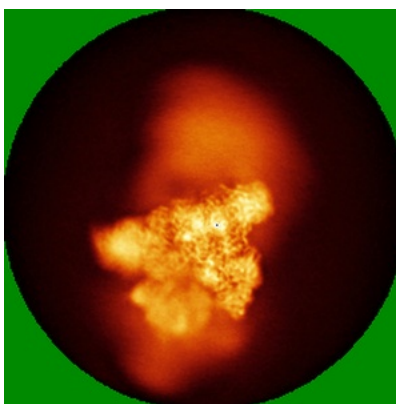

Y

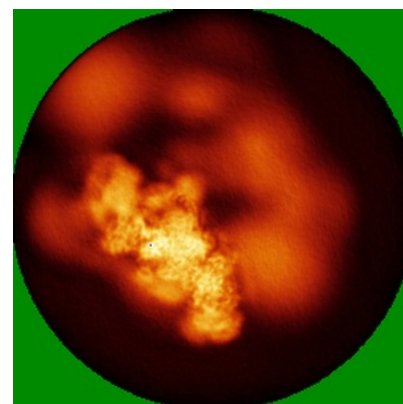

Z

The images above show the map standard deviation projections with false color in three orthogonal directions. Minimum values are shown in green, max in blue, and dark to light orange shades represent small to large values respectively.

6.5 Orthogonal surface views [i](#)

6.5.1 Primary map

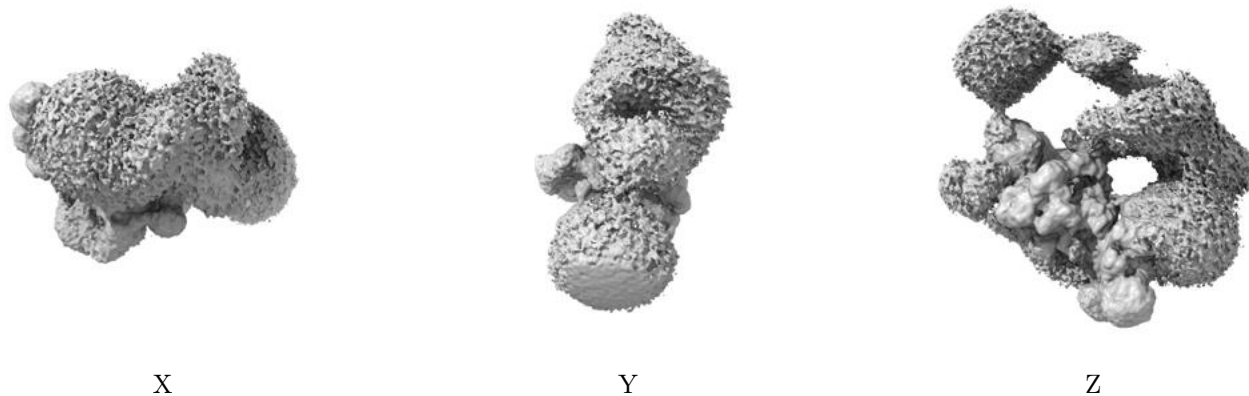

The images above show the 3D surface view of the map at the recommended contour level 0.02. These images, in conjunction with the slice images, may facilitate assessment of whether an appropriate contour level has been provided.

6.5.2 Raw map

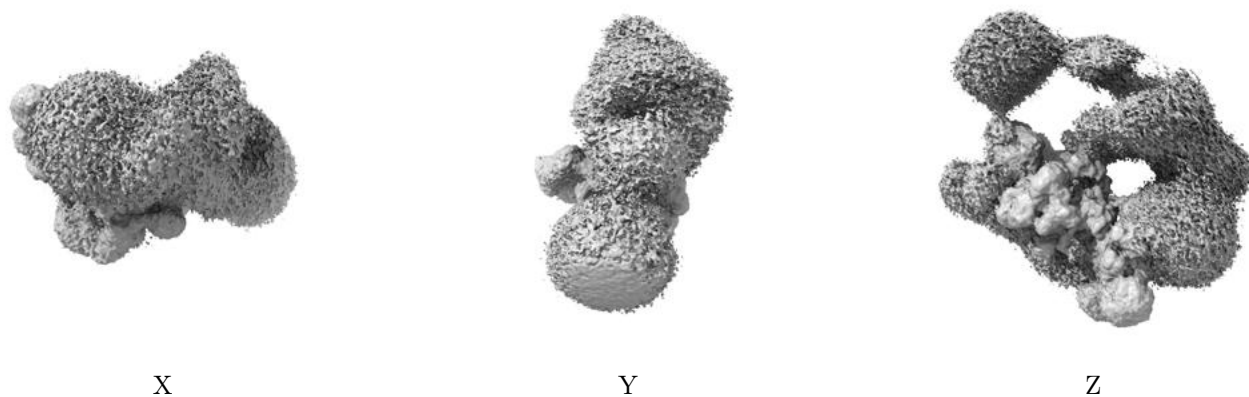

These images show the 3D surface of the raw map. The raw map's contour level was selected so that its surface encloses the same volume as the primary map does at its recommended contour level.

6.6 Mask visualisation [i](#)

This section was not generated. No masks/segmentation were deposited.

7 Map analysis [i](#)

This section contains the results of statistical analysis of the map.

7.1 Map-value distribution [i](#)

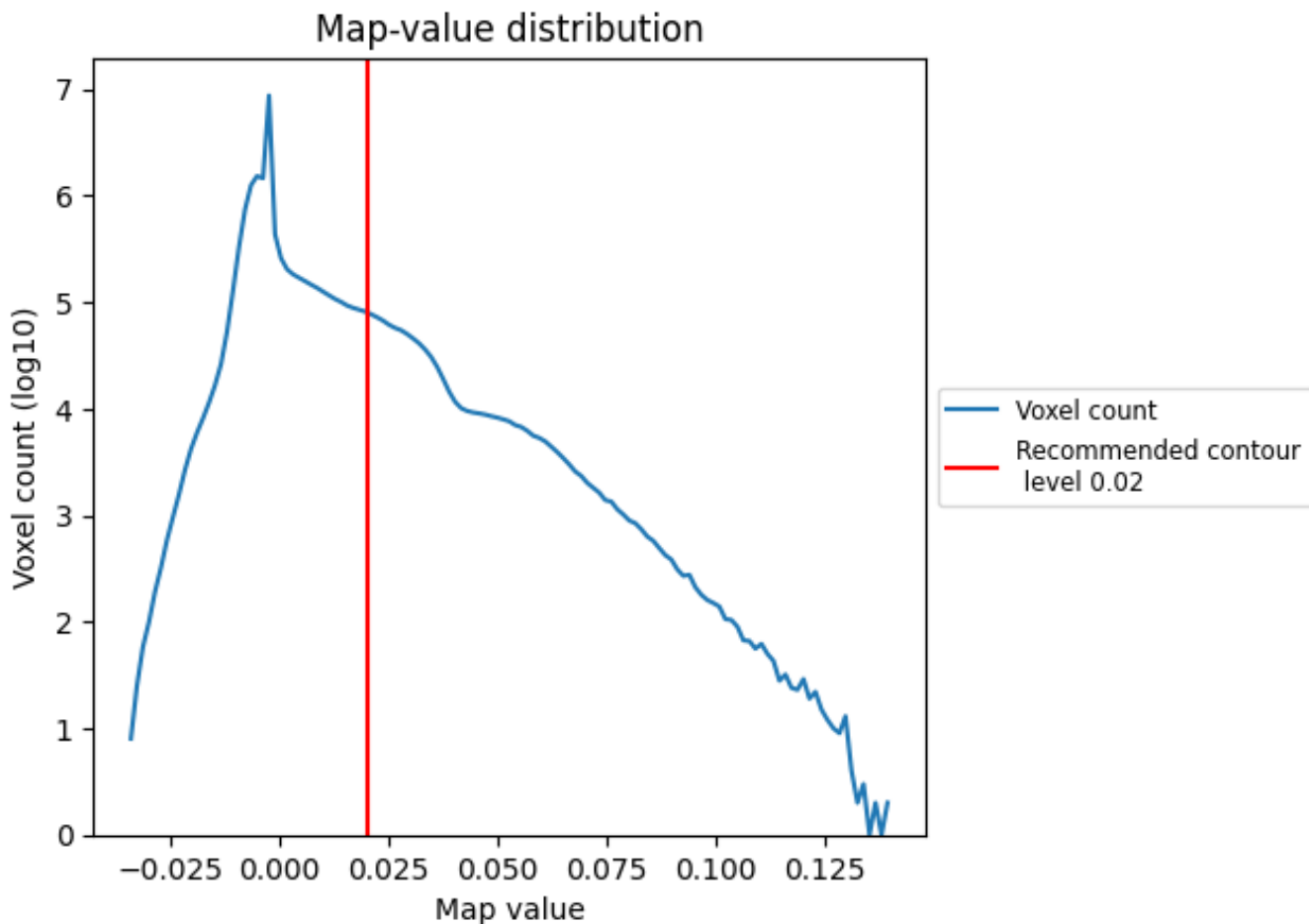

The map-value distribution is plotted in 128 intervals along the x-axis. The y-axis is logarithmic. A spike in this graph at zero usually indicates that the volume has been masked.

7.2 Volume estimate [\(i\)](#)

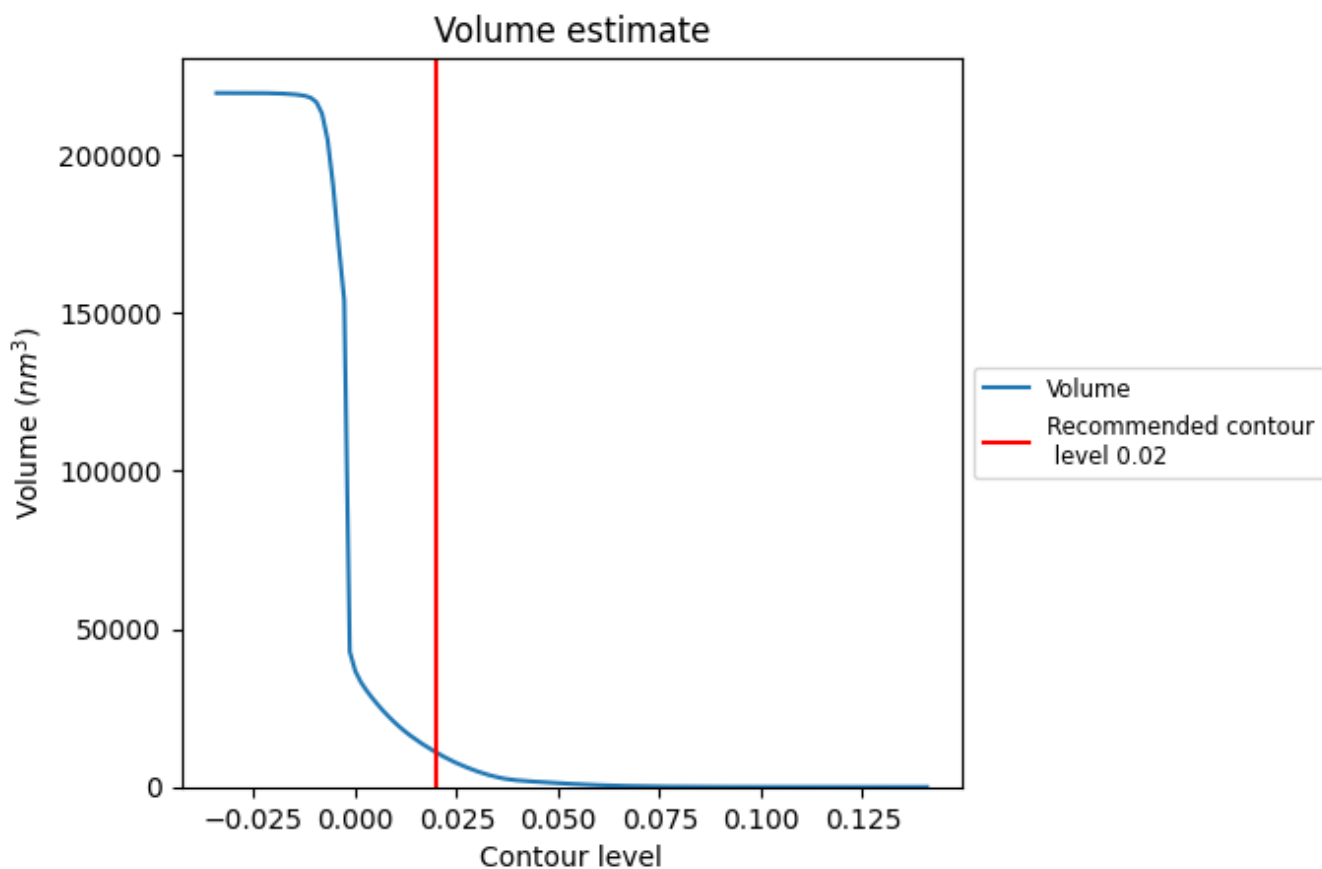

The volume at the recommended contour level is 10940 nm^3 ; this corresponds to an approximate mass of 9883 kDa.

The volume estimate graph shows how the enclosed volume varies with the contour level. The recommended contour level is shown as a vertical line and the intersection between the line and the curve gives the volume of the enclosed surface at the given level.

7.3 Rotationally averaged power spectrum i

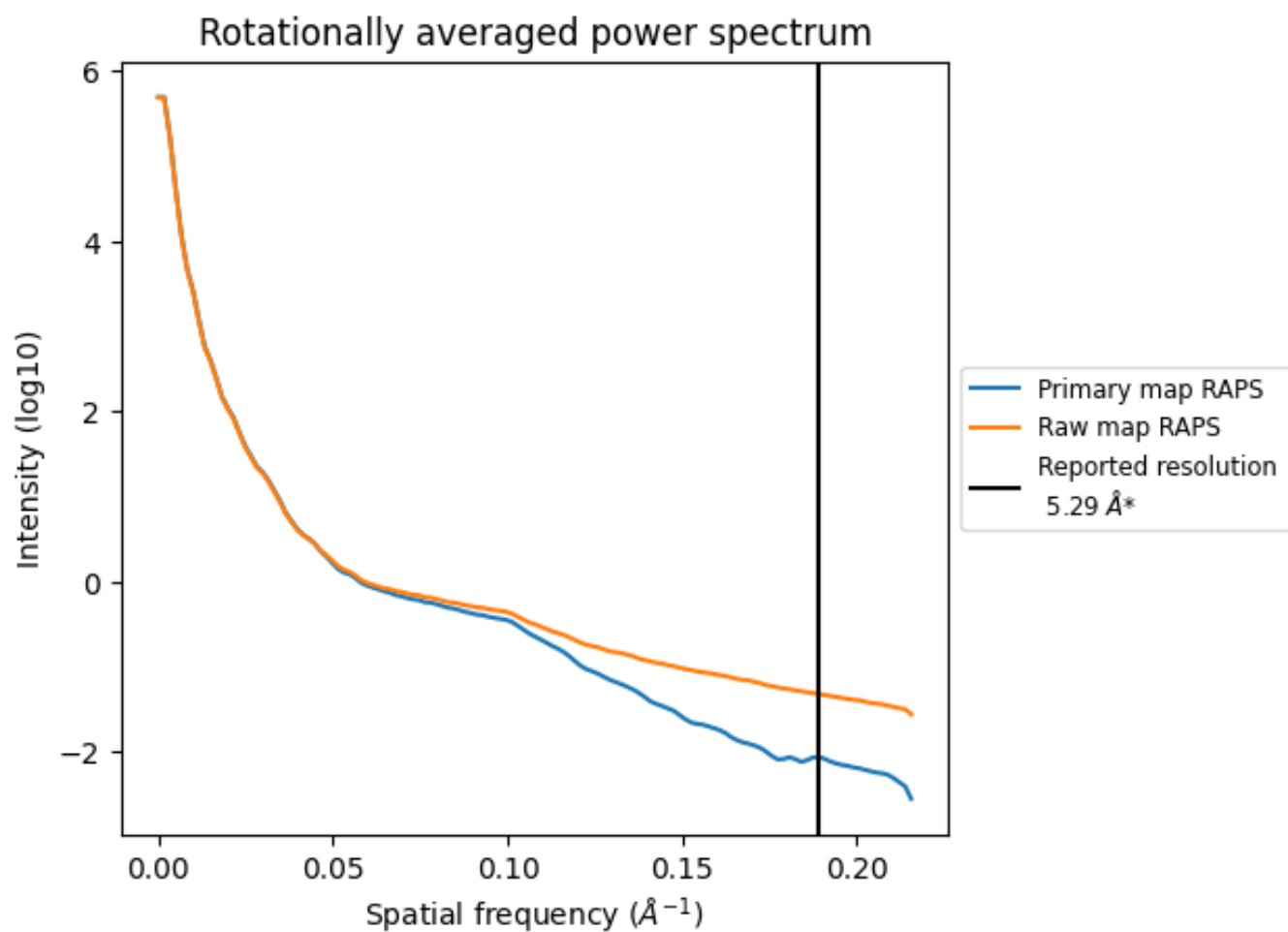

*Reported resolution corresponds to spatial frequency of 0.189 Å⁻¹

8 Fourier-Shell correlation [i](#)

Fourier-Shell Correlation (FSC) is the most commonly used method to estimate the resolution of single-particle and subtomogram-averaged maps. The shape of the curve depends on the imposed symmetry, mask and whether or not the two 3D reconstructions used were processed from a common reference. The reported resolution is shown as a black line. A curve is displayed for the half-bit criterion in addition to lines showing the 0.143 gold standard cut-off and 0.5 cut-off.

8.1 FSC [i](#)

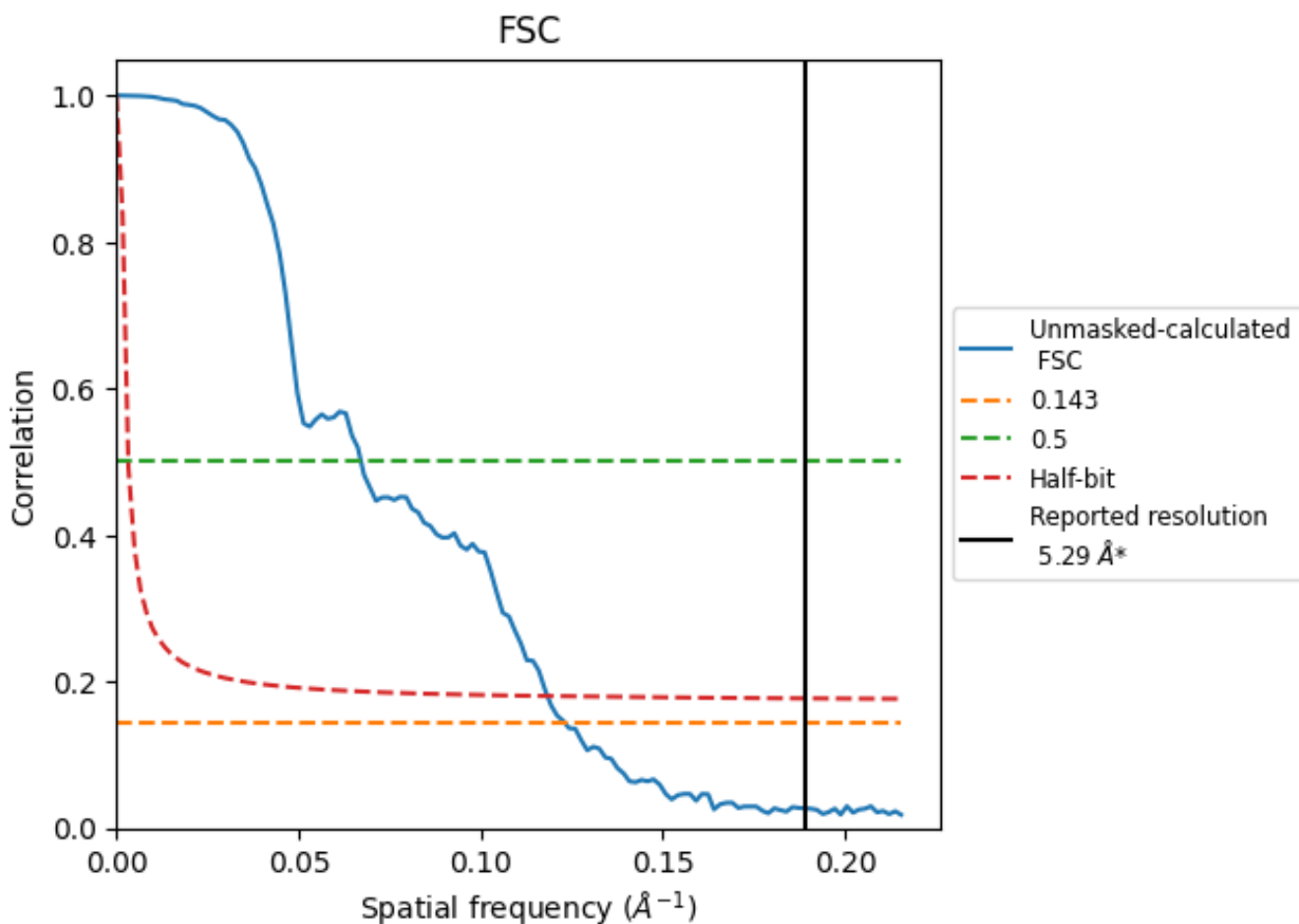

*Reported resolution corresponds to spatial frequency of 0.189 Å⁻¹

8.2 Resolution estimates [i](#)

Resolution estimate (Å)	Estimation criterion (FSC cut-off)		
	0.143	0.5	Half-bit
Reported by author	5.29	-	-
Author-provided FSC curve	-	-	-
Unmasked-calculated*	8.12	14.88	8.45

*Resolution estimate based on FSC curve calculated by comparison of deposited half-maps. The value from deposited half-maps intersecting FSC 0.143 CUT-OFF 8.12 differs from the reported value 5.29 by more than 10 %

9 Map-model fit [i](#)

This section contains information regarding the fit between EMDB map EMD-18529 and PDB model 8QO9. Per-residue inclusion information can be found in section 3 on page 15.

9.1 Map-model overlay [i](#)

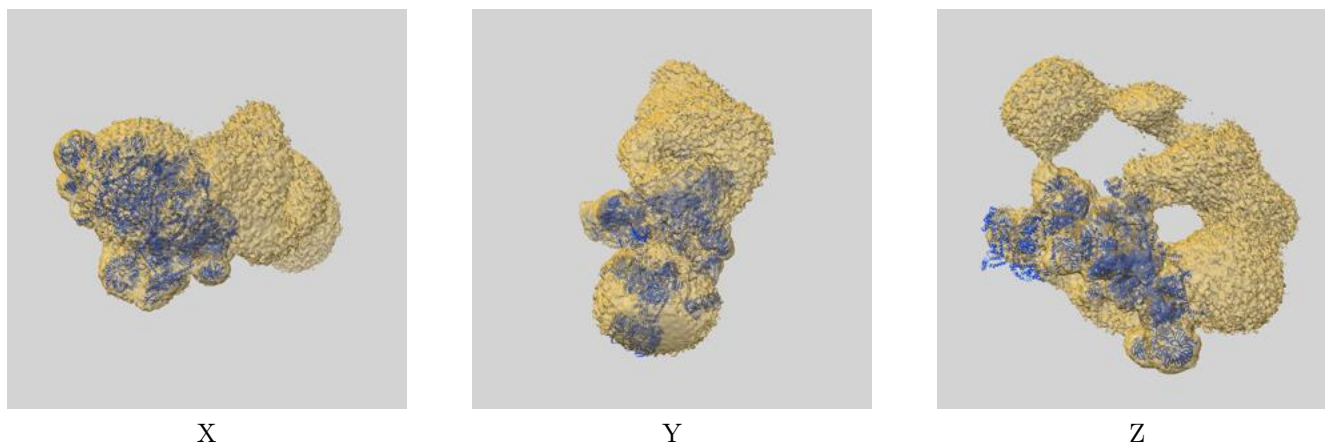

The images above show the 3D surface view of the map at the recommended contour level 0.02 at 50% transparency in yellow overlaid with a ribbon representation of the model coloured in blue. These images allow for the visual assessment of the quality of fit between the atomic model and the map.

9.2 Q-score mapped to coordinate model [i](#)

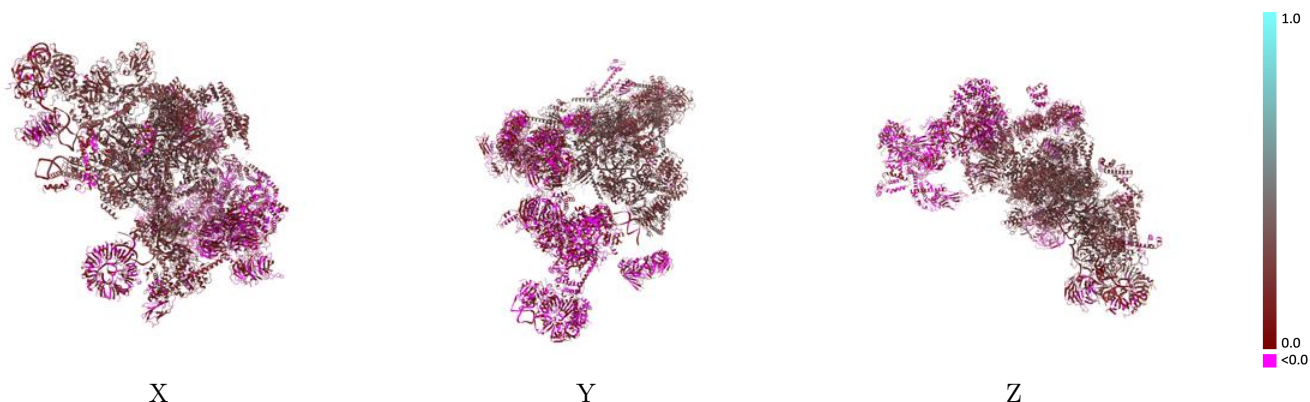

The images above show the model with each residue coloured according to its Q-score. This shows their resolvability in the map with higher Q-score values reflecting better resolvability. Please note: Q-score is calculating the resolvability of atoms, and thus high values are only expected at resolutions at which atoms can be resolved. Low Q-score values may therefore be expected for many entries.

9.3 Atom inclusion mapped to coordinate model [i](#)

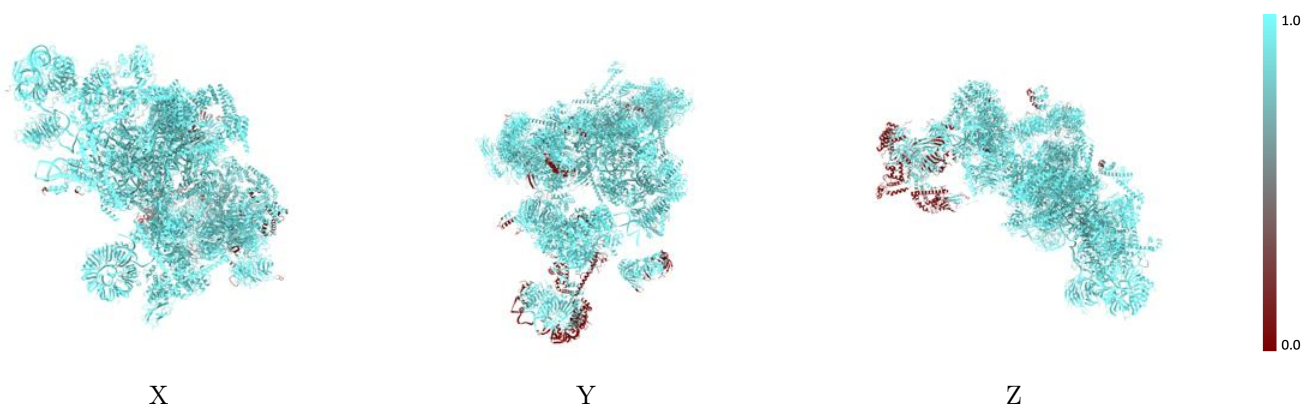

The images above show the model with each residue coloured according to its atom inclusion. This shows to what extent they are inside the map at the recommended contour level (0.02).



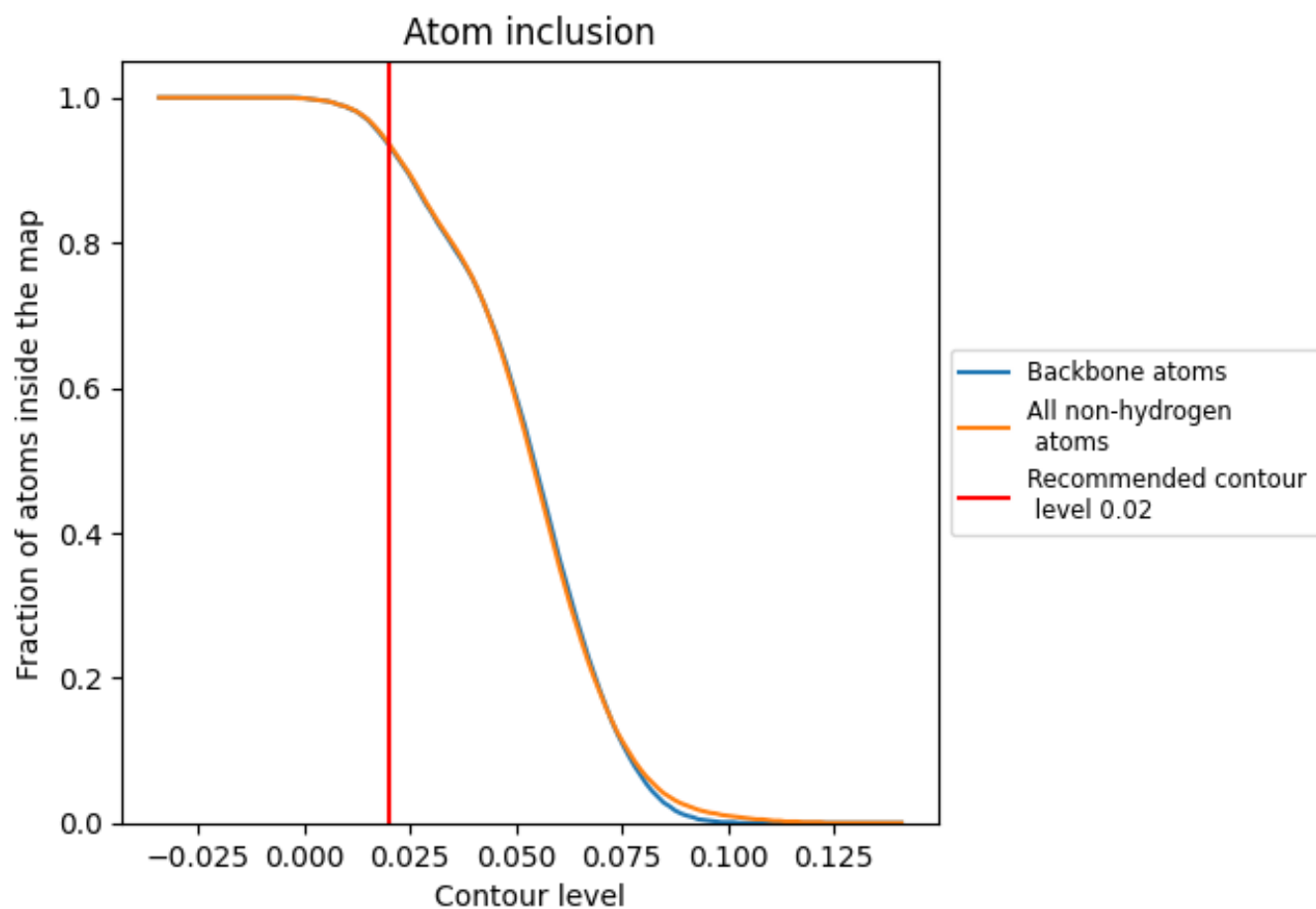



































































9.4 Atom inclusion [i](#)



At the recommended contour level, 94% of all backbone atoms, 94% of all non-hydrogen atoms, are inside the map.

9.5 Map-model fit summary











































































The table lists the average atom inclusion at the recommended contour level (0.02) and Q-score for the entire model and for each chain.

Chain	Atom inclusion	Q-score
All	 0.9370	 0.1580
2	 0.8310	 0.0270
21	 0.9550	 0.0410
22	 0.5140	 0.0130
23	 1.0000	 0.0220
2A	 0.8200	 0.0220
2B	 0.7570	 0.0160
2b	 1.0000	 0.0020
2e	 0.3570	 0.0210
2f	 0.2590	 0.0420
2g	 0.7640	 0.0410
4	 0.9990	 0.1710
41	 1.0000	 0.0340
42	 0.9980	 0.0600
43	 1.0000	 0.0350
4b	 1.0000	 0.0530
4e	 1.0000	 0.0510
4f	 1.0000	 0.0540
4g	 1.0000	 0.0230
5	 1.0000	 0.1840
51	 1.0000	 0.2060
52	 0.9920	 0.1130
53	 1.0000	 0.2640
5b	 0.9860	 0.1870
5e	 1.0000	 0.1950
5f	 1.0000	 0.1230
5g	 1.0000	 0.2370
6	 1.0000	 0.2000
62	 0.9420	 0.0120
63	 0.9190	 0.0070
64	 0.6280	 -0.0180
65	 0.6420	 0.0370
66	 0.8860	 -0.0100
67	 0.4190	 0.0540
68	 0.9470	 0.0500



Continued on next page...

Continued from previous page...

Chain	Atom inclusion	Q-score
7	 0.4450	 0.0960
8	 0.3390	 0.0500
9	 0.2770	 0.0100
A	 0.9980	 0.2880
B	 1.0000	 0.1950
B1	 0.9710	 0.0360
B2	 0.8320	 0.0190
B3	 0.9230	 0.0570
B4	 1.0000	 0.0240
B5	 1.0000	 0.0650
B6	 1.0000	 0.0630
BP	 1.0000	 0.0440
C	 1.0000	 0.2540
D	 1.0000	 0.2890
E	 0.9980	 0.0590
F	 1.0000	 0.2480
G	 0.8720	 0.0660
H	 0.9200	 0.0570
I	 1.0000	 0.2780
J	 1.0000	 0.2610
K	 0.9920	 0.2360
L	 1.0000	 0.2850
M	 1.0000	 0.2950
N	 1.0000	 0.2430
Q	 1.0000	 0.2340
S	 0.9910	 0.2670
T	 0.9340	 0.1530
W	 1.0000	 0.2050
X	 1.0000	 0.2490
Z	 1.0000	 0.1570
r	 1.0000	 0.2650
s	 1.0000	 0.2980
v	 0.9460	 0.0550
w	 0.8530	 0.0470
x	 0.8830	 0.0250
y	 0.9470	 -0.0010
z	 1.0000	 0.0640