



wwPDB EM Validation Summary Report ⓘ

Sep 4, 2024 – 04:41 pm BST

PDB ID : 8RN8
EMDB ID : EMD-19390
Title : Influenza B polymerase pseudo-symmetrical apo-dimer (FluPol(E)|FluPol(S))
Authors : Arragain, B.; Cusack, S.
Deposited on : 2024-01-09
Resolution : 2.92 Å(reported)

This is a wwPDB EM Validation Summary Report for a publicly released PDB entry.

We welcome your comments at validation@mail.wwpdb.org

A user guide is available at

<https://www.wwpdb.org/validation/2017/EMValidationReportHelp>

with specific help available everywhere you see the ⓘ symbol.

The types of validation reports are described at

<http://www.wwpdb.org/validation/2017/FAQs#types>.

The following versions of software and data (see [references ⓘ](#)) were used in the production of this report:

EMDB validation analysis : 0.0.1.dev112
MolProbity : 4.02b-467
Percentile statistics : 20231227.v01 (using entries in the PDB archive December 27th 2023)
MapQ : 1.9.13
Ideal geometry (proteins) : Engh & Huber (2001)
Ideal geometry (DNA, RNA) : Parkinson et al. (1996)
Validation Pipeline (wwPDB-VP) : 2.38.2

1 Overall quality at a glance i

The following experimental techniques were used to determine the structure:

ELECTRON MICROSCOPY

The reported resolution of this entry is 2.92 Å.

Percentile scores (ranging between 0-100) for global validation metrics of the entry are shown in the following graphic. The table shows the number of entries on which the scores are based.

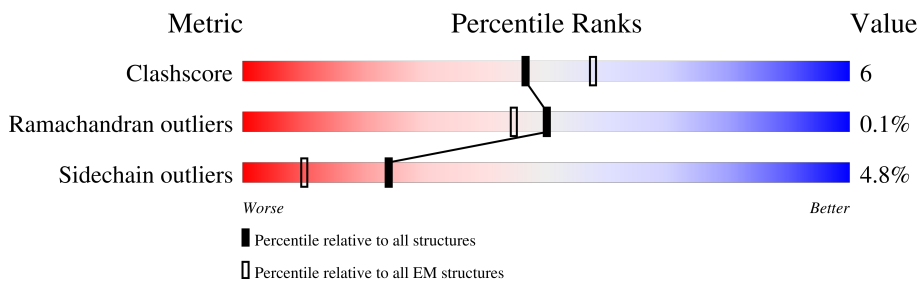

Metric	Whole archive (#Entries)	EM structures (#Entries)
Clashscore	210492	15764
Ramachandran outliers	207382	16835
Sidechain outliers	206894	16415

The table below summarises the geometric issues observed across the polymeric chains and their fit to the map. The red, orange, yellow and green segments of the bar indicate the fraction of residues that contain outliers for ≥ 3 , 2, 1 and 0 types of geometric quality criteria respectively. A grey segment represents the fraction of residues that are not modelled. The numeric value for each fraction is indicated below the corresponding segment, with a dot representing fractions $\leq 5\%$. The upper red bar (where present) indicates the fraction of residues that have poor fit to the EM map (all-atom inclusion $< 40\%$). The numeric value is given above the bar.

Mol	Chain	Length	Quality of chain
1	A	726	
1	D	726	
2	B	752	
2	E	752	
3	C	799	
3	F	799	

2 Entry composition [i](#)

There are 4 unique types of molecules in this entry. The entry contains 51366 atoms, of which 25704 are hydrogens and 0 are deuteriums.

In the tables below, the AltConf column contains the number of residues with at least one atom in alternate conformation and the Trace column contains the number of residues modelled with at most 2 atoms.

- Molecule 1 is a protein called Polymerase acidic protein.

Mol	Chain	Residues	Atoms						AltConf	Trace
			Total	C	H	N	O	S		
1	A	706	Total	C	H	N	O	S	0	0
			11326	3608	5653	951	1074	40		
1	D	518	Total	C	H	N	O	S	0	0
			8275	2628	4139	703	775	30		

- Molecule 2 is a protein called RNA-directed RNA polymerase catalytic subunit.

Mol	Chain	Residues	Atoms						AltConf	Trace
			Total	C	H	N	O	S		
2	B	622	Total	C	H	N	O	S	0	0
			9701	3079	4843	823	915	41		
2	E	640	Total	C	H	N	O	S	0	0
			10039	3172	5032	853	940	42		

- Molecule 3 is a protein called Polymerase basic protein 2.

Mol	Chain	Residues	Atoms						AltConf	Trace
			Total	C	H	N	O	S		
3	C	613	Total	C	H	N	O	S	0	0
			9818	3096	4937	847	903	35		
3	F	135	Total	C	H	N	O	S	0	0
			2202	706	1100	199	188	9		

There are 58 discrepancies between the modelled and reference sequences:

Chain	Residue	Modelled	Actual	Comment	Reference
C	771	GLY	-	expression tag	UNP Q5V8X3
C	772	TRP	-	expression tag	UNP Q5V8X3
C	773	SER	-	expression tag	UNP Q5V8X3
C	774	HIS	-	expression tag	UNP Q5V8X3
C	775	PRO	-	expression tag	UNP Q5V8X3
C	776	GLN	-	expression tag	UNP Q5V8X3
C	777	PHE	-	expression tag	UNP Q5V8X3
C	778	GLU	-	expression tag	UNP Q5V8X3
C	779	LYS	-	expression tag	UNP Q5V8X3

Continued on next page...

Continued from previous page...

Chain	Residue	Modelled	Actual	Comment	Reference
C	780	GLY	-	expression tag	UNP Q5V8X3
C	781	GLY	-	expression tag	UNP Q5V8X3
C	782	GLY	-	expression tag	UNP Q5V8X3
C	783	SER	-	expression tag	UNP Q5V8X3
C	784	GLY	-	expression tag	UNP Q5V8X3
C	785	GLY	-	expression tag	UNP Q5V8X3
C	786	GLY	-	expression tag	UNP Q5V8X3
C	787	SER	-	expression tag	UNP Q5V8X3
C	788	GLY	-	expression tag	UNP Q5V8X3
C	789	GLY	-	expression tag	UNP Q5V8X3
C	790	SER	-	expression tag	UNP Q5V8X3
C	791	ALA	-	expression tag	UNP Q5V8X3
C	792	TRP	-	expression tag	UNP Q5V8X3
C	793	SER	-	expression tag	UNP Q5V8X3
C	794	HIS	-	expression tag	UNP Q5V8X3
C	795	PRO	-	expression tag	UNP Q5V8X3
C	796	GLN	-	expression tag	UNP Q5V8X3
C	797	PHE	-	expression tag	UNP Q5V8X3
C	798	GLU	-	expression tag	UNP Q5V8X3
C	799	LYS	-	expression tag	UNP Q5V8X3
F	771	GLY	-	expression tag	UNP Q5V8X3
F	772	TRP	-	expression tag	UNP Q5V8X3
F	773	SER	-	expression tag	UNP Q5V8X3
F	774	HIS	-	expression tag	UNP Q5V8X3
F	775	PRO	-	expression tag	UNP Q5V8X3
F	776	GLN	-	expression tag	UNP Q5V8X3
F	777	PHE	-	expression tag	UNP Q5V8X3
F	778	GLU	-	expression tag	UNP Q5V8X3
F	779	LYS	-	expression tag	UNP Q5V8X3
F	780	GLY	-	expression tag	UNP Q5V8X3
F	781	GLY	-	expression tag	UNP Q5V8X3
F	782	GLY	-	expression tag	UNP Q5V8X3
F	783	SER	-	expression tag	UNP Q5V8X3
F	784	GLY	-	expression tag	UNP Q5V8X3
F	785	GLY	-	expression tag	UNP Q5V8X3
F	786	GLY	-	expression tag	UNP Q5V8X3
F	787	SER	-	expression tag	UNP Q5V8X3
F	788	GLY	-	expression tag	UNP Q5V8X3
F	789	GLY	-	expression tag	UNP Q5V8X3
F	790	SER	-	expression tag	UNP Q5V8X3
F	791	ALA	-	expression tag	UNP Q5V8X3
F	792	TRP	-	expression tag	UNP Q5V8X3

Continued on next page...

Continued from previous page...

Chain	Residue	Modelled	Actual	Comment	Reference
F	793	SER	-	expression tag	UNP Q5V8X3
F	794	HIS	-	expression tag	UNP Q5V8X3
F	795	PRO	-	expression tag	UNP Q5V8X3
F	796	GLN	-	expression tag	UNP Q5V8X3
F	797	PHE	-	expression tag	UNP Q5V8X3
F	798	GLU	-	expression tag	UNP Q5V8X3
F	799	LYS	-	expression tag	UNP Q5V8X3

- Molecule 4 is MAGNESIUM ION (three-letter code: MG) (formula: Mg) (labeled as "Ligand of Interest" by depositor).

Mol	Chain	Residues	Atoms	AltConf
4	A	1	Total Mg 1 1	0
4	B	2	Total Mg 2 2	0
4	E	2	Total Mg 2 2	0

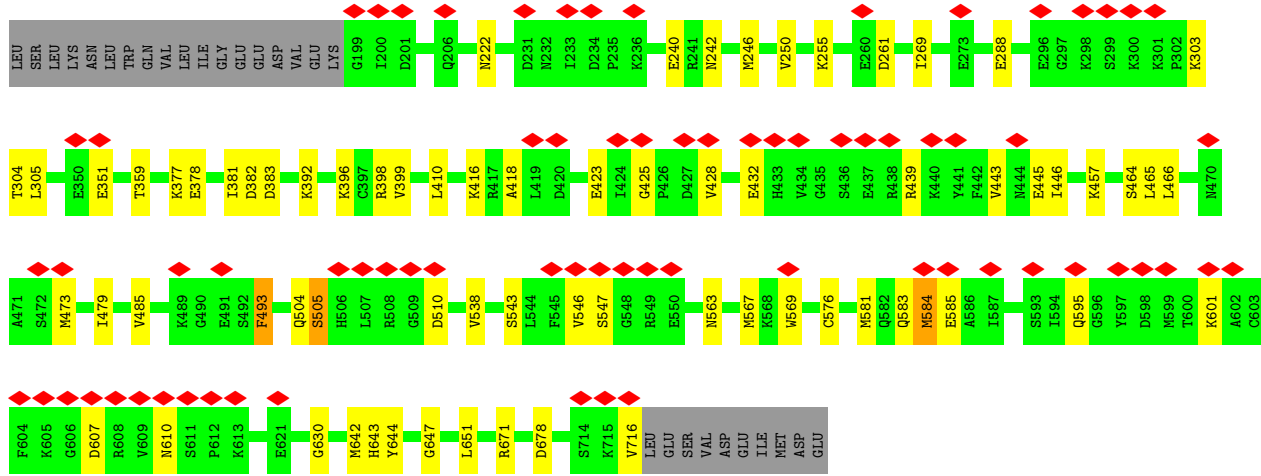

● Molecule 2: RNA-directed RNA polymerase catalytic subunit

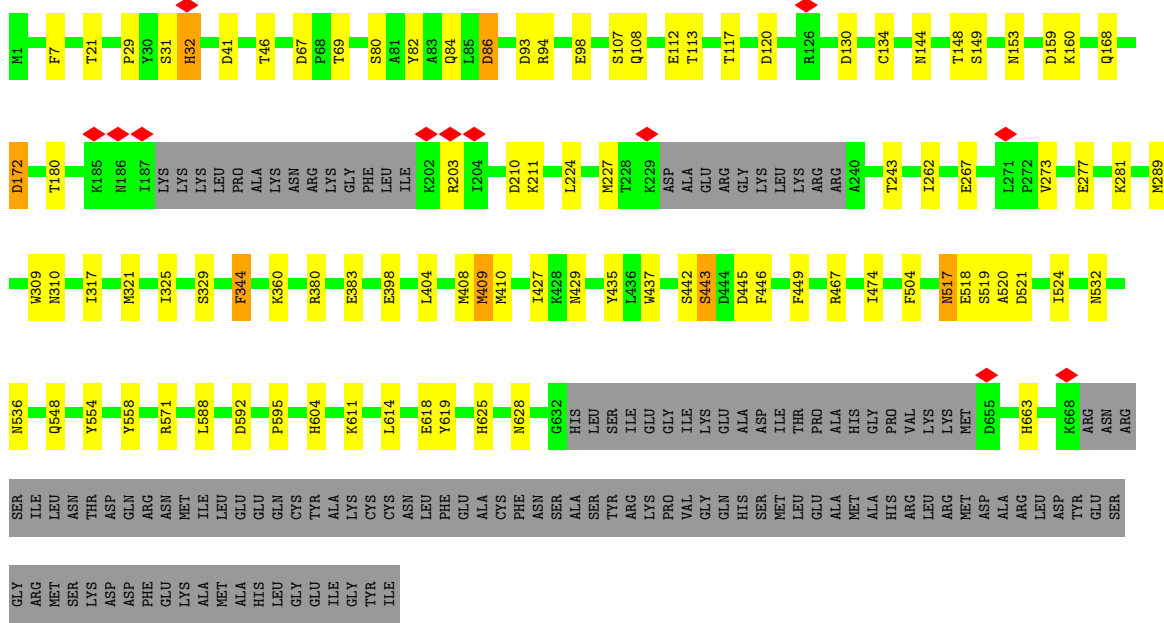

● Molecule 2: RNA-directed RNA polymerase catalytic subunit

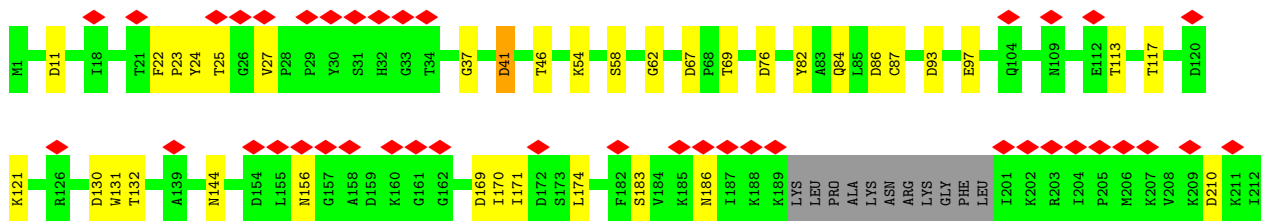

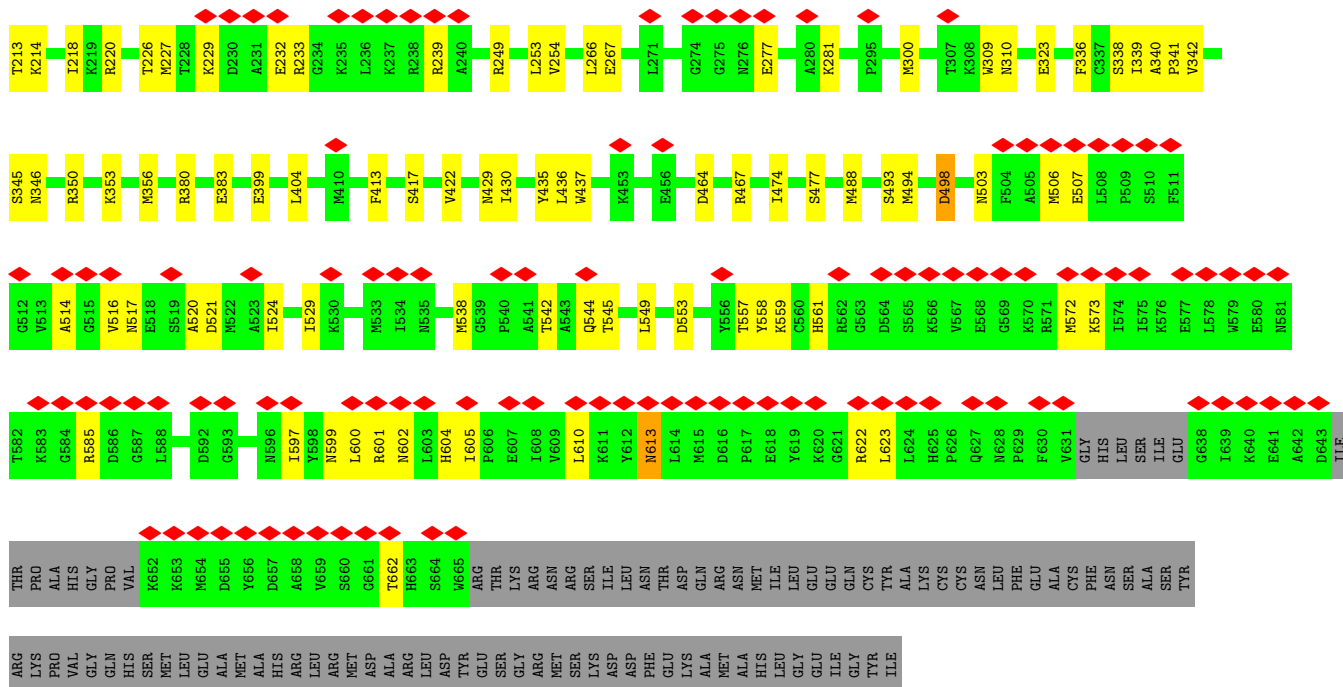

• Molecule 3: Polymerase basic protein 2

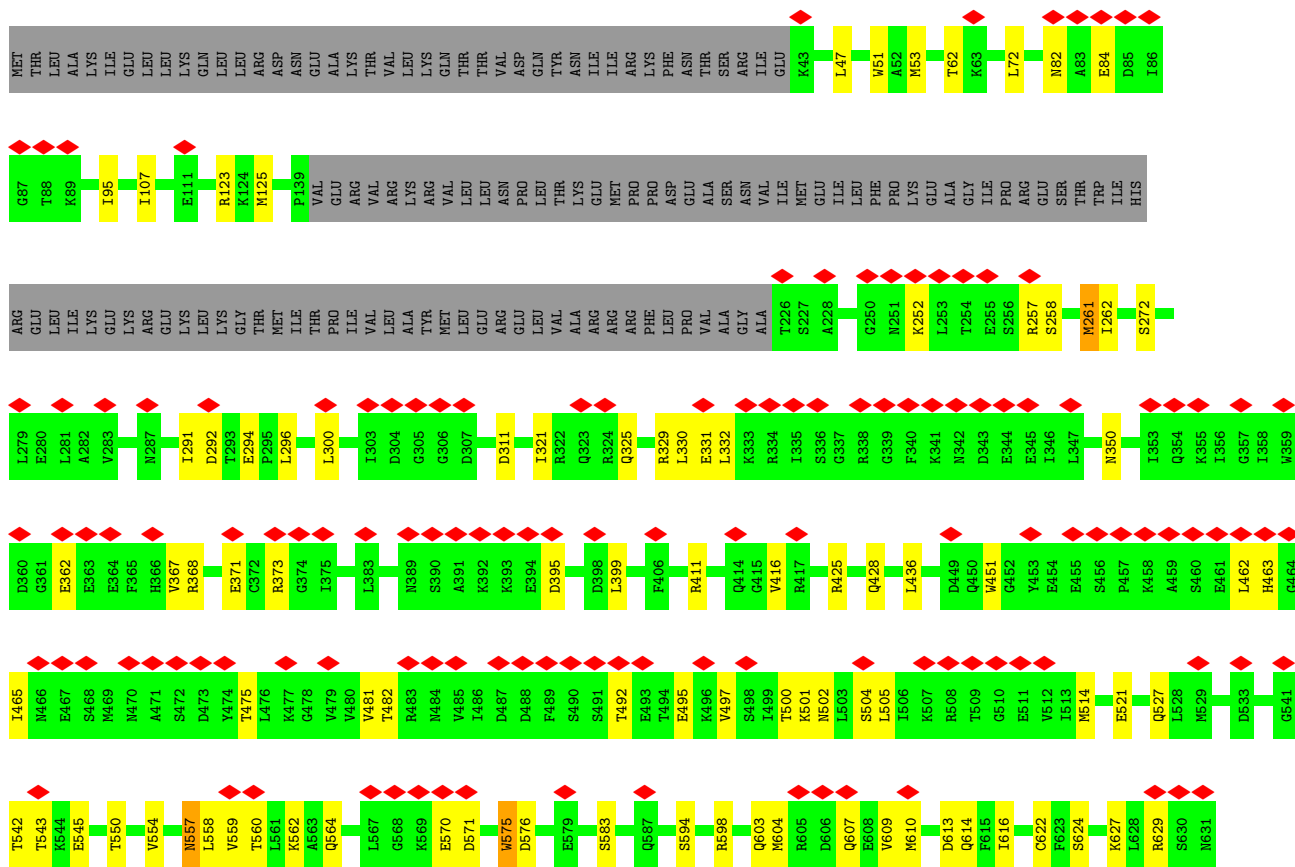

GLY
SER
GLY
GLY
GLY
SER
GLY
GLY
SER
ALA
TRP
SER
HIS
PRO
GLN
PHE
GLU
LYS

4 Experimental information

Property	Value	Source
EM reconstruction method	SINGLE PARTICLE	Depositor
Imposed symmetry	POINT, Not provided	
Number of particles used	179550	Depositor
Resolution determination method	FSC 0.143 CUT-OFF	Depositor
CTF correction method	PHASE FLIPPING AND AMPLITUDE CORRECTION	Depositor
Microscope	TFS KRIOS	Depositor
Voltage (kV)	300	Depositor
Electron dose ($e^-/\text{\AA}^2$)	40	Depositor
Minimum defocus (nm)	800	Depositor
Maximum defocus (nm)	2000	Depositor
Magnification	Not provided	
Image detector	GATAN K3 BIOQUANTUM (6k x 4k)	Depositor
Maximum map value	5.184	Depositor
Minimum map value	-3.789	Depositor
Average map value	-0.000	Depositor
Map value standard deviation	0.085	Depositor
Recommended contour level	0.5	Depositor
Map size (\AA)	403.19998, 403.19998, 403.19998	wwPDB
Map dimensions	480, 480, 480	wwPDB
Map angles ($^\circ$)	90.0, 90.0, 90.0	wwPDB
Pixel spacing (\AA)	0.84, 0.84, 0.84	Depositor

5 Model quality [i](#)

5.1 Standard geometry [i](#)

Bond lengths and bond angles in the following residue types are not validated in this section: MG

The Z score for a bond length (or angle) is the number of standard deviations the observed value is removed from the expected value. A bond length (or angle) with $|Z| > 5$ is considered an outlier worth inspection. RMSZ is the root-mean-square of all Z scores of the bond lengths (or angles).

Mol	Chain	Bond lengths		Bond angles	
		RMSZ	# Z >5	RMSZ	# Z >5
1	A	0.26	0/5789	0.47	0/7806
1	D	0.25	0/4223	0.48	0/5696
2	B	0.26	0/4955	0.48	0/6694
2	E	0.25	0/5104	0.47	0/6886
3	C	0.25	0/4967	0.49	0/6673
3	F	0.24	0/1130	0.53	0/1524
All	All	0.25	0/26168	0.48	0/35279

There are no bond length outliers.

There are no bond angle outliers.

There are no chirality outliers.

There are no planarity outliers.

5.2 Too-close contacts [i](#)

In the following table, the Non-H and H(model) columns list the number of non-hydrogen atoms and hydrogen atoms in the chain respectively. The H(added) column lists the number of hydrogen atoms added and optimized by MolProbity. The Clashes column lists the number of clashes within the asymmetric unit, whereas Symm-Clashes lists symmetry-related clashes.

Mol	Chain	Non-H	H(model)	H(added)	Clashes	Symm-Clashes
1	A	5673	5653	5653	78	0
1	D	4136	4139	4138	38	0
2	B	4858	4843	4857	56	0
2	E	5007	5032	5029	70	0
3	C	4881	4937	4948	71	0
3	F	1102	1100	1097	14	0
4	A	1	0	0	0	0

Continued on next page...

Continued from previous page...

Mol	Chain	Non-H	H(model)	H(added)	Clashes	Symm-Clashes
4	B	2	0	0	0	0
4	E	2	0	0	0	0
All	All	25662	25704	25722	301	0

The all-atom clashscore is defined as the number of clashes found per 1000 atoms (including hydrogen atoms). The all-atom clashscore for this structure is 6.

The worst 5 of 301 close contacts within the same asymmetric unit are listed below, sorted by their clash magnitude.

Atom-1	Atom-2	Interatomic distance (Å)	Clash overlap (Å)
3:C:713:THR:OG1	3:C:716:GLU:OE1	1.88	0.91
2:E:23:PRO:O	2:E:233:ARG:NH2	2.11	0.83
2:E:383:GLU:N	2:E:383:GLU:OE2	2.11	0.82
1:A:135:LYS:NZ	1:A:197:GLU:OE2	2.14	0.81
2:B:227:MET:SD	2:B:243:THR:OG1	2.40	0.80

There are no symmetry-related clashes.

5.3 Torsion angles [i](#)

5.3.1 Protein backbone [i](#)

In the following table, the Percentiles column shows the percent Ramachandran outliers of the chain as a percentile score with respect to all PDB entries followed by that with respect to all EM entries.

The Analysed column shows the number of residues for which the backbone conformation was analysed, and the total number of residues.

Mol	Chain	Analysed	Favoured	Allowed	Outliers	Percentiles	
1	A	702/726 (97%)	670 (95%)	32 (5%)	0	100	100
1	D	516/726 (71%)	497 (96%)	18 (4%)	1 (0%)	44	72
2	B	614/752 (82%)	593 (97%)	20 (3%)	1 (0%)	44	72
2	E	632/752 (84%)	618 (98%)	14 (2%)	0	100	100
3	C	609/799 (76%)	580 (95%)	28 (5%)	1 (0%)	44	72
3	F	129/799 (16%)	127 (98%)	2 (2%)	0	100	100
All	All	3202/4554 (70%)	3085 (96%)	114 (4%)	3 (0%)	50	76

All (3) Ramachandran outliers are listed below:

Mol	Chain	Res	Type
1	D	505	SER
2	B	443	SER
3	C	292	ASP

5.3.2 Protein sidechains [i](#)

In the following table, the Percentiles column shows the percent sidechain outliers of the chain as a percentile score with respect to all PDB entries followed by that with respect to all EM entries.

The Analysed column shows the number of residues for which the sidechain conformation was analysed, and the total number of residues.

Mol	Chain	Analysed	Rotameric	Outliers	Percentiles	
1	A	628/645 (97%)	593 (94%)	35 (6%)	17	46
1	D	458/645 (71%)	435 (95%)	23 (5%)	20	50
2	B	535/645 (83%)	518 (97%)	17 (3%)	34	67
2	E	550/645 (85%)	522 (95%)	28 (5%)	20	50
3	C	531/693 (77%)	508 (96%)	23 (4%)	25	56
3	F	116/693 (17%)	108 (93%)	8 (7%)	13	36
All	All	2818/3966 (71%)	2684 (95%)	134 (5%)	24	52

5 of 134 residues with a non-rotameric sidechain are listed below:

Mol	Chain	Res	Type
2	E	477	SER
2	E	561	HIS
3	F	142	ARG
2	B	410	MET
2	B	409	MET

Sometimes sidechains can be flipped to improve hydrogen bonding and reduce clashes. All (1) such sidechains are listed below:

Mol	Chain	Res	Type
2	E	602	ASN

5.3.3 RNA [i](#)

There are no RNA molecules in this entry.

5.4 Non-standard residues in protein, DNA, RNA chains [i](#)

There are no non-standard protein/DNA/RNA residues in this entry.

5.5 Carbohydrates [i](#)

There are no oligosaccharides in this entry.

5.6 Ligand geometry [i](#)

Of 5 ligands modelled in this entry, 5 are monoatomic - leaving 0 for Mogul analysis.

There are no bond length outliers.

There are no bond angle outliers.

There are no chirality outliers.

There are no torsion outliers.

There are no ring outliers.

No monomer is involved in short contacts.

5.7 Other polymers [i](#)

There are no such residues in this entry.

5.8 Polymer linkage issues [i](#)

There are no chain breaks in this entry.

6 Map visualisation [i](#)

This section contains visualisations of the EMDB entry EMD-19390. These allow visual inspection of the internal detail of the map and identification of artifacts.

Images derived from a raw map, generated by summing the deposited half-maps, are presented below the corresponding image components of the primary map to allow further visual inspection and comparison with those of the primary map.

6.1 Orthogonal projections [i](#)

6.1.1 Primary map

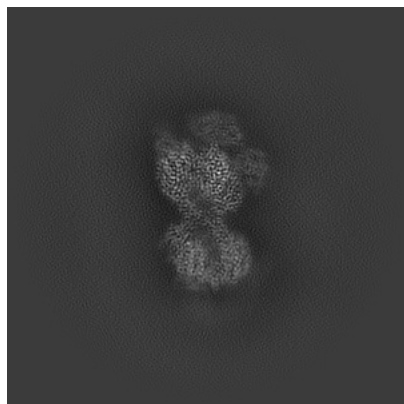

X

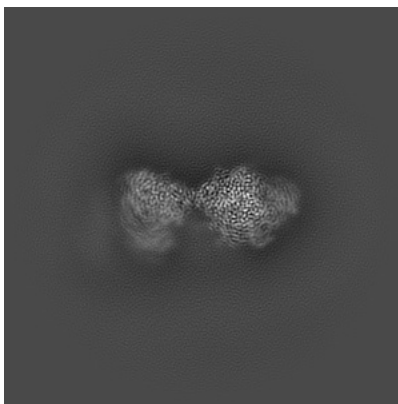

Y

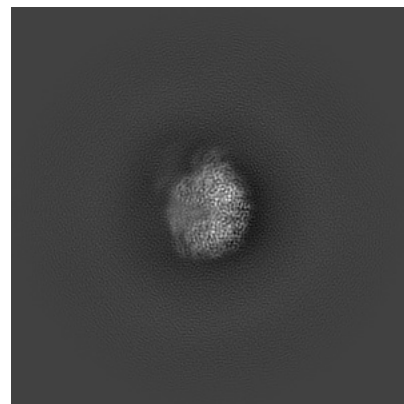

Z

6.1.2 Raw map

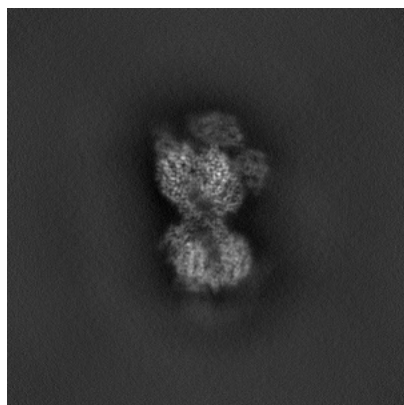

X

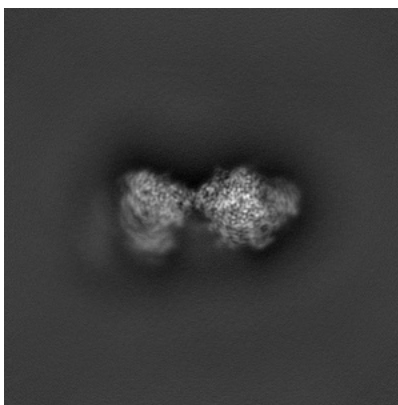

Y

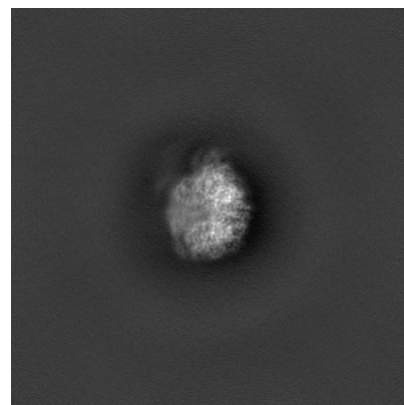

Z

The images above show the map projected in three orthogonal directions.

6.2 Central slices [i](#)

6.2.1 Primary map

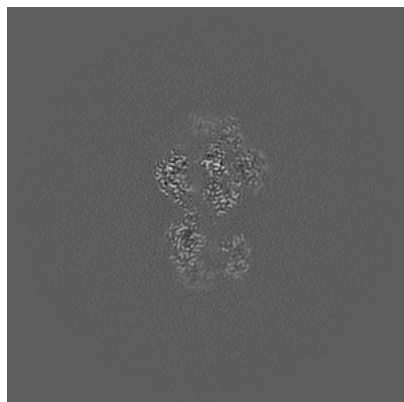

X Index: 240

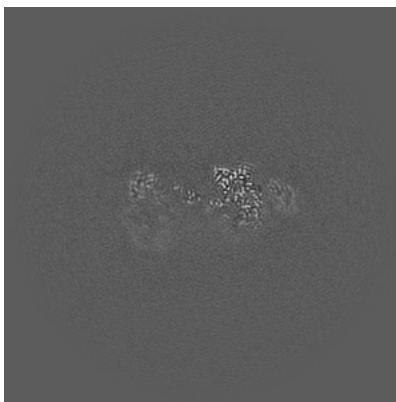

Y Index: 240

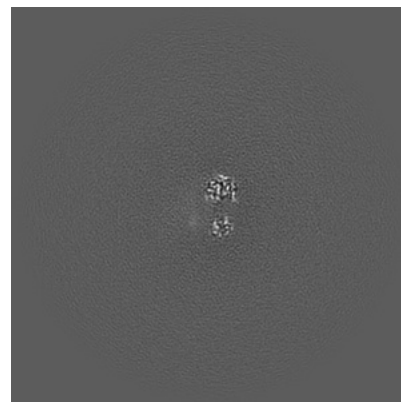

Z Index: 240

6.2.2 Raw map

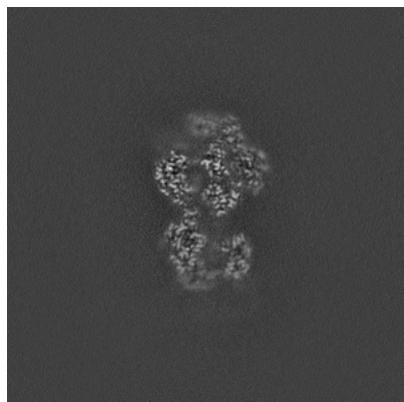

X Index: 240

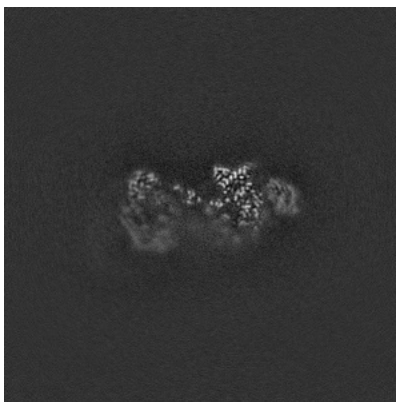

Y Index: 240

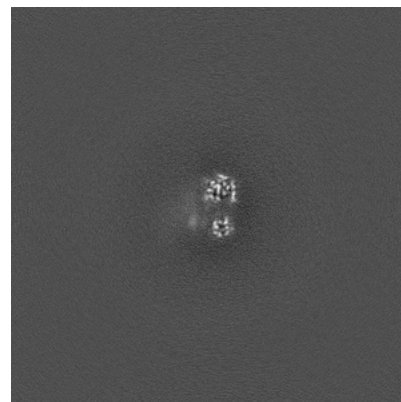

Z Index: 240

The images above show central slices of the map in three orthogonal directions.

6.3 Largest variance slices [i](#)

6.3.1 Primary map

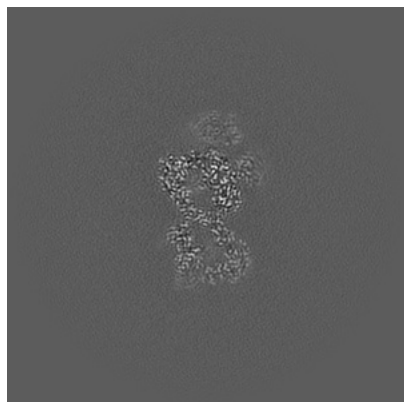

X Index: 252

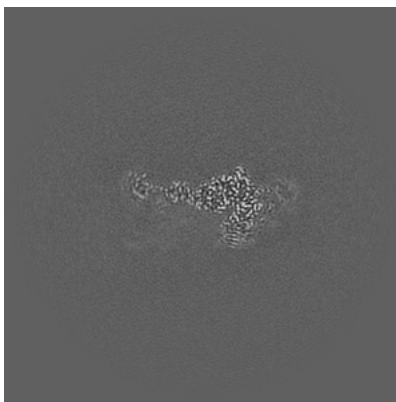

Y Index: 254

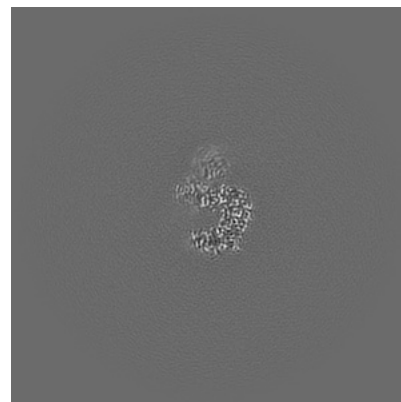

Z Index: 288

6.3.2 Raw map

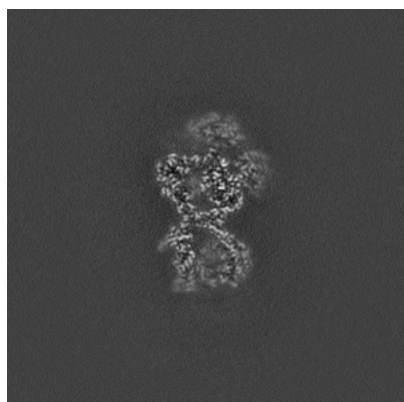

X Index: 249

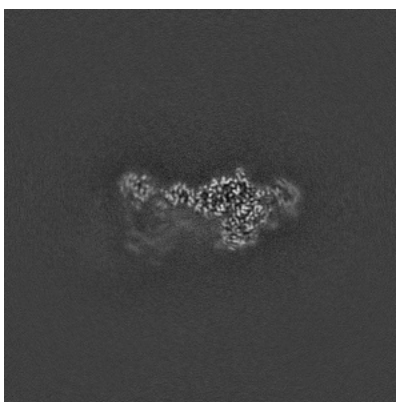

Y Index: 253

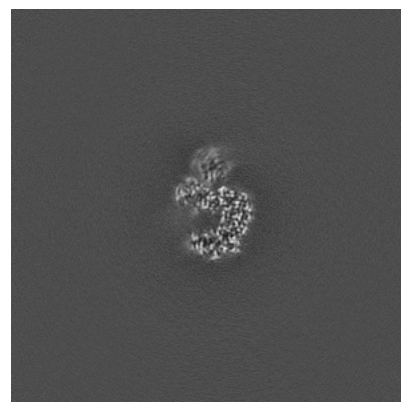

Z Index: 287

The images above show the largest variance slices of the map in three orthogonal directions.

6.4 Orthogonal standard-deviation projections (False-color) [i](#)

6.4.1 Primary map

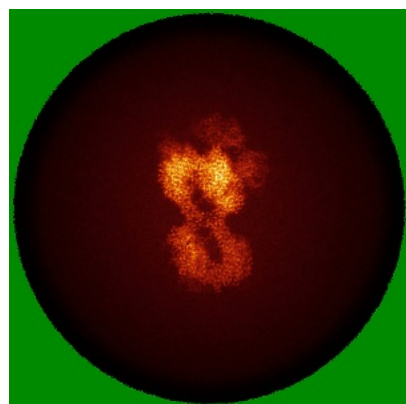

X

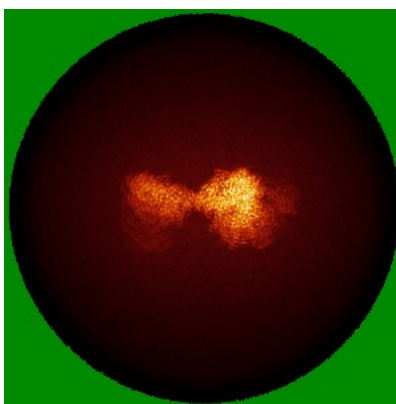

Y

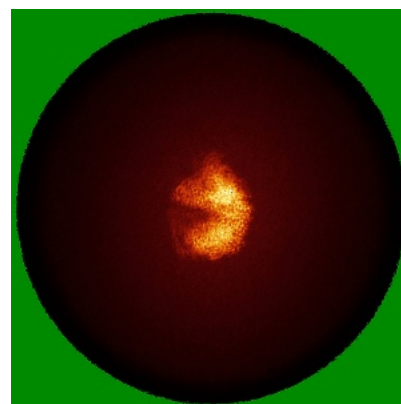

Z

6.4.2 Raw map

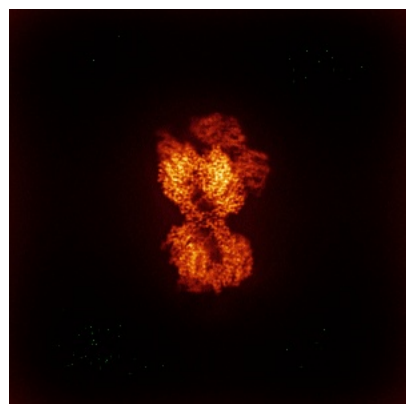

X

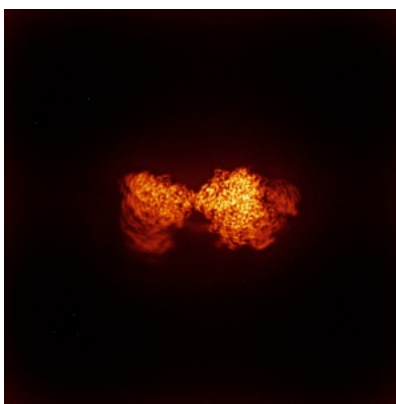

Y

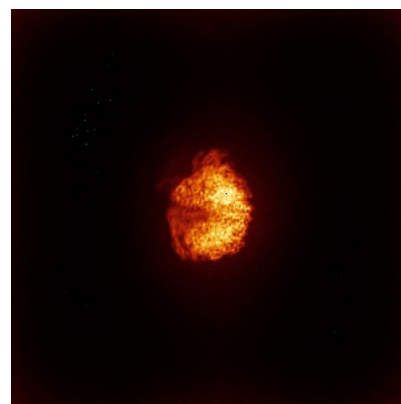

Z

The images above show the map standard deviation projections with false color in three orthogonal directions. Minimum values are shown in green, max in blue, and dark to light orange shades represent small to large values respectively.

6.5 Orthogonal surface views [i](#)

6.5.1 Primary map



X



Y



Z

The images above show the 3D surface view of the map at the recommended contour level 0.5. These images, in conjunction with the slice images, may facilitate assessment of whether an appropriate contour level has been provided.

6.5.2 Raw map



X



Y

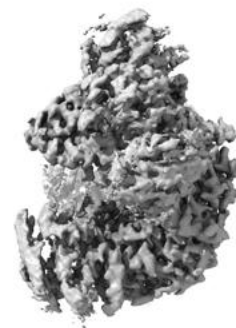

Z

These images show the 3D surface of the raw map. The raw map's contour level was selected so that its surface encloses the same volume as the primary map does at its recommended contour level.

6.6 Mask visualisation [i](#)

This section shows the 3D surface view of the primary map at 50% transparency overlaid with the specified mask at 0% transparency

A mask typically either:

- Encompasses the whole structure
- Separates out a domain, a functional unit, a monomer or an area of interest from a larger structure

6.6.1 emd_19390_msk_1.map [i](#)

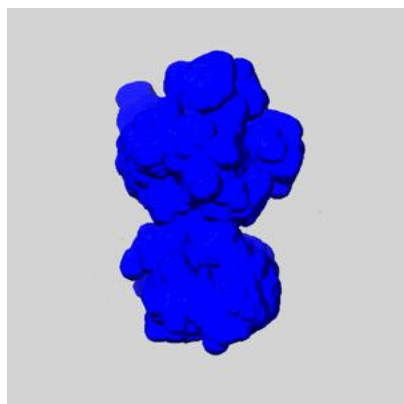

X

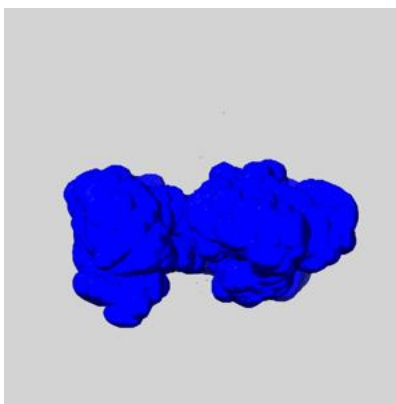

Y

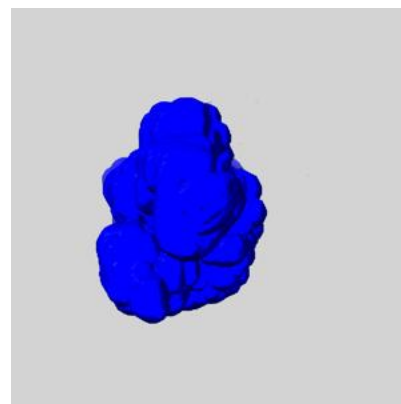

Z

7 Map analysis [i](#)

This section contains the results of statistical analysis of the map.

7.1 Map-value distribution [i](#)

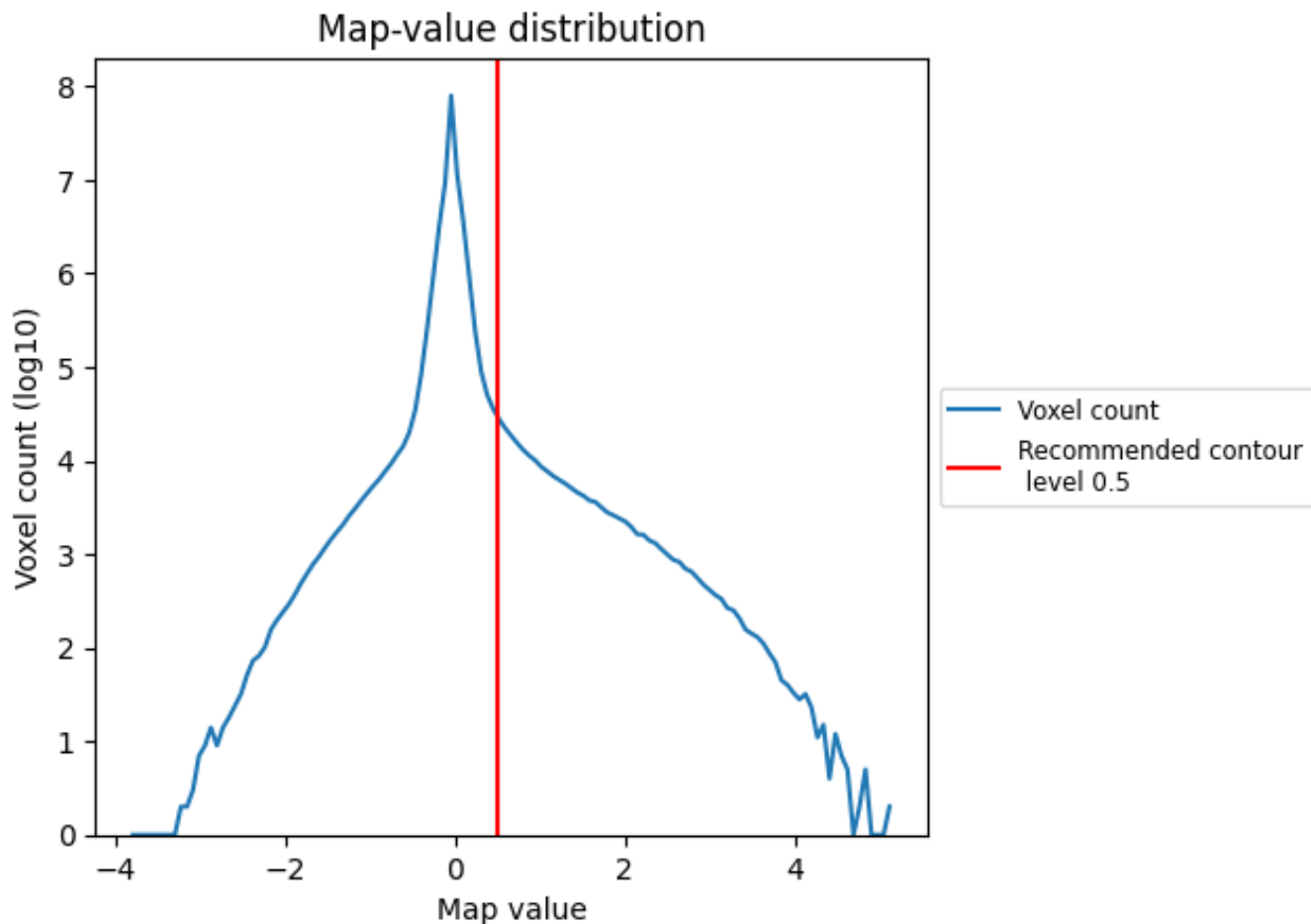

The map-value distribution is plotted in 128 intervals along the x-axis. The y-axis is logarithmic. A spike in this graph at zero usually indicates that the volume has been masked.

7.2 Volume estimate [\(i\)](#)

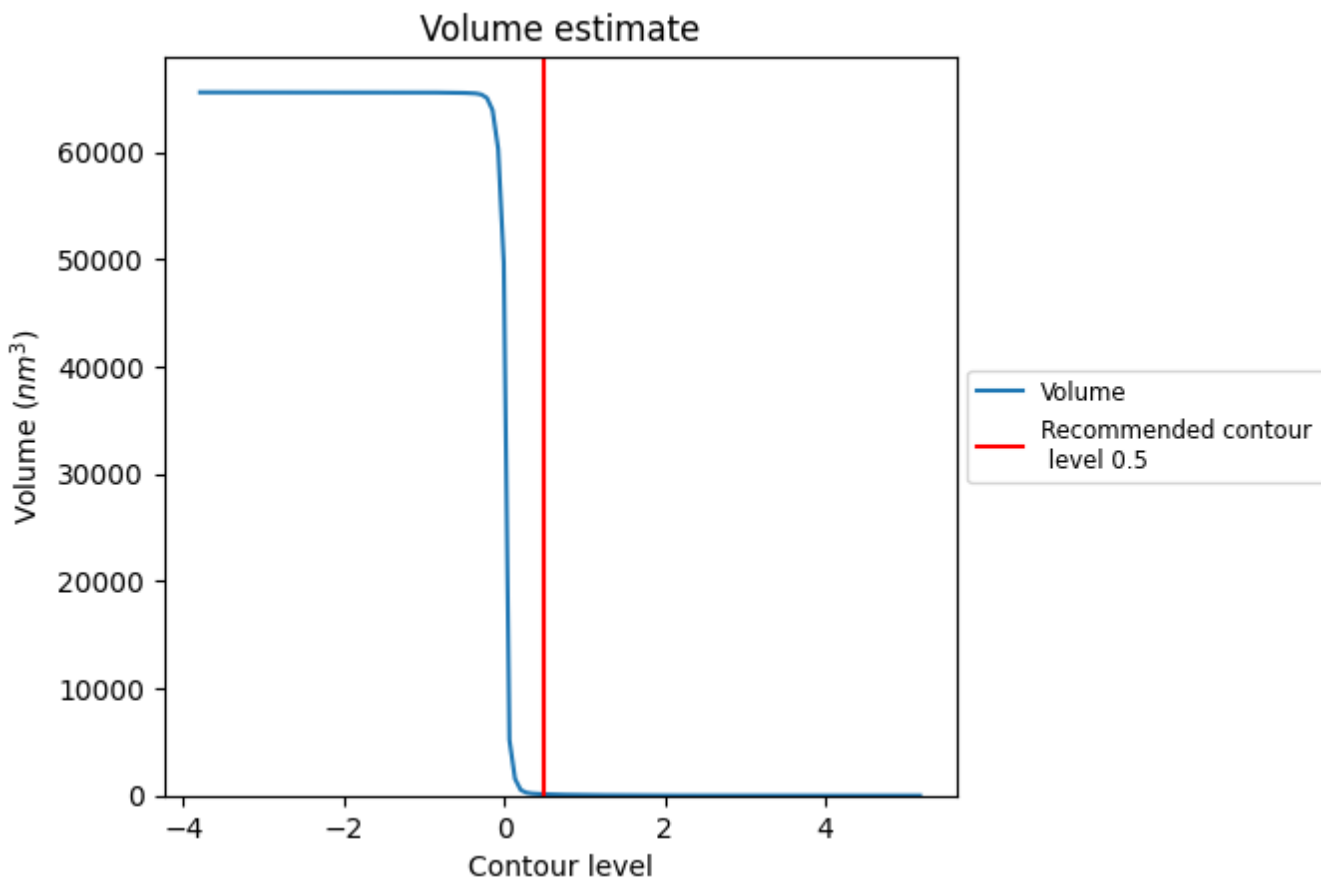

The volume at the recommended contour level is 127 nm³; this corresponds to an approximate mass of 115 kDa.

The volume estimate graph shows how the enclosed volume varies with the contour level. The recommended contour level is shown as a vertical line and the intersection between the line and the curve gives the volume of the enclosed surface at the given level.

7.3 Rotationally averaged power spectrum [i](#)

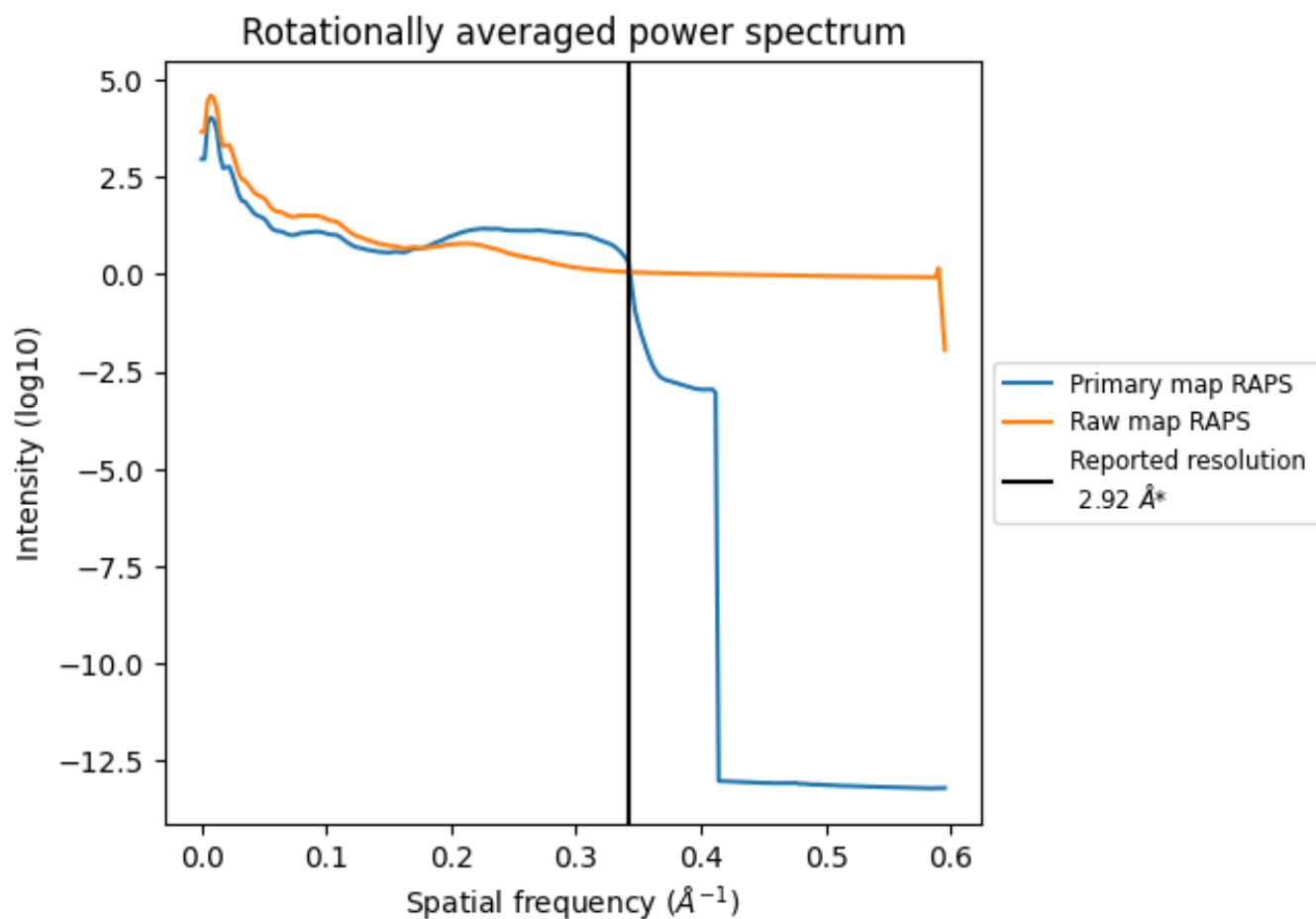

*Reported resolution corresponds to spatial frequency of 0.342 Å⁻¹

8 Fourier-Shell correlation [i](#)

Fourier-Shell Correlation (FSC) is the most commonly used method to estimate the resolution of single-particle and subtomogram-averaged maps. The shape of the curve depends on the imposed symmetry, mask and whether or not the two 3D reconstructions used were processed from a common reference. The reported resolution is shown as a black line. A curve is displayed for the half-bit criterion in addition to lines showing the 0.143 gold standard cut-off and 0.5 cut-off.

8.1 FSC [i](#)

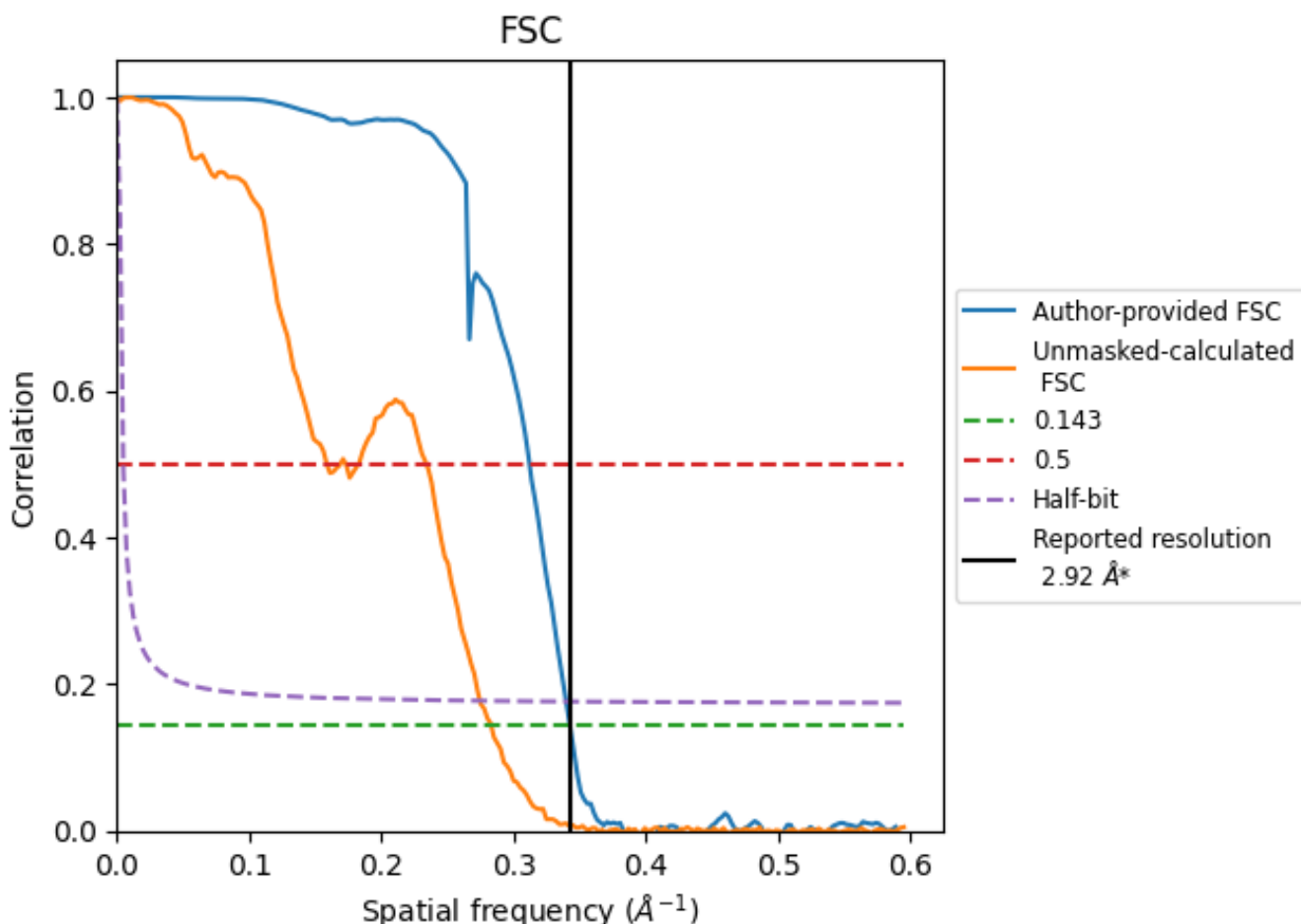

*Reported resolution corresponds to spatial frequency of 0.342 Å⁻¹

8.2 Resolution estimates [i](#)

Resolution estimate (Å)	Estimation criterion (FSC cut-off)		
	0.143	0.5	Half-bit
Reported by author	2.92	-	-
Author-provided FSC curve	2.92	3.20	2.94
Unmasked-calculated*	3.53	6.30	3.64

*Resolution estimate based on FSC curve calculated by comparison of deposited half-maps. The value from deposited half-maps intersecting FSC 0.143 CUT-OFF 3.53 differs from the reported value 2.92 by more than 10 %

9 Map-model fit [i](#)

This section contains information regarding the fit between EMDB map EMD-19390 and PDB model 8RN8. Per-residue inclusion information can be found in section 3 on page 6.

9.1 Map-model overlay [i](#)

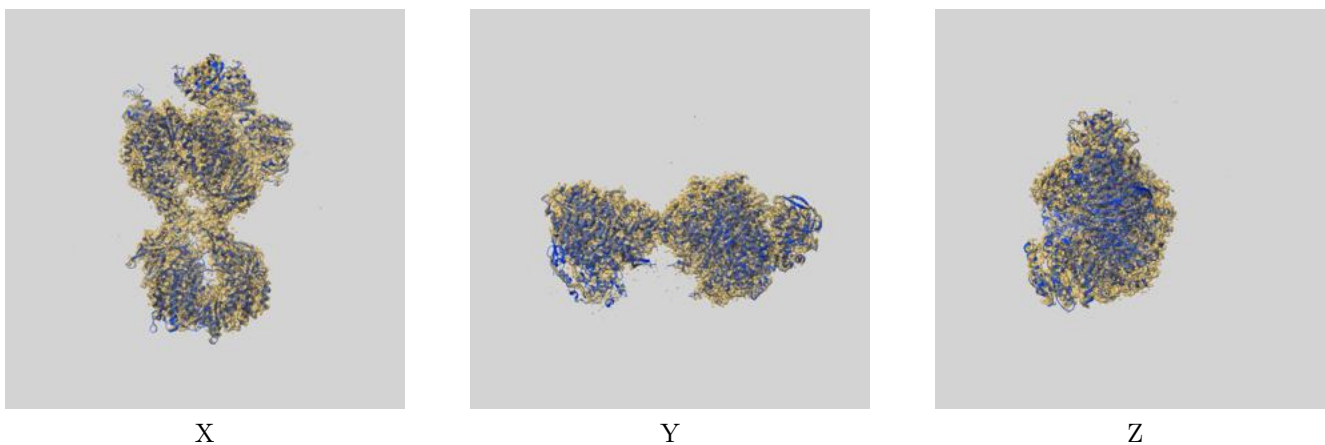

The images above show the 3D surface view of the map at the recommended contour level 0.5 at 50% transparency in yellow overlaid with a ribbon representation of the model coloured in blue. These images allow for the visual assessment of the quality of fit between the atomic model and the map.

9.2 Q-score mapped to coordinate model [i](#)

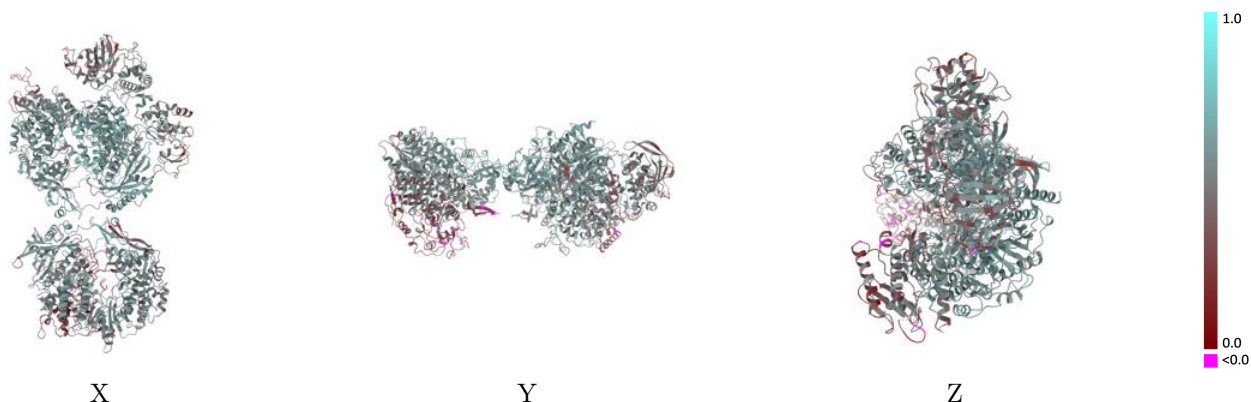

The images above show the model with each residue coloured according to its Q-score. This shows their resolvability in the map with higher Q-score values reflecting better resolvability. Please note: Q-score is calculating the resolvability of atoms, and thus high values are only expected at resolutions at which atoms can be resolved. Low Q-score values may therefore be expected for many entries.

9.3 Atom inclusion mapped to coordinate model [i](#)

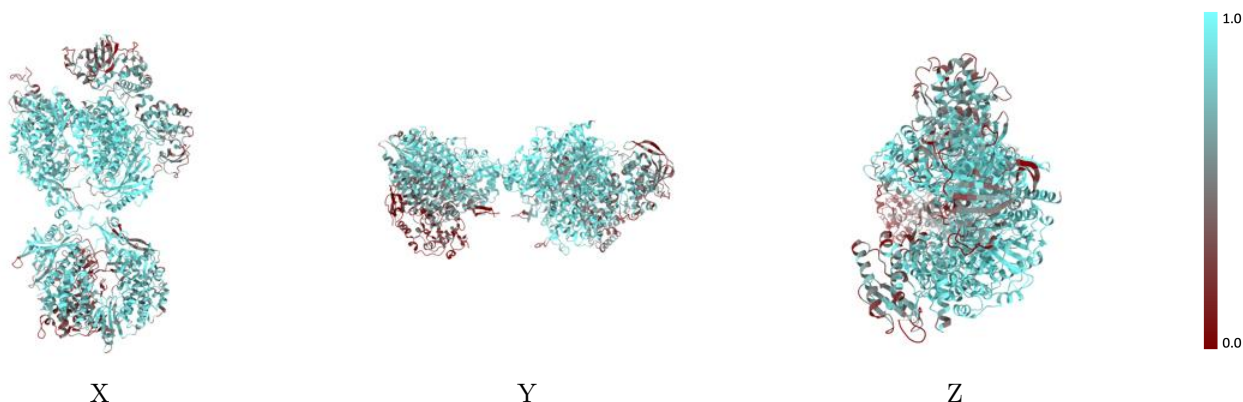

The images above show the model with each residue coloured according to its atom inclusion. This shows to what extent they are inside the map at the recommended contour level (0.5).



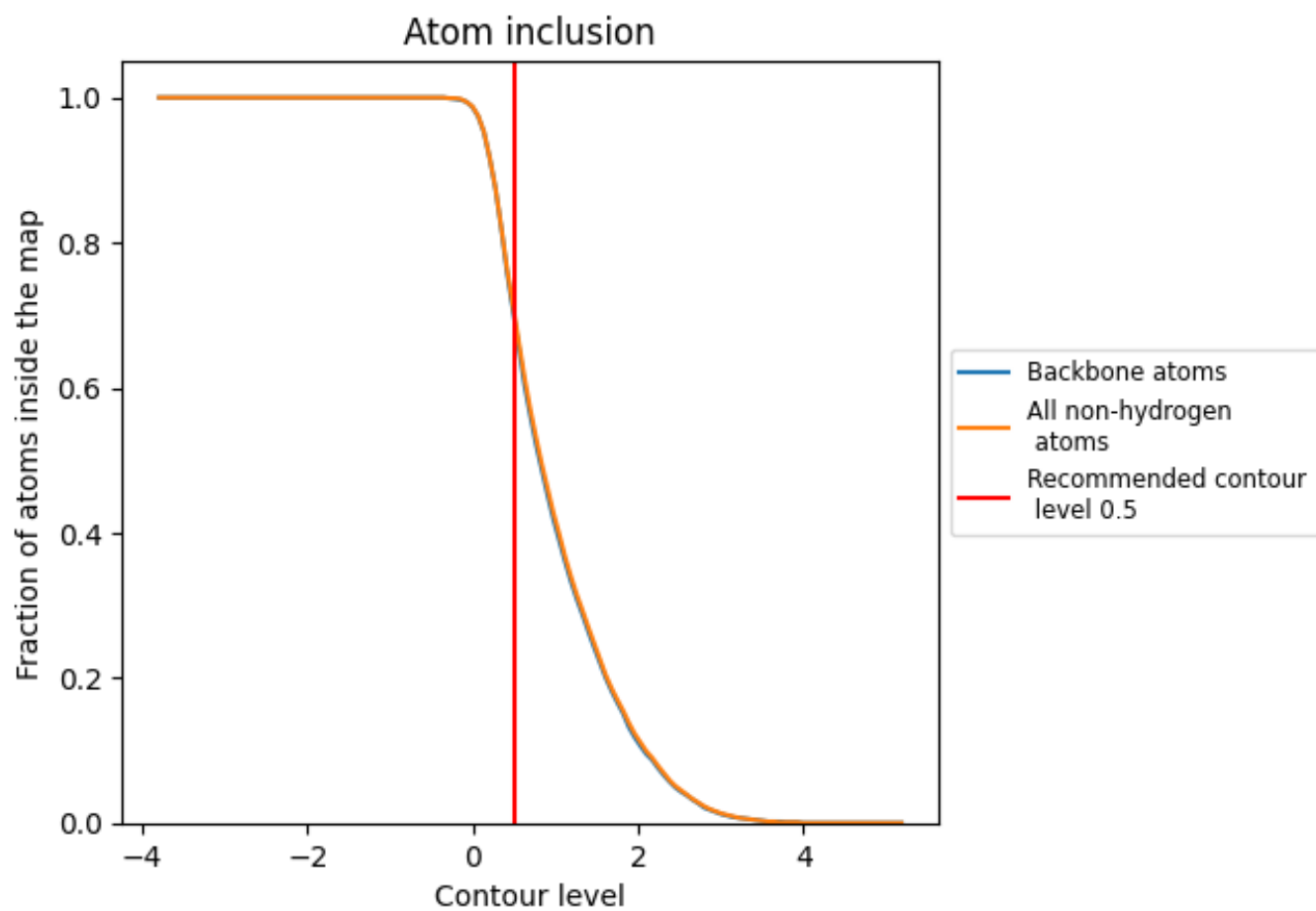











9.4 Atom inclusion [i](#)



At the recommended contour level, 70% of all backbone atoms, 70% of all non-hydrogen atoms, are inside the map.

9.5 Map-model fit summary

The table lists the average atom inclusion at the recommended contour level (0.5) and Q-score for the entire model and for each chain.

Chain	Atom inclusion	Q-score
All	 0.7040	 0.5030
A	 0.8170	 0.5430
B	 0.8970	 0.5790
C	 0.5860	 0.4690
D	 0.7370	 0.5160
E	 0.6280	 0.4610
F	 0.1080	 0.2560

