



Full wwPDB EM Validation Report ⓘ

Oct 5, 2024 – 10:46 pm BST

PDB ID : 8RQE
EMDB ID : EMD-19439
Title : Composite map of bacteriophage JBD30 capsid - neck complex
Authors : Valentova, L.; Fuzik, T.; Plevka, P.
Deposited on : 2024-01-18
Resolution : 8.00 Å (reported)

This is a Full wwPDB EM Validation Report for a publicly released PDB entry.

We welcome your comments at validation@mail.wwpdb.org

A user guide is available at

<https://www.wwpdb.org/validation/2017/EMValidationReportHelp>

with specific help available everywhere you see the ⓘ symbol.

The types of validation reports are described at

<http://www.wwpdb.org/validation/2017/FAQs#types>.

The following versions of software and data (see [references ⓘ](#)) were used in the production of this report:

EMDB validation analysis : 0.0.1.dev113
MolProbity : 4.02b-467
Percentile statistics : 20231227.v01 (using entries in the PDB archive December 27th 2023)
MapQ : 1.9.13
Ideal geometry (proteins) : Engh & Huber (2001)
Ideal geometry (DNA, RNA) : Parkinson et al. (1996)
Validation Pipeline (wwPDB-VP) : 2.39

1 Overall quality at a glance i

The following experimental techniques were used to determine the structure:

ELECTRON MICROSCOPY

The reported resolution of this entry is 8.00 Å.

Percentile scores (ranging between 0-100) for global validation metrics of the entry are shown in the following graphic. The table shows the number of entries on which the scores are based.

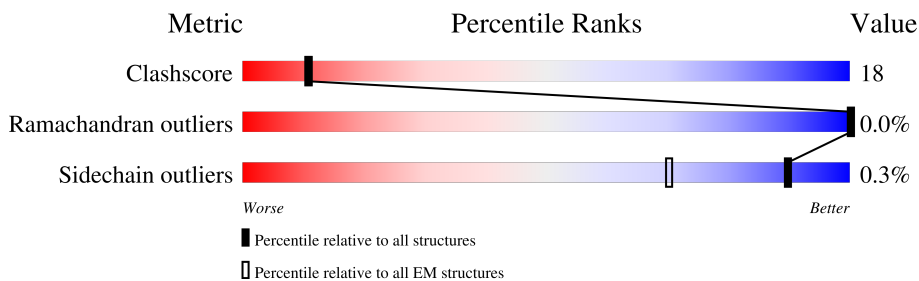

Metric	Whole archive (#Entries)	EM structures (#Entries)
Clashscore	210492	15764
Ramachandran outliers	207382	16835
Sidechain outliers	206894	16415

The table below summarises the geometric issues observed across the polymeric chains and their fit to the map. The red, orange, yellow and green segments of the bar indicate the fraction of residues that contain outliers for ≥ 3 , 2, 1 and 0 types of geometric quality criteria respectively. A grey segment represents the fraction of residues that are not modelled. The numeric value for each fraction is indicated below the corresponding segment, with a dot representing fractions $\leq 5\%$. The upper red bar (where present) indicates the fraction of residues that have poor fit to the EM map (all-atom inclusion $< 40\%$). The numeric value is given above the bar.

Mol	Chain	Length	Quality of chain
1	aA	113	<div style="display: flex; justify-content: space-between; align-items: center;"> <div style="text-align: center;">43%</div> <div style="width: 100%; height: 15px; background: linear-gradient(to right, red, orange, yellow, green, grey);"></div> <div style="text-align: center;">50%</div> </div> <div style="display: flex; justify-content: space-between; align-items: center; margin-top: 5px;"> <div style="text-align: center;">49%</div> <div style="width: 100%; height: 15px; background: linear-gradient(to right, red, orange, yellow, green, grey);"></div> <div style="text-align: center;">50%</div> </div>
1	aB	113	<div style="display: flex; justify-content: space-between; align-items: center;"> <div style="text-align: center;">37%</div> <div style="width: 100%; height: 15px; background: linear-gradient(to right, red, orange, yellow, green, grey);"></div> <div style="text-align: center;">50%</div> </div> <div style="display: flex; justify-content: space-between; align-items: center; margin-top: 5px;"> <div style="text-align: center;">50%</div> <div style="width: 100%; height: 15px; background: linear-gradient(to right, red, orange, yellow, green, grey);"></div> <div style="text-align: center;">50%</div> </div>
1	aC	113	<div style="display: flex; justify-content: space-between; align-items: center;"> <div style="text-align: center;">39%</div> <div style="width: 100%; height: 15px; background: linear-gradient(to right, red, orange, yellow, green, grey);"></div> <div style="text-align: center;">50%</div> </div> <div style="display: flex; justify-content: space-between; align-items: center; margin-top: 5px;"> <div style="text-align: center;">50%</div> <div style="width: 100%; height: 15px; background: linear-gradient(to right, red, orange, yellow, green, grey);"></div> <div style="text-align: center;">50%</div> </div>
1	aD	113	<div style="display: flex; justify-content: space-between; align-items: center;"> <div style="text-align: center;">38%</div> <div style="width: 100%; height: 15px; background: linear-gradient(to right, red, orange, yellow, green, grey);"></div> <div style="text-align: center;">50%</div> </div> <div style="display: flex; justify-content: space-between; align-items: center; margin-top: 5px;"> <div style="text-align: center;">50%</div> <div style="width: 100%; height: 15px; background: linear-gradient(to right, red, orange, yellow, green, grey);"></div> <div style="text-align: center;">50%</div> </div>
1	aE	113	<div style="display: flex; justify-content: space-between; align-items: center;"> <div style="text-align: center;">36%</div> <div style="width: 100%; height: 15px; background: linear-gradient(to right, red, orange, yellow, green, grey);"></div> <div style="text-align: center;">50%</div> </div> <div style="display: flex; justify-content: space-between; align-items: center; margin-top: 5px;"> <div style="text-align: center;">50%</div> <div style="width: 100%; height: 15px; background: linear-gradient(to right, red, orange, yellow, green, grey);"></div> <div style="text-align: center;">50%</div> </div>
1	aF	113	<div style="display: flex; justify-content: space-between; align-items: center;"> <div style="text-align: center;">41%</div> <div style="width: 100%; height: 15px; background: linear-gradient(to right, red, orange, yellow, green, grey);"></div> <div style="text-align: center;">50%</div> </div> <div style="display: flex; justify-content: space-between; align-items: center; margin-top: 5px;"> <div style="text-align: center;">50%</div> <div style="width: 100%; height: 15px; background: linear-gradient(to right, red, orange, yellow, green, grey);"></div> <div style="text-align: center;">50%</div> </div>
1	aG	113	<div style="display: flex; justify-content: space-between; align-items: center;"> <div style="text-align: center;">38%</div> <div style="width: 100%; height: 15px; background: linear-gradient(to right, red, orange, yellow, green, grey);"></div> <div style="text-align: center;">50%</div> </div> <div style="display: flex; justify-content: space-between; align-items: center; margin-top: 5px;"> <div style="text-align: center;">49%</div> <div style="width: 100%; height: 15px; background: linear-gradient(to right, red, orange, yellow, green, grey);"></div> <div style="text-align: center;">50%</div> </div>
1	aO	113	<div style="display: flex; justify-content: space-between; align-items: center;"> <div style="text-align: center;">41%</div> <div style="width: 100%; height: 15px; background: linear-gradient(to right, red, orange, yellow, green, grey);"></div> <div style="text-align: center;">50%</div> </div> <div style="display: flex; justify-content: space-between; align-items: center; margin-top: 5px;"> <div style="text-align: center;">49%</div> <div style="width: 100%; height: 15px; background: linear-gradient(to right, red, orange, yellow, green, grey);"></div> <div style="text-align: center;">50%</div> </div>

Continued on next page...

Continued from previous page...

Mol	Chain	Length	Quality of chain
1	aP	113	40% 50% 50%
1	aQ	113	41% 50% 50%
1	aR	113	42% 50% 50%
1	aS	113	35% 50% 50%
1	aT	113	43% 50% 50%
1	aU	113	35% 49% 50%
1	aa	113	36% 50% 50%
1	ab	113	41% 50% 50%
1	ac	113	36% 50% 50%
1	ad	113	27% 50% 50%
1	ae	113	39% 50% 50%
1	af	113	28% 49% 50%
1	an	113	30% 49% 50%
1	ao	113	36% 50% 50%
1	ap	113	43% 50% 50%
1	aq	113	39% 50% 50%
1	ar	113	44% 50% 50%
1	as	113	43% 50% 50%
1	at	113	42% 49% 50%
1	bE	113	38% 49% 50%
1	bF	113	38% 50% 50%
1	bG	113	45% 50% 50%
1	bH	113	36% 50% 50%
1	bI	113	39% 50% 50%
1	bJ	113	44% 50% 50%

Continued on next page...

Continued from previous page...

Mol	Chain	Length	Quality of chain
1	bK	113	42% 49% 50%
1	bR	113	37% 49% 50%
1	bS	113	40% 50% 50%
1	bT	113	44% 50% 50%
1	bU	113	38% 50% 50%
1	bV	113	35% 50% 50%
1	bW	113	41% 50% 50%
1	bX	113	37% 49% 50%
1	bc	113	38% 49% 50%
1	bd	113	37% 50% 50%
1	be	113	40% 50% 50%
1	bf	113	40% 50% 50%
1	bg	113	38% 50% 50%
1	bh	113	41% 50% 50%
1	bi	113	39% 49% 50%
1	bq	113	40% 49% 50%
1	br	113	41% 50% 50%
1	bs	113	42% 50% 50%
1	bt	113	43% 50% 50%
1	bu	113	40% 50% 50%
1	bv	113	42% 50% 50%
1	bw	113	35% 49% 50%
1	cH	113	35% 49% 50%
1	cI	113	37% 50% 50%
1	cJ	113	42% 50% 50%

Continued on next page...

Continued from previous page...

Mol	Chain	Length	Quality of chain
1	cK	113	34% 50% 50%
1	cL	113	37% 50% 50%
1	cM	113	43% 50% 50%
1	cN	113	37% 49% 50%
1	cV	113	41% 49% 50%
1	cW	113	43% 50% 50%
1	cX	113	41% 50% 50%
1	cY	113	38% 50% 50%
1	cZ	113	42% 50% 50%
1	cf	113	37% 49% 50%
1	cg	113	37% 50% 50%
1	ch	113	42% 50% 50%
1	ci	113	36% 50% 50%
1	cj	113	36% 50% 50%
1	ck	113	41% 50% 50%
1	cl	113	34% 49% 50%
1	ct	113	35% 49% 50%
1	cu	113	37% 50% 50%
1	cv	113	42% 50% 50%
1	cw	113	36% 50% 50%
1	cx	113	34% 50% 50%
1	cy	113	35% 50% 50%
1	cz	113	35% 49% 50%
1	dA	113	42% 50% 50%
1	dB	113	36% 50% 50%

Continued on next page...

Continued from previous page...

Mol	Chain	Length	Quality of chain
1	dC	113	42% 50% 50%
1	dD	113	37% 49% 50%
1	dL	113	36% 49% 50%
1	dM	113	35% 50% 50%
1	dN	113	41% 50% 50%
1	dO	113	35% 50% 50%
1	dP	113	30% 50% 50%
1	dQ	113	37% 50% 50%
1	dR	113	26% 49% 50%
1	dZ	113	29% 49% 50%
1	da	113	45% 50% 50%
1	db	113	37% 49% 50%
1	dj	113	39% 49% 50%
1	dk	113	41% 50% 50%
1	dl	113	40% 50% 50%
1	dm	113	38% 50% 50%
1	dn	113	35% 50% 50%
1	do	113	36% 50% 50%
1	dp	113	35% 49% 50%
1	dx	113	35% 49% 50%
1	dy	113	40% 50% 50%
1	dz	113	43% 50% 50%
1	eB	113	37% 49% 50%
1	eC	113	42% 50% 50%
1	eD	113	44% 50% 50%

Continued on next page...

Continued from previous page...

Mol	Chain	Length	Quality of chain
1	eE	113	37% 50% 50%
1	eF	113	34% 50% 50%
1	eG	113	40% 50% 50%
1	eH	113	38% 49% 50%
1	eP	113	41% 49% 50%
1	eQ	113	37% 50% 50%
1	eR	113	40% 50% 50%
1	eS	113	41% 50% 50%
1	eT	113	40% 50% 50%
1	eU	113	40% 50% 50%
1	eV	113	33% 49% 50%
1	ea	113	34% 50% 50%
1	eb	113	44% 50% 50%
1	ec	113	38% 50% 50%
1	ed	113	33% 50% 50%
1	ee	113	38% 50% 50%
1	ef	113	37% 49% 50%
1	en	113	38% 49% 50%
1	eo	113	38% 50% 50%
1	ep	113	42% 50% 50%
1	eq	113	35% 50% 50%
1	er	113	35% 50% 50%
1	es	113	39% 50% 50%
1	et	113	36% 49% 50%
1	ff	113	34% 49% 50%

Continued on next page...

Continued from previous page...

Mol	Chain	Length	Quality of chain
1	fG	113	42% 50% 50%
1	fH	113	45% 50% 50%
1	fI	113	33% 50% 50%
1	fJ	113	32% 50% 50%
1	fK	113	38% 50% 50%
1	fL	113	33% 49% 50%
1	fT	113	36% 49% 50%
1	fU	113	41% 50% 50%
1	fV	113	43% 50% 50%
1	fW	113	36% 50% 50%
1	fX	113	35% 50% 50%
1	fY	113	42% 50% 50%
1	fZ	113	35% 49% 50%
1	fd	113	33% 49% 50%
1	fe	113	36% 50% 50%
1	ff	113	42% 50% 50%
1	fg	113	40% 50% 50%
1	fh	113	40% 50% 50%
1	fi	113	40% 50% 50%
1	fj	113	35% 49% 50%
1	fr	113	41% 49% 50%
1	fs	113	38% 50% 50%
1	ft	113	42% 50% 50%
1	fu	113	35% 50% 50%
1	fv	113	37% 50% 50%

Continued on next page...

Continued from previous page...

Mol	Chain	Length	Quality of chain
1	fw	113	37% 50% 50%
1	fx	113	38% 49% 50%
1	gA	113	43% 50% 50%
1	gB	113	41% 49% 50%
1	gJ	113	43% 49% 50%
1	gK	113	33% 50% 50%
1	gL	113	40% 50% 50%
1	gM	113	36% 50% 50%
1	gN	113	35% 50% 50%
1	gO	113	41% 50% 50%
1	gP	113	36% 49% 50%
1	gX	113	40% 49% 50%
1	gY	113	41% 50% 50%
1	gZ	113	42% 50% 50%
1	gh	113	38% 49% 50%
1	gi	113	41% 50% 50%
1	gj	113	39% 50% 50%
1	gk	113	39% 50% 50%
1	gl	113	34% 50% 50%
1	gm	113	35% 50% 50%
1	gn	113	40% 49% 50%
1	gv	113	35% 49% 50%
1	gw	113	39% 50% 50%
1	gx	113	41% 50% 50%
1	gy	113	37% 50% 50%

Continued on next page...

Continued from previous page...

Mol	Chain	Length	Quality of chain
1	gz	113	40% 50% 50%
1	hA	113	44% 50% 50%
1	hB	113	39% 50% 50%
1	hC	113	39% 50% 50%
1	hD	113	38% 50% 50%
1	hE	113	42% 49% 50%
1	hL	113	38% 49% 50%
1	hM	113	34% 50% 50%
1	hN	113	38% 50% 50%
1	hO	113	42% 50% 50%
1	hP	113	37% 50% 50%
1	hQ	113	42% 50% 50%
1	hR	113	38% 49% 50%
1	hZ	113	40% 49% 50%
1	ha	113	37% 50% 50%
1	hb	113	28% 50% 50%
1	hc	113	42% 50% 50%
1	hd	113	34% 49% 50%
1	hl	113	35% 49% 50%
1	hm	113	35% 50% 50%
1	hn	113	44% 50% 50%
1	ho	113	41% 50% 50%
1	hp	113	41% 50% 50%
1	hq	113	39% 50% 50%
1	hr	113	42% 49% 50%

Continued on next page...

Continued from previous page...

Mol	Chain	Length	Quality of chain
1	hy	113	40% 49% 50%
1	hz	113	40% 50% 50%
1	iB	113	39% 49% 50%
1	iC	113	42% 50% 50%
1	iD	113	44% 50% 50%
1	iE	113	39% 50% 50%
1	iF	113	42% 50% 50%
1	iG	113	42% 50% 50%
1	iH	113	35% 49% 50%
1	iP	113	37% 49% 50%
1	iQ	113	39% 50% 50%
1	iR	113	42% 50% 50%
1	iS	113	35% 50% 50%
1	iT	113	39% 50% 50%
1	iU	113	36% 50% 50%
1	iV	113	36% 49% 50%
1	ia	113	40% 50% 50%
1	ib	113	46% 50% 50%
1	ic	113	41% 50% 50%
1	id	113	30% 50% 50%
1	ie	113	40% 50% 50%
1	if	113	35% 49% 50%
1	in	113	35% 49% 50%
1	io	113	41% 50% 50%
1	ip	113	40% 50% 50%

Continued on next page...

Continued from previous page...

Mol	Chain	Length	Quality of chain
1	iq	113	36% 50% 50%
1	ir	113	34% 50% 50%
1	is	113	40% 50% 50%
1	it	113	37% 49% 50%
1	jF	113	42% 49% 50%
1	jG	113	39% 50% 50%
1	jH	113	41% 50% 50%
1	jI	113	31% 50% 50%
1	jJ	113	32% 50% 50%
1	jK	113	35% 50% 50%
1	jL	113	35% 49% 50%
1	jT	113	35% 49% 50%
1	jU	113	42% 50% 50%
1	jV	113	44% 50% 50%
1	jW	113	42% 50% 50%
1	jX	113	35% 50% 50%
1	jY	113	42% 50% 50%
1	jZ	113	35% 49% 50%
1	jd	113	35% 49% 50%
1	je	113	37% 50% 50%
1	jf	113	42% 50% 50%
1	jg	113	35% 50% 50%
1	jh	113	37% 50% 50%
1	ji	113	39% 50% 50%
1	jj	113	36% 49% 50%

Continued on next page...

Continued from previous page...

Mol	Chain	Length	Quality of chain	
1	jr	113	37%	50%
1	js	113	38%	50%
1	jt	113	42%	50%
1	ju	113	42%	50%
1	jv	113	41%	50%
1	jw	113	39%	50%
1	jx	113	36%	50%
1	kA	113	38%	50%
1	kI	113	38%	50%
1	kJ	113	38%	50%
1	kK	113	39%	50%
1	kL	113	34%	50%
1	kM	113	37%	50%
1	kN	113	34%	50%
1	kO	113	35%	50%
1	kW	113	34%	50%
1	kX	113	36%	50%
1	kY	113	41%	50%
1	kZ	113	35%	50%
1	kh	113	39%	50%
1	ki	113	35%	50%
1	kj	113	46%	50%
1	kk	113	41%	50%
1	kl	113	42%	50%
1	km	113	37%	50%

Continued on next page...

Continued from previous page...

Mol	Chain	Length	Quality of chain
1	kn	113	44% 49% 50%
1	ku	113	42% 49% 50%
1	113	36% 50% 50%	
1	kw	113	40% 50% 50%
1	kx	113	35% 50% 50%
1	ky	113	34% 50% 50%
1	kz	113	42% 50% 50%
1	lA	113	42% 50% 50%
1	lB	113	35% 50% 50%
1	lC	113	34% 50% 50%
1	lD	113	43% 50% 50%
1	lE	113	39% 49% 50%
1	lM	113	38% 49% 50%
1	lN	113	40% 50% 50%
1	lO	113	42% 50% 50%
1	lP	113	36% 50% 50%
1	lQ	113	38% 50% 50%
1	lR	113	34% 50% 50%
1	lS	113	36% 49% 50%
1	la	113	40% 50% 50%
1	lb	113	42% 50% 50%
1	lc	113	40% 49% 50%
1	lk	113	39% 49% 50%
1	ll	113	39% 50% 50%
1	lm	113	46% 50% 50%

Continued on next page...

Continued from previous page...

Mol	Chain	Length	Quality of chain
1	ln	113	38% 50% 50%
1	lo	113	38% 50% 50%
1	lp	113	45% 50% 50%
1	lq	113	41% 49% 50%
1	ly	113	36% 49% 50%
1	lz	113	39% 50% 50%
1	mC	113	36% 49% 50%
1	mD	113	40% 50% 50%
1	mE	113	39% 50% 50%
1	mF	113	33% 50% 50%
1	mG	113	35% 50% 50%
1	mH	113	38% 50% 50%
1	mI	113	37% 49% 50%
1	mQ	113	35% 49% 50%
1	mR	113	40% 50% 50%
1	mS	113	42% 50% 50%
1	mT	113	37% 50% 50%
1	mU	113	32% 50% 50%
1	mV	113	38% 50% 50%
1	mW	113	34% 49% 50%
1	ma	113	35% 49% 50%
1	mb	113	36% 50% 50%
1	mc	113	38% 50% 50%
1	md	113	35% 50% 50%
1	me	113	38% 50% 50%

Continued on next page...

Continued from previous page...

Mol	Chain	Length	Quality of chain
1	mf	113	41% 50% 50%
1	mg	113	39% 49% 50%
1	mo	113	41% 49% 50%
1	mp	113	39% 50% 50%
1	mq	113	40% 50% 50%
1	mr	113	40% 50% 50%
1	ms	113	41% 50% 50%
1	mt	113	34% 50% 50%
1	mu	113	38% 49% 50%
1	nG	113	36% 49% 50%
1	nH	113	35% 50% 50%
1	nI	113	41% 50% 50%
1	nJ	113	35% 50% 50%
1	nK	113	27% 50% 50%
1	nL	113	36% 50% 50%
1	nM	113	26% 49% 50%
1	nU	113	28% 49% 50%
1	nV	113	35% 50% 50%
1	nW	113	40% 50% 50%
1	nX	113	36% 50% 50%
1	nY	113	30% 50% 50%
1	nZ	113	41% 50% 50%
1	ne	113	34% 49% 50%
1	nf	113	30% 50% 50%
1	ng	113	43% 50% 50%

Continued on next page...

Continued from previous page...

Mol	Chain	Length	Quality of chain
1	nh	113	39% 50% 50%
1	ni	113	31% 50% 50%
1	nj	113	35% 50% 50%
1	nk	113	37% 49% 50%
1	ns	113	42% 49% 50%
1	nt	113	35% 50% 50%
1	nu	113	37% 50% 50%
1	nv	113	41% 50% 50%
1	nw	113	33% 50% 50%
1	nx	113	35% 50% 50%
1	ny	113	36% 49% 50%
1	oA	113	36% 50% 50%
1	oB	113	37% 50% 50%
1	oC	113	35% 49% 50%
1	oK	113	36% 49% 50%
1	oL	113	36% 50% 50%
1	oM	113	41% 50% 50%
1	oN	113	35% 50% 50%
1	oO	113	29% 50% 50%
1	oP	113	41% 50% 50%
1	oQ	113	29% 49% 50%
1	oY	113	30% 49% 50%
1	oZ	113	34% 50% 50%
1	oa	113	27% 49% 50%
1	oi	113	30% 49% 50%

Continued on next page...

Continued from previous page...

Mol	Chain	Length	Quality of chain
1	oj	113	30% 50% 50%
1	ok	113	42% 50% 50%
1	ol	113	45% 50% 50%
1	om	113	35% 50% 50%
1	on	113	36% 50% 50%
1	oo	113	39% 49% 50%
1	ow	113	39% 49% 50%
1	ox	113	36% 50% 50%
1	oy	113	37% 50% 50%
1	oz	113	41% 50% 50%
1	pA	113	36% 49% 50%
1	pB	113	34% 50% 50%
1	pC	113	42% 50% 50%
1	pD	113	41% 50% 50%
1	pE	113	35% 50% 50%
1	pF	113	38% 50% 50%
1	pG	113	36% 49% 50%
1	pO	113	36% 49% 50%
1	pP	113	39% 50% 50%
1	pQ	113	42% 50% 50%
1	pR	113	41% 50% 50%
1	pS	113	41% 50% 50%
1	pT	113	41% 50% 50%
1	pU	113	36% 49% 50%
1	pa	113	42% 50% 50%

Continued on next page...

Continued from previous page...

Mol	Chain	Length	Quality of chain
1	pb	113	38% 50% 50%
1	pc	113	31% 50% 50%
1	pd	113	39% 50% 50%
1	pe	113	38% 49% 50%
1	pm	113	35% 49% 50%
1	pn	113	38% 50% 50%
1	po	113	42% 50% 50%
1	pp	113	42% 50% 50%
1	pq	113	36% 50% 50%
1	pr	113	43% 50% 50%
1	ps	113	34% 49% 50%
1	qc	113	40% 49% 50%
2	aH	304	59% 96% ..
2	aI	304	65% 98% .
2	aJ	304	64% 96% ..
2	aK	304	64% 97% .
2	aL	304	65% 97% .
2	aM	304	63% 96% ..
2	aN	304	62% 97% .
2	aV	304	64% 96% ..
2	aW	304	67% 98% .
2	aX	304	74% 96% ..
2	aY	304	74% 97% .
2	aZ	304	74% 97% .
2	ag	304	51% 96% ..

Continued on next page...

Continued from previous page...

Mol	Chain	Length	Quality of chain
2	ah	304	34% 98%
2	ai	304	71% 96%
2	aj	304	64% 97%
2	ak	304	73% 97%
2	al	304	65% 96%
2	am	304	54% 97%
2	au	304	52% 96%
2	av	304	67% 96%
2	aw	304	74% 97%
2	ax	304	70% 97%
2	ay	304	68% 96%
2	az	304	61% 97%
2	bA	304	71% 97%
2	bB	304	74% 97%
2	bC	304	67% 96%
2	bD	304	67% 97%
2	bL	304	51% 96%
2	bM	304	74% 96%
2	bN	304	72% 97%
2	bO	304	69% 97%
2	bP	304	66% 96%
2	bQ	304	61% 97%
2	bY	304	57% 96%
2	bZ	304	68% 98%
2	ba	304	73% 96%

Continued on next page...

Continued from previous page...

Mol	Chain	Length	Quality of chain
2	bb	304	67% 97%
2	bj	304	64% 96%
2	bk	304	67% 98%
2	bl	304	68% 96%
2	bm	304	69% 97%
2	bn	304	70% 97%
2	bo	304	63% 96%
2	bp	304	66% 97%
2	bx	304	65% 96%
2	by	304	68% 98%
2	bz	304	72% 96%
2	cA	304	62% 96%
2	cB	304	63% 98%
2	cC	304	72% 96%
2	cD	304	67% 97%
2	cE	304	73% 97%
2	cF	304	67% 96%
2	cG	304	65% 97%
2	cO	304	69% 96%
2	cP	304	59% 98%
2	cQ	304	77% 96%
2	cR	304	71% 97%
2	cS	304	76% 97%
2	cT	304	70% 96%
2	cU	304	58% 97%

Continued on next page...

Continued from previous page...

Mol	Chain	Length	Quality of chain
2	ca	304	69% 96%
2	cb	304	66% 97%
2	cc	304	72% 97%
2	cd	304	65% 96%
2	ce	304	61% 97%
2	cm	304	56% 96%
2	cn	304	60% 98%
2	co	304	69% 96%
2	cp	304	73% 97%
2	cq	304	68% 97%
2	cr	304	65% 96%
2	cs	304	67% 97%
2	dE	304	59% 96%
2	dF	304	59% 98%
2	dG	304	69% 96%
2	dH	304	71% 97%
2	dI	304	65% 97%
2	dJ	304	66% 96%
2	dK	304	60% 97%
2	dS	304	49% 96%
2	dT	304	34% 98%
2	dU	304	70% 96%
2	dV	304	63% 97%
2	dW	304	72% 97%
2	dX	304	62% 96%

Continued on next page...

Continued from previous page...

Mol	Chain	Length	Quality of chain
2	dY	304	53% 97%
2	dc	304	61% 96%
2	dd	304	69% 98%
2	de	304	70% 96%
2	df	304	71% 97%
2	dg	304	70% 97%
2	dh	304	69% 96%
2	di	304	64% 97%
2	dq	304	62% 96%
2	dr	304	67% 98%
2	ds	304	71% 96%
2	dt	304	62% 97%
2	du	304	70% 97%
2	dv	304	65% 96%
2	dw	304	60% 97%
2	eA	304	61% 97%
2	eI	304	58% 96%
2	eJ	304	68% 98%
2	eK	304	67% 96%
2	eL	304	64% 97%
2	eM	304	66% 97%
2	eN	304	64% 96%
2	eO	304	63% 97%
2	eW	304	60% 96%
2	eX	304	57% 98%

Continued on next page...

Continued from previous page...

Mol	Chain	Length	Quality of chain
2	eY	304	69% 96%
2	eZ	304	70% 97%
2	eg	304	63% 96%
2	eh	304	63% 98%
2	ei	304	66% 96%
2	ej	304	69% 97%
2	ek	304	69% 97%
2	el	304	70% 96%
2	em	304	63% 97%
2	eu	304	63% 96%
2	ev	304	64% 98%
2	ew	304	70% 96%
2	ex	304	65% 97%
2	ey	304	72% 97%
2	ez	304	69% 96%
2	fA	304	72% 96%
2	fB	304	66% 97%
2	fC	304	75% 97%
2	fD	304	70% 96%
2	fE	304	65% 97%
2	fM	304	62% 96%
2	fN	304	70% 98%
2	fO	304	70% 96%
2	fP	304	72% 97%
2	fQ	304	74% 97%

Continued on next page...

Continued from previous page...

Mol	Chain	Length	Quality of chain	
2	fR	304	66%	96%
2	fS	304	64%	97%
2	fa	304	73%	97%
2	fb	304	67%	96%
2	fc	304	66%	97%
2	fk	304	57%	96%
2	fl	304	65%	98%
2	fm	304	68%	96%
2	fn	304	70%	97%
2	fo	304	71%	97%
2	fp	304	64%	96%
2	fq	304	68%	97%
2	fy	304	70%	96%
2	fz	304	66%	98%
2	gC	304	68%	96%
2	gD	304	62%	98%
2	gE	304	70%	96%
2	gF	304	69%	97%
2	gG	304	68%	97%
2	gH	304	67%	96%
2	gI	304	63%	97%
2	gQ	304	55%	96%
2	gR	304	64%	98%
2	gS	304	66%	96%
2	gT	304	63%	97%

Continued on next page...

Continued from previous page...

Mol	Chain	Length	Quality of chain
2	gU	304	72% 97%
2	gV	304	63% 96%
2	gW	304	59% 97%
2	ga	304	64% 96%
2	gb	304	66% 98%
2	gc	304	69% 96%
2	gd	304	73% 97%
2	ge	304	71% 97%
2	gf	304	71% 96%
2	gg	304	67% 97%
2	go	304	61% 96%
2	gp	304	66% 98%
2	gq	304	71% 96%
2	gr	304	65% 97%
2	gs	304	70% 97%
2	gt	304	66% 96%
2	gu	304	61% 97%
2	hF	304	48% 96%
2	hG	304	75% 96%
2	hH	304	72% 97%
2	hI	304	74% 97%
2	hJ	304	65% 96%
2	hK	304	62% 97%
2	hS	304	62% 96%
2	hT	304	67% 98%

Continued on next page...

Continued from previous page...

Mol	Chain	Length	Quality of chain
2	hU	304	73% 96%
2	hV	304	68% 97%
2	hW	304	69% 97%
2	hX	304	68% 96%
2	hY	304	63% 97%
2	he	304	58% 96%
2	hf	304	64% 98%
2	hg	304	72% 96%
2	hh	304	73% 97%
2	hi	304	76% 97%
2	hj	304	66% 96%
2	hk	304	64% 97%
2	hs	304	49% 96%
2	ht	304	69% 96%
2	hu	304	75% 97%
2	hv	304	69% 97%
2	hw	304	66% 96%
2	hx	304	63% 97%
2	iA	304	59% 97%
2	iI	304	68% 96%
2	iJ	304	69% 98%
2	iK	304	71% 96%
2	iL	304	77% 97%
2	iM	304	79% 97%
2	iN	304	74% 96%

Continued on next page...

Continued from previous page...

Mol	Chain	Length	Quality of chain
2	iO	304	74% 97%
2	iW	304	57% 96%
2	iX	304	66% 98%
2	iY	304	68% 96%
2	iZ	304	62% 97%
2	ig	304	61% 96%
2	ih	304	62% 98%
2	ii	304	72% 96%
2	ij	304	71% 97%
2	ik	304	73% 97%
2	il	304	64% 96%
2	im	304	60% 97%
2	iu	304	63% 96%
2	iv	304	56% 98%
2	iw	304	76% 96%
2	ix	304	67% 97%
2	iy	304	71% 97%
2	iz	304	63% 96%
2	jA	304	70% 96%
2	jB	304	70% 97%
2	jC	304	70% 97%
2	jD	304	65% 96%
2	jE	304	68% 97%
2	jM	304	63% 96%
2	jN	304	60% 98%

Continued on next page...

Continued from previous page...

Mol	Chain	Length	Quality of chain
2	jO	304	70% 96%
2	jP	304	67% 97%
2	jQ	304	74% 97%
2	jR	304	63% 96%
2	jS	304	58% 97%
2	ja	304	71% 97%
2	jb	304	63% 96%
2	jc	304	56% 97%
2	jk	304	61% 96%
2	jl	304	67% 98%
2	jm	304	69% 96%
2	jn	304	65% 97%
2	jo	304	67% 97%
2	jp	304	69% 96%
2	jq	304	66% 97%
2	jy	304	63% 96%
2	jz	304	64% 98%
2	kB	304	60% 96%
2	kC	304	61% 98%
2	kD	304	69% 96%
2	kE	304	68% 97%
2	kF	304	72% 97%
2	kG	304	66% 96%
2	kH	304	61% 97%
2	kP	304	58% 96%

Continued on next page...

Continued from previous page...

Mol	Chain	Length	Quality of chain
2	kQ	304	63% 98%
2	kR	304	69% 96%
2	kS	304	64% 97%
2	kT	304	71% 97%
2	kU	304	63% 96%
2	kV	304	53% 97%
2	ka	304	61% 96%
2	kb	304	65% 98%
2	kc	304	71% 96%
2	kd	304	72% 97%
2	ke	304	72% 97%
2	kf	304	64% 96%
2	kg	304	65% 97%
2	ko	304	52% 96%
2	kp	304	72% 96%
2	kq	304	73% 97%
2	kr	304	72% 97%
2	ks	304	68% 96%
2	kt	304	63% 97%
2	lF	304	62% 96%
2	lG	304	66% 98%
2	lH	304	69% 96%
2	lI	304	72% 97%
2	lJ	304	69% 97%
2	lK	304	70% 96%

Continued on next page...

Continued from previous page...

Mol	Chain	Length	Quality of chain
2	lL	304	68% 97%
2	lT	304	56% 96%
2	lU	304	68% 98%
2	lV	304	70% 96%
2	lW	304	66% 97%
2	lX	304	75% 97%
2	lY	304	64% 96%
2	lZ	304	63% 97%
2	ld	304	69% 96%
2	le	304	69% 98%
2	lf	304	72% 96%
2	lg	304	71% 97%
2	lh	304	72% 97%
2	li	304	66% 96%
2	lj	304	65% 97%
2	lr	304	63% 96%
2	ls	304	63% 98%
2	lt	304	71% 96%
2	lu	304	68% 97%
2	lv	304	71% 97%
2	lw	304	72% 96%
2	lx	304	66% 97%
2	mA	304	72% 96%
2	mB	304	76% 97%
2	mJ	304	65% 96%

Continued on next page...

Continued from previous page...

Mol	Chain	Length	Quality of chain	
2	mK	304	68%	98%
2	mL	304	69%	96%
2	mM	304	69%	97%
2	mN	304	72%	97%
2	mO	304	66%	96%
2	mP	304	61%	97%
2	mX	304	58%	96%
2	mY	304	63%	98%
2	mZ	304	64%	96%
2	mh	304	69%	96%
2	mi	304	66%	98%
2	mj	304	72%	96%
2	mk	304	70%	97%
2	ml	304	68%	97%
2	mm	304	68%	96%
2	mn	304	62%	97%
2	mv	304	67%	96%
2	mw	304	66%	98%
2	mx	304	75%	96%
2	my	304	77%	97%
2	mz	304	76%	97%
2	nA	304	65%	98%
2	nB	304	70%	96%
2	nC	304	73%	97%
2	nD	304	72%	97%

Continued on next page...

Continued from previous page...

Mol	Chain	Length	Quality of chain
2	nE	304	72% 96%
2	nF	304	68% 97%
2	nN	304	50% 96%
2	nO	304	36% 98%
2	nP	304	69% 96%
2	nQ	304	64% 97%
2	nR	304	71% 97%
2	nS	304	62% 96%
2	nT	304	55% 97%
2	na	304	61% 97%
2	nb	304	65% 97%
2	nc	304	57% 96%
2	nd	304	57% 97%
2	nl	304	68% 96%
2	nm	304	64% 98%
2	nn	304	61% 96%
2	no	304	74% 97%
2	np	304	71% 97%
2	nq	304	69% 96%
2	nr	304	66% 97%
2	nz	304	62% 96%
2	oD	304	65% 96%
2	oE	304	69% 98%
2	oF	304	70% 96%
2	oG	304	72% 97%

Continued on next page...

Continued from previous page...

Mol	Chain	Length	Quality of chain
2	oH	304	71% 97%
2	oI	304	72% 96%
2	oJ	304	66% 97%
2	oR	304	49% 96%
2	oS	304	35% 98%
2	oT	304	70% 96%
2	oU	304	65% 97%
2	oV	304	72% 97%
2	oW	304	65% 96%
2	oX	304	52% 97%
2	ob	304	51% 96%
2	oc	304	36% 98%
2	od	304	67% 96%
2	oe	304	66% 97%
2	of	304	73% 97%
2	og	304	64% 96%
2	oh	304	55% 97%
2	op	304	66% 96%
2	oq	304	68% 98%
2	or	304	68% 96%
2	os	304	73% 97%
2	ot	304	71% 97%
2	ou	304	71% 96%
2	ov	304	67% 97%
2	pH	304	62% 96%

Continued on next page...

Continued from previous page...

Mol	Chain	Length	Quality of chain
2	pI	304	63% 98%
2	pJ	304	69% 96%
2	pK	304	74% 97%
2	pL	304	69% 97%
2	pM	304	72% 96%
2	pN	304	63% 97%
2	pV	304	62% 96%
2	pW	304	70% 98%
2	pX	304	67% 96%
2	pY	304	71% 97%
2	pZ	304	70% 97%
2	pf	304	56% 96%
2	pg	304	62% 98%
2	ph	304	60% 96%
2	pi	304	67% 97%
2	pj	304	67% 97%
2	pk	304	63% 96%
2	pl	304	59% 97%
2	pt	304	61% 96%
2	pu	304	67% 98%
2	pV	304	77% 96%
2	pW	304	79% 97%
2	pX	304	76% 97%
2	pY	304	72% 96%
2	pZ	304	72% 97%

Continued on next page...

Continued from previous page...

Mol	Chain	Length	Quality of chain	
2	qa	304	72%	96%
2	qb	304	65%	97%
3	qd	157	30%	87%
3	qe	157	34%	87%
3	qf	157	24%	87%
3	qg	157	29%	87%
3	qh	157	30%	87%
3	qi	157	32%	87%
4	qj	256	17%	98%
4	qk	256	12%	98%
4	ql	256	17%	98%
4	qm	256	19%	98%
4	qn	256	18%	98%
4	qo	256	15%	98%
5	qB	526	26%	77%
5	qD	526	29%	77%
5	qF	526	32%	77%
5	qH	526	30%	77%
5	qJ	526	28%	77%
5	qL	526	25%	77%
5	qp	526	30%	77%
5	qr	526	32%	77%
5	qt	526	32%	77%
5	qv	526	33%	77%
5	qx	526	29%	77%

Continued on next page...

Continued from previous page...

Mol	Chain	Length	Quality of chain
5	qz	526	 28% 77% 23%
6	qA	138	 98%
6	qC	138	 98%
6	qE	138	 98%
6	qG	138	 98%
6	qI	138	 7% 98%
6	qK	138	 7% 98%
6	qM	138	 98%
6	qq	138	 98%
6	qs	138	 98%
6	qu	138	 5% 98%
6	qw	138	 98%
6	qy	138	 7% 98%

2 Entry composition [i](#)

There are 6 unique types of molecules in this entry. The entry contains 1224397 atoms, of which 17454 are hydrogens and 0 are deuteriums.

In the tables below, the AltConf column contains the number of residues with at least one atom in alternate conformation and the Trace column contains the number of residues modelled with at most 2 atoms.

- Molecule 1 is a protein called Mu-like prophage FluMu N-terminal domain-containing protein.

Mol	Chain	Residues	Atoms					AltConf	Trace
			Total	C	N	O	S		
1	aa	56	433	268	75	87	3	0	0
1	ab	56	433	268	75	87	3	0	0
1	ac	56	433	268	75	87	3	0	0
1	ad	56	433	268	75	87	3	0	0
1	ae	56	433	268	75	87	3	0	0
1	af	56	433	268	75	87	3	0	0
1	an	56	433	268	75	87	3	0	0
1	ao	56	433	268	75	87	3	0	0
1	ap	56	433	268	75	87	3	0	0
1	aq	56	433	268	75	87	3	0	0
1	ar	56	433	268	75	87	3	0	0
1	as	56	433	268	75	87	3	0	0
1	at	56	433	268	75	87	3	0	0
1	aA	56	433	268	75	87	3	0	0
1	aB	56	433	268	75	87	3	0	0
1	aC	56	433	268	75	87	3	0	0
1	aD	56	433	268	75	87	3	0	0

Continued on next page...

Continued from previous page...

Mol	Chain	Residues	Atoms					AltConf	Trace
			Total	C	N	O	S		
1	aE	56	433	268	75	87	3	0	0
1	aF	56	433	268	75	87	3	0	0
1	aG	56	433	268	75	87	3	0	0
1	aO	56	433	268	75	87	3	0	0
1	aP	56	433	268	75	87	3	0	0
1	aQ	56	433	268	75	87	3	0	0
1	aR	56	433	268	75	87	3	0	0
1	aS	56	433	268	75	87	3	0	0
1	aT	56	433	268	75	87	3	0	0
1	aU	56	433	268	75	87	3	0	0
1	bc	56	433	268	75	87	3	0	0
1	bd	56	433	268	75	87	3	0	0
1	be	56	433	268	75	87	3	0	0
1	bf	56	433	268	75	87	3	0	0
1	bg	56	433	268	75	87	3	0	0
1	bh	56	433	268	75	87	3	0	0
1	bi	56	433	268	75	87	3	0	0
1	bq	56	433	268	75	87	3	0	0
1	br	56	433	268	75	87	3	0	0
1	bs	56	433	268	75	87	3	0	0
1	bt	56	433	268	75	87	3	0	0

Continued on next page...

Continued from previous page...

Mol	Chain	Residues	Atoms					AltConf	Trace
			Total	C	N	O	S		
1	bu	56	433	268	75	87	3	0	0
1	bv	56	433	268	75	87	3	0	0
1	bw	56	433	268	75	87	3	0	0
1	bE	56	433	268	75	87	3	0	0
1	bF	56	433	268	75	87	3	0	0
1	bG	56	433	268	75	87	3	0	0
1	bH	56	433	268	75	87	3	0	0
1	bI	56	433	268	75	87	3	0	0
1	bJ	56	433	268	75	87	3	0	0
1	bK	56	433	268	75	87	3	0	0
1	bR	56	433	268	75	87	3	0	0
1	bS	56	433	268	75	87	3	0	0
1	bT	56	433	268	75	87	3	0	0
1	bU	56	433	268	75	87	3	0	0
1	bV	56	433	268	75	87	3	0	0
1	bW	56	433	268	75	87	3	0	0
1	bX	56	433	268	75	87	3	0	0
1	cf	56	433	268	75	87	3	0	0
1	cg	56	433	268	75	87	3	0	0
1	ch	56	433	268	75	87	3	0	0
1	ci	56	433	268	75	87	3	0	0

Continued on next page...

Continued from previous page...

Mol	Chain	Residues	Atoms					AltConf	Trace
			Total	C	N	O	S		
1	cj	56	433	268	75	87	3	0	0
1	ck	56	433	268	75	87	3	0	0
1	cl	56	433	268	75	87	3	0	0
1	ct	56	433	268	75	87	3	0	0
1	cu	56	433	268	75	87	3	0	0
1	cv	56	433	268	75	87	3	0	0
1	cw	56	433	268	75	87	3	0	0
1	cx	56	433	268	75	87	3	0	0
1	cy	56	433	268	75	87	3	0	0
1	cz	56	433	268	75	87	3	0	0
1	cH	56	433	268	75	87	3	0	0
1	cI	56	433	268	75	87	3	0	0
1	cJ	56	433	268	75	87	3	0	0
1	cK	56	433	268	75	87	3	0	0
1	cL	56	433	268	75	87	3	0	0
1	cM	56	433	268	75	87	3	0	0
1	cN	56	433	268	75	87	3	0	0
1	cV	56	433	268	75	87	3	0	0
1	cW	56	433	268	75	87	3	0	0
1	cX	56	433	268	75	87	3	0	0
1	cY	56	433	268	75	87	3	0	0

Continued on next page...

Continued from previous page...

Mol	Chain	Residues	Atoms					AltConf	Trace
			Total	C	N	O	S		
1	cZ	56	433	268	75	87	3	0	0
1	da	56	433	268	75	87	3	0	0
1	db	56	433	268	75	87	3	0	0
1	dj	56	433	268	75	87	3	0	0
1	dk	56	433	268	75	87	3	0	0
1	dl	56	433	268	75	87	3	0	0
1	dm	56	433	268	75	87	3	0	0
1	dn	56	433	268	75	87	3	0	0
1	do	56	433	268	75	87	3	0	0
1	dp	56	433	268	75	87	3	0	0
1	dx	56	433	268	75	87	3	0	0
1	dy	56	433	268	75	87	3	0	0
1	dz	56	433	268	75	87	3	0	0
1	dA	56	433	268	75	87	3	0	0
1	dB	56	433	268	75	87	3	0	0
1	dC	56	433	268	75	87	3	0	0
1	dD	56	433	268	75	87	3	0	0
1	dL	56	433	268	75	87	3	0	0
1	dM	56	433	268	75	87	3	0	0
1	dN	56	433	268	75	87	3	0	0
1	dO	56	433	268	75	87	3	0	0

Continued on next page...

Continued from previous page...

Mol	Chain	Residues	Atoms					AltConf	Trace
			Total	C	N	O	S		
1	dP	56	433	268	75	87	3	0	0
1	dQ	56	433	268	75	87	3	0	0
1	dR	56	433	268	75	87	3	0	0
1	dZ	56	433	268	75	87	3	0	0
1	ea	56	433	268	75	87	3	0	0
1	eb	56	433	268	75	87	3	0	0
1	ec	56	433	268	75	87	3	0	0
1	ed	56	433	268	75	87	3	0	0
1	ee	56	433	268	75	87	3	0	0
1	ef	56	433	268	75	87	3	0	0
1	en	56	433	268	75	87	3	0	0
1	eo	56	433	268	75	87	3	0	0
1	ep	56	433	268	75	87	3	0	0
1	eq	56	433	268	75	87	3	0	0
1	er	56	433	268	75	87	3	0	0
1	es	56	433	268	75	87	3	0	0
1	et	56	433	268	75	87	3	0	0
1	eB	56	433	268	75	87	3	0	0
1	eC	56	433	268	75	87	3	0	0
1	eD	56	433	268	75	87	3	0	0
1	eE	56	433	268	75	87	3	0	0

Continued on next page...

Continued from previous page...

Mol	Chain	Residues	Atoms					AltConf	Trace
			Total	C	N	O	S		
1	eF	56	433	268	75	87	3	0	0
1	eG	56	433	268	75	87	3	0	0
1	eH	56	433	268	75	87	3	0	0
1	eP	56	433	268	75	87	3	0	0
1	eQ	56	433	268	75	87	3	0	0
1	eR	56	433	268	75	87	3	0	0
1	eS	56	433	268	75	87	3	0	0
1	eT	56	433	268	75	87	3	0	0
1	eU	56	433	268	75	87	3	0	0
1	eV	56	433	268	75	87	3	0	0
1	fd	56	433	268	75	87	3	0	0
1	fe	56	433	268	75	87	3	0	0
1	ff	56	433	268	75	87	3	0	0
1	fg	56	433	268	75	87	3	0	0
1	fh	56	433	268	75	87	3	0	0
1	fi	56	433	268	75	87	3	0	0
1	fj	56	433	268	75	87	3	0	0
1	fr	56	433	268	75	87	3	0	0
1	fs	56	433	268	75	87	3	0	0
1	ft	56	433	268	75	87	3	0	0
1	fu	56	433	268	75	87	3	0	0

Continued on next page...

Continued from previous page...

Mol	Chain	Residues	Atoms					AltConf	Trace
			Total	C	N	O	S		
1	fv	56	433	268	75	87	3	0	0
1	fw	56	433	268	75	87	3	0	0
1	fx	56	433	268	75	87	3	0	0
1	fF	56	433	268	75	87	3	0	0
1	fG	56	433	268	75	87	3	0	0
1	fH	56	433	268	75	87	3	0	0
1	fI	56	433	268	75	87	3	0	0
1	fJ	56	433	268	75	87	3	0	0
1	fK	56	433	268	75	87	3	0	0
1	fL	56	433	268	75	87	3	0	0
1	fT	56	433	268	75	87	3	0	0
1	fU	56	433	268	75	87	3	0	0
1	fV	56	433	268	75	87	3	0	0
1	fW	56	433	268	75	87	3	0	0
1	fX	56	433	268	75	87	3	0	0
1	fY	56	433	268	75	87	3	0	0
1	fZ	56	433	268	75	87	3	0	0
1	gh	56	433	268	75	87	3	0	0
1	gi	56	433	268	75	87	3	0	0
1	gj	56	433	268	75	87	3	0	0
1	gk	56	433	268	75	87	3	0	0

Continued on next page...

Continued from previous page...

Mol	Chain	Residues	Atoms					AltConf	Trace
			Total	C	N	O	S		
1	gl	56	433	268	75	87	3	0	0
1	gm	56	433	268	75	87	3	0	0
1	gn	56	433	268	75	87	3	0	0
1	gv	56	433	268	75	87	3	0	0
1	gw	56	433	268	75	87	3	0	0
1	gx	56	433	268	75	87	3	0	0
1	gy	56	433	268	75	87	3	0	0
1	gz	56	433	268	75	87	3	0	0
1	gA	56	433	268	75	87	3	0	0
1	gB	56	433	268	75	87	3	0	0
1	gJ	56	433	268	75	87	3	0	0
1	gK	56	433	268	75	87	3	0	0
1	gL	56	433	268	75	87	3	0	0
1	gM	56	433	268	75	87	3	0	0
1	gN	56	433	268	75	87	3	0	0
1	gO	56	433	268	75	87	3	0	0
1	gP	56	433	268	75	87	3	0	0
1	gX	56	433	268	75	87	3	0	0
1	gY	56	433	268	75	87	3	0	0
1	gZ	56	433	268	75	87	3	0	0
1	ha	56	433	268	75	87	3	0	0

Continued on next page...

Continued from previous page...

Mol	Chain	Residues	Atoms					AltConf	Trace
			Total	C	N	O	S		
1	hb	56	433	268	75	87	3	0	0
1	hc	56	433	268	75	87	3	0	0
1	hd	56	433	268	75	87	3	0	0
1	hl	56	433	268	75	87	3	0	0
1	hm	56	433	268	75	87	3	0	0
1	hn	56	433	268	75	87	3	0	0
1	ho	56	433	268	75	87	3	0	0
1	hp	56	433	268	75	87	3	0	0
1	hq	56	433	268	75	87	3	0	0
1	hr	56	433	268	75	87	3	0	0
1	hy	56	433	268	75	87	3	0	0
1	hz	56	433	268	75	87	3	0	0
1	hA	56	433	268	75	87	3	0	0
1	hB	56	433	268	75	87	3	0	0
1	hC	56	433	268	75	87	3	0	0
1	hD	56	433	268	75	87	3	0	0
1	hE	56	433	268	75	87	3	0	0
1	hL	56	433	268	75	87	3	0	0
1	hM	56	433	268	75	87	3	0	0
1	hN	56	433	268	75	87	3	0	0
1	hO	56	433	268	75	87	3	0	0

Continued on next page...

Continued from previous page...

Mol	Chain	Residues	Atoms					AltConf	Trace
			Total	C	N	O	S		
1	hP	56	433	268	75	87	3	0	0
1	hQ	56	433	268	75	87	3	0	0
1	hR	56	433	268	75	87	3	0	0
1	hZ	56	433	268	75	87	3	0	0
1	ia	56	433	268	75	87	3	0	0
1	ib	56	433	268	75	87	3	0	0
1	ic	56	433	268	75	87	3	0	0
1	id	56	433	268	75	87	3	0	0
1	ie	56	433	268	75	87	3	0	0
1	if	56	433	268	75	87	3	0	0
1	in	56	433	268	75	87	3	0	0
1	io	56	433	268	75	87	3	0	0
1	ip	56	433	268	75	87	3	0	0
1	iq	56	433	268	75	87	3	0	0
1	ir	56	433	268	75	87	3	0	0
1	is	56	433	268	75	87	3	0	0
1	it	56	433	268	75	87	3	0	0
1	iB	56	433	268	75	87	3	0	0
1	iC	56	433	268	75	87	3	0	0
1	iD	56	433	268	75	87	3	0	0
1	iE	56	433	268	75	87	3	0	0

Continued on next page...

Continued from previous page...

Mol	Chain	Residues	Atoms					AltConf	Trace
			Total	C	N	O	S		
1	iF	56	433	268	75	87	3	0	0
1	iG	56	433	268	75	87	3	0	0
1	iH	56	433	268	75	87	3	0	0
1	iP	56	433	268	75	87	3	0	0
1	iQ	56	433	268	75	87	3	0	0
1	iR	56	433	268	75	87	3	0	0
1	iS	56	433	268	75	87	3	0	0
1	iT	56	433	268	75	87	3	0	0
1	iU	56	433	268	75	87	3	0	0
1	iV	56	433	268	75	87	3	0	0
1	jd	56	433	268	75	87	3	0	0
1	je	56	433	268	75	87	3	0	0
1	jf	56	433	268	75	87	3	0	0
1	yg	56	433	268	75	87	3	0	0
1	yh	56	433	268	75	87	3	0	0
1	yi	56	433	268	75	87	3	0	0
1	yj	56	433	268	75	87	3	0	0
1	yr	56	433	268	75	87	3	0	0
1	ys	56	433	268	75	87	3	0	0
1	yt	56	433	268	75	87	3	0	0
1	yu	56	433	268	75	87	3	0	0

Continued on next page...

Continued from previous page...

Mol	Chain	Residues	Atoms					AltConf	Trace
			Total	C	N	O	S		
1	jv	56	433	268	75	87	3	0	0
1	jw	56	433	268	75	87	3	0	0
1	jx	56	433	268	75	87	3	0	0
1	jF	56	433	268	75	87	3	0	0
1	jG	56	433	268	75	87	3	0	0
1	jH	56	433	268	75	87	3	0	0
1	jI	56	433	268	75	87	3	0	0
1	jJ	56	433	268	75	87	3	0	0
1	jK	56	433	268	75	87	3	0	0
1	jL	56	433	268	75	87	3	0	0
1	jT	56	433	268	75	87	3	0	0
1	jU	56	433	268	75	87	3	0	0
1	jV	56	433	268	75	87	3	0	0
1	jW	56	433	268	75	87	3	0	0
1	jX	56	433	268	75	87	3	0	0
1	jY	56	433	268	75	87	3	0	0
1	jZ	56	433	268	75	87	3	0	0
1	kh	56	433	268	75	87	3	0	0
1	ki	56	433	268	75	87	3	0	0
1	kj	56	433	268	75	87	3	0	0
1	kk	56	433	268	75	87	3	0	0

Continued on next page...

Continued from previous page...

Mol	Chain	Residues	Atoms					AltConf	Trace
			Total	C	N	O	S		
1	kl	56	433	268	75	87	3	0	0
1	km	56	433	268	75	87	3	0	0
1	kn	56	433	268	75	87	3	0	0
1	ku	56	433	268	75	87	3	0	0
1	56	433	268	75	87	3	0	0	
1	kw	56	433	268	75	87	3	0	0
1	kx	56	433	268	75	87	3	0	0
1	ky	56	433	268	75	87	3	0	0
1	kz	56	433	268	75	87	3	0	0
1	kA	56	433	268	75	87	3	0	0
1	kI	56	433	268	75	87	3	0	0
1	kJ	56	433	268	75	87	3	0	0
1	kK	56	433	268	75	87	3	0	0
1	kL	56	433	268	75	87	3	0	0
1	kM	56	433	268	75	87	3	0	0
1	kN	56	433	268	75	87	3	0	0
1	kO	56	433	268	75	87	3	0	0
1	kW	56	433	268	75	87	3	0	0
1	kX	56	433	268	75	87	3	0	0
1	kY	56	433	268	75	87	3	0	0
1	kZ	56	433	268	75	87	3	0	0

Continued on next page...

Continued from previous page...

Mol	Chain	Residues	Atoms					AltConf	Trace
			Total	C	N	O	S		
1	la	56	433	268	75	87	3	0	0
1	lb	56	433	268	75	87	3	0	0
1	lc	56	433	268	75	87	3	0	0
1	lk	56	433	268	75	87	3	0	0
1	ll	56	433	268	75	87	3	0	0
1	lm	56	433	268	75	87	3	0	0
1	ln	56	433	268	75	87	3	0	0
1	lo	56	433	268	75	87	3	0	0
1	lp	56	433	268	75	87	3	0	0
1	lq	56	433	268	75	87	3	0	0
1	ly	56	433	268	75	87	3	0	0
1	lz	56	433	268	75	87	3	0	0
1	lA	56	433	268	75	87	3	0	0
1	lB	56	433	268	75	87	3	0	0
1	lC	56	433	268	75	87	3	0	0
1	lD	56	433	268	75	87	3	0	0
1	lE	56	433	268	75	87	3	0	0
1	lM	56	433	268	75	87	3	0	0
1	lN	56	433	268	75	87	3	0	0
1	lO	56	433	268	75	87	3	0	0
1	lP	56	433	268	75	87	3	0	0

Continued on next page...

Continued from previous page...

Mol	Chain	Residues	Atoms					AltConf	Trace
			Total	C	N	O	S		
1	lQ	56	433	268	75	87	3	0	0
1	lR	56	433	268	75	87	3	0	0
1	lS	56	433	268	75	87	3	0	0
1	ma	56	433	268	75	87	3	0	0
1	mb	56	433	268	75	87	3	0	0
1	mc	56	433	268	75	87	3	0	0
1	md	56	433	268	75	87	3	0	0
1	me	56	433	268	75	87	3	0	0
1	mf	56	433	268	75	87	3	0	0
1	mg	56	433	268	75	87	3	0	0
1	mo	56	433	268	75	87	3	0	0
1	mp	56	433	268	75	87	3	0	0
1	mq	56	433	268	75	87	3	0	0
1	mr	56	433	268	75	87	3	0	0
1	ms	56	433	268	75	87	3	0	0
1	mt	56	433	268	75	87	3	0	0
1	mu	56	433	268	75	87	3	0	0
1	mC	56	433	268	75	87	3	0	0
1	mD	56	433	268	75	87	3	0	0
1	mE	56	433	268	75	87	3	0	0
1	mF	56	433	268	75	87	3	0	0

Continued on next page...

Continued from previous page...

Mol	Chain	Residues	Atoms					AltConf	Trace
			Total	C	N	O	S		
1	mG	56	433	268	75	87	3	0	0
1	mH	56	433	268	75	87	3	0	0
1	mI	56	433	268	75	87	3	0	0
1	mQ	56	433	268	75	87	3	0	0
1	mR	56	433	268	75	87	3	0	0
1	mS	56	433	268	75	87	3	0	0
1	mT	56	433	268	75	87	3	0	0
1	mU	56	433	268	75	87	3	0	0
1	mV	56	433	268	75	87	3	0	0
1	mW	56	433	268	75	87	3	0	0
1	ne	56	433	268	75	87	3	0	0
1	nf	56	433	268	75	87	3	0	0
1	ng	56	433	268	75	87	3	0	0
1	nh	56	433	268	75	87	3	0	0
1	ni	56	433	268	75	87	3	0	0
1	nj	56	433	268	75	87	3	0	0
1	nk	56	433	268	75	87	3	0	0
1	ns	56	433	268	75	87	3	0	0
1	nt	56	433	268	75	87	3	0	0
1	nu	56	433	268	75	87	3	0	0
1	nv	56	433	268	75	87	3	0	0

Continued on next page...

Continued from previous page...

Mol	Chain	Residues	Atoms					AltConf	Trace
			Total	C	N	O	S		
1	nw	56	433	268	75	87	3	0	0
1	nx	56	433	268	75	87	3	0	0
1	ny	56	433	268	75	87	3	0	0
1	nG	56	433	268	75	87	3	0	0
1	nH	56	433	268	75	87	3	0	0
1	nI	56	433	268	75	87	3	0	0
1	nJ	56	433	268	75	87	3	0	0
1	nK	56	433	268	75	87	3	0	0
1	nL	56	433	268	75	87	3	0	0
1	nM	56	433	268	75	87	3	0	0
1	nU	56	433	268	75	87	3	0	0
1	nV	56	433	268	75	87	3	0	0
1	nW	56	433	268	75	87	3	0	0
1	nX	56	433	268	75	87	3	0	0
1	nY	56	433	268	75	87	3	0	0
1	nZ	56	433	268	75	87	3	0	0
1	oa	56	433	268	75	87	3	0	0
1	oi	56	433	268	75	87	3	0	0
1	oj	56	433	268	75	87	3	0	0
1	ok	56	433	268	75	87	3	0	0
1	ol	56	433	268	75	87	3	0	0

Continued on next page...

Continued from previous page...

Mol	Chain	Residues	Atoms					AltConf	Trace
			Total	C	N	O	S		
1	om	56	433	268	75	87	3	0	0
1	on	56	433	268	75	87	3	0	0
1	oo	56	433	268	75	87	3	0	0
1	ow	56	433	268	75	87	3	0	0
1	ox	56	433	268	75	87	3	0	0
1	oy	56	433	268	75	87	3	0	0
1	oz	56	433	268	75	87	3	0	0
1	oA	56	433	268	75	87	3	0	0
1	oB	56	433	268	75	87	3	0	0
1	oC	56	433	268	75	87	3	0	0
1	oK	56	433	268	75	87	3	0	0
1	oL	56	433	268	75	87	3	0	0
1	oM	56	433	268	75	87	3	0	0
1	oN	56	433	268	75	87	3	0	0
1	oO	56	433	268	75	87	3	0	0
1	oP	56	433	268	75	87	3	0	0
1	oQ	56	433	268	75	87	3	0	0
1	oY	56	433	268	75	87	3	0	0
1	oZ	56	433	268	75	87	3	0	0
1	pa	56	433	268	75	87	3	0	0
1	pb	56	433	268	75	87	3	0	0

Continued on next page...

Continued from previous page...

Mol	Chain	Residues	Atoms					AltConf	Trace
			Total	C	N	O	S		
1	pc	56	433	268	75	87	3	0	0
1	pd	56	433	268	75	87	3	0	0
1	pe	56	433	268	75	87	3	0	0
1	pm	56	433	268	75	87	3	0	0
1	pn	56	433	268	75	87	3	0	0
1	po	56	433	268	75	87	3	0	0
1	pp	56	433	268	75	87	3	0	0
1	pq	56	433	268	75	87	3	0	0
1	pr	56	433	268	75	87	3	0	0
1	ps	56	433	268	75	87	3	0	0
1	pA	56	433	268	75	87	3	0	0
1	pB	56	433	268	75	87	3	0	0
1	pC	56	433	268	75	87	3	0	0
1	pD	56	433	268	75	87	3	0	0
1	pE	56	433	268	75	87	3	0	0
1	pF	56	433	268	75	87	3	0	0
1	pG	56	433	268	75	87	3	0	0
1	pO	56	433	268	75	87	3	0	0
1	pP	56	433	268	75	87	3	0	0
1	pQ	56	433	268	75	87	3	0	0
1	pR	56	433	268	75	87	3	0	0

Continued on next page...

Continued from previous page...

Mol	Chain	Residues	Atoms					AltConf	Trace
1	pS	56	Total	C	N	O	S	0	0
			433	268	75	87	3		
1	pT	56	Total	C	N	O	S	0	0
			433	268	75	87	3		
1	pU	56	Total	C	N	O	S	0	0
			433	268	75	87	3		
1	qc	56	Total	C	N	O	S	0	0
			433	268	75	87	3		

- Molecule 2 is a protein called Bacteriophage Mu GpT domain-containing protein.

Mol	Chain	Residues	Atoms					AltConf	Trace
2	ag	295	Total	C	N	O	S	0	0
			2305	1463	394	438	10		
2	ah	297	Total	C	N	O	S	0	0
			2317	1470	396	441	10		
2	ai	295	Total	C	N	O	S	0	0
			2305	1463	394	438	10		
2	aj	295	Total	C	N	O	S	0	0
			2305	1463	394	438	10		
2	ak	295	Total	C	N	O	S	0	0
			2305	1463	394	438	10		
2	al	295	Total	C	N	O	S	0	0
			2305	1463	394	438	10		
2	am	295	Total	C	N	O	S	0	0
			2305	1463	394	438	10		
2	au	295	Total	C	N	O	S	0	0
			2305	1463	394	438	10		
2	av	295	Total	C	N	O	S	0	0
			2305	1463	394	438	10		
2	aw	295	Total	C	N	O	S	0	0
			2305	1463	394	438	10		
2	ax	295	Total	C	N	O	S	0	0
			2305	1463	394	438	10		
2	ay	295	Total	C	N	O	S	0	0
			2305	1463	394	438	10		
2	az	295	Total	C	N	O	S	0	0
			2305	1463	394	438	10		
2	aH	295	Total	C	N	O	S	0	0
			2305	1463	394	438	10		
2	aI	297	Total	C	N	O	S	0	0
			2317	1470	396	441	10		

Continued on next page...

Continued from previous page...

Mol	Chain	Residues	Atoms					AltConf	Trace
2	aJ	295	Total 2305	C 1463	N 394	O 438	S 10	0	0
2	aK	295	Total 2305	C 1463	N 394	O 438	S 10	0	0
2	aL	295	Total 2305	C 1463	N 394	O 438	S 10	0	0
2	aM	295	Total 2305	C 1463	N 394	O 438	S 10	0	0
2	aN	295	Total 2305	C 1463	N 394	O 438	S 10	0	0
2	aV	295	Total 2305	C 1463	N 394	O 438	S 10	0	0
2	aW	297	Total 2317	C 1470	N 396	O 441	S 10	0	0
2	aX	295	Total 2305	C 1463	N 394	O 438	S 10	0	0
2	aY	295	Total 2305	C 1463	N 394	O 438	S 10	0	0
2	aZ	295	Total 2305	C 1463	N 394	O 438	S 10	0	0
2	ba	295	Total 2305	C 1463	N 394	O 438	S 10	0	0
2	bb	295	Total 2305	C 1463	N 394	O 438	S 10	0	0
2	bj	295	Total 2305	C 1463	N 394	O 438	S 10	0	0
2	bk	297	Total 2317	C 1470	N 396	O 441	S 10	0	0
2	bl	295	Total 2305	C 1463	N 394	O 438	S 10	0	0
2	bm	295	Total 2305	C 1463	N 394	O 438	S 10	0	0
2	bn	295	Total 2305	C 1463	N 394	O 438	S 10	0	0
2	bo	295	Total 2305	C 1463	N 394	O 438	S 10	0	0
2	bp	295	Total 2305	C 1463	N 394	O 438	S 10	0	0
2	bx	295	Total 2305	C 1463	N 394	O 438	S 10	0	0
2	by	297	Total 2317	C 1470	N 396	O 441	S 10	0	0

Continued on next page...

Continued from previous page...

Mol	Chain	Residues	Atoms					AltConf	Trace
2	bz	295	Total 2305	C 1463	N 394	O 438	S 10	0	0
2	bA	295	Total 2305	C 1463	N 394	O 438	S 10	0	0
2	bB	295	Total 2305	C 1463	N 394	O 438	S 10	0	0
2	bC	295	Total 2305	C 1463	N 394	O 438	S 10	0	0
2	bD	295	Total 2305	C 1463	N 394	O 438	S 10	0	0
2	bL	295	Total 2305	C 1463	N 394	O 438	S 10	0	0
2	bM	295	Total 2305	C 1463	N 394	O 438	S 10	0	0
2	bN	295	Total 2305	C 1463	N 394	O 438	S 10	0	0
2	bO	295	Total 2305	C 1463	N 394	O 438	S 10	0	0
2	bP	295	Total 2305	C 1463	N 394	O 438	S 10	0	0
2	bQ	295	Total 2305	C 1463	N 394	O 438	S 10	0	0
2	bY	295	Total 2305	C 1463	N 394	O 438	S 10	0	0
2	bZ	297	Total 2317	C 1470	N 396	O 441	S 10	0	0
2	ca	295	Total 2305	C 1463	N 394	O 438	S 10	0	0
2	cb	295	Total 2305	C 1463	N 394	O 438	S 10	0	0
2	cc	295	Total 2305	C 1463	N 394	O 438	S 10	0	0
2	cd	295	Total 2305	C 1463	N 394	O 438	S 10	0	0
2	ce	295	Total 2305	C 1463	N 394	O 438	S 10	0	0
2	cm	295	Total 2305	C 1463	N 394	O 438	S 10	0	0
2	cn	297	Total 2317	C 1470	N 396	O 441	S 10	0	0
2	co	295	Total 2305	C 1463	N 394	O 438	S 10	0	0

Continued on next page...

Continued from previous page...

Mol	Chain	Residues	Atoms					AltConf	Trace
			Total	C	N	O	S		
2	cp	295	2305	1463	394	438	10	0	0
2	cq	295	2305	1463	394	438	10	0	0
2	cr	295	2305	1463	394	438	10	0	0
2	cs	295	2305	1463	394	438	10	0	0
2	cA	295	2305	1463	394	438	10	0	0
2	cB	297	2317	1470	396	441	10	0	0
2	cC	295	2305	1463	394	438	10	0	0
2	cD	295	2305	1463	394	438	10	0	0
2	cE	295	2305	1463	394	438	10	0	0
2	cF	295	2305	1463	394	438	10	0	0
2	cG	295	2305	1463	394	438	10	0	0
2	cO	295	2305	1463	394	438	10	0	0
2	cP	297	2317	1470	396	441	10	0	0
2	cQ	295	2305	1463	394	438	10	0	0
2	cR	295	2305	1463	394	438	10	0	0
2	cS	295	2305	1463	394	438	10	0	0
2	cT	295	2305	1463	394	438	10	0	0
2	cU	295	2305	1463	394	438	10	0	0
2	dc	295	2305	1463	394	438	10	0	0
2	dd	297	2317	1470	396	441	10	0	0
2	de	295	2305	1463	394	438	10	0	0

Continued on next page...

Continued from previous page...

Mol	Chain	Residues	Atoms					AltConf	Trace
			Total	C	N	O	S		
2	df	295	Total 2305	C 1463	N 394	O 438	S 10	0	0
2	dg	295	Total 2305	C 1463	N 394	O 438	S 10	0	0
2	dh	295	Total 2305	C 1463	N 394	O 438	S 10	0	0
2	di	295	Total 2305	C 1463	N 394	O 438	S 10	0	0
2	dq	295	Total 2305	C 1463	N 394	O 438	S 10	0	0
2	dr	297	Total 2317	C 1470	N 396	O 441	S 10	0	0
2	ds	295	Total 2305	C 1463	N 394	O 438	S 10	0	0
2	dt	295	Total 2305	C 1463	N 394	O 438	S 10	0	0
2	du	295	Total 2305	C 1463	N 394	O 438	S 10	0	0
2	dv	295	Total 2305	C 1463	N 394	O 438	S 10	0	0
2	dw	295	Total 2305	C 1463	N 394	O 438	S 10	0	0
2	dE	295	Total 2305	C 1463	N 394	O 438	S 10	0	0
2	dF	297	Total 2317	C 1470	N 396	O 441	S 10	0	0
2	dG	295	Total 2305	C 1463	N 394	O 438	S 10	0	0
2	dH	295	Total 2305	C 1463	N 394	O 438	S 10	0	0
2	dI	295	Total 2305	C 1463	N 394	O 438	S 10	0	0
2	dJ	295	Total 2305	C 1463	N 394	O 438	S 10	0	0
2	dK	295	Total 2305	C 1463	N 394	O 438	S 10	0	0
2	dS	295	Total 2305	C 1463	N 394	O 438	S 10	0	0
2	dT	297	Total 2317	C 1470	N 396	O 441	S 10	0	0
2	dU	295	Total 2305	C 1463	N 394	O 438	S 10	0	0

Continued on next page...

Continued from previous page...

Mol	Chain	Residues	Atoms					AltConf	Trace
			Total	C	N	O	S		
2	dV	295	2305	1463	394	438	10	0	0
2	dW	295	2305	1463	394	438	10	0	0
2	dX	295	2305	1463	394	438	10	0	0
2	dY	295	2305	1463	394	438	10	0	0
2	eg	295	2305	1463	394	438	10	0	0
2	eh	297	2317	1470	396	441	10	0	0
2	ei	295	2305	1463	394	438	10	0	0
2	ej	295	2305	1463	394	438	10	0	0
2	ek	295	2305	1463	394	438	10	0	0
2	el	295	2305	1463	394	438	10	0	0
2	em	295	2305	1463	394	438	10	0	0
2	eu	295	2305	1463	394	438	10	0	0
2	ev	297	2317	1470	396	441	10	0	0
2	ew	295	2305	1463	394	438	10	0	0
2	ex	295	2305	1463	394	438	10	0	0
2	ey	295	2305	1463	394	438	10	0	0
2	ez	295	2305	1463	394	438	10	0	0
2	eA	295	2305	1463	394	438	10	0	0
2	eI	295	2305	1463	394	438	10	0	0
2	eJ	297	2317	1470	396	441	10	0	0
2	eK	295	2305	1463	394	438	10	0	0

Continued on next page...

Continued from previous page...

Mol	Chain	Residues	Atoms					AltConf	Trace
			Total	C	N	O	S		
2	eL	295	2305	1463	394	438	10	0	0
2	eM	295	2305	1463	394	438	10	0	0
2	eN	295	2305	1463	394	438	10	0	0
2	eO	295	2305	1463	394	438	10	0	0
2	eW	295	2305	1463	394	438	10	0	0
2	eX	297	2317	1470	396	441	10	0	0
2	eY	295	2305	1463	394	438	10	0	0
2	eZ	295	2305	1463	394	438	10	0	0
2	fa	295	2305	1463	394	438	10	0	0
2	fb	295	2305	1463	394	438	10	0	0
2	fc	295	2305	1463	394	438	10	0	0
2	fk	295	2305	1463	394	438	10	0	0
2	fl	297	2317	1470	396	441	10	0	0
2	fm	295	2305	1463	394	438	10	0	0
2	fn	295	2305	1463	394	438	10	0	0
2	fo	295	2305	1463	394	438	10	0	0
2	fp	295	2305	1463	394	438	10	0	0
2	fq	295	2305	1463	394	438	10	0	0
2	fy	295	2305	1463	394	438	10	0	0
2	fz	297	2317	1470	396	441	10	0	0
2	fA	295	2305	1463	394	438	10	0	0

Continued on next page...

Continued from previous page...

Mol	Chain	Residues	Atoms					AltConf	Trace
			Total	C	N	O	S		
2	fB	295	2305	1463	394	438	10	0	0
2	fC	295	2305	1463	394	438	10	0	0
2	fD	295	2305	1463	394	438	10	0	0
2	fE	295	2305	1463	394	438	10	0	0
2	fM	295	2305	1463	394	438	10	0	0
2	fN	297	2317	1470	396	441	10	0	0
2	fO	295	2305	1463	394	438	10	0	0
2	fP	295	2305	1463	394	438	10	0	0
2	fQ	295	2305	1463	394	438	10	0	0
2	fR	295	2305	1463	394	438	10	0	0
2	fS	295	2305	1463	394	438	10	0	0
2	ga	295	2305	1463	394	438	10	0	0
2	gb	297	2317	1470	396	441	10	0	0
2	gc	295	2305	1463	394	438	10	0	0
2	gd	295	2305	1463	394	438	10	0	0
2	ge	295	2305	1463	394	438	10	0	0
2	gf	295	2305	1463	394	438	10	0	0
2	gg	295	2305	1463	394	438	10	0	0
2	go	295	2305	1463	394	438	10	0	0
2	gp	297	2317	1470	396	441	10	0	0
2	gq	295	2305	1463	394	438	10	0	0

Continued on next page...

Continued from previous page...

Mol	Chain	Residues	Atoms					AltConf	Trace
			Total	C	N	O	S		
2	gr	295	2305	1463	394	438	10	0	0
2	gs	295	2305	1463	394	438	10	0	0
2	gt	295	2305	1463	394	438	10	0	0
2	gu	295	2305	1463	394	438	10	0	0
2	gC	295	2305	1463	394	438	10	0	0
2	gD	297	2317	1470	396	441	10	0	0
2	gE	295	2305	1463	394	438	10	0	0
2	gF	295	2305	1463	394	438	10	0	0
2	gG	295	2305	1463	394	438	10	0	0
2	gH	295	2305	1463	394	438	10	0	0
2	gI	295	2305	1463	394	438	10	0	0
2	gQ	295	2305	1463	394	438	10	0	0
2	gR	297	2317	1470	396	441	10	0	0
2	gS	295	2305	1463	394	438	10	0	0
2	gT	295	2305	1463	394	438	10	0	0
2	gU	295	2305	1463	394	438	10	0	0
2	gV	295	2305	1463	394	438	10	0	0
2	gW	295	2305	1463	394	438	10	0	0
2	he	295	2305	1463	394	438	10	0	0
2	hf	297	2317	1470	396	441	10	0	0
2	hg	295	2305	1463	394	438	10	0	0

Continued on next page...

Continued from previous page...

Mol	Chain	Residues	Atoms					AltConf	Trace
			Total	C	N	O	S		
2	hh	295	2305	1463	394	438	10	0	0
2	hi	295	2305	1463	394	438	10	0	0
2	hj	295	2305	1463	394	438	10	0	0
2	hk	295	2305	1463	394	438	10	0	0
2	hs	295	2305	1463	394	438	10	0	0
2	ht	295	2305	1463	394	438	10	0	0
2	hu	295	2305	1463	394	438	10	0	0
2	hv	295	2305	1463	394	438	10	0	0
2	hw	295	2305	1463	394	438	10	0	0
2	hx	295	2305	1463	394	438	10	0	0
2	hF	295	2305	1463	394	438	10	0	0
2	hG	295	2305	1463	394	438	10	0	0
2	hH	295	2305	1463	394	438	10	0	0
2	hI	295	2305	1463	394	438	10	0	0
2	hJ	295	2305	1463	394	438	10	0	0
2	hK	295	2305	1463	394	438	10	0	0
2	hS	295	2305	1463	394	438	10	0	0
2	hT	297	2317	1470	396	441	10	0	0
2	hU	295	2305	1463	394	438	10	0	0
2	hV	295	2305	1463	394	438	10	0	0
2	hW	295	2305	1463	394	438	10	0	0

Continued on next page...

Continued from previous page...

Mol	Chain	Residues	Atoms					AltConf	Trace
2	hX	295	Total 2305	C 1463	N 394	O 438	S 10	0	0
2	hY	295	Total 2305	C 1463	N 394	O 438	S 10	0	0
2	ig	295	Total 2305	C 1463	N 394	O 438	S 10	0	0
2	ih	297	Total 2317	C 1470	N 396	O 441	S 10	0	0
2	ii	295	Total 2305	C 1463	N 394	O 438	S 10	0	0
2	ij	295	Total 2305	C 1463	N 394	O 438	S 10	0	0
2	ik	295	Total 2305	C 1463	N 394	O 438	S 10	0	0
2	il	295	Total 2305	C 1463	N 394	O 438	S 10	0	0
2	im	295	Total 2305	C 1463	N 394	O 438	S 10	0	0
2	iu	295	Total 2305	C 1463	N 394	O 438	S 10	0	0
2	iv	297	Total 2317	C 1470	N 396	O 441	S 10	0	0
2	iw	295	Total 2305	C 1463	N 394	O 438	S 10	0	0
2	ix	295	Total 2305	C 1463	N 394	O 438	S 10	0	0
2	iy	295	Total 2305	C 1463	N 394	O 438	S 10	0	0
2	iz	295	Total 2305	C 1463	N 394	O 438	S 10	0	0
2	iA	295	Total 2305	C 1463	N 394	O 438	S 10	0	0
2	iI	295	Total 2305	C 1463	N 394	O 438	S 10	0	0
2	iJ	297	Total 2317	C 1470	N 396	O 441	S 10	0	0
2	iK	295	Total 2305	C 1463	N 394	O 438	S 10	0	0
2	iL	295	Total 2305	C 1463	N 394	O 438	S 10	0	0
2	iM	295	Total 2305	C 1463	N 394	O 438	S 10	0	0

Continued on next page...

Continued from previous page...

Mol	Chain	Residues	Atoms					AltConf	Trace
2	iN	295	Total 2305	C 1463	N 394	O 438	S 10	0	0
2	iO	295	Total 2305	C 1463	N 394	O 438	S 10	0	0
2	iW	295	Total 2305	C 1463	N 394	O 438	S 10	0	0
2	iX	297	Total 2317	C 1470	N 396	O 441	S 10	0	0
2	iY	295	Total 2305	C 1463	N 394	O 438	S 10	0	0
2	iZ	295	Total 2305	C 1463	N 394	O 438	S 10	0	0
2	ja	295	Total 2305	C 1463	N 394	O 438	S 10	0	0
2	jb	295	Total 2305	C 1463	N 394	O 438	S 10	0	0
2	jc	295	Total 2305	C 1463	N 394	O 438	S 10	0	0
2	jk	295	Total 2305	C 1463	N 394	O 438	S 10	0	0
2	jl	297	Total 2317	C 1470	N 396	O 441	S 10	0	0
2	jm	295	Total 2305	C 1463	N 394	O 438	S 10	0	0
2	jn	295	Total 2305	C 1463	N 394	O 438	S 10	0	0
2	jo	295	Total 2305	C 1463	N 394	O 438	S 10	0	0
2	jp	295	Total 2305	C 1463	N 394	O 438	S 10	0	0
2	jq	295	Total 2305	C 1463	N 394	O 438	S 10	0	0
2	jy	295	Total 2305	C 1463	N 394	O 438	S 10	0	0
2	jz	297	Total 2317	C 1470	N 396	O 441	S 10	0	0
2	jA	295	Total 2305	C 1463	N 394	O 438	S 10	0	0
2	jB	295	Total 2305	C 1463	N 394	O 438	S 10	0	0
2	jC	295	Total 2305	C 1463	N 394	O 438	S 10	0	0

Continued on next page...

Continued from previous page...

Mol	Chain	Residues	Atoms					AltConf	Trace
			Total	C	N	O	S		
2	jD	295	Total 2305	C 1463	N 394	O 438	S 10	0	0
2	jE	295	Total 2305	C 1463	N 394	O 438	S 10	0	0
2	jM	295	Total 2305	C 1463	N 394	O 438	S 10	0	0
2	jN	297	Total 2317	C 1470	N 396	O 441	S 10	0	0
2	jO	295	Total 2305	C 1463	N 394	O 438	S 10	0	0
2	jP	295	Total 2305	C 1463	N 394	O 438	S 10	0	0
2	jQ	295	Total 2305	C 1463	N 394	O 438	S 10	0	0
2	jR	295	Total 2305	C 1463	N 394	O 438	S 10	0	0
2	jS	295	Total 2305	C 1463	N 394	O 438	S 10	0	0
2	ka	295	Total 2305	C 1463	N 394	O 438	S 10	0	0
2	kb	297	Total 2317	C 1470	N 396	O 441	S 10	0	0
2	kc	295	Total 2305	C 1463	N 394	O 438	S 10	0	0
2	kd	295	Total 2305	C 1463	N 394	O 438	S 10	0	0
2	ke	295	Total 2305	C 1463	N 394	O 438	S 10	0	0
2	kf	295	Total 2305	C 1463	N 394	O 438	S 10	0	0
2	kg	295	Total 2305	C 1463	N 394	O 438	S 10	0	0
2	ko	295	Total 2305	C 1463	N 394	O 438	S 10	0	0
2	kp	295	Total 2305	C 1463	N 394	O 438	S 10	0	0
2	kq	295	Total 2305	C 1463	N 394	O 438	S 10	0	0
2	kr	295	Total 2305	C 1463	N 394	O 438	S 10	0	0
2	ks	295	Total 2305	C 1463	N 394	O 438	S 10	0	0

Continued on next page...

Continued from previous page...

Mol	Chain	Residues	Atoms					AltConf	Trace
			Total	C	N	O	S		
2	kt	295	2305	1463	394	438	10	0	0
2	kB	295	2305	1463	394	438	10	0	0
2	kC	297	2317	1470	396	441	10	0	0
2	kD	295	2305	1463	394	438	10	0	0
2	kE	295	2305	1463	394	438	10	0	0
2	kF	295	2305	1463	394	438	10	0	0
2	kG	295	2305	1463	394	438	10	0	0
2	kH	295	2305	1463	394	438	10	0	0
2	kP	295	2305	1463	394	438	10	0	0
2	kQ	297	2317	1470	396	441	10	0	0
2	kR	295	2305	1463	394	438	10	0	0
2	kS	295	2305	1463	394	438	10	0	0
2	kT	295	2305	1463	394	438	10	0	0
2	kU	295	2305	1463	394	438	10	0	0
2	kV	295	2305	1463	394	438	10	0	0
2	ld	295	2305	1463	394	438	10	0	0
2	le	297	2317	1470	396	441	10	0	0
2	lf	295	2305	1463	394	438	10	0	0
2	lg	295	2305	1463	394	438	10	0	0
2	lh	295	2305	1463	394	438	10	0	0
2	li	295	2305	1463	394	438	10	0	0

Continued on next page...

Continued from previous page...

Mol	Chain	Residues	Atoms					AltConf	Trace
			Total	C	N	O	S		
2	lj	295	2305	1463	394	438	10	0	0
2	lr	295	2305	1463	394	438	10	0	0
2	ls	297	2317	1470	396	441	10	0	0
2	lt	295	2305	1463	394	438	10	0	0
2	lu	295	2305	1463	394	438	10	0	0
2	lv	295	2305	1463	394	438	10	0	0
2	lw	295	2305	1463	394	438	10	0	0
2	lx	295	2305	1463	394	438	10	0	0
2	lF	295	2305	1463	394	438	10	0	0
2	lG	297	2317	1470	396	441	10	0	0
2	lH	295	2305	1463	394	438	10	0	0
2	lI	295	2305	1463	394	438	10	0	0
2	lJ	295	2305	1463	394	438	10	0	0
2	lK	295	2305	1463	394	438	10	0	0
2	lL	295	2305	1463	394	438	10	0	0
2	lT	295	2305	1463	394	438	10	0	0
2	lU	297	2317	1470	396	441	10	0	0
2	lV	295	2305	1463	394	438	10	0	0
2	lW	295	2305	1463	394	438	10	0	0
2	lX	295	2305	1463	394	438	10	0	0
2	lY	295	2305	1463	394	438	10	0	0

Continued on next page...

Continued from previous page...

Mol	Chain	Residues	Atoms					AltConf	Trace
			Total	C	N	O	S		
2	lZ	295	2305	1463	394	438	10	0	0
2	mh	295	2305	1463	394	438	10	0	0
2	mi	297	2317	1470	396	441	10	0	0
2	mj	295	2305	1463	394	438	10	0	0
2	mk	295	2305	1463	394	438	10	0	0
2	ml	295	2305	1463	394	438	10	0	0
2	mm	295	2305	1463	394	438	10	0	0
2	mn	295	2305	1463	394	438	10	0	0
2	mv	295	2305	1463	394	438	10	0	0
2	mw	297	2317	1470	396	441	10	0	0
2	mx	295	2305	1463	394	438	10	0	0
2	my	295	2305	1463	394	438	10	0	0
2	mz	295	2305	1463	394	438	10	0	0
2	mA	295	2305	1463	394	438	10	0	0
2	mB	295	2305	1463	394	438	10	0	0
2	mJ	295	2305	1463	394	438	10	0	0
2	mK	297	2317	1470	396	441	10	0	0
2	mL	295	2305	1463	394	438	10	0	0
2	mM	295	2305	1463	394	438	10	0	0
2	mN	295	2305	1463	394	438	10	0	0
2	mO	295	2305	1463	394	438	10	0	0

Continued on next page...

Continued from previous page...

Mol	Chain	Residues	Atoms					AltConf	Trace
2	mP	295	Total	C	N	O	S	0	0
			2305	1463	394	438	10		
2	mX	295	Total	C	N	O	S	0	0
			2305	1463	394	438	10		
2	mY	297	Total	C	N	O	S	0	0
			2317	1470	396	441	10		
2	mZ	295	Total	C	N	O	S	0	0
			2305	1463	394	438	10		
2	na	295	Total	C	N	O	S	0	0
			2305	1463	394	438	10		
2	nb	295	Total	C	N	O	S	0	0
			2305	1463	394	438	10		
2	nc	295	Total	C	N	O	S	0	0
			2305	1463	394	438	10		
2	nd	295	Total	C	N	O	S	0	0
			2305	1463	394	438	10		
2	nl	295	Total	C	N	O	S	0	0
			2305	1463	394	438	10		
2	nm	297	Total	C	N	O	S	0	0
			2317	1470	396	441	10		
2	nn	295	Total	C	N	O	S	0	0
			2305	1463	394	438	10		
2	no	295	Total	C	N	O	S	0	0
			2305	1463	394	438	10		
2	np	295	Total	C	N	O	S	0	0
			2305	1463	394	438	10		
2	nq	295	Total	C	N	O	S	0	0
			2305	1463	394	438	10		
2	nr	295	Total	C	N	O	S	0	0
			2305	1463	394	438	10		
2	nz	295	Total	C	N	O	S	0	0
			2305	1463	394	438	10		
2	nA	297	Total	C	N	O	S	0	0
			2317	1470	396	441	10		
2	nB	295	Total	C	N	O	S	0	0
			2305	1463	394	438	10		
2	nC	295	Total	C	N	O	S	0	0
			2305	1463	394	438	10		
2	nD	295	Total	C	N	O	S	0	0
			2305	1463	394	438	10		
2	nE	295	Total	C	N	O	S	0	0
			2305	1463	394	438	10		

Continued on next page...

Continued from previous page...

Mol	Chain	Residues	Atoms					AltConf	Trace
2	nF	295	Total	C	N	O	S	0	0
			2305	1463	394	438	10		
2	nN	295	Total	C	N	O	S	0	0
			2305	1463	394	438	10		
2	nO	297	Total	C	N	O	S	0	0
			2317	1470	396	441	10		
2	nP	295	Total	C	N	O	S	0	0
			2305	1463	394	438	10		
2	nQ	295	Total	C	N	O	S	0	0
			2305	1463	394	438	10		
2	nR	295	Total	C	N	O	S	0	0
			2305	1463	394	438	10		
2	nS	295	Total	C	N	O	S	0	0
			2305	1463	394	438	10		
2	nT	295	Total	C	N	O	S	0	0
			2305	1463	394	438	10		
2	ob	295	Total	C	N	O	S	0	0
			2305	1463	394	438	10		
2	oc	297	Total	C	N	O	S	0	0
			2317	1470	396	441	10		
2	od	295	Total	C	N	O	S	0	0
			2305	1463	394	438	10		
2	oe	295	Total	C	N	O	S	0	0
			2305	1463	394	438	10		
2	of	295	Total	C	N	O	S	0	0
			2305	1463	394	438	10		
2	og	295	Total	C	N	O	S	0	0
			2305	1463	394	438	10		
2	oh	295	Total	C	N	O	S	0	0
			2305	1463	394	438	10		
2	op	295	Total	C	N	O	S	0	0
			2305	1463	394	438	10		
2	oq	297	Total	C	N	O	S	0	0
			2317	1470	396	441	10		
2	or	295	Total	C	N	O	S	0	0
			2305	1463	394	438	10		
2	os	295	Total	C	N	O	S	0	0
			2305	1463	394	438	10		
2	ot	295	Total	C	N	O	S	0	0
			2305	1463	394	438	10		
2	ou	295	Total	C	N	O	S	0	0
			2305	1463	394	438	10		

Continued on next page...

Continued from previous page...

Mol	Chain	Residues	Atoms					AltConf	Trace
			Total	C	N	O	S		
2	ov	295	2305	1463	394	438	10	0	0
2	oD	295	2305	1463	394	438	10	0	0
2	oE	297	2317	1470	396	441	10	0	0
2	oF	295	2305	1463	394	438	10	0	0
2	oG	295	2305	1463	394	438	10	0	0
2	oH	295	2305	1463	394	438	10	0	0
2	oI	295	2305	1463	394	438	10	0	0
2	oJ	295	2305	1463	394	438	10	0	0
2	oR	295	2305	1463	394	438	10	0	0
2	oS	297	2317	1470	396	441	10	0	0
2	oT	295	2305	1463	394	438	10	0	0
2	oU	295	2305	1463	394	438	10	0	0
2	oV	295	2305	1463	394	438	10	0	0
2	oW	295	2305	1463	394	438	10	0	0
2	oX	295	2305	1463	394	438	10	0	0
2	pf	295	2305	1463	394	438	10	0	0
2	pg	297	2317	1470	396	441	10	0	0
2	ph	295	2305	1463	394	438	10	0	0
2	pi	295	2305	1463	394	438	10	0	0
2	pj	295	2305	1463	394	438	10	0	0
2	pk	295	2305	1463	394	438	10	0	0

Continued on next page...

Continued from previous page...

Mol	Chain	Residues	Atoms					AltConf	Trace
			Total	C	N	O	S		
2	pl	295	Total 2305	C 1463	N 394	O 438	S 10	0	0
2	pt	295	Total 2305	C 1463	N 394	O 438	S 10	0	0
2	pu	297	Total 2317	C 1470	N 396	O 441	S 10	0	0
2	pv	295	Total 2305	C 1463	N 394	O 438	S 10	0	0
2	pw	295	Total 2305	C 1463	N 394	O 438	S 10	0	0
2	px	295	Total 2305	C 1463	N 394	O 438	S 10	0	0
2	py	295	Total 2305	C 1463	N 394	O 438	S 10	0	0
2	pz	295	Total 2305	C 1463	N 394	O 438	S 10	0	0
2	pH	295	Total 2305	C 1463	N 394	O 438	S 10	0	0
2	pI	297	Total 2317	C 1470	N 396	O 441	S 10	0	0
2	pJ	295	Total 2305	C 1463	N 394	O 438	S 10	0	0
2	pK	295	Total 2305	C 1463	N 394	O 438	S 10	0	0
2	pL	295	Total 2305	C 1463	N 394	O 438	S 10	0	0
2	pM	295	Total 2305	C 1463	N 394	O 438	S 10	0	0
2	pN	295	Total 2305	C 1463	N 394	O 438	S 10	0	0
2	pV	295	Total 2305	C 1463	N 394	O 438	S 10	0	0
2	pW	297	Total 2317	C 1470	N 396	O 441	S 10	0	0
2	pX	295	Total 2305	C 1463	N 394	O 438	S 10	0	0
2	pY	295	Total 2305	C 1463	N 394	O 438	S 10	0	0
2	pZ	295	Total 2305	C 1463	N 394	O 438	S 10	0	0
2	qa	295	Total 2305	C 1463	N 394	O 438	S 10	0	0

Continued on next page...

Continued from previous page...

Mol	Chain	Residues	Atoms					AltConf	Trace
			Total	C	N	O	S		
2	qb	295	2305	1463	394	438	10	0	0

- Molecule 3 is a protein called Stopper protein.

Mol	Chain	Residues	Atoms					AltConf	Trace
			Total	C	H	N	O		
3	qd	136	2036	652	1013	179	192	0	0
3	qe	136	2036	652	1013	179	192	0	0
3	qf	136	2036	652	1013	179	192	0	0
3	qg	136	2036	652	1013	179	192	0	0
3	qh	136	2036	652	1013	179	192	0	0
3	qi	136	2036	652	1013	179	192	0	0

- Molecule 4 is a protein called Virion structural protein.

Mol	Chain	Residues	Atoms						AltConf	Trace
			Total	C	H	N	O	S		
4	qj	252	3767	1199	1896	309	360	3	0	0
4	qk	252	3767	1199	1896	309	360	3	0	0
4	ql	252	3767	1199	1896	309	360	3	0	0
4	qm	252	3767	1199	1896	309	360	3	0	0
4	qn	252	3767	1199	1896	309	360	3	0	0
4	qo	252	3767	1199	1896	309	360	3	0	0

- Molecule 5 is a protein called Portal protein.

Mol	Chain	Residues	Atoms					AltConf	Trace
			Total	C	N	O	S		
5	qp	405	3151	1993	563	585	10	0	0
5	qr	405	3151	1993	563	585	10	0	0

Continued on next page...

Continued from previous page...

Mol	Chain	Residues	Atoms					AltConf	Trace
5	qt	405	Total	C	N	O	S	0	0
			3151	1993	563	585	10		
5	qv	405	Total	C	N	O	S	0	0
			3151	1993	563	585	10		
5	qx	405	Total	C	N	O	S	0	0
			3151	1993	563	585	10		
5	qz	405	Total	C	N	O	S	0	0
			3151	1993	563	585	10		
5	qB	405	Total	C	N	O	S	0	0
			3151	1993	563	585	10		
5	qD	405	Total	C	N	O	S	0	0
			3151	1993	563	585	10		
5	qF	405	Total	C	N	O	S	0	0
			3151	1993	563	585	10		
5	qH	405	Total	C	N	O	S	0	0
			3151	1993	563	585	10		
5	qJ	405	Total	C	N	O	S	0	0
			3151	1993	563	585	10		
5	qL	405	Total	C	N	O	S	0	0
			3151	1993	563	585	10		

- Molecule 6 is a protein called DUF1320 domain-containing protein.

Mol	Chain	Residues	Atoms					AltConf	Trace
6	qq	137	Total	C	N	O	S	0	0
			1056	663	186	205	2		
6	qs	137	Total	C	N	O	S	0	0
			1056	663	186	205	2		
6	qu	137	Total	C	N	O	S	0	0
			1056	663	186	205	2		
6	qw	137	Total	C	N	O	S	0	0
			1056	663	186	205	2		
6	qy	137	Total	C	N	O	S	0	0
			1056	663	186	205	2		
6	qA	137	Total	C	N	O	S	0	0
			1056	663	186	205	2		
6	qC	137	Total	C	N	O	S	0	0
			1056	663	186	205	2		
6	qE	137	Total	C	N	O	S	0	0
			1056	663	186	205	2		
6	qG	137	Total	C	N	O	S	0	0
			1056	663	186	205	2		

Continued on next page...

Continued from previous page...

Mol	Chain	Residues	Atoms					AltConf	Trace
6	qI	137	Total	C	N	O	S	0	0
			1056	663	186	205	2		
6	qK	137	Total	C	N	O	S	0	0
			1056	663	186	205	2		
6	qM	137	Total	C	N	O	S	0	0
			1056	663	186	205	2		

3 Residue-property plots

These plots are drawn for all protein, RNA, DNA and oligosaccharide chains in the entry. The first graphic for a chain summarises the proportions of the various outlier classes displayed in the second graphic. The second graphic shows the sequence view annotated by issues in geometry and atom inclusion in map density. Residues are color-coded according to the number of geometric quality criteria for which they contain at least one outlier: green = 0, yellow = 1, orange = 2 and red = 3 or more. A red diamond above a residue indicates a poor fit to the EM map for this residue (all-atom inclusion < 40%). Stretches of 2 or more consecutive residues without any outlier are shown as a green connector. Residues present in the sample, but not in the model, are shown in grey.

- Molecule 1: Mu-like prophage FluMu N-terminal domain-containing protein

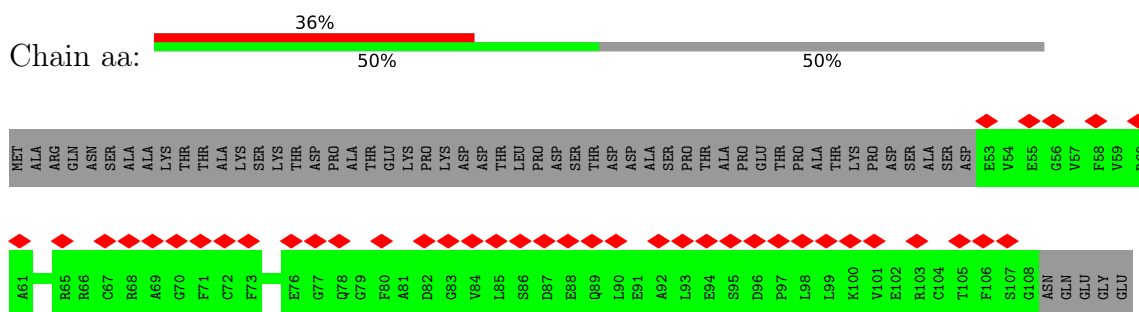

- Molecule 1: Mu-like prophage FluMu N-terminal domain-containing protein



- Molecule 1: Mu-like prophage FluMu N-terminal domain-containing protein

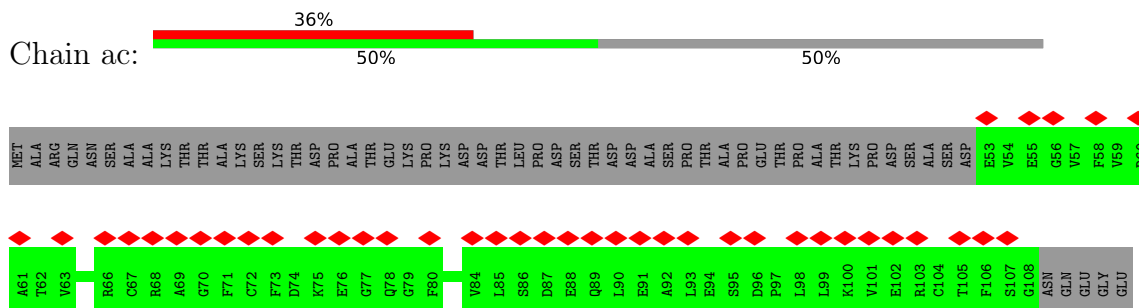

- Molecule 1: Mu-like prophage FluMu N-terminal domain-containing protein



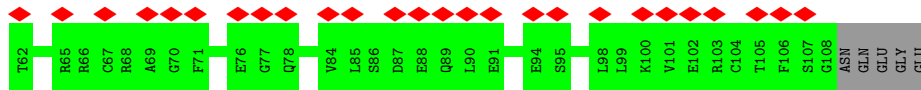
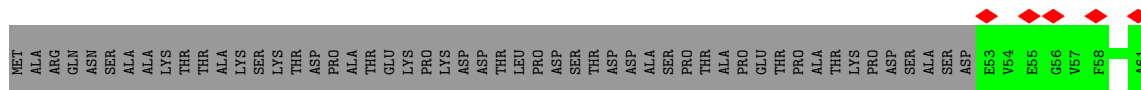

• Molecule 1: Mu-like prophage FluMu N-terminal domain-containing protein

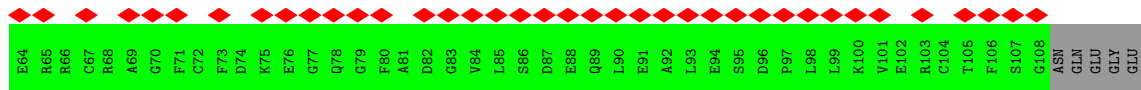
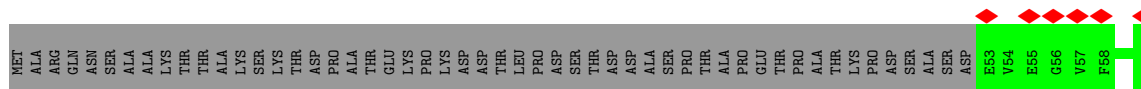
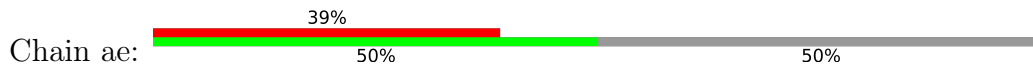

• Molecule 1: Mu-like prophage FluMu N-terminal domain-containing protein

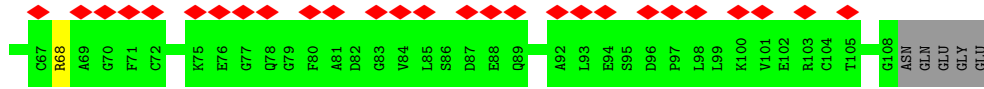
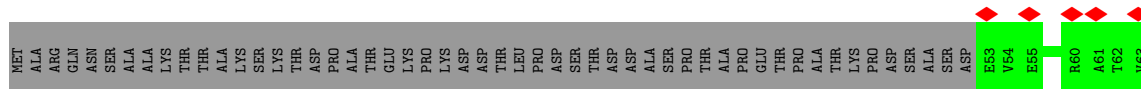

• Molecule 1: Mu-like prophage FluMu N-terminal domain-containing protein

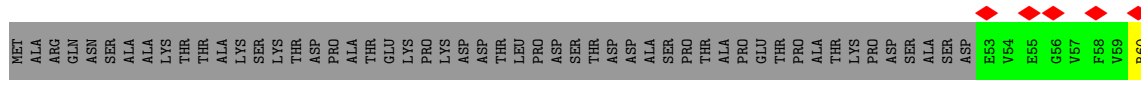

• Molecule 1: Mu-like prophage FluMu N-terminal domain-containing protein



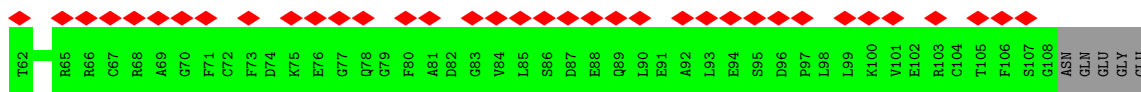

• Molecule 1: Mu-like prophage FluMu N-terminal domain-containing protein

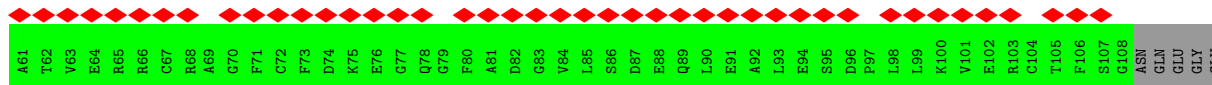
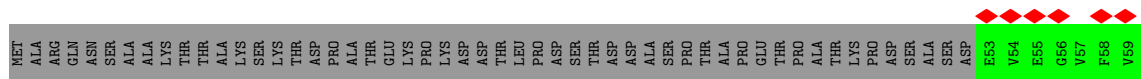
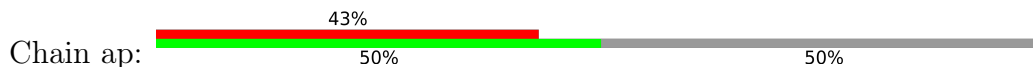

• Molecule 1: Mu-like prophage FluMu N-terminal domain-containing protein

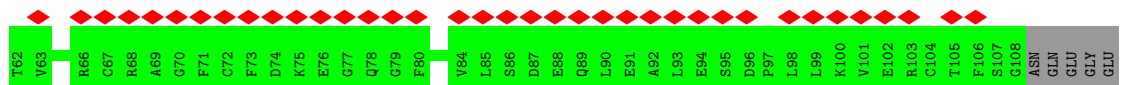
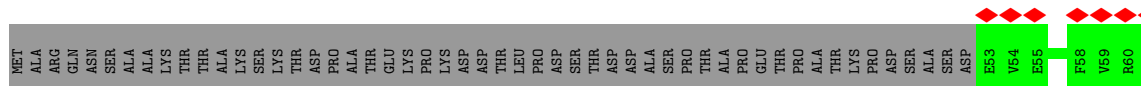
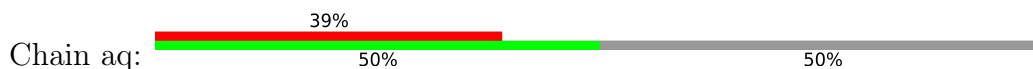

• Molecule 1: Mu-like prophage FluMu N-terminal domain-containing protein

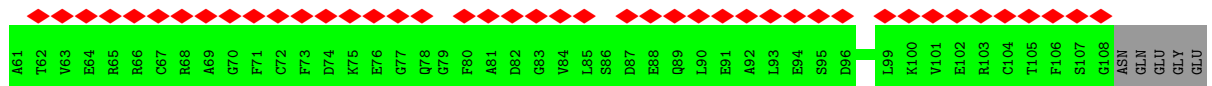
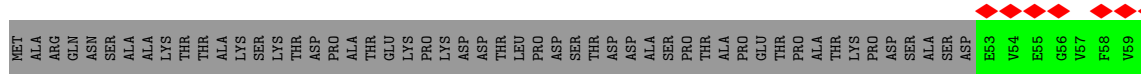
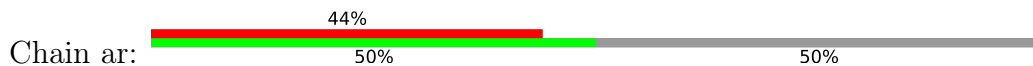

• Molecule 1: Mu-like prophage FluMu N-terminal domain-containing protein

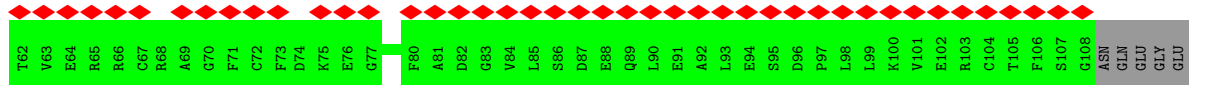
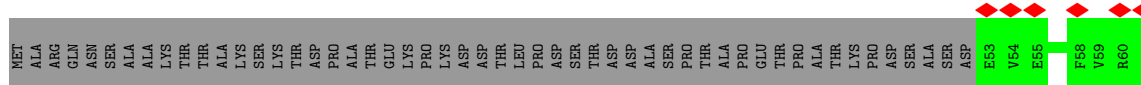
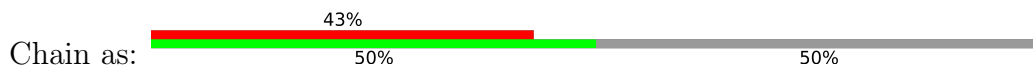

• Molecule 1: Mu-like prophage FluMu N-terminal domain-containing protein

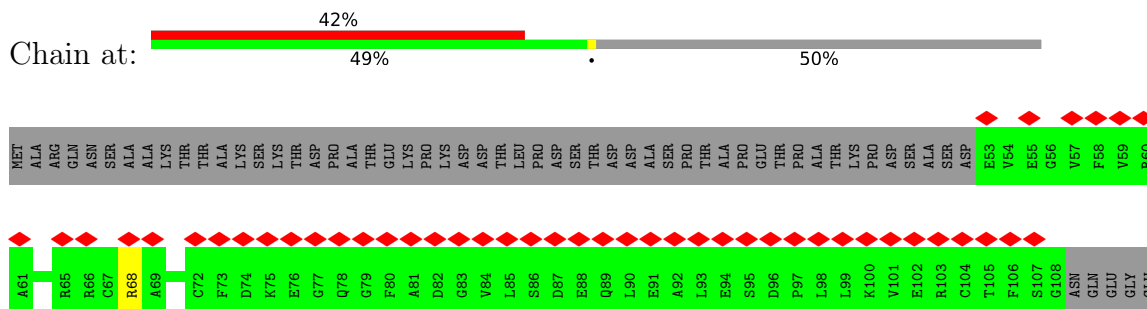

• Molecule 1: Mu-like prophage FluMu N-terminal domain-containing protein

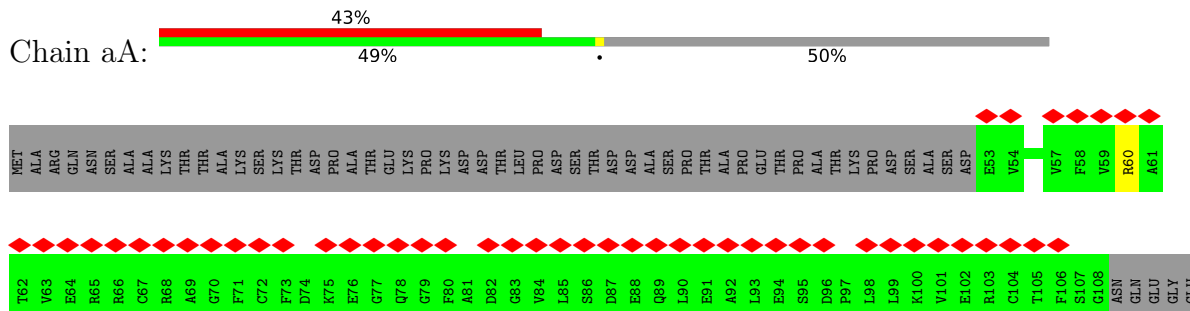

• Molecule 1: Mu-like prophage FluMu N-terminal domain-containing protein

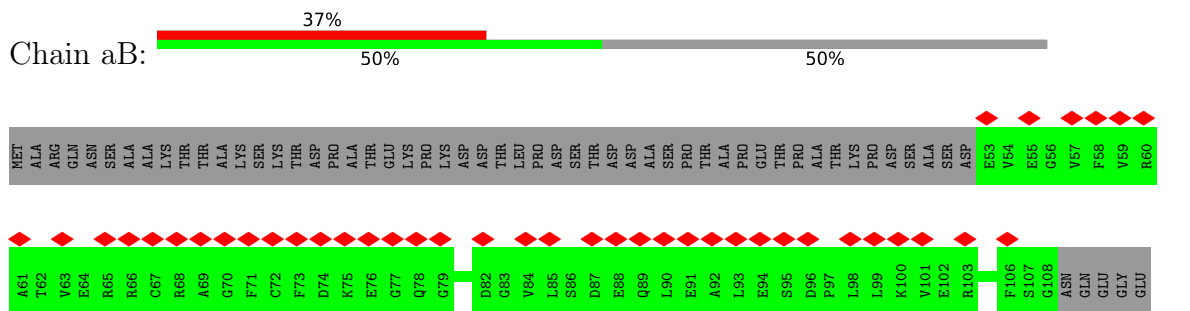

• Molecule 1: Mu-like prophage FluMu N-terminal domain-containing protein

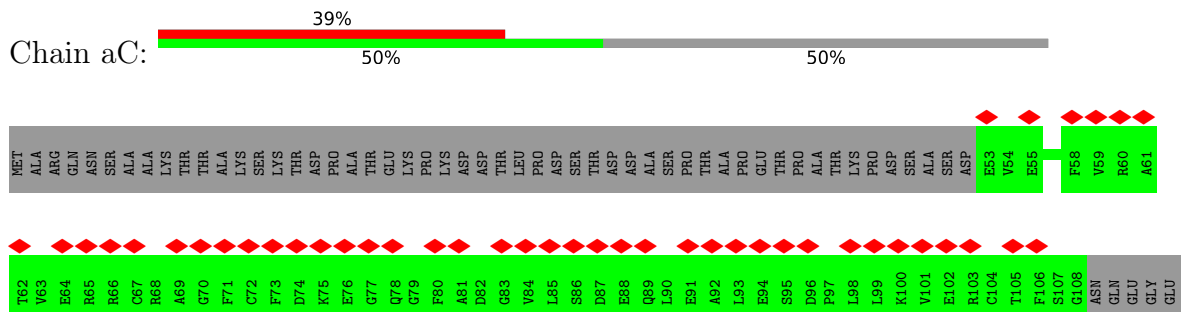

• Molecule 1: Mu-like prophage FluMu N-terminal domain-containing protein

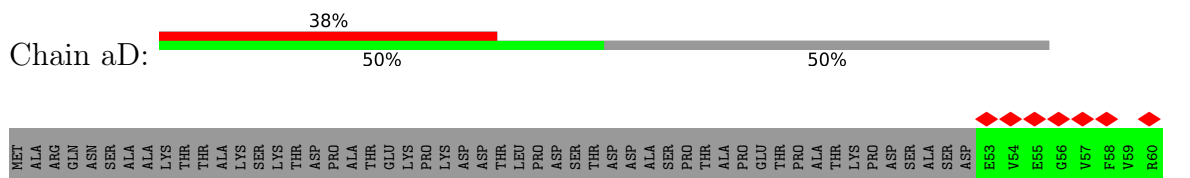

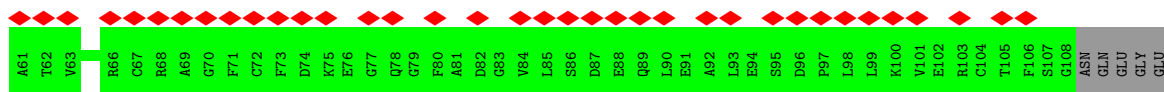

• Molecule 1: Mu-like prophage FluMu N-terminal domain-containing protein

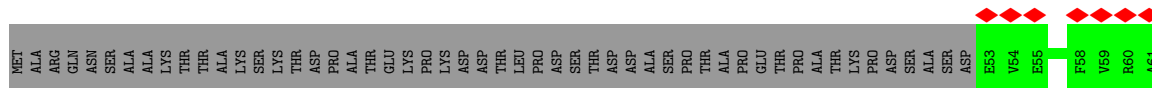

• Molecule 1: Mu-like prophage FluMu N-terminal domain-containing protein

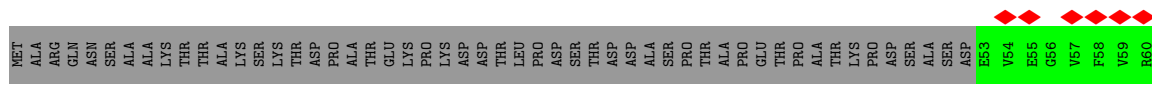
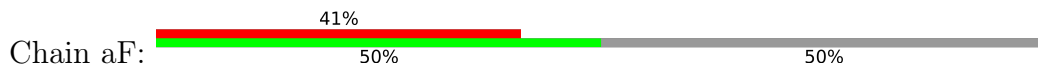

• Molecule 1: Mu-like prophage FluMu N-terminal domain-containing protein

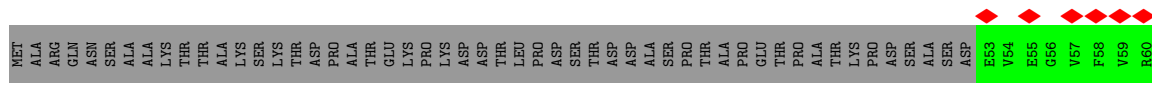
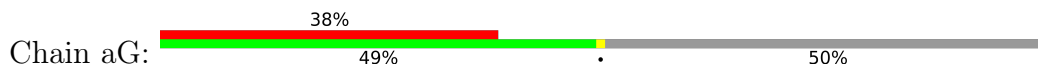

• Molecule 1: Mu-like prophage FluMu N-terminal domain-containing protein

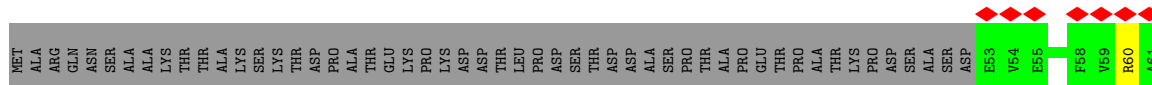
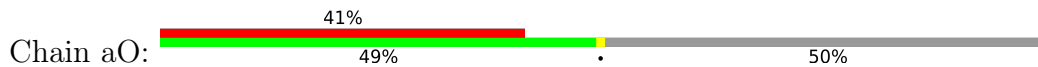

• Molecule 1: Mu-like prophage FluMu N-terminal domain-containing protein

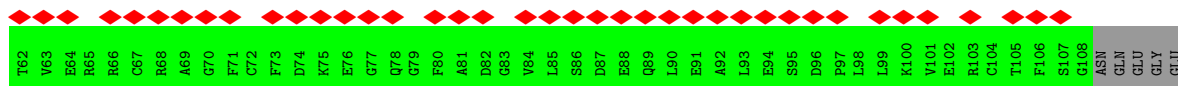

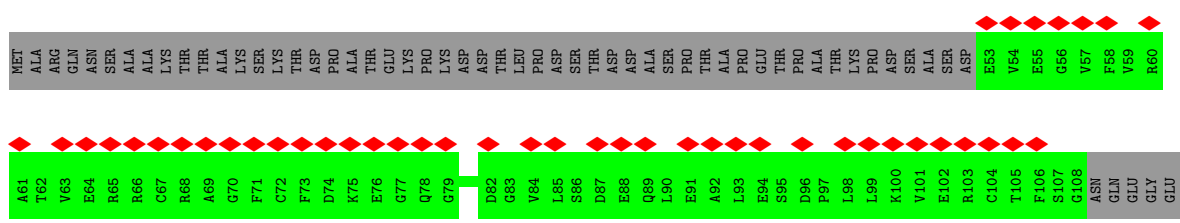

• Molecule 1: Mu-like prophage FluMu N-terminal domain-containing protein

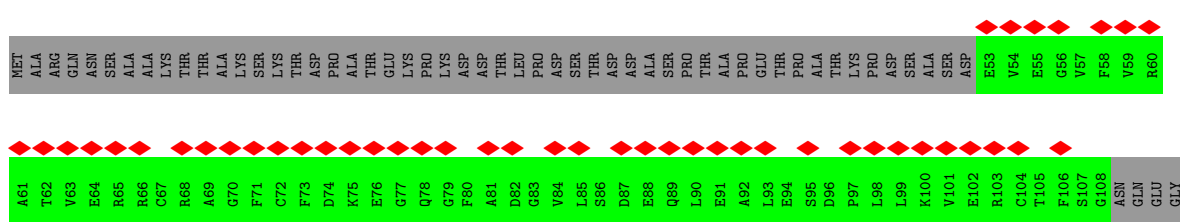
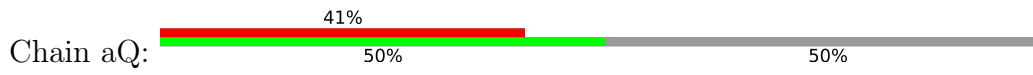

• Molecule 1: Mu-like prophage FluMu N-terminal domain-containing protein

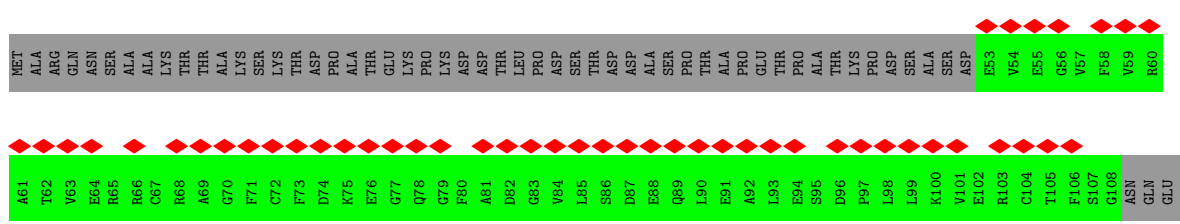
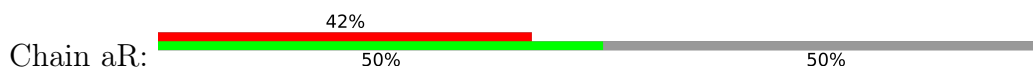

• Molecule 1: Mu-like prophage FluMu N-terminal domain-containing protein

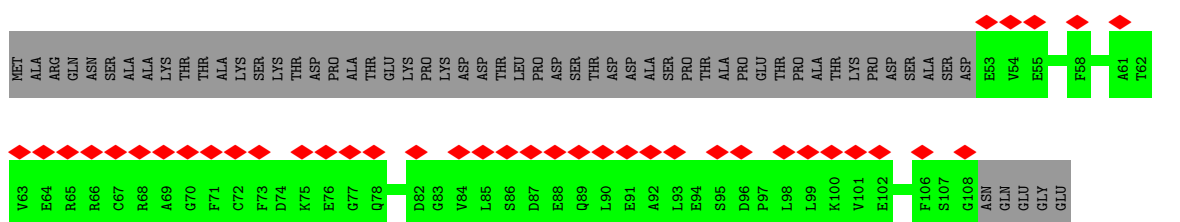

• Molecule 1: Mu-like prophage FluMu N-terminal domain-containing protein

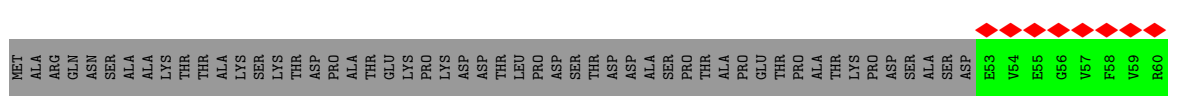

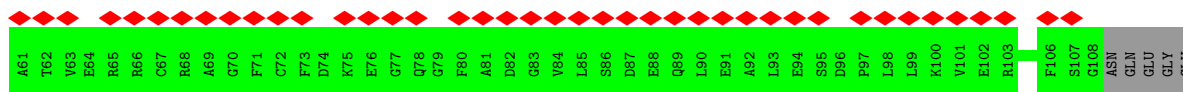

• Molecule 1: Mu-like prophage FluMu N-terminal domain-containing protein

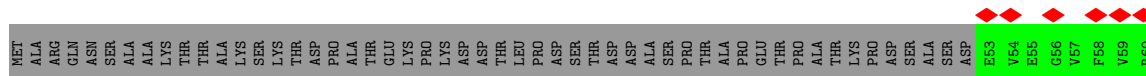

• Molecule 1: Mu-like prophage FluMu N-terminal domain-containing protein

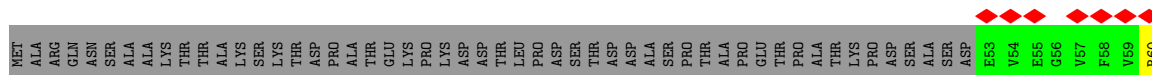
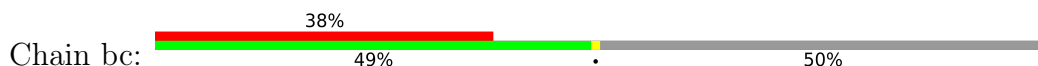

• Molecule 1: Mu-like prophage FluMu N-terminal domain-containing protein

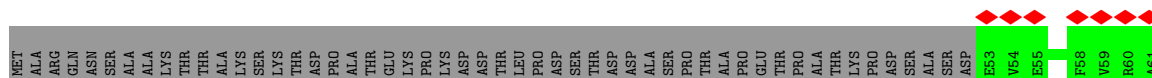

• Molecule 1: Mu-like prophage FluMu N-terminal domain-containing protein

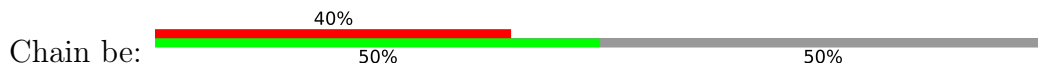

• Molecule 1: Mu-like prophage FluMu N-terminal domain-containing protein

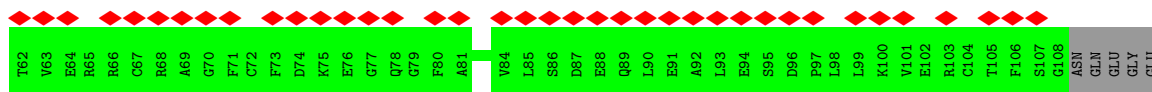

• Molecule 1: Mu-like prophage FluMu N-terminal domain-containing protein

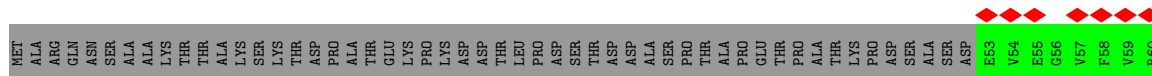
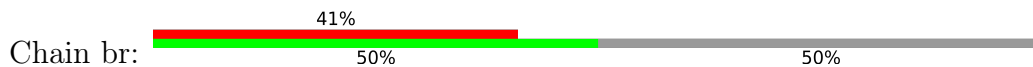

• Molecule 1: Mu-like prophage FluMu N-terminal domain-containing protein

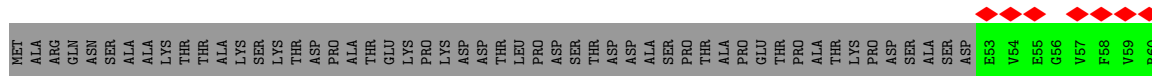
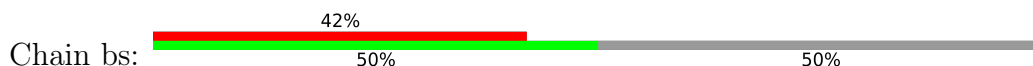

• Molecule 1: Mu-like prophage FluMu N-terminal domain-containing protein

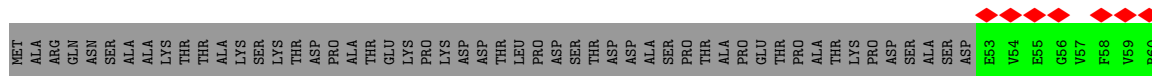
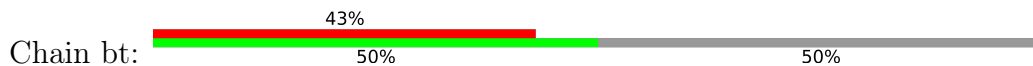

• Molecule 1: Mu-like prophage FluMu N-terminal domain-containing protein

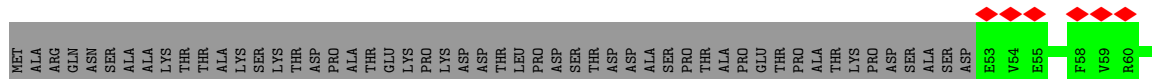
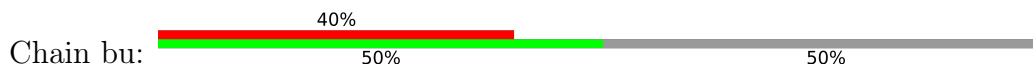

• Molecule 1: Mu-like prophage FluMu N-terminal domain-containing protein

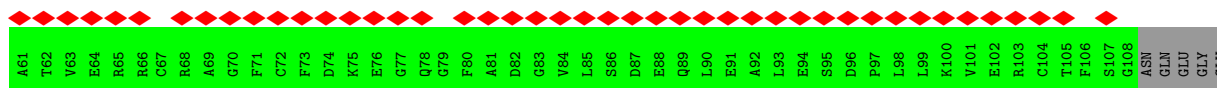

- Molecule 1: Mu-like prophage FluMu N-terminal domain-containing protein

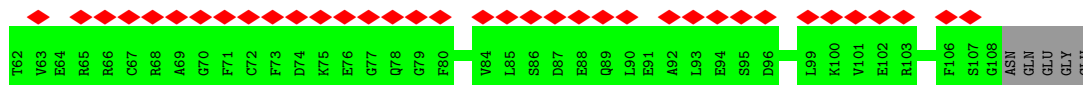
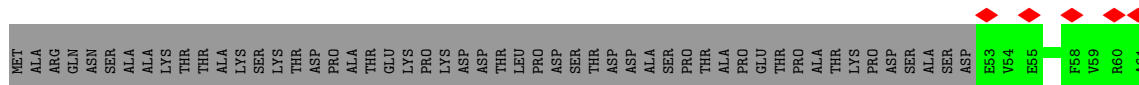

- Molecule 1: Mu-like prophage FluMu N-terminal domain-containing protein

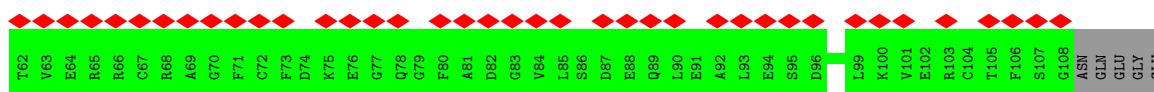
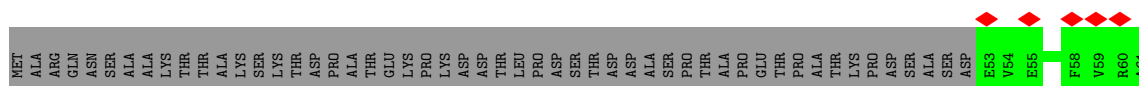
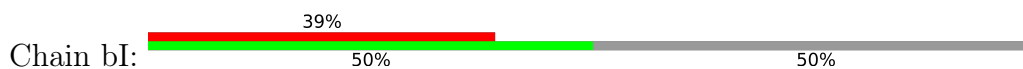

- Molecule 1: Mu-like prophage FluMu N-terminal domain-containing protein

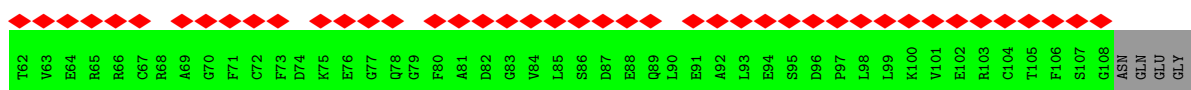
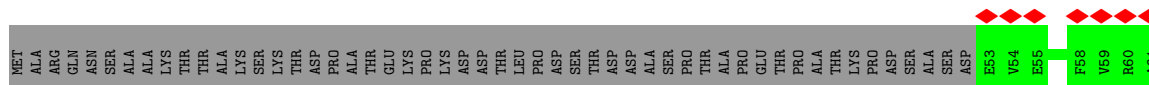
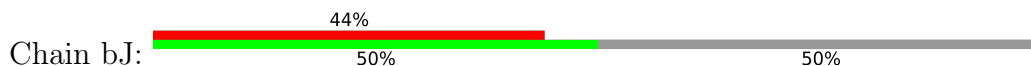

- Molecule 1: Mu-like prophage FluMu N-terminal domain-containing protein

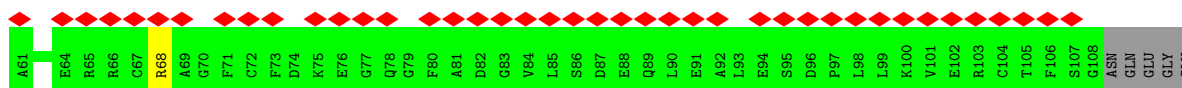
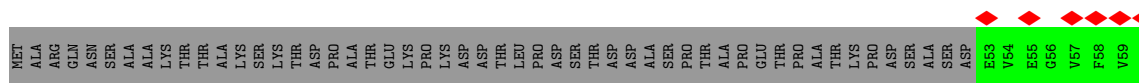
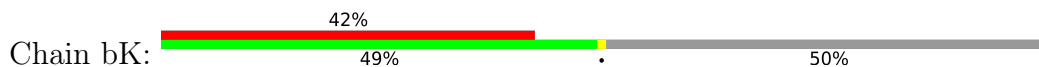

- Molecule 1: Mu-like prophage FluMu N-terminal domain-containing protein

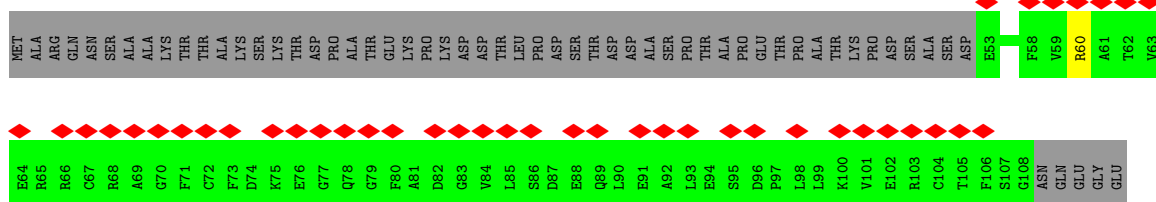

• Molecule 1: Mu-like prophage FluMu N-terminal domain-containing protein

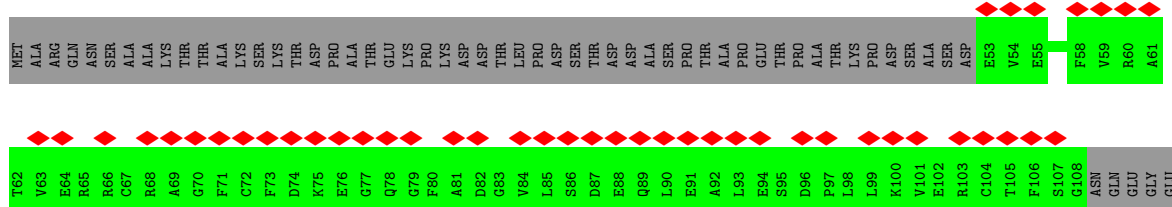
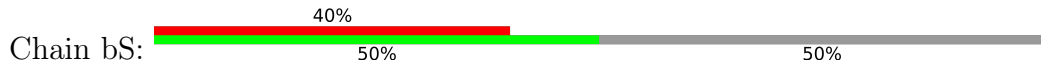

• Molecule 1: Mu-like prophage FluMu N-terminal domain-containing protein

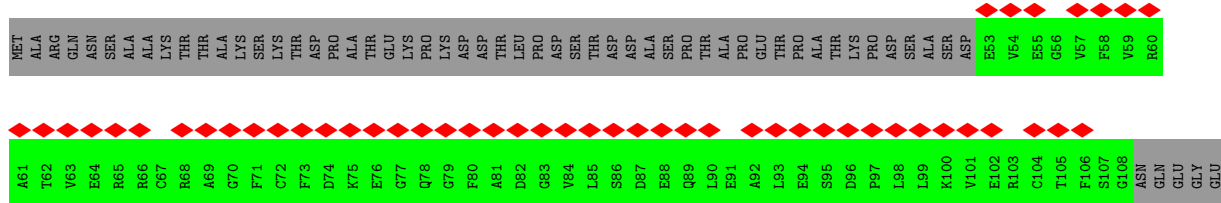

• Molecule 1: Mu-like prophage FluMu N-terminal domain-containing protein

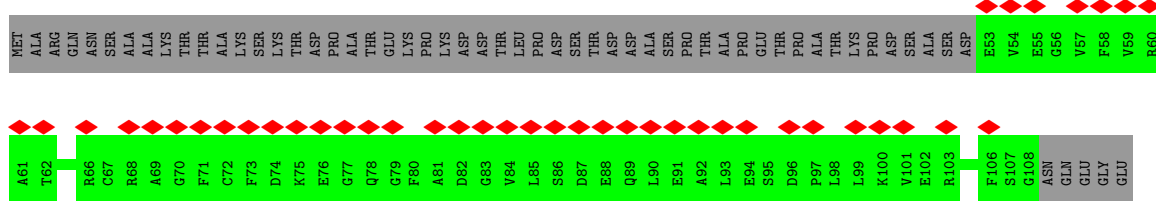

• Molecule 1: Mu-like prophage FluMu N-terminal domain-containing protein

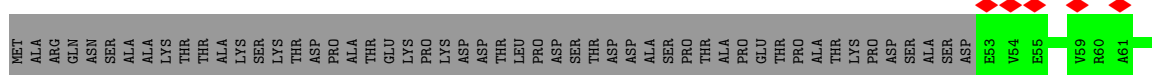

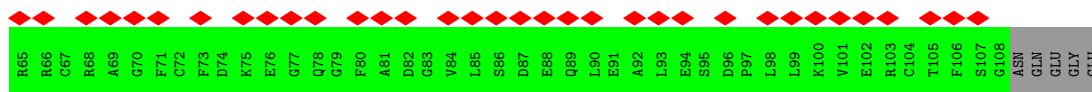

• Molecule 1: Mu-like prophage FluMu N-terminal domain-containing protein

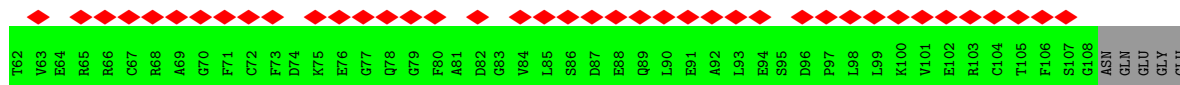
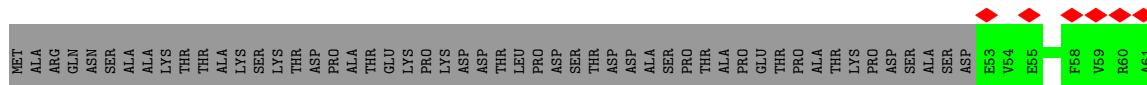
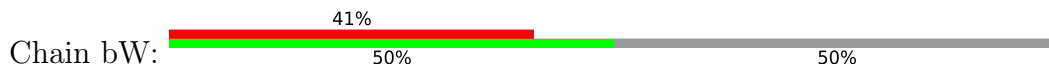

• Molecule 1: Mu-like prophage FluMu N-terminal domain-containing protein

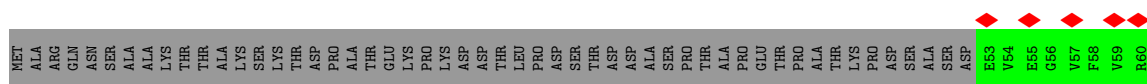
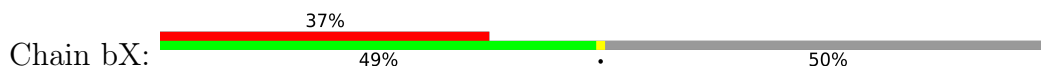

• Molecule 1: Mu-like prophage FluMu N-terminal domain-containing protein

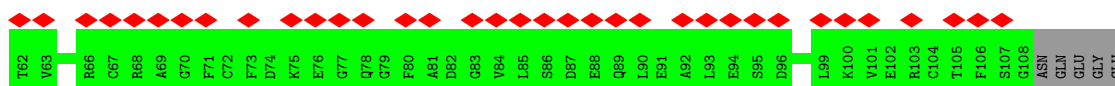
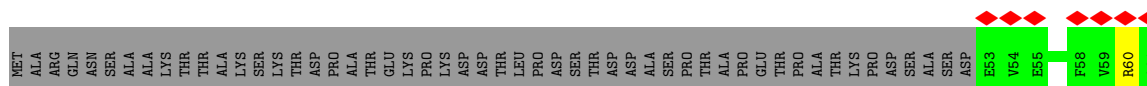

• Molecule 1: Mu-like prophage FluMu N-terminal domain-containing protein

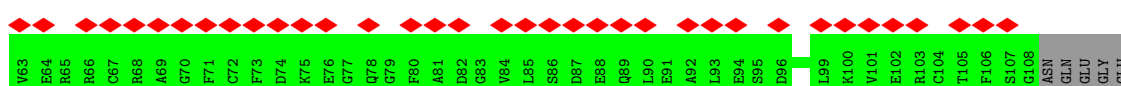
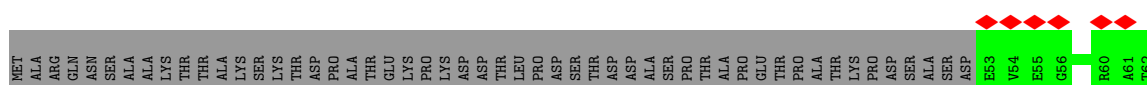

• Molecule 1: Mu-like prophage FluMu N-terminal domain-containing protein

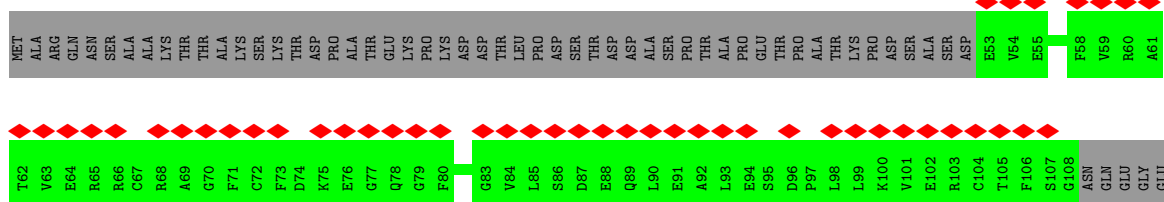
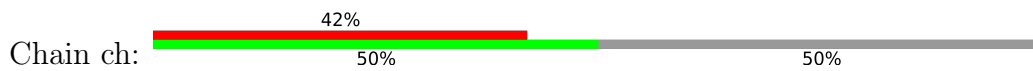

• Molecule 1: Mu-like prophage FluMu N-terminal domain-containing protein

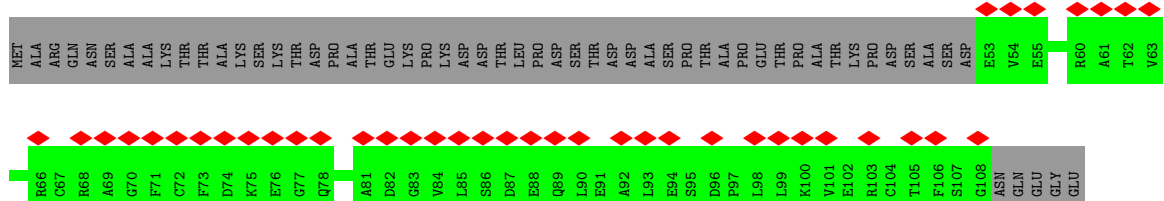

• Molecule 1: Mu-like prophage FluMu N-terminal domain-containing protein

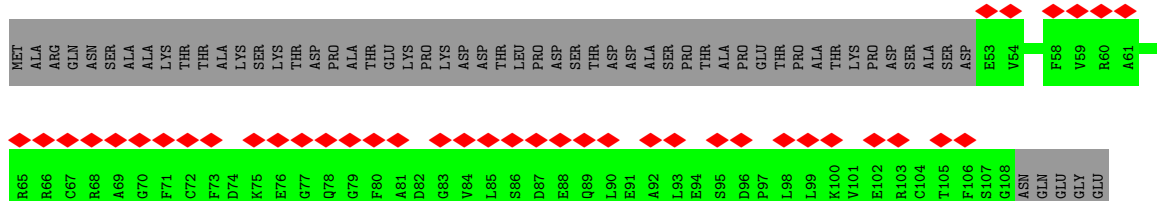

• Molecule 1: Mu-like prophage FluMu N-terminal domain-containing protein

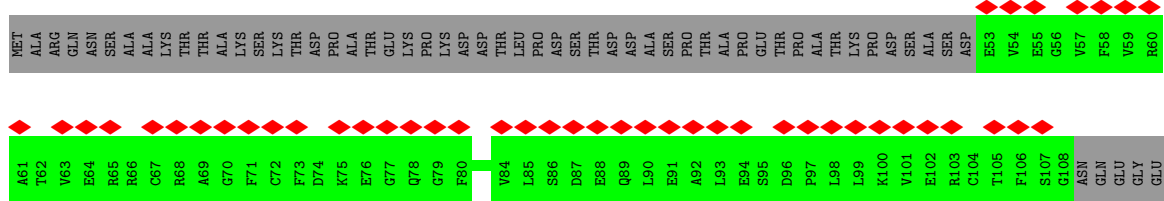
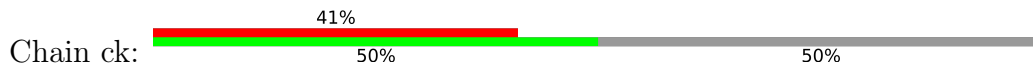

• Molecule 1: Mu-like prophage FluMu N-terminal domain-containing protein

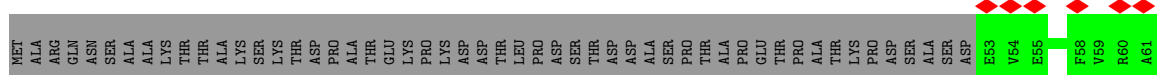



• Molecule 1: Mu-like prophage FluMu N-terminal domain-containing protein

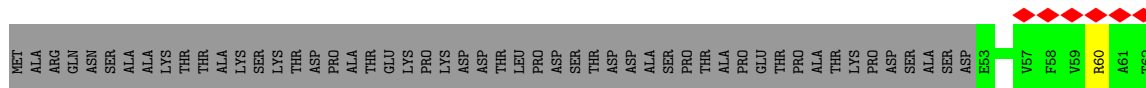

• Molecule 1: Mu-like prophage FluMu N-terminal domain-containing protein

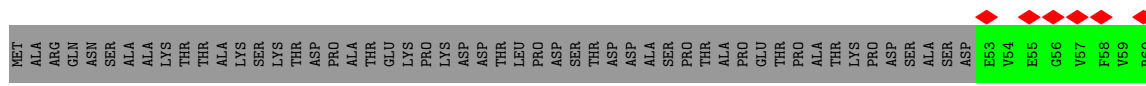
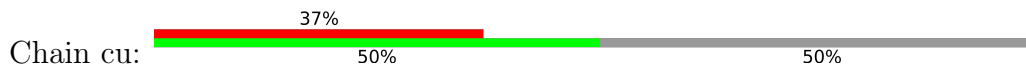

• Molecule 1: Mu-like prophage FluMu N-terminal domain-containing protein

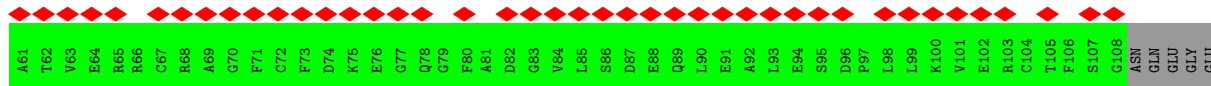
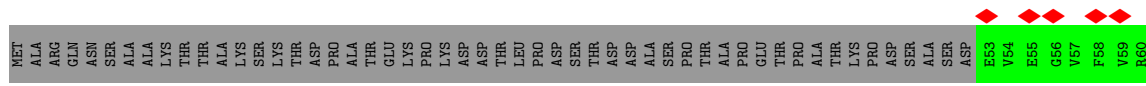
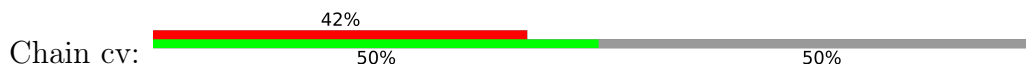

• Molecule 1: Mu-like prophage FluMu N-terminal domain-containing protein

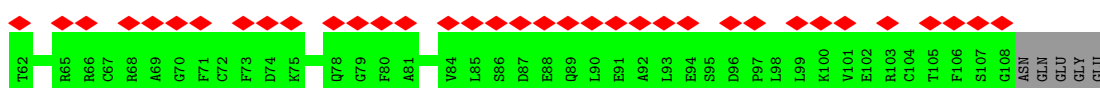
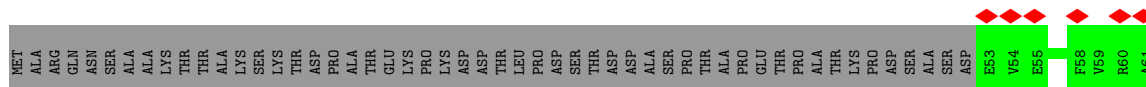
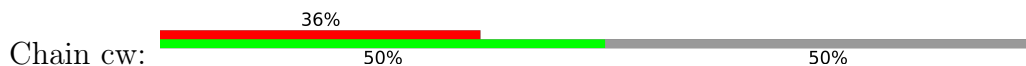

• Molecule 1: Mu-like prophage FluMu N-terminal domain-containing protein



- Molecule 1: Mu-like prophage FluMu N-terminal domain-containing protein

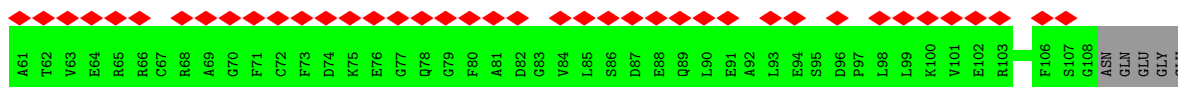
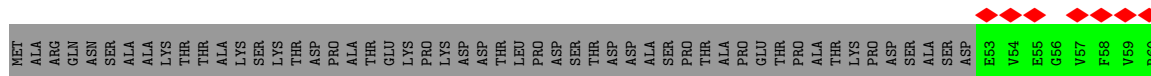
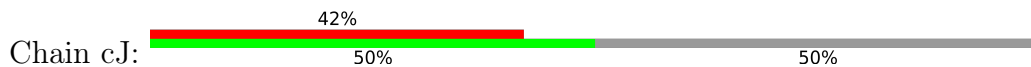

- Molecule 1: Mu-like prophage FluMu N-terminal domain-containing protein

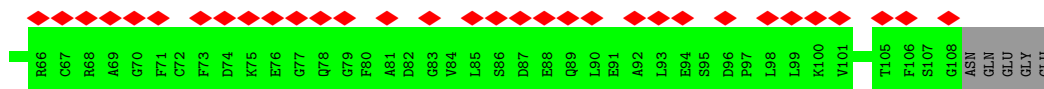
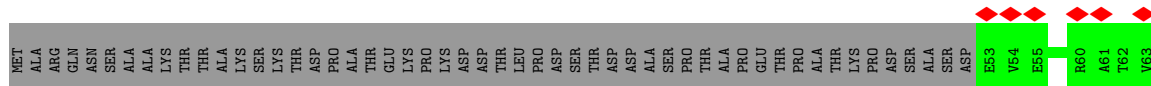

- Molecule 1: Mu-like prophage FluMu N-terminal domain-containing protein

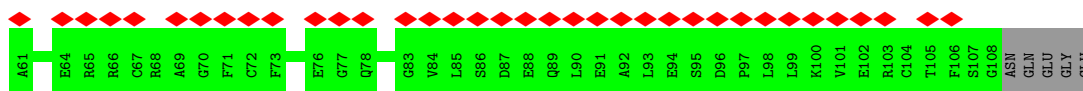
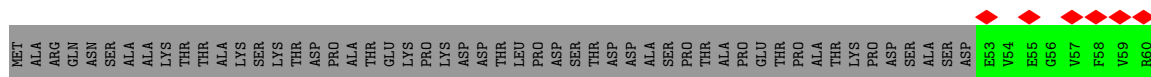

- Molecule 1: Mu-like prophage FluMu N-terminal domain-containing protein

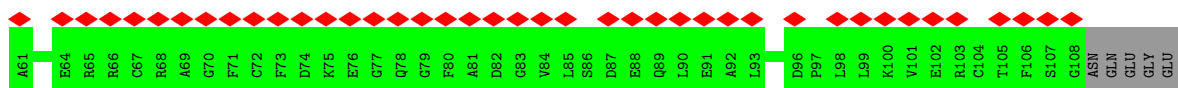
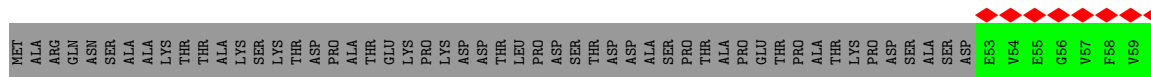
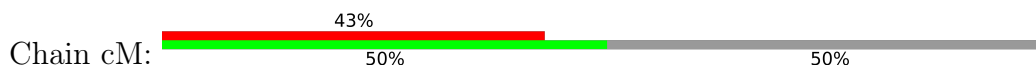

- Molecule 1: Mu-like prophage FluMu N-terminal domain-containing protein

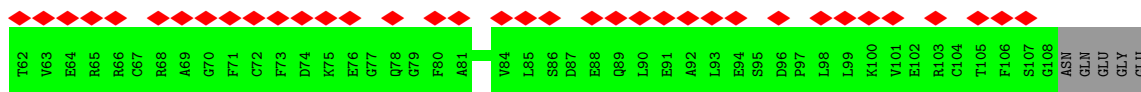

• Molecule 1: Mu-like prophage FluMu N-terminal domain-containing protein

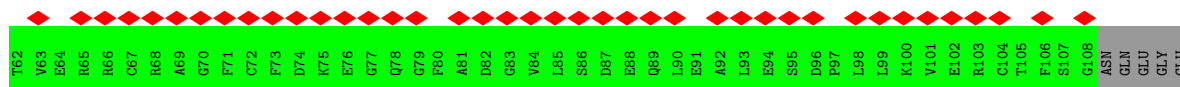
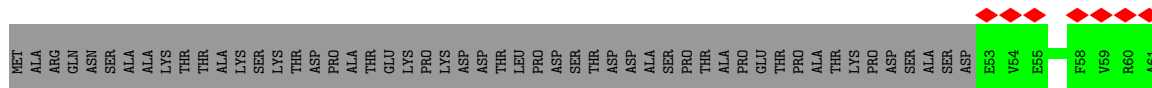
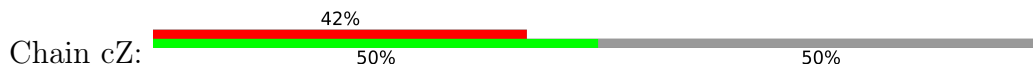

• Molecule 1: Mu-like prophage FluMu N-terminal domain-containing protein

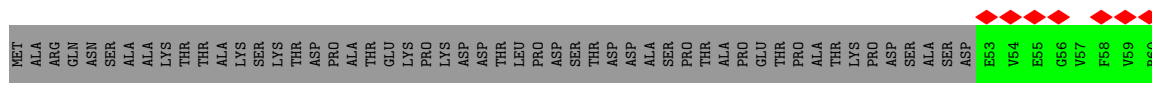

• Molecule 1: Mu-like prophage FluMu N-terminal domain-containing protein

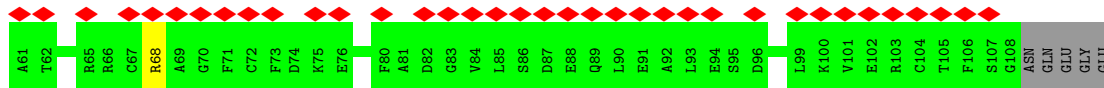
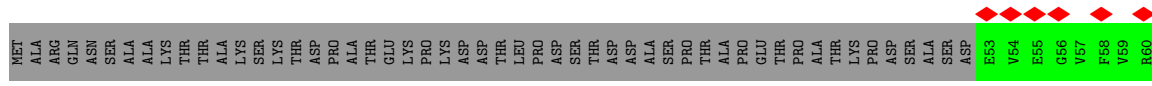
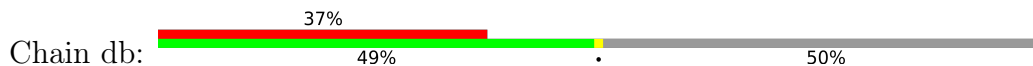

• Molecule 1: Mu-like prophage FluMu N-terminal domain-containing protein

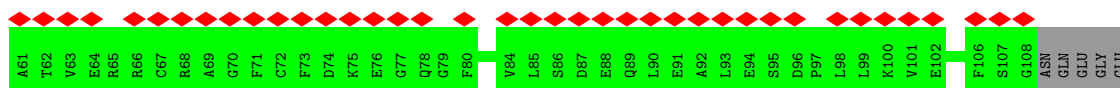
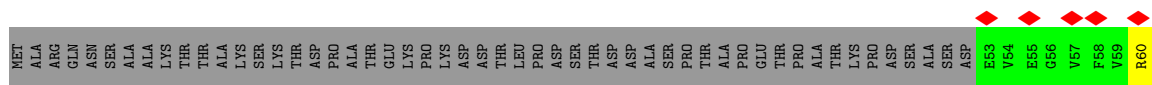
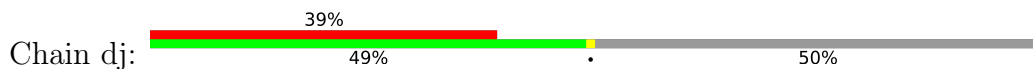

• Molecule 1: Mu-like prophage FluMu N-terminal domain-containing protein

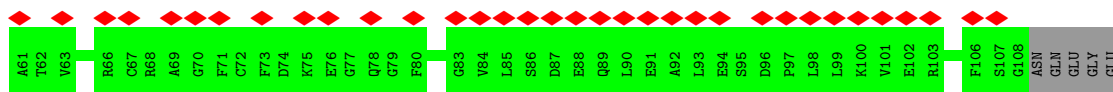

- Molecule 1: Mu-like prophage FluMu N-terminal domain-containing protein

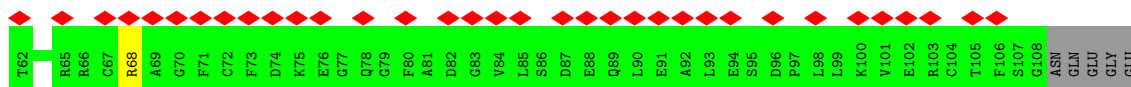
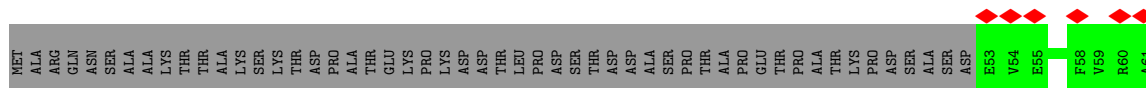

- Molecule 1: Mu-like prophage FluMu N-terminal domain-containing protein

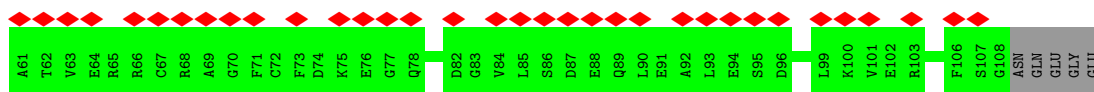
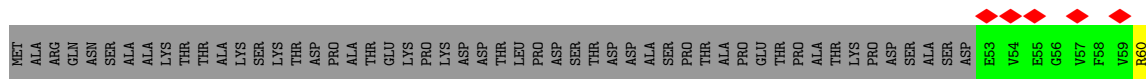

- Molecule 1: Mu-like prophage FluMu N-terminal domain-containing protein

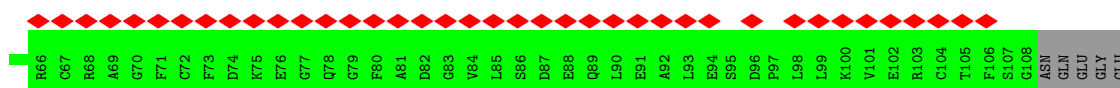
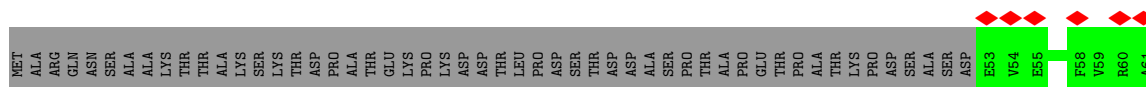
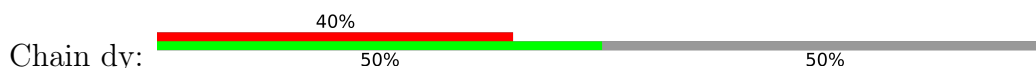

- Molecule 1: Mu-like prophage FluMu N-terminal domain-containing protein

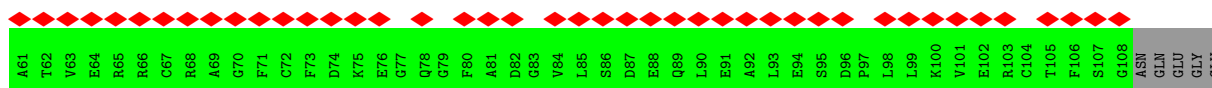
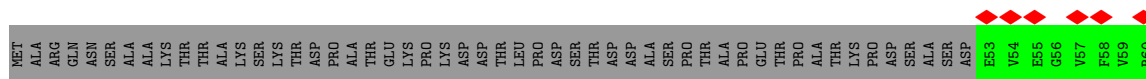
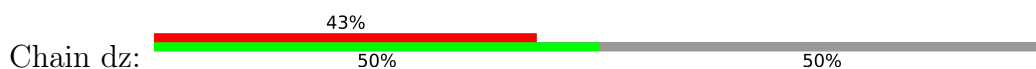

- Molecule 1: Mu-like prophage FluMu N-terminal domain-containing protein

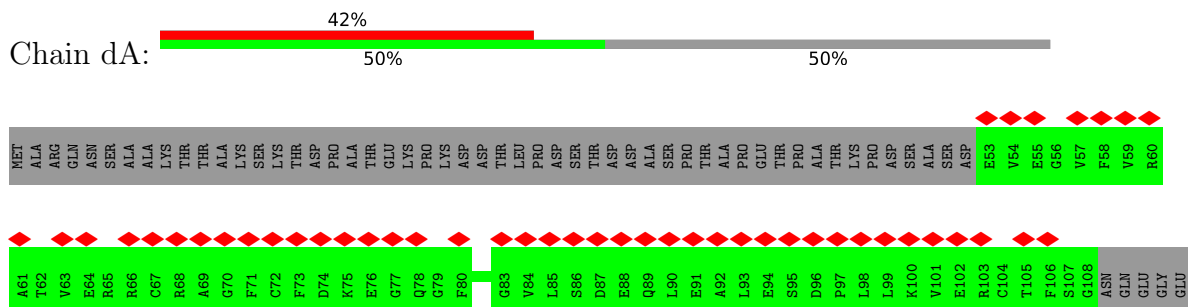

• Molecule 1: Mu-like prophage FluMu N-terminal domain-containing protein

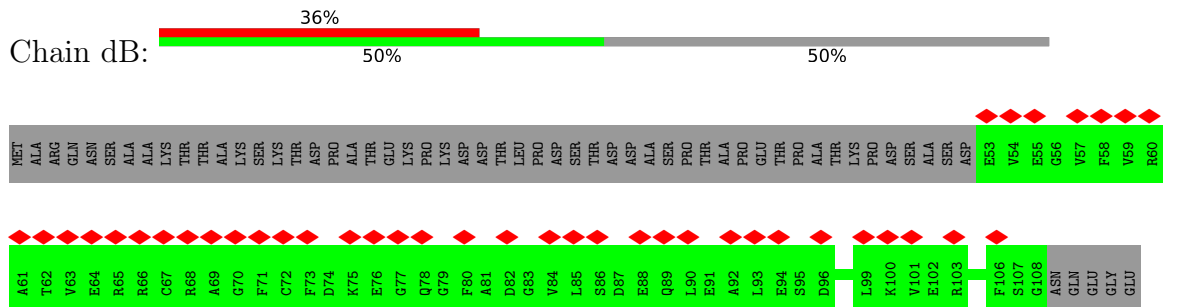

• Molecule 1: Mu-like prophage FluMu N-terminal domain-containing protein

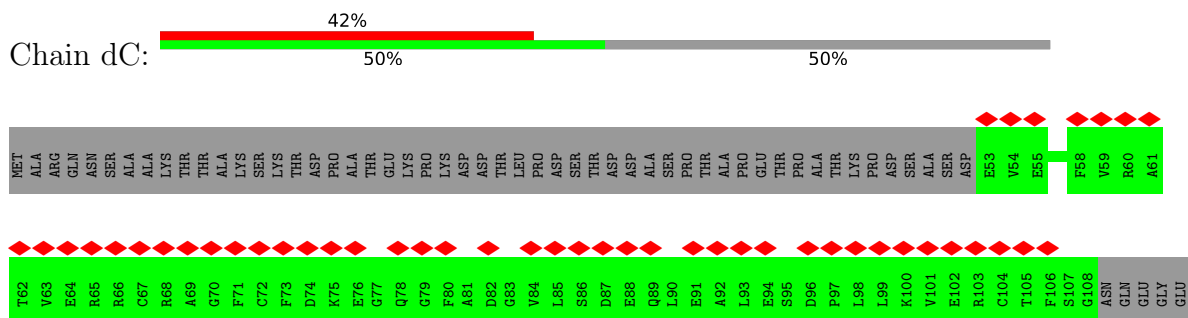

• Molecule 1: Mu-like prophage FluMu N-terminal domain-containing protein

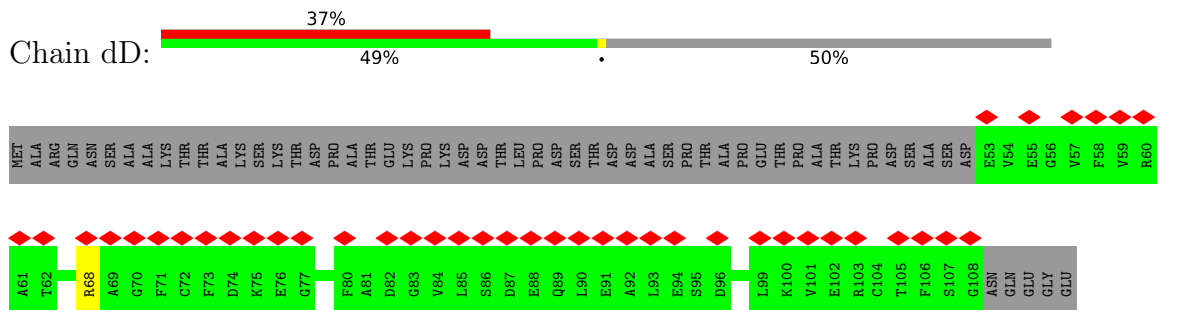

• Molecule 1: Mu-like prophage FluMu N-terminal domain-containing protein

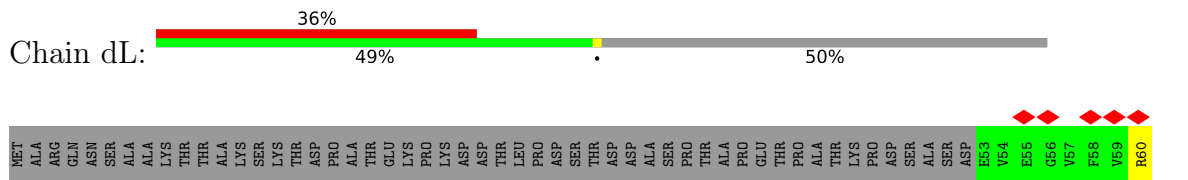

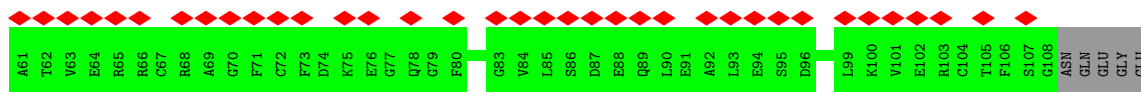

• Molecule 1: Mu-like prophage FluMu N-terminal domain-containing protein

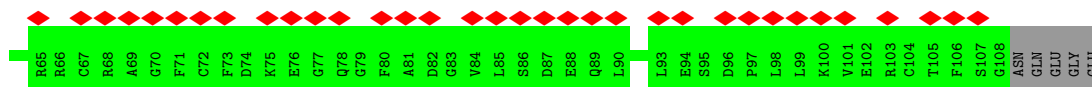
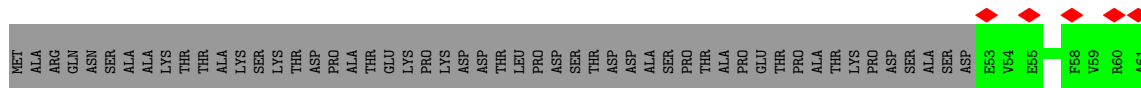

• Molecule 1: Mu-like prophage FluMu N-terminal domain-containing protein

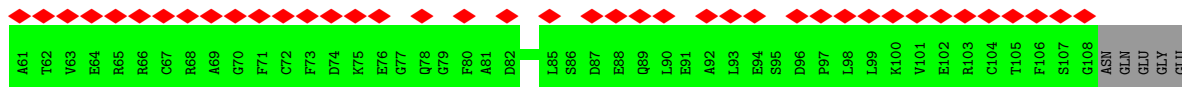
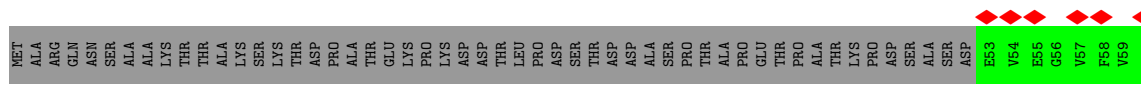
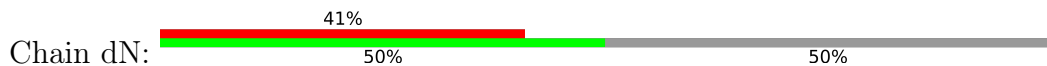

• Molecule 1: Mu-like prophage FluMu N-terminal domain-containing protein

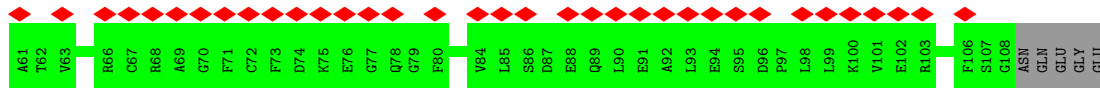
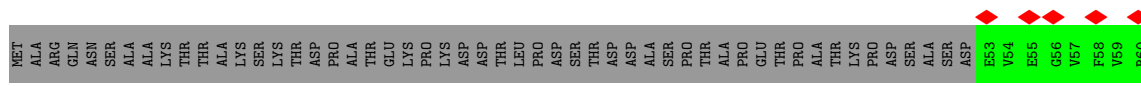

• Molecule 1: Mu-like prophage FluMu N-terminal domain-containing protein

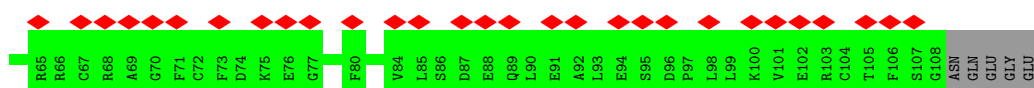
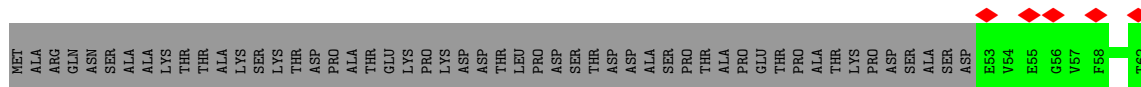

• Molecule 1: Mu-like prophage FluMu N-terminal domain-containing protein

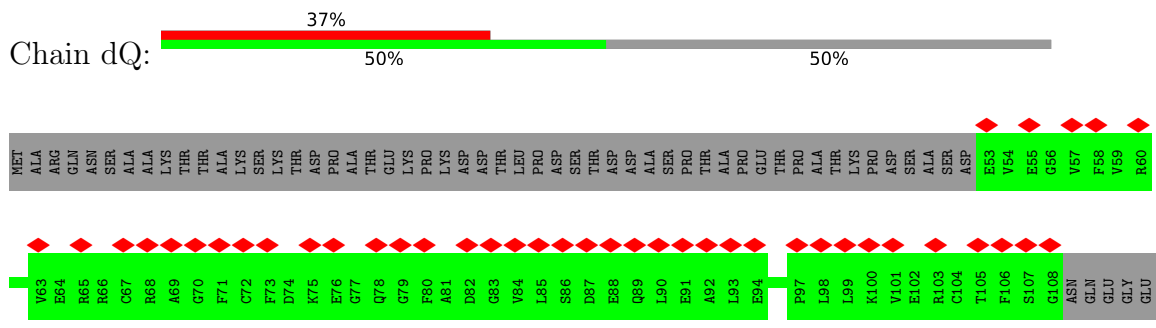

• Molecule 1: Mu-like prophage FluMu N-terminal domain-containing protein



• Molecule 1: Mu-like prophage FluMu N-terminal domain-containing protein

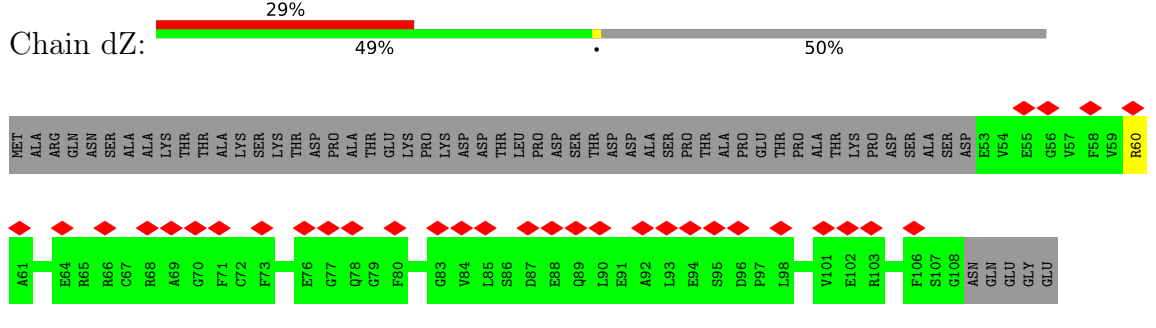

• Molecule 1: Mu-like prophage FluMu N-terminal domain-containing protein

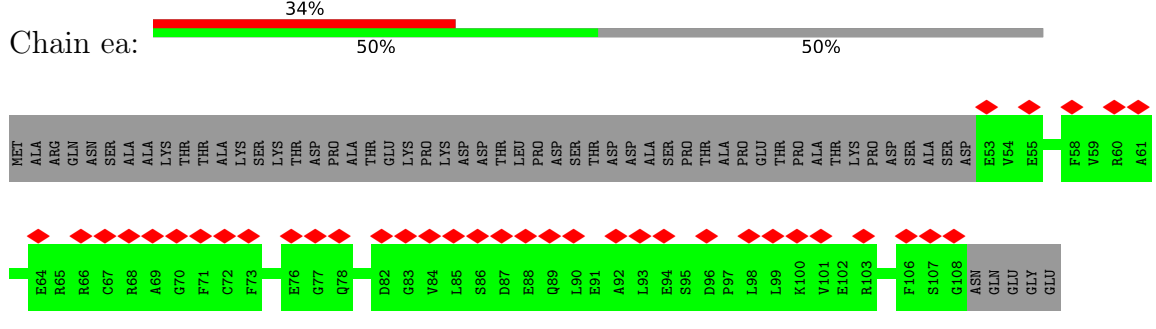

• Molecule 1: Mu-like prophage FluMu N-terminal domain-containing protein

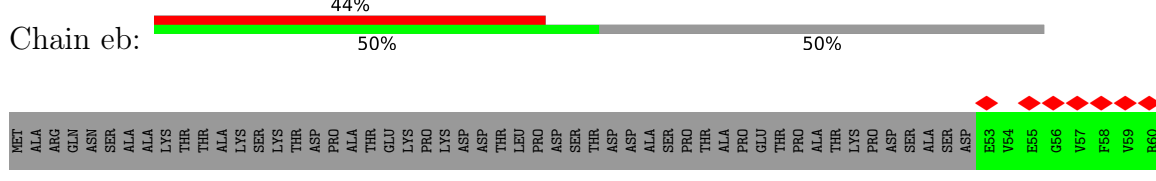

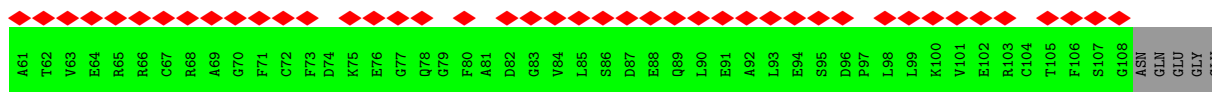

• Molecule 1: Mu-like prophage FluMu N-terminal domain-containing protein

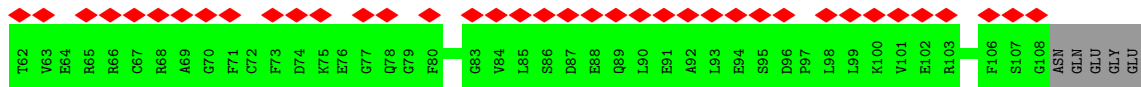
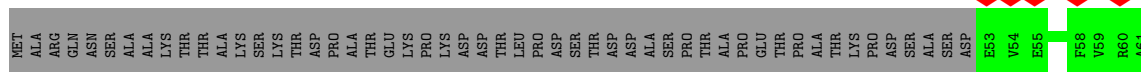
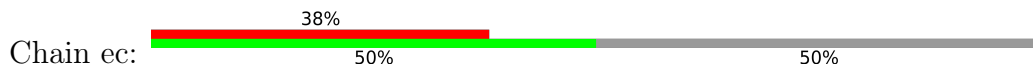

• Molecule 1: Mu-like prophage FluMu N-terminal domain-containing protein

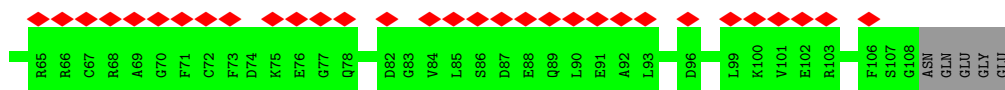
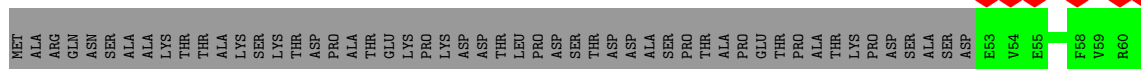

• Molecule 1: Mu-like prophage FluMu N-terminal domain-containing protein

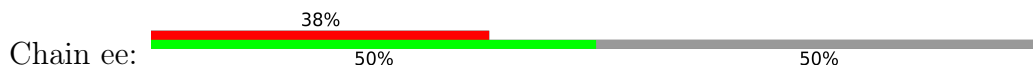

• Molecule 1: Mu-like prophage FluMu N-terminal domain-containing protein

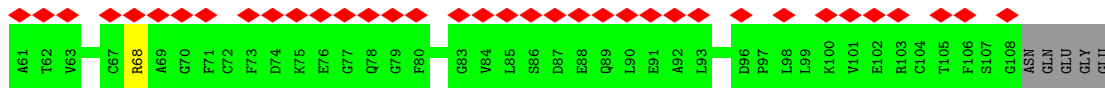
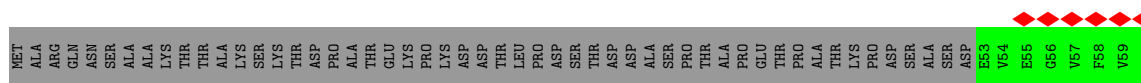

• Molecule 1: Mu-like prophage FluMu N-terminal domain-containing protein

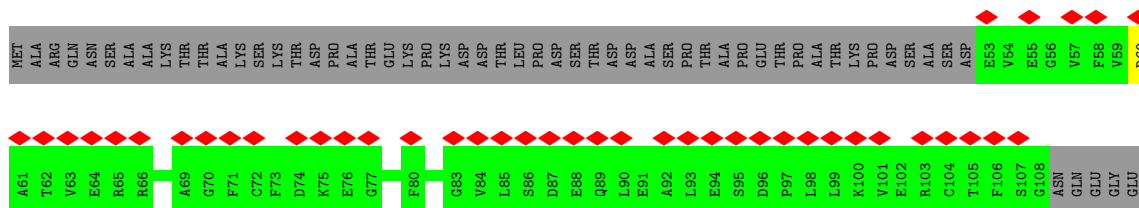

- Molecule 1: Mu-like prophage FluMu N-terminal domain-containing protein

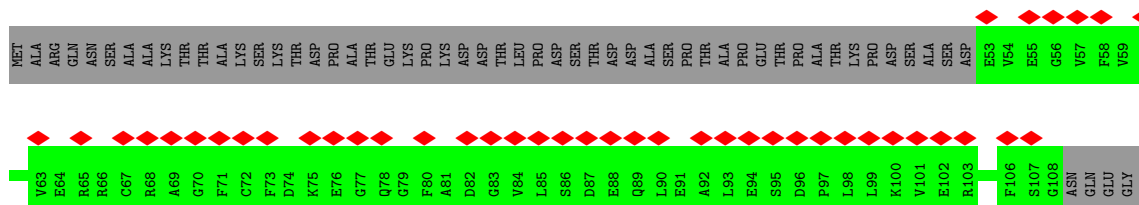
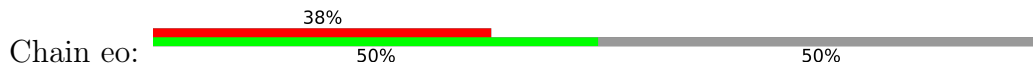

- Molecule 1: Mu-like prophage FluMu N-terminal domain-containing protein

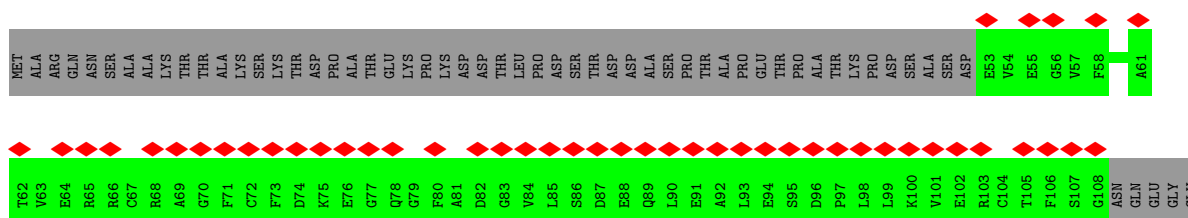
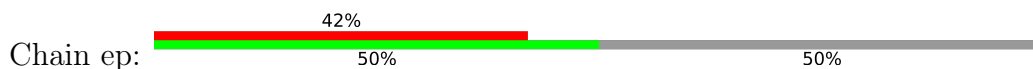

- Molecule 1: Mu-like prophage FluMu N-terminal domain-containing protein

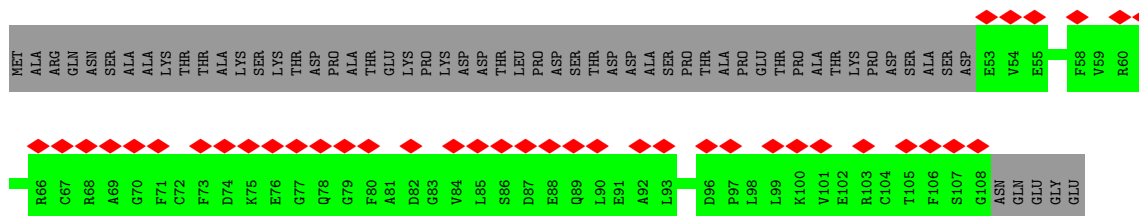

- Molecule 1: Mu-like prophage FluMu N-terminal domain-containing protein



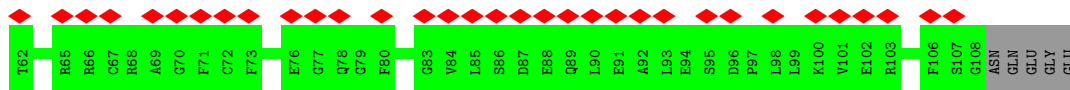

• Molecule 1: Mu-like prophage FluMu N-terminal domain-containing protein

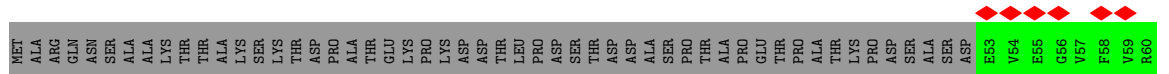
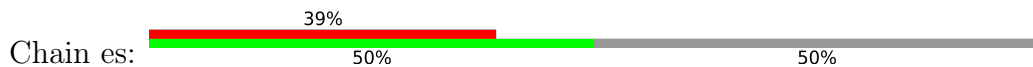

• Molecule 1: Mu-like prophage FluMu N-terminal domain-containing protein



• Molecule 1: Mu-like prophage FluMu N-terminal domain-containing protein



• Molecule 1: Mu-like prophage FluMu N-terminal domain-containing protein

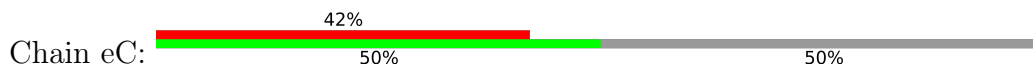

• Molecule 1: Mu-like prophage FluMu N-terminal domain-containing protein



• Molecule 1: Mu-like prophage FluMu N-terminal domain-containing protein



• Molecule 1: Mu-like prophage FluMu N-terminal domain-containing protein

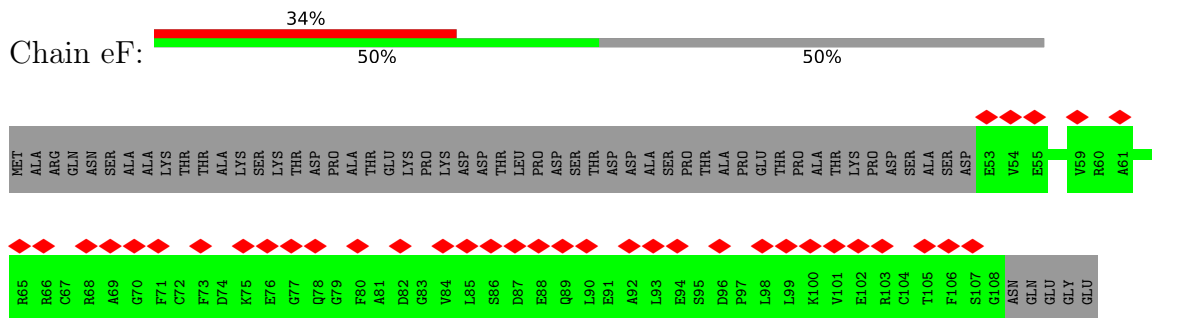

• Molecule 1: Mu-like prophage FluMu N-terminal domain-containing protein

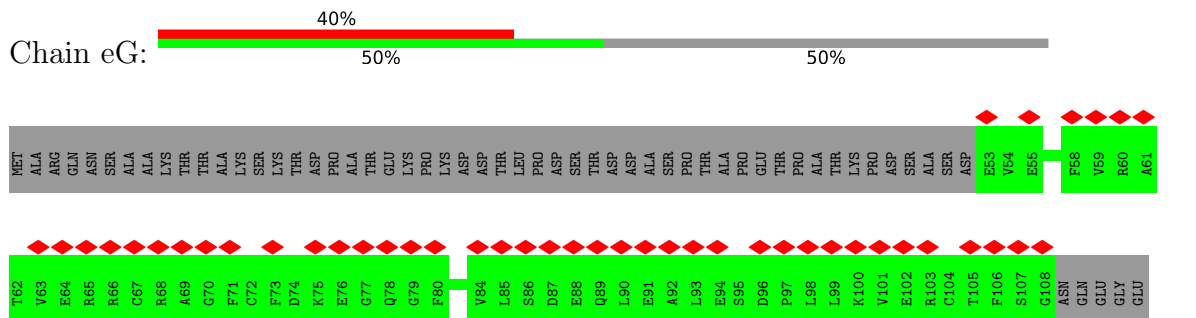

• Molecule 1: Mu-like prophage FluMu N-terminal domain-containing protein

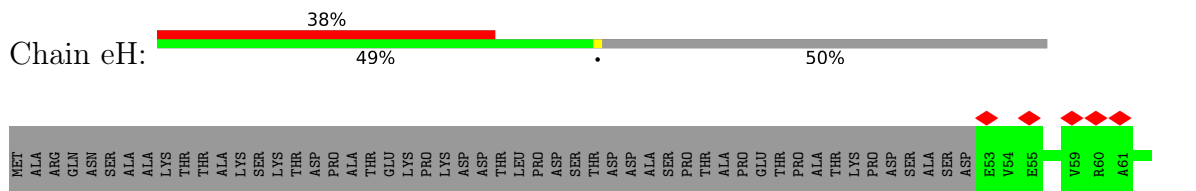

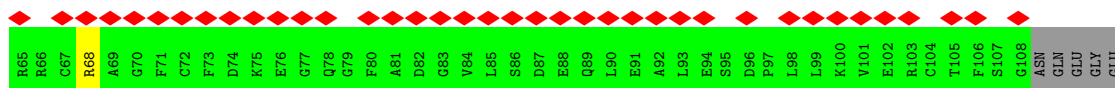

- Molecule 1: Mu-like prophage FluMu N-terminal domain-containing protein

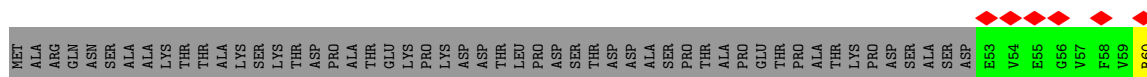
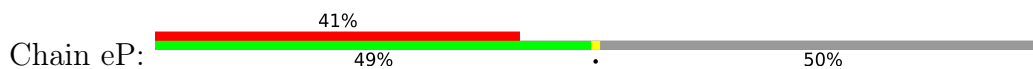

- Molecule 1: Mu-like prophage FluMu N-terminal domain-containing protein

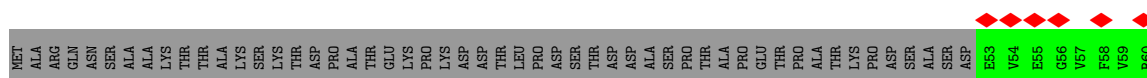
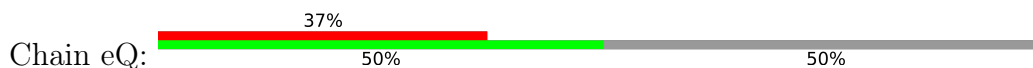

- Molecule 1: Mu-like prophage FluMu N-terminal domain-containing protein

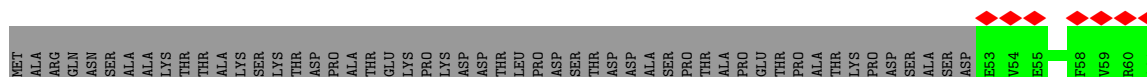
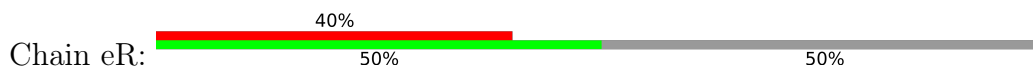

- Molecule 1: Mu-like prophage FluMu N-terminal domain-containing protein

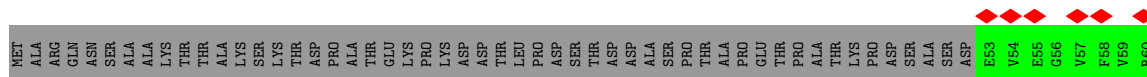
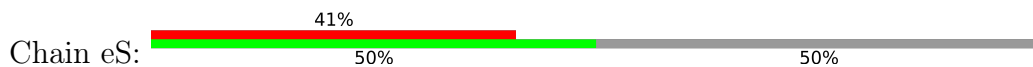

- Molecule 1: Mu-like prophage FluMu N-terminal domain-containing protein

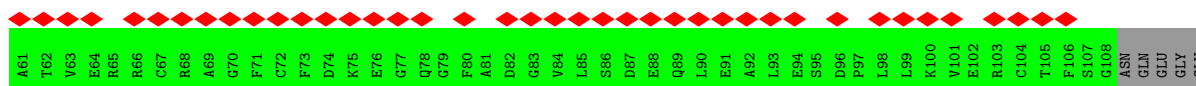

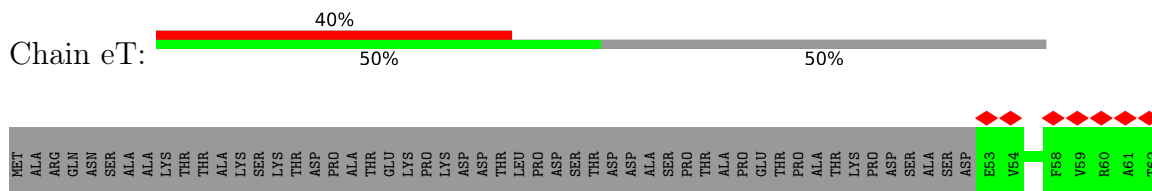

• Molecule 1: Mu-like prophage FluMu N-terminal domain-containing protein

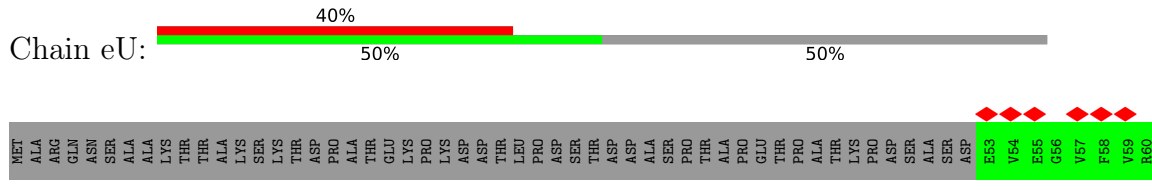

• Molecule 1: Mu-like prophage FluMu N-terminal domain-containing protein

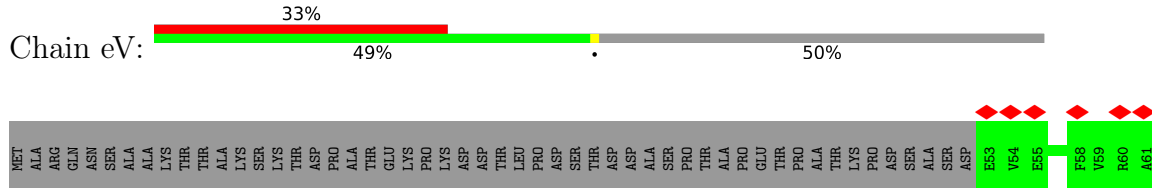

• Molecule 1: Mu-like prophage FluMu N-terminal domain-containing protein

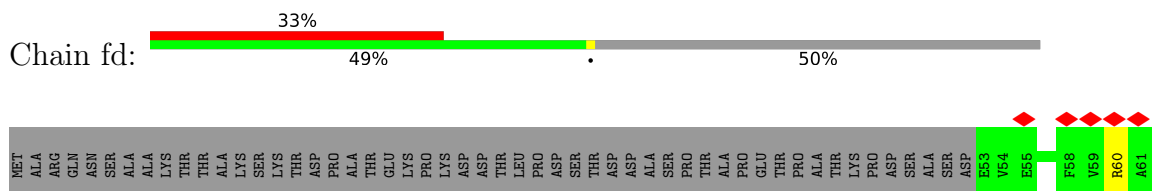

• Molecule 1: Mu-like prophage FluMu N-terminal domain-containing protein

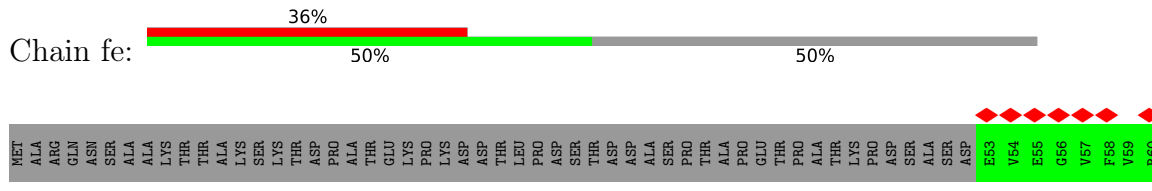

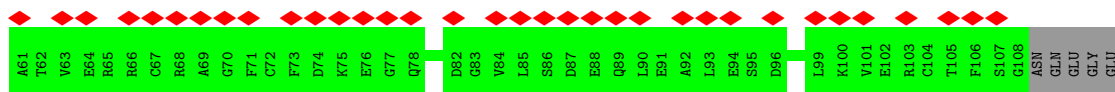

• Molecule 1: Mu-like prophage FluMu N-terminal domain-containing protein

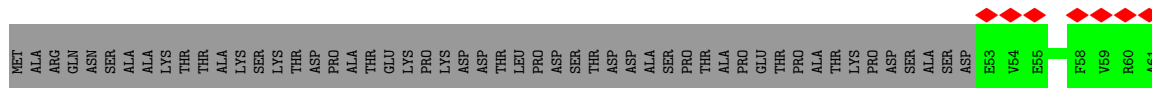
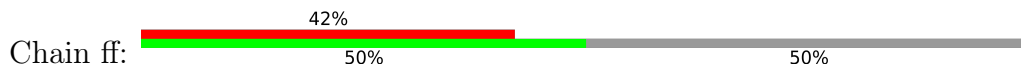

• Molecule 1: Mu-like prophage FluMu N-terminal domain-containing protein

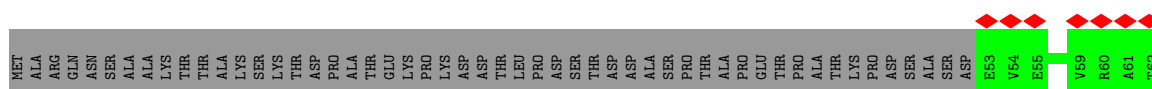

• Molecule 1: Mu-like prophage FluMu N-terminal domain-containing protein

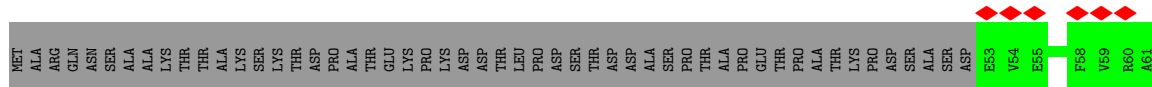
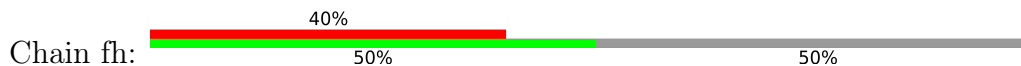

• Molecule 1: Mu-like prophage FluMu N-terminal domain-containing protein

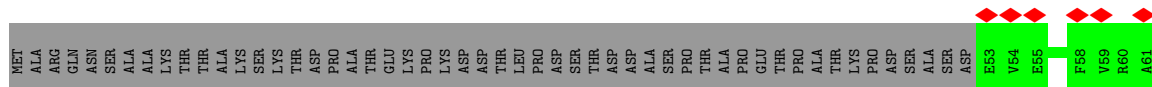
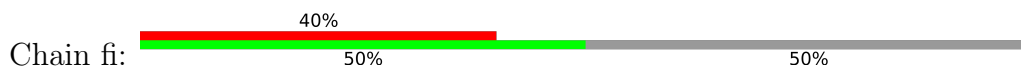

• Molecule 1: Mu-like prophage FluMu N-terminal domain-containing protein



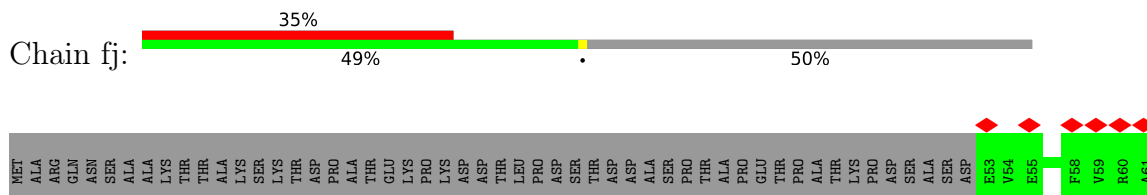

• Molecule 1: Mu-like prophage FluMu N-terminal domain-containing protein

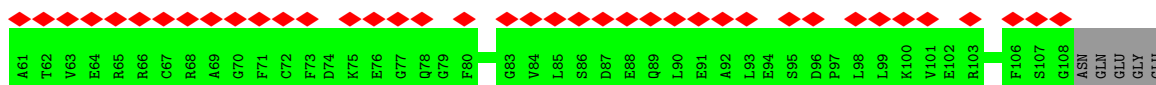
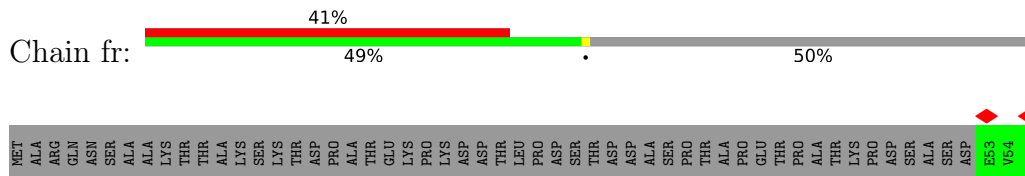

• Molecule 1: Mu-like prophage FluMu N-terminal domain-containing protein

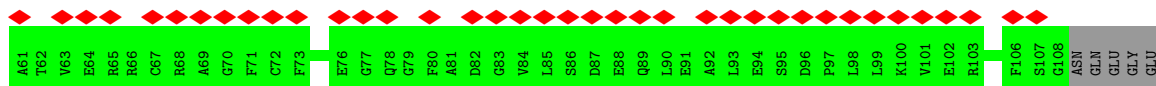
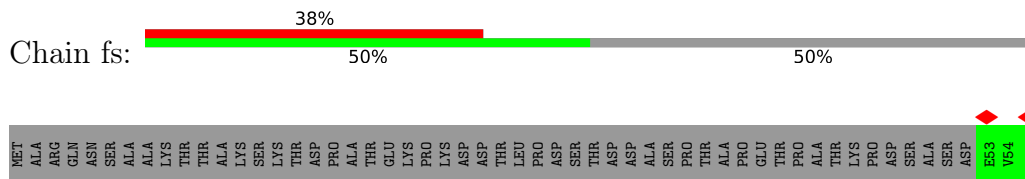

• Molecule 1: Mu-like prophage FluMu N-terminal domain-containing protein

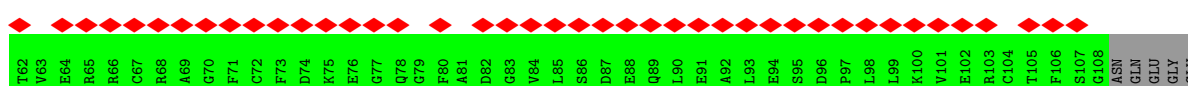
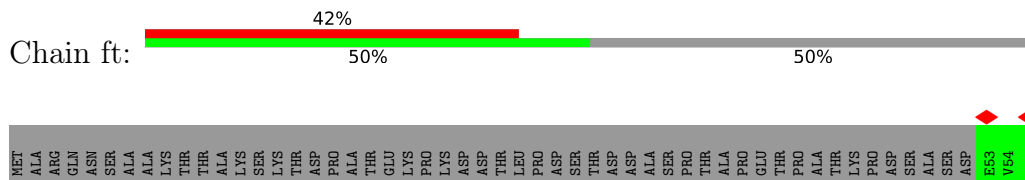

• Molecule 1: Mu-like prophage FluMu N-terminal domain-containing protein

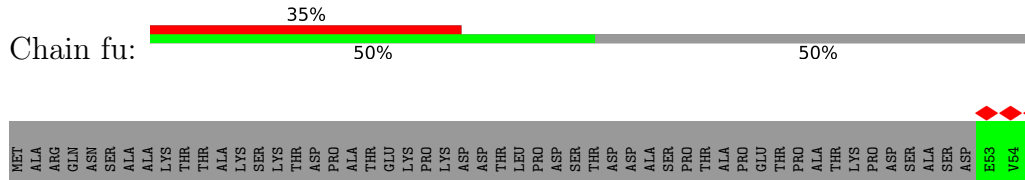

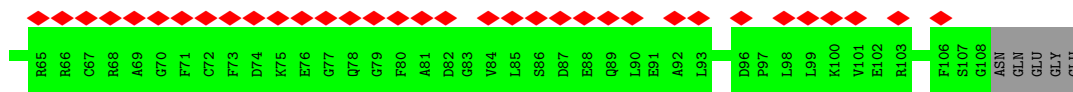

• Molecule 1: Mu-like prophage FluMu N-terminal domain-containing protein

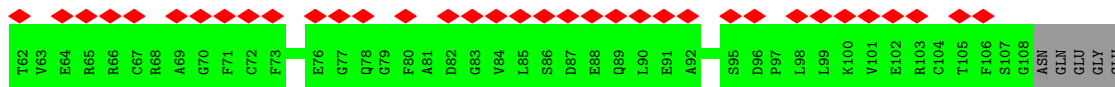
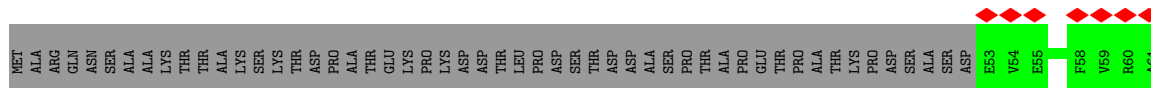

• Molecule 1: Mu-like prophage FluMu N-terminal domain-containing protein

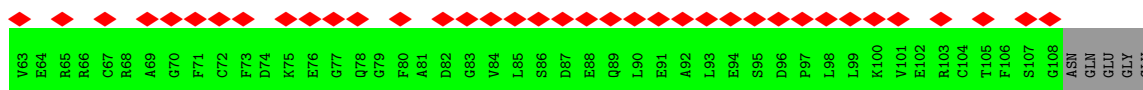
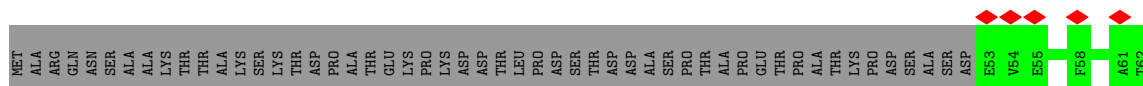
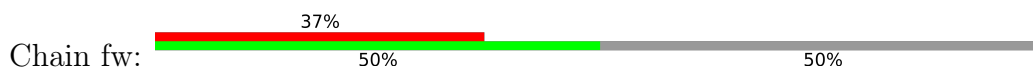

• Molecule 1: Mu-like prophage FluMu N-terminal domain-containing protein

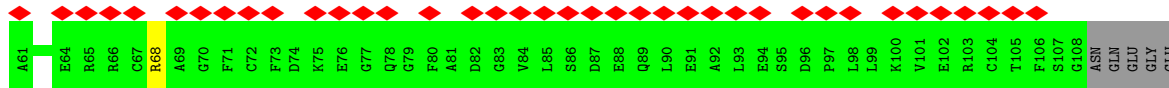
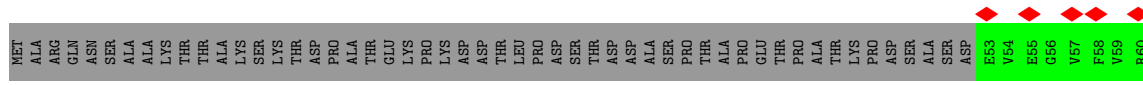
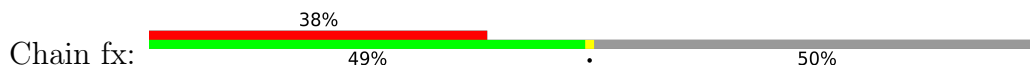

• Molecule 1: Mu-like prophage FluMu N-terminal domain-containing protein

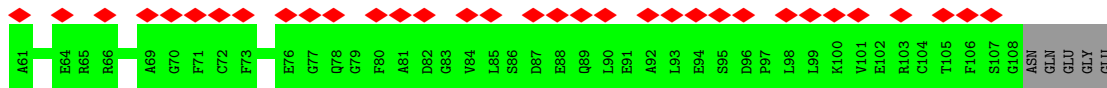
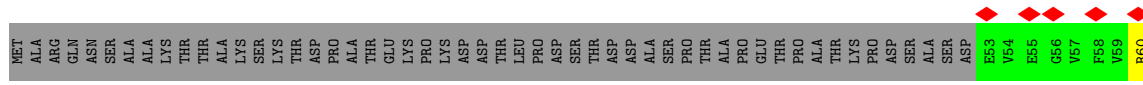

• Molecule 1: Mu-like prophage FluMu N-terminal domain-containing protein

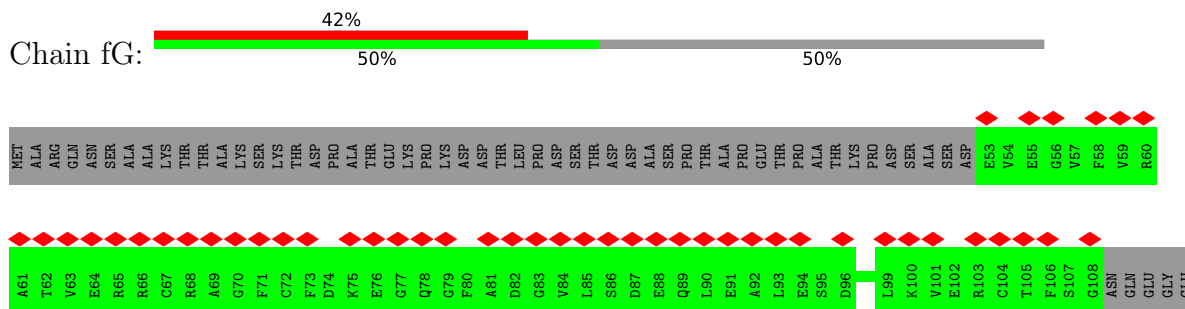

• Molecule 1: Mu-like prophage FluMu N-terminal domain-containing protein

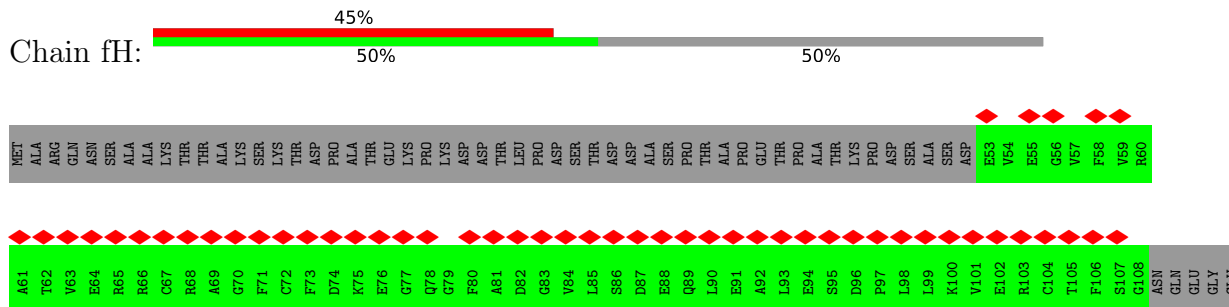

• Molecule 1: Mu-like prophage FluMu N-terminal domain-containing protein

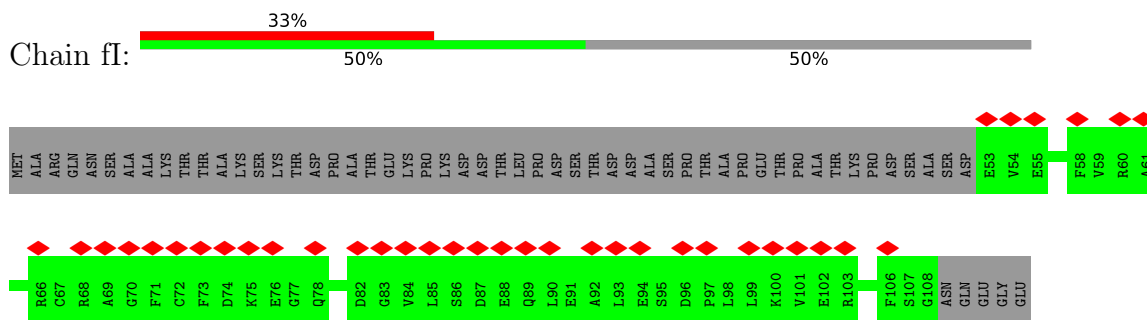

• Molecule 1: Mu-like prophage FluMu N-terminal domain-containing protein

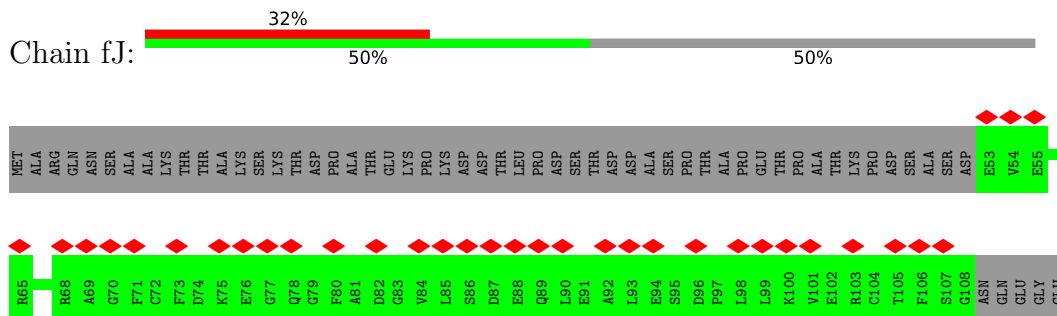

• Molecule 1: Mu-like prophage FluMu N-terminal domain-containing protein

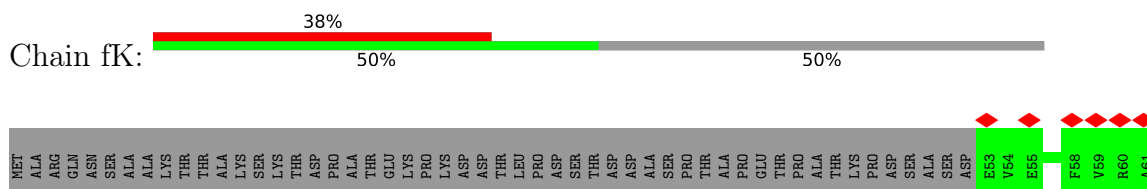

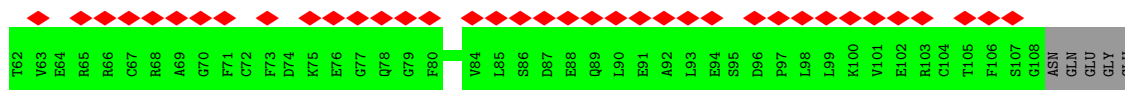

- Molecule 1: Mu-like prophage FluMu N-terminal domain-containing protein

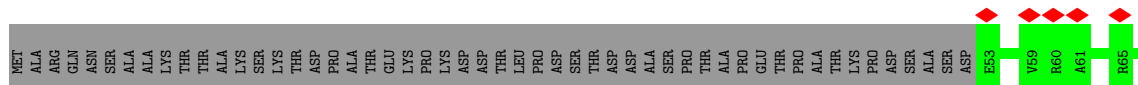

- Molecule 1: Mu-like prophage FluMu N-terminal domain-containing protein

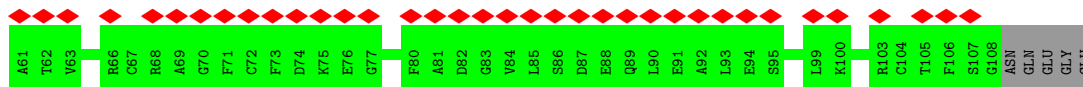
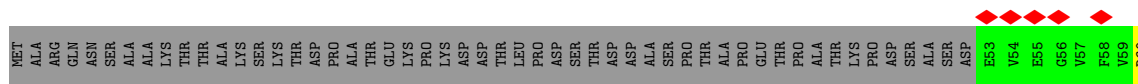

- Molecule 1: Mu-like prophage FluMu N-terminal domain-containing protein

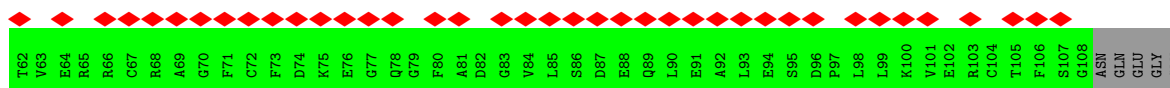
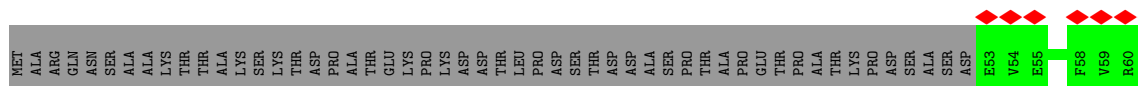
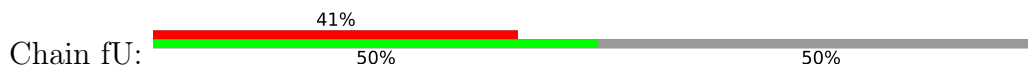

- Molecule 1: Mu-like prophage FluMu N-terminal domain-containing protein

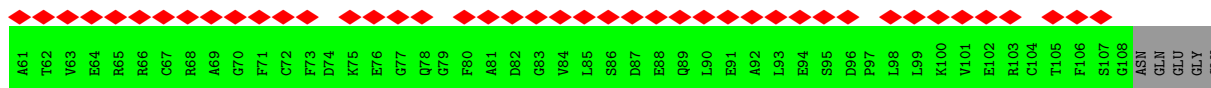
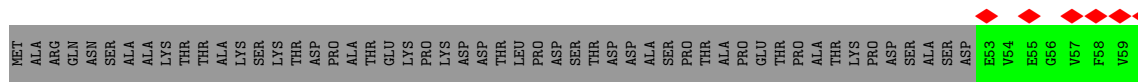
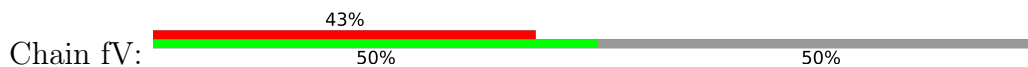

- Molecule 1: Mu-like prophage FluMu N-terminal domain-containing protein

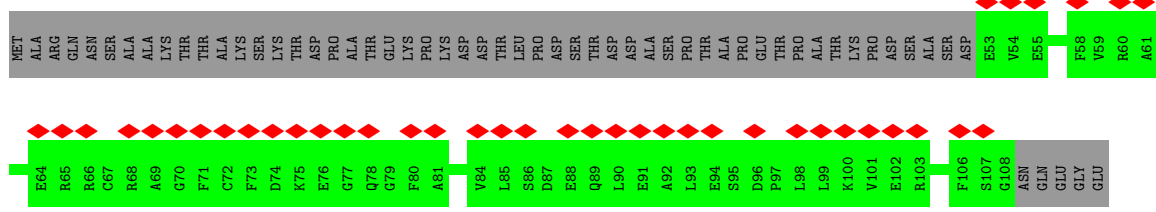

• Molecule 1: Mu-like prophage FluMu N-terminal domain-containing protein

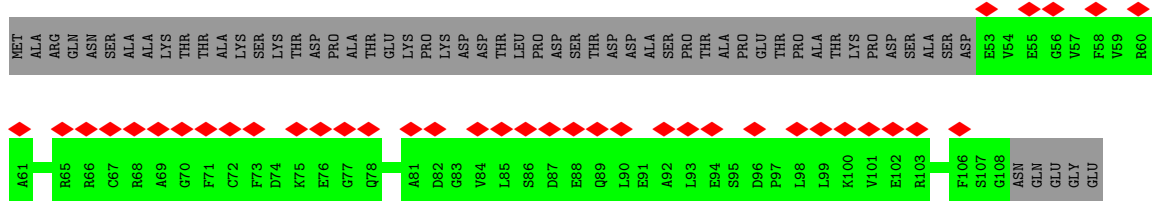

• Molecule 1: Mu-like prophage FluMu N-terminal domain-containing protein

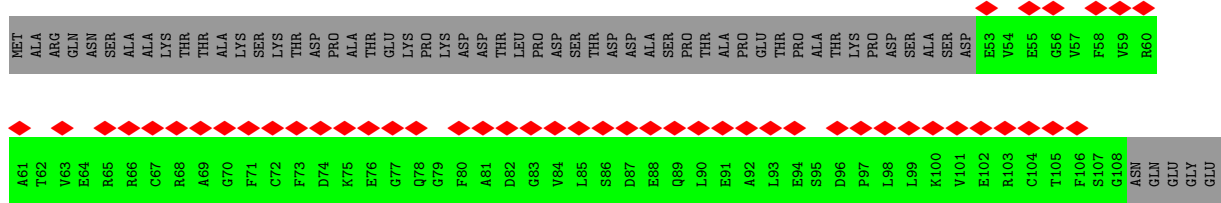

• Molecule 1: Mu-like prophage FluMu N-terminal domain-containing protein

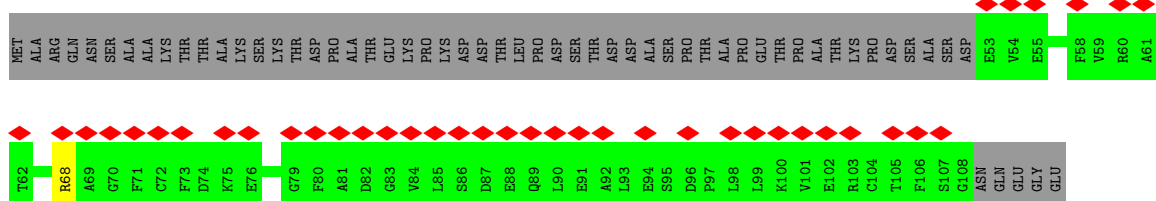

• Molecule 1: Mu-like prophage FluMu N-terminal domain-containing protein

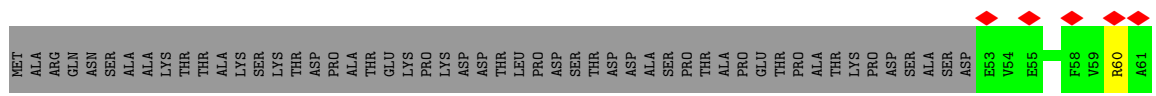
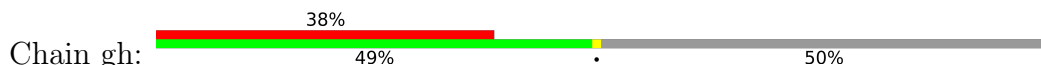

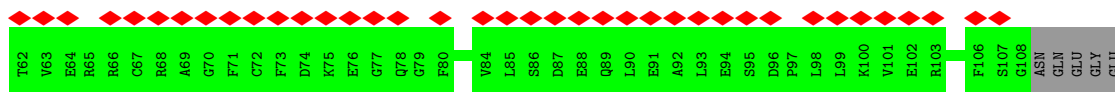

• Molecule 1: Mu-like prophage FluMu N-terminal domain-containing protein

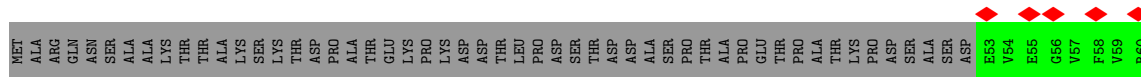
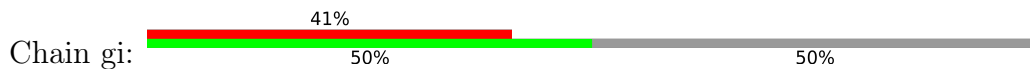

• Molecule 1: Mu-like prophage FluMu N-terminal domain-containing protein

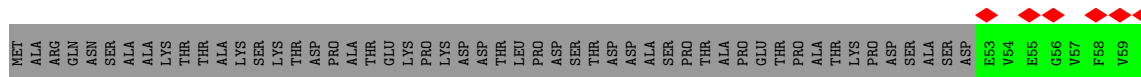
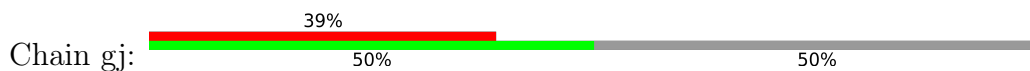

• Molecule 1: Mu-like prophage FluMu N-terminal domain-containing protein

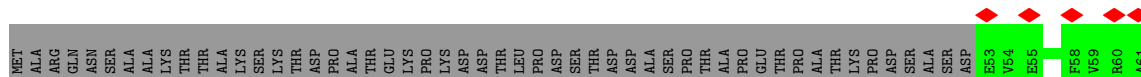
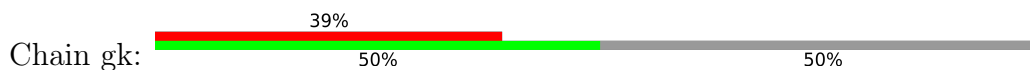

• Molecule 1: Mu-like prophage FluMu N-terminal domain-containing protein

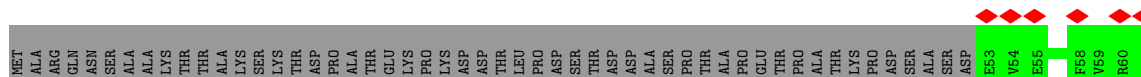

• Molecule 1: Mu-like prophage FluMu N-terminal domain-containing protein

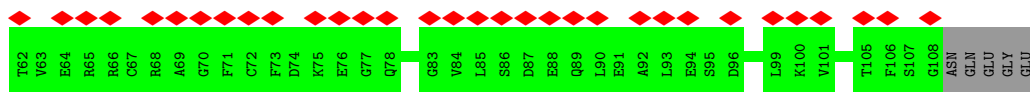

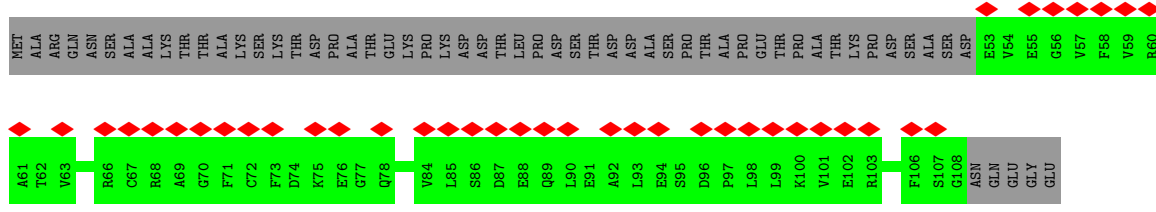
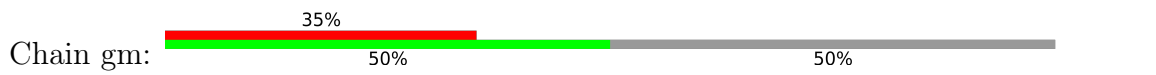

• Molecule 1: Mu-like prophage FluMu N-terminal domain-containing protein

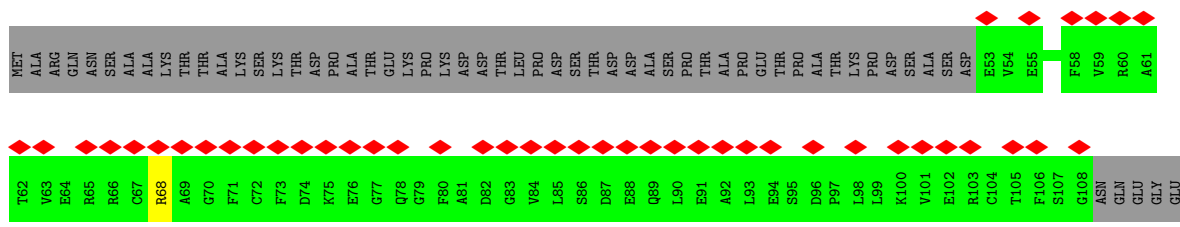
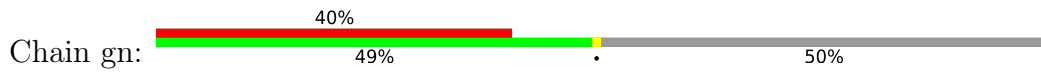

• Molecule 1: Mu-like prophage FluMu N-terminal domain-containing protein

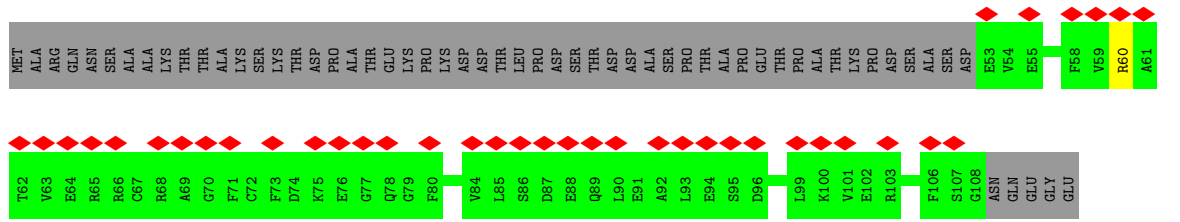

• Molecule 1: Mu-like prophage FluMu N-terminal domain-containing protein

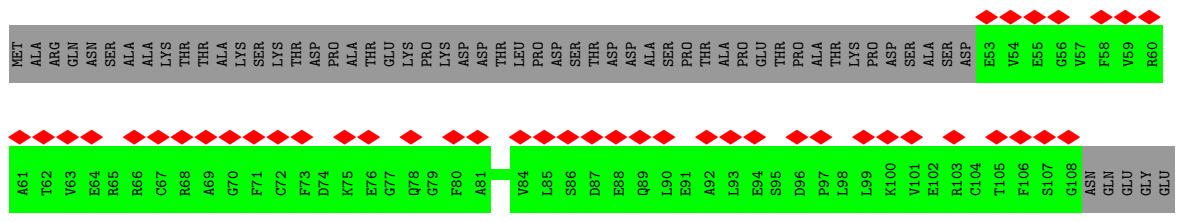
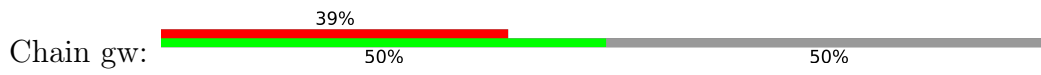

• Molecule 1: Mu-like prophage FluMu N-terminal domain-containing protein

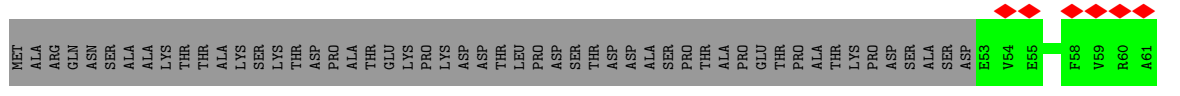
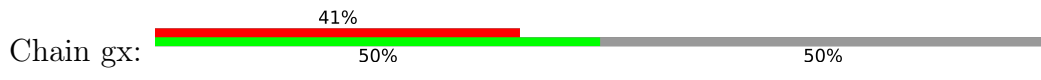



• Molecule 1: Mu-like prophage FluMu N-terminal domain-containing protein

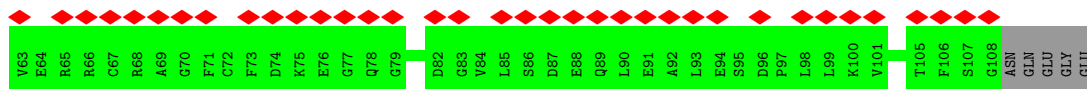
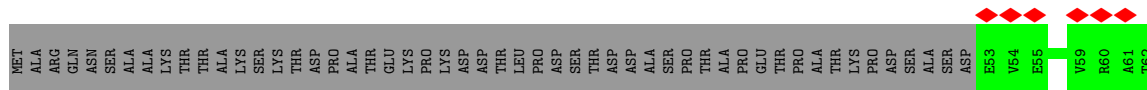

• Molecule 1: Mu-like prophage FluMu N-terminal domain-containing protein

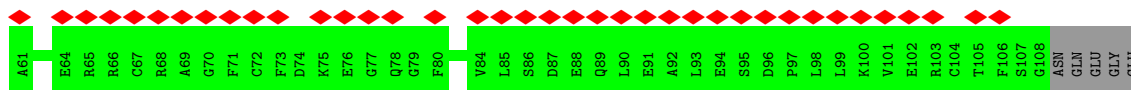
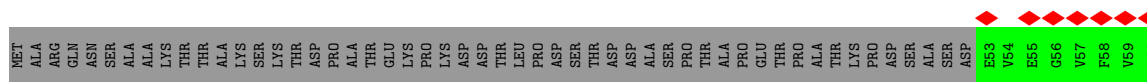
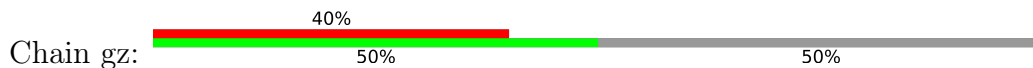

• Molecule 1: Mu-like prophage FluMu N-terminal domain-containing protein

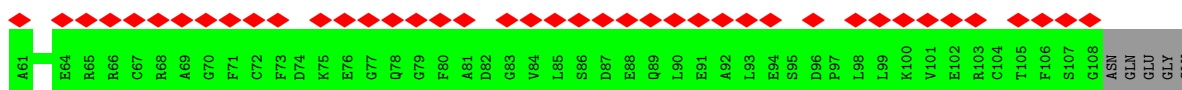
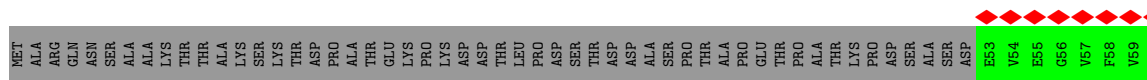
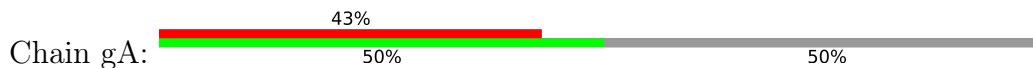

• Molecule 1: Mu-like prophage FluMu N-terminal domain-containing protein

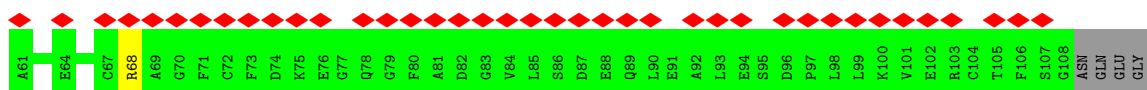
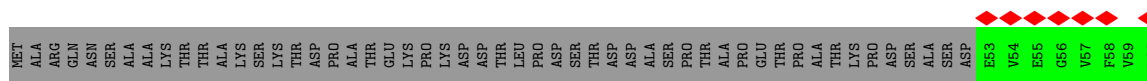
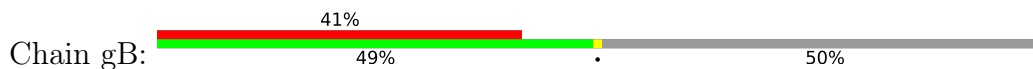

• Molecule 1: Mu-like prophage FluMu N-terminal domain-containing protein

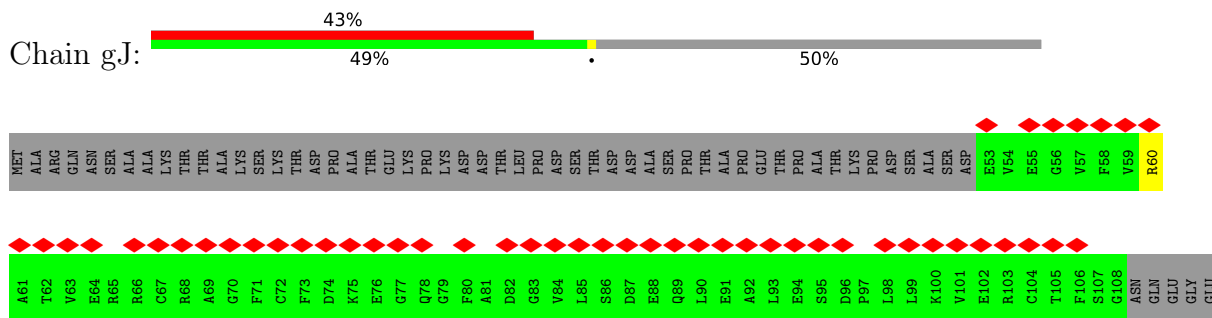

• Molecule 1: Mu-like prophage FluMu N-terminal domain-containing protein

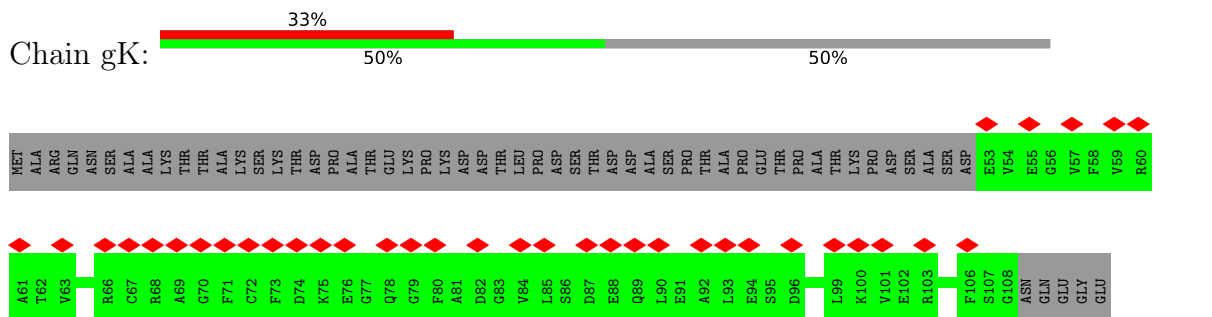

• Molecule 1: Mu-like prophage FluMu N-terminal domain-containing protein

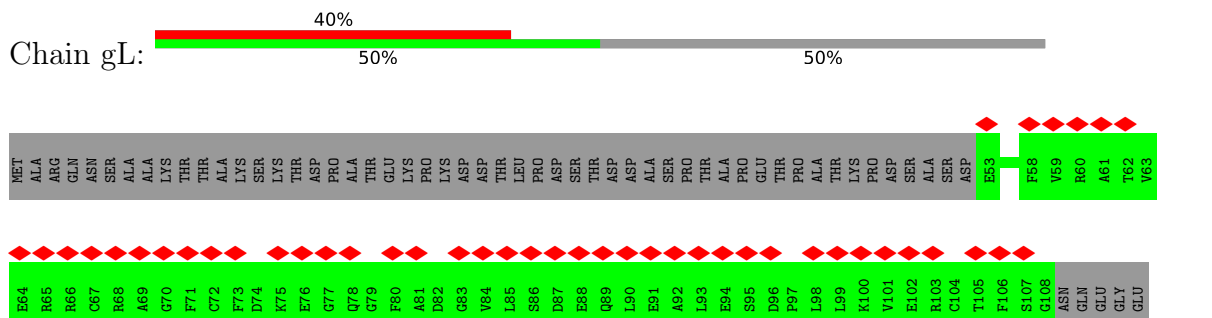

• Molecule 1: Mu-like prophage FluMu N-terminal domain-containing protein

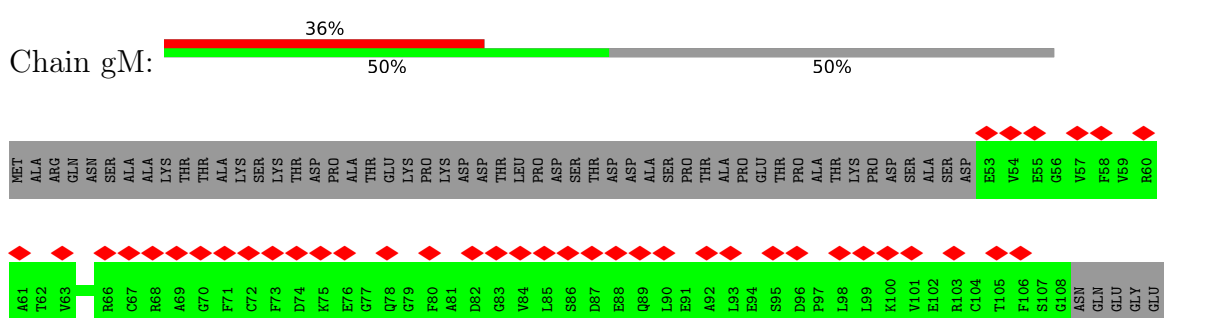

• Molecule 1: Mu-like prophage FluMu N-terminal domain-containing protein

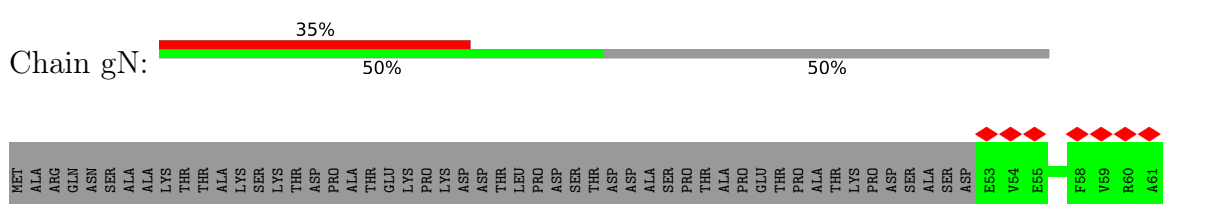

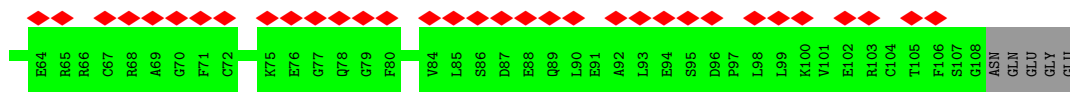

• Molecule 1: Mu-like prophage FluMu N-terminal domain-containing protein

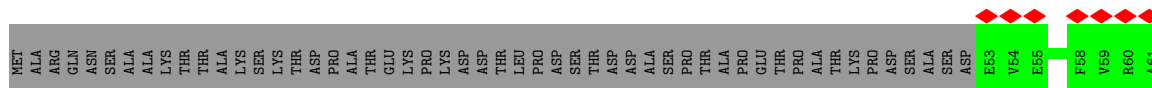
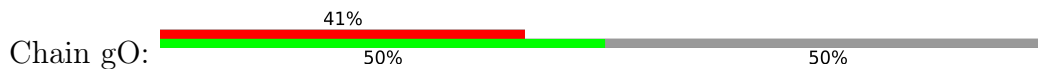

• Molecule 1: Mu-like prophage FluMu N-terminal domain-containing protein

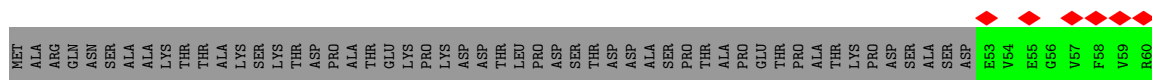

• Molecule 1: Mu-like prophage FluMu N-terminal domain-containing protein

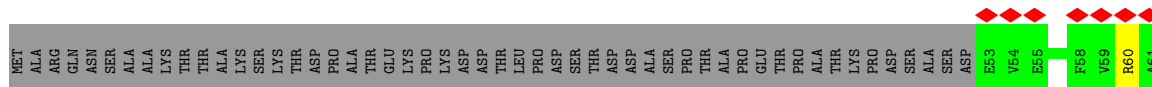

• Molecule 1: Mu-like prophage FluMu N-terminal domain-containing protein

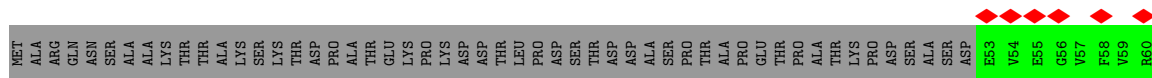
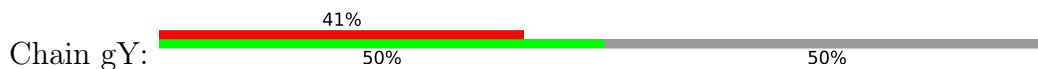

• Molecule 1: Mu-like prophage FluMu N-terminal domain-containing protein

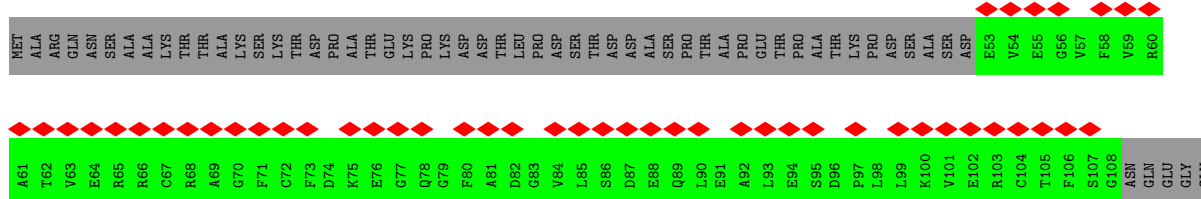
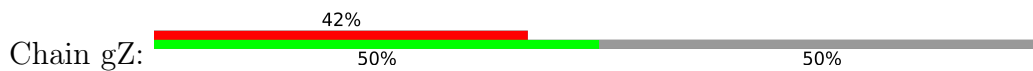

• Molecule 1: Mu-like prophage FluMu N-terminal domain-containing protein

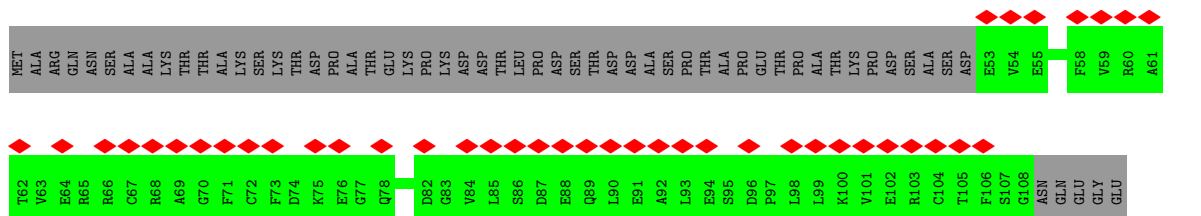
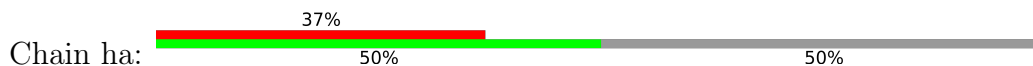

• Molecule 1: Mu-like prophage FluMu N-terminal domain-containing protein

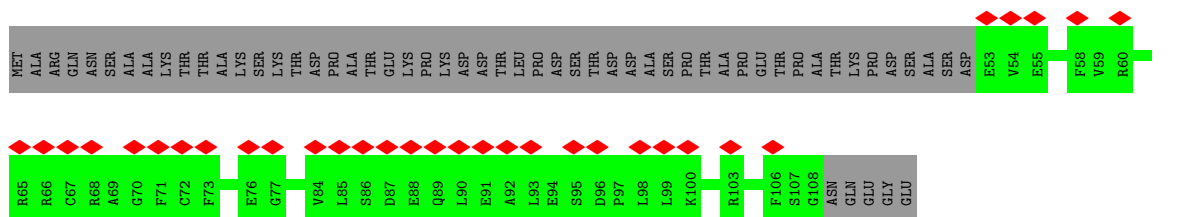

• Molecule 1: Mu-like prophage FluMu N-terminal domain-containing protein

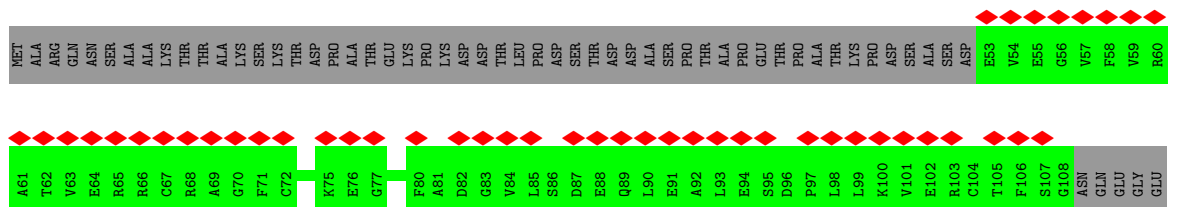
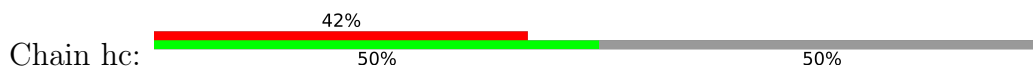

• Molecule 1: Mu-like prophage FluMu N-terminal domain-containing protein



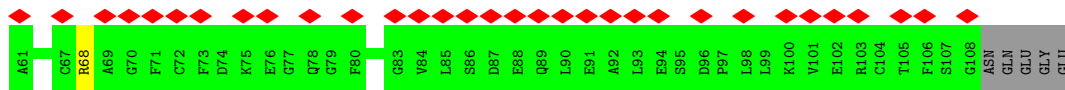

• Molecule 1: Mu-like prophage FluMu N-terminal domain-containing protein

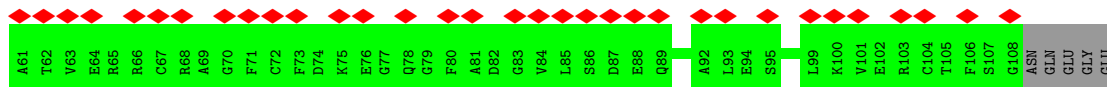
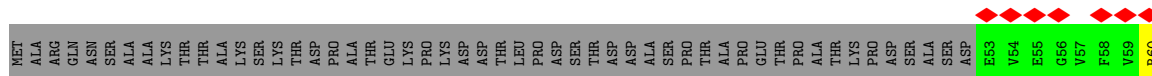

• Molecule 1: Mu-like prophage FluMu N-terminal domain-containing protein



• Molecule 1: Mu-like prophage FluMu N-terminal domain-containing protein

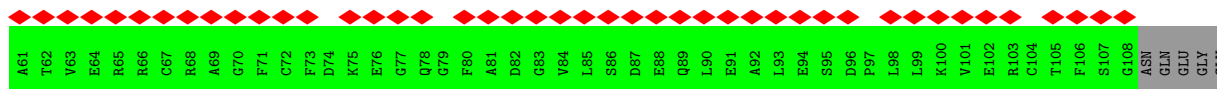
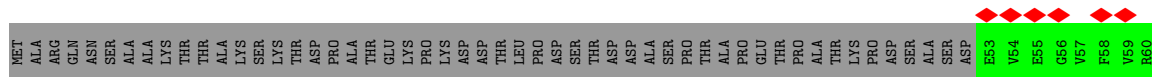
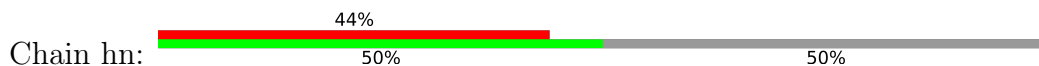

• Molecule 1: Mu-like prophage FluMu N-terminal domain-containing protein

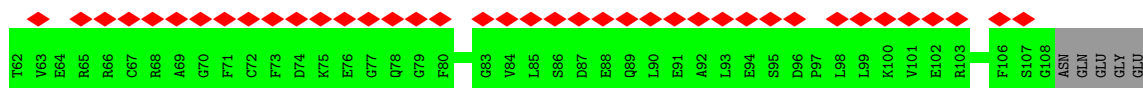
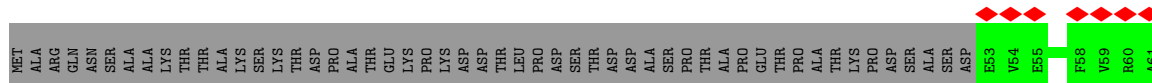
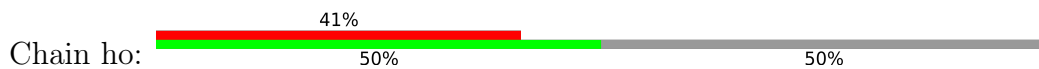

• Molecule 1: Mu-like prophage FluMu N-terminal domain-containing protein

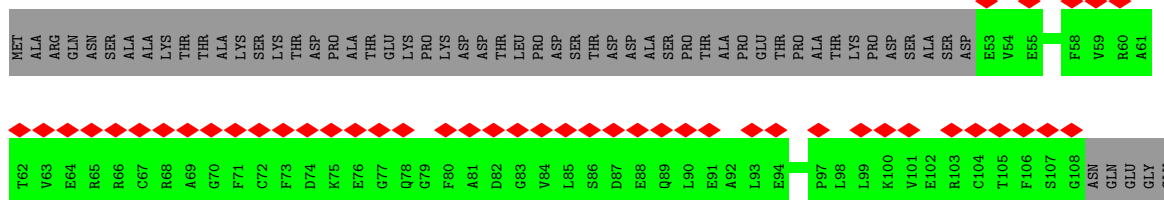
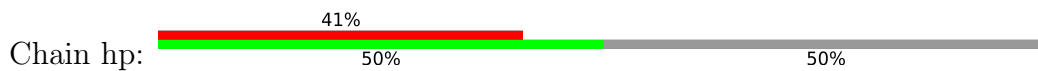

• Molecule 1: Mu-like prophage FluMu N-terminal domain-containing protein

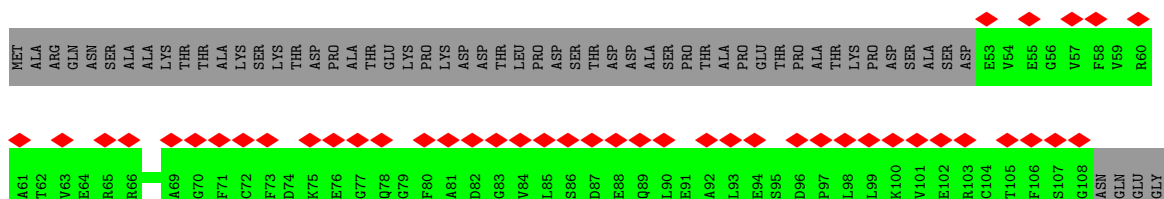
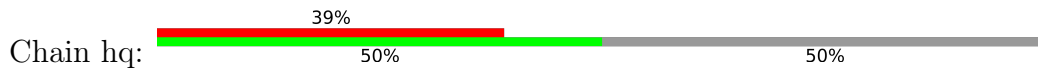

• Molecule 1: Mu-like prophage FluMu N-terminal domain-containing protein

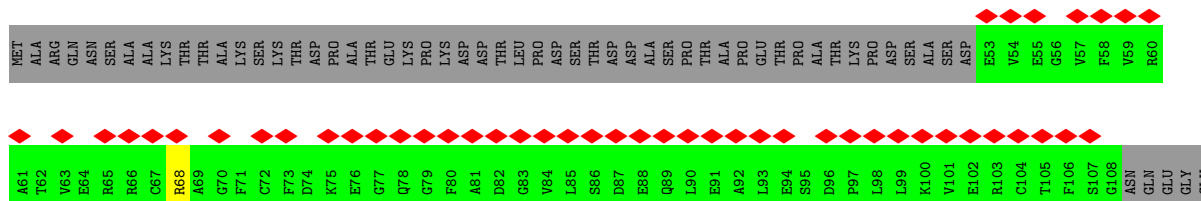
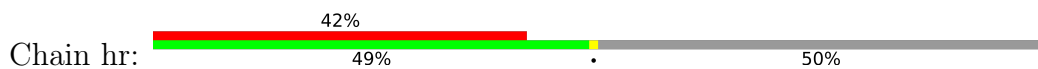

• Molecule 1: Mu-like prophage FluMu N-terminal domain-containing protein

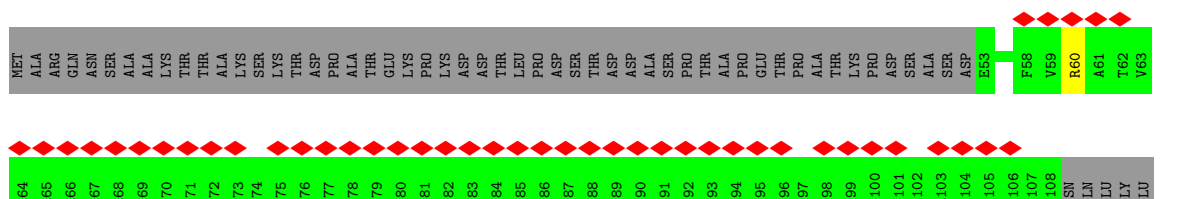
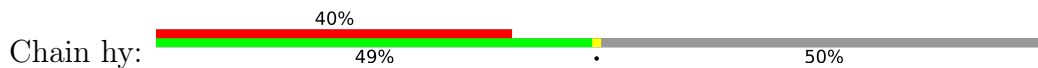

• Molecule 1: Mu-like prophage FluMu N-terminal domain-containing protein

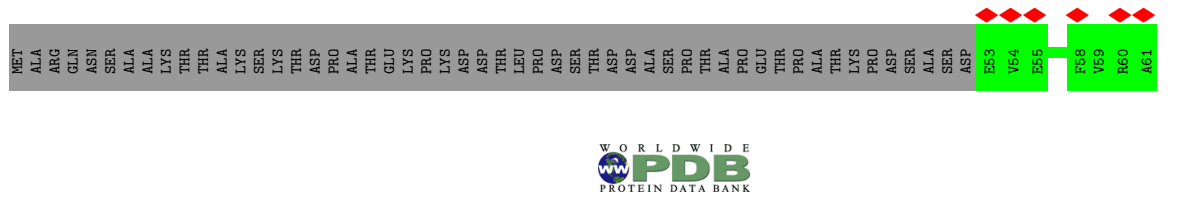
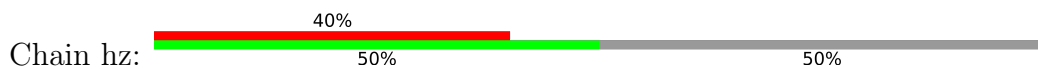



- Molecule 1: Mu-like prophage FluMu N-terminal domain-containing protein

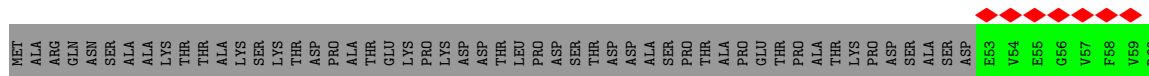
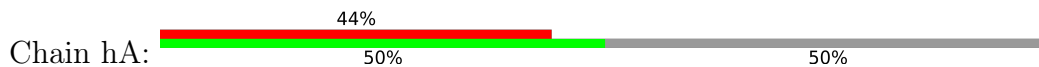

- Molecule 1: Mu-like prophage FluMu N-terminal domain-containing protein

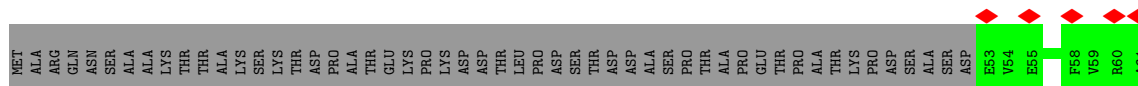
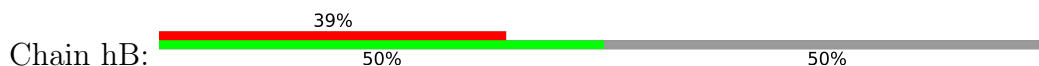

- Molecule 1: Mu-like prophage FluMu N-terminal domain-containing protein

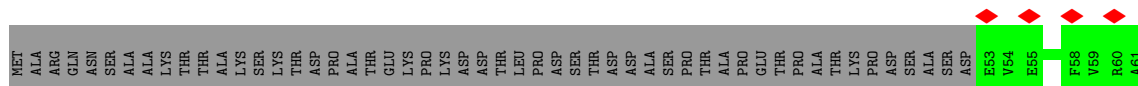
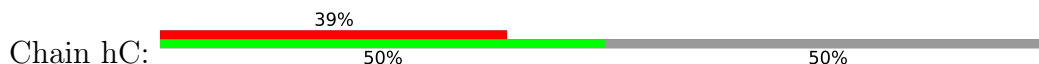

- Molecule 1: Mu-like prophage FluMu N-terminal domain-containing protein

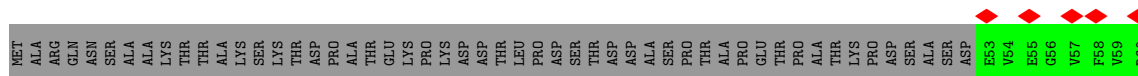
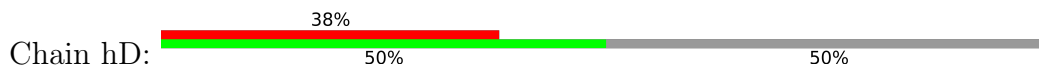

- Molecule 1: Mu-like prophage FluMu N-terminal domain-containing protein



• Molecule 1: Mu-like prophage FluMu N-terminal domain-containing protein

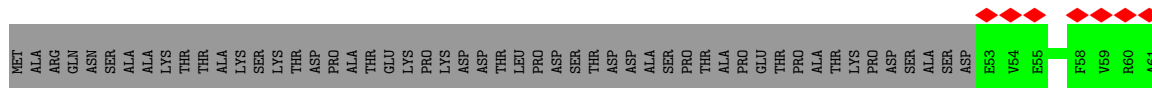

• Molecule 1: Mu-like prophage FluMu N-terminal domain-containing protein

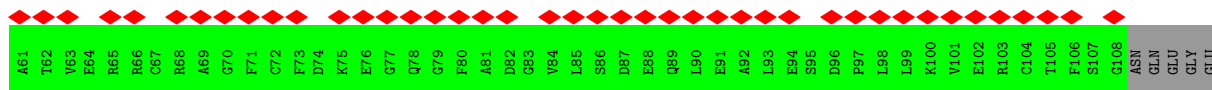
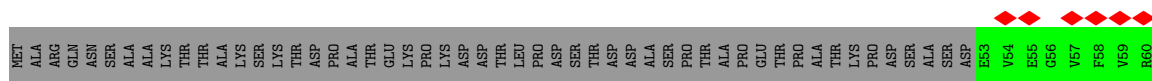
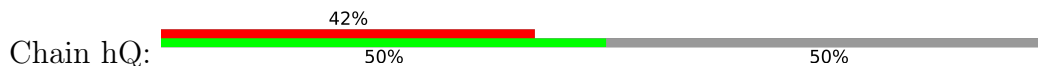

• Molecule 1: Mu-like prophage FluMu N-terminal domain-containing protein

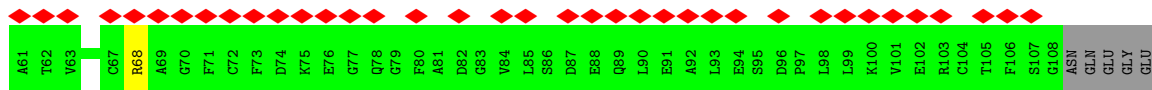
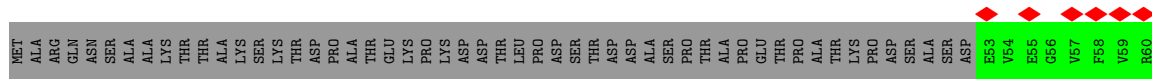
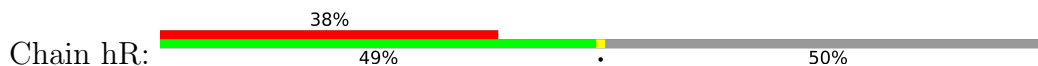

• Molecule 1: Mu-like prophage FluMu N-terminal domain-containing protein

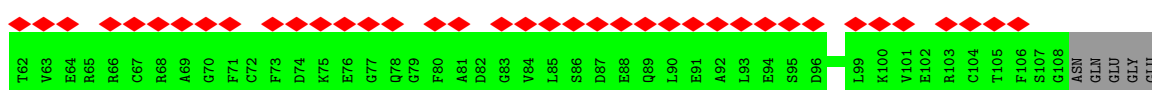
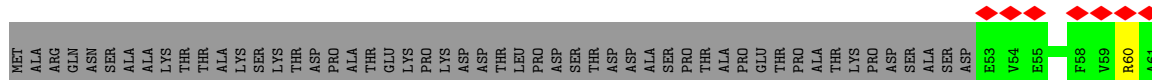
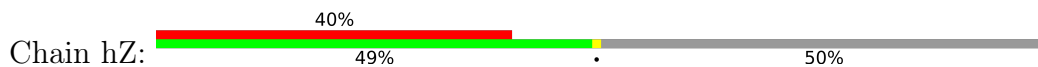

• Molecule 1: Mu-like prophage FluMu N-terminal domain-containing protein

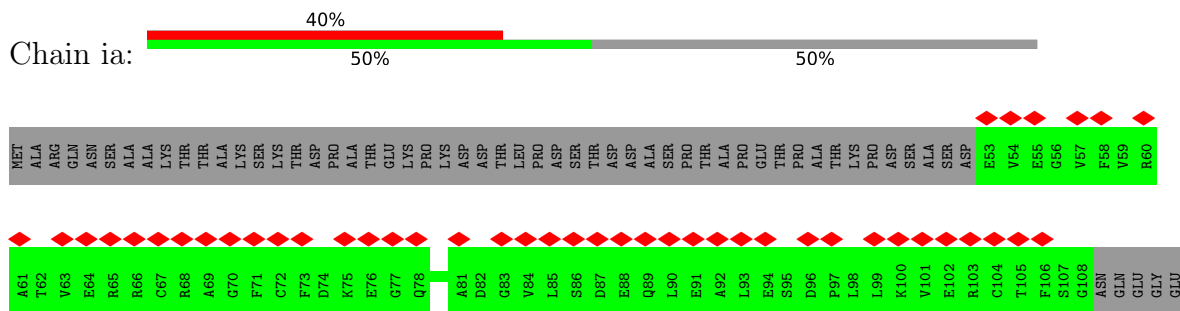

• Molecule 1: Mu-like prophage FluMu N-terminal domain-containing protein

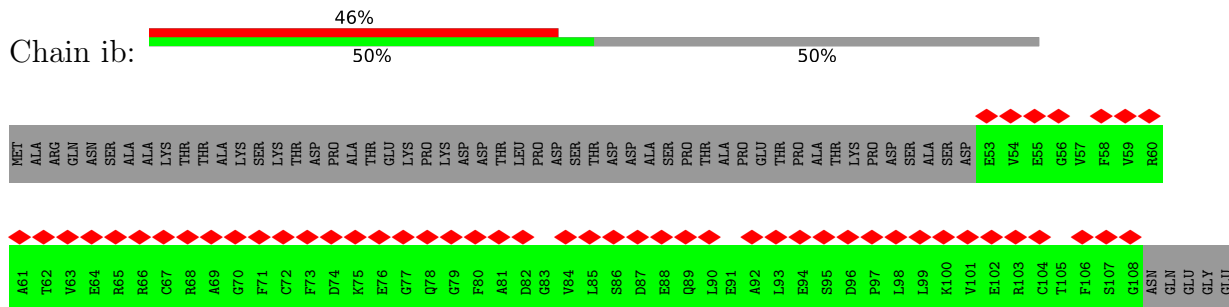

• Molecule 1: Mu-like prophage FluMu N-terminal domain-containing protein

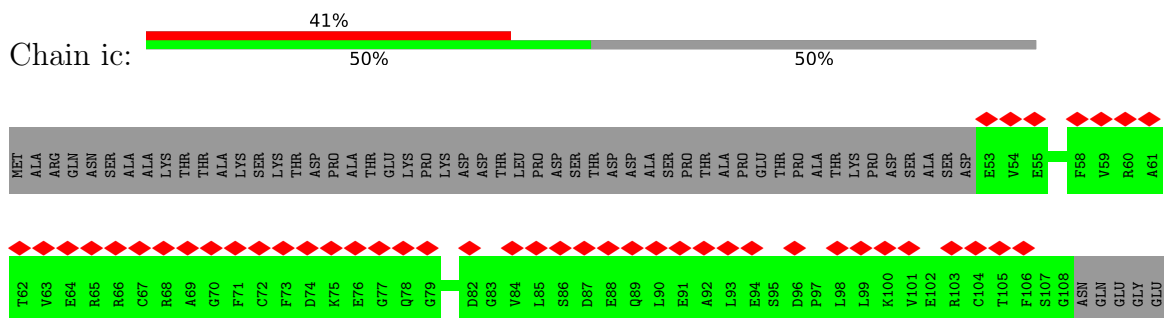

• Molecule 1: Mu-like prophage FluMu N-terminal domain-containing protein

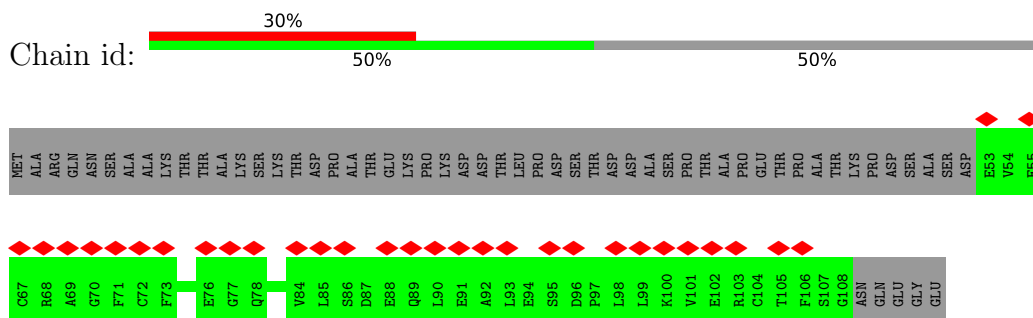

• Molecule 1: Mu-like prophage FluMu N-terminal domain-containing protein

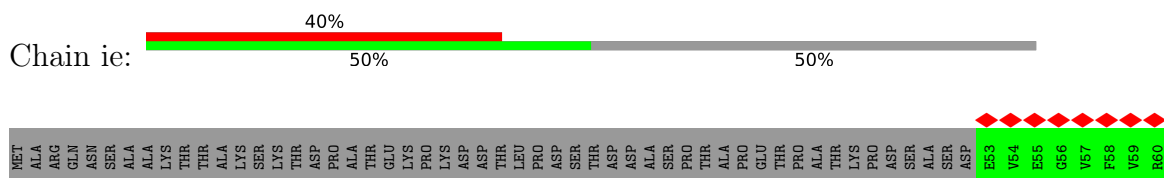

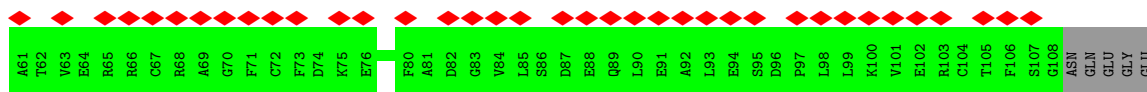

• Molecule 1: Mu-like prophage FluMu N-terminal domain-containing protein

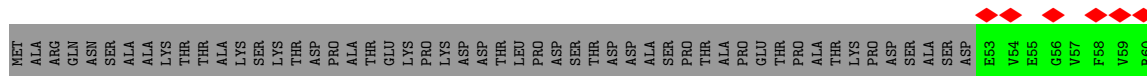

• Molecule 1: Mu-like prophage FluMu N-terminal domain-containing protein

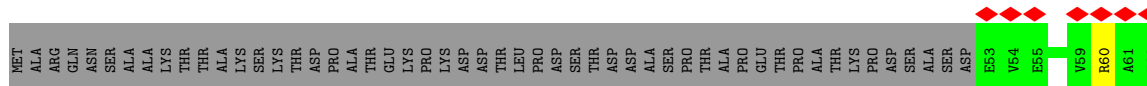

• Molecule 1: Mu-like prophage FluMu N-terminal domain-containing protein

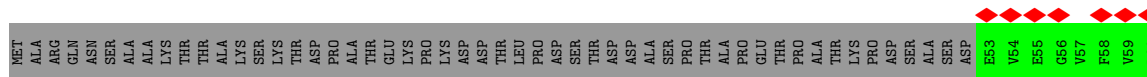
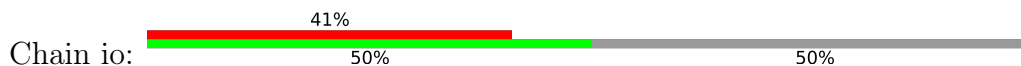

• Molecule 1: Mu-like prophage FluMu N-terminal domain-containing protein

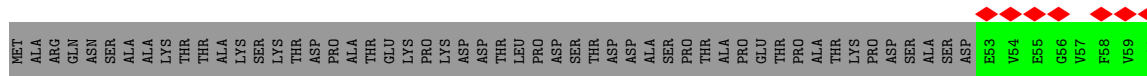
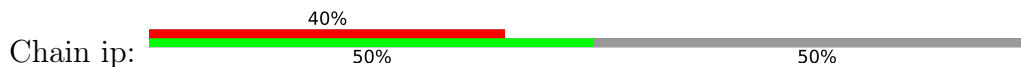

• Molecule 1: Mu-like prophage FluMu N-terminal domain-containing protein

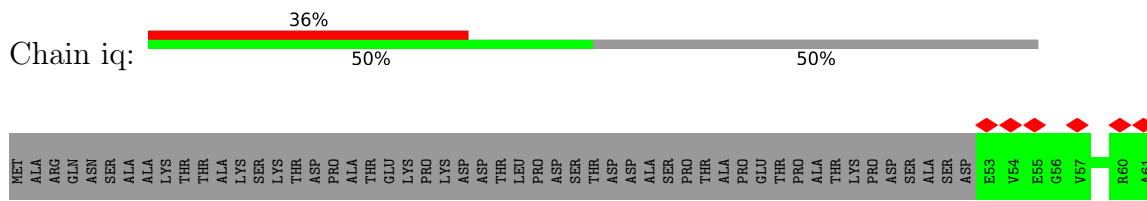

• Molecule 1: Mu-like prophage FluMu N-terminal domain-containing protein

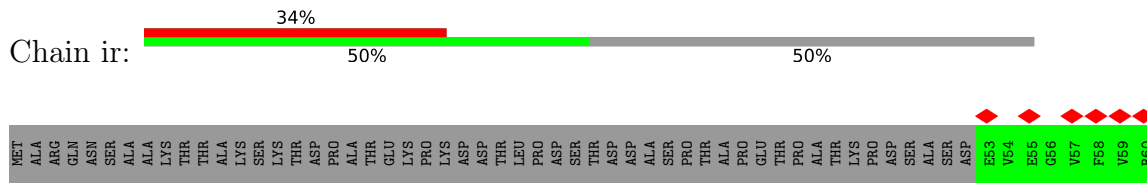

• Molecule 1: Mu-like prophage FluMu N-terminal domain-containing protein

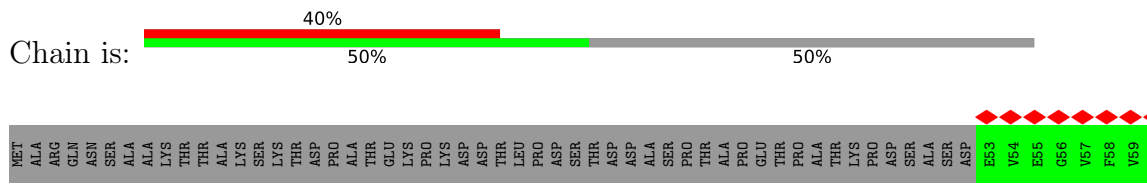

• Molecule 1: Mu-like prophage FluMu N-terminal domain-containing protein

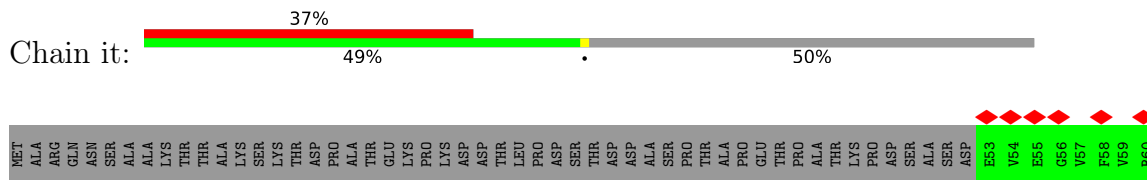

• Molecule 1: Mu-like prophage FluMu N-terminal domain-containing protein

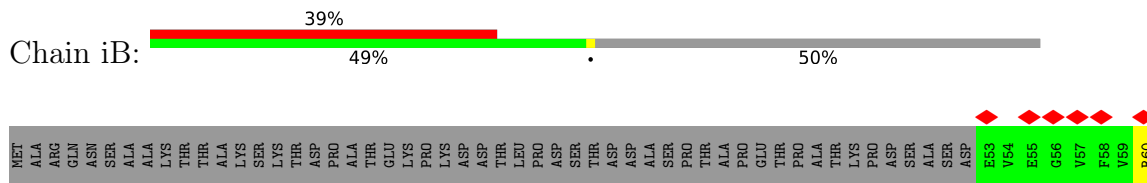

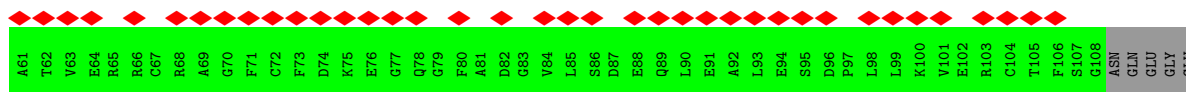

• Molecule 1: Mu-like prophage FluMu N-terminal domain-containing protein

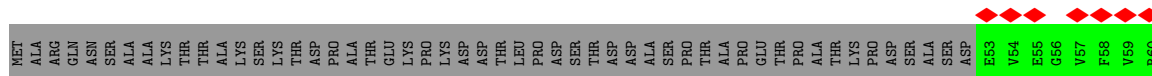
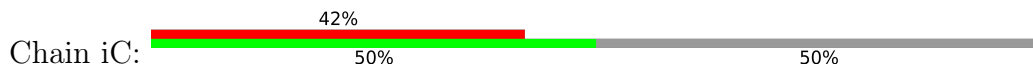

• Molecule 1: Mu-like prophage FluMu N-terminal domain-containing protein

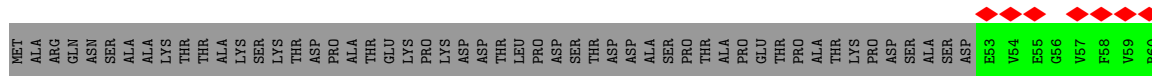
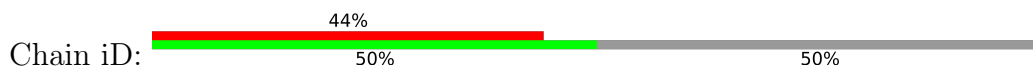

• Molecule 1: Mu-like prophage FluMu N-terminal domain-containing protein

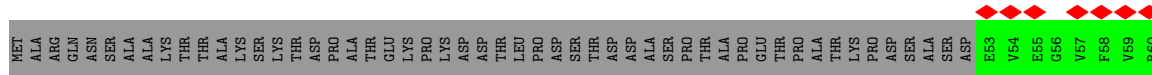
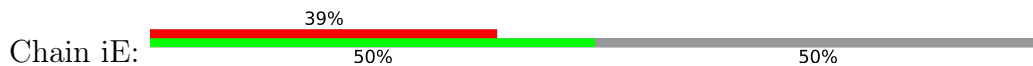

• Molecule 1: Mu-like prophage FluMu N-terminal domain-containing protein

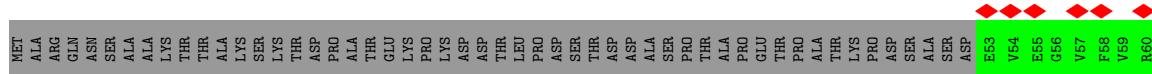
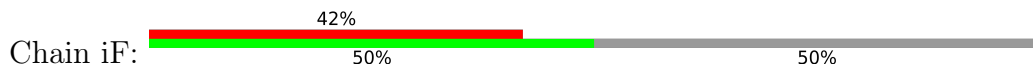

• Molecule 1: Mu-like prophage FluMu N-terminal domain-containing protein

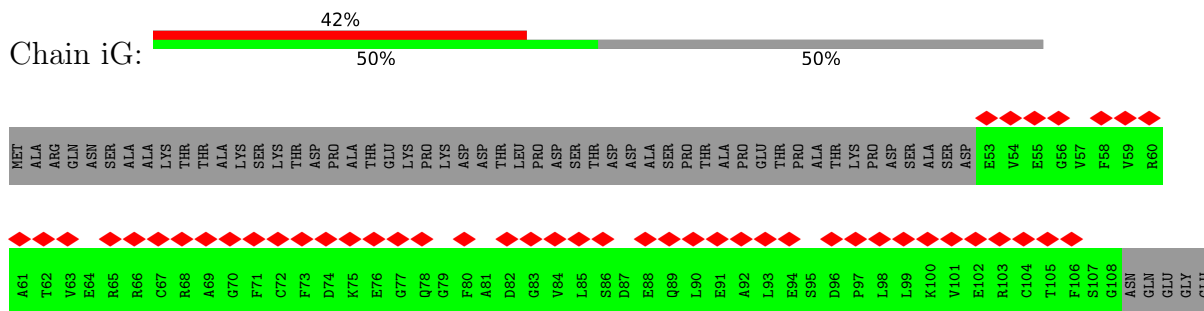

• Molecule 1: Mu-like prophage FluMu N-terminal domain-containing protein

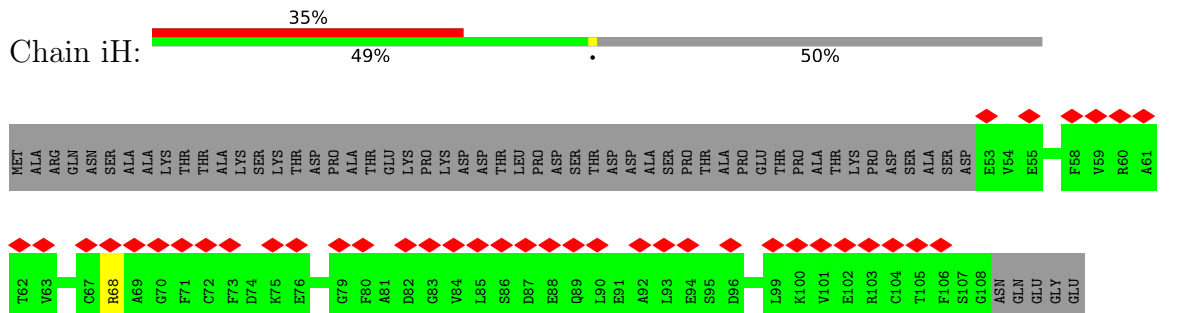

• Molecule 1: Mu-like prophage FluMu N-terminal domain-containing protein

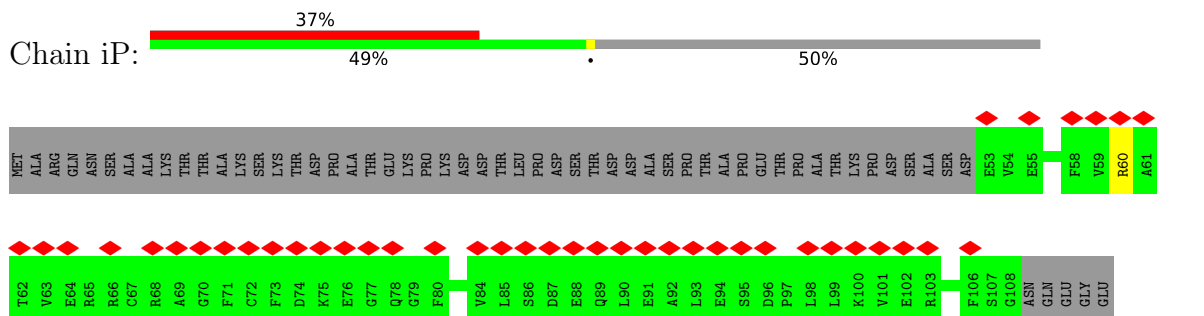

• Molecule 1: Mu-like prophage FluMu N-terminal domain-containing protein

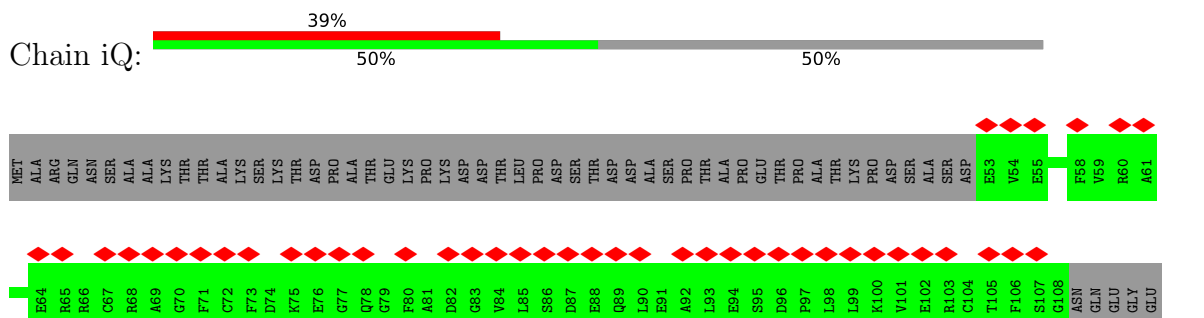

• Molecule 1: Mu-like prophage FluMu N-terminal domain-containing protein

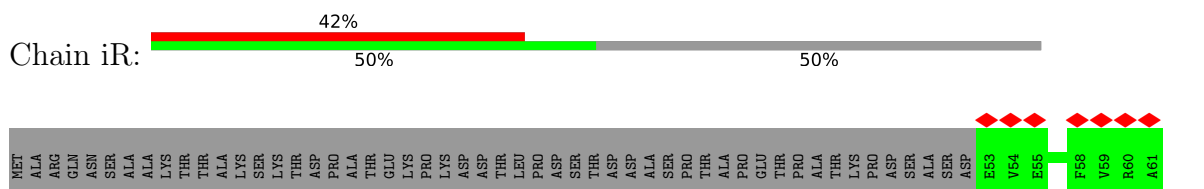

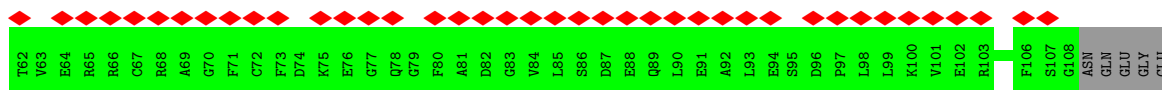

- Molecule 1: Mu-like prophage FluMu N-terminal domain-containing protein

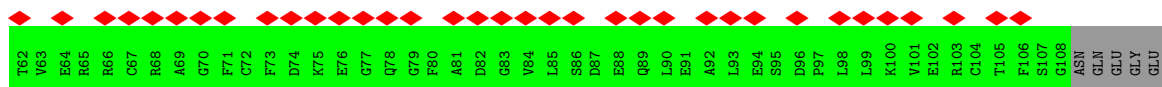
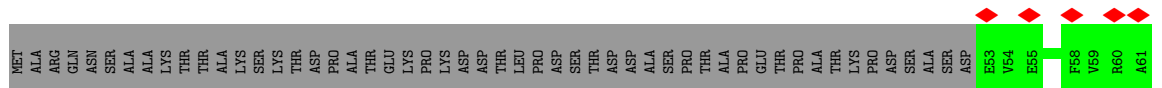

- Molecule 1: Mu-like prophage FluMu N-terminal domain-containing protein

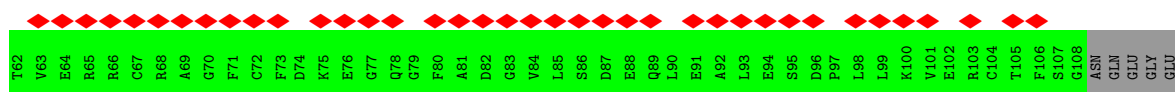
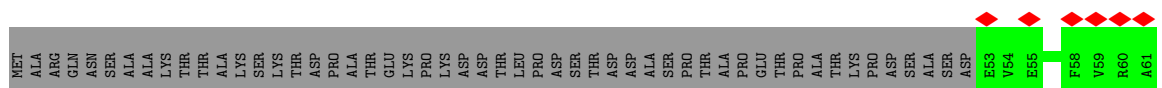
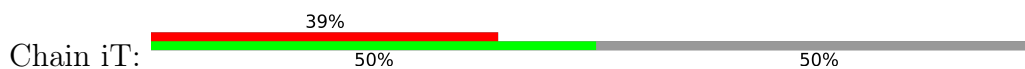

- Molecule 1: Mu-like prophage FluMu N-terminal domain-containing protein

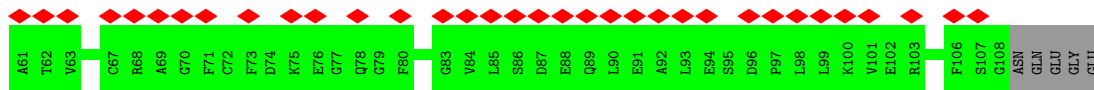
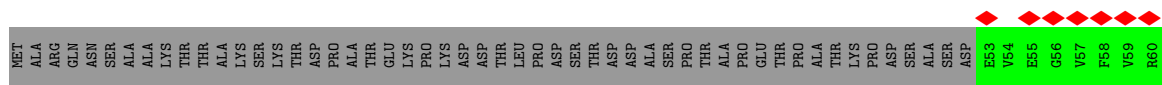

- Molecule 1: Mu-like prophage FluMu N-terminal domain-containing protein

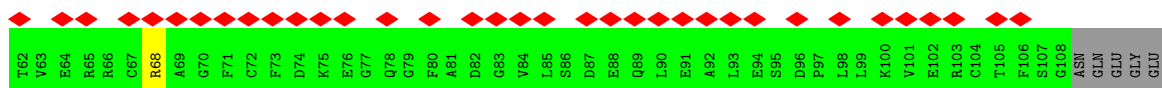
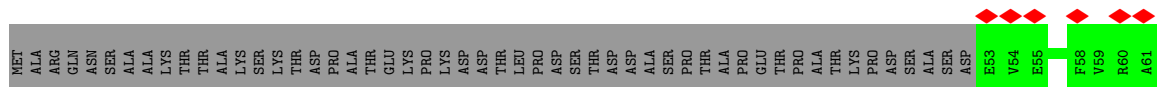

- Molecule 1: Mu-like prophage FluMu N-terminal domain-containing protein

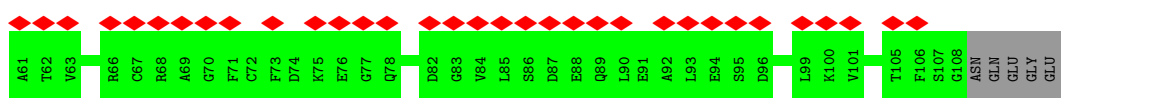
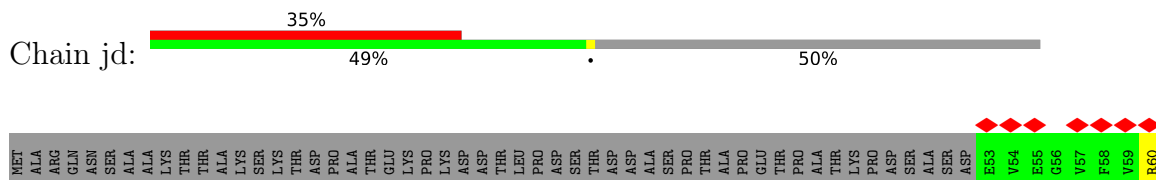

• Molecule 1: Mu-like prophage FluMu N-terminal domain-containing protein

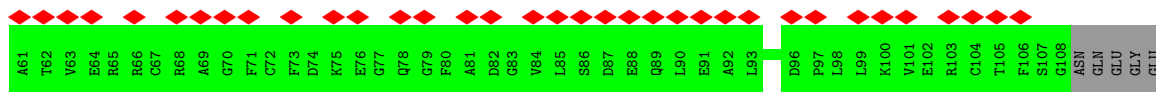
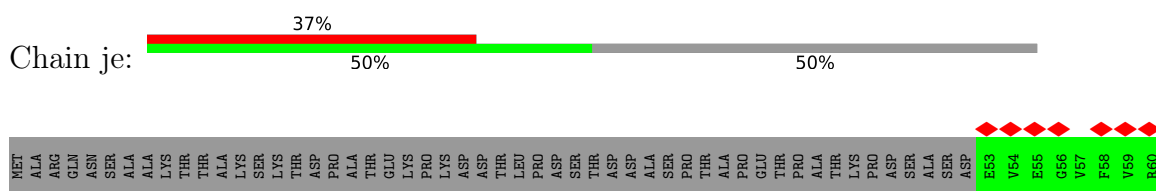

• Molecule 1: Mu-like prophage FluMu N-terminal domain-containing protein

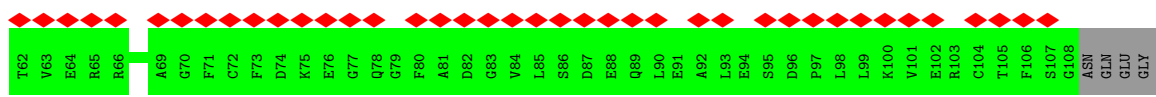
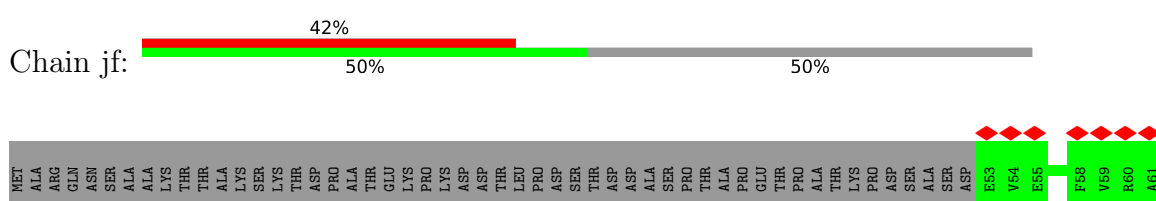

• Molecule 1: Mu-like prophage FluMu N-terminal domain-containing protein

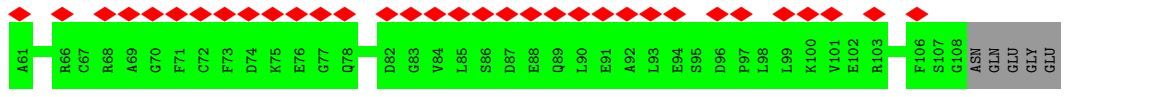
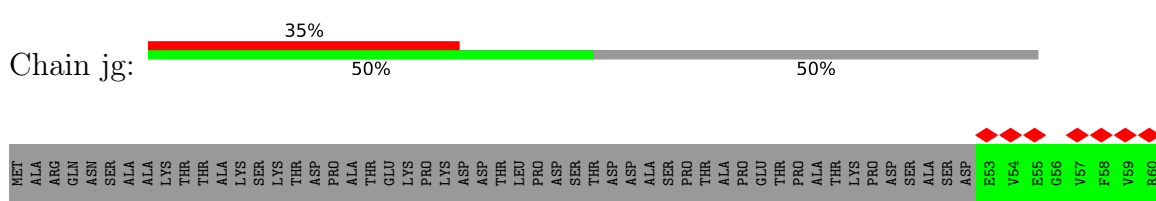

• Molecule 1: Mu-like prophage FluMu N-terminal domain-containing protein

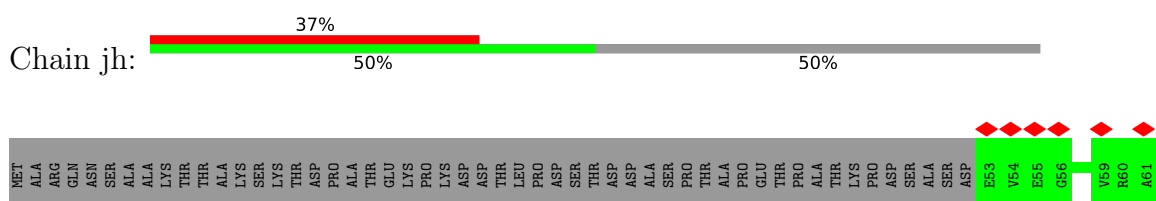

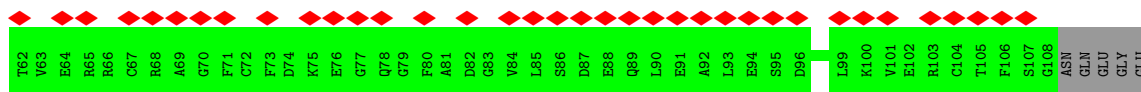

• Molecule 1: Mu-like prophage FluMu N-terminal domain-containing protein

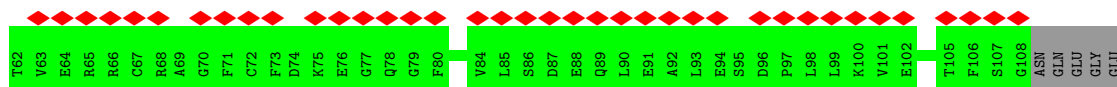
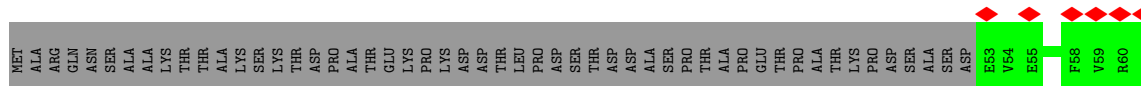

• Molecule 1: Mu-like prophage FluMu N-terminal domain-containing protein

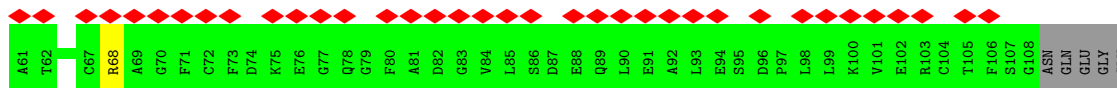
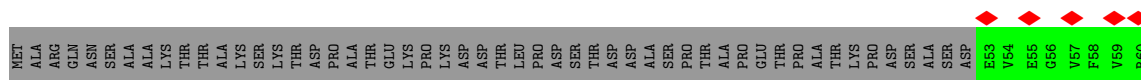

• Molecule 1: Mu-like prophage FluMu N-terminal domain-containing protein

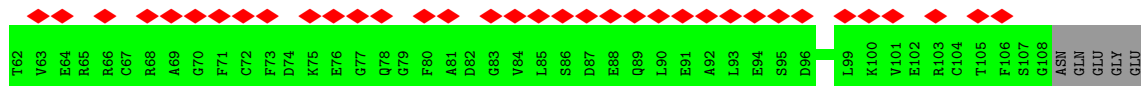
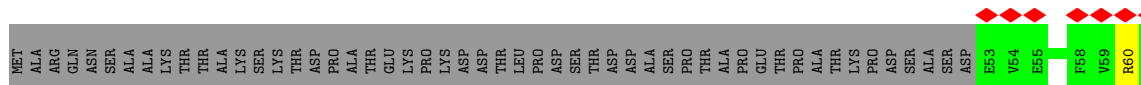

• Molecule 1: Mu-like prophage FluMu N-terminal domain-containing protein

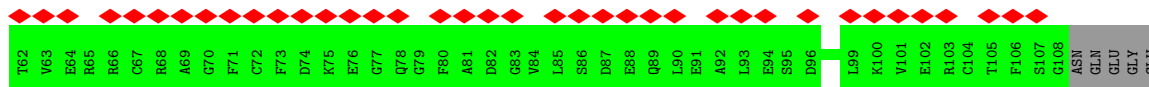
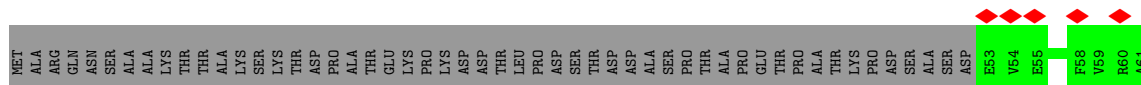
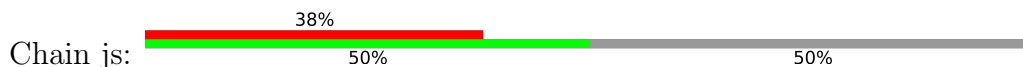

• Molecule 1: Mu-like prophage FluMu N-terminal domain-containing protein

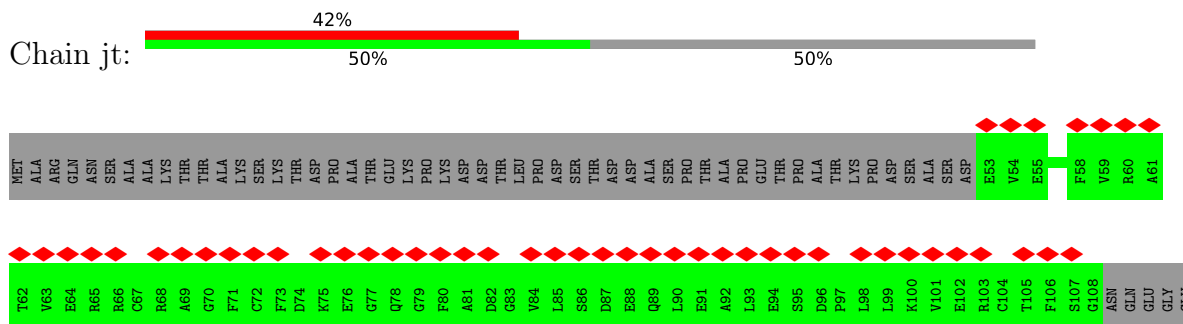

• Molecule 1: Mu-like prophage FluMu N-terminal domain-containing protein

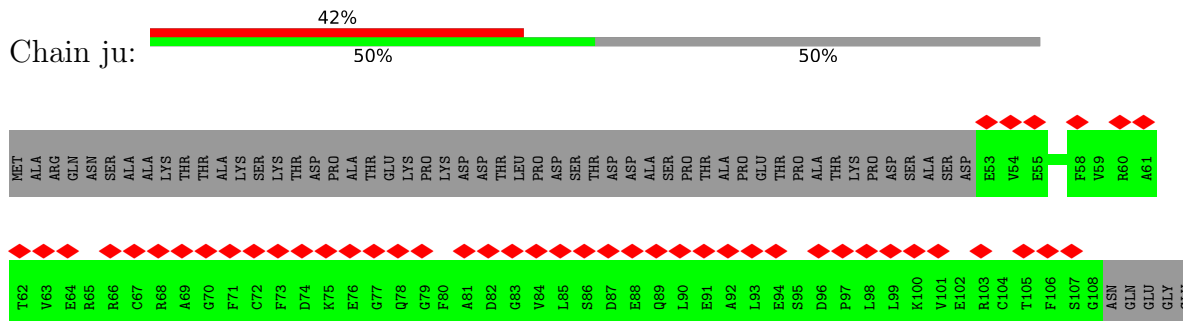

• Molecule 1: Mu-like prophage FluMu N-terminal domain-containing protein

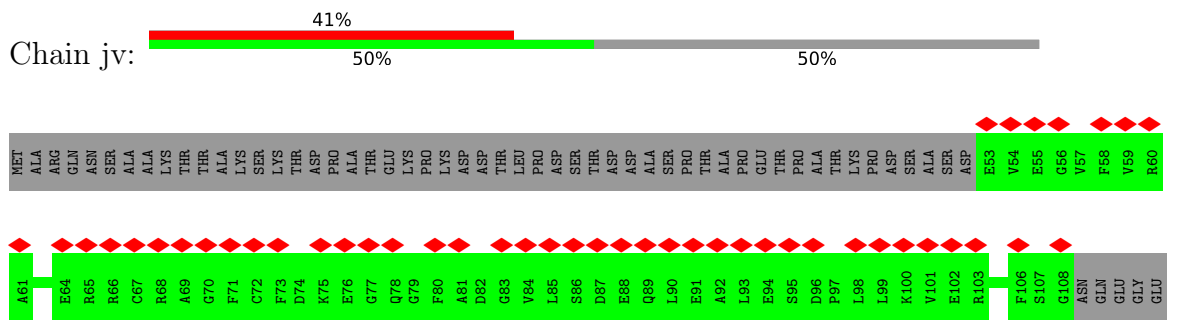

• Molecule 1: Mu-like prophage FluMu N-terminal domain-containing protein

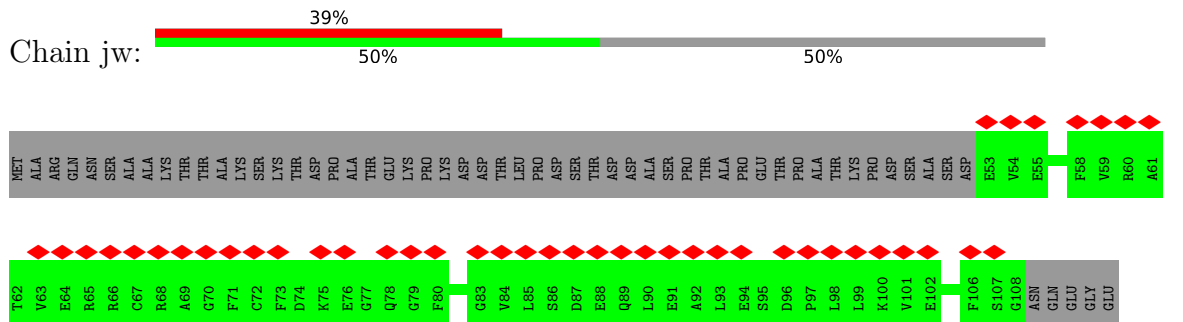

• Molecule 1: Mu-like prophage FluMu N-terminal domain-containing protein

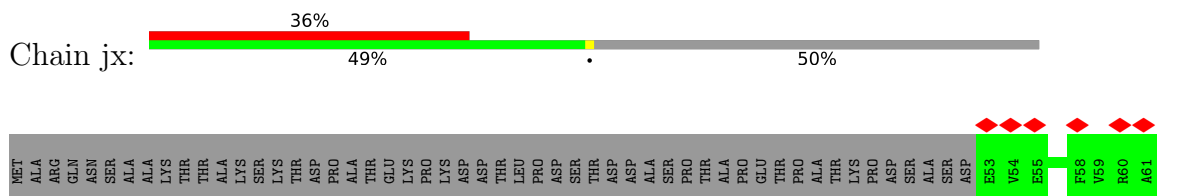

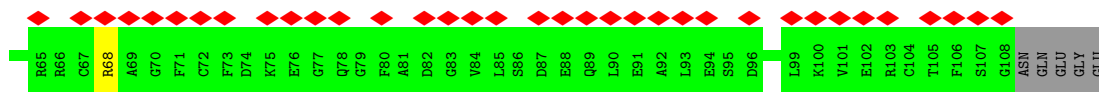

• Molecule 1: Mu-like prophage FluMu N-terminal domain-containing protein

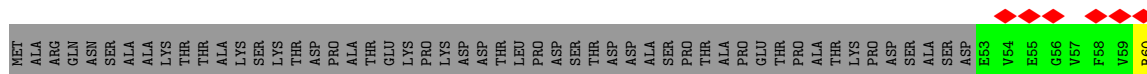
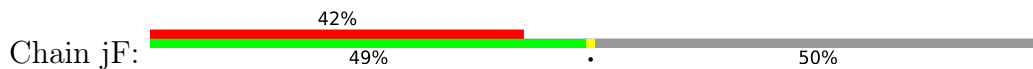

• Molecule 1: Mu-like prophage FluMu N-terminal domain-containing protein

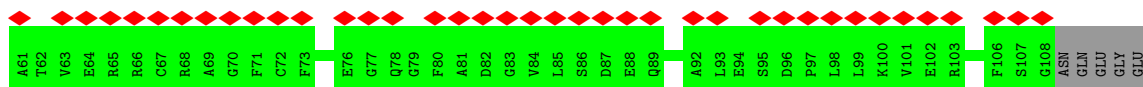
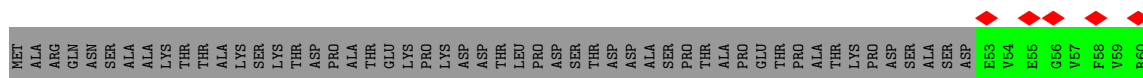
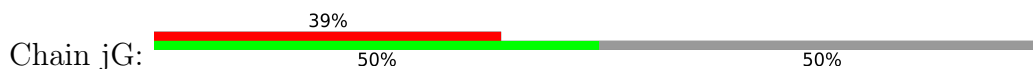

• Molecule 1: Mu-like prophage FluMu N-terminal domain-containing protein

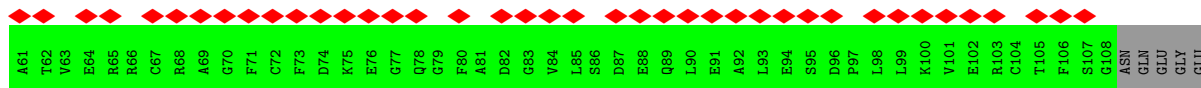
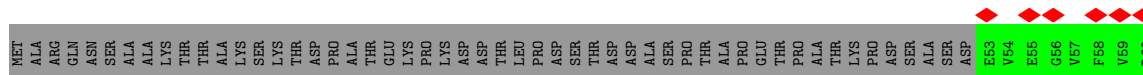
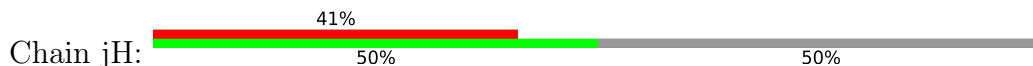

• Molecule 1: Mu-like prophage FluMu N-terminal domain-containing protein

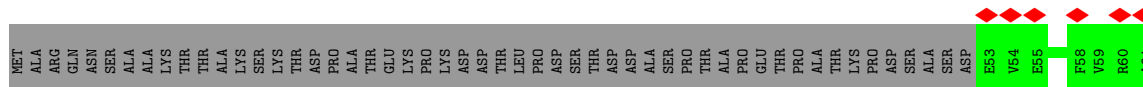

• Molecule 1: Mu-like prophage FluMu N-terminal domain-containing protein

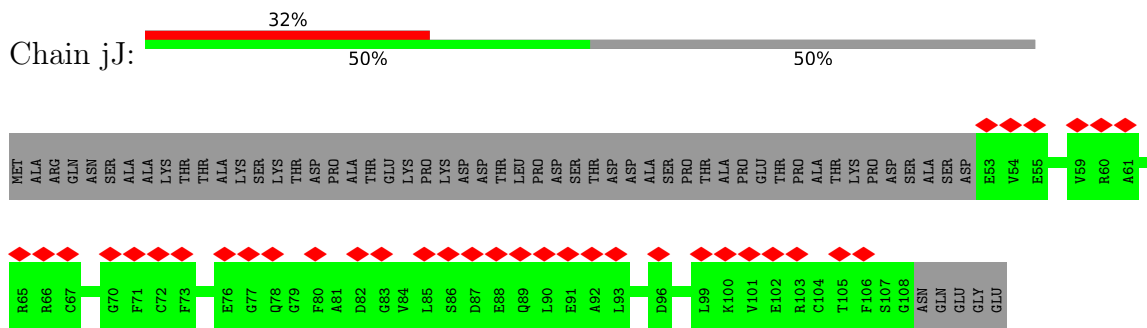

• Molecule 1: Mu-like prophage FluMu N-terminal domain-containing protein

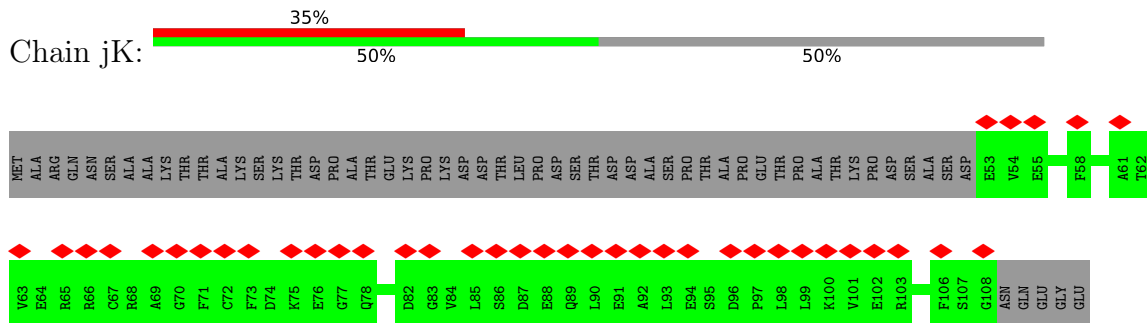

• Molecule 1: Mu-like prophage FluMu N-terminal domain-containing protein

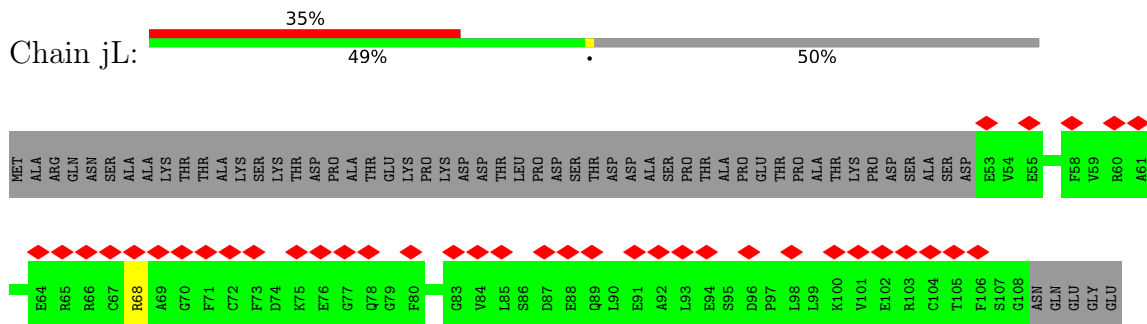

• Molecule 1: Mu-like prophage FluMu N-terminal domain-containing protein

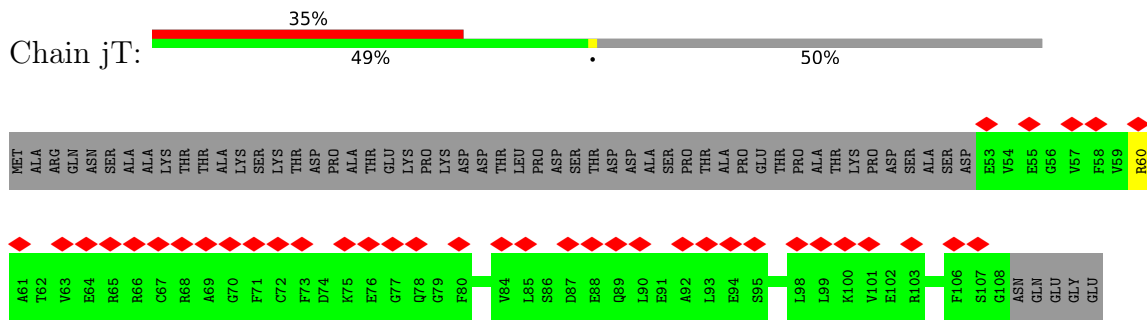

• Molecule 1: Mu-like prophage FluMu N-terminal domain-containing protein

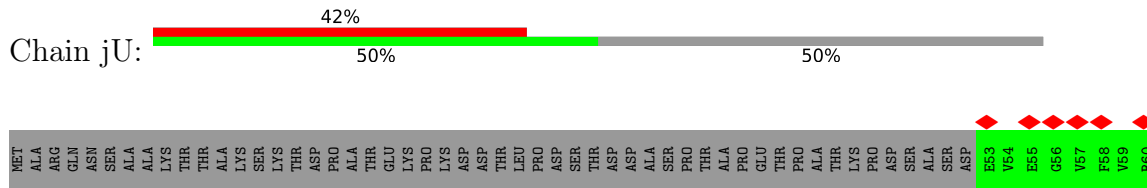

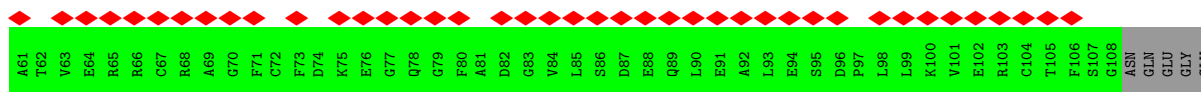

• Molecule 1: Mu-like prophage FluMu N-terminal domain-containing protein

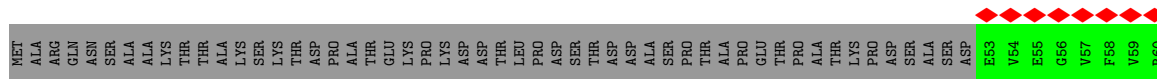
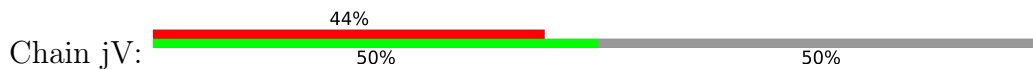

• Molecule 1: Mu-like prophage FluMu N-terminal domain-containing protein

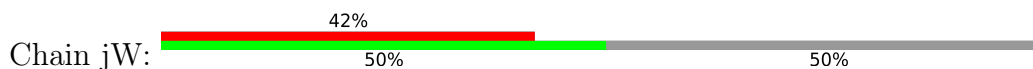

• Molecule 1: Mu-like prophage FluMu N-terminal domain-containing protein

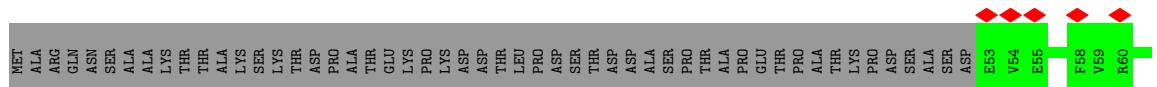

• Molecule 1: Mu-like prophage FluMu N-terminal domain-containing protein

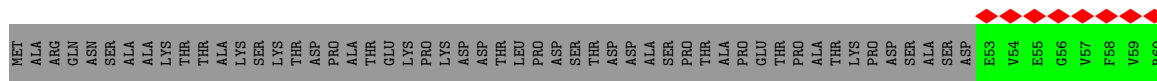
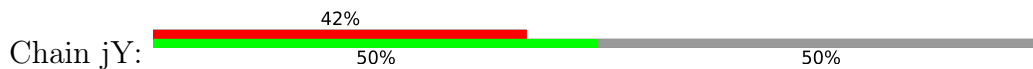

• Molecule 1: Mu-like prophage FluMu N-terminal domain-containing protein

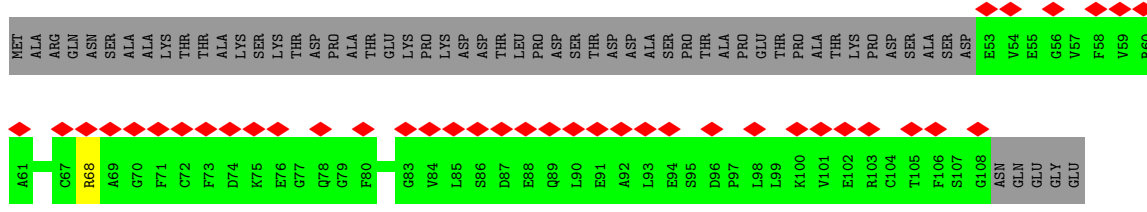

• Molecule 1: Mu-like prophage FluMu N-terminal domain-containing protein

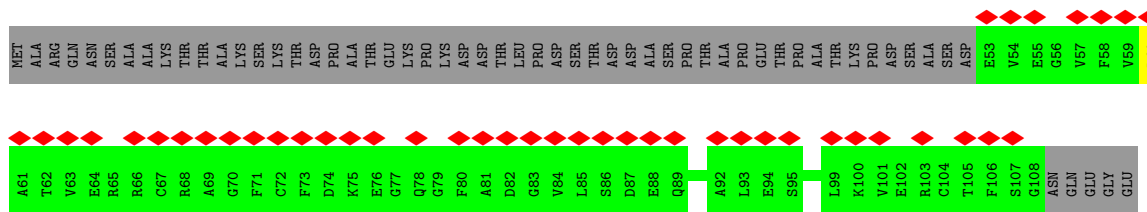
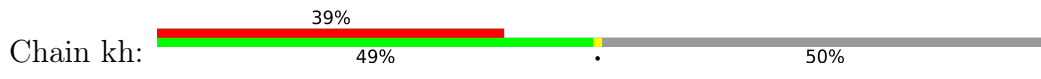

• Molecule 1: Mu-like prophage FluMu N-terminal domain-containing protein

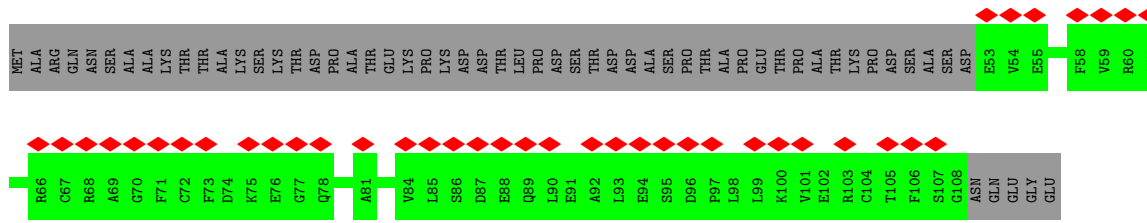

• Molecule 1: Mu-like prophage FluMu N-terminal domain-containing protein

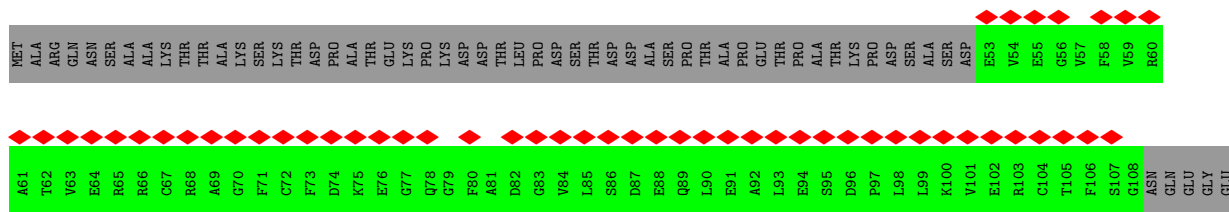

• Molecule 1: Mu-like prophage FluMu N-terminal domain-containing protein

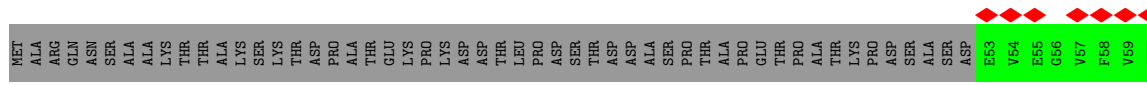
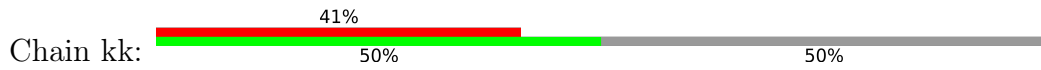

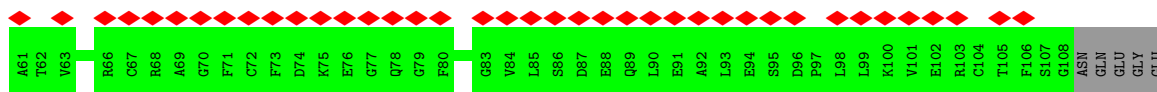

• Molecule 1: Mu-like prophage FluMu N-terminal domain-containing protein

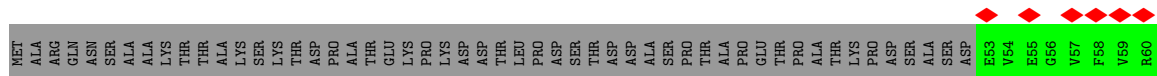
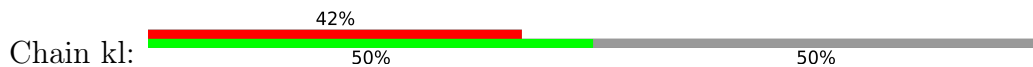

• Molecule 1: Mu-like prophage FluMu N-terminal domain-containing protein

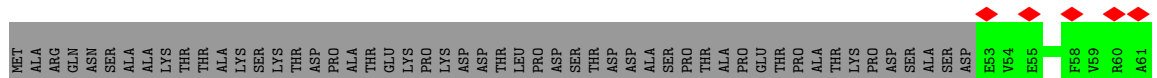
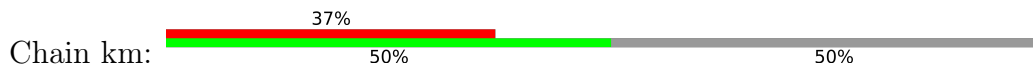

• Molecule 1: Mu-like prophage FluMu N-terminal domain-containing protein

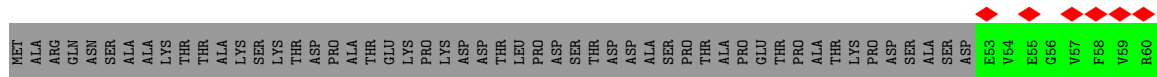

• Molecule 1: Mu-like prophage FluMu N-terminal domain-containing protein

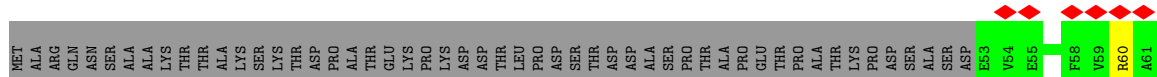
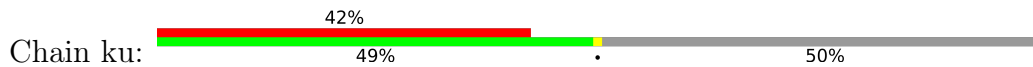

• Molecule 1: Mu-like prophage FluMu N-terminal domain-containing protein

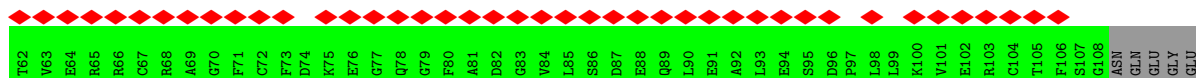

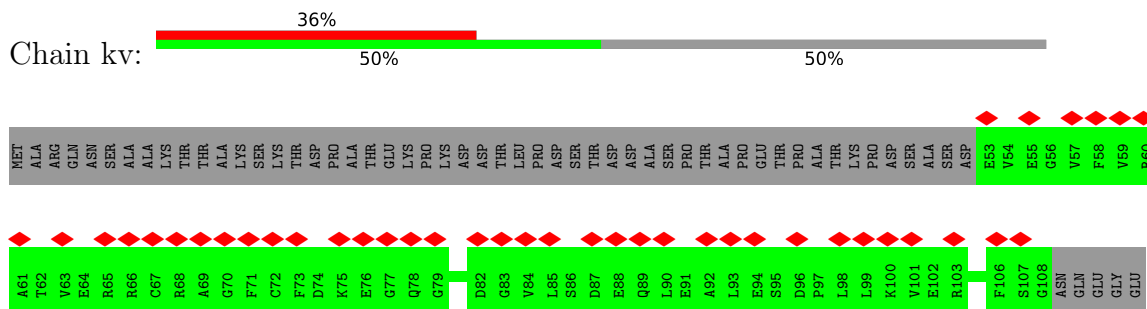

• Molecule 1: Mu-like prophage FluMu N-terminal domain-containing protein

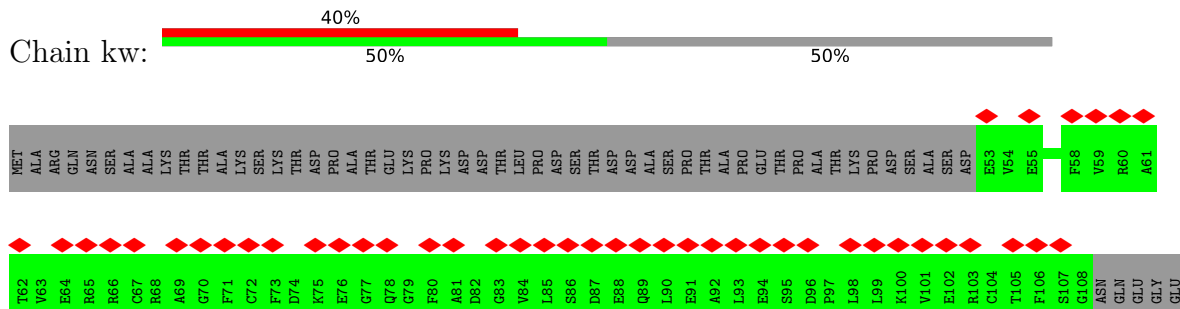

• Molecule 1: Mu-like prophage FluMu N-terminal domain-containing protein

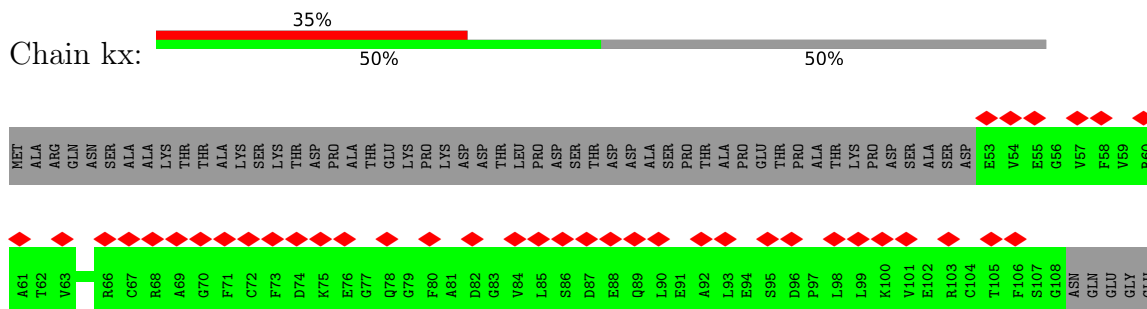

• Molecule 1: Mu-like prophage FluMu N-terminal domain-containing protein

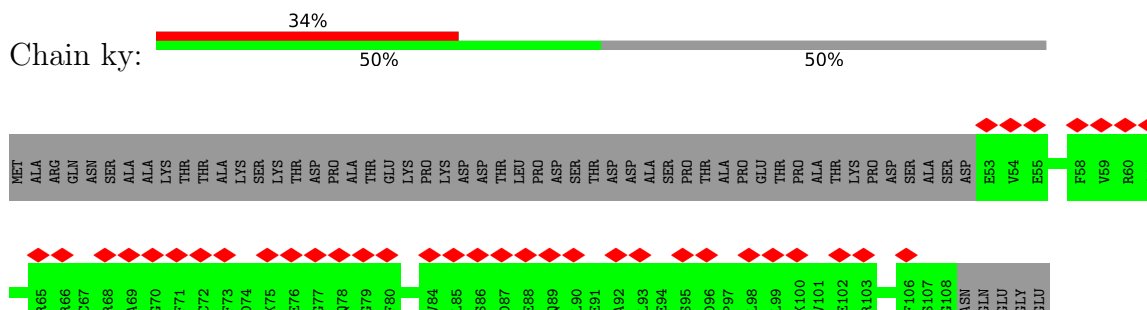

• Molecule 1: Mu-like prophage FluMu N-terminal domain-containing protein

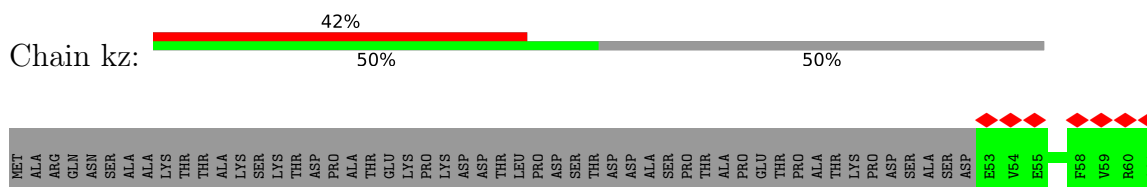

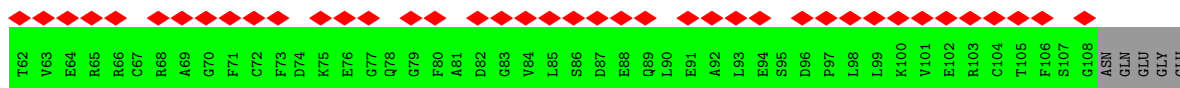

- Molecule 1: Mu-like prophage FluMu N-terminal domain-containing protein

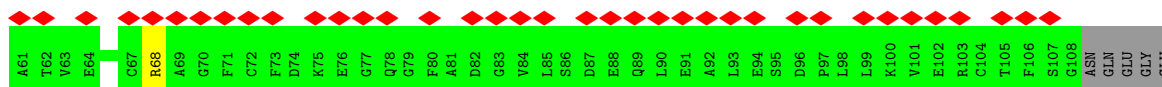
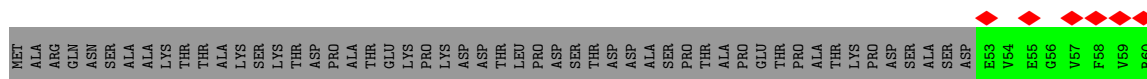
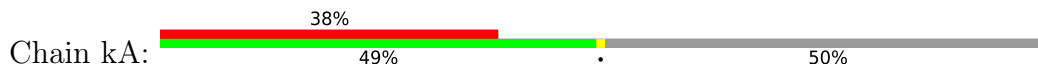

- Molecule 1: Mu-like prophage FluMu N-terminal domain-containing protein

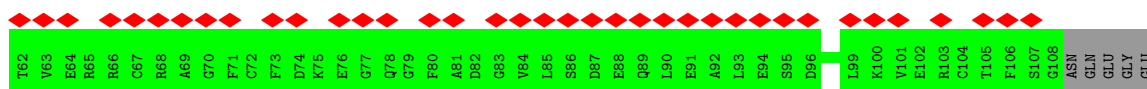
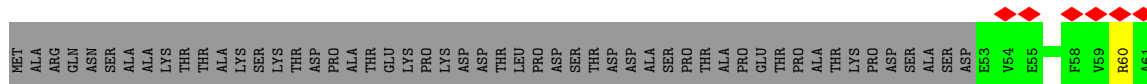
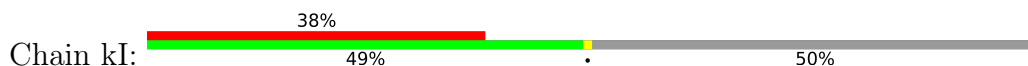

- Molecule 1: Mu-like prophage FluMu N-terminal domain-containing protein

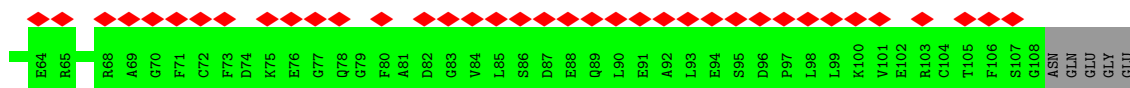
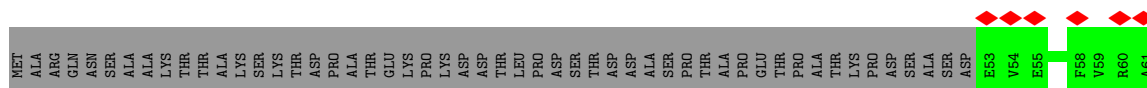
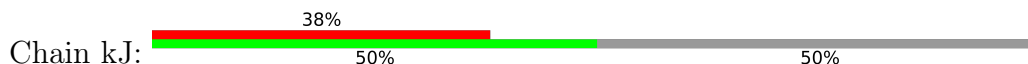

- Molecule 1: Mu-like prophage FluMu N-terminal domain-containing protein

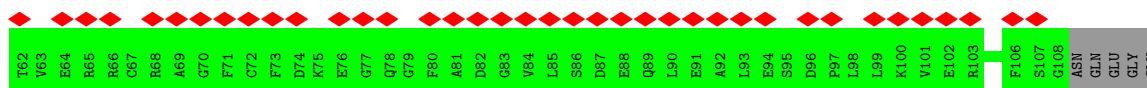
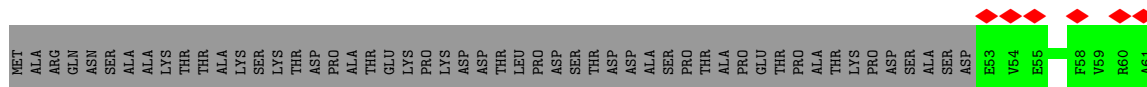
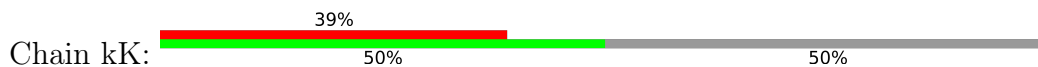

- Molecule 1: Mu-like prophage FluMu N-terminal domain-containing protein

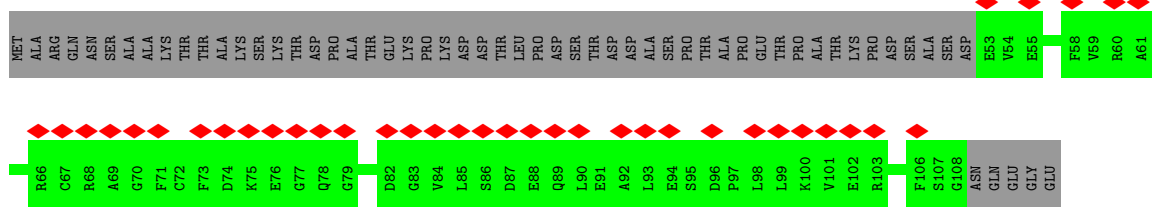

• Molecule 1: Mu-like prophage FluMu N-terminal domain-containing protein

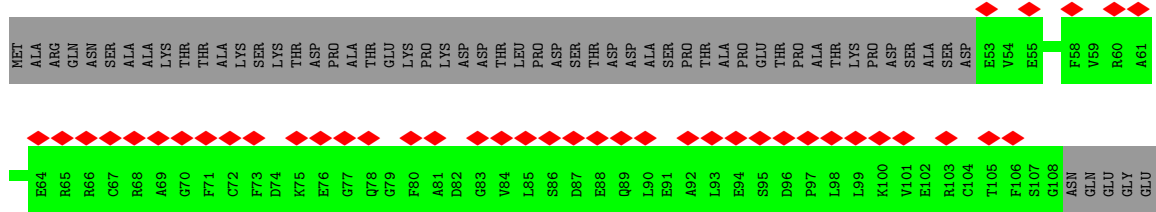

• Molecule 1: Mu-like prophage FluMu N-terminal domain-containing protein

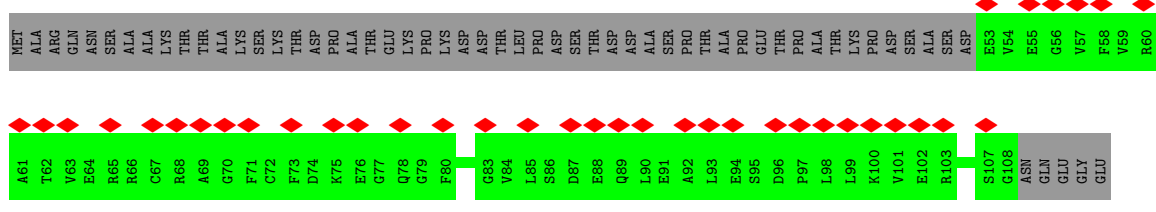

• Molecule 1: Mu-like prophage FluMu N-terminal domain-containing protein

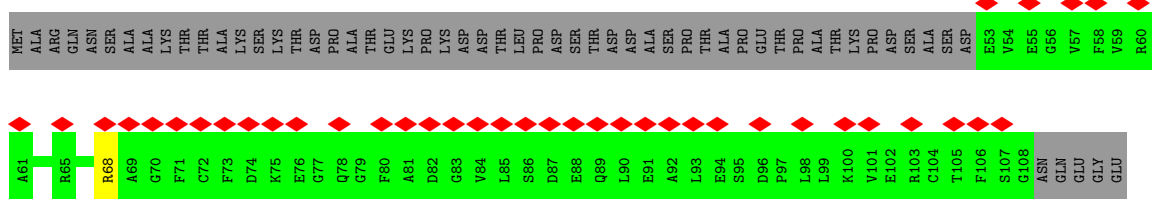

• Molecule 1: Mu-like prophage FluMu N-terminal domain-containing protein



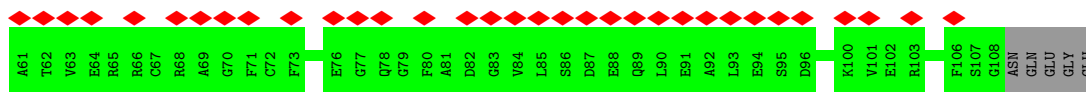

- Molecule 1: Mu-like prophage FluMu N-terminal domain-containing protein

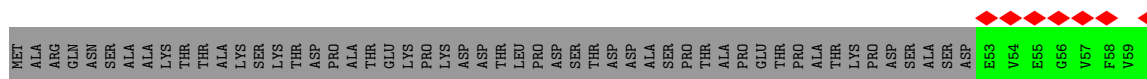

- Molecule 1: Mu-like prophage FluMu N-terminal domain-containing protein

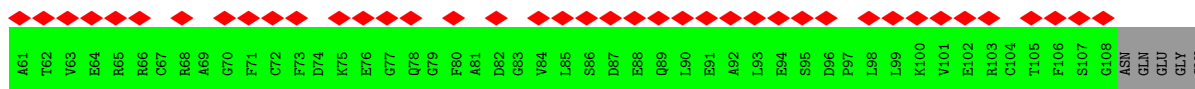
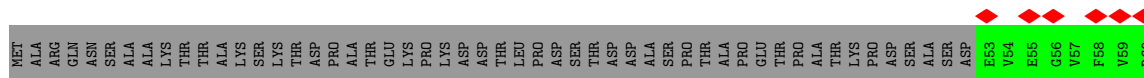
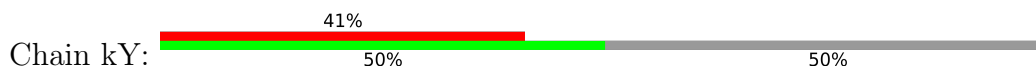

- Molecule 1: Mu-like prophage FluMu N-terminal domain-containing protein

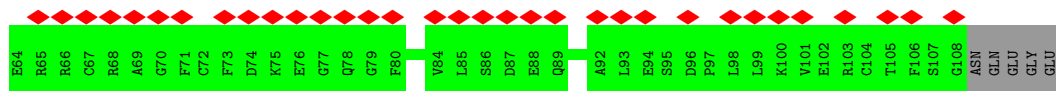
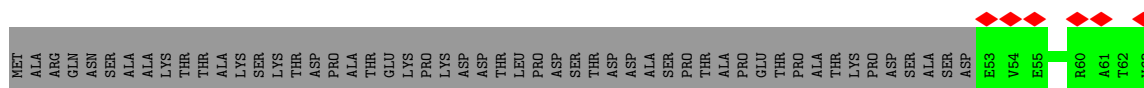

- Molecule 1: Mu-like prophage FluMu N-terminal domain-containing protein

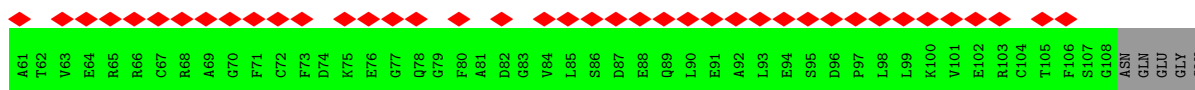
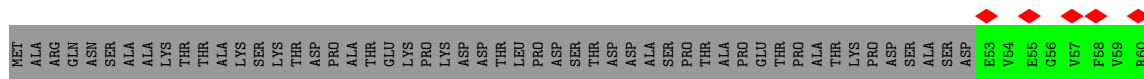
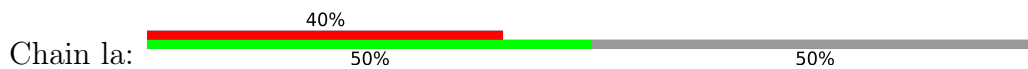

- Molecule 1: Mu-like prophage FluMu N-terminal domain-containing protein

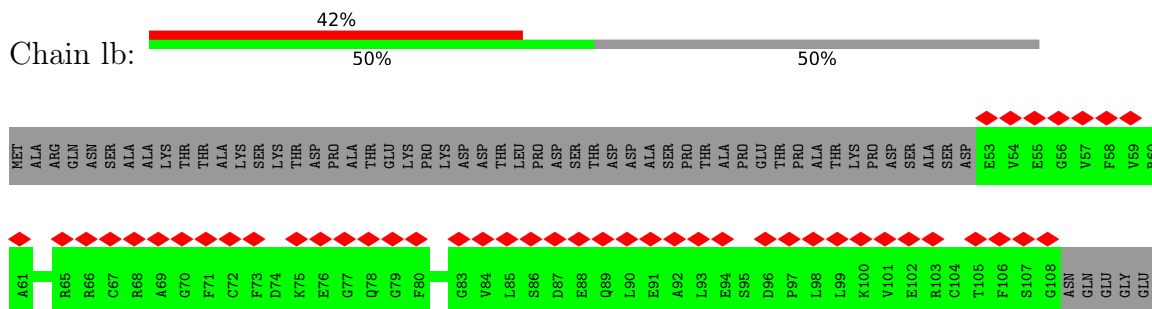

• Molecule 1: Mu-like prophage FluMu N-terminal domain-containing protein

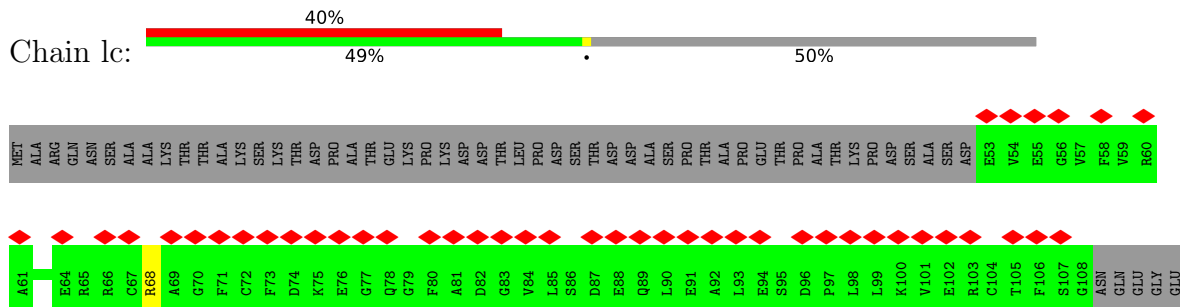

• Molecule 1: Mu-like prophage FluMu N-terminal domain-containing protein

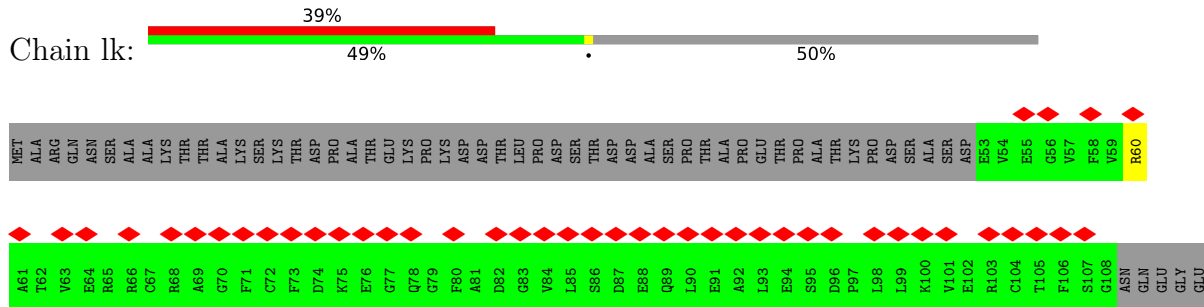

• Molecule 1: Mu-like prophage FluMu N-terminal domain-containing protein

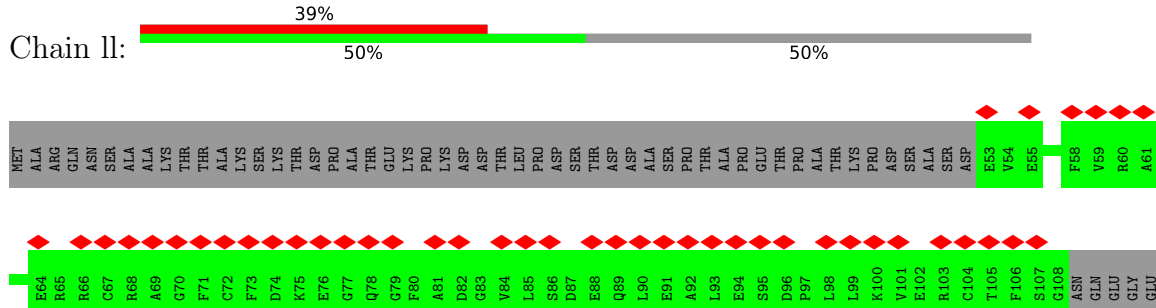

• Molecule 1: Mu-like prophage FluMu N-terminal domain-containing protein

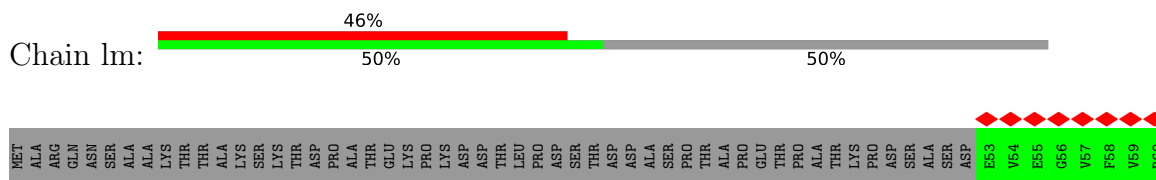

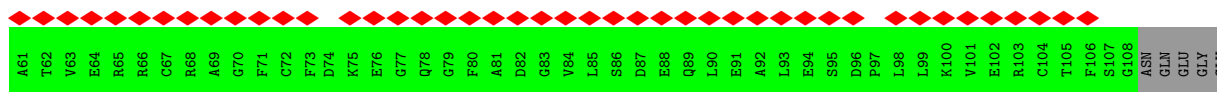

• Molecule 1: Mu-like prophage FluMu N-terminal domain-containing protein

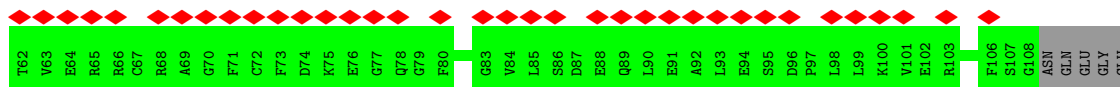
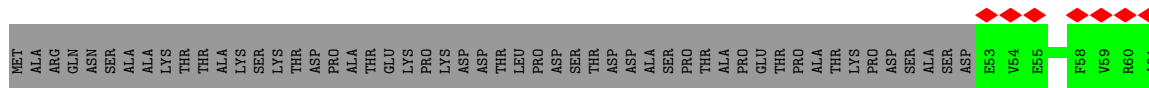
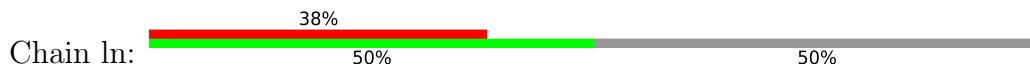

• Molecule 1: Mu-like prophage FluMu N-terminal domain-containing protein

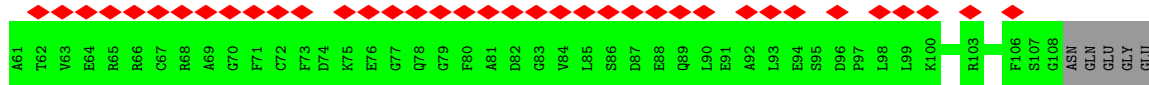
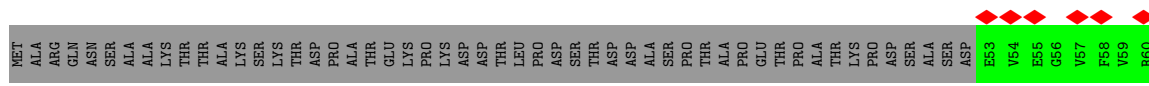
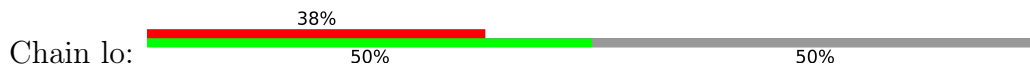

• Molecule 1: Mu-like prophage FluMu N-terminal domain-containing protein

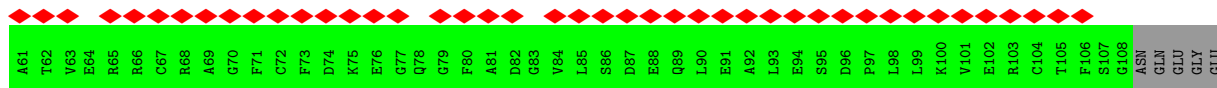
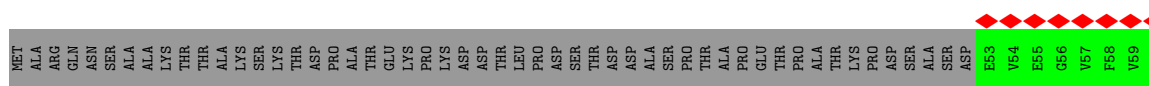

• Molecule 1: Mu-like prophage FluMu N-terminal domain-containing protein

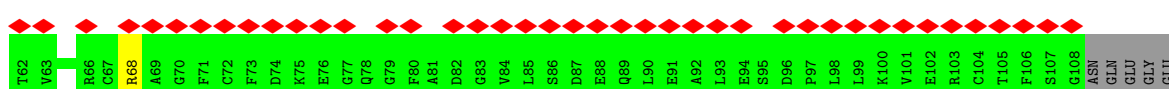
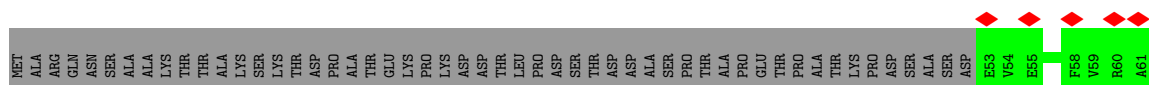
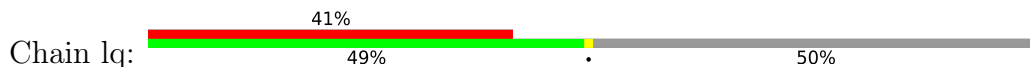

• Molecule 1: Mu-like prophage FluMu N-terminal domain-containing protein

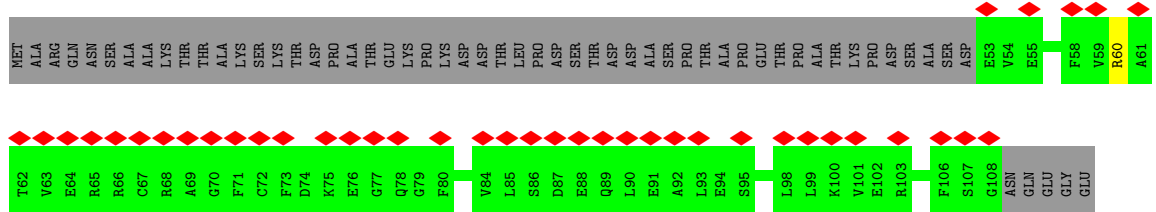

• Molecule 1: Mu-like prophage FluMu N-terminal domain-containing protein

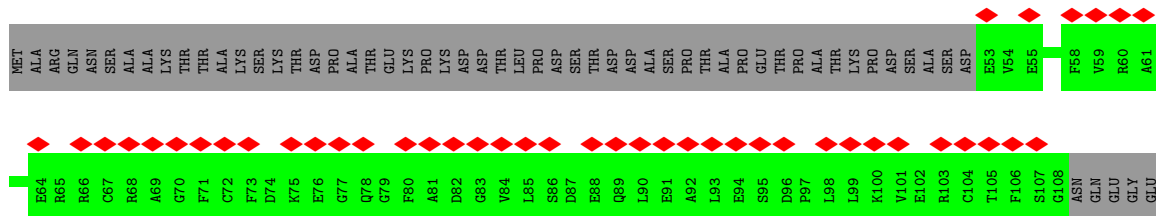
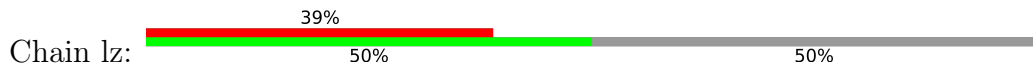

• Molecule 1: Mu-like prophage FluMu N-terminal domain-containing protein

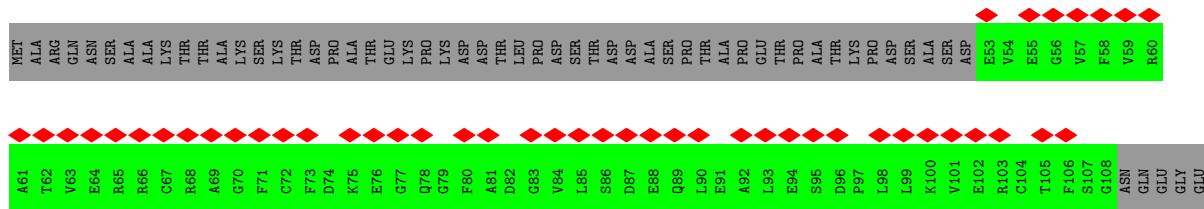
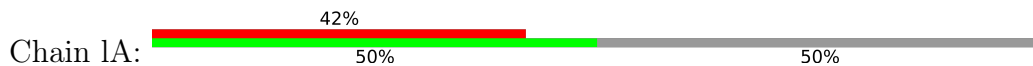

• Molecule 1: Mu-like prophage FluMu N-terminal domain-containing protein

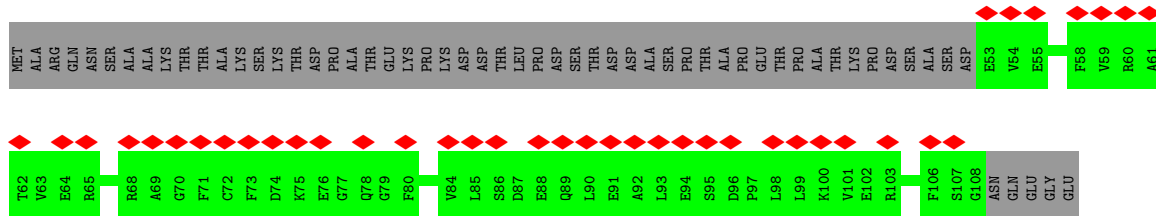

• Molecule 1: Mu-like prophage FluMu N-terminal domain-containing protein



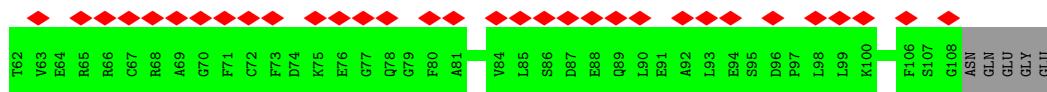

• Molecule 1: Mu-like prophage FluMu N-terminal domain-containing protein

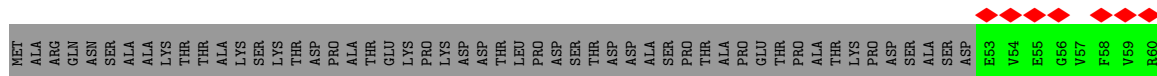
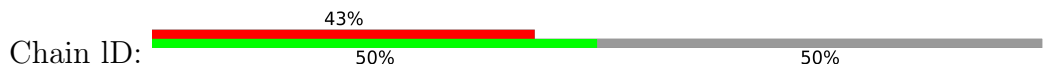

• Molecule 1: Mu-like prophage FluMu N-terminal domain-containing protein

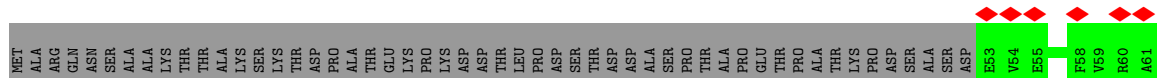
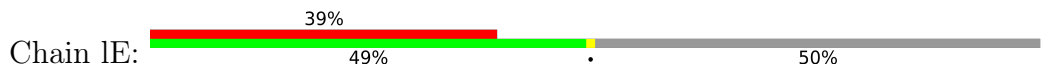

• Molecule 1: Mu-like prophage FluMu N-terminal domain-containing protein

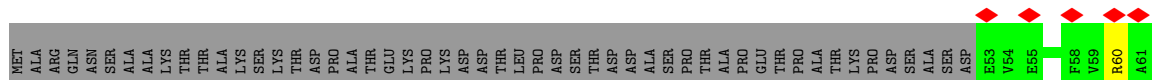
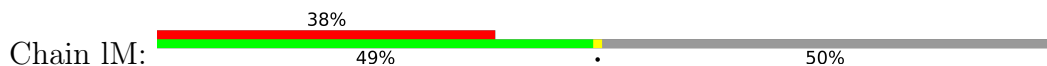

• Molecule 1: Mu-like prophage FluMu N-terminal domain-containing protein

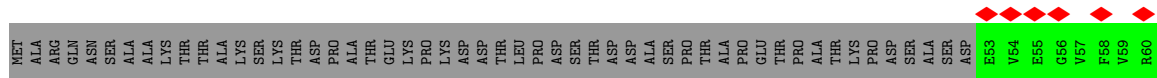
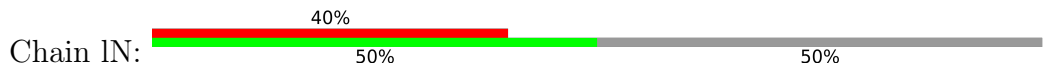

• Molecule 1: Mu-like prophage FluMu N-terminal domain-containing protein

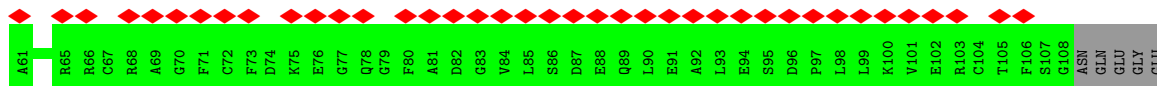



• Molecule 1: Mu-like prophage FluMu N-terminal domain-containing protein

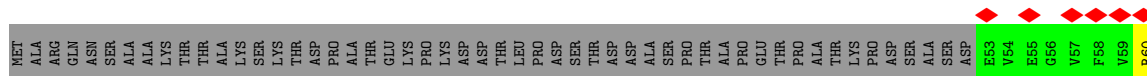

• Molecule 1: Mu-like prophage FluMu N-terminal domain-containing protein

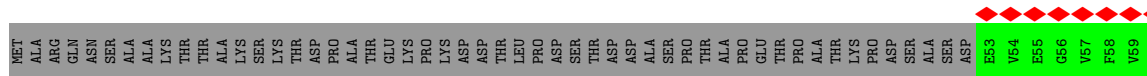

• Molecule 1: Mu-like prophage FluMu N-terminal domain-containing protein

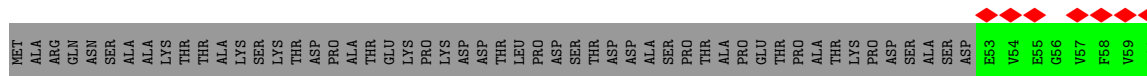
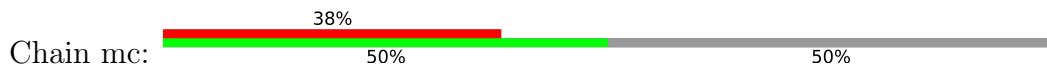

• Molecule 1: Mu-like prophage FluMu N-terminal domain-containing protein

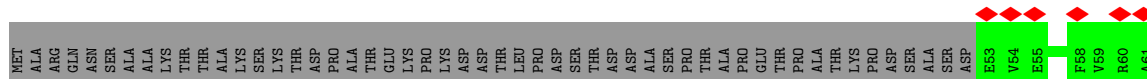

• Molecule 1: Mu-like prophage FluMu N-terminal domain-containing protein



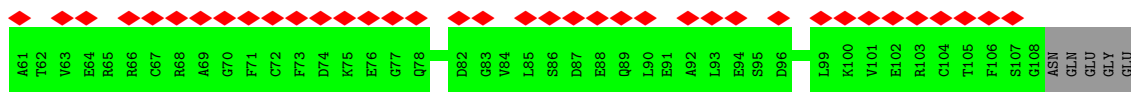

• Molecule 1: Mu-like prophage FluMu N-terminal domain-containing protein

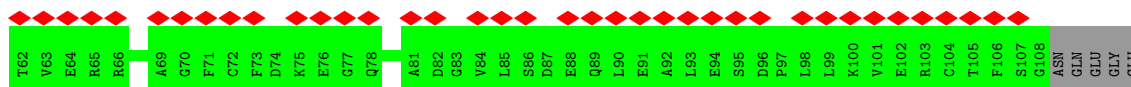
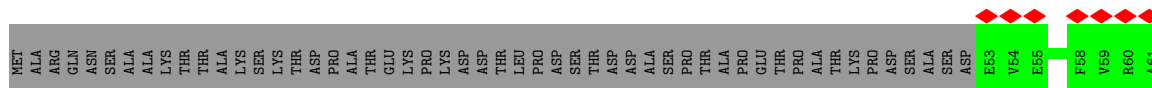
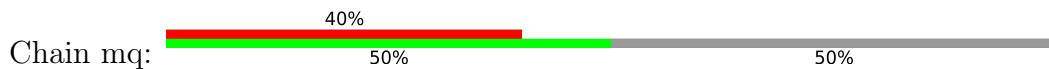

• Molecule 1: Mu-like prophage FluMu N-terminal domain-containing protein

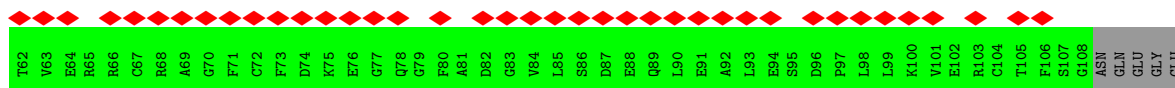
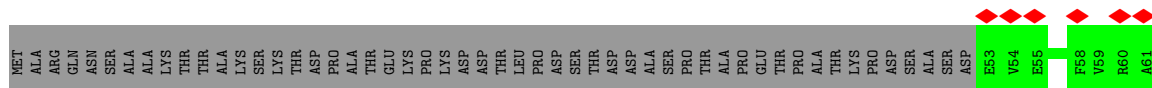
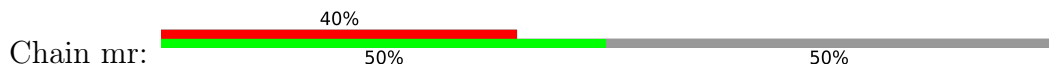

• Molecule 1: Mu-like prophage FluMu N-terminal domain-containing protein

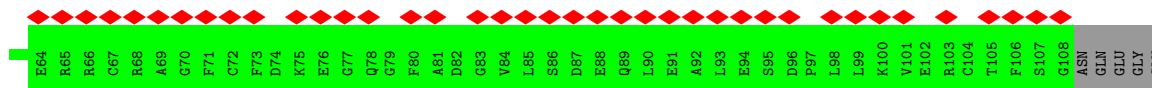
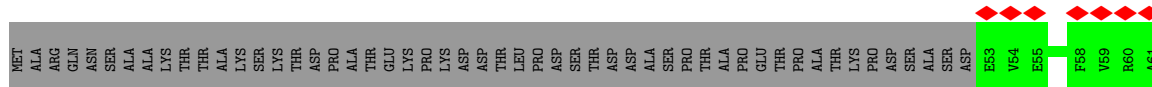
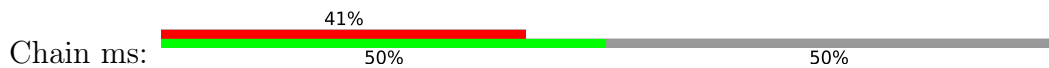

• Molecule 1: Mu-like prophage FluMu N-terminal domain-containing protein

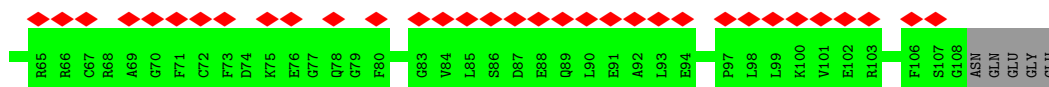

• Molecule 1: Mu-like prophage FluMu N-terminal domain-containing protein

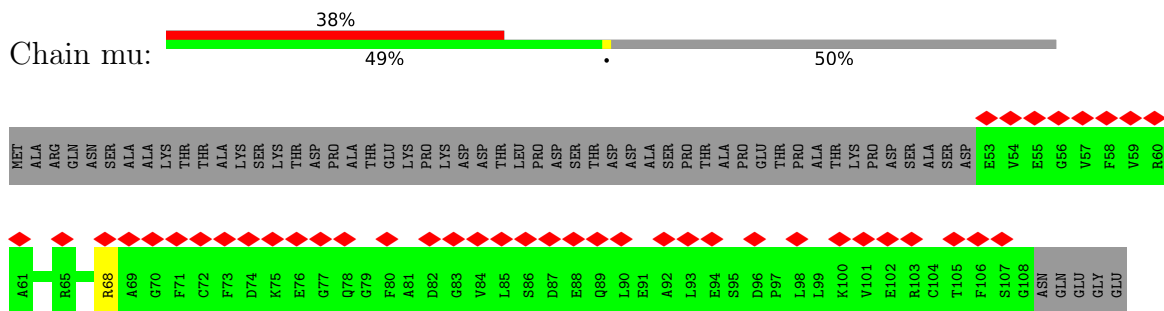

• Molecule 1: Mu-like prophage FluMu N-terminal domain-containing protein

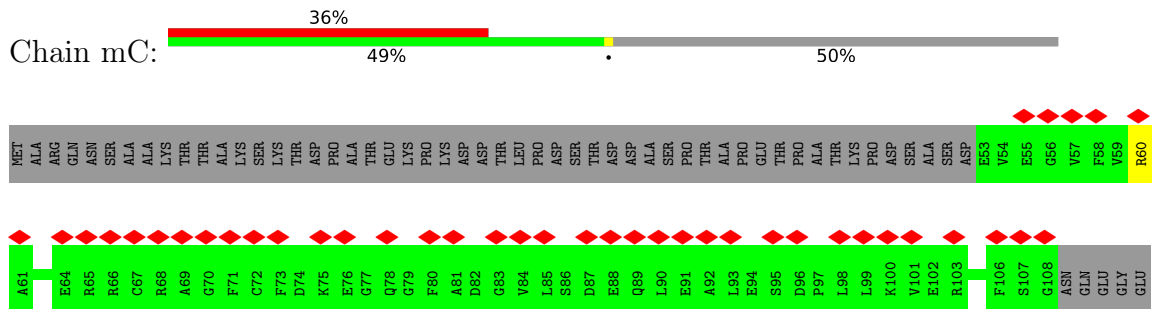

• Molecule 1: Mu-like prophage FluMu N-terminal domain-containing protein



• Molecule 1: Mu-like prophage FluMu N-terminal domain-containing protein

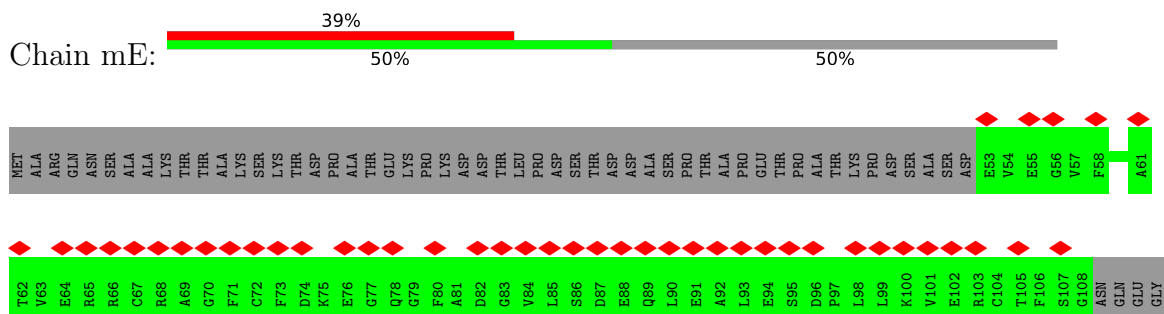

• Molecule 1: Mu-like prophage FluMu N-terminal domain-containing protein

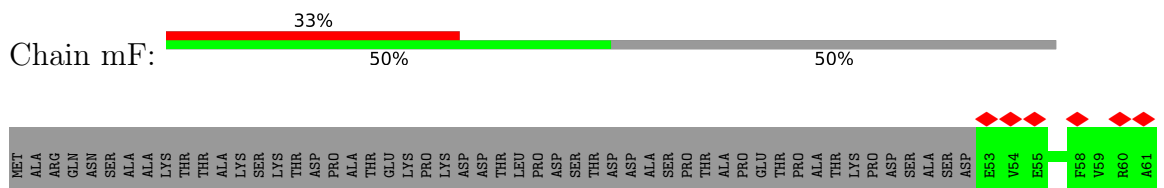



- Molecule 1: Mu-like prophage FluMu N-terminal domain-containing protein

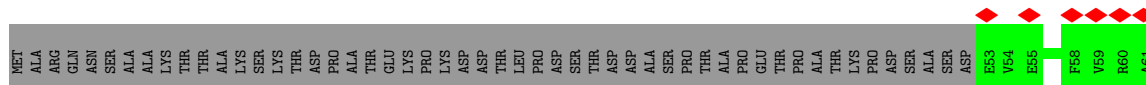

- Molecule 1: Mu-like prophage FluMu N-terminal domain-containing protein

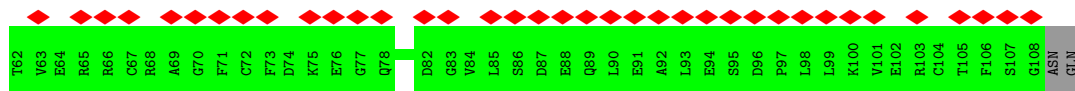
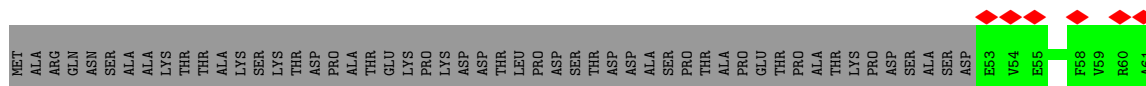
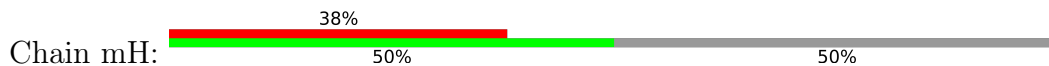

- Molecule 1: Mu-like prophage FluMu N-terminal domain-containing protein

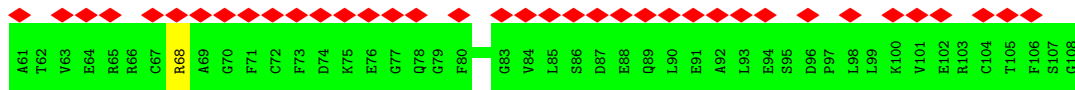
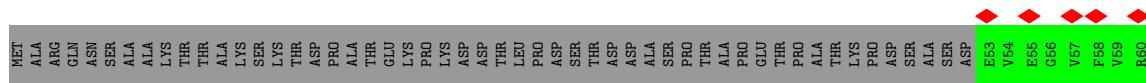

- Molecule 1: Mu-like prophage FluMu N-terminal domain-containing protein

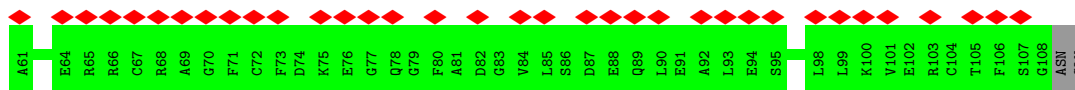
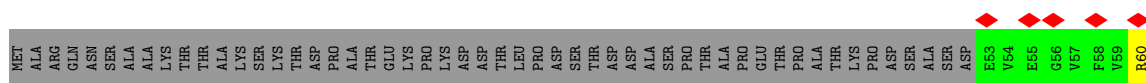

- Molecule 1: Mu-like prophage FluMu N-terminal domain-containing protein

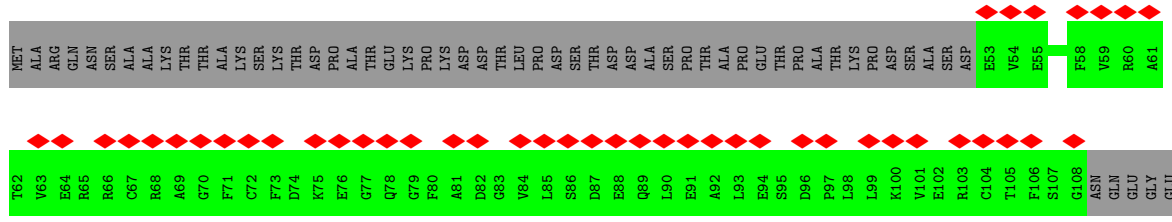
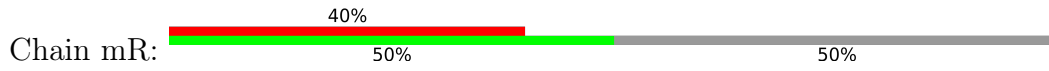

- Molecule 1: Mu-like prophage FluMu N-terminal domain-containing protein

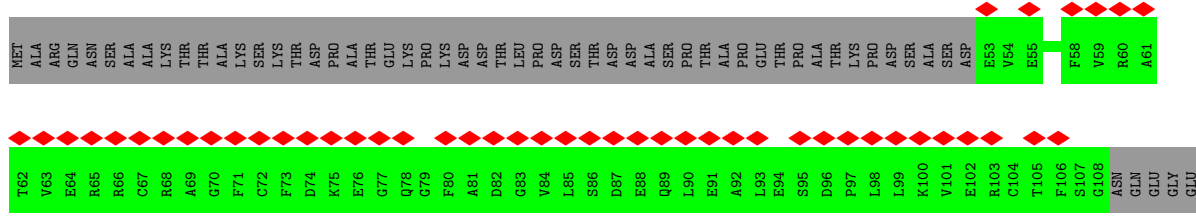
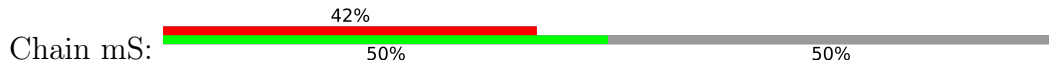

- Molecule 1: Mu-like prophage FluMu N-terminal domain-containing protein

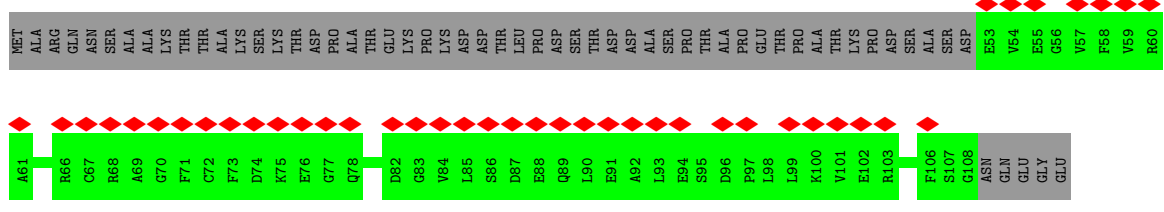
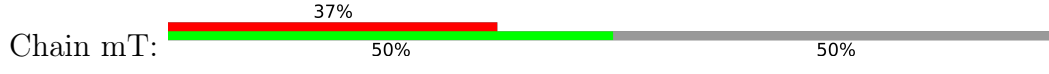

- Molecule 1: Mu-like prophage FluMu N-terminal domain-containing protein

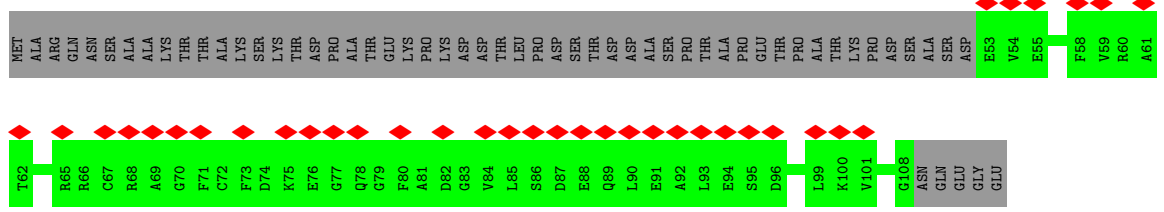

- Molecule 1: Mu-like prophage FluMu N-terminal domain-containing protein

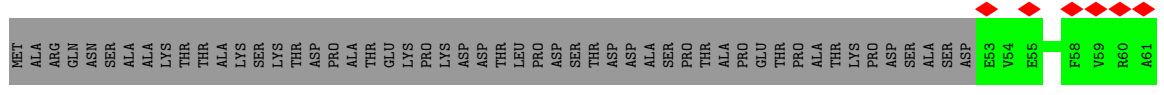
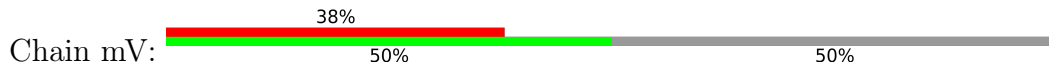



• Molecule 1: Mu-like prophage FluMu N-terminal domain-containing protein

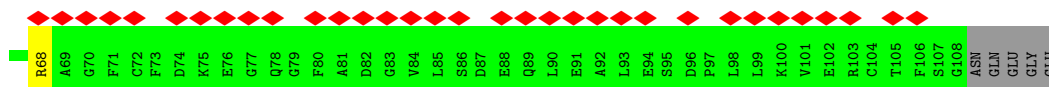
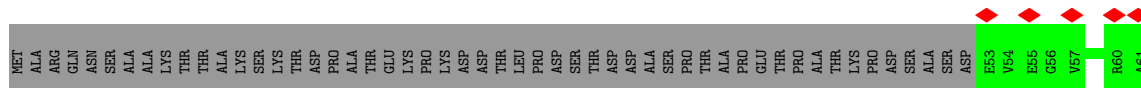

• Molecule 1: Mu-like prophage FluMu N-terminal domain-containing protein

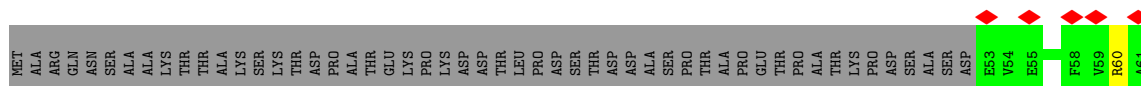

• Molecule 1: Mu-like prophage FluMu N-terminal domain-containing protein

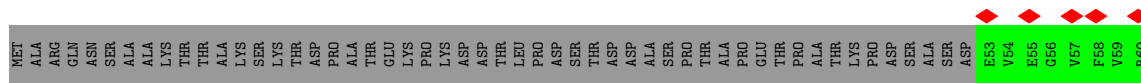

• Molecule 1: Mu-like prophage FluMu N-terminal domain-containing protein

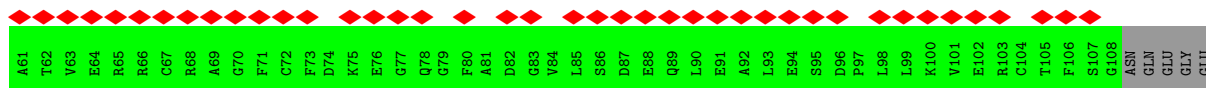
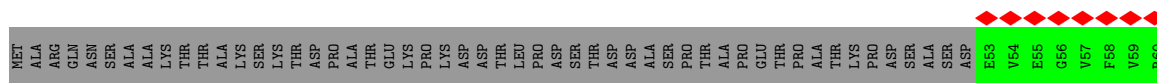
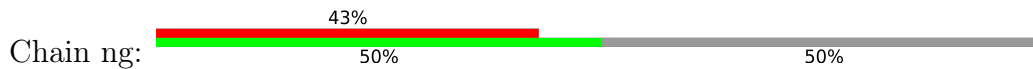

• Molecule 1: Mu-like prophage FluMu N-terminal domain-containing protein

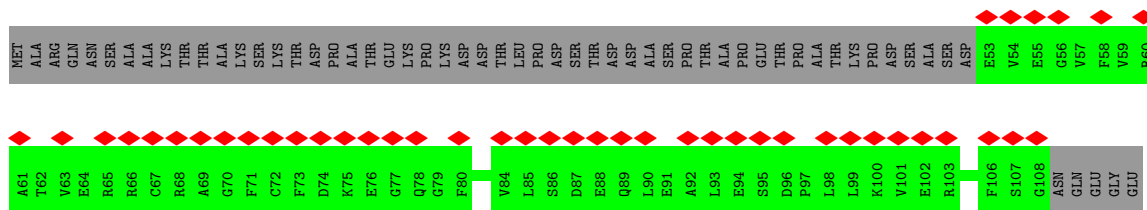

• Molecule 1: Mu-like prophage FluMu N-terminal domain-containing protein

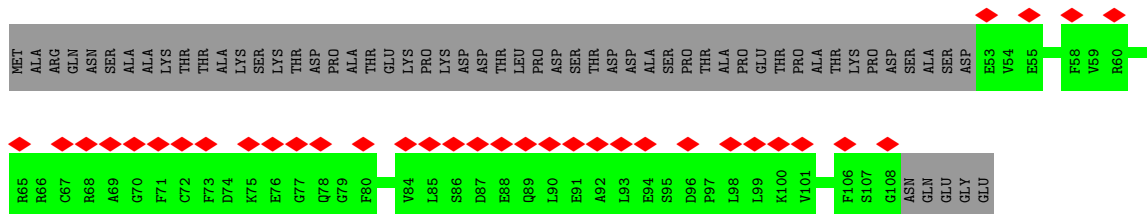

• Molecule 1: Mu-like prophage FluMu N-terminal domain-containing protein

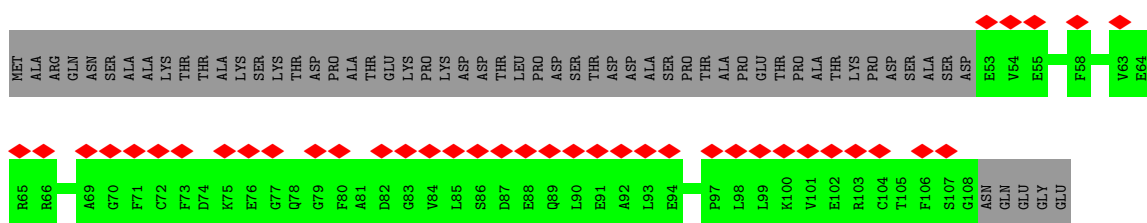

• Molecule 1: Mu-like prophage FluMu N-terminal domain-containing protein

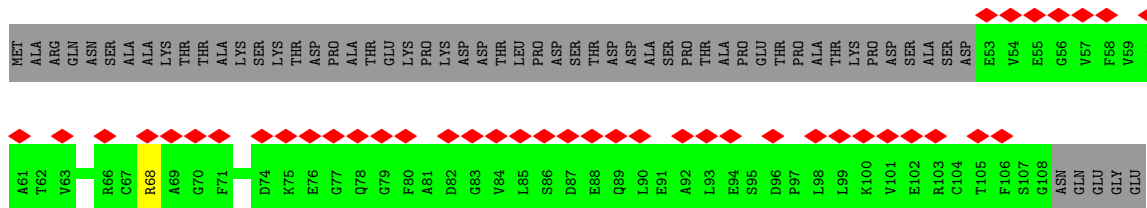

• Molecule 1: Mu-like prophage FluMu N-terminal domain-containing protein

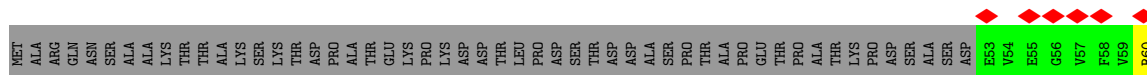
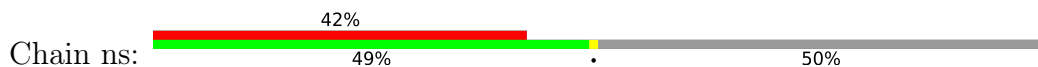

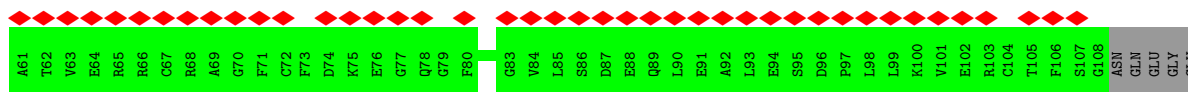

● Molecule 1: Mu-like prophage FluMu N-terminal domain-containing protein

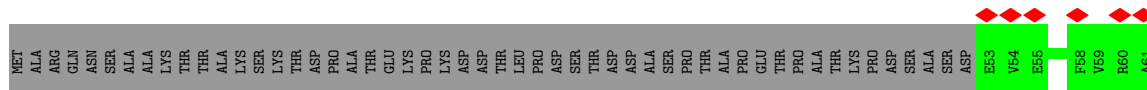

● Molecule 1: Mu-like prophage FluMu N-terminal domain-containing protein

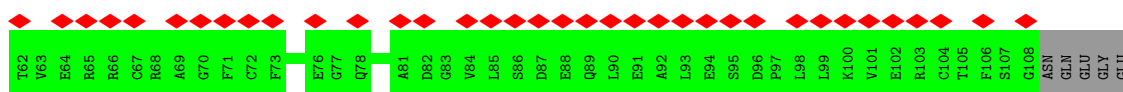
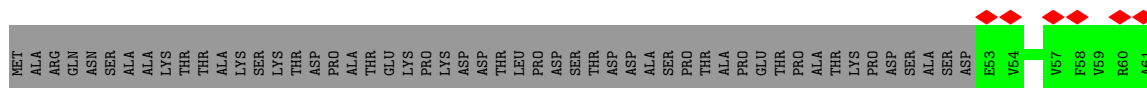

● Molecule 1: Mu-like prophage FluMu N-terminal domain-containing protein

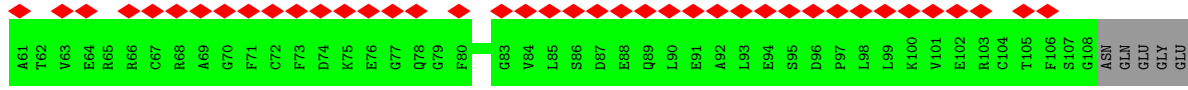
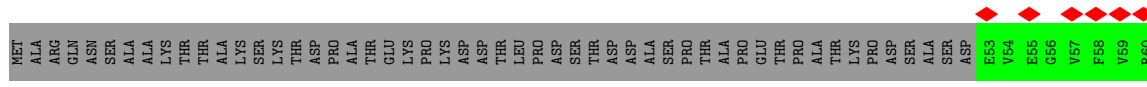
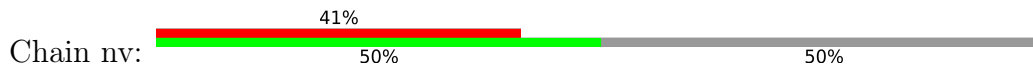

● Molecule 1: Mu-like prophage FluMu N-terminal domain-containing protein

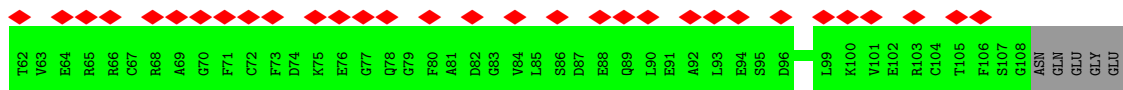
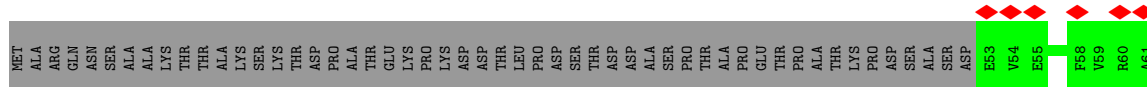

● Molecule 1: Mu-like prophage FluMu N-terminal domain-containing protein

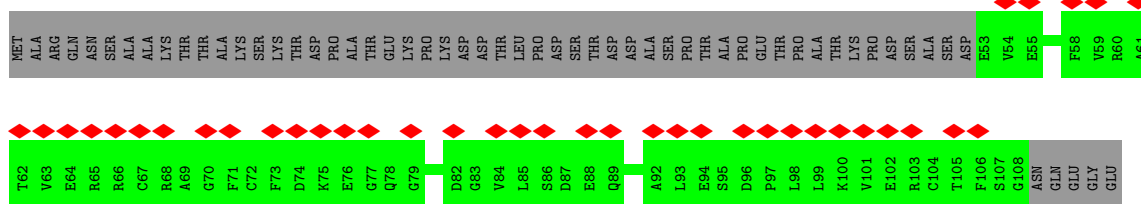

• Molecule 1: Mu-like prophage FluMu N-terminal domain-containing protein

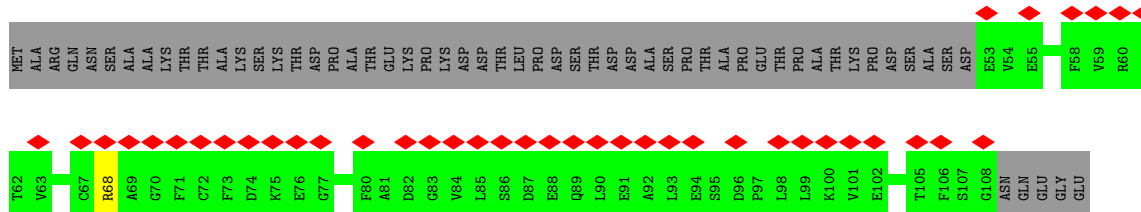

• Molecule 1: Mu-like prophage FluMu N-terminal domain-containing protein

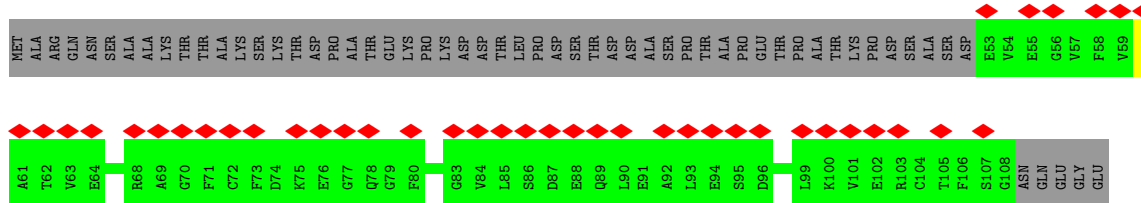

• Molecule 1: Mu-like prophage FluMu N-terminal domain-containing protein

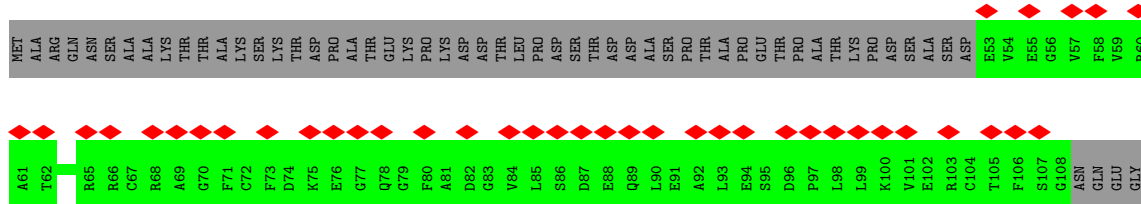

• Molecule 1: Mu-like prophage FluMu N-terminal domain-containing protein

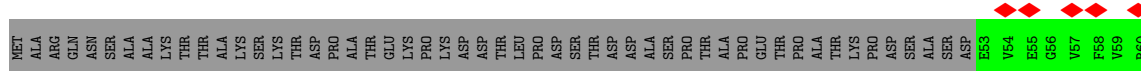

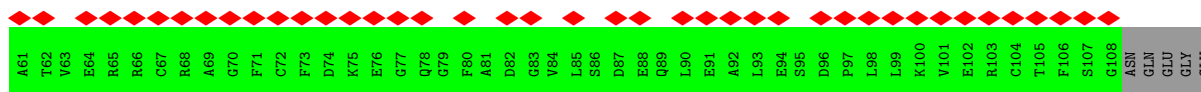

• Molecule 1: Mu-like prophage FluMu N-terminal domain-containing protein

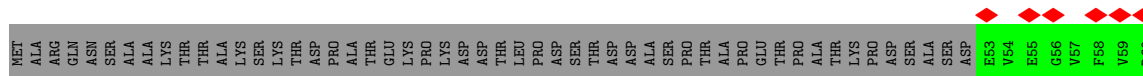

• Molecule 1: Mu-like prophage FluMu N-terminal domain-containing protein

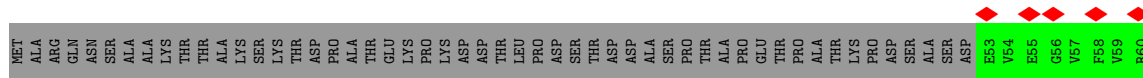

• Molecule 1: Mu-like prophage FluMu N-terminal domain-containing protein

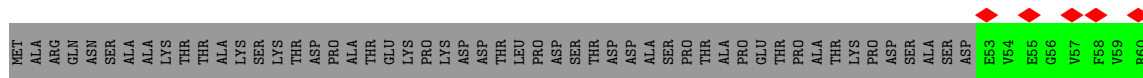

• Molecule 1: Mu-like prophage FluMu N-terminal domain-containing protein

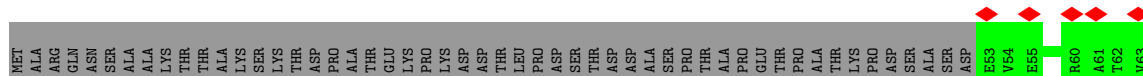

• Molecule 1: Mu-like prophage FluMu N-terminal domain-containing protein

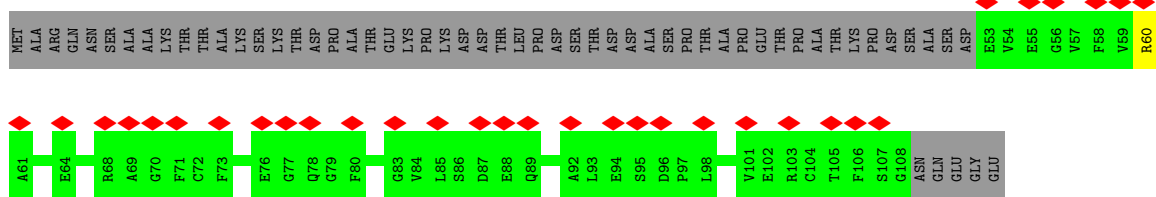

• Molecule 1: Mu-like prophage FluMu N-terminal domain-containing protein

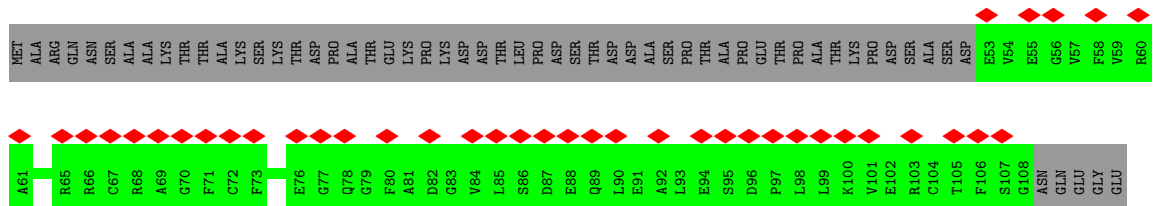

• Molecule 1: Mu-like prophage FluMu N-terminal domain-containing protein

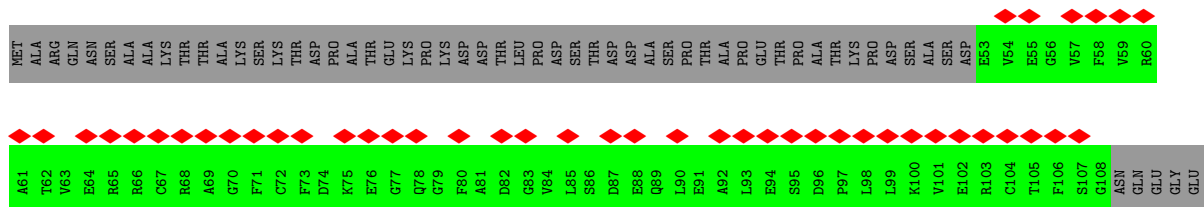
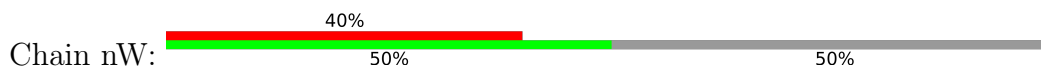

• Molecule 1: Mu-like prophage FluMu N-terminal domain-containing protein

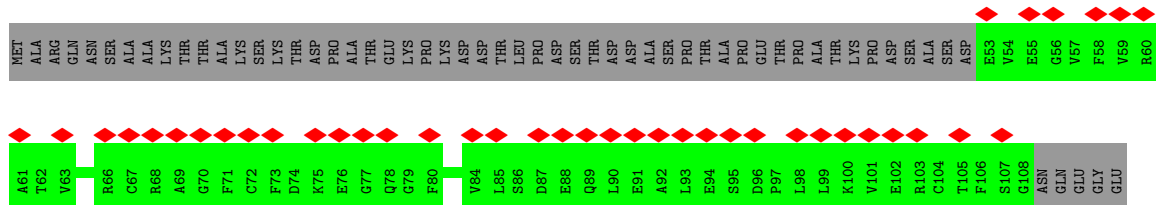

• Molecule 1: Mu-like prophage FluMu N-terminal domain-containing protein

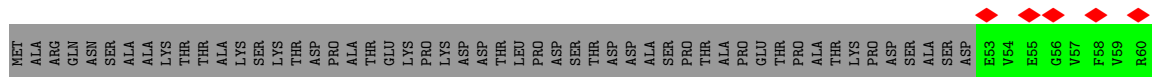

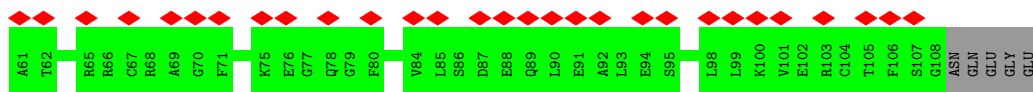

• Molecule 1: Mu-like prophage FluMu N-terminal domain-containing protein

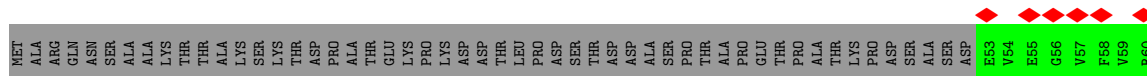
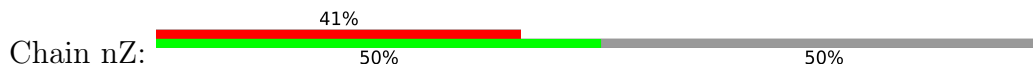

• Molecule 1: Mu-like prophage FluMu N-terminal domain-containing protein

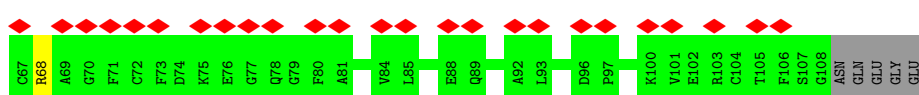
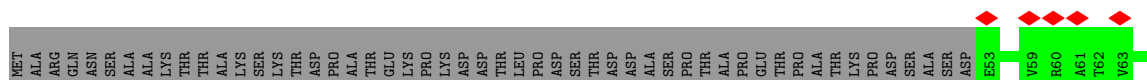

• Molecule 1: Mu-like prophage FluMu N-terminal domain-containing protein

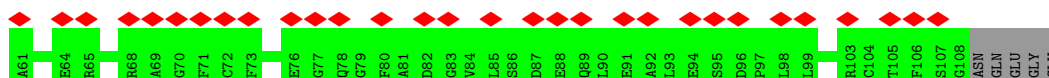
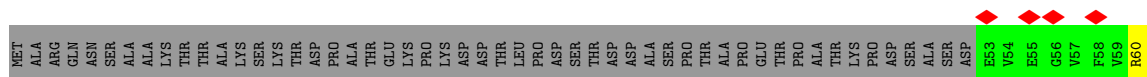

• Molecule 1: Mu-like prophage FluMu N-terminal domain-containing protein

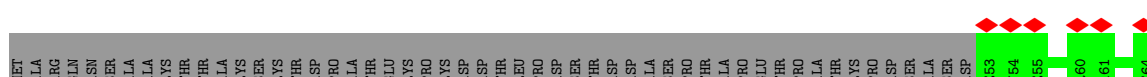

• Molecule 1: Mu-like prophage FluMu N-terminal domain-containing protein

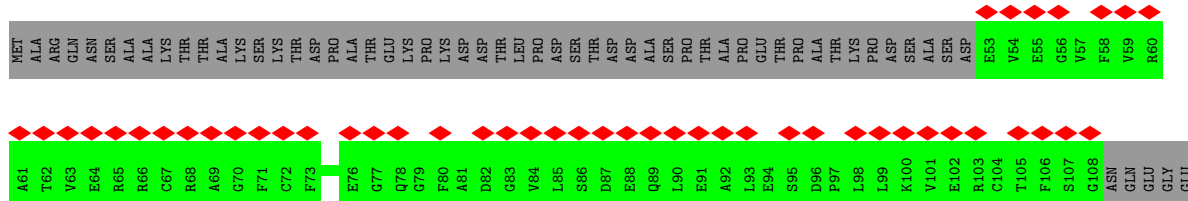

• Molecule 1: Mu-like prophage FluMu N-terminal domain-containing protein

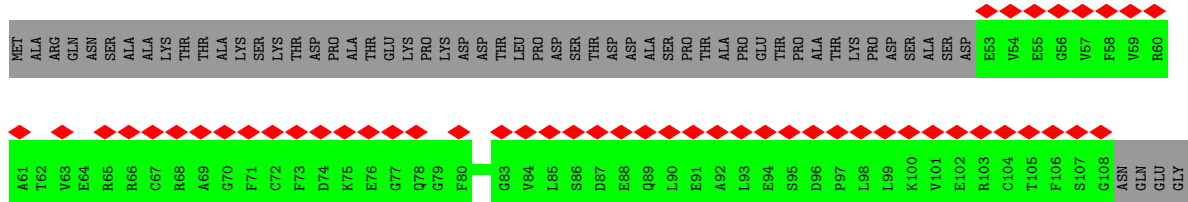

• Molecule 1: Mu-like prophage FluMu N-terminal domain-containing protein

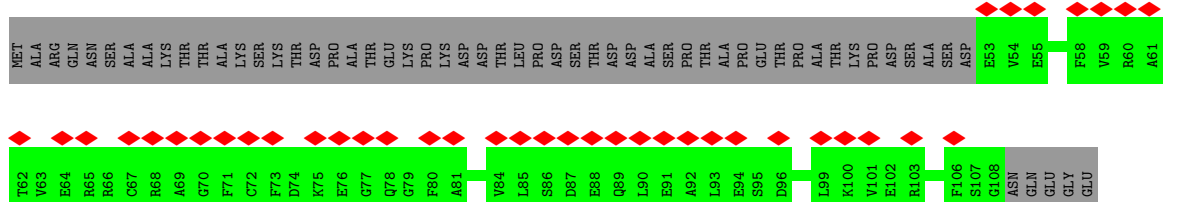

• Molecule 1: Mu-like prophage FluMu N-terminal domain-containing protein

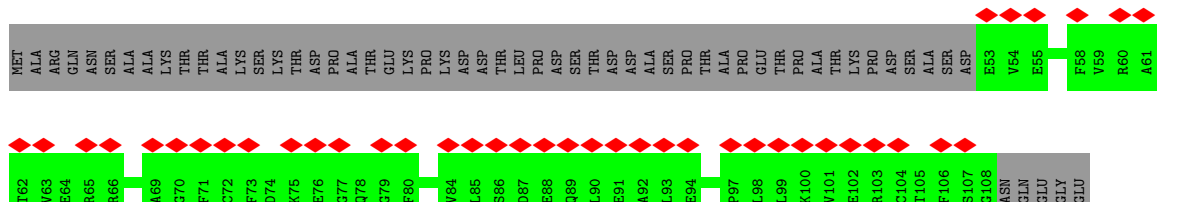

• Molecule 1: Mu-like prophage FluMu N-terminal domain-containing protein

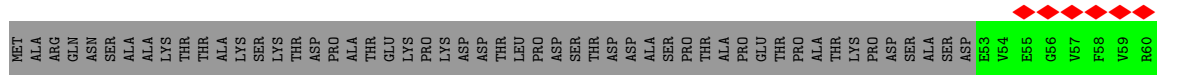
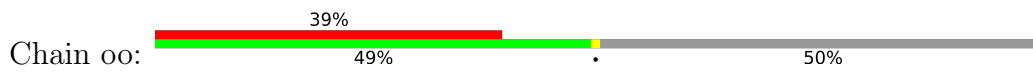



• Molecule 1: Mu-like prophage FluMu N-terminal domain-containing protein

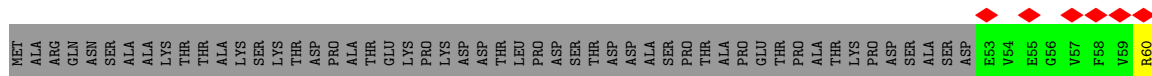
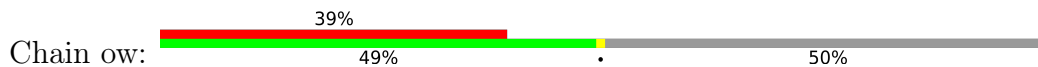

• Molecule 1: Mu-like prophage FluMu N-terminal domain-containing protein

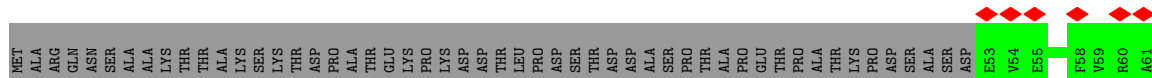

• Molecule 1: Mu-like prophage FluMu N-terminal domain-containing protein

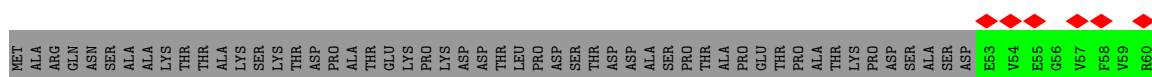

• Molecule 1: Mu-like prophage FluMu N-terminal domain-containing protein

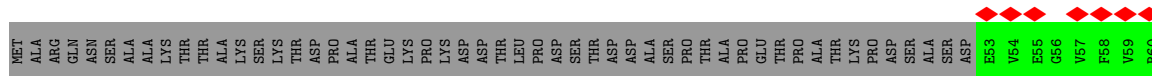
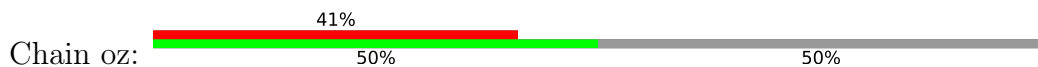

• Molecule 1: Mu-like prophage FluMu N-terminal domain-containing protein

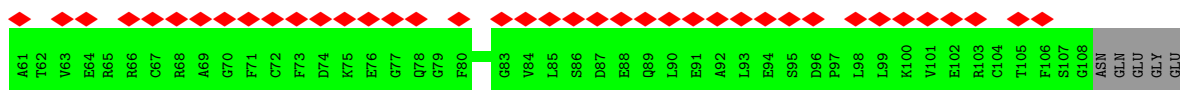

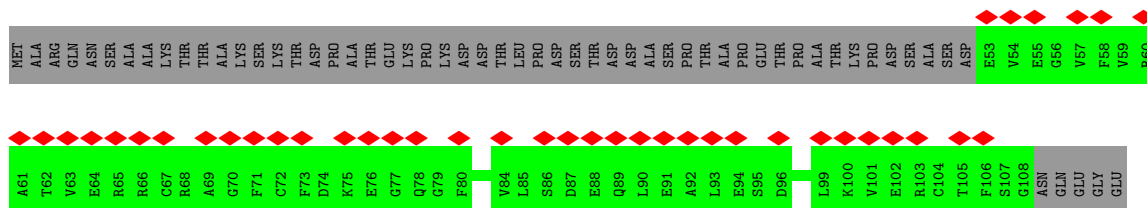

• Molecule 1: Mu-like prophage FluMu N-terminal domain-containing protein

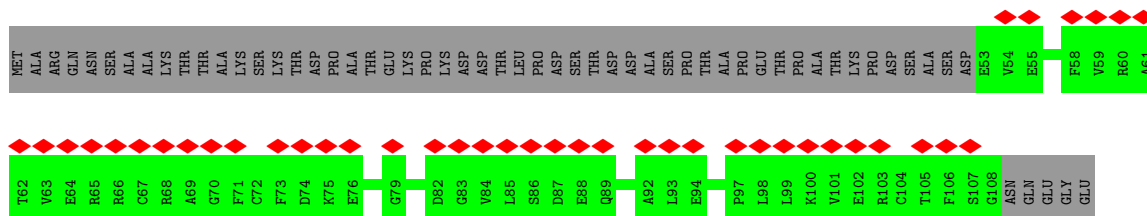

• Molecule 1: Mu-like prophage FluMu N-terminal domain-containing protein

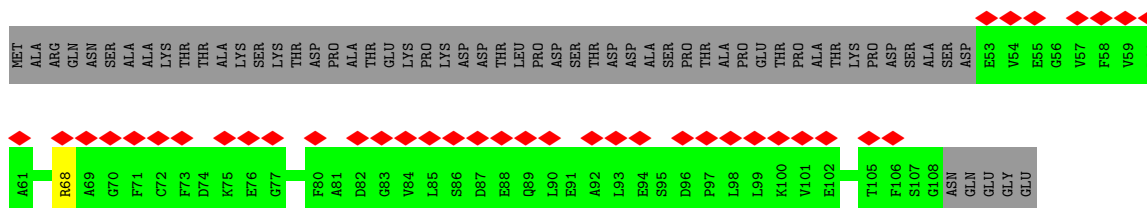

• Molecule 1: Mu-like prophage FluMu N-terminal domain-containing protein

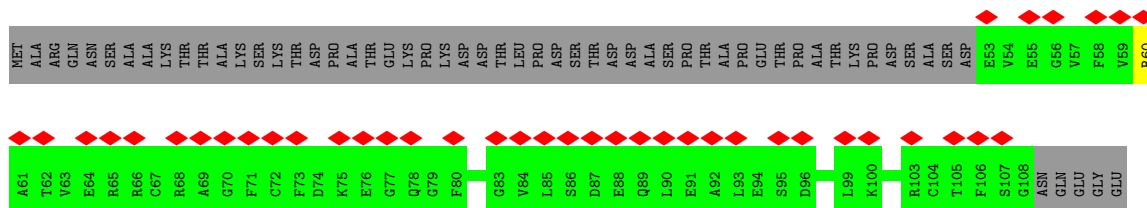

• Molecule 1: Mu-like prophage FluMu N-terminal domain-containing protein

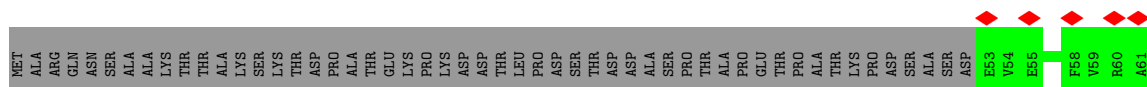

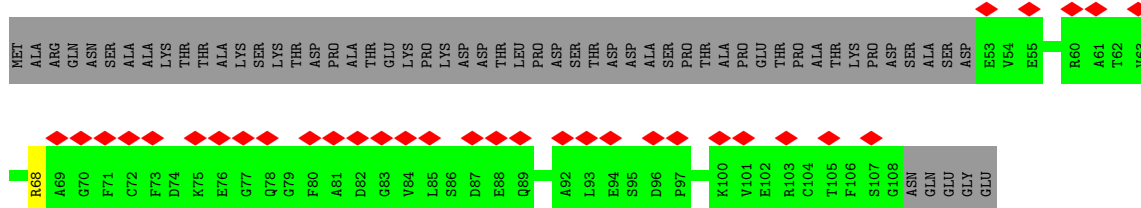

• Molecule 1: Mu-like prophage FluMu N-terminal domain-containing protein

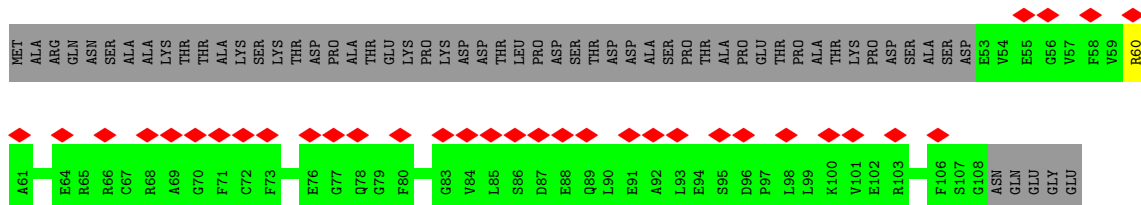

• Molecule 1: Mu-like prophage FluMu N-terminal domain-containing protein

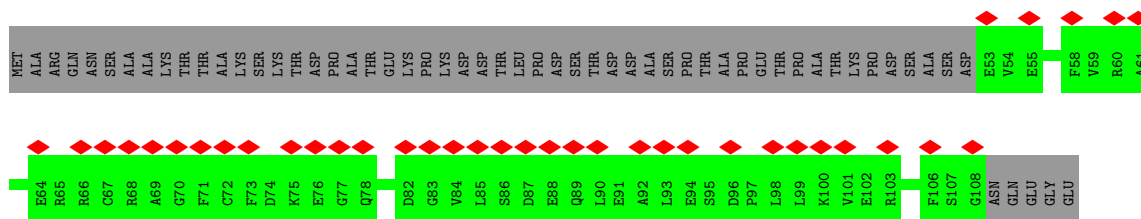

• Molecule 1: Mu-like prophage FluMu N-terminal domain-containing protein

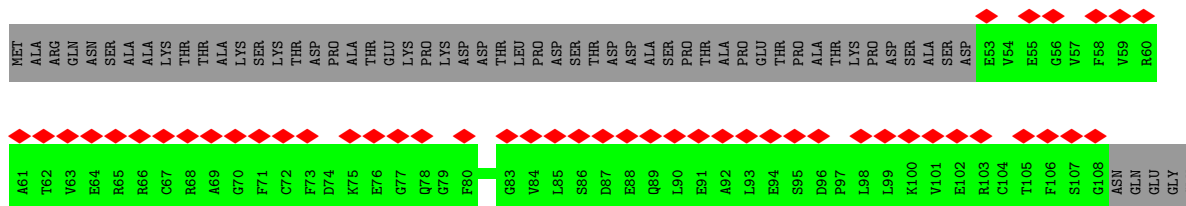
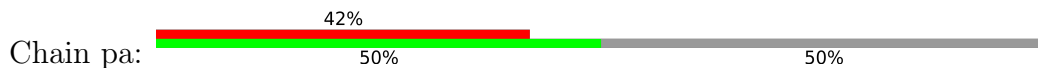

• Molecule 1: Mu-like prophage FluMu N-terminal domain-containing protein

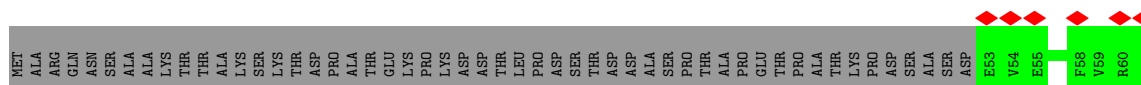
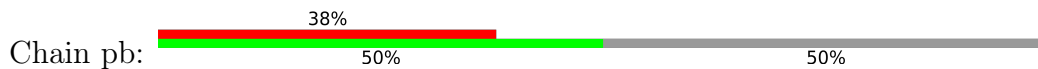



- Molecule 1: Mu-like prophage FluMu N-terminal domain-containing protein

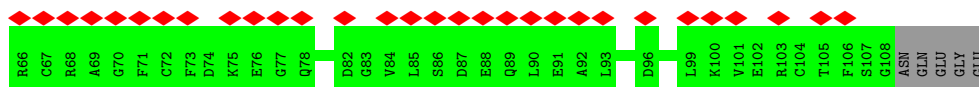
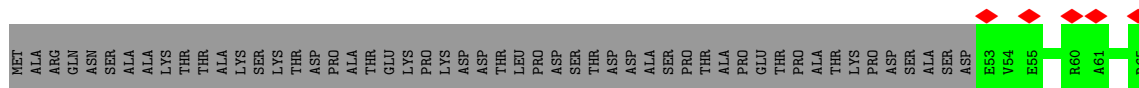

- Molecule 1: Mu-like prophage FluMu N-terminal domain-containing protein

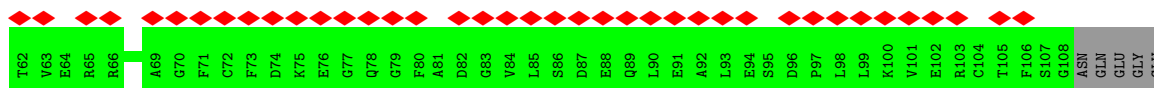
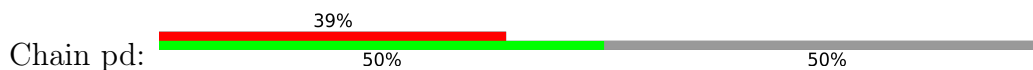

- Molecule 1: Mu-like prophage FluMu N-terminal domain-containing protein

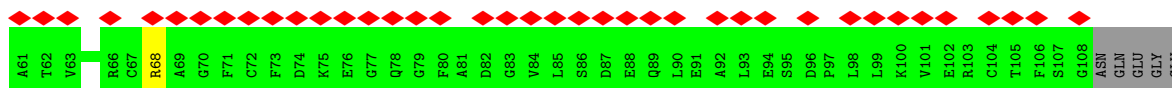
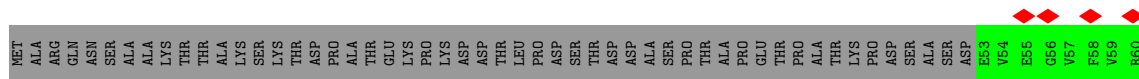
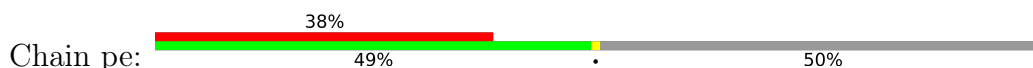

- Molecule 1: Mu-like prophage FluMu N-terminal domain-containing protein

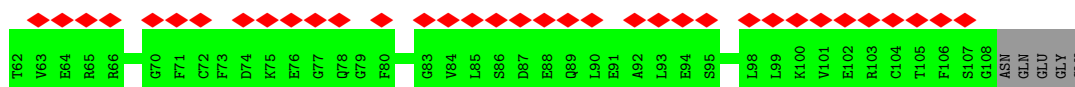

- Molecule 1: Mu-like prophage FluMu N-terminal domain-containing protein

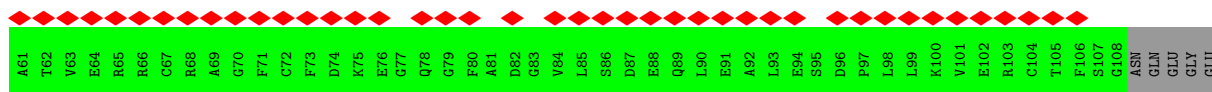

• Molecule 1: Mu-like prophage FluMu N-terminal domain-containing protein

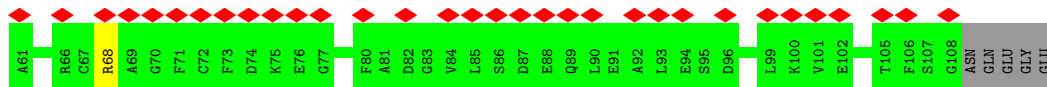
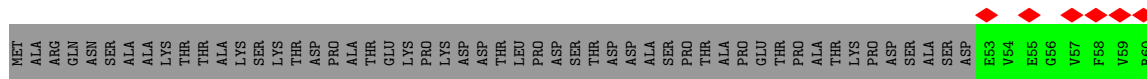

• Molecule 1: Mu-like prophage FluMu N-terminal domain-containing protein

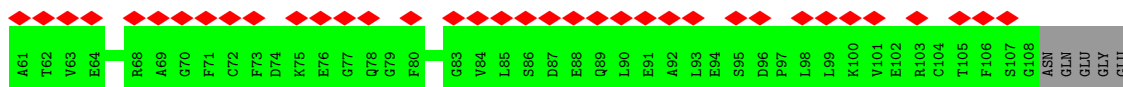
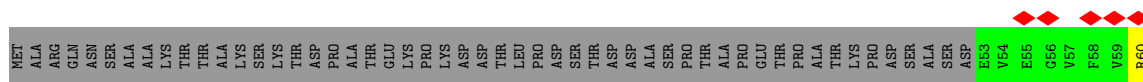

• Molecule 1: Mu-like prophage FluMu N-terminal domain-containing protein

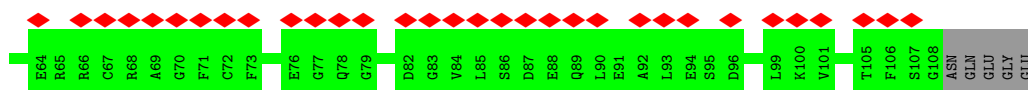

• Molecule 1: Mu-like prophage FluMu N-terminal domain-containing protein

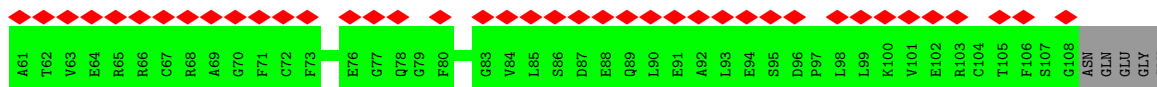
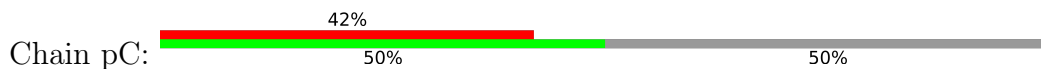

• Molecule 1: Mu-like prophage FluMu N-terminal domain-containing protein

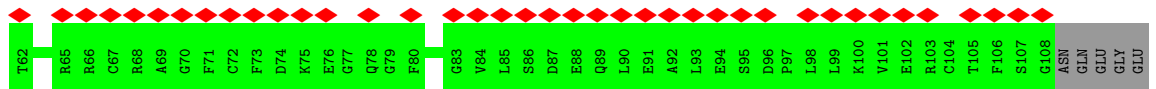
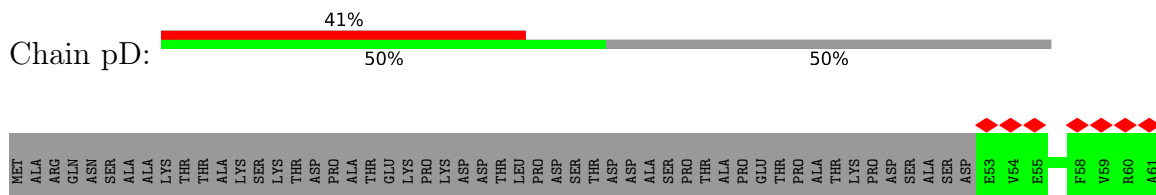

• Molecule 1: Mu-like prophage FluMu N-terminal domain-containing protein

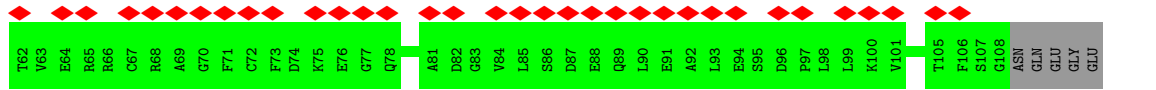
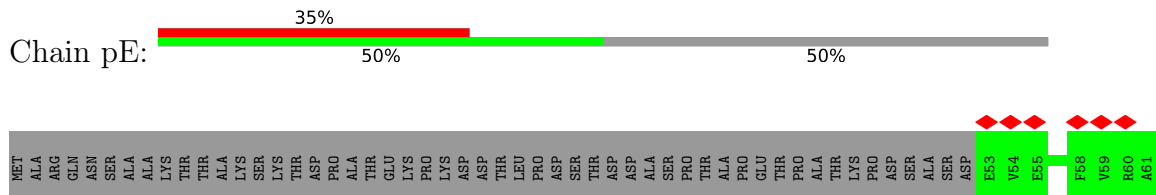

• Molecule 1: Mu-like prophage FluMu N-terminal domain-containing protein

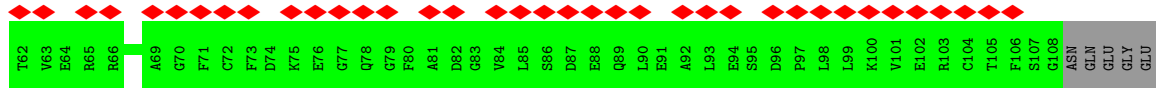
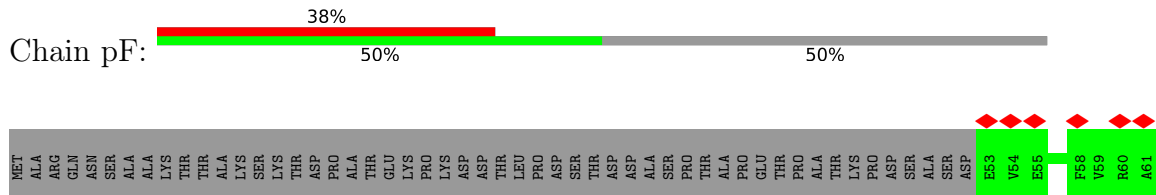

• Molecule 1: Mu-like prophage FluMu N-terminal domain-containing protein

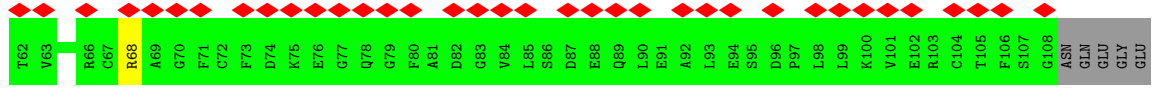
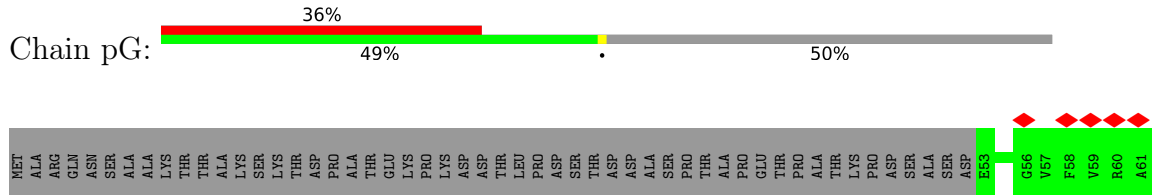

• Molecule 1: Mu-like prophage FluMu N-terminal domain-containing protein

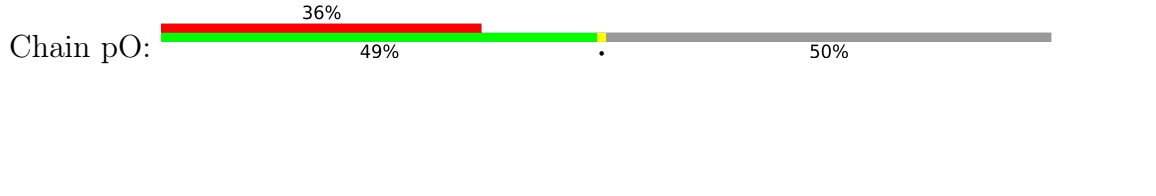

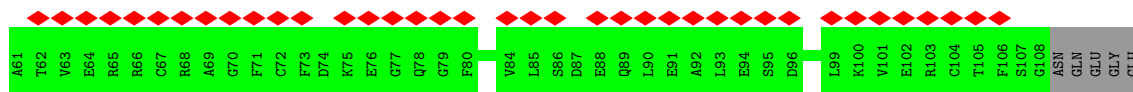

• Molecule 1: Mu-like prophage FluMu N-terminal domain-containing protein

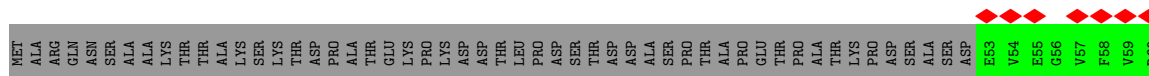
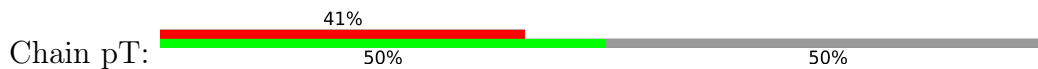

• Molecule 1: Mu-like prophage FluMu N-terminal domain-containing protein

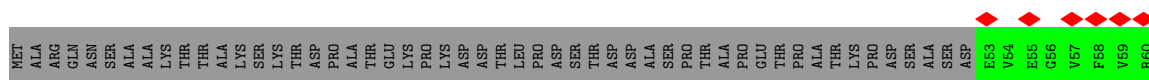

• Molecule 1: Mu-like prophage FluMu N-terminal domain-containing protein

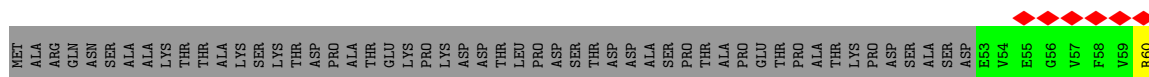
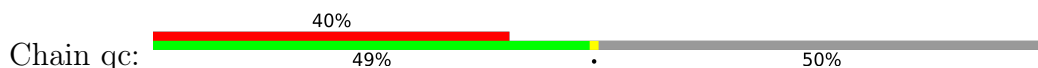

• Molecule 2: Bacteriophage Mu GpT domain-containing protein

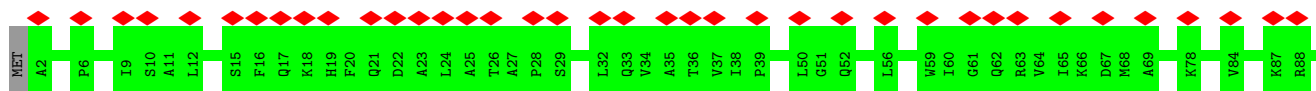

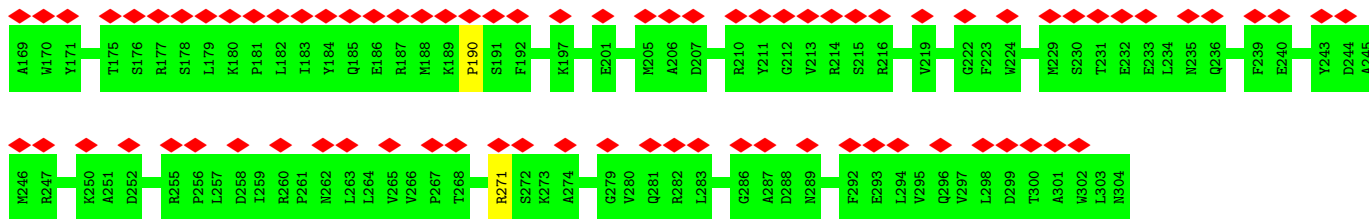

• Molecule 2: Bacteriophage Mu GpT domain-containing protein

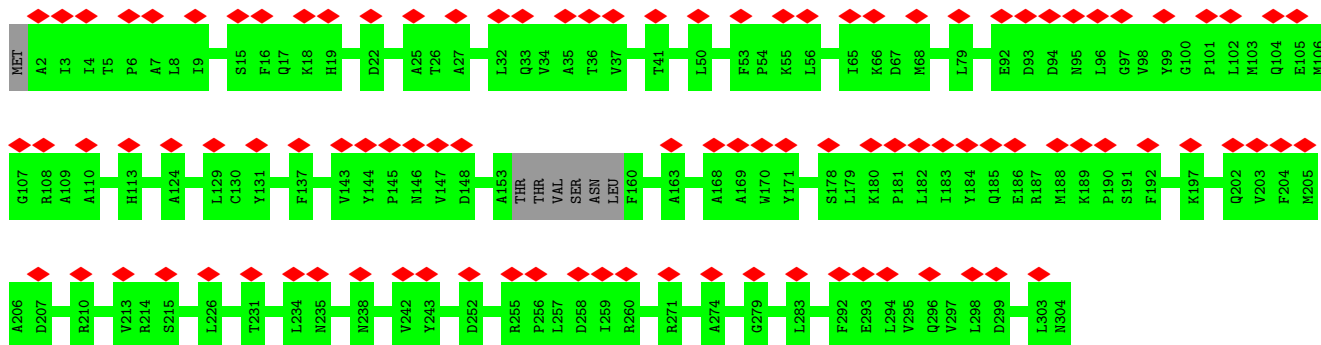

• Molecule 2: Bacteriophage Mu GpT domain-containing protein

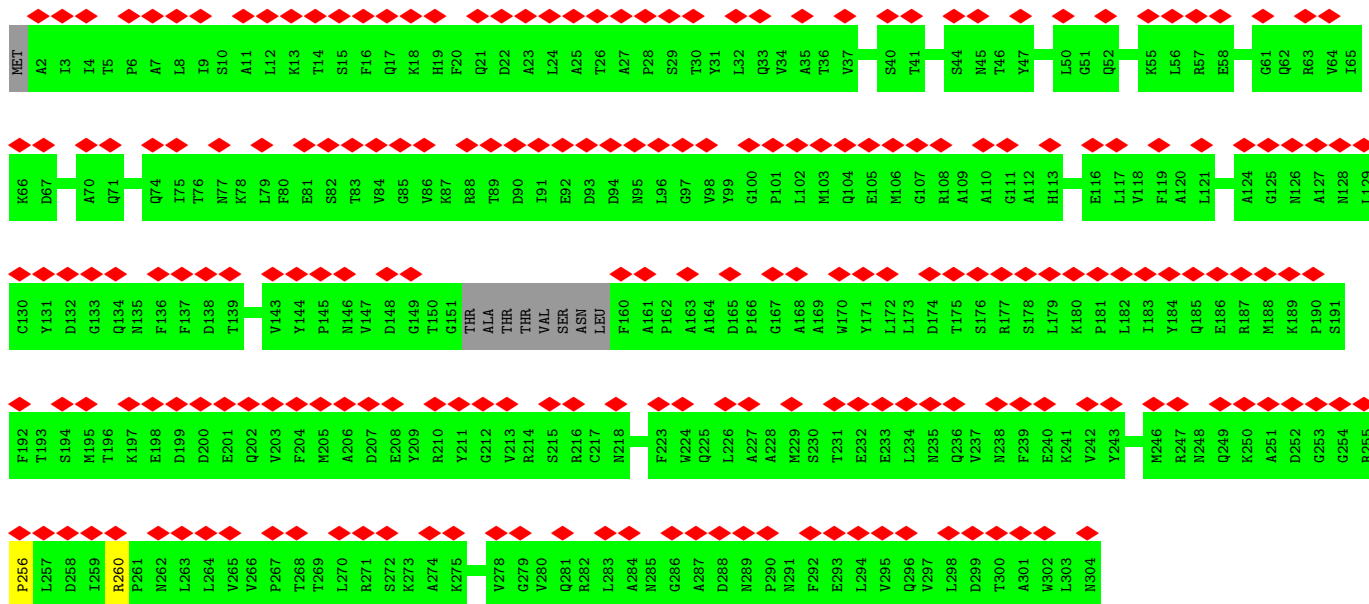

• Molecule 2: Bacteriophage Mu GpT domain-containing protein





• Molecule 2: Bacteriophage Mu GpT domain-containing protein

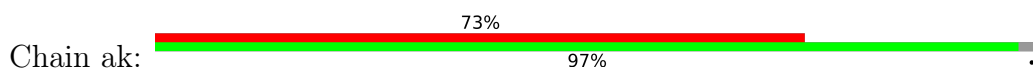

• Molecule 2: Bacteriophage Mu GpT domain-containing protein

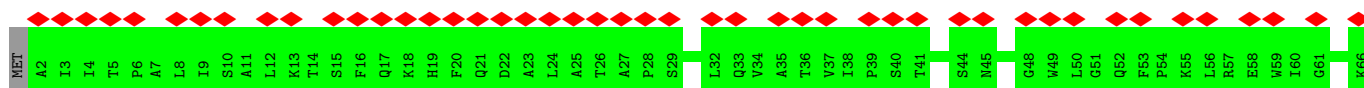



• Molecule 2: Bacteriophage Mu GpT domain-containing protein

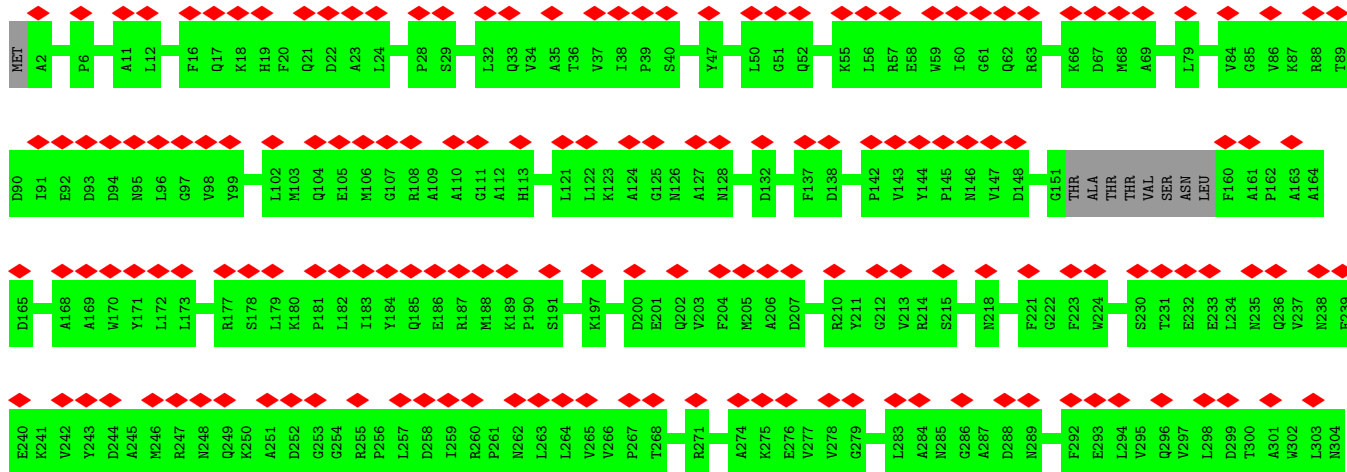

• Molecule 2: Bacteriophage Mu GpT domain-containing protein

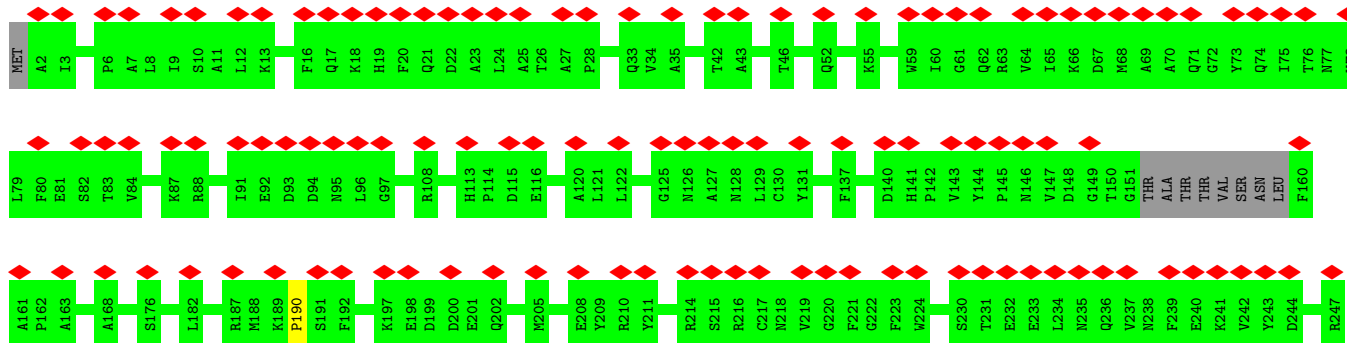

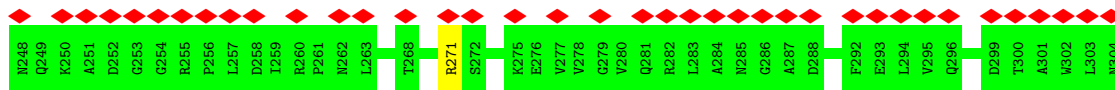

• Molecule 2: Bacteriophage Mu GpT domain-containing protein



• Molecule 2: Bacteriophage Mu GpT domain-containing protein

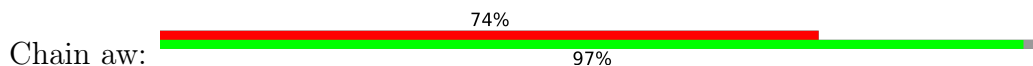

• Molecule 2: Bacteriophage Mu GpT domain-containing protein

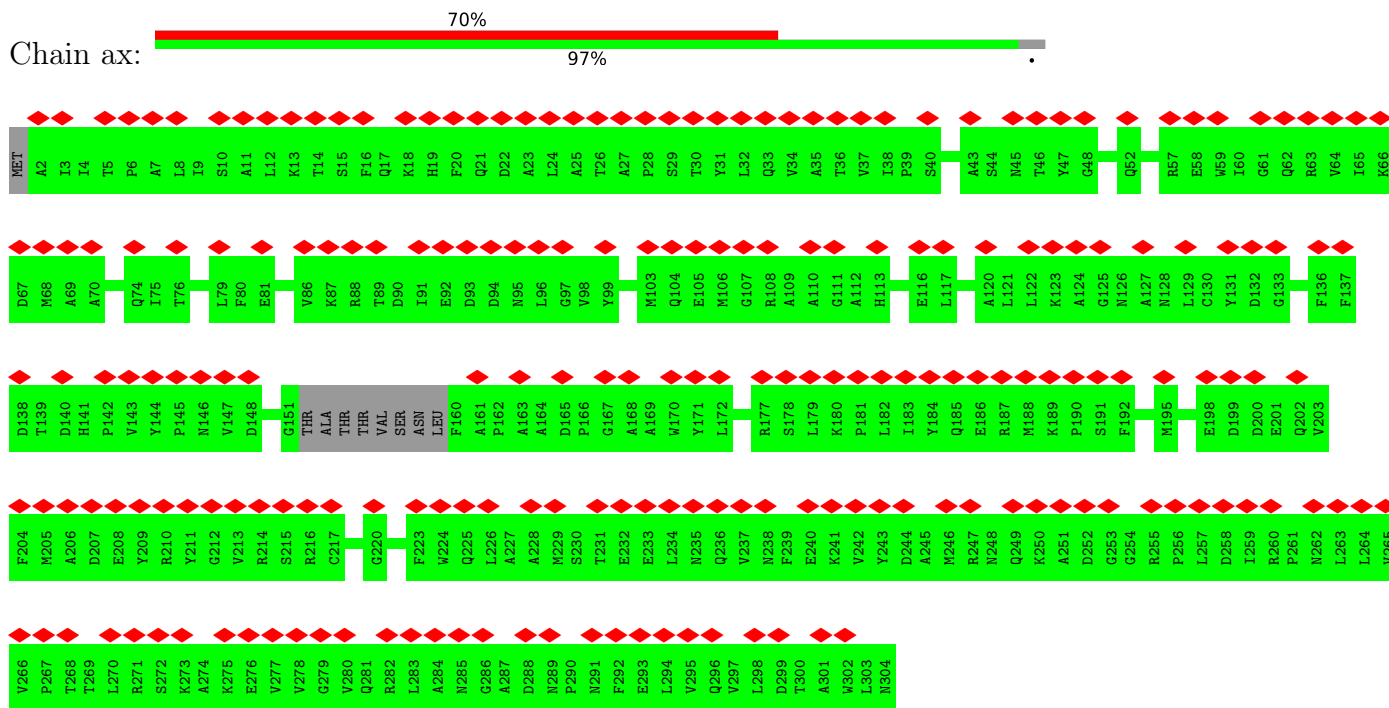

• Molecule 2: Bacteriophage Mu GpT domain-containing protein

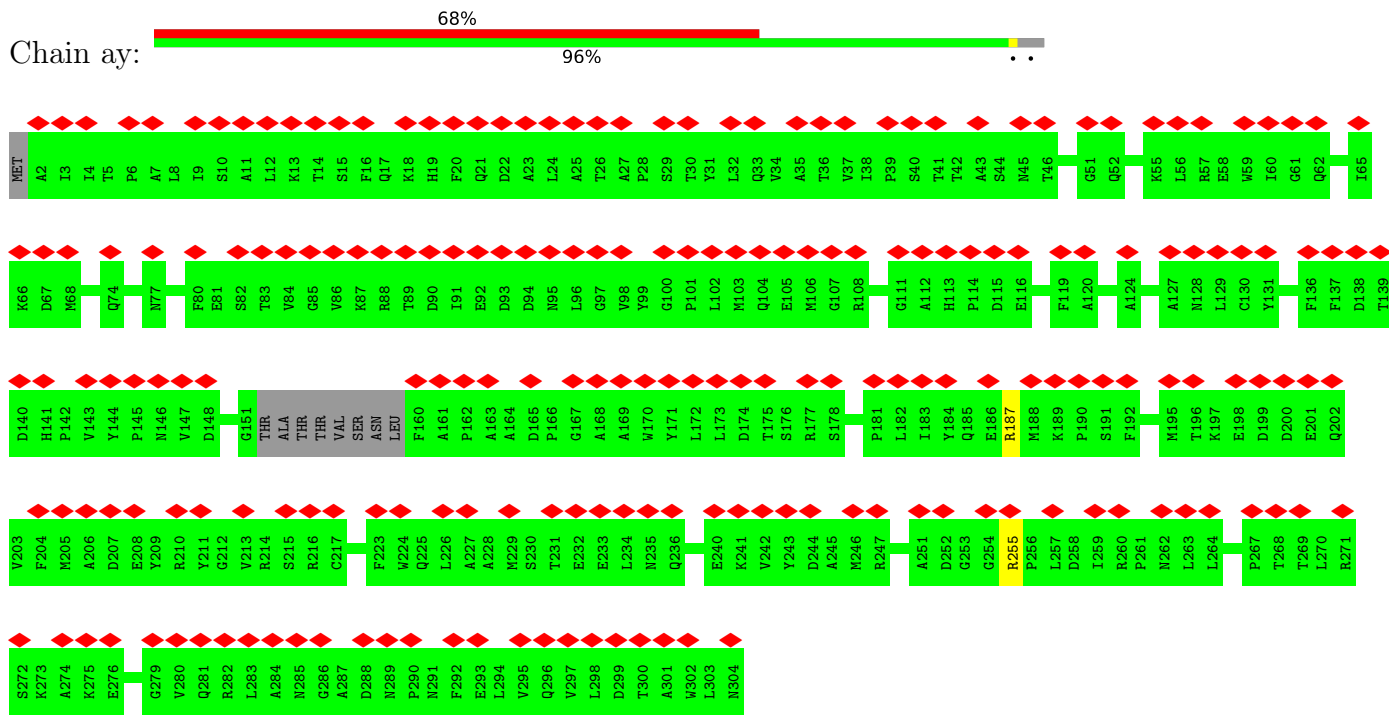

• Molecule 2: Bacteriophage Mu GpT domain-containing protein

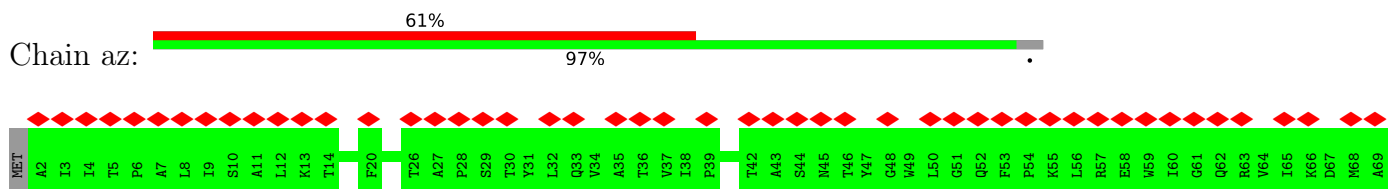

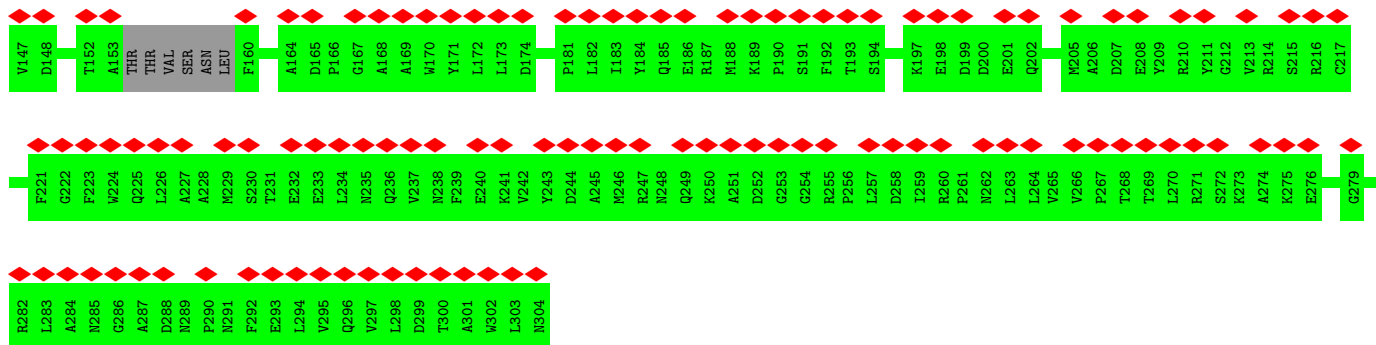

• Molecule 2: Bacteriophage Mu GpT domain-containing protein



• Molecule 2: Bacteriophage Mu GpT domain-containing protein

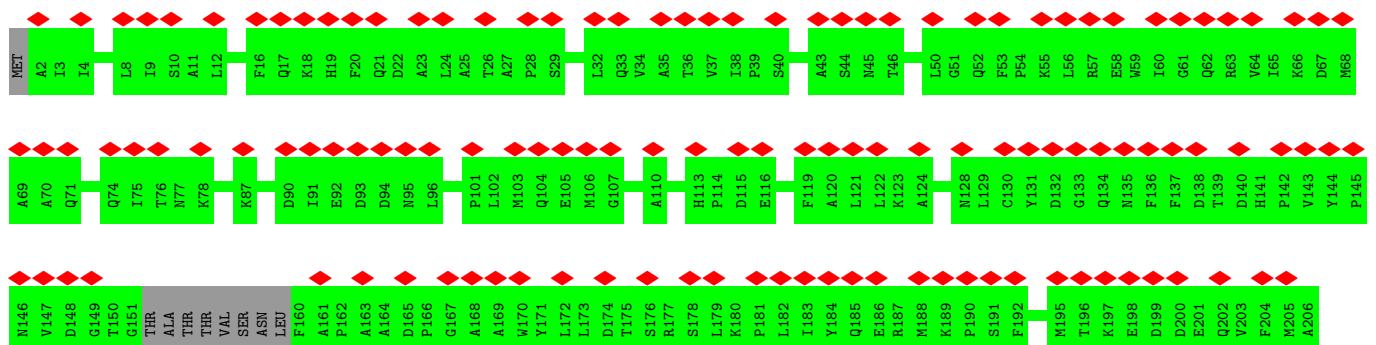

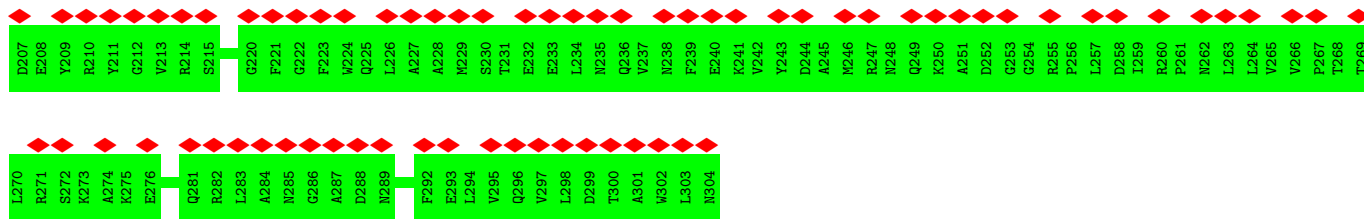

• Molecule 2: Bacteriophage Mu GpT domain-containing protein

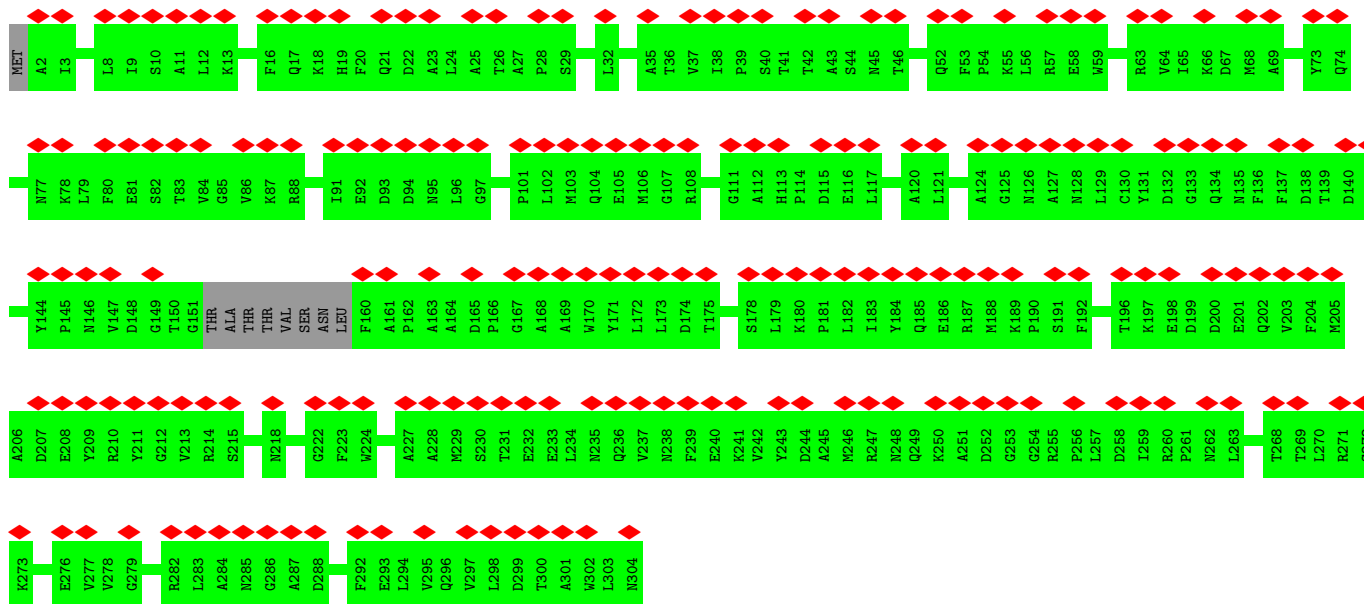

• Molecule 2: Bacteriophage Mu GpT domain-containing protein

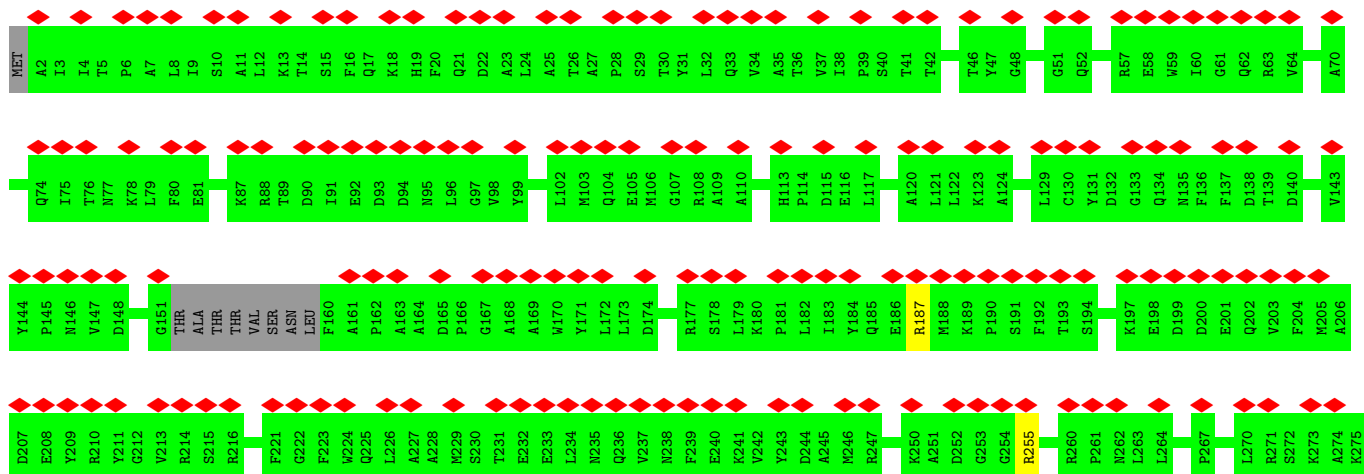



• Molecule 2: Bacteriophage Mu GpT domain-containing protein

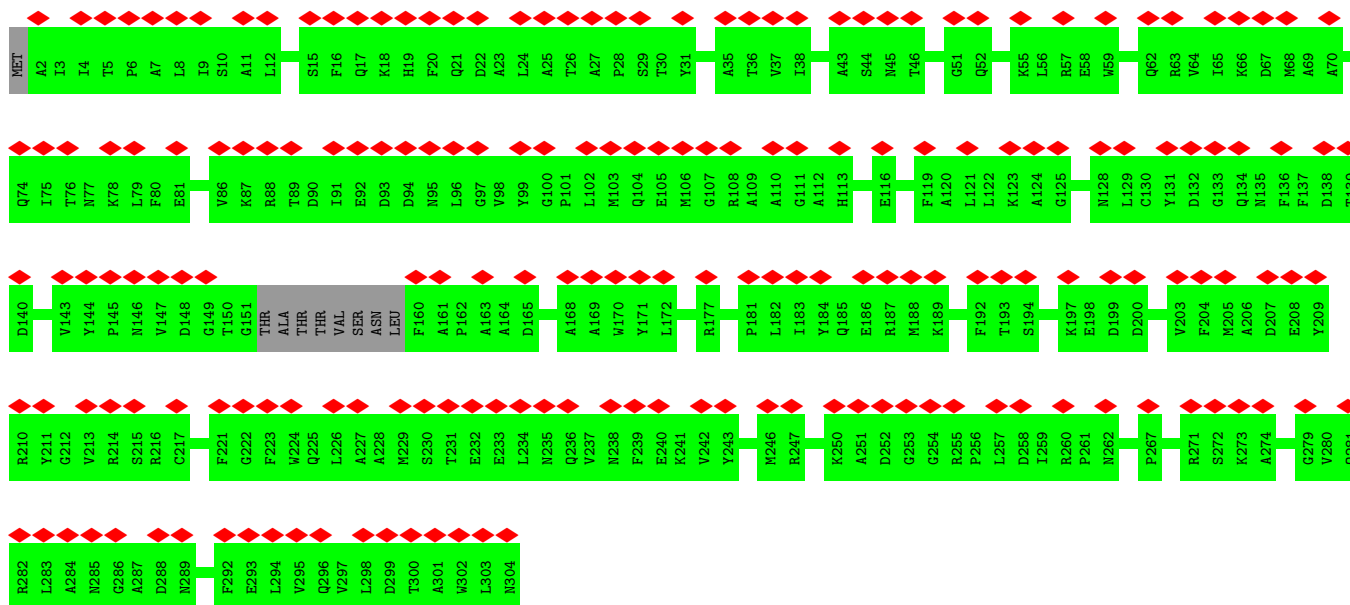

• Molecule 2: Bacteriophage Mu GpT domain-containing protein



• Molecule 2: Bacteriophage Mu GpT domain-containing protein



• Molecule 2: Bacteriophage Mu GpT domain-containing protein

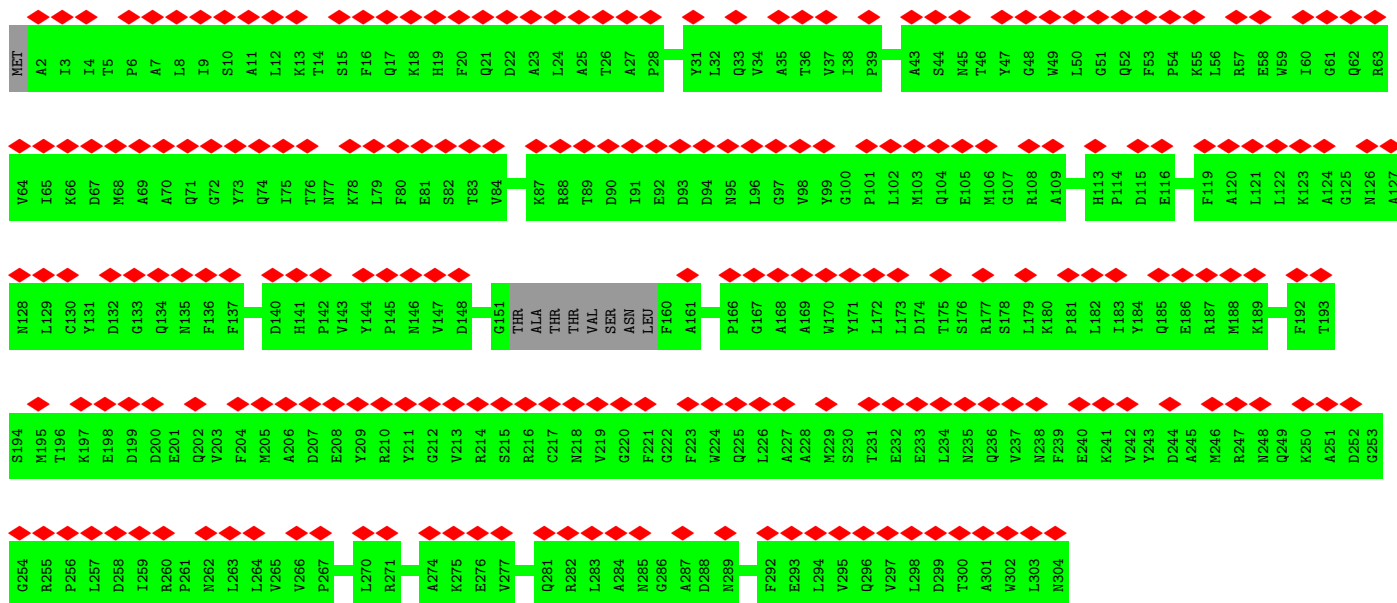
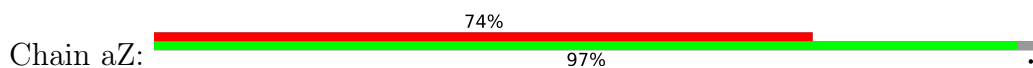

• Molecule 2: Bacteriophage Mu GpT domain-containing protein

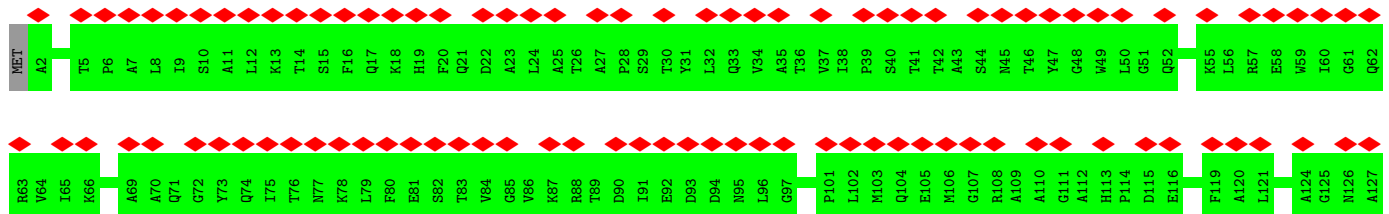
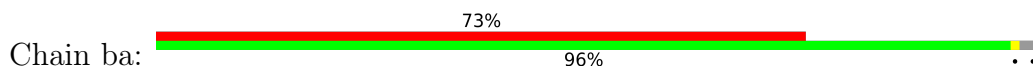

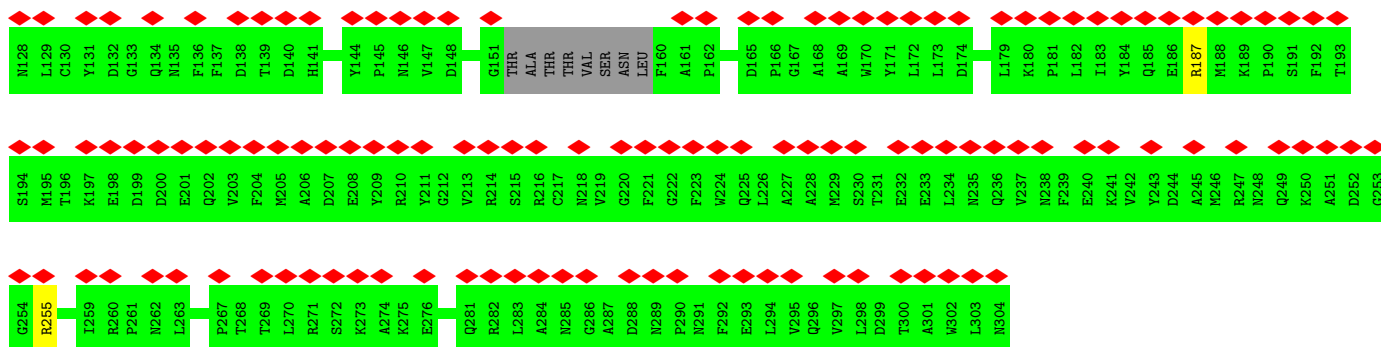

• Molecule 2: Bacteriophage Mu GpT domain-containing protein

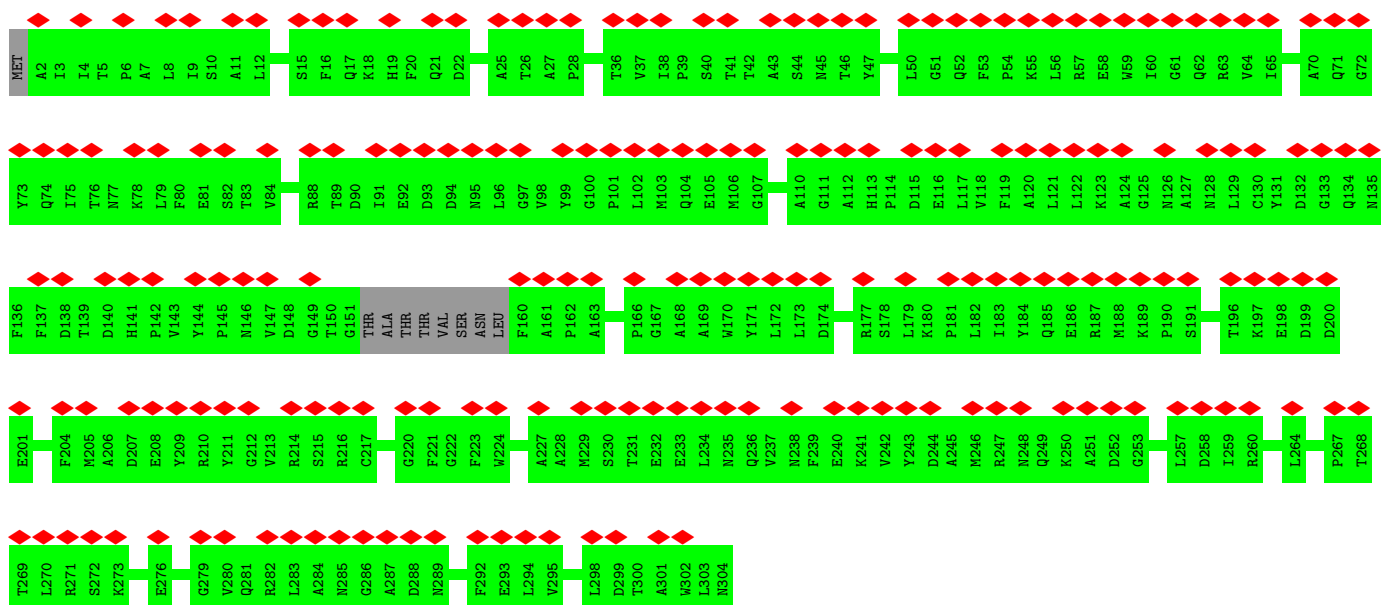

• Molecule 2: Bacteriophage Mu GpT domain-containing protein

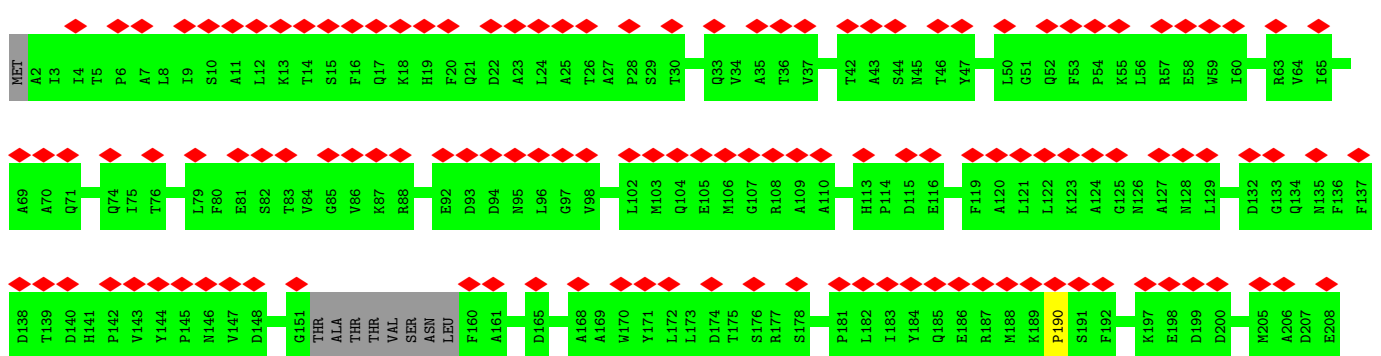



• Molecule 2: Bacteriophage Mu GpT domain-containing protein



• Molecule 2: Bacteriophage Mu GpT domain-containing protein

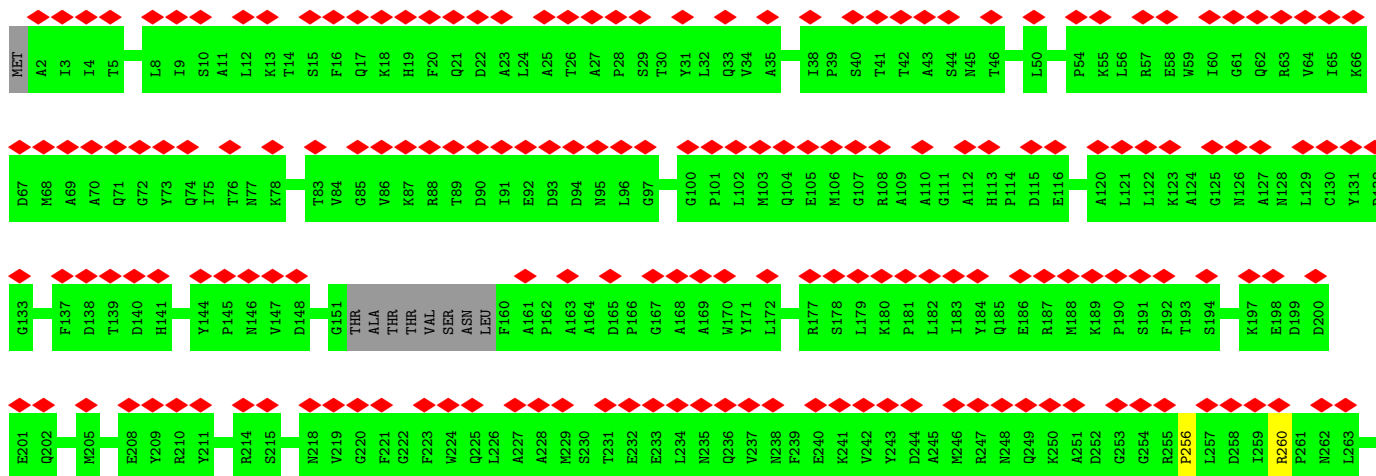

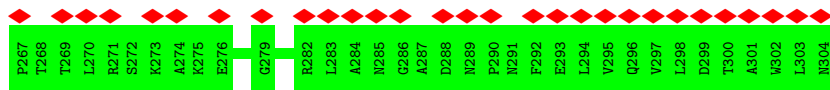

• Molecule 2: Bacteriophage Mu GpT domain-containing protein

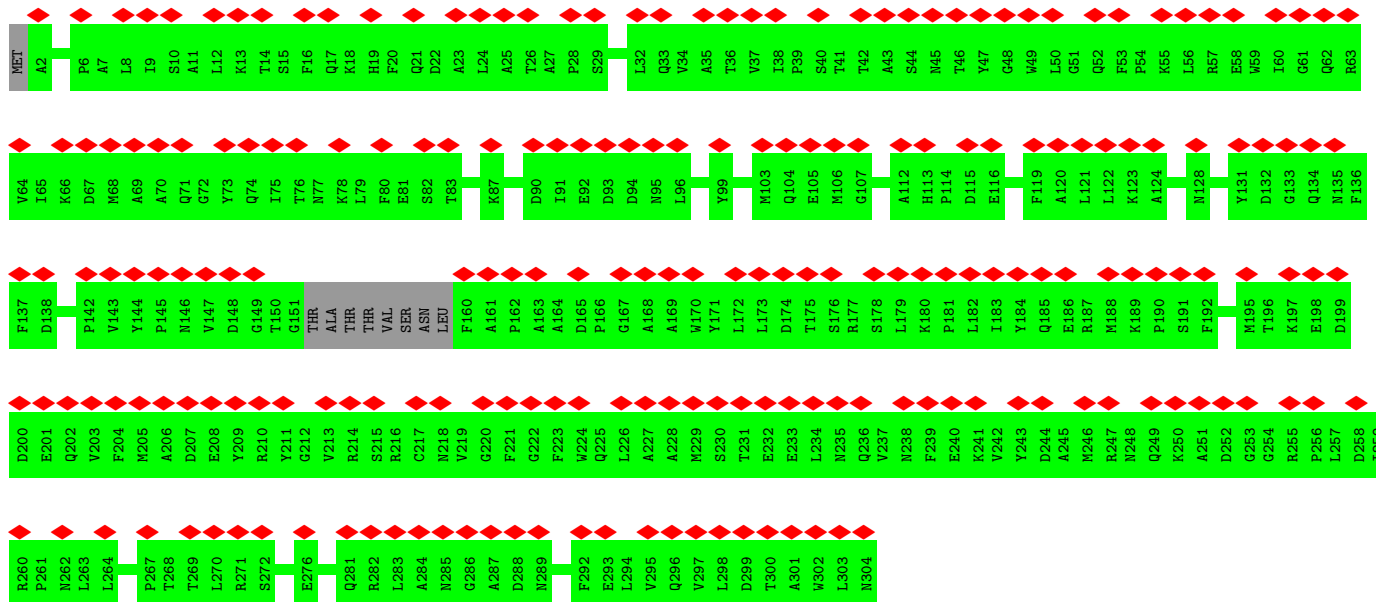

• Molecule 2: Bacteriophage Mu GpT domain-containing protein

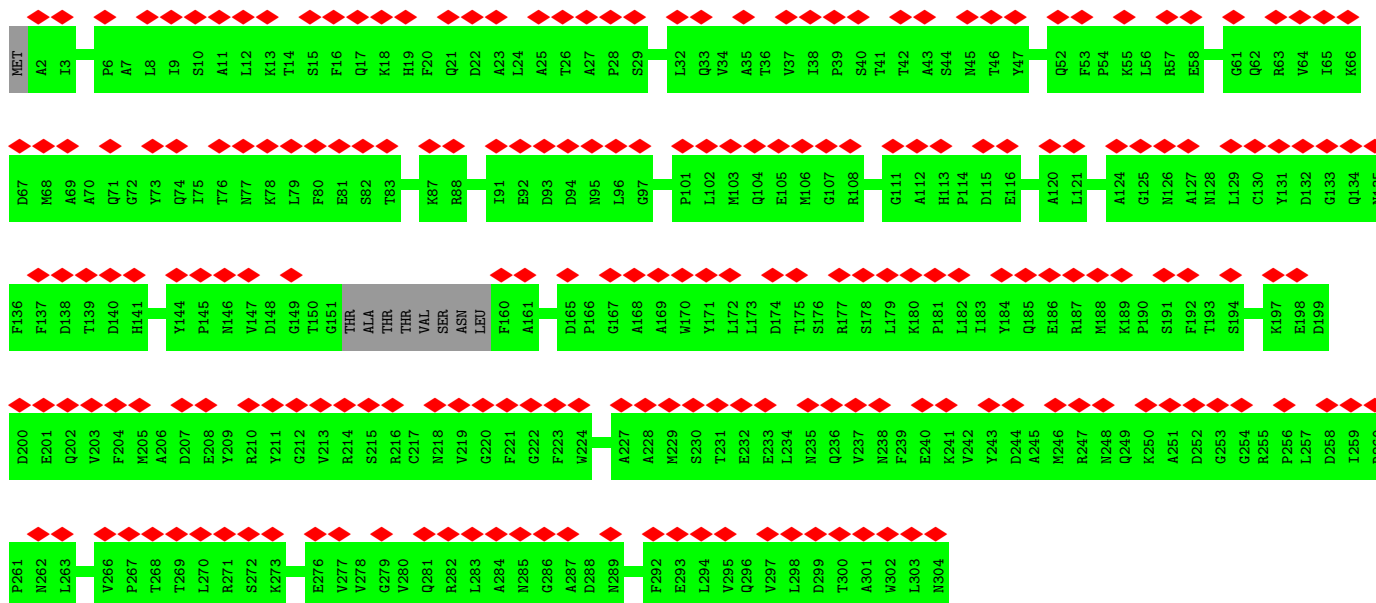

• Molecule 2: Bacteriophage Mu GpT domain-containing protein

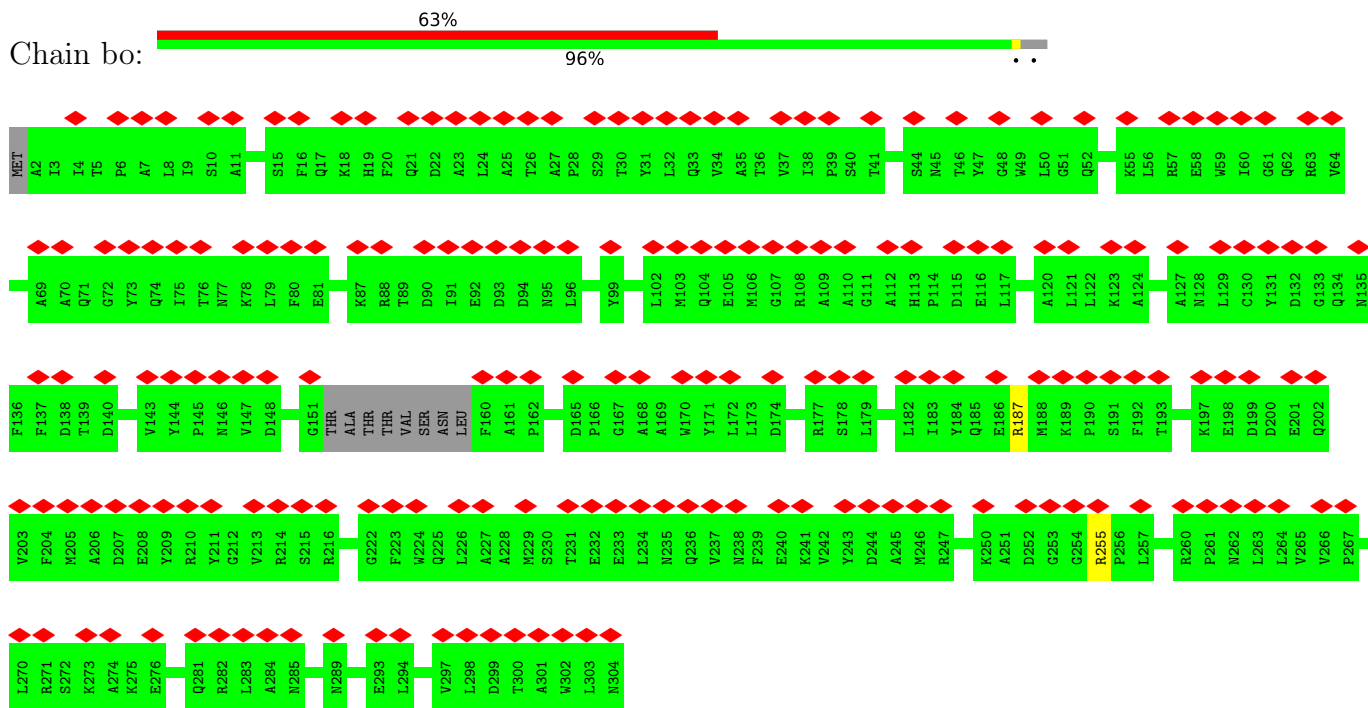

• Molecule 2: Bacteriophage Mu GpT domain-containing protein

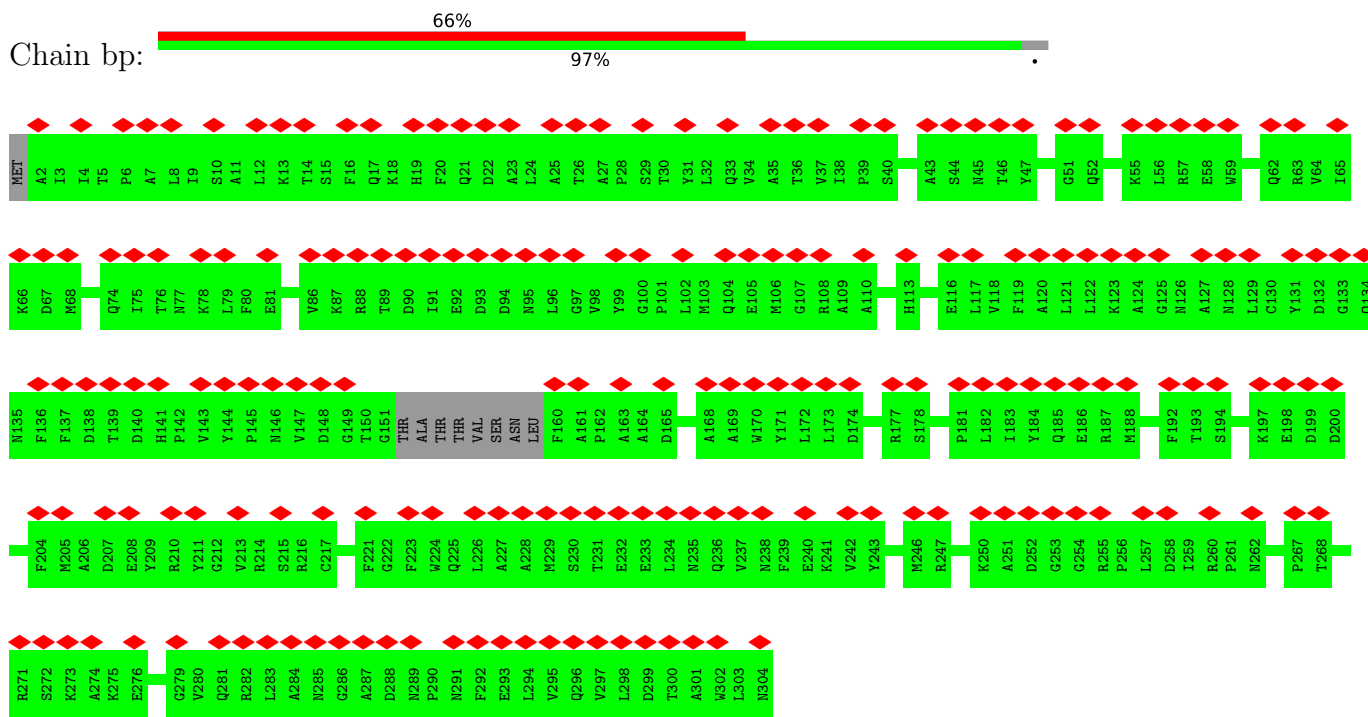

• Molecule 2: Bacteriophage Mu GpT domain-containing protein

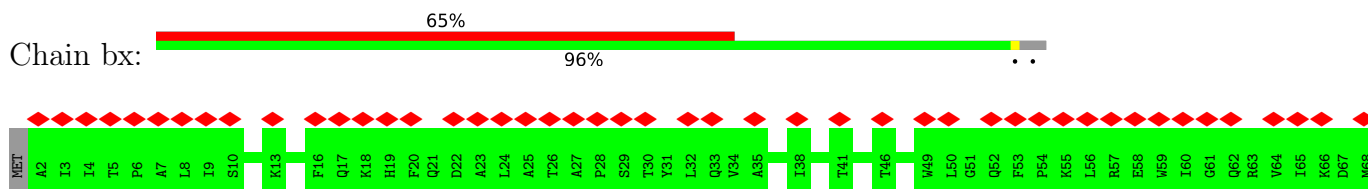

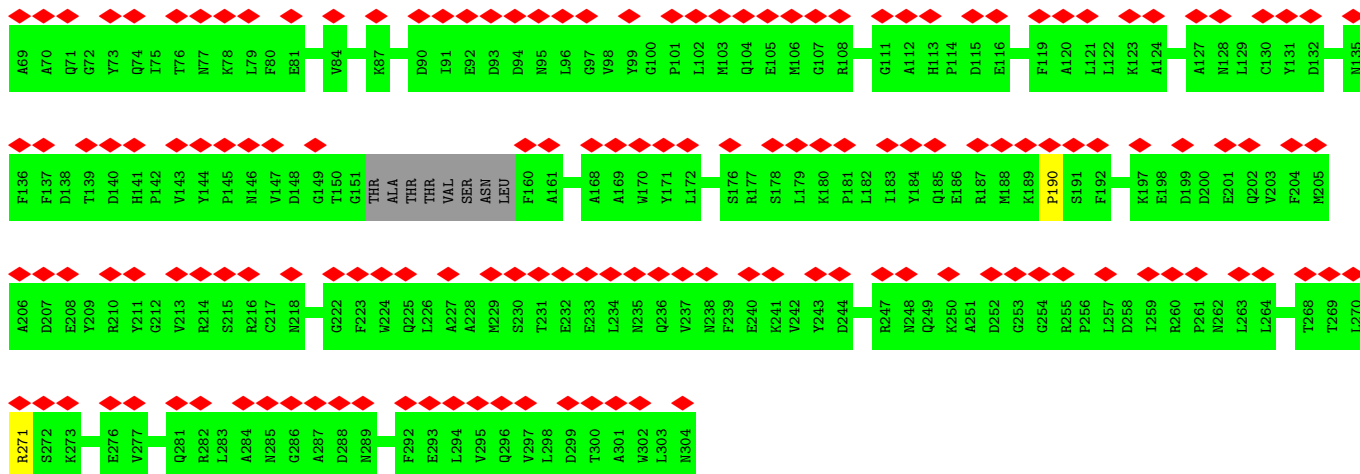

• Molecule 2: Bacteriophage Mu GpT domain-containing protein

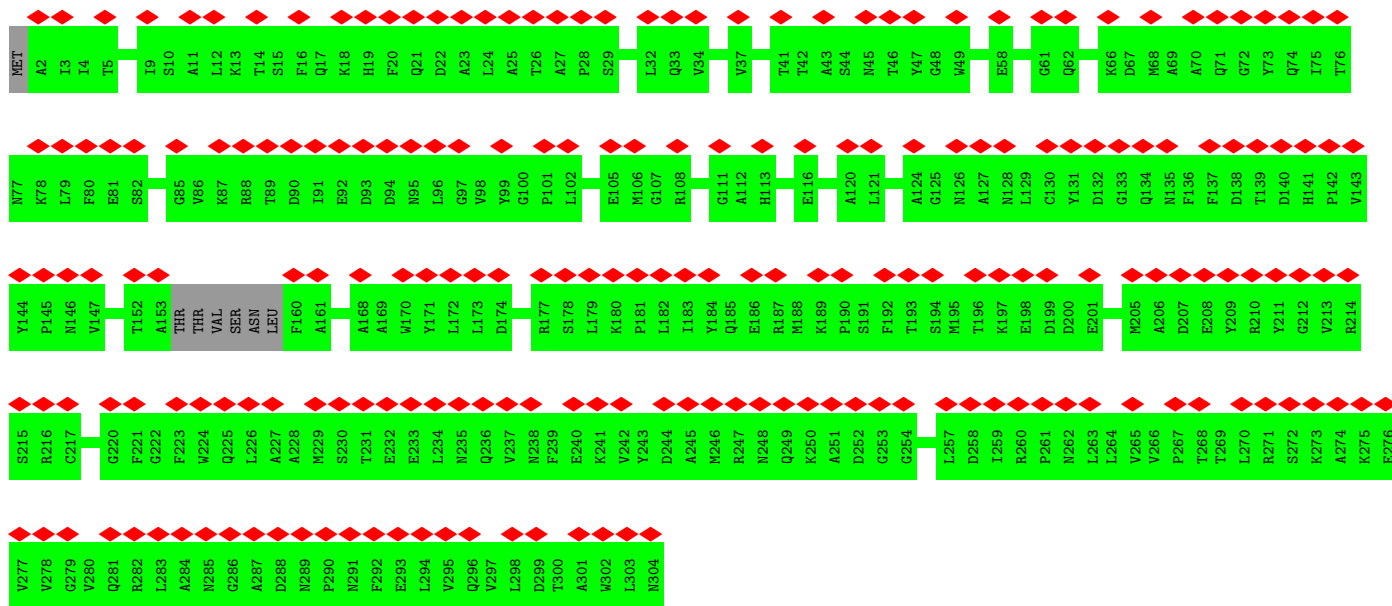

• Molecule 2: Bacteriophage Mu GpT domain-containing protein

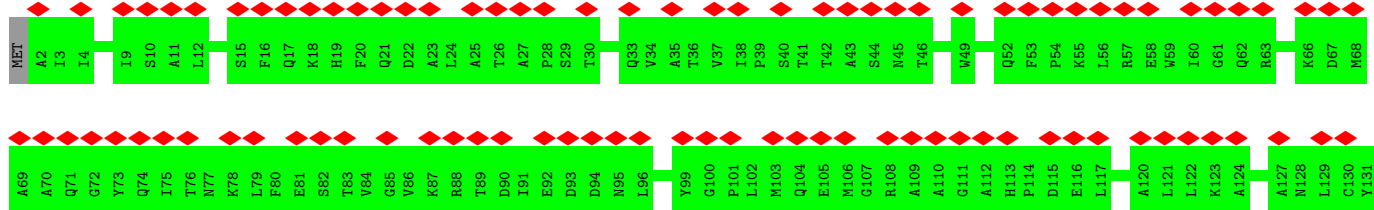
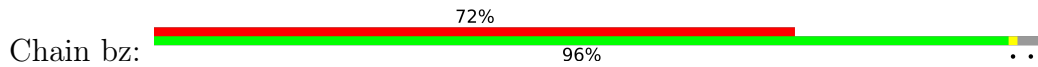

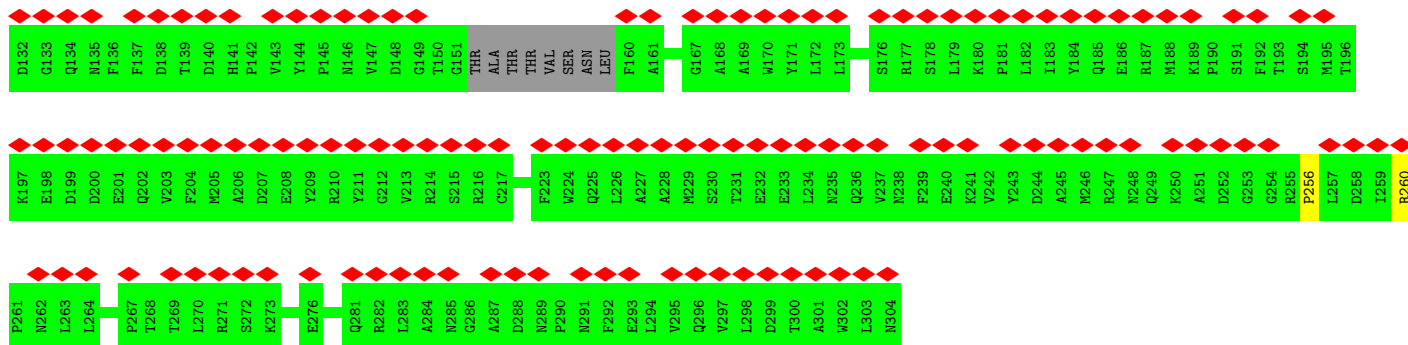

• Molecule 2: Bacteriophage Mu GpT domain-containing protein

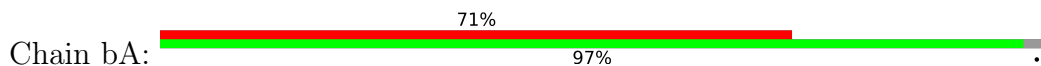

• Molecule 2: Bacteriophage Mu GpT domain-containing protein

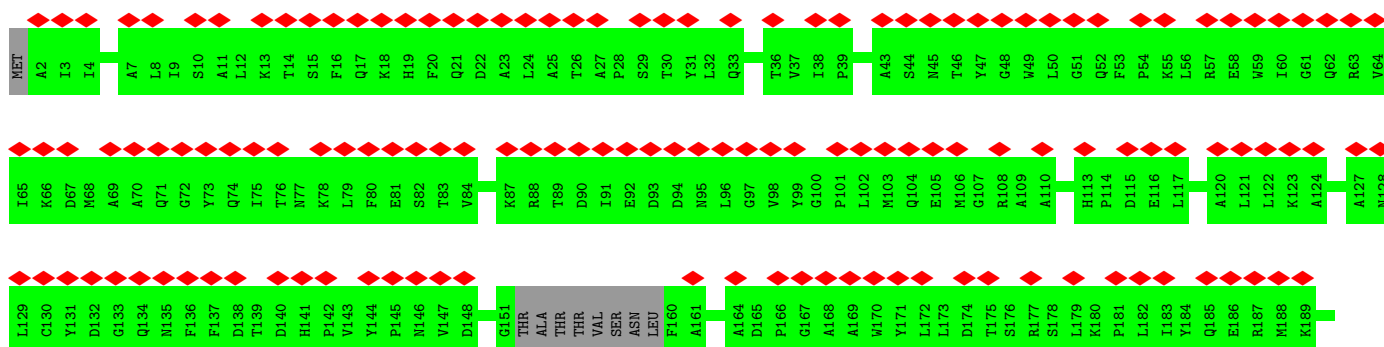
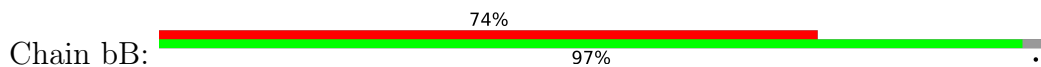

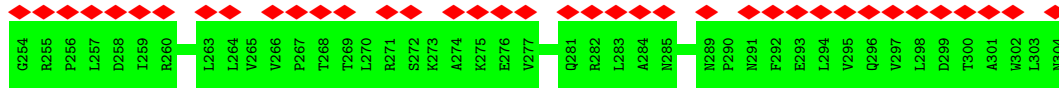
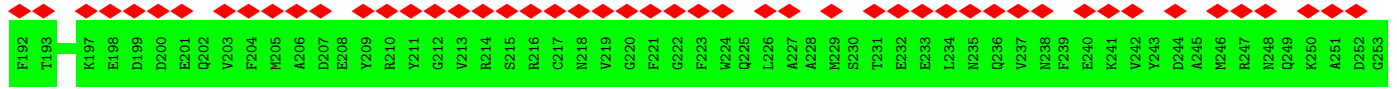

• Molecule 2: Bacteriophage Mu GpT domain-containing protein

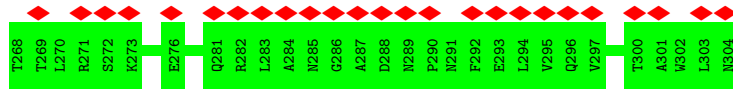
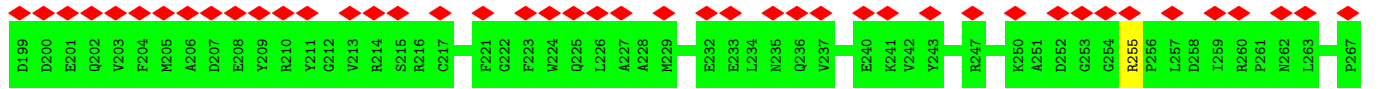
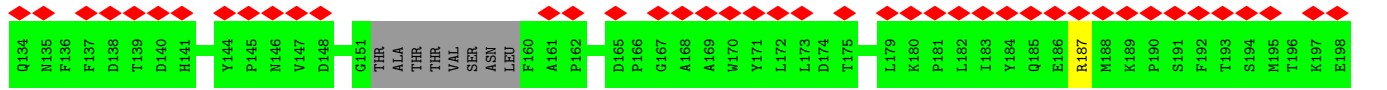
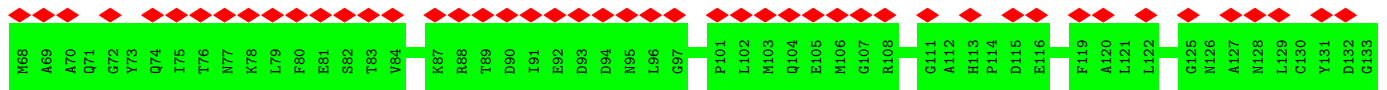
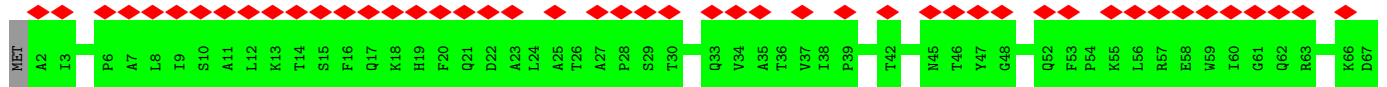

• Molecule 2: Bacteriophage Mu GpT domain-containing protein

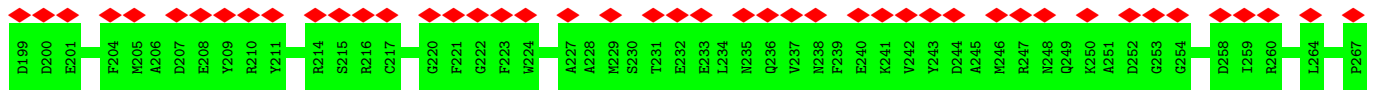
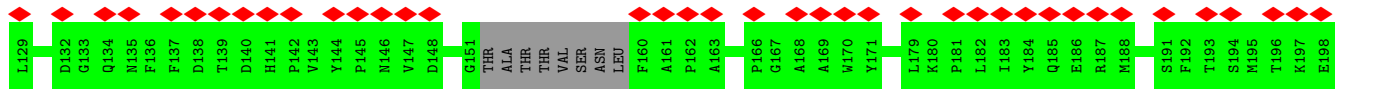
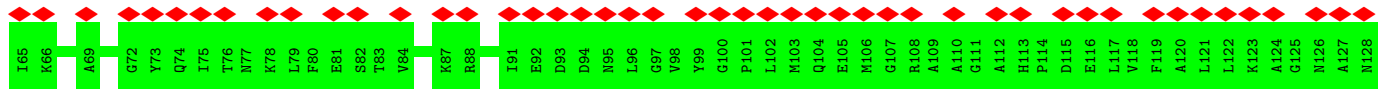
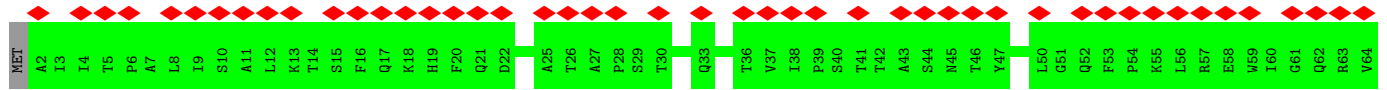

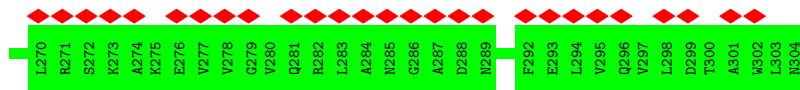

• Molecule 2: Bacteriophage Mu GpT domain-containing protein

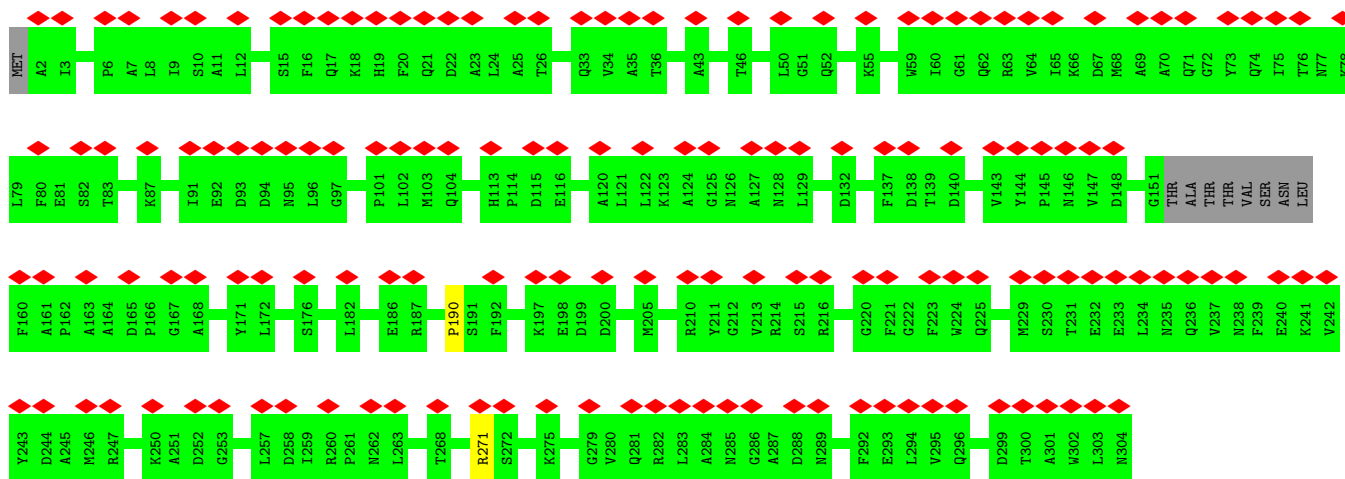

• Molecule 2: Bacteriophage Mu GpT domain-containing protein

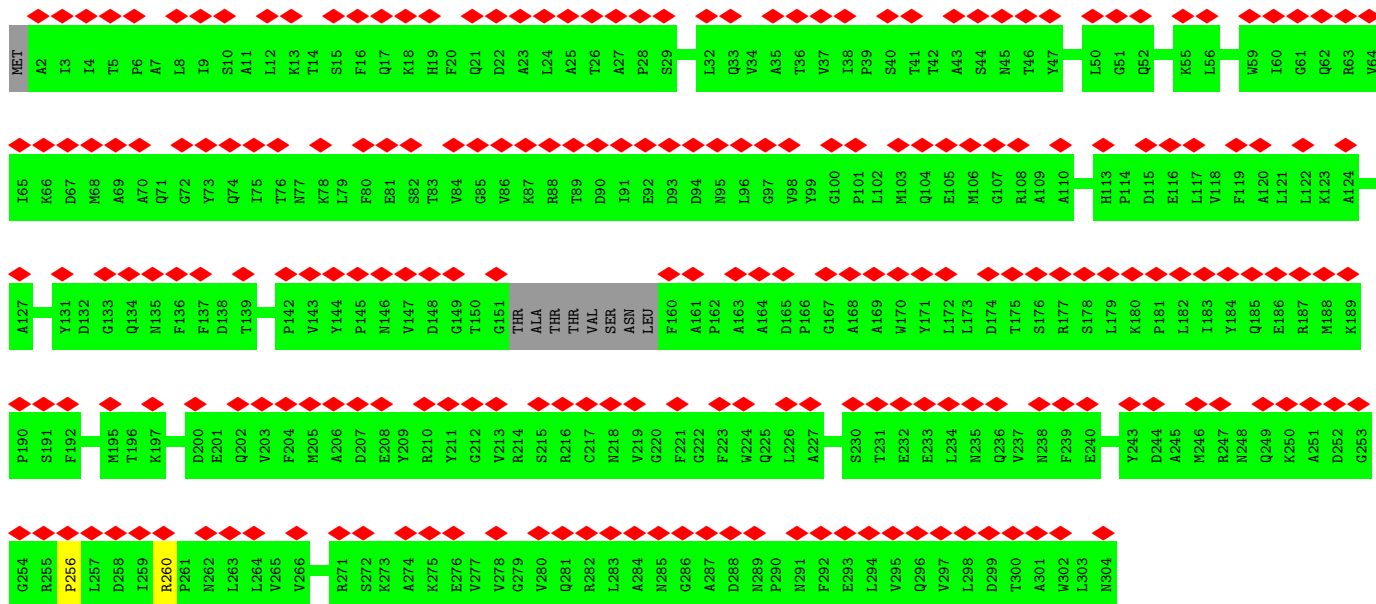
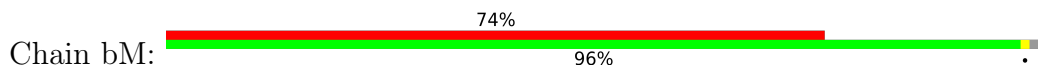

• Molecule 2: Bacteriophage Mu GpT domain-containing protein

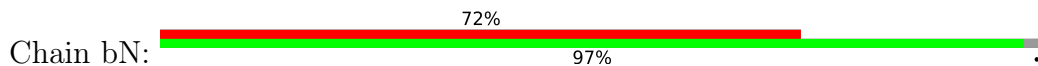

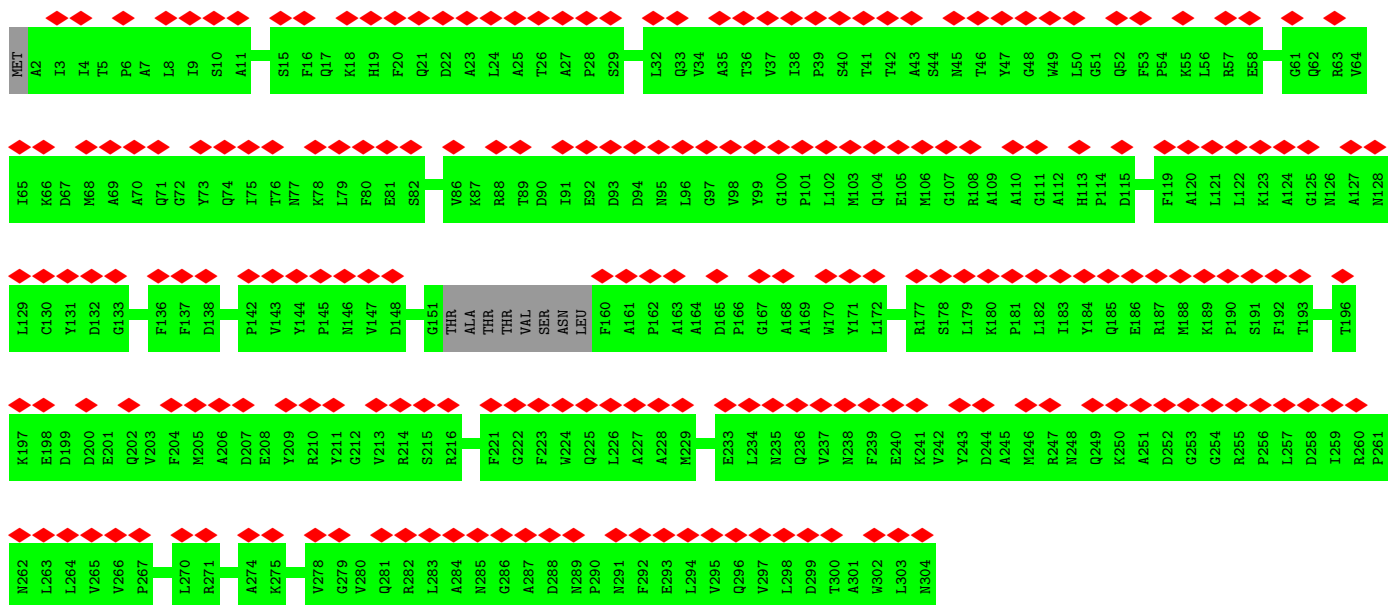

• Molecule 2: Bacteriophage Mu GpT domain-containing protein

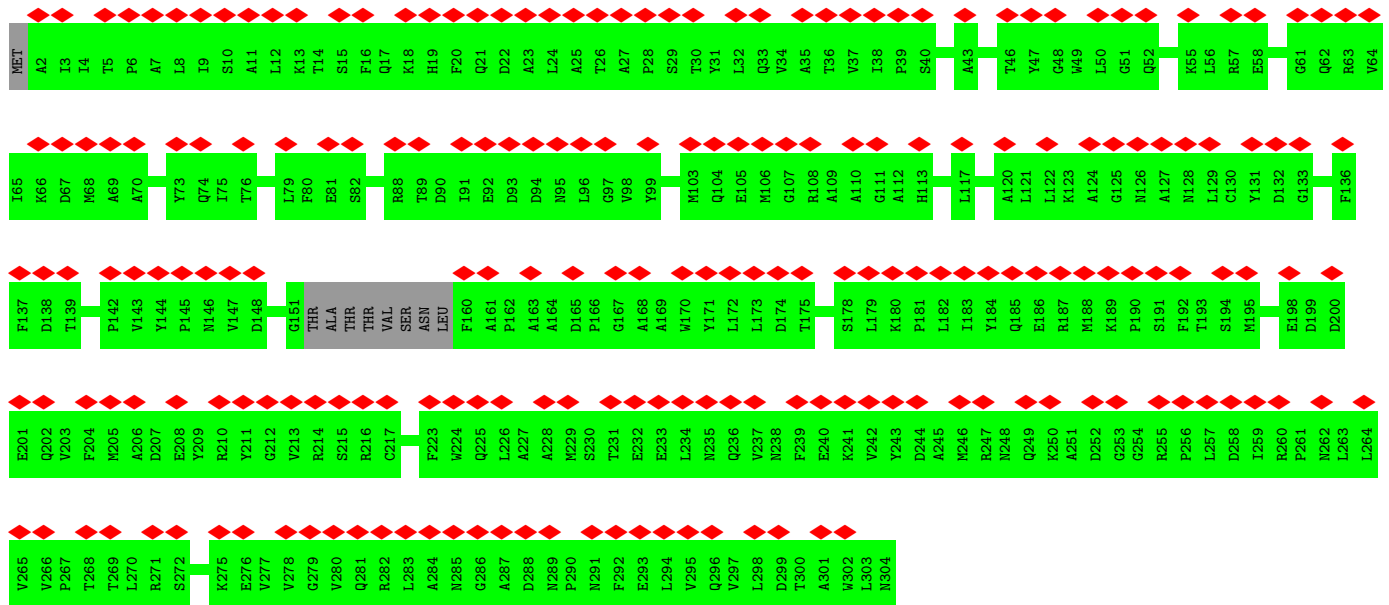

• Molecule 2: Bacteriophage Mu GpT domain-containing protein



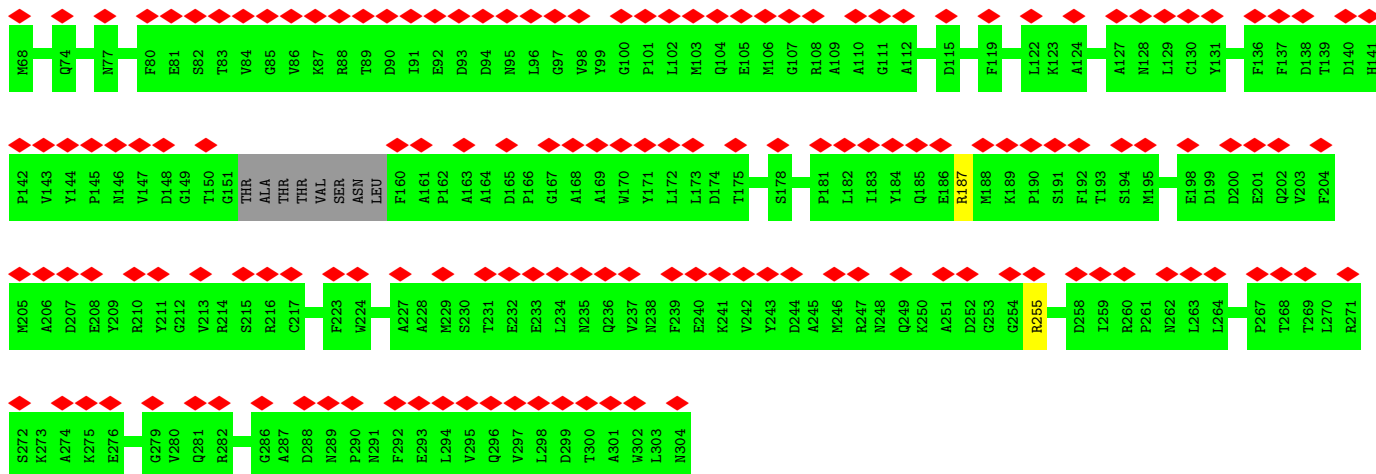

• Molecule 2: Bacteriophage Mu GpT domain-containing protein

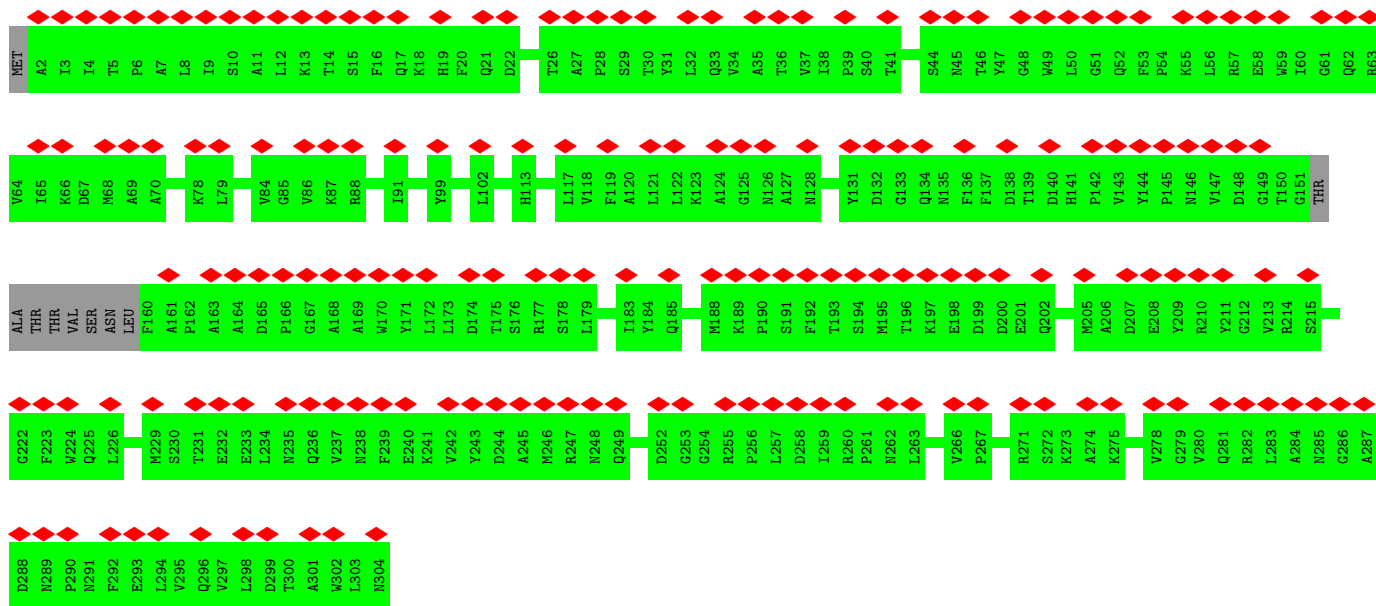

• Molecule 2: Bacteriophage Mu GpT domain-containing protein

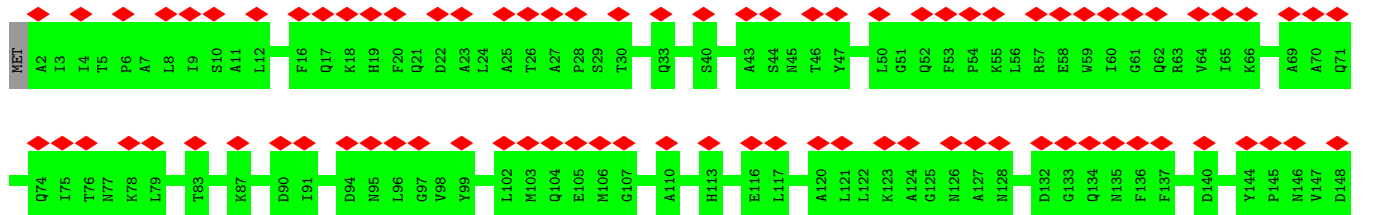

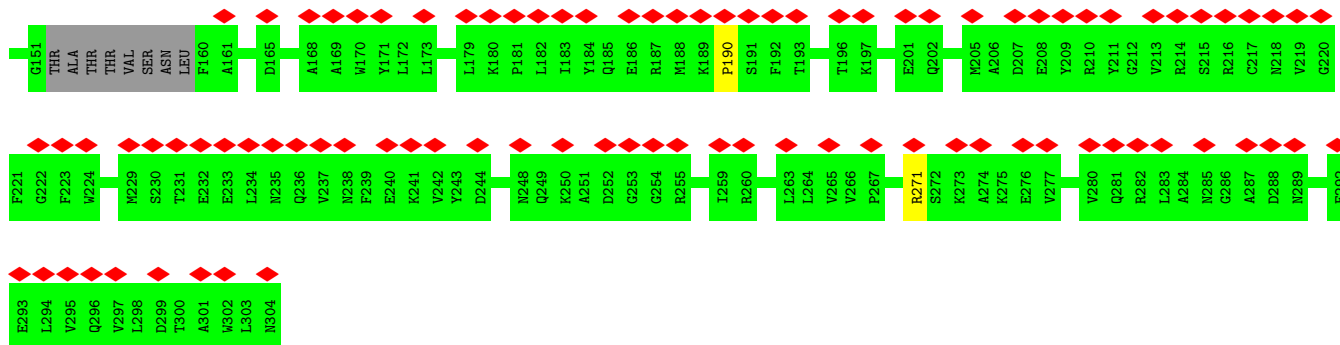

• Molecule 2: Bacteriophage Mu GpT domain-containing protein



• Molecule 2: Bacteriophage Mu GpT domain-containing protein

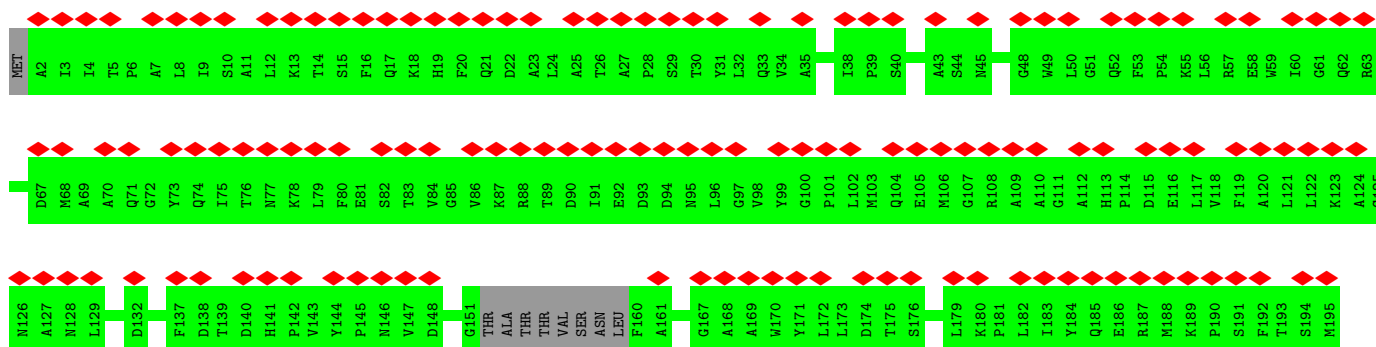

• Molecule 2: Bacteriophage Mu GpT domain-containing protein

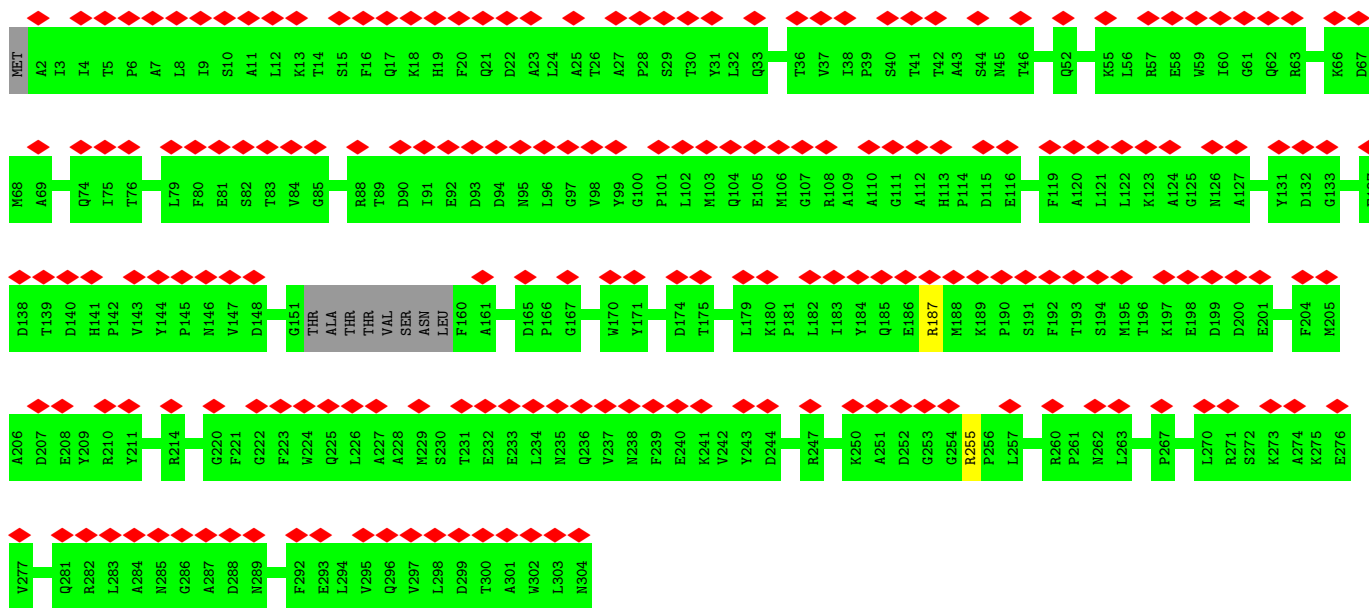

• Molecule 2: Bacteriophage Mu GpT domain-containing protein



• Molecule 2: Bacteriophage Mu GpT domain-containing protein



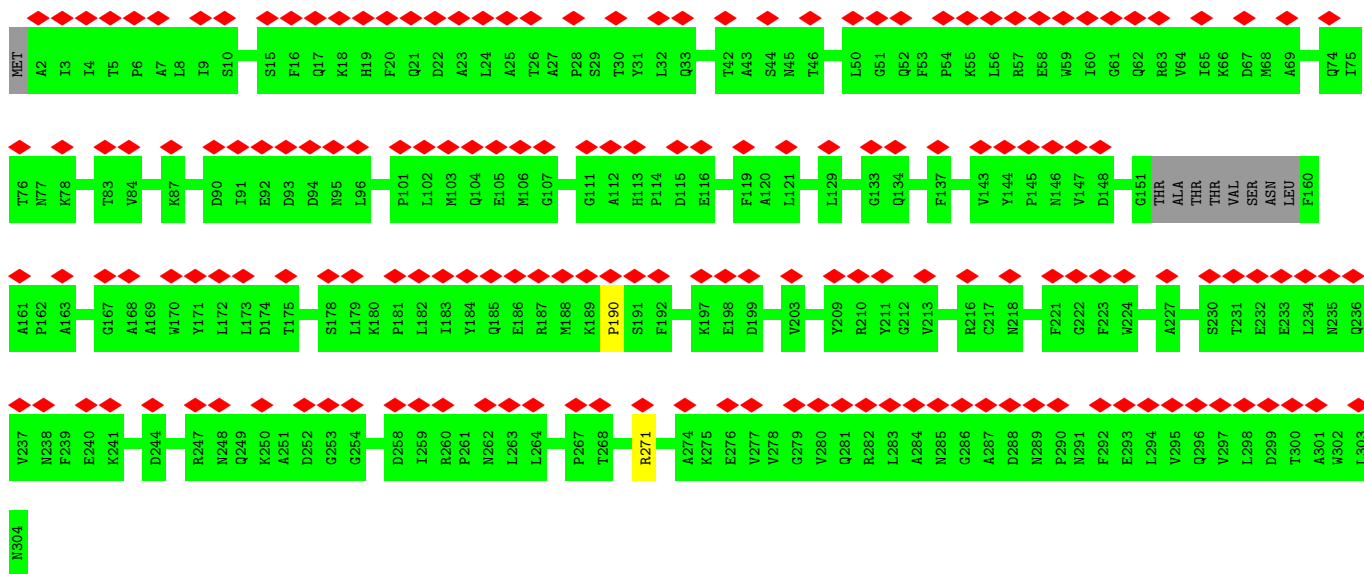

• Molecule 2: Bacteriophage Mu GpT domain-containing protein

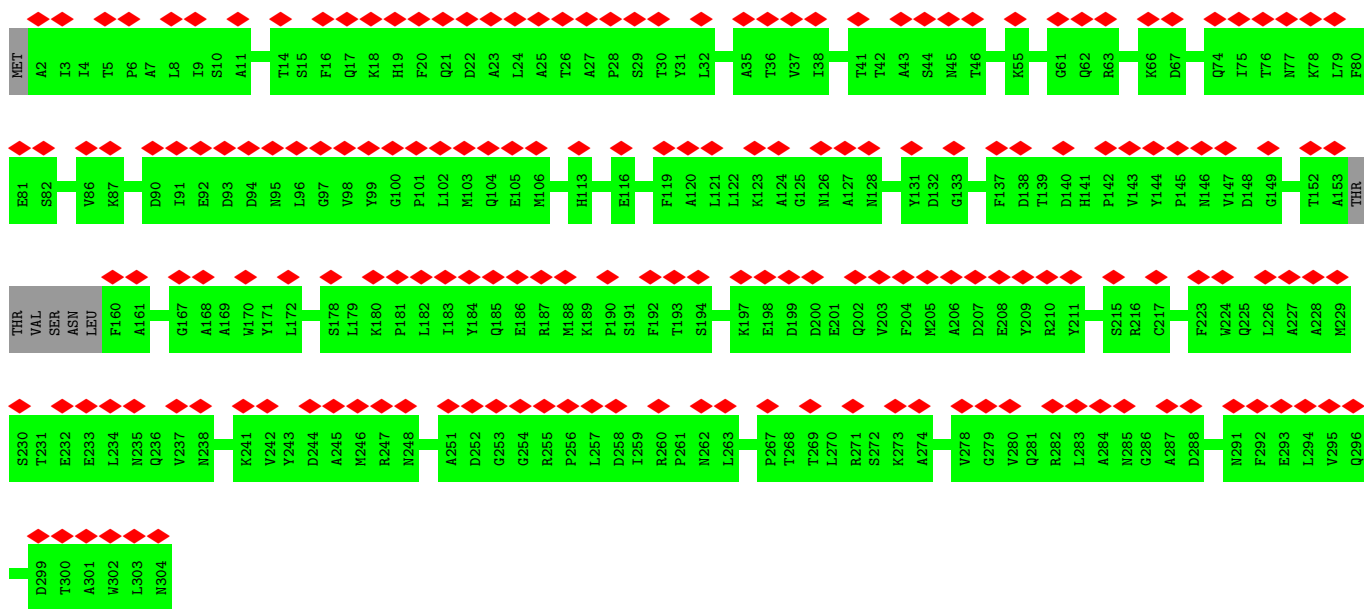

• Molecule 2: Bacteriophage Mu GpT domain-containing protein

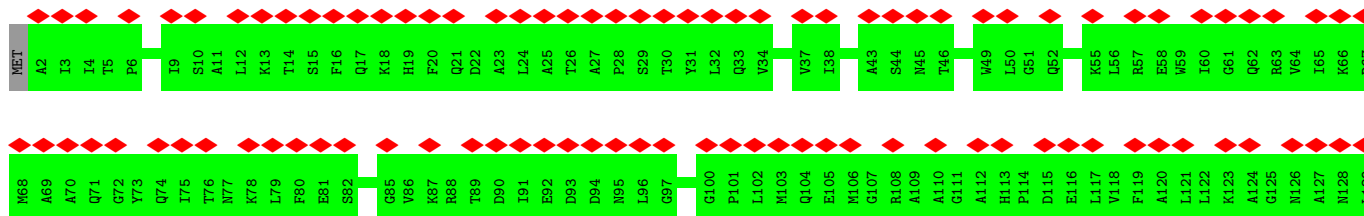

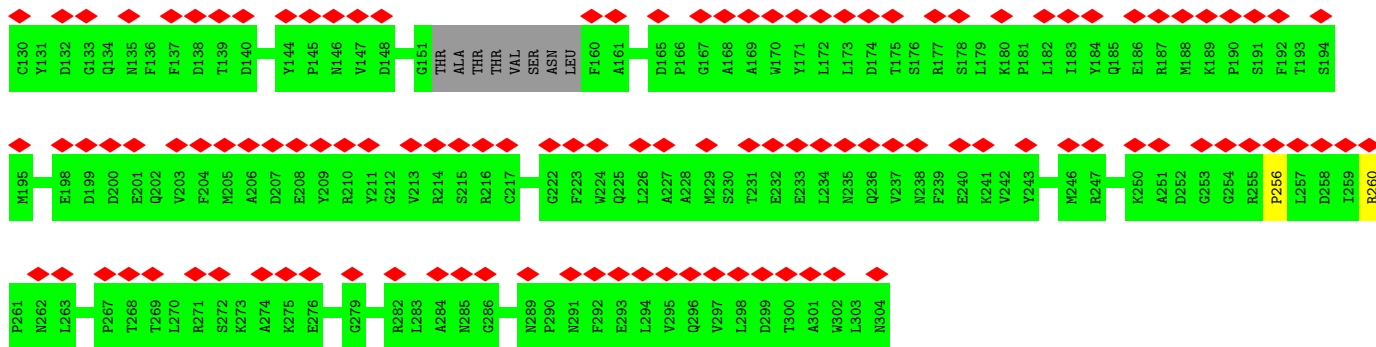

• Molecule 2: Bacteriophage Mu GpT domain-containing protein

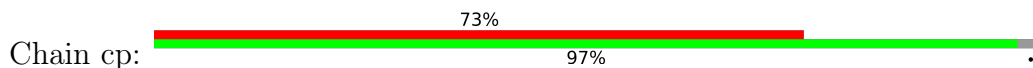

• Molecule 2: Bacteriophage Mu GpT domain-containing protein

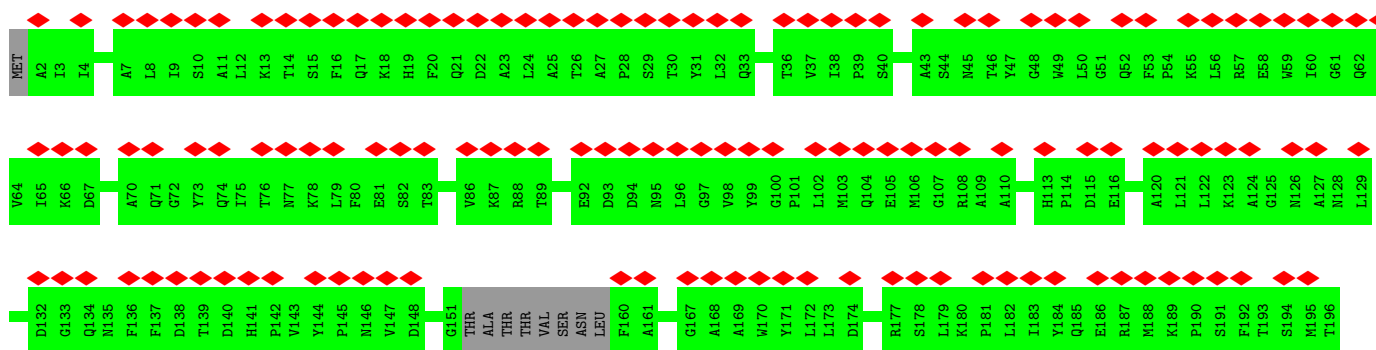

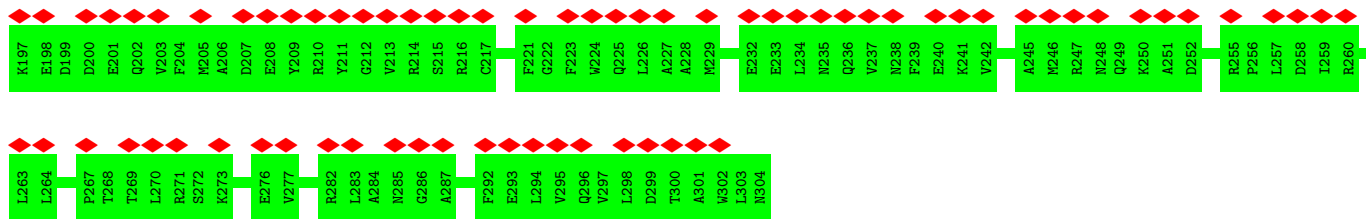

• Molecule 2: Bacteriophage Mu GpT domain-containing protein

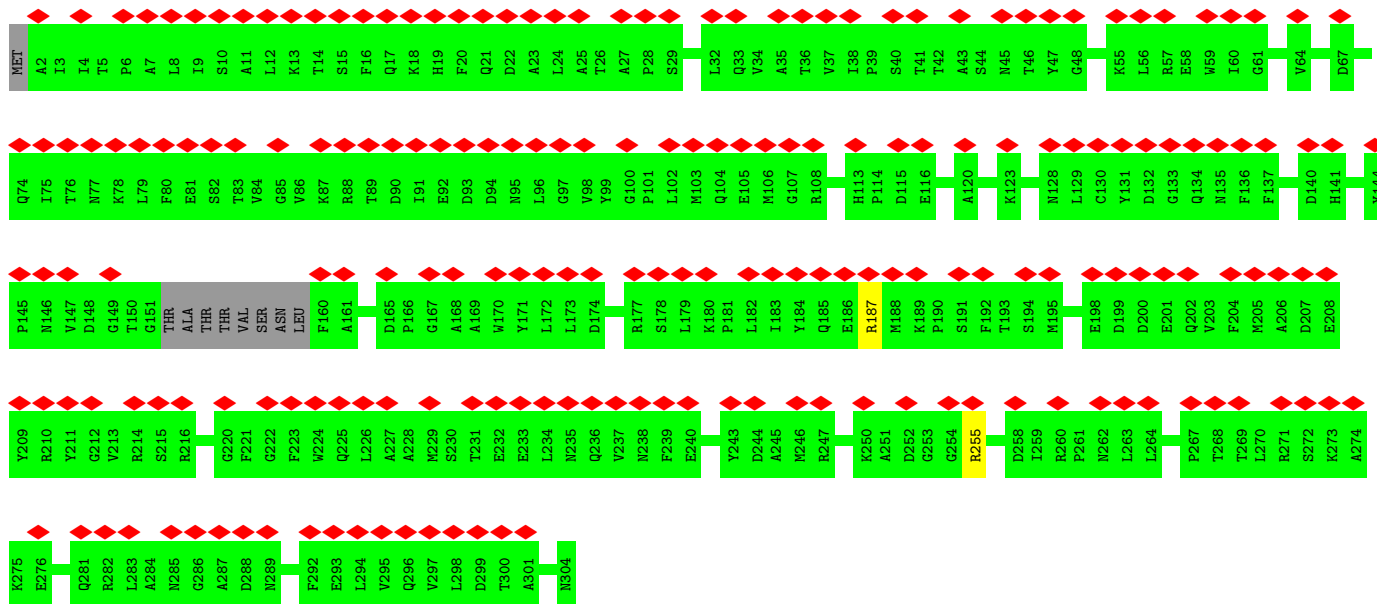

• Molecule 2: Bacteriophage Mu GpT domain-containing protein

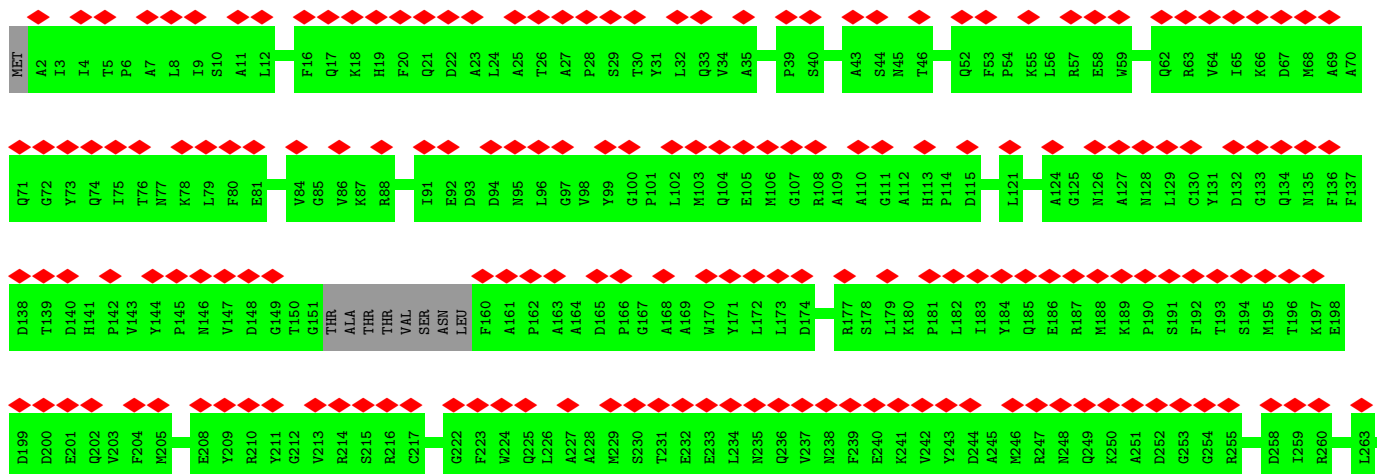

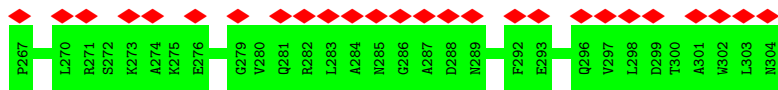

• Molecule 2: Bacteriophage Mu GpT domain-containing protein



• Molecule 2: Bacteriophage Mu GpT domain-containing protein



• Molecule 2: Bacteriophage Mu GpT domain-containing protein

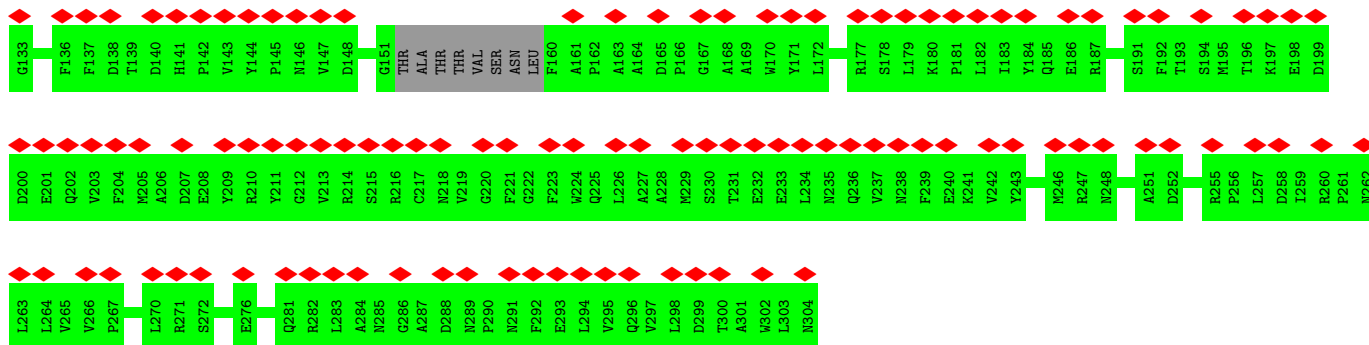

• Molecule 2: Bacteriophage Mu GpT domain-containing protein

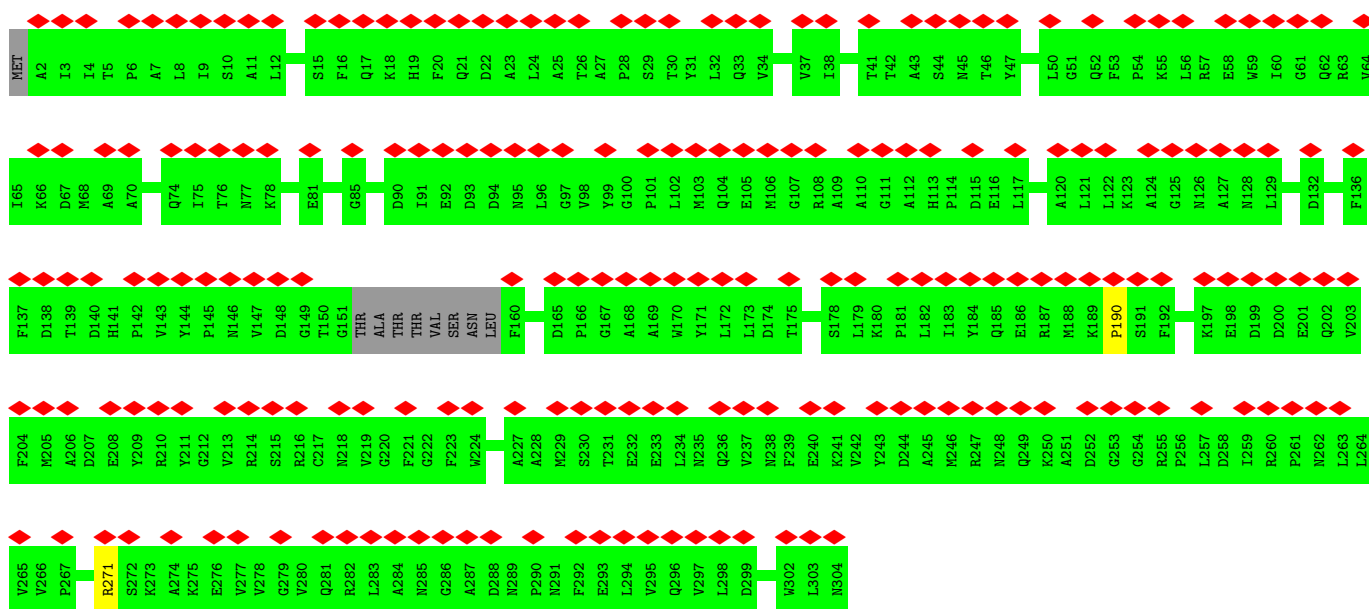

• Molecule 2: Bacteriophage Mu GpT domain-containing protein

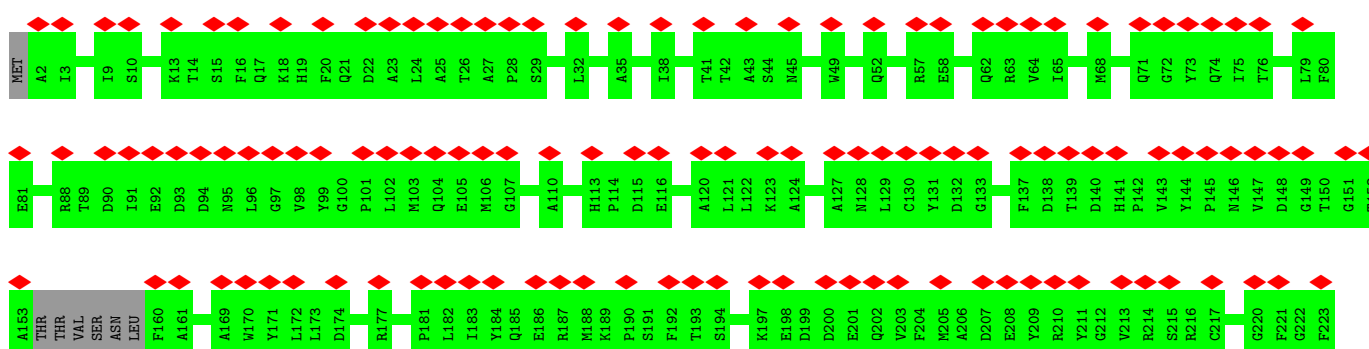



• Molecule 2: Bacteriophage Mu GpT domain-containing protein

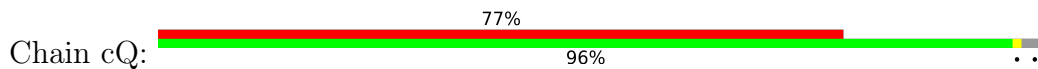

• Molecule 2: Bacteriophage Mu GpT domain-containing protein

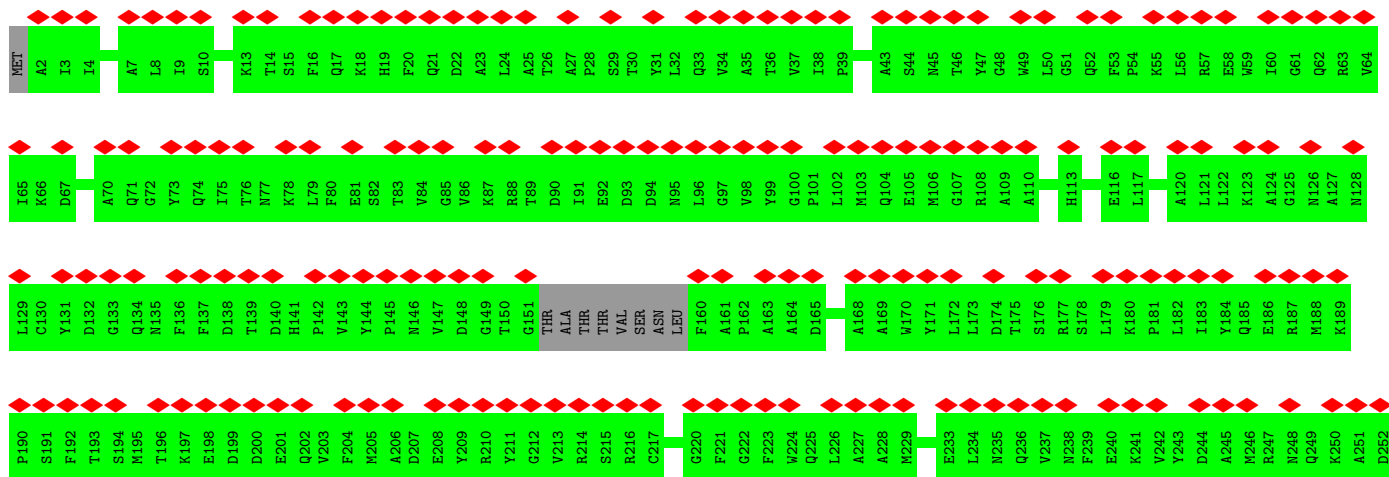
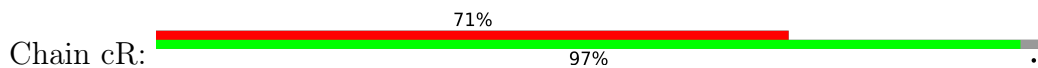

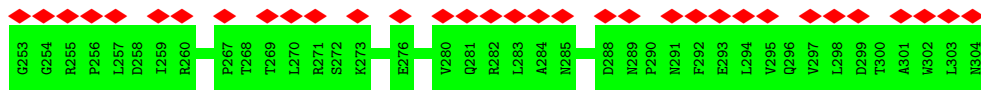

• Molecule 2: Bacteriophage Mu GpT domain-containing protein

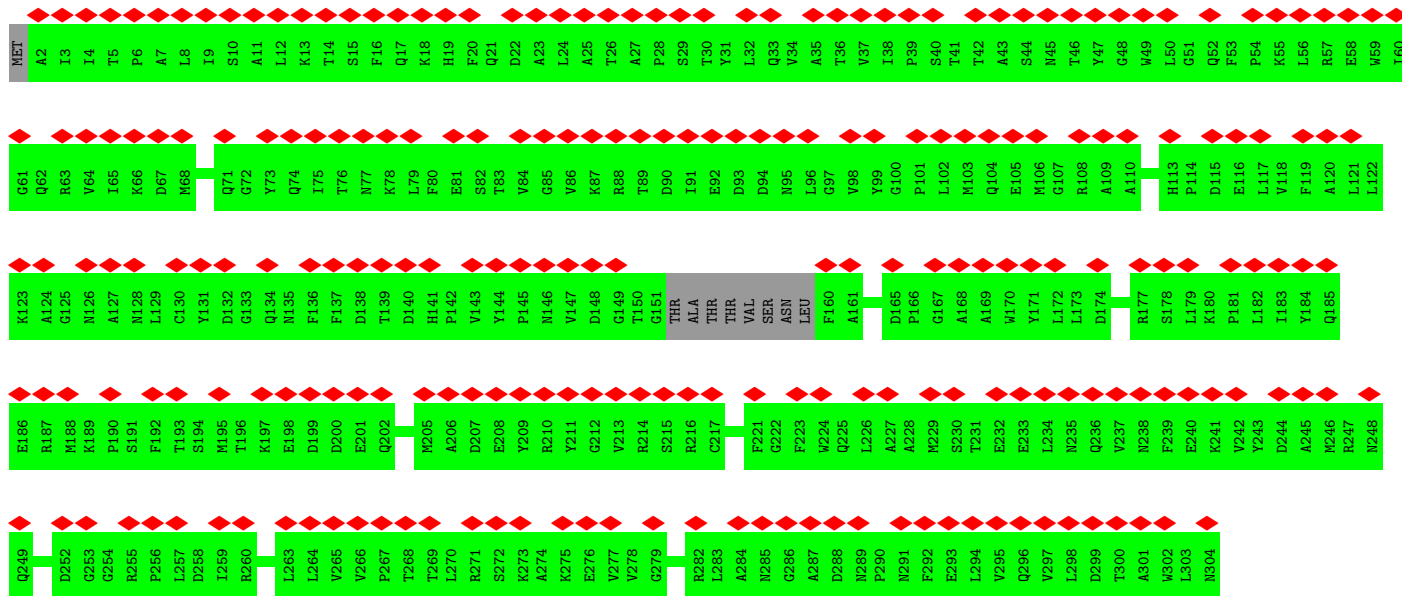
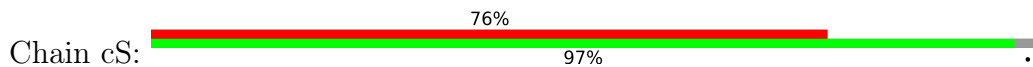

• Molecule 2: Bacteriophage Mu GpT domain-containing protein



• Molecule 2: Bacteriophage Mu GpT domain-containing protein

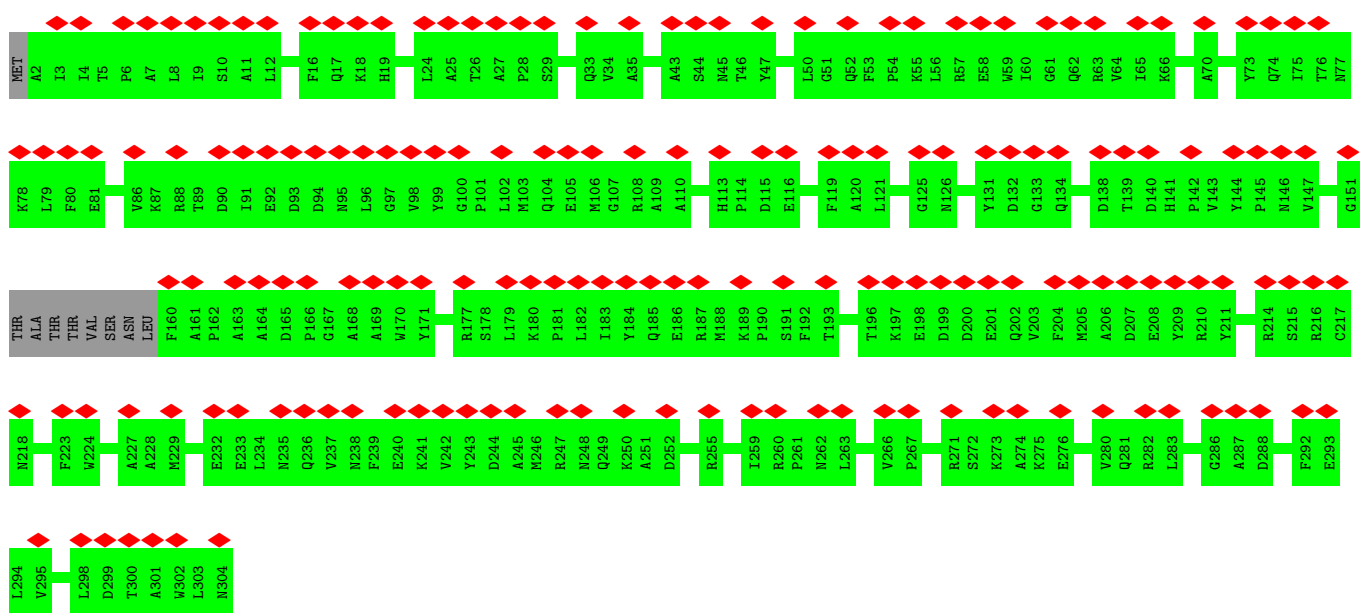

• Molecule 2: Bacteriophage Mu GpT domain-containing protein

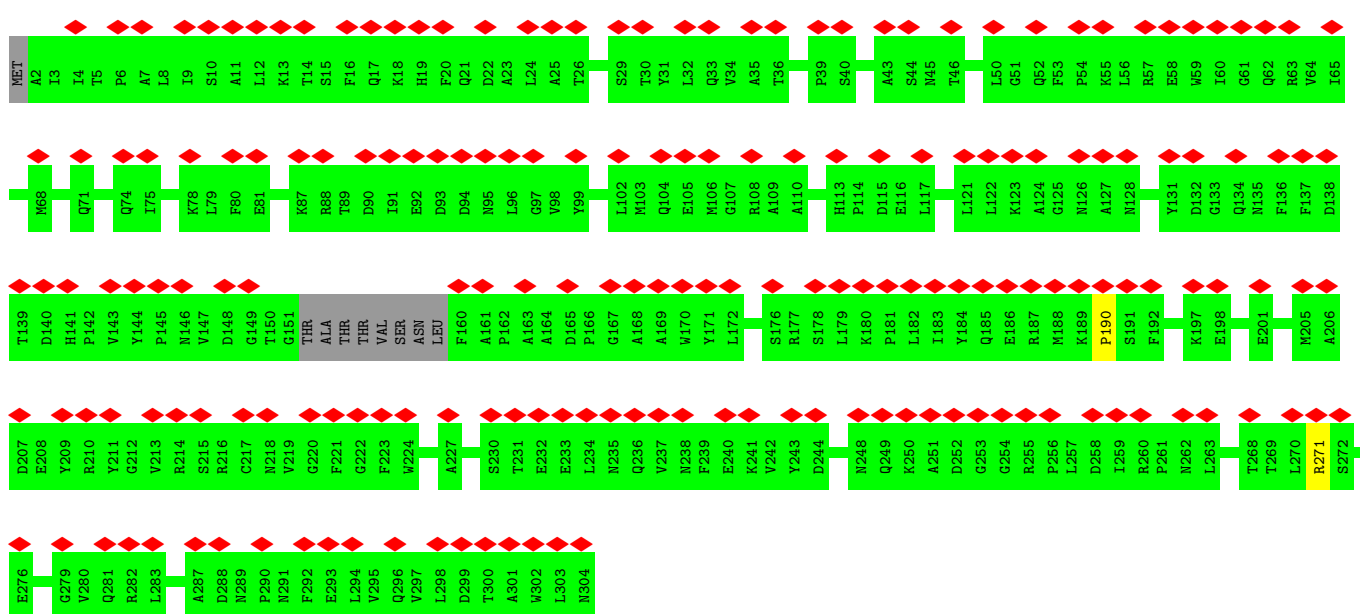

• Molecule 2: Bacteriophage Mu GpT domain-containing protein

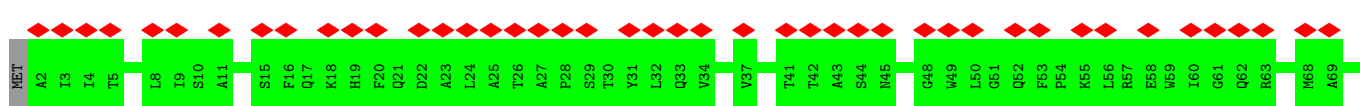

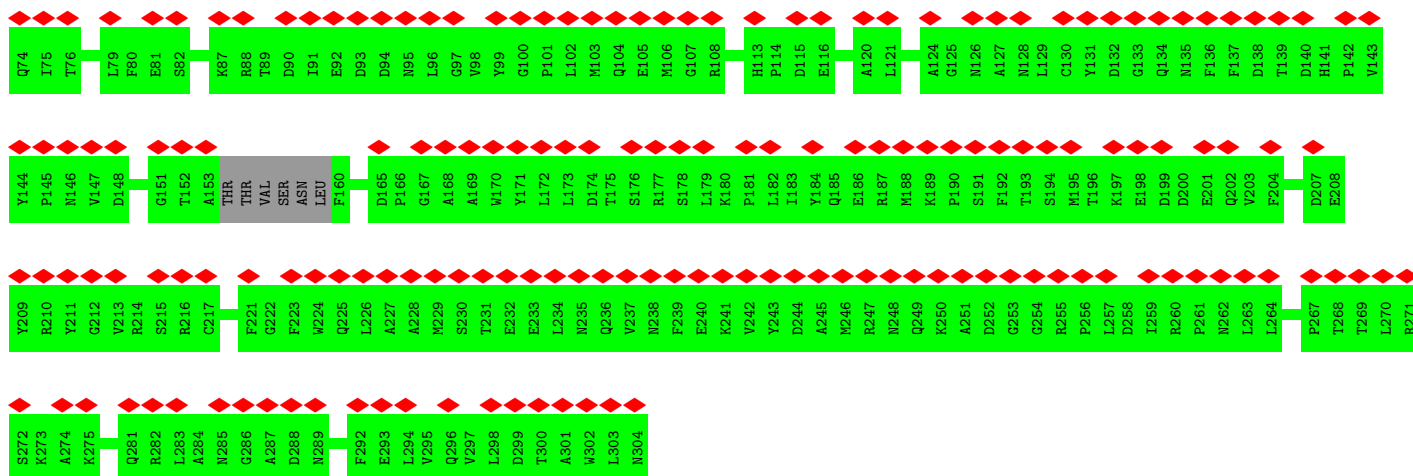

• Molecule 2: Bacteriophage Mu GpT domain-containing protein



• Molecule 2: Bacteriophage Mu GpT domain-containing protein

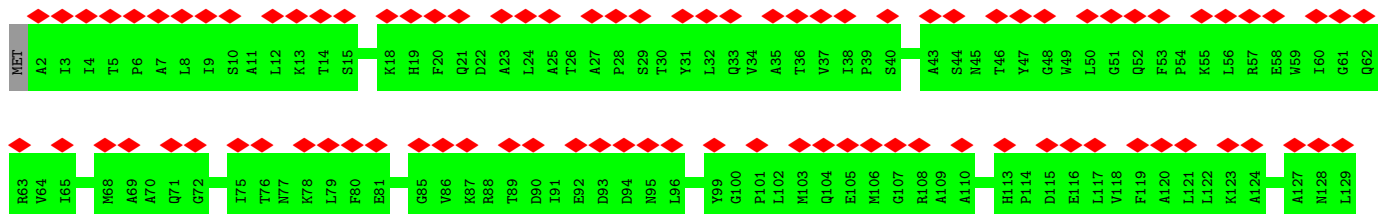

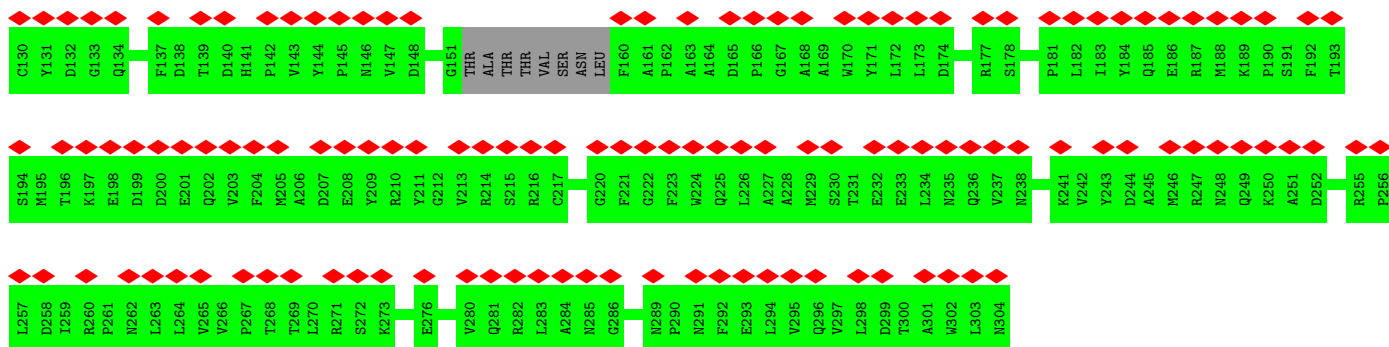

• Molecule 2: Bacteriophage Mu GpT domain-containing protein



• Molecule 2: Bacteriophage Mu GpT domain-containing protein

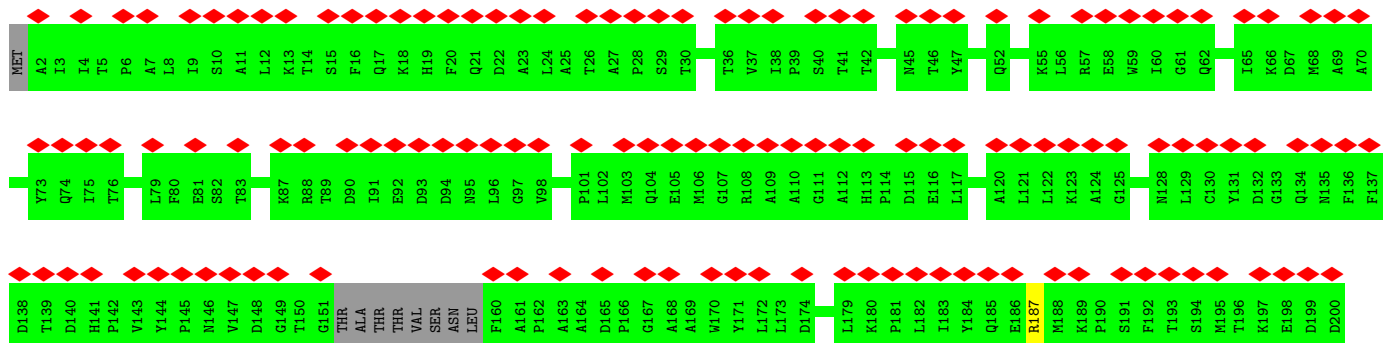

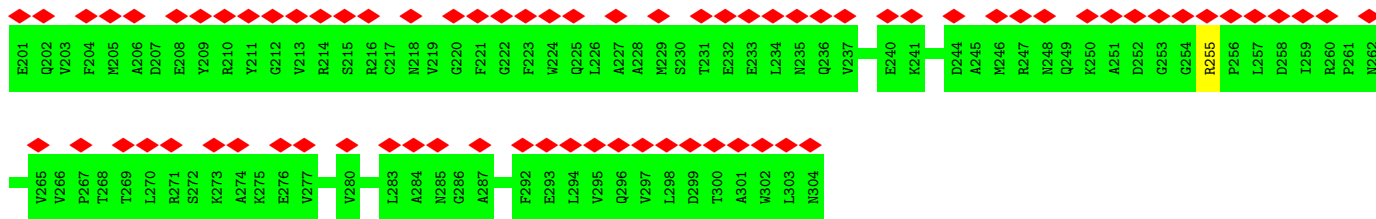

• Molecule 2: Bacteriophage Mu GpT domain-containing protein



• Molecule 2: Bacteriophage Mu GpT domain-containing protein

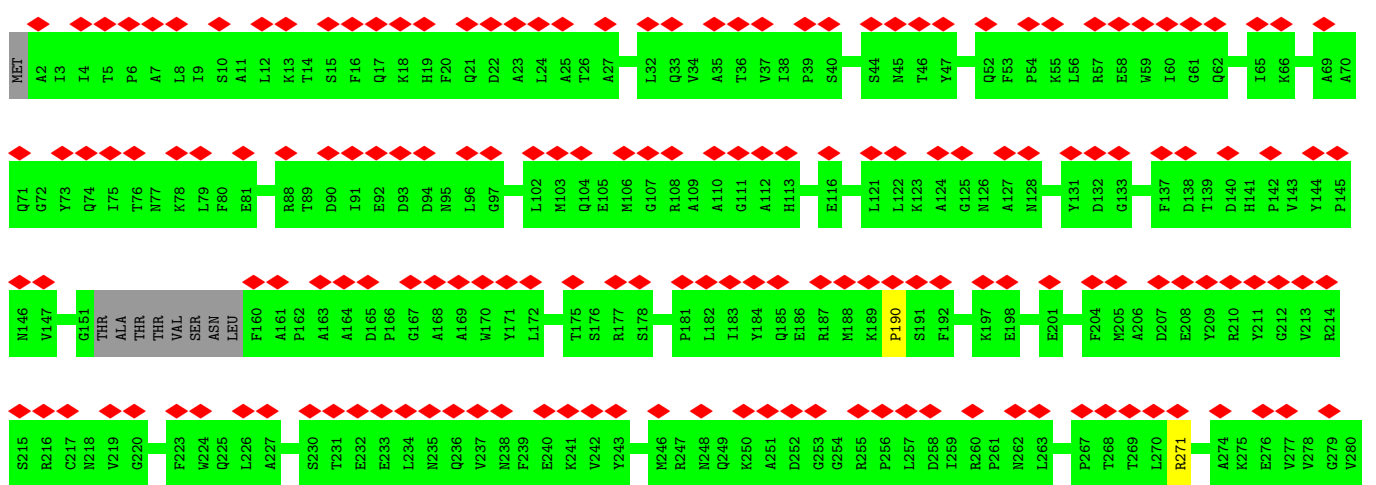

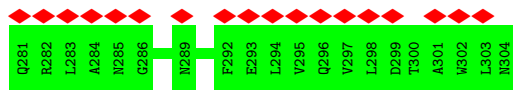

• Molecule 2: Bacteriophage Mu GpT domain-containing protein



• Molecule 2: Bacteriophage Mu GpT domain-containing protein

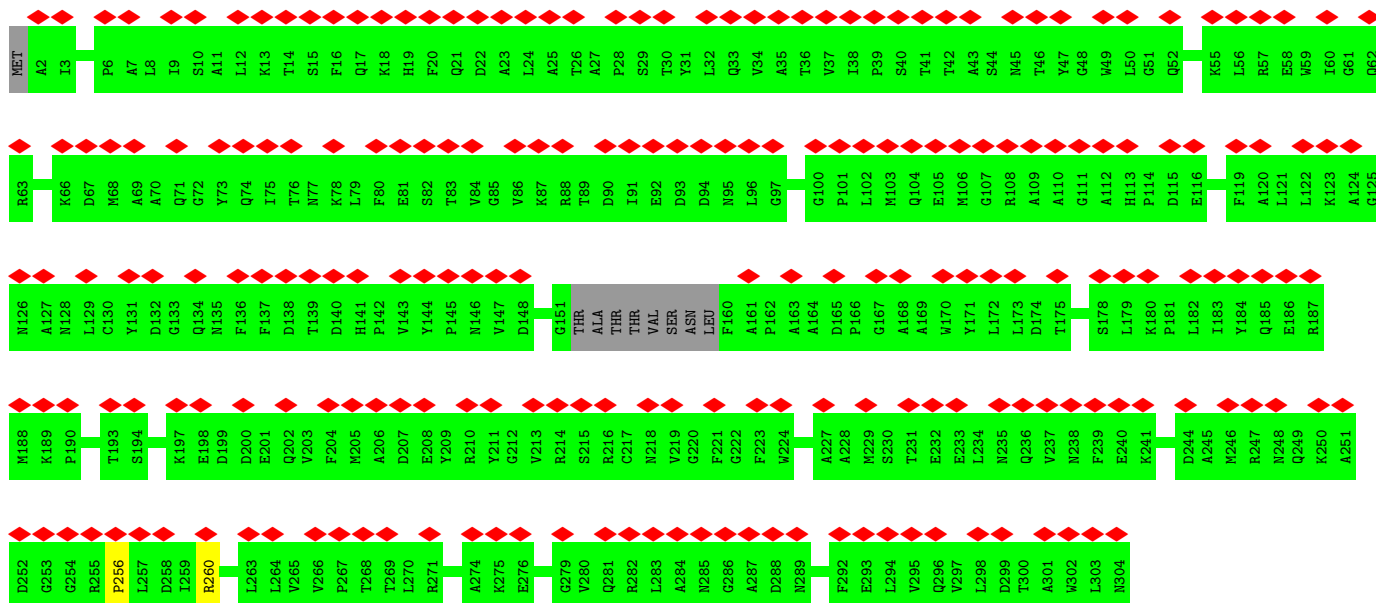

• Molecule 2: Bacteriophage Mu GpT domain-containing protein

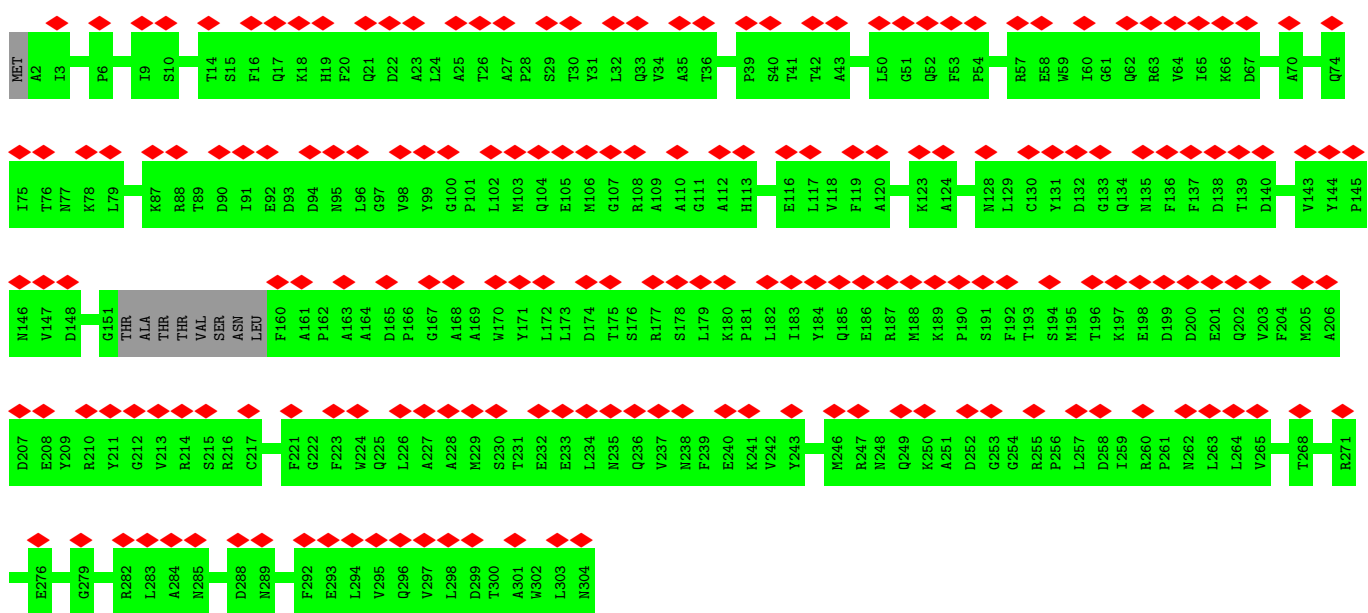

• Molecule 2: Bacteriophage Mu GpT domain-containing protein

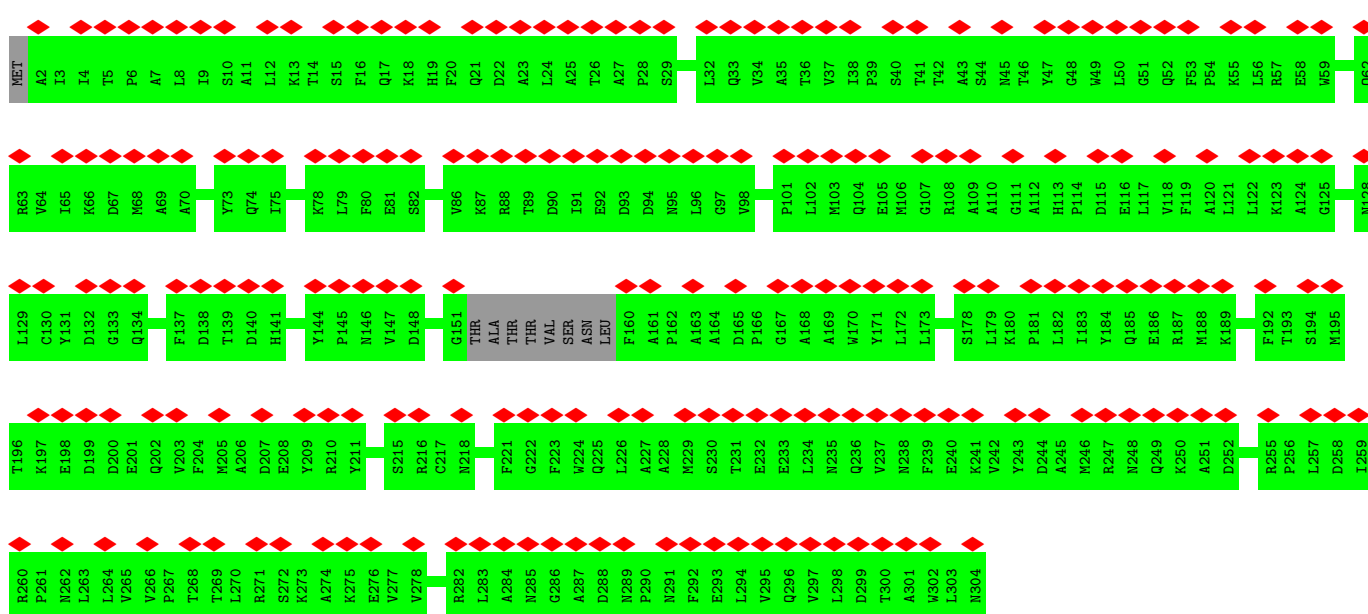
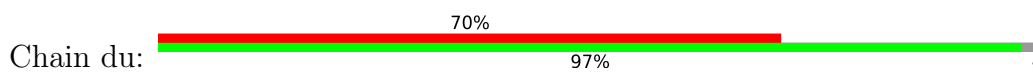

• Molecule 2: Bacteriophage Mu GpT domain-containing protein

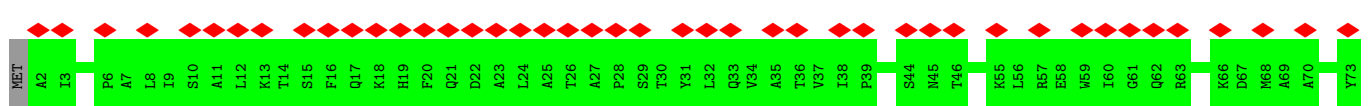

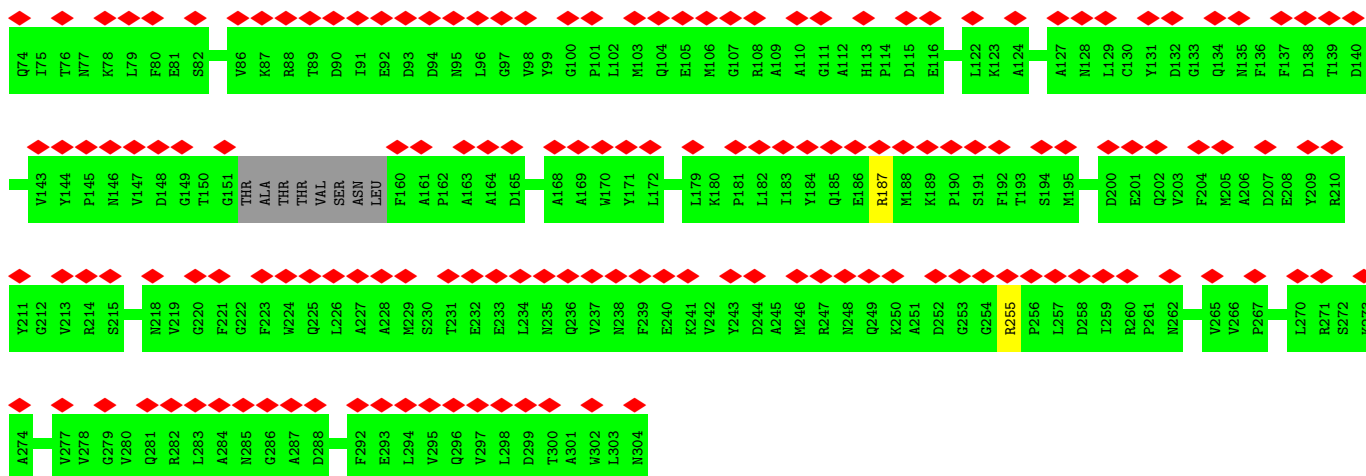

• Molecule 2: Bacteriophage Mu GpT domain-containing protein

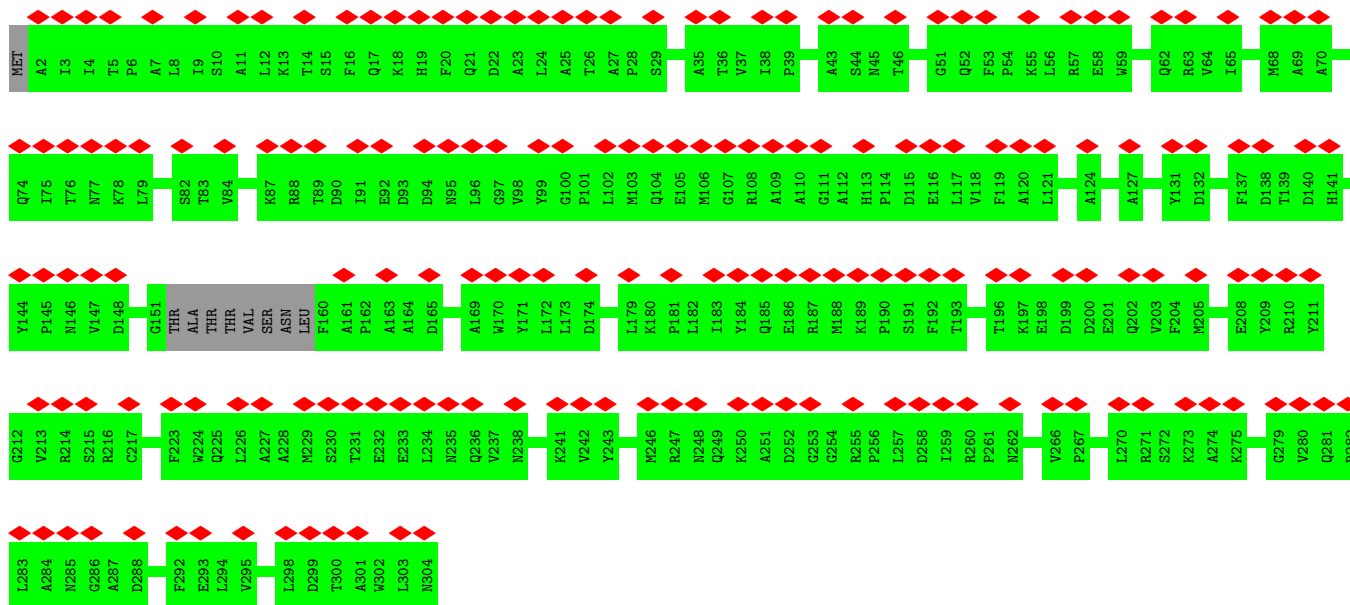

• Molecule 2: Bacteriophage Mu GpT domain-containing protein

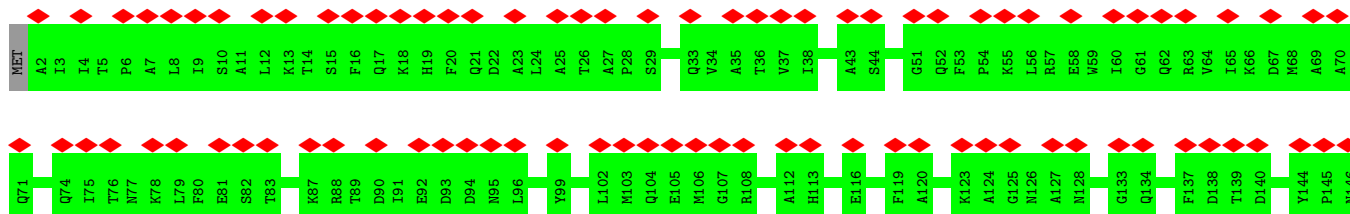

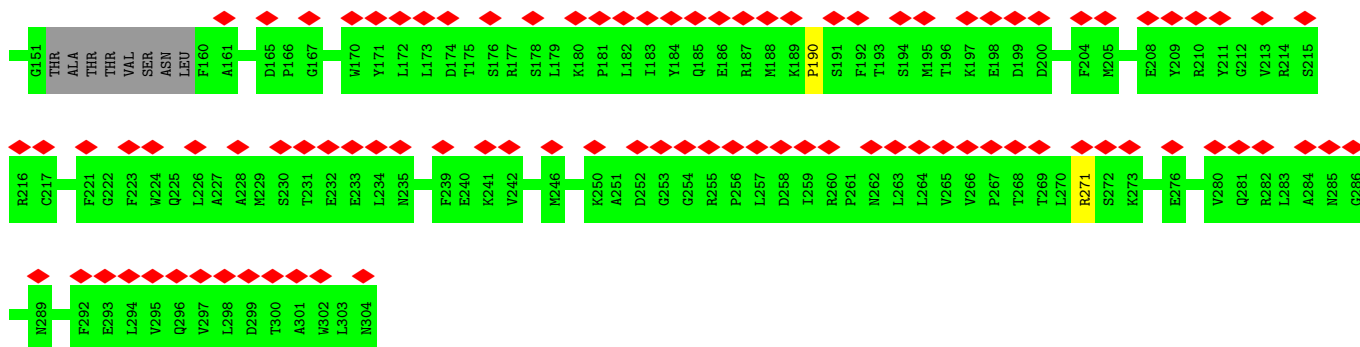

• Molecule 2: Bacteriophage Mu GpT domain-containing protein



• Molecule 2: Bacteriophage Mu GpT domain-containing protein

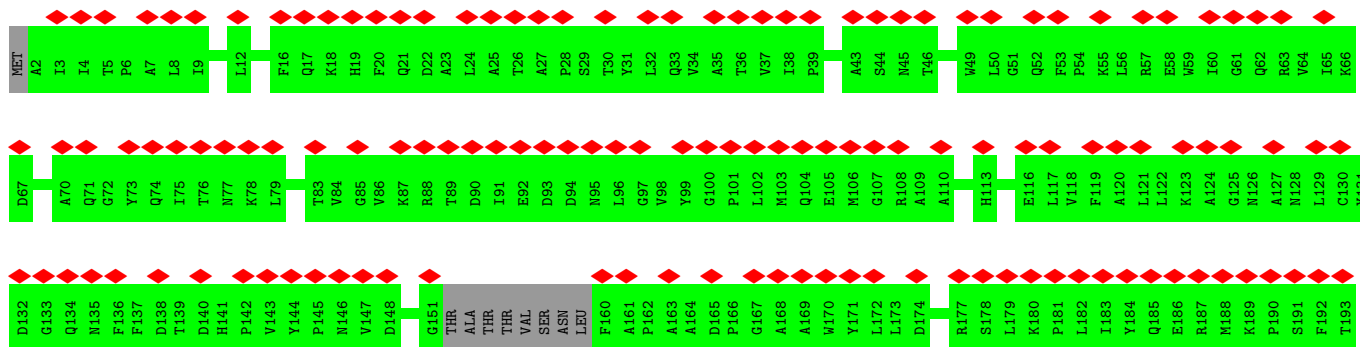

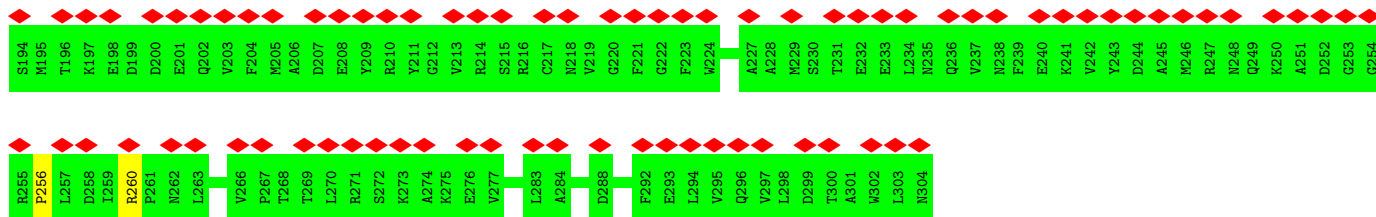

• Molecule 2: Bacteriophage Mu GpT domain-containing protein

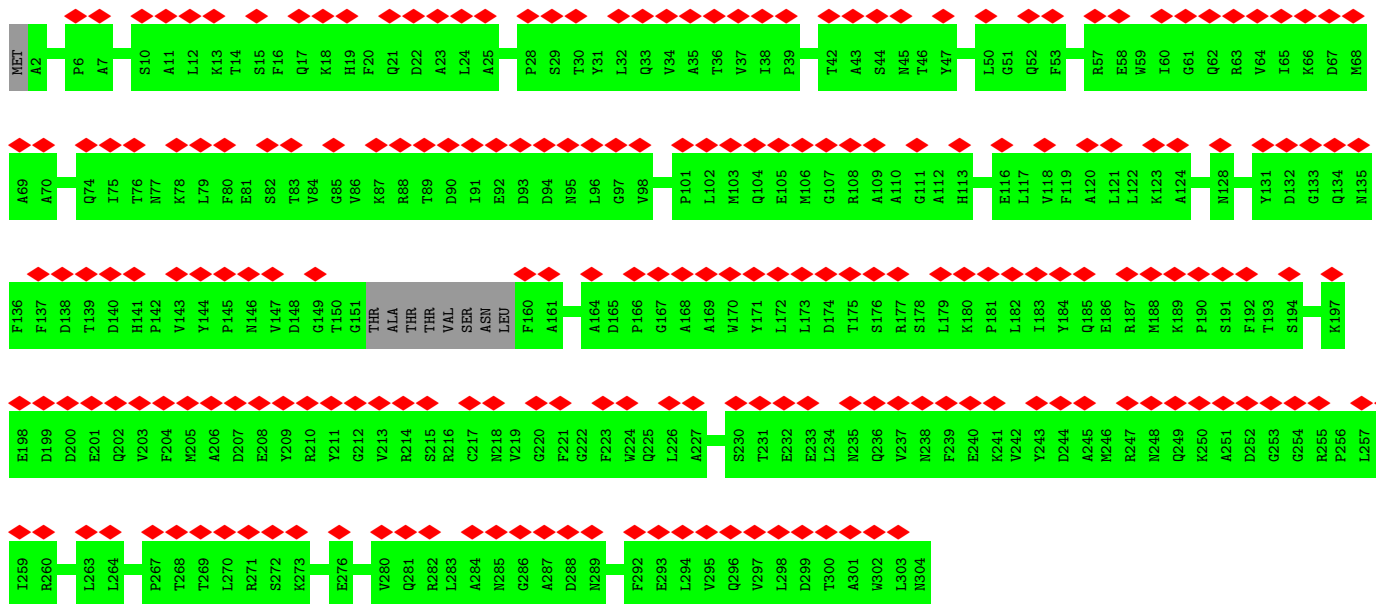
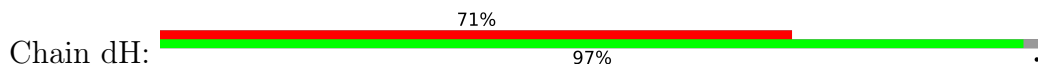

• Molecule 2: Bacteriophage Mu GpT domain-containing protein

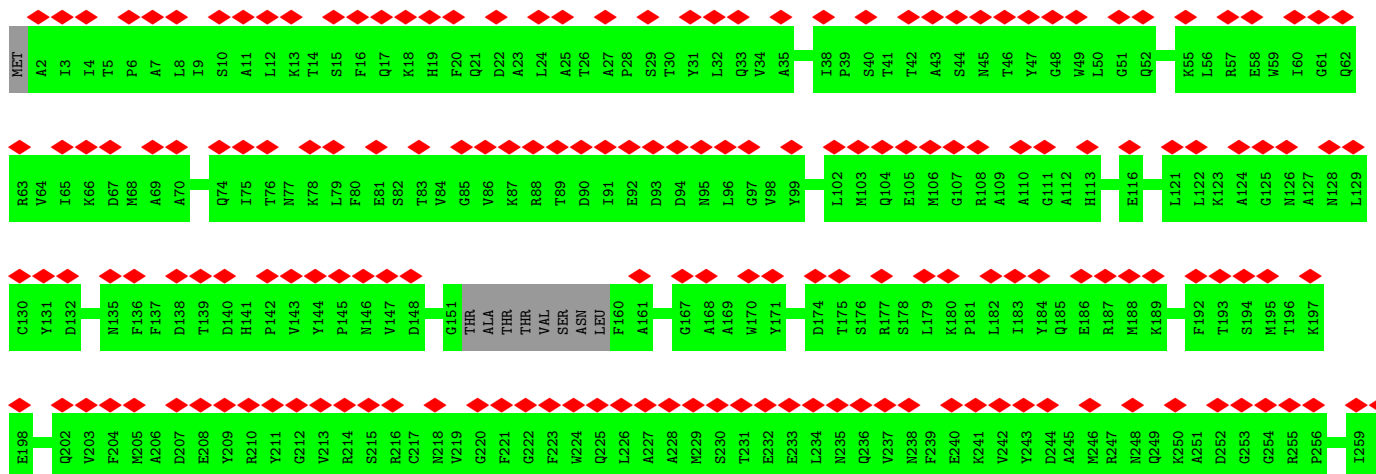

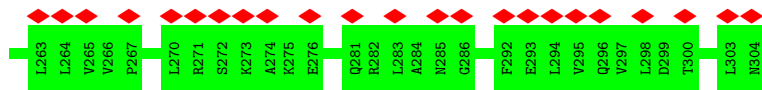

• Molecule 2: Bacteriophage Mu GpT domain-containing protein



Chain dJ:

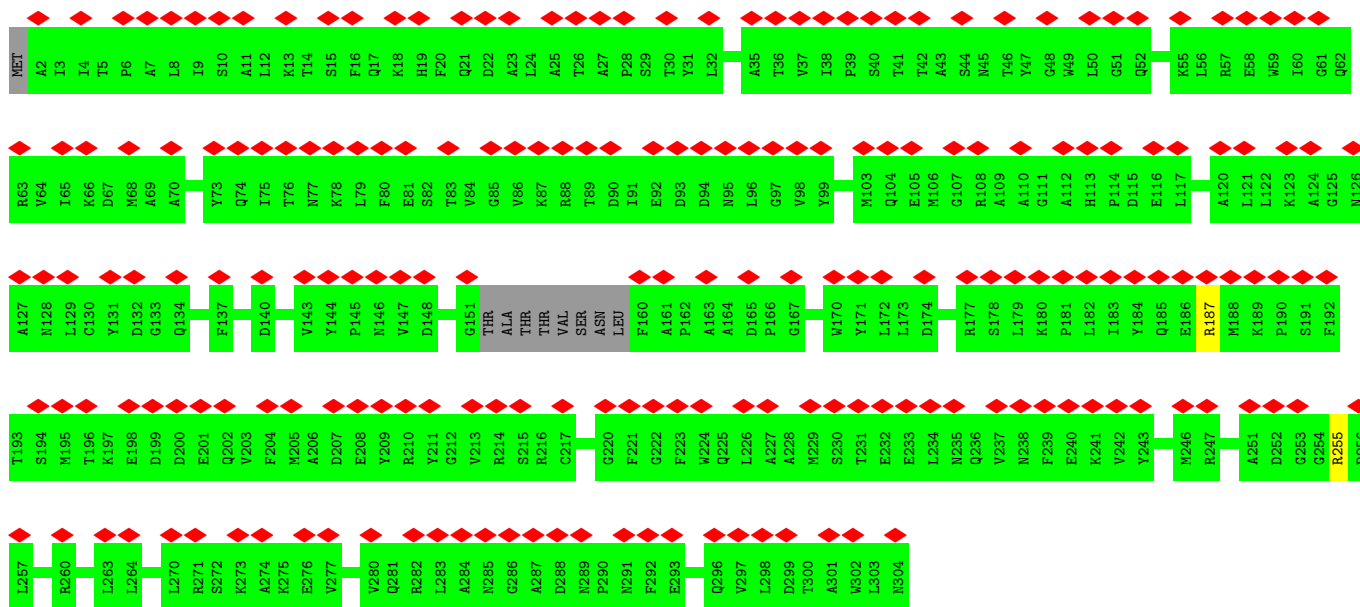

• Molecule 2: Bacteriophage Mu GpT domain-containing protein



Chain dK:

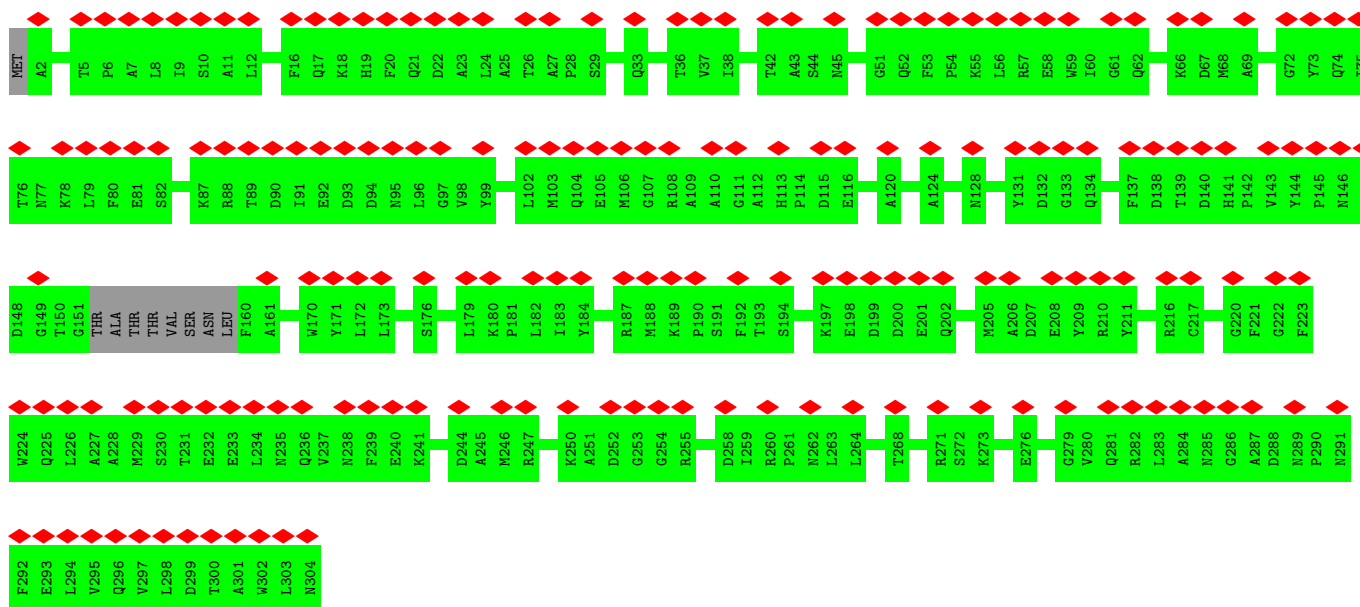

• Molecule 2: Bacteriophage Mu GpT domain-containing protein

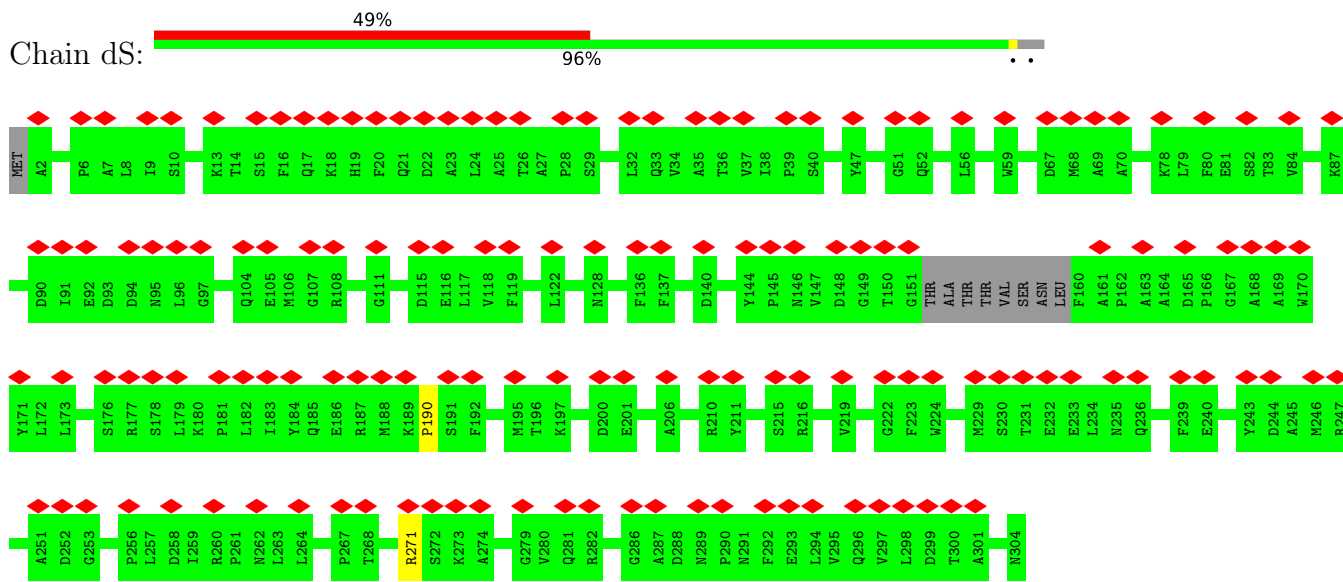

• Molecule 2: Bacteriophage Mu GpT domain-containing protein

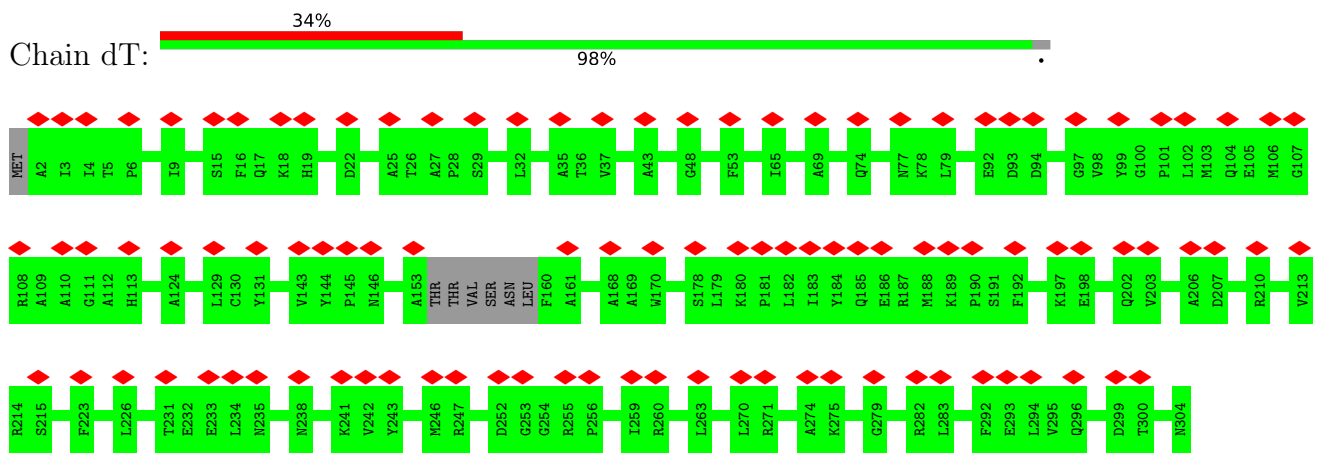

• Molecule 2: Bacteriophage Mu GpT domain-containing protein

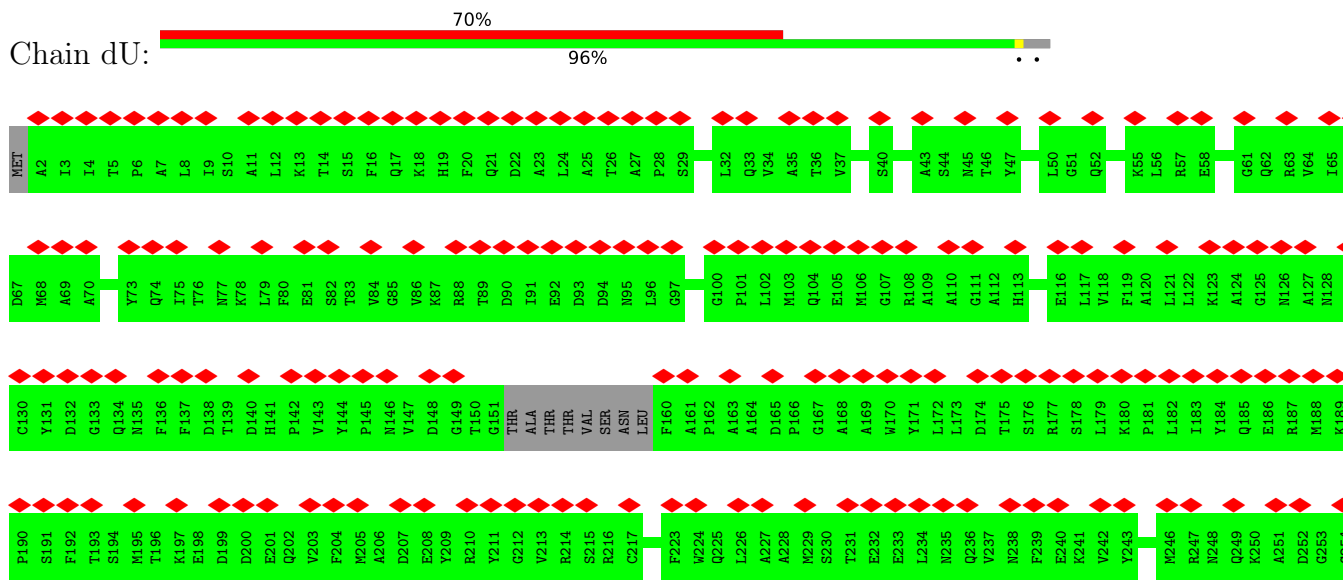

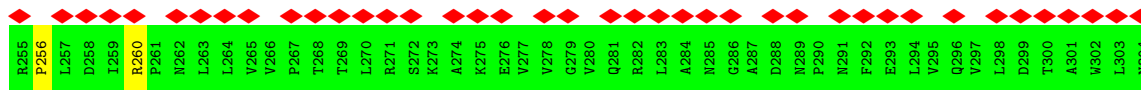

• Molecule 2: Bacteriophage Mu GpT domain-containing protein

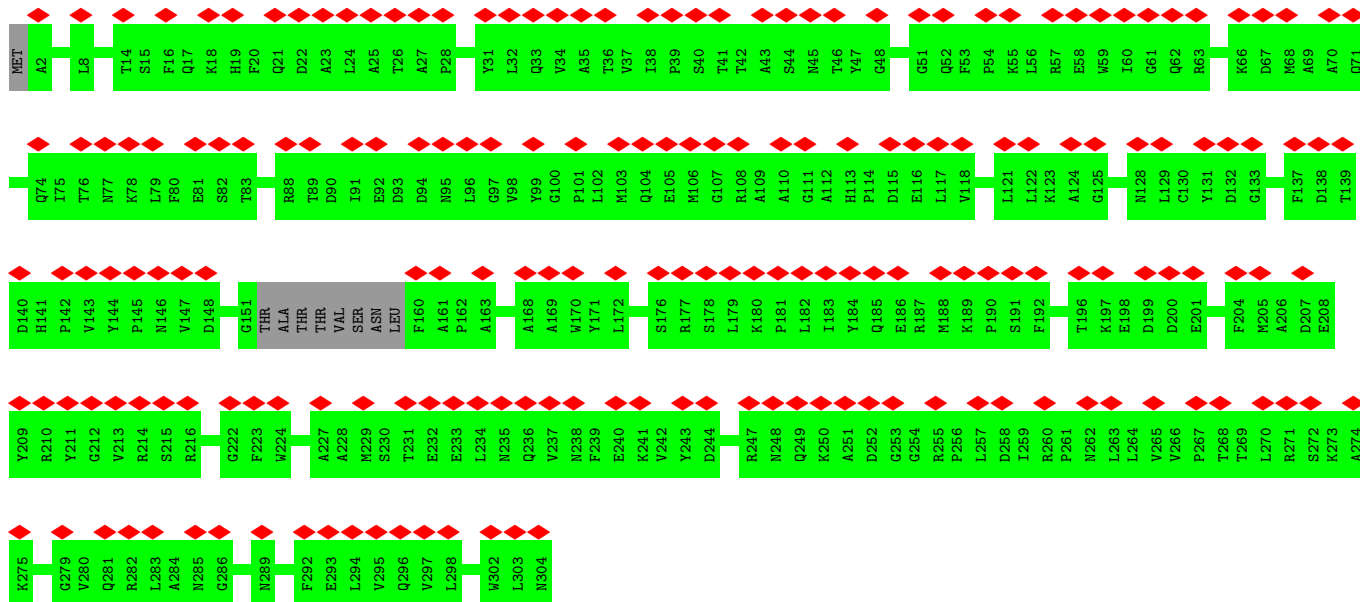

• Molecule 2: Bacteriophage Mu GpT domain-containing protein

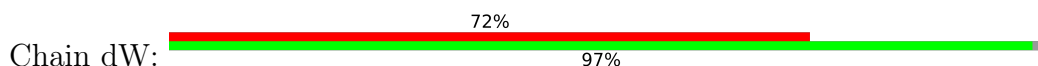

• Molecule 2: Bacteriophage Mu GpT domain-containing protein

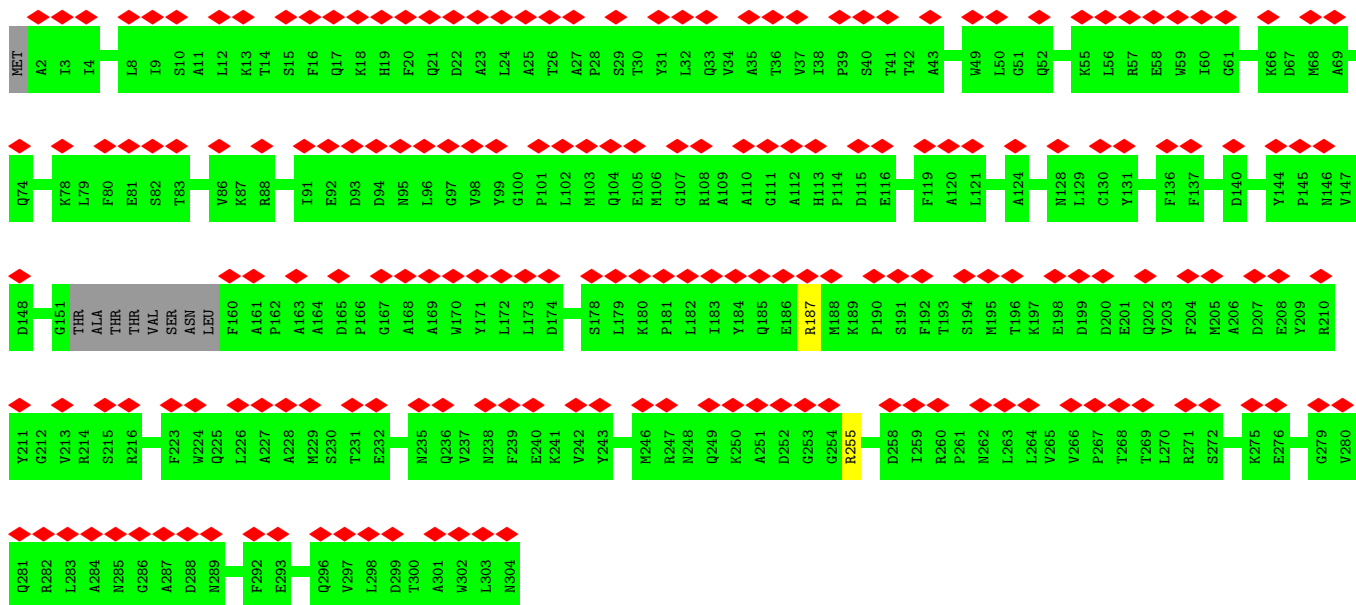

• Molecule 2: Bacteriophage Mu GpT domain-containing protein

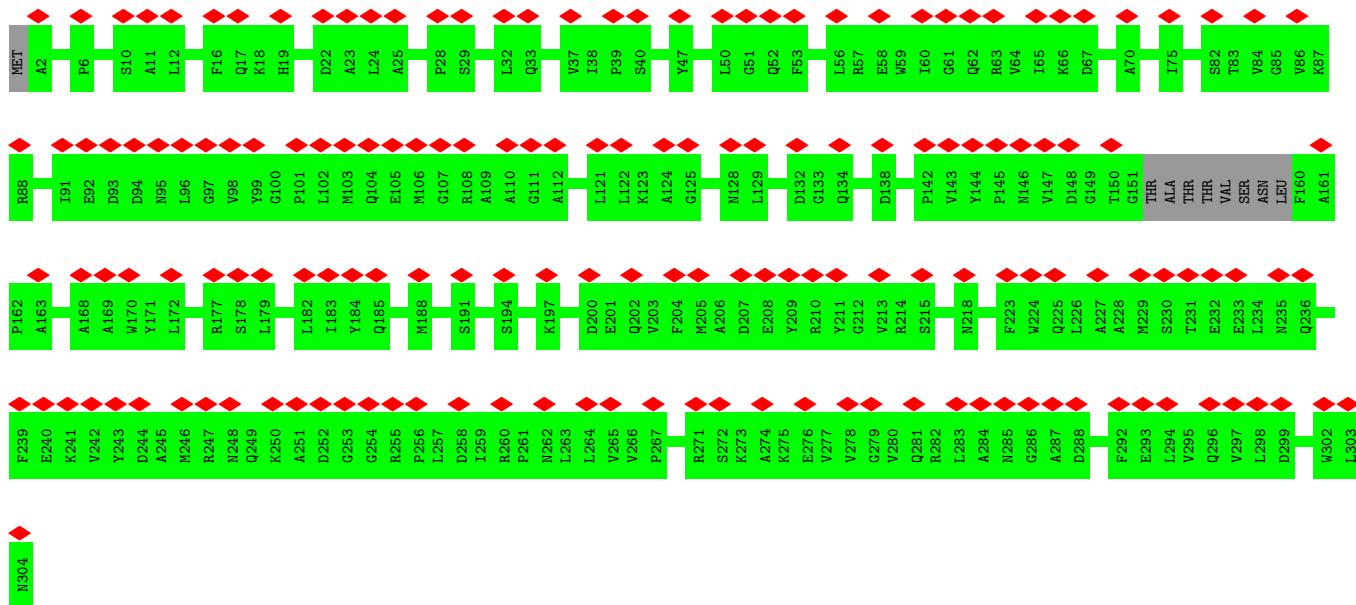

• Molecule 2: Bacteriophage Mu GpT domain-containing protein

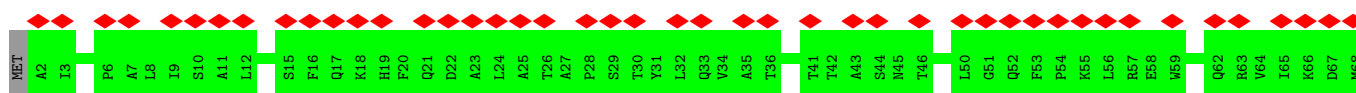

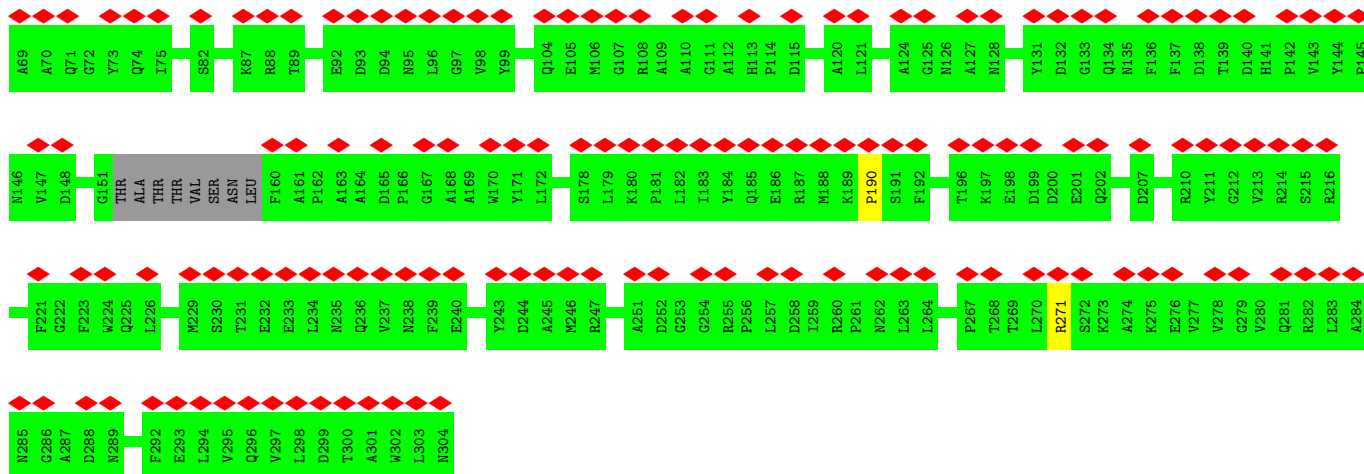

• Molecule 2: Bacteriophage Mu GpT domain-containing protein



• Molecule 2: Bacteriophage Mu GpT domain-containing protein

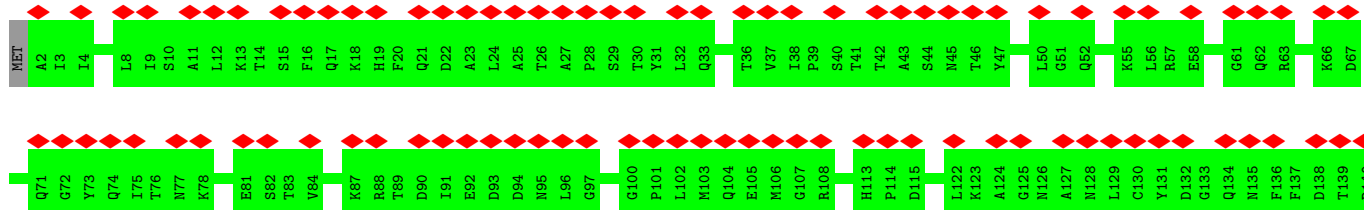

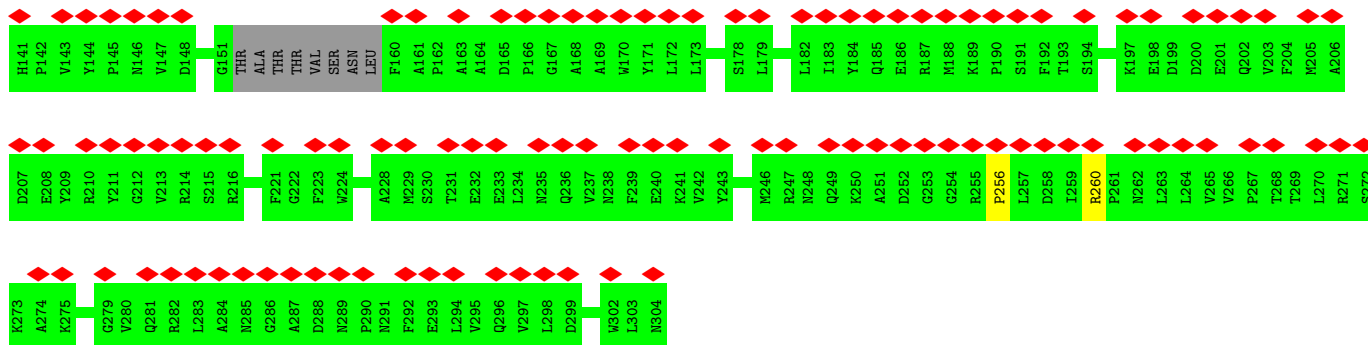

• Molecule 2: Bacteriophage Mu GpT domain-containing protein



• Molecule 2: Bacteriophage Mu GpT domain-containing protein

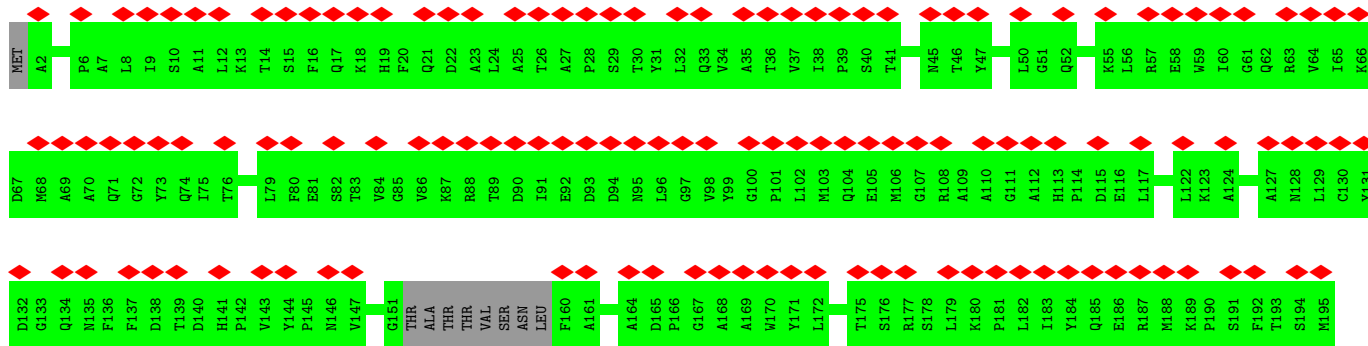

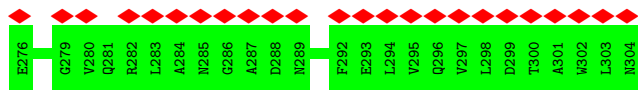

• Molecule 2: Bacteriophage Mu GpT domain-containing protein

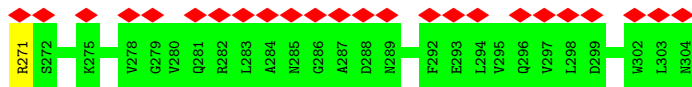
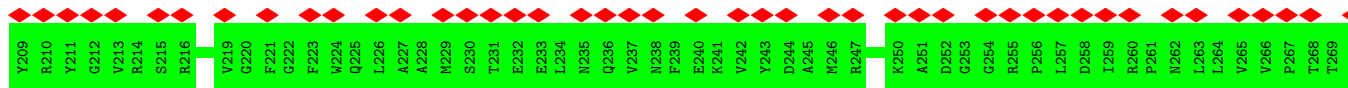
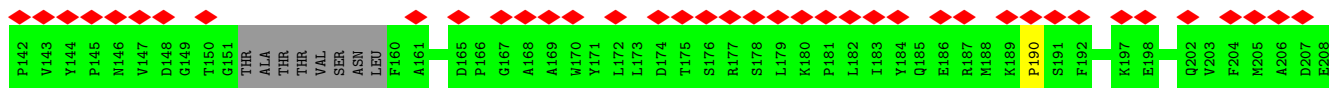
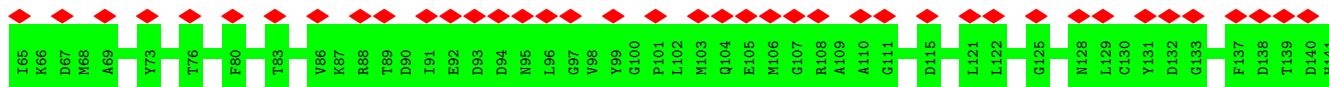
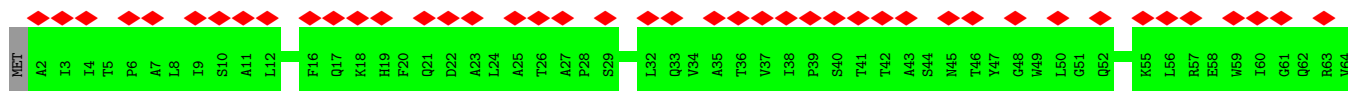

• Molecule 2: Bacteriophage Mu GpT domain-containing protein

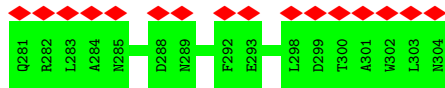
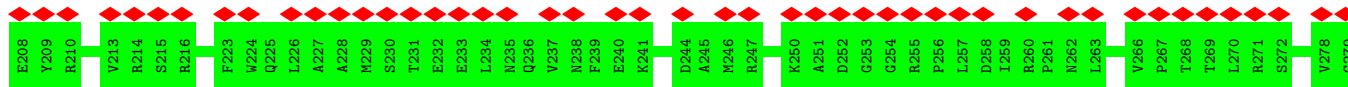
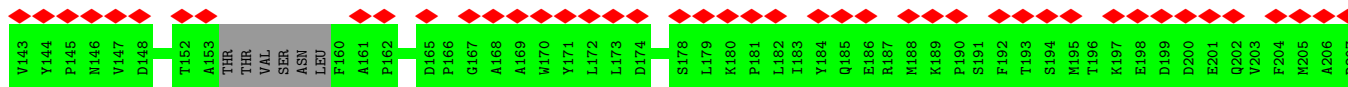
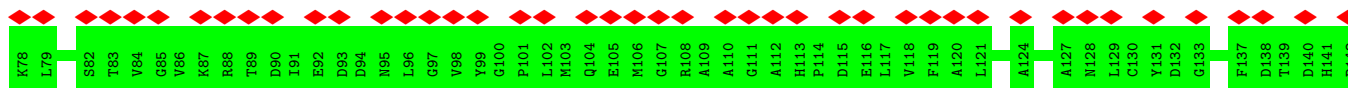
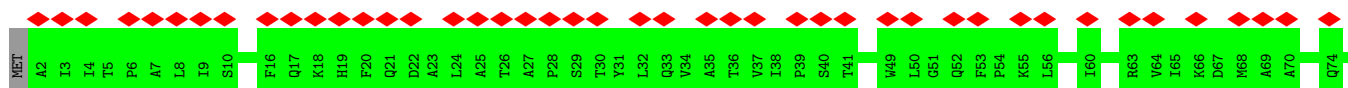

• Molecule 2: Bacteriophage Mu GpT domain-containing protein

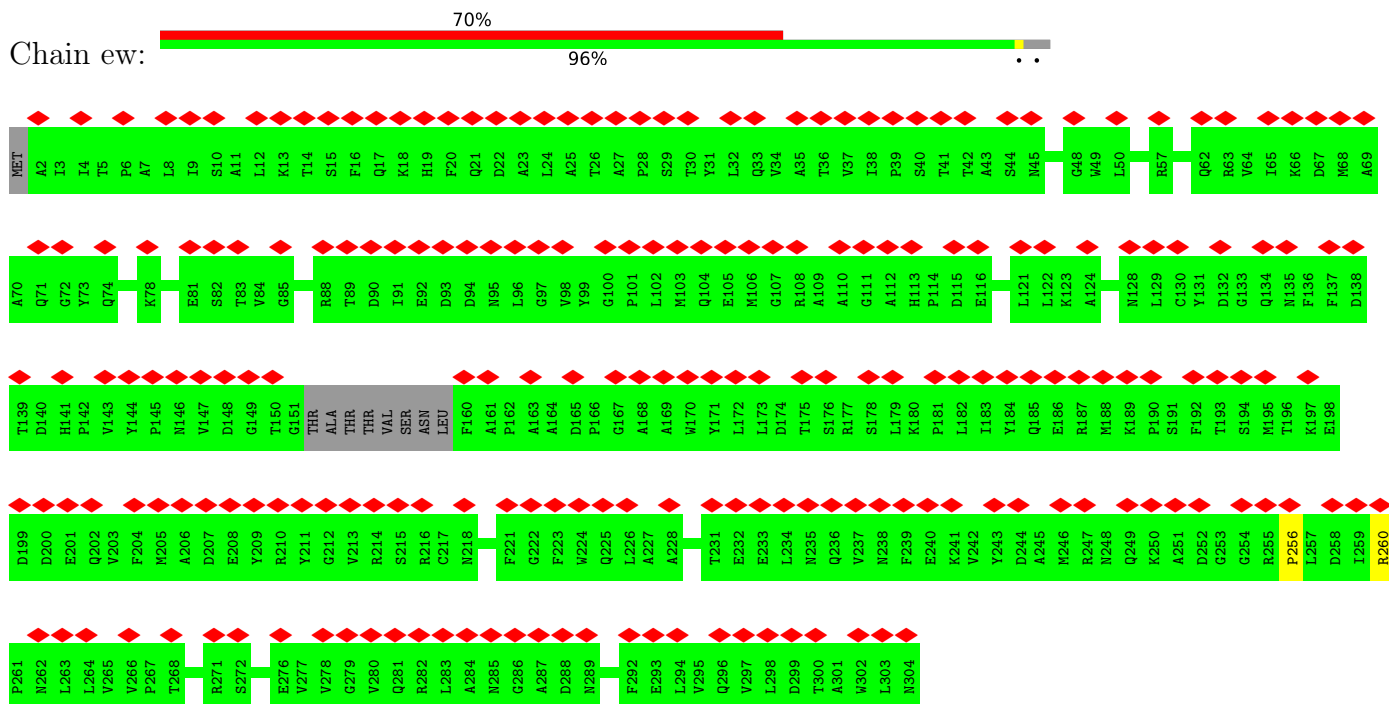

• Molecule 2: Bacteriophage Mu GpT domain-containing protein

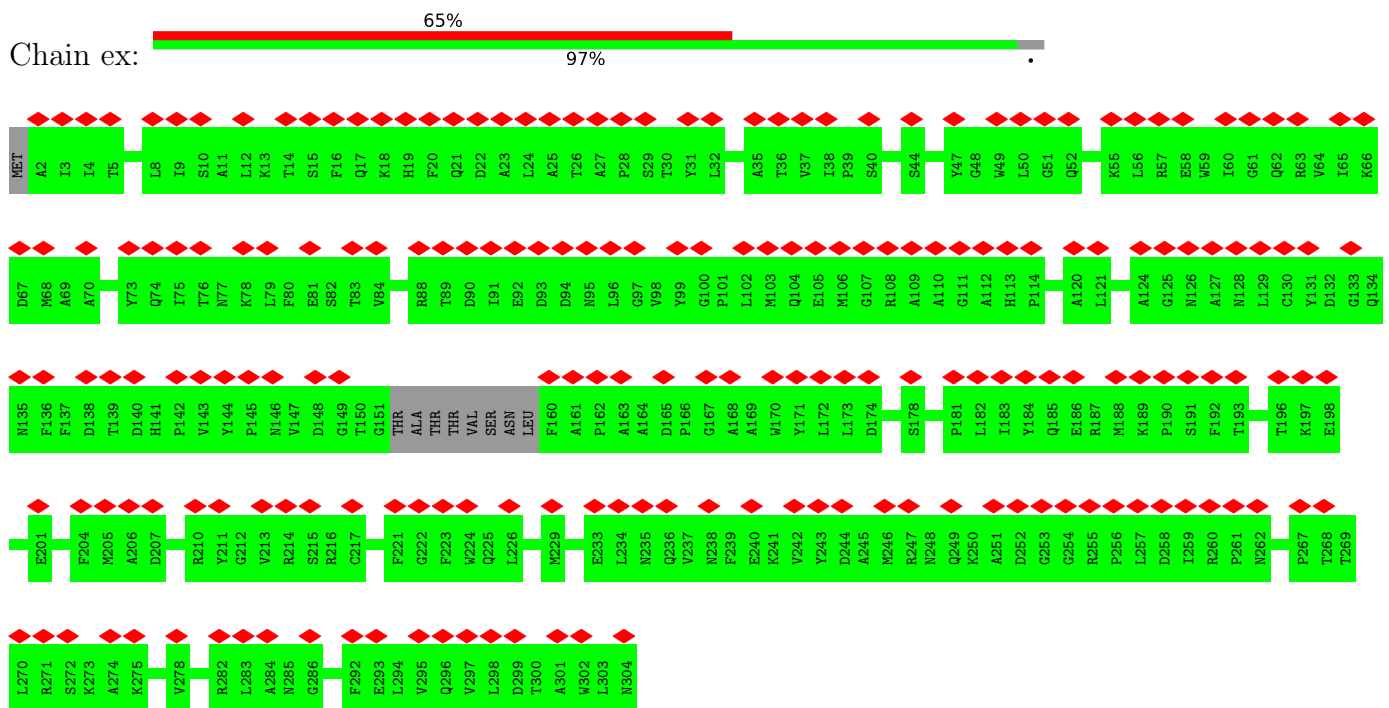

• Molecule 2: Bacteriophage Mu GpT domain-containing protein

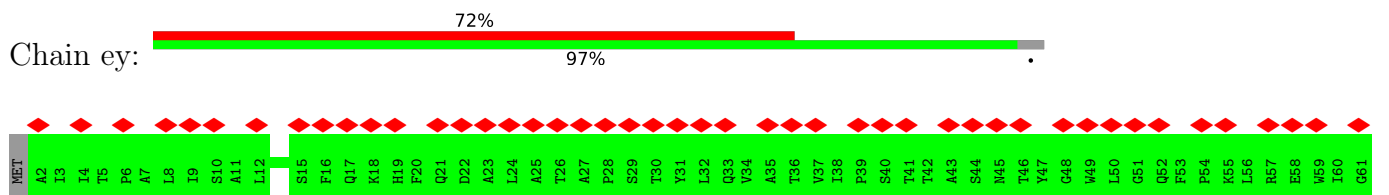

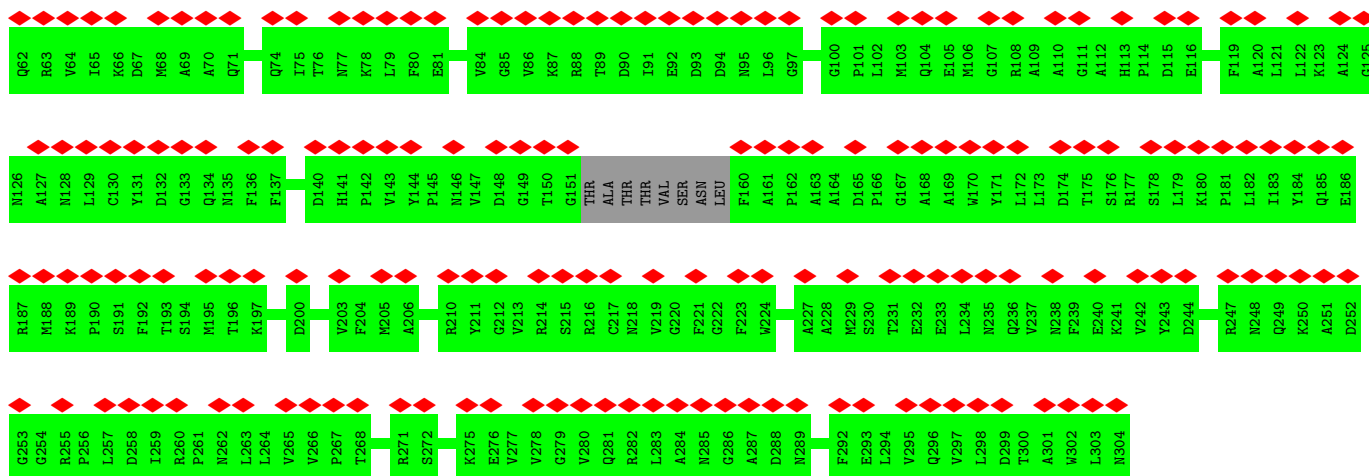

• Molecule 2: Bacteriophage Mu GpT domain-containing protein



• Molecule 2: Bacteriophage Mu GpT domain-containing protein

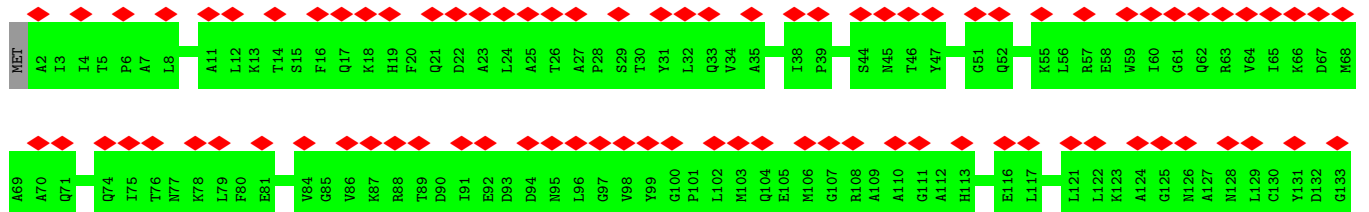

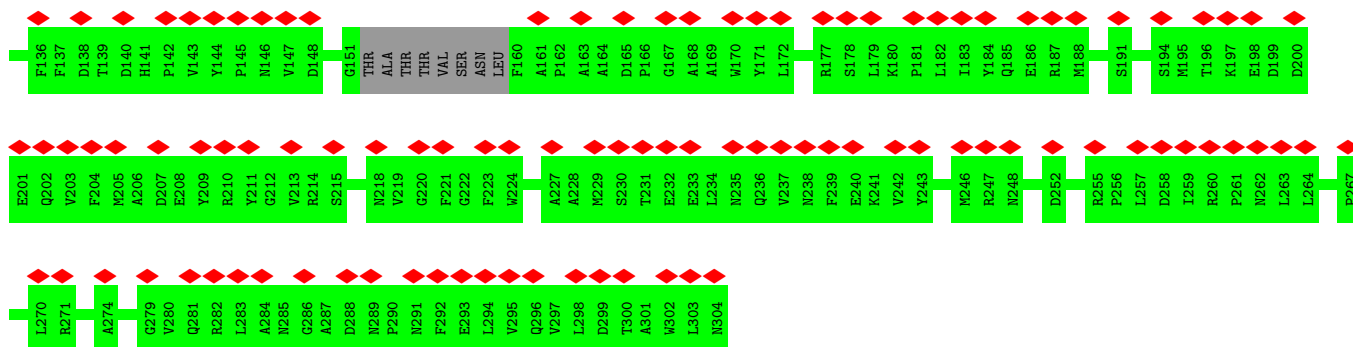

• Molecule 2: Bacteriophage Mu GpT domain-containing protein

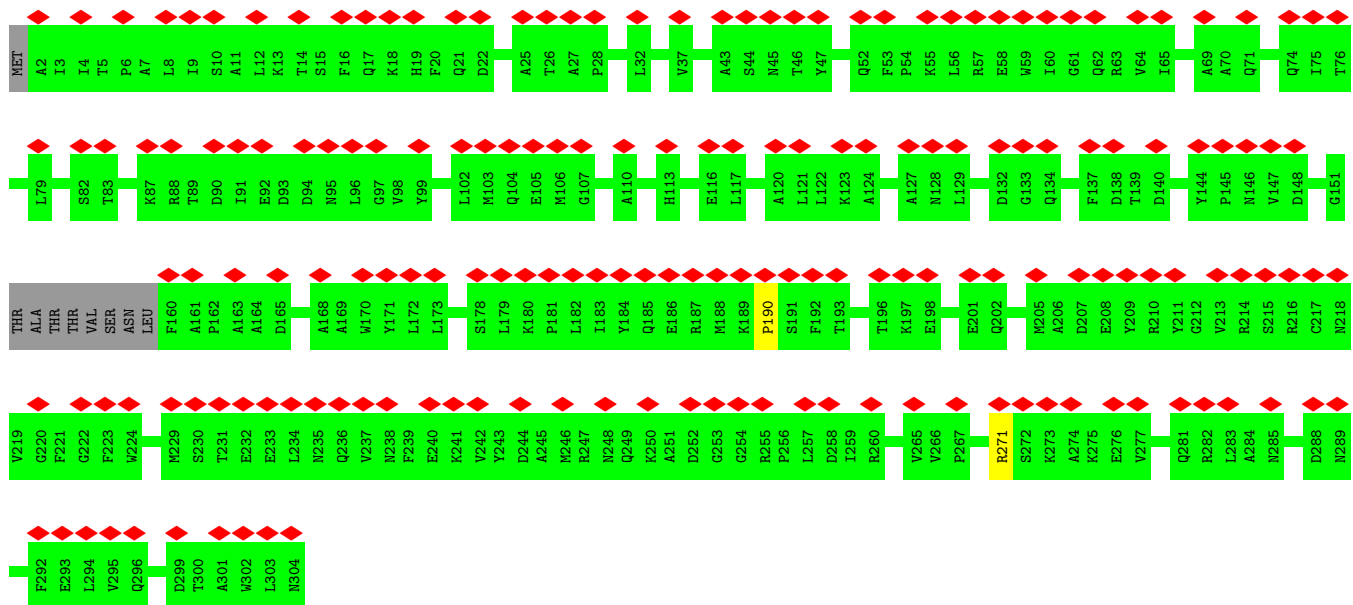

• Molecule 2: Bacteriophage Mu GpT domain-containing protein

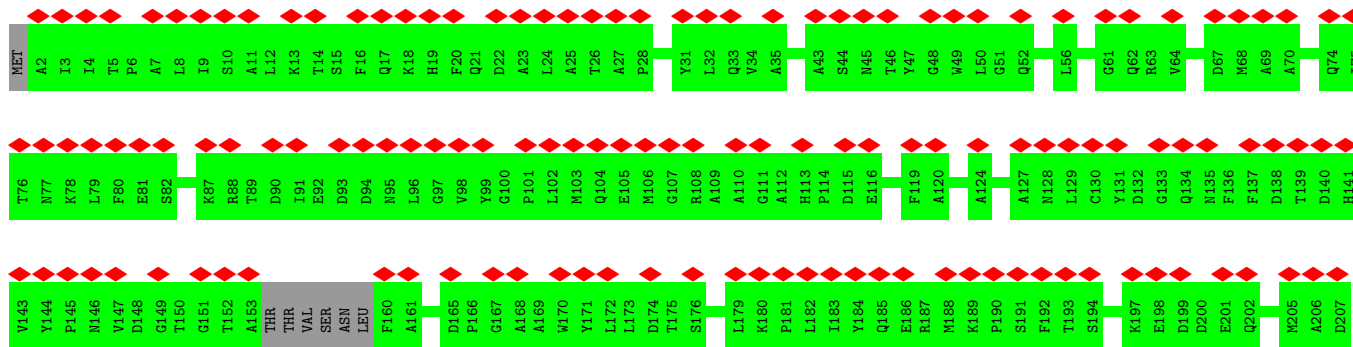

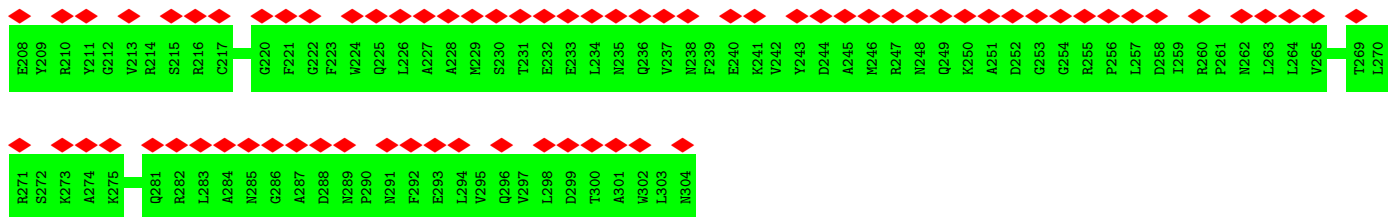

• Molecule 2: Bacteriophage Mu GpT domain-containing protein



• Molecule 2: Bacteriophage Mu GpT domain-containing protein

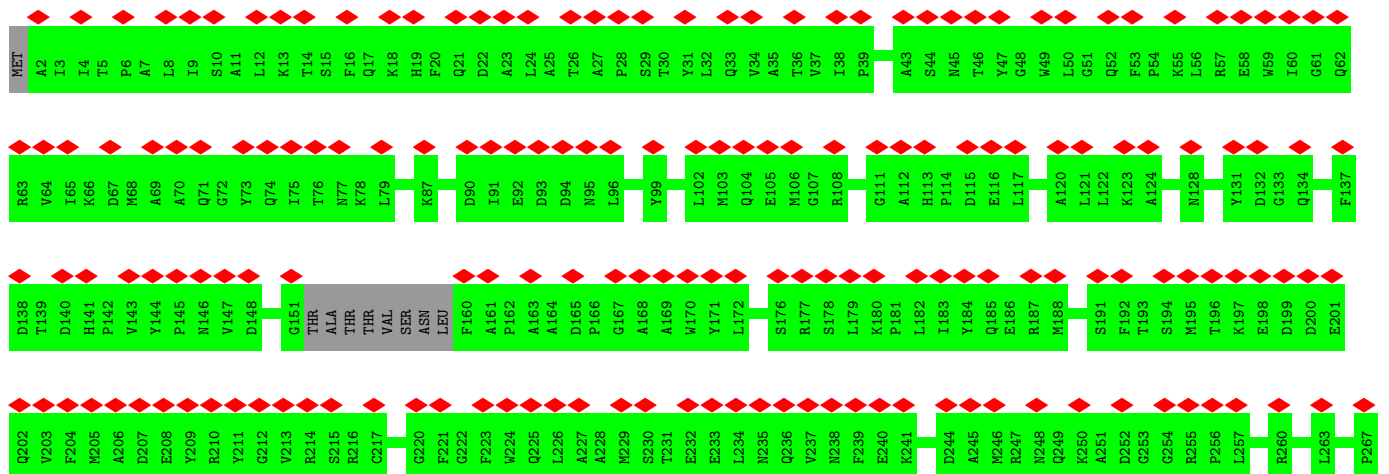

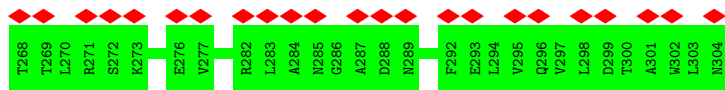

• Molecule 2: Bacteriophage Mu GpT domain-containing protein



• Molecule 2: Bacteriophage Mu GpT domain-containing protein



• Molecule 2: Bacteriophage Mu GpT domain-containing protein

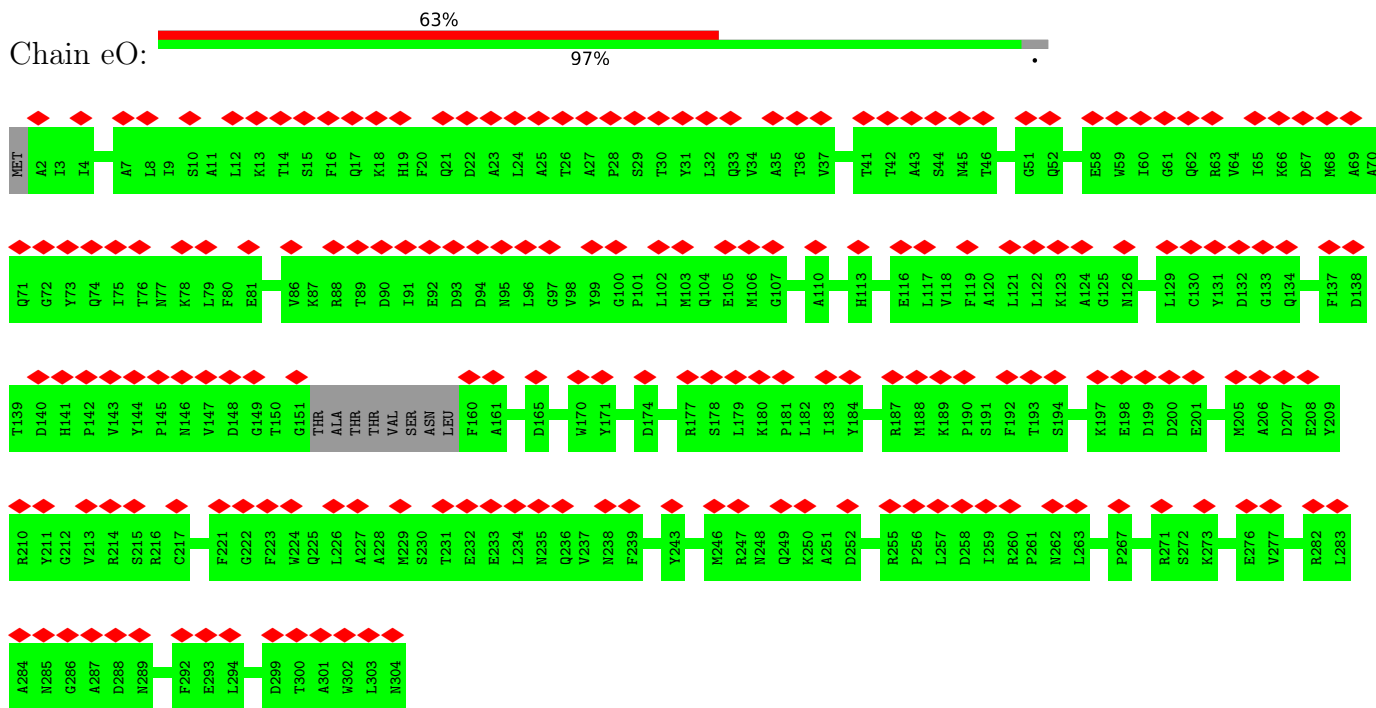

• Molecule 2: Bacteriophage Mu GpT domain-containing protein

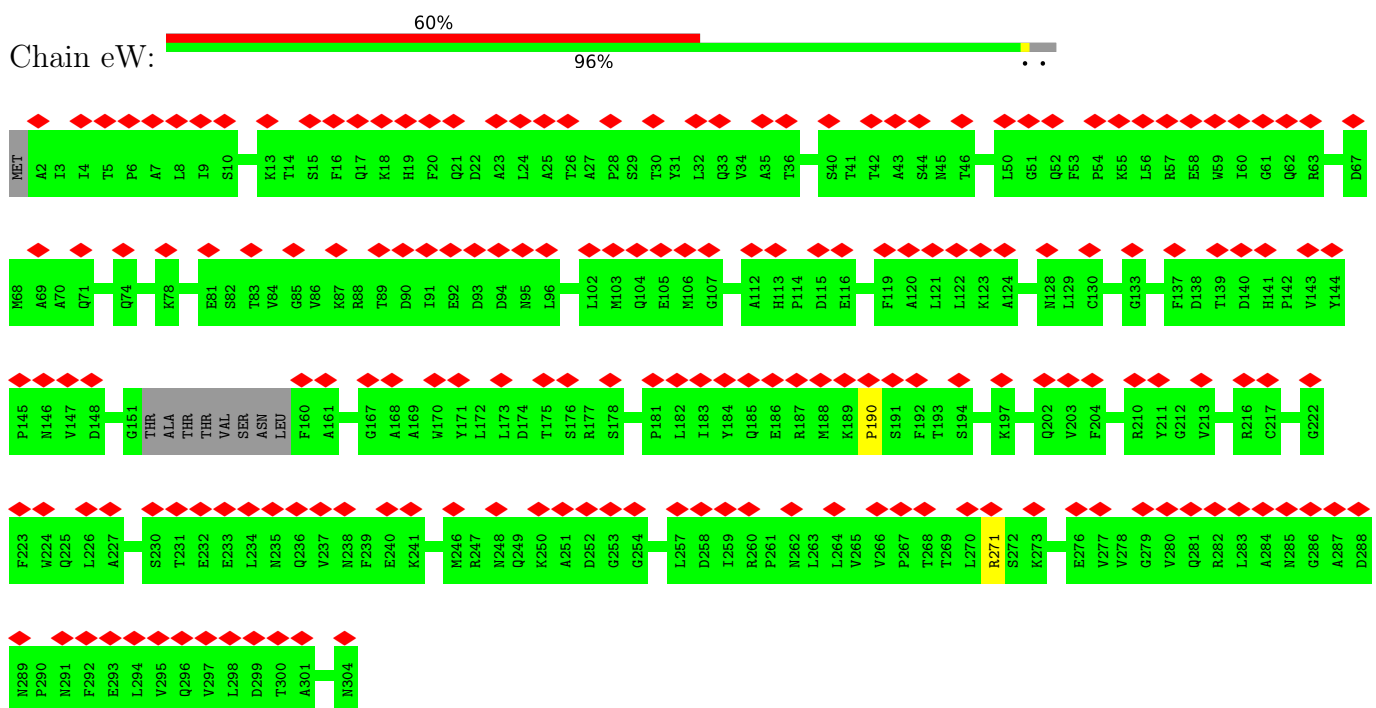

• Molecule 2: Bacteriophage Mu GpT domain-containing protein

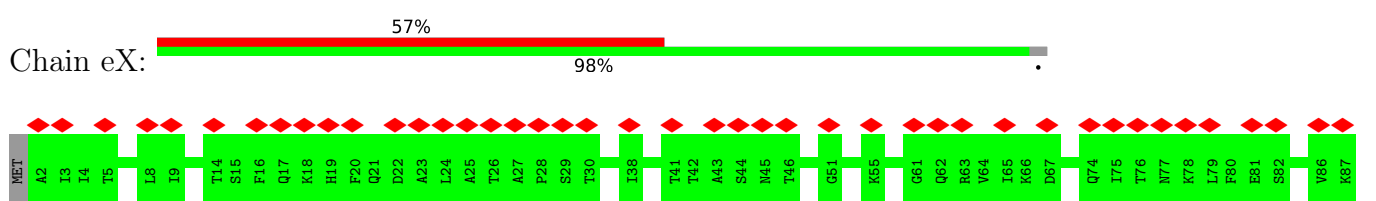

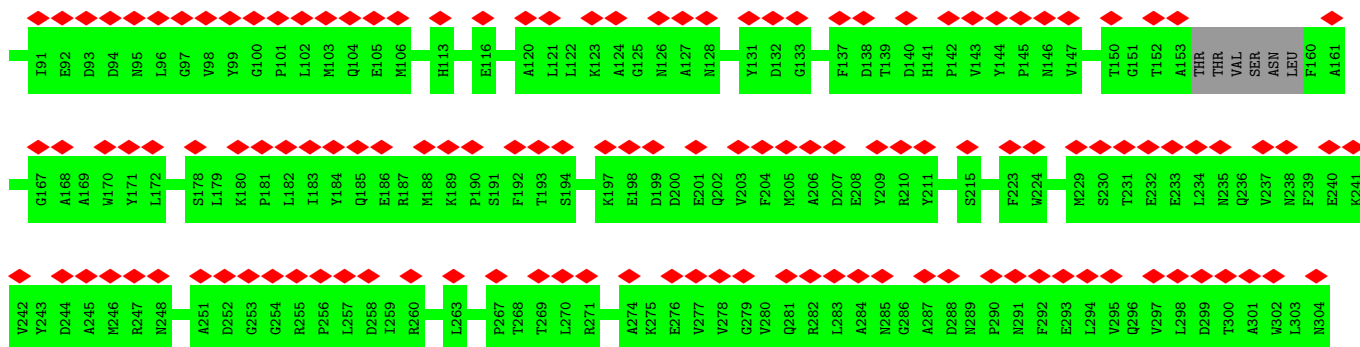

• Molecule 2: Bacteriophage Mu GpT domain-containing protein



Chain eY:

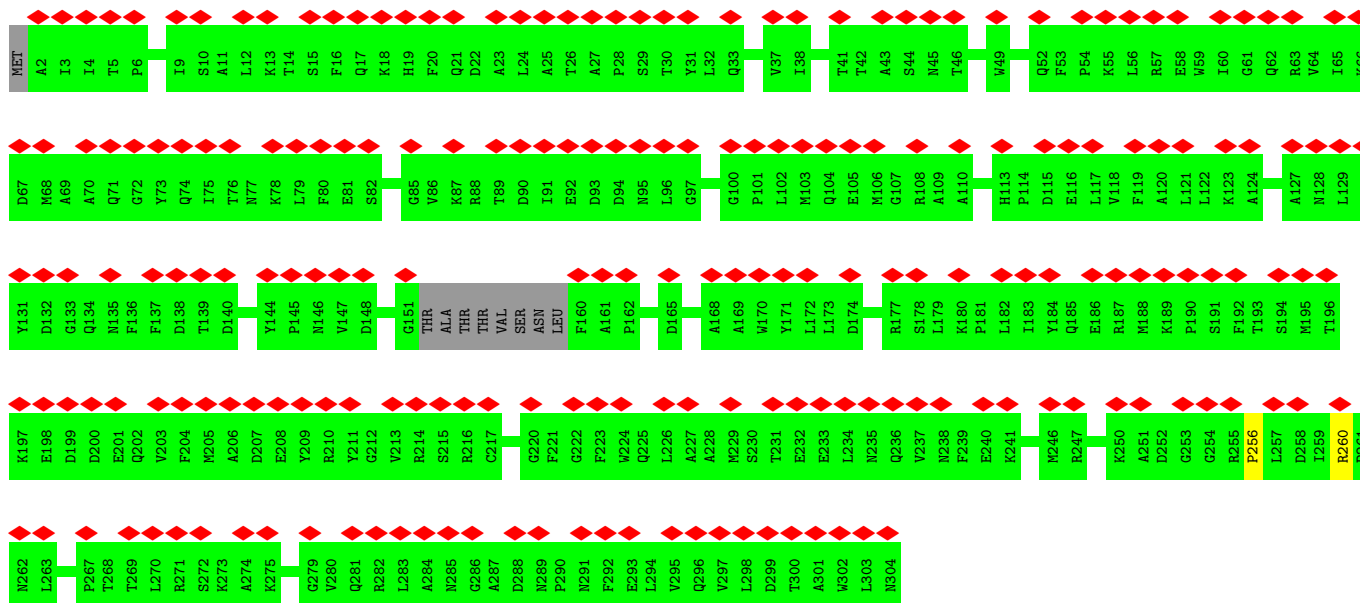

• Molecule 2: Bacteriophage Mu GpT domain-containing protein



Chain eZ:

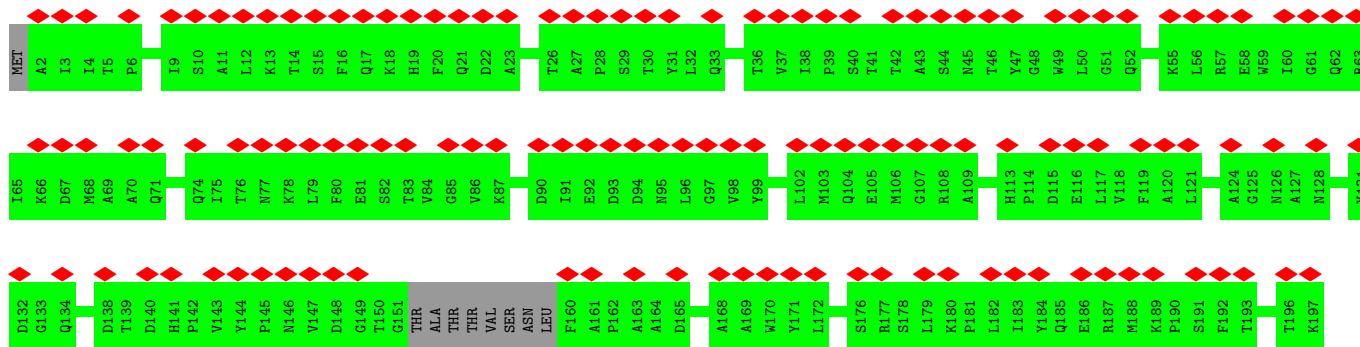

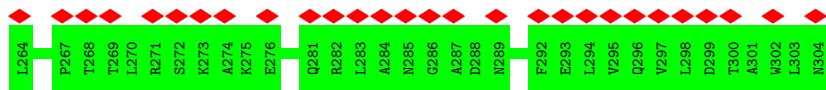

• Molecule 2: Bacteriophage Mu GpT domain-containing protein



• Molecule 2: Bacteriophage Mu GpT domain-containing protein

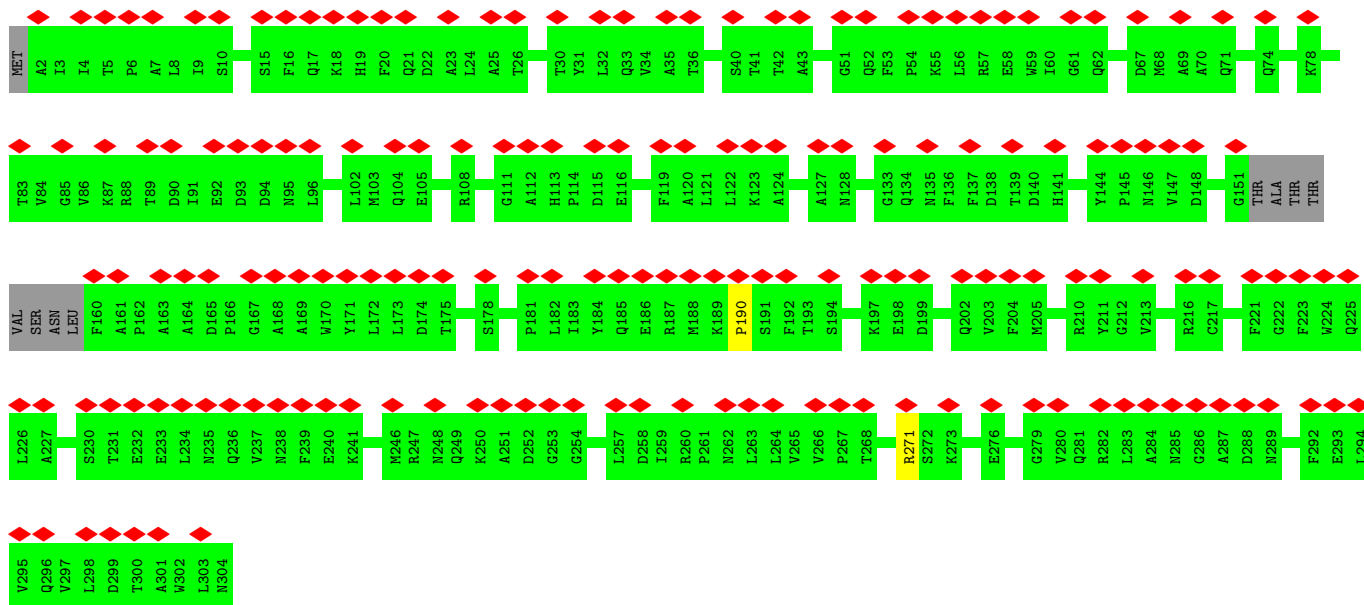

• Molecule 2: Bacteriophage Mu GpT domain-containing protein

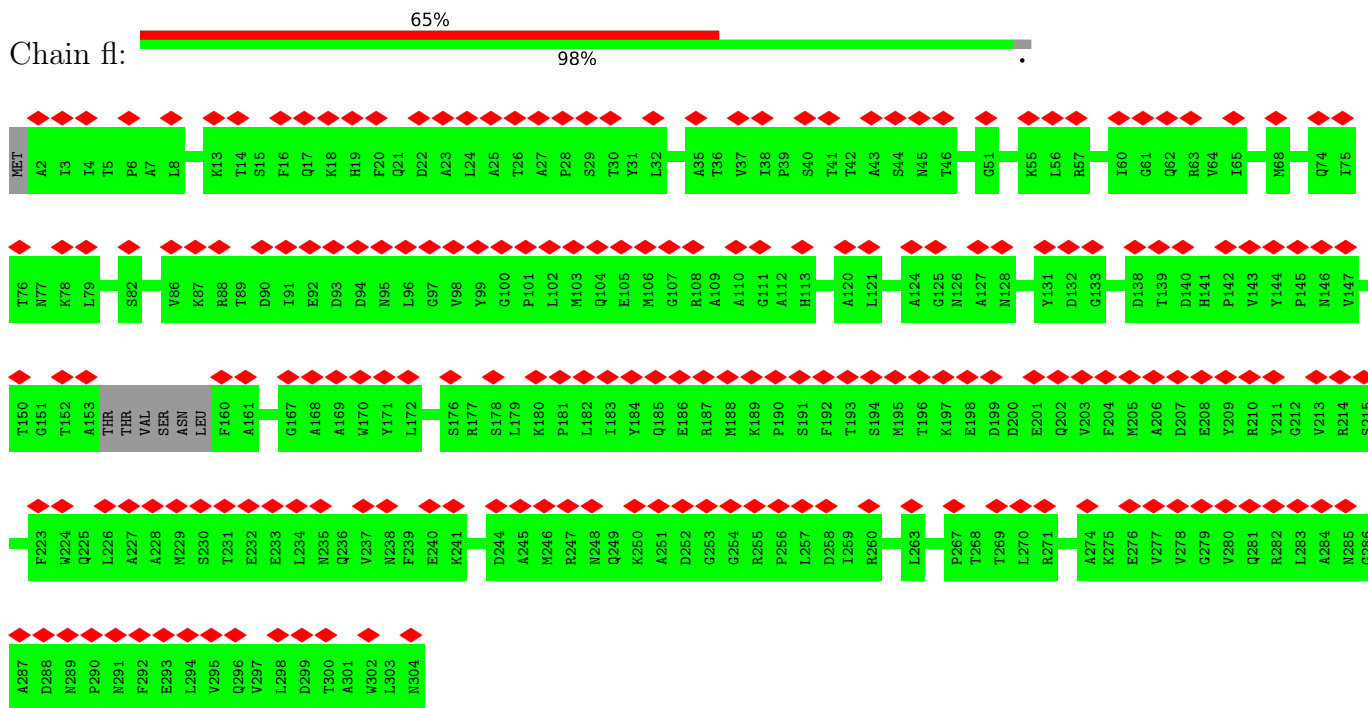

• Molecule 2: Bacteriophage Mu GpT domain-containing protein

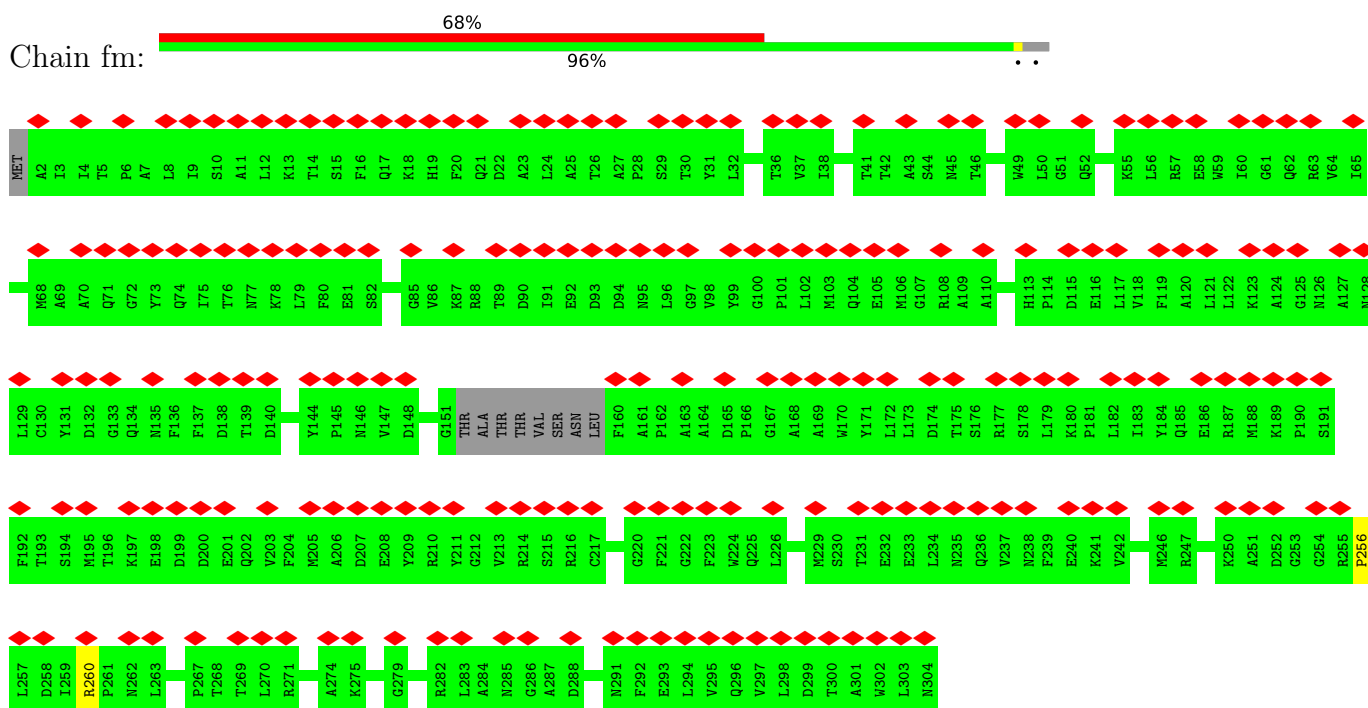

• Molecule 2: Bacteriophage Mu GpT domain-containing protein

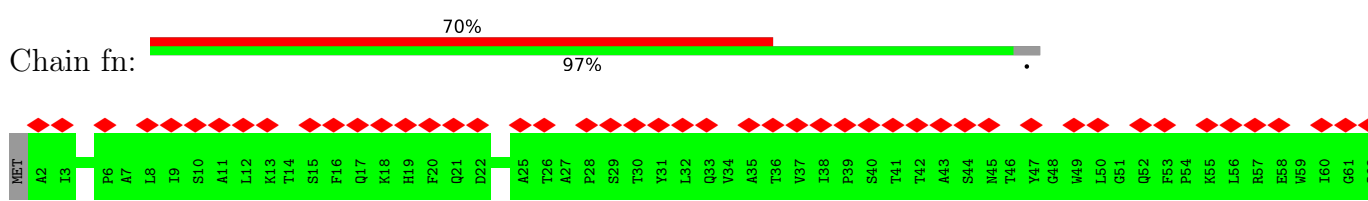

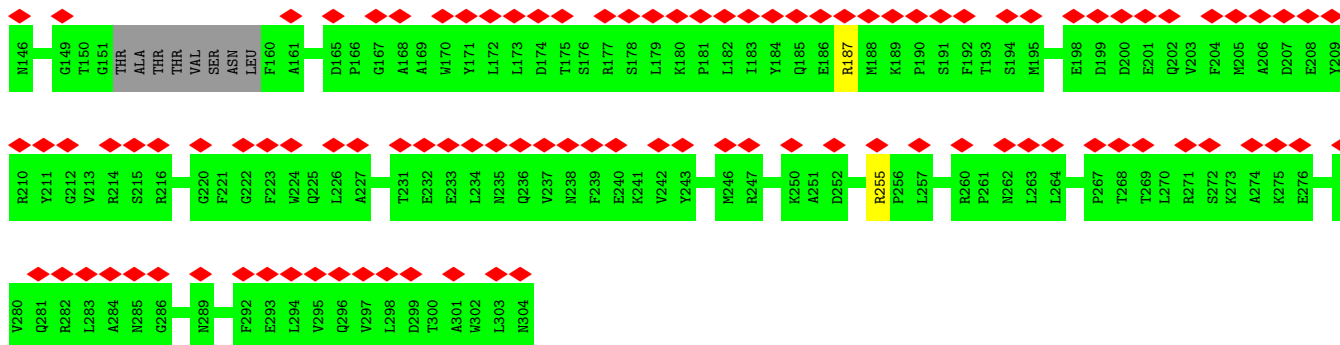

• Molecule 2: Bacteriophage Mu GpT domain-containing protein

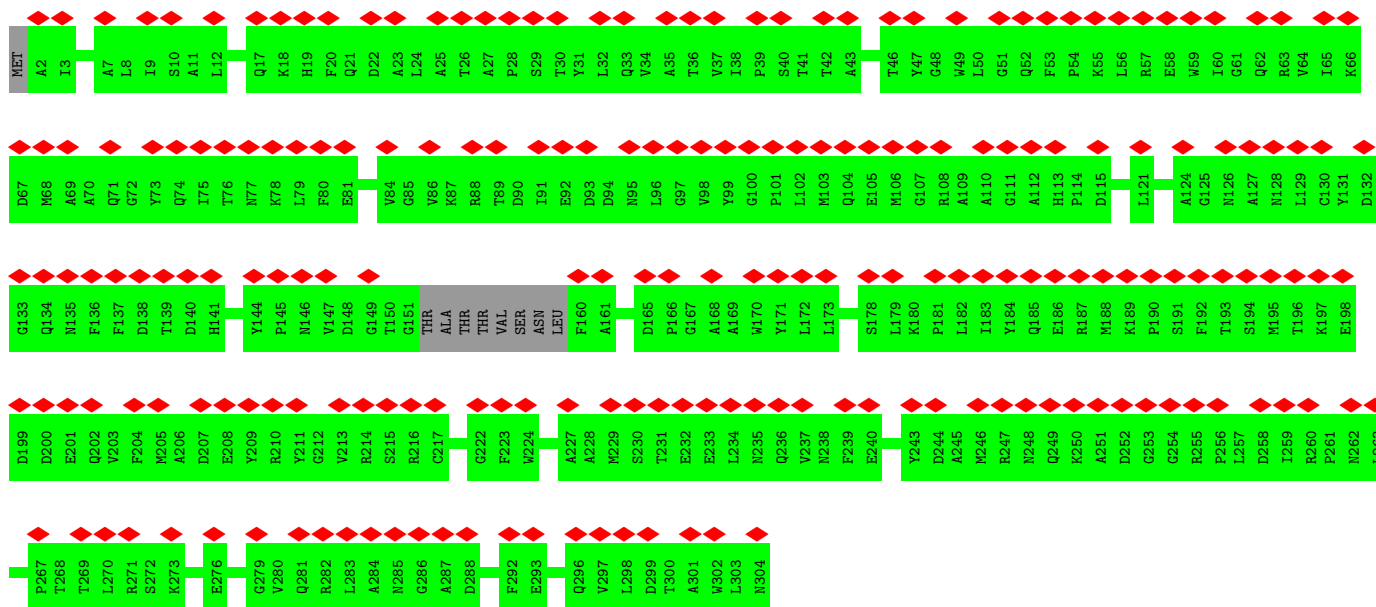

• Molecule 2: Bacteriophage Mu GpT domain-containing protein

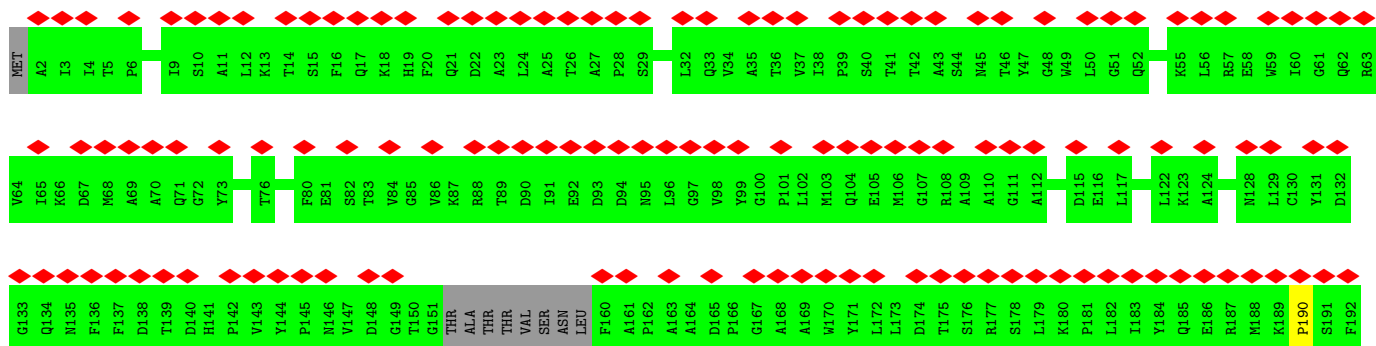

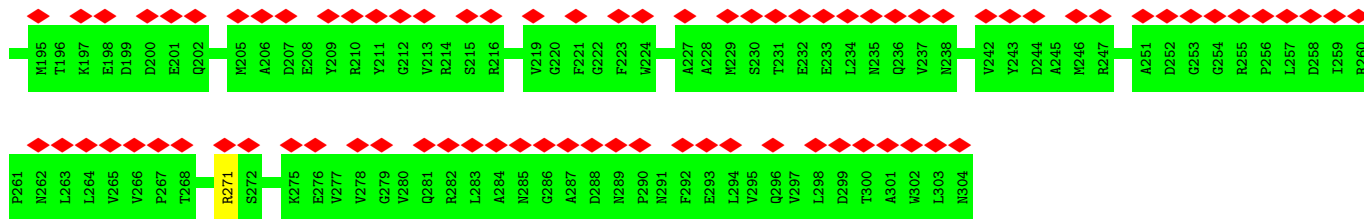

• Molecule 2: Bacteriophage Mu GpT domain-containing protein



• Molecule 2: Bacteriophage Mu GpT domain-containing protein

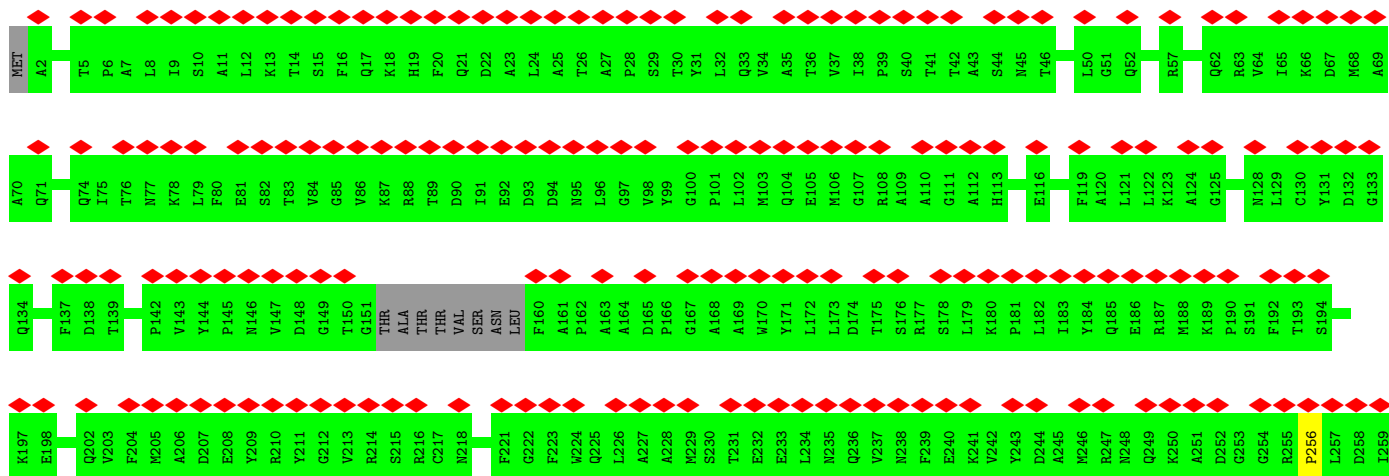

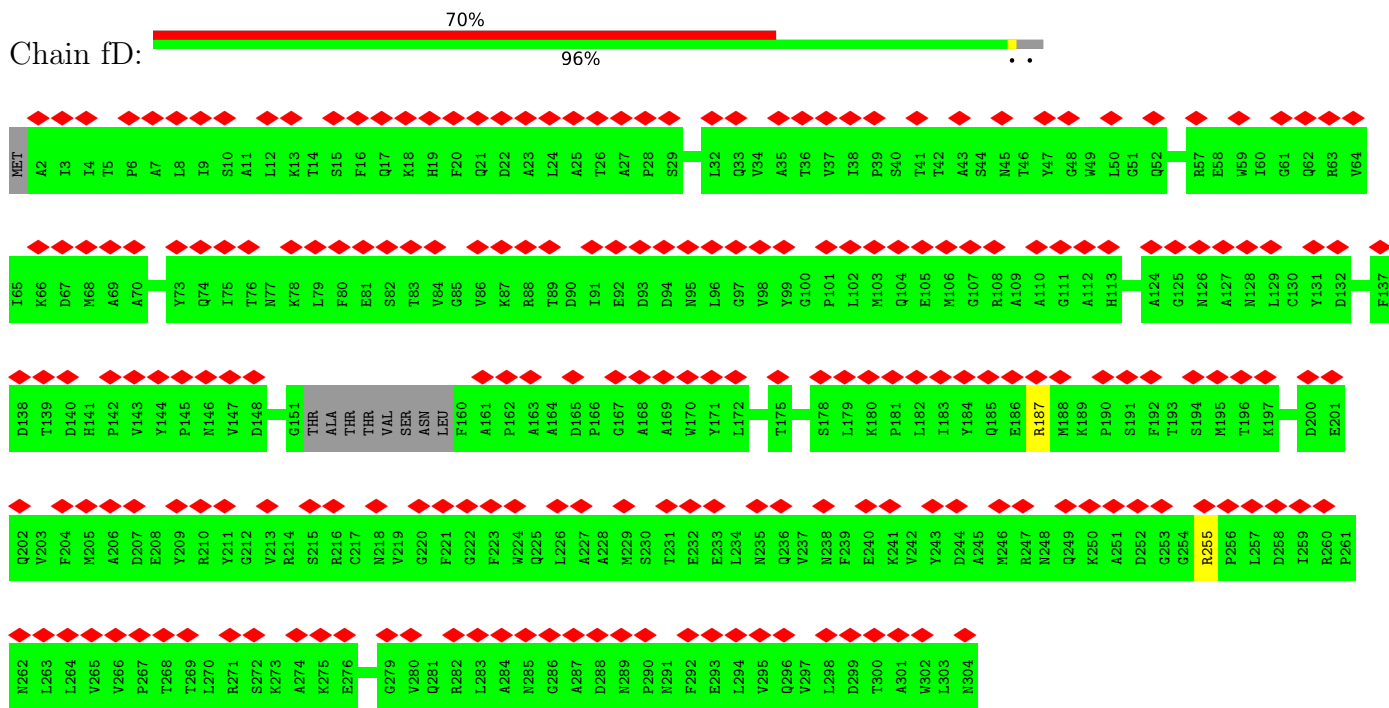

• Molecule 2: Bacteriophage Mu GpT domain-containing protein



• Molecule 2: Bacteriophage Mu GpT domain-containing protein

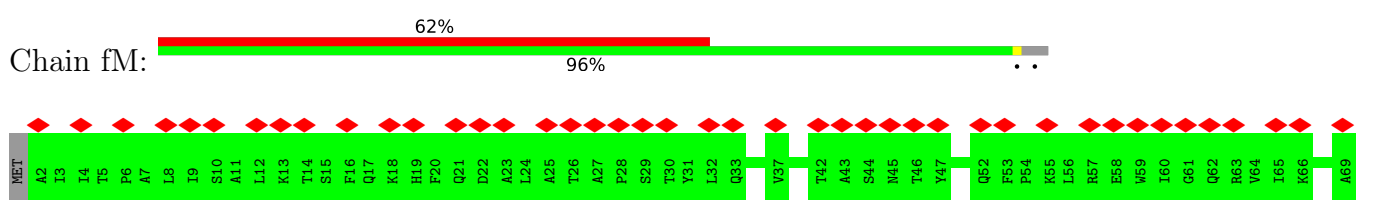

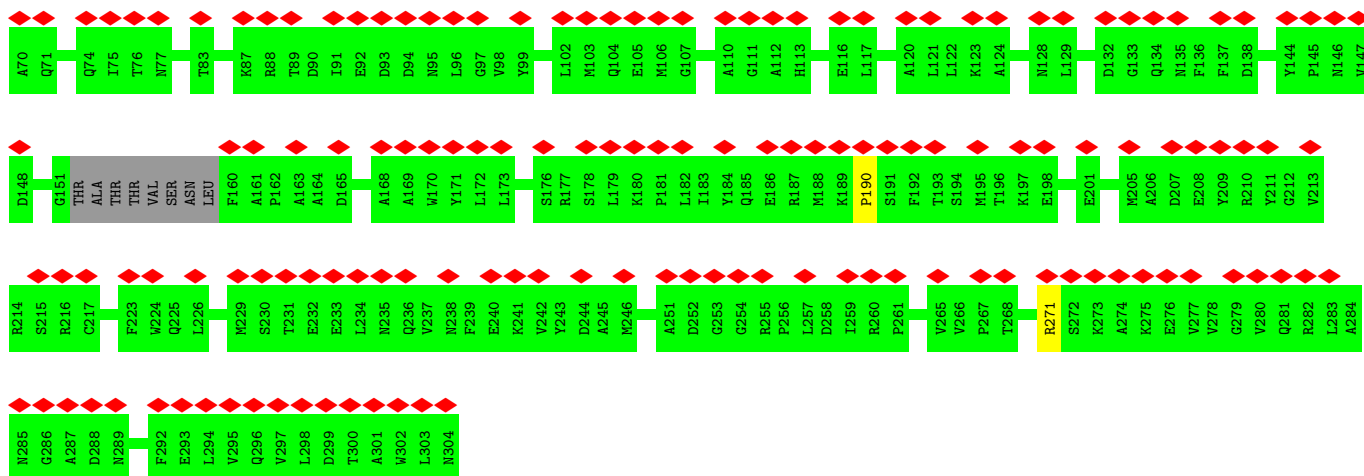

• Molecule 2: Bacteriophage Mu GpT domain-containing protein

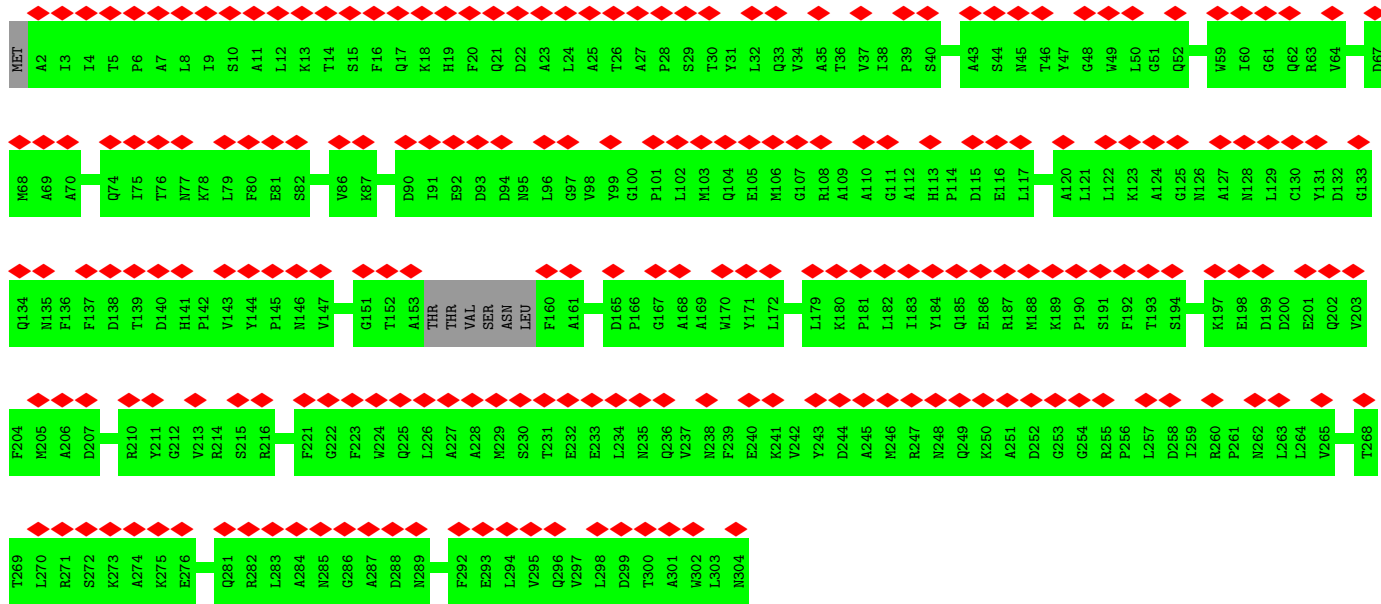

• Molecule 2: Bacteriophage Mu GpT domain-containing protein

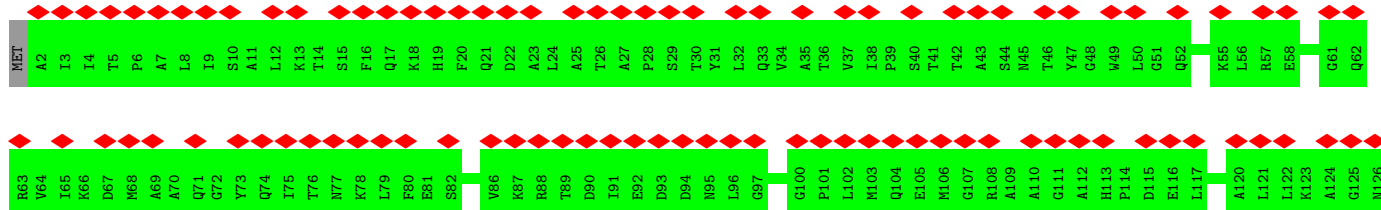

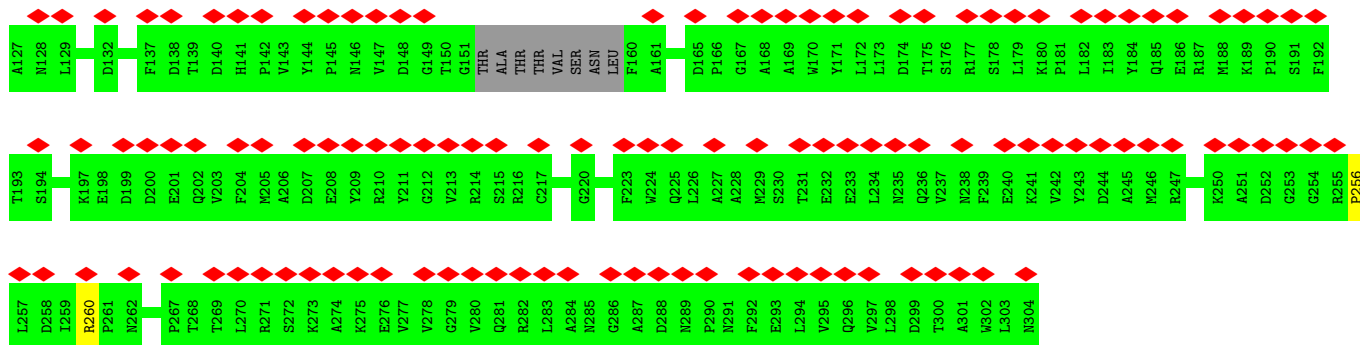

• Molecule 2: Bacteriophage Mu GpT domain-containing protein

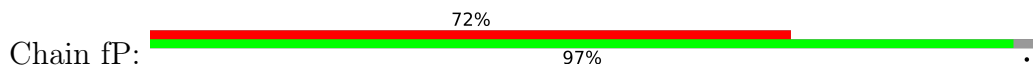

• Molecule 2: Bacteriophage Mu GpT domain-containing protein

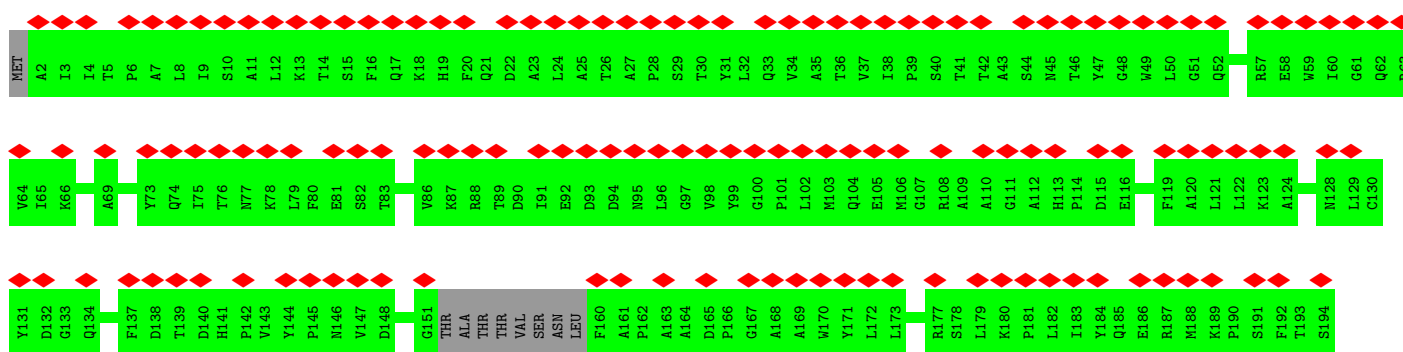
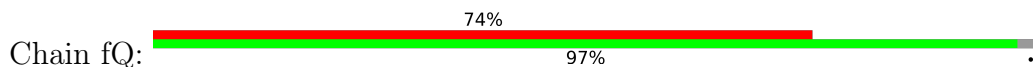

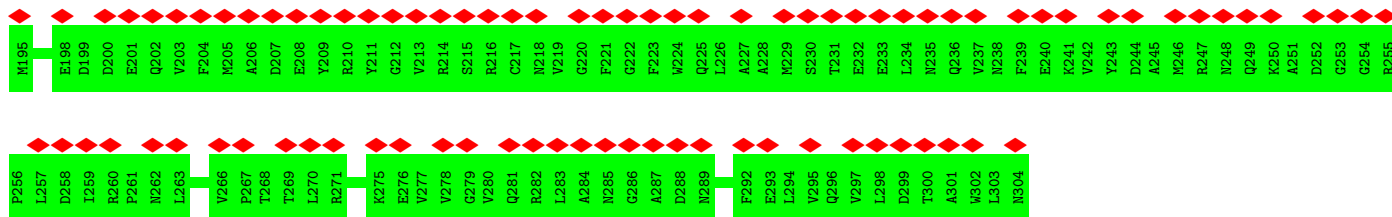

• Molecule 2: Bacteriophage Mu GpT domain-containing protein

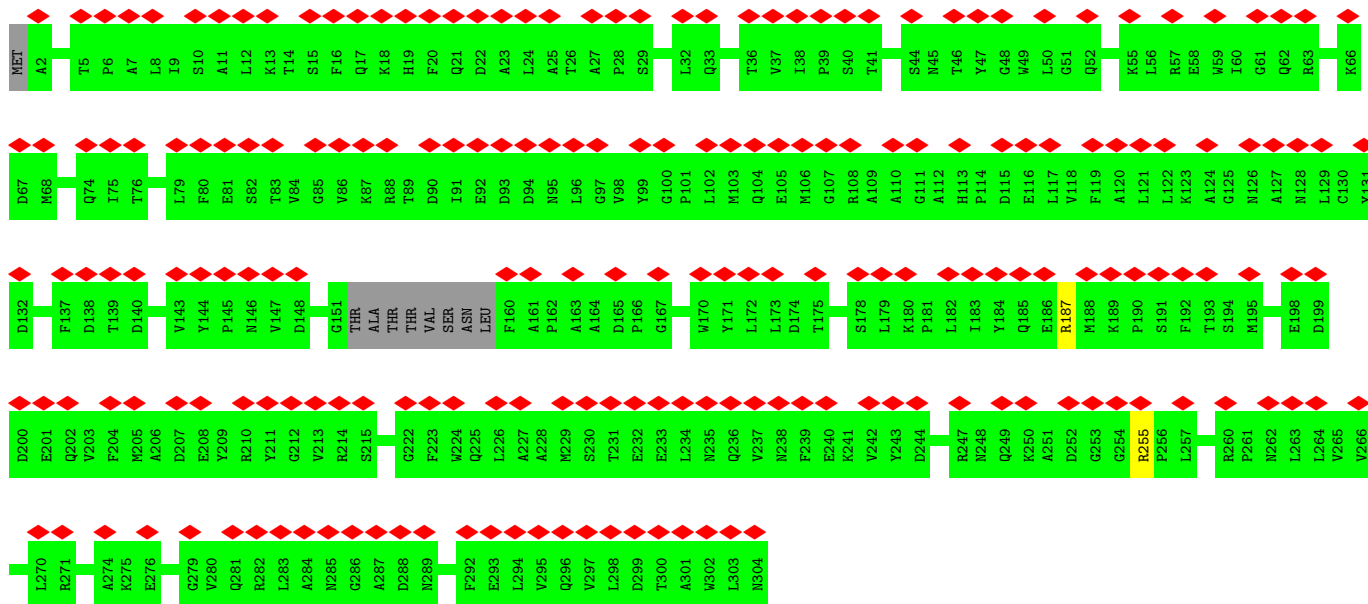

• Molecule 2: Bacteriophage Mu GpT domain-containing protein

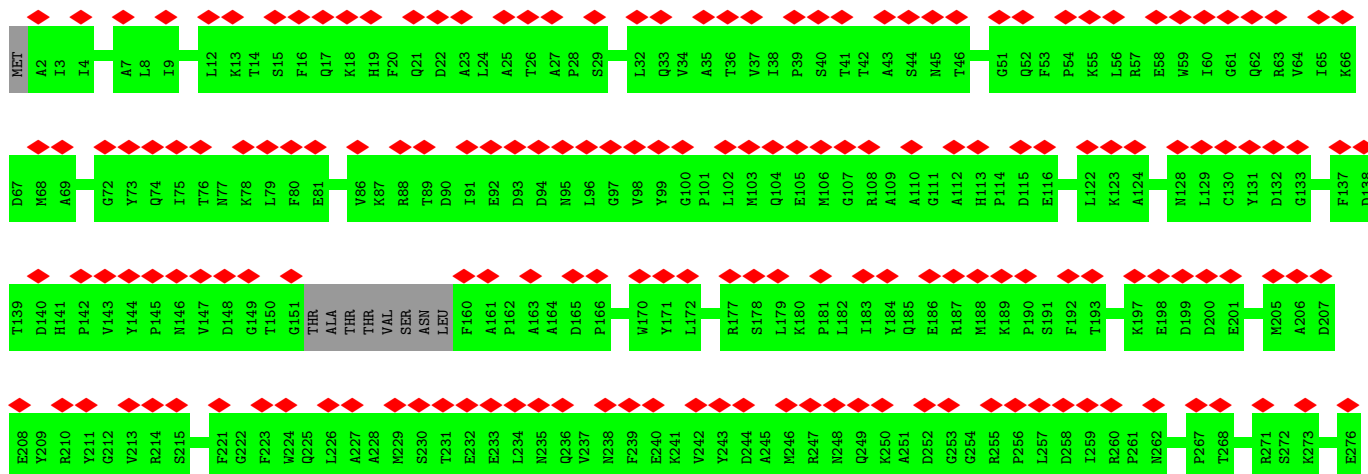

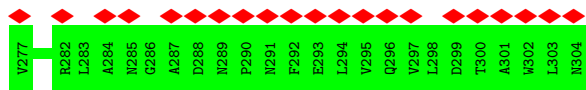

• Molecule 2: Bacteriophage Mu GpT domain-containing protein

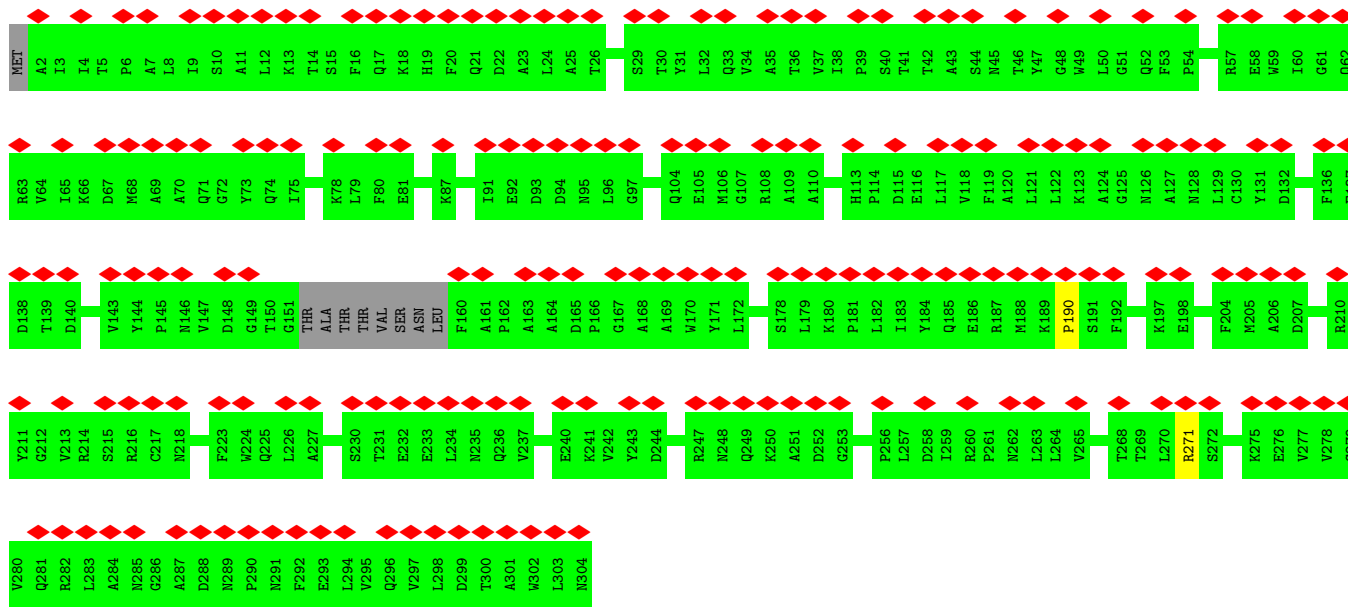

• Molecule 2: Bacteriophage Mu GpT domain-containing protein



• Molecule 2: Bacteriophage Mu GpT domain-containing protein

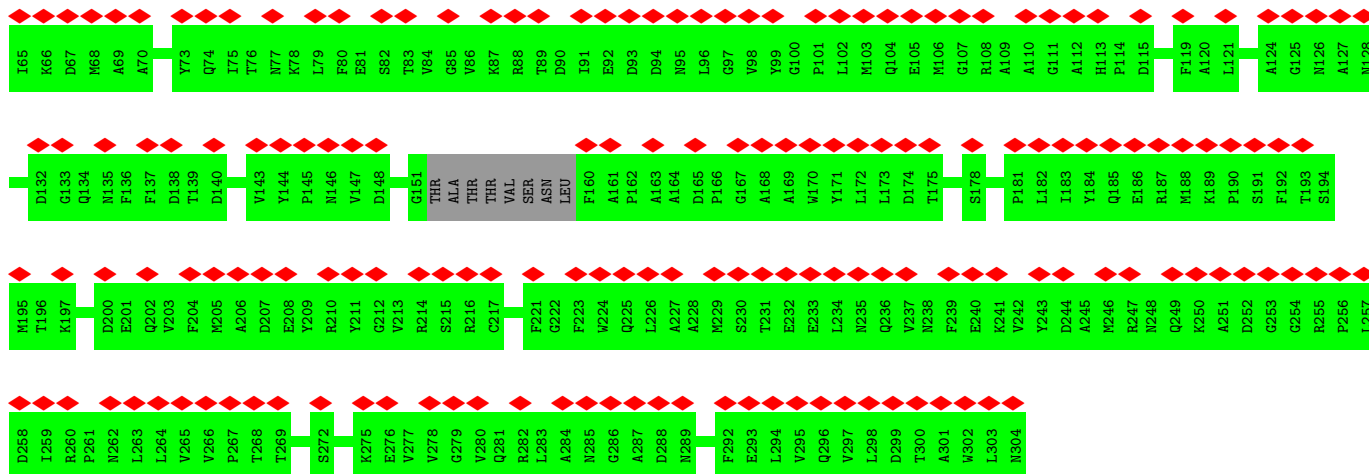

• Molecule 2: Bacteriophage Mu GpT domain-containing protein



• Molecule 2: Bacteriophage Mu GpT domain-containing protein

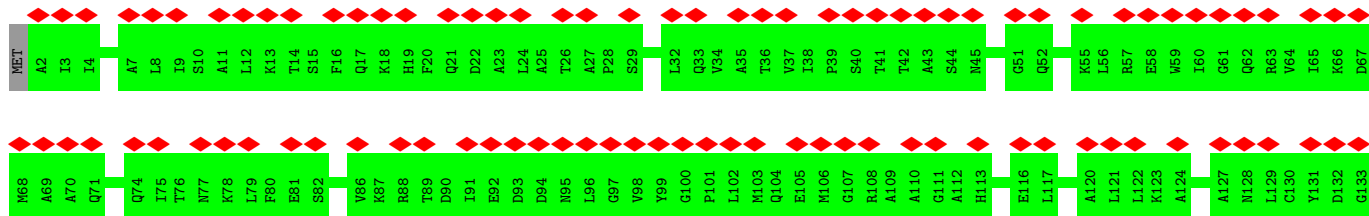

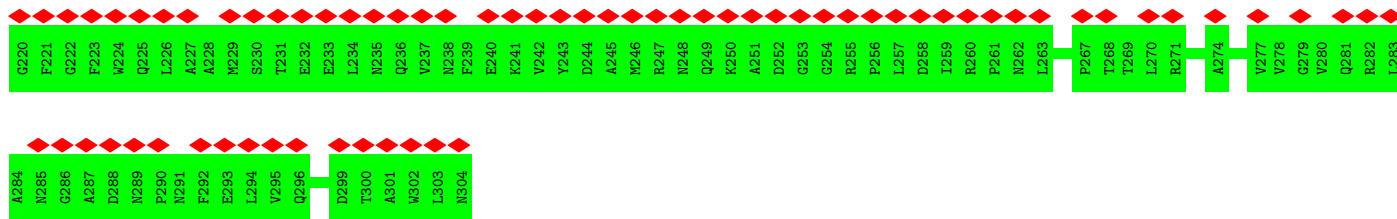

• Molecule 2: Bacteriophage Mu GpT domain-containing protein

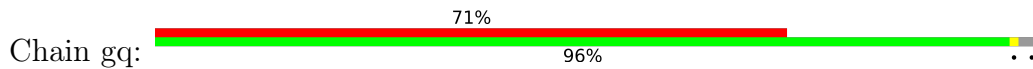

• Molecule 2: Bacteriophage Mu GpT domain-containing protein

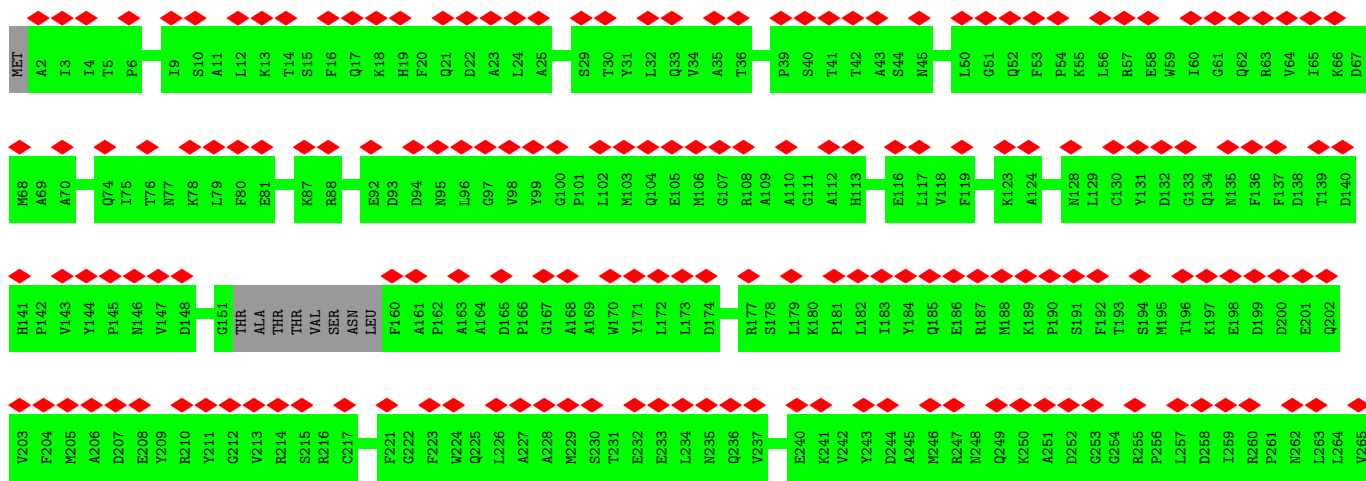

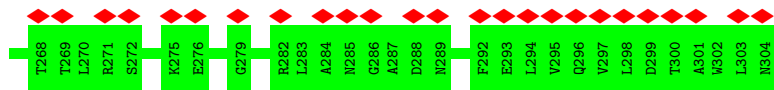

• Molecule 2: Bacteriophage Mu GpT domain-containing protein

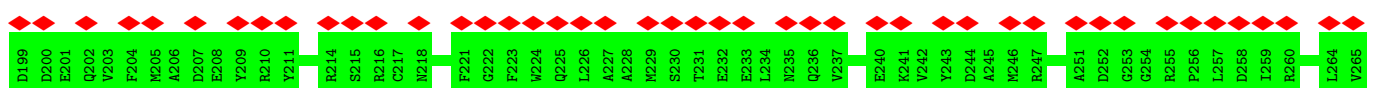
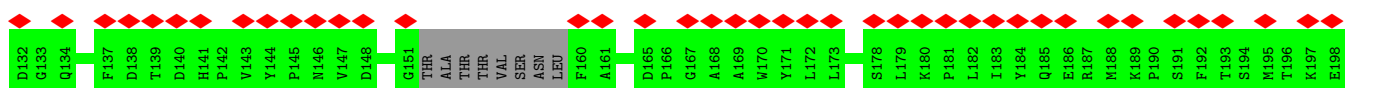
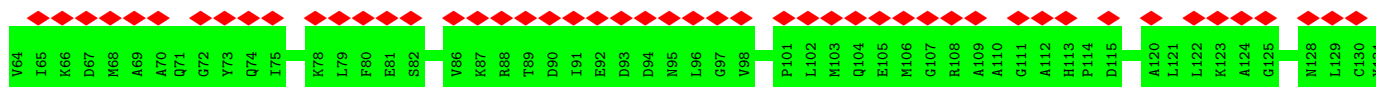
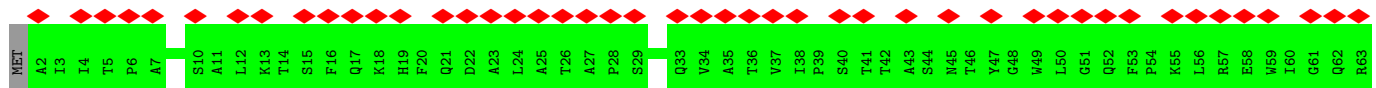

• Molecule 2: Bacteriophage Mu GpT domain-containing protein

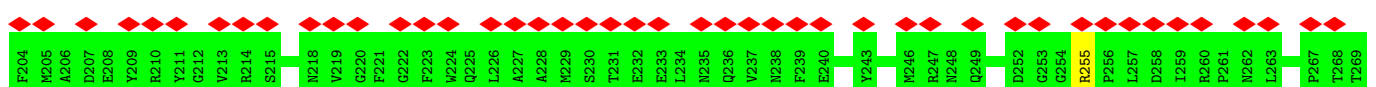
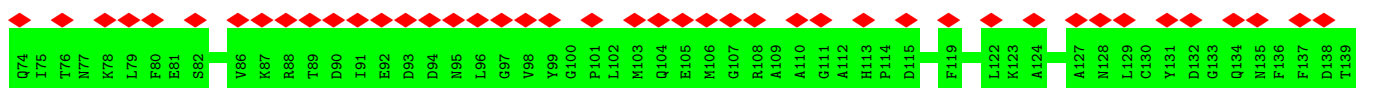
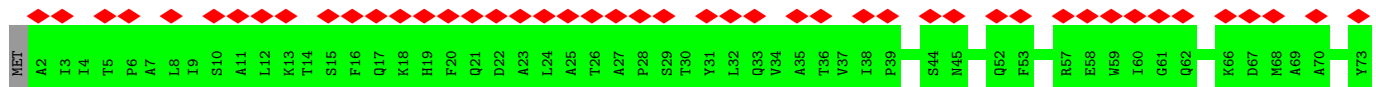

• Molecule 2: Bacteriophage Mu GpT domain-containing protein

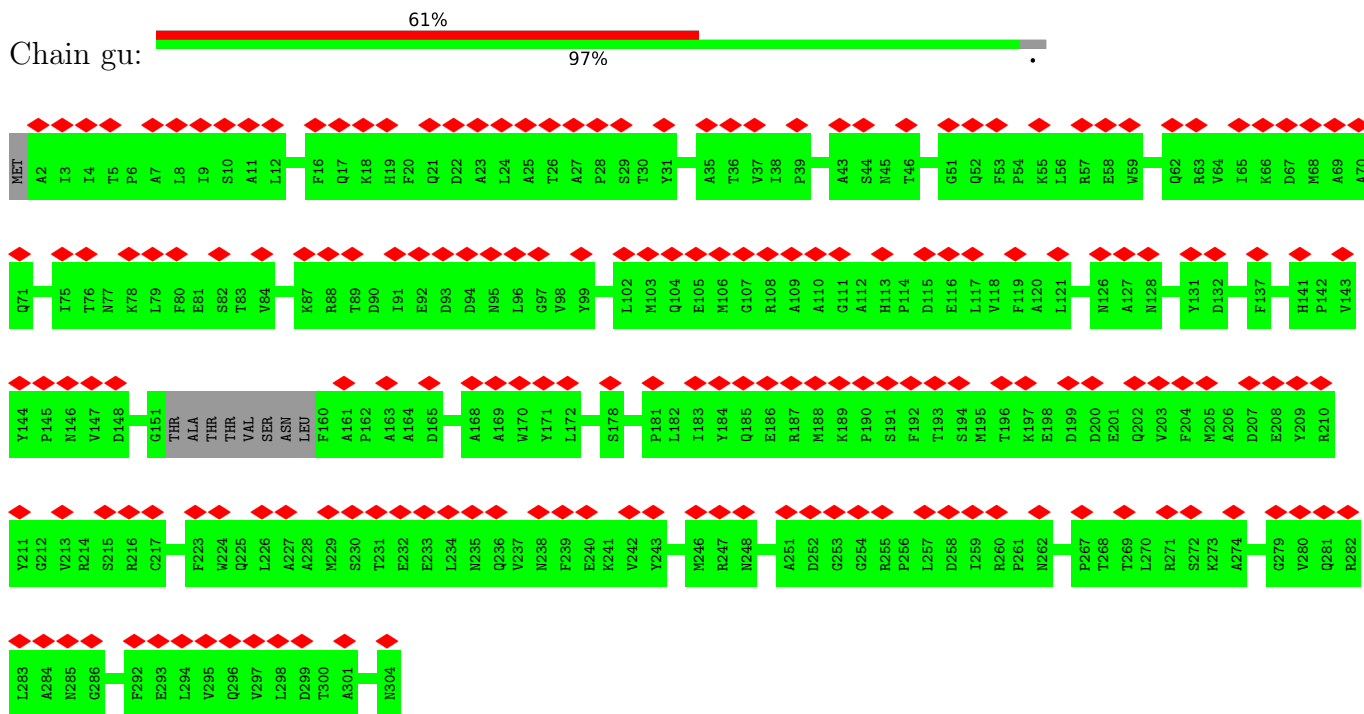

• Molecule 2: Bacteriophage Mu GpT domain-containing protein

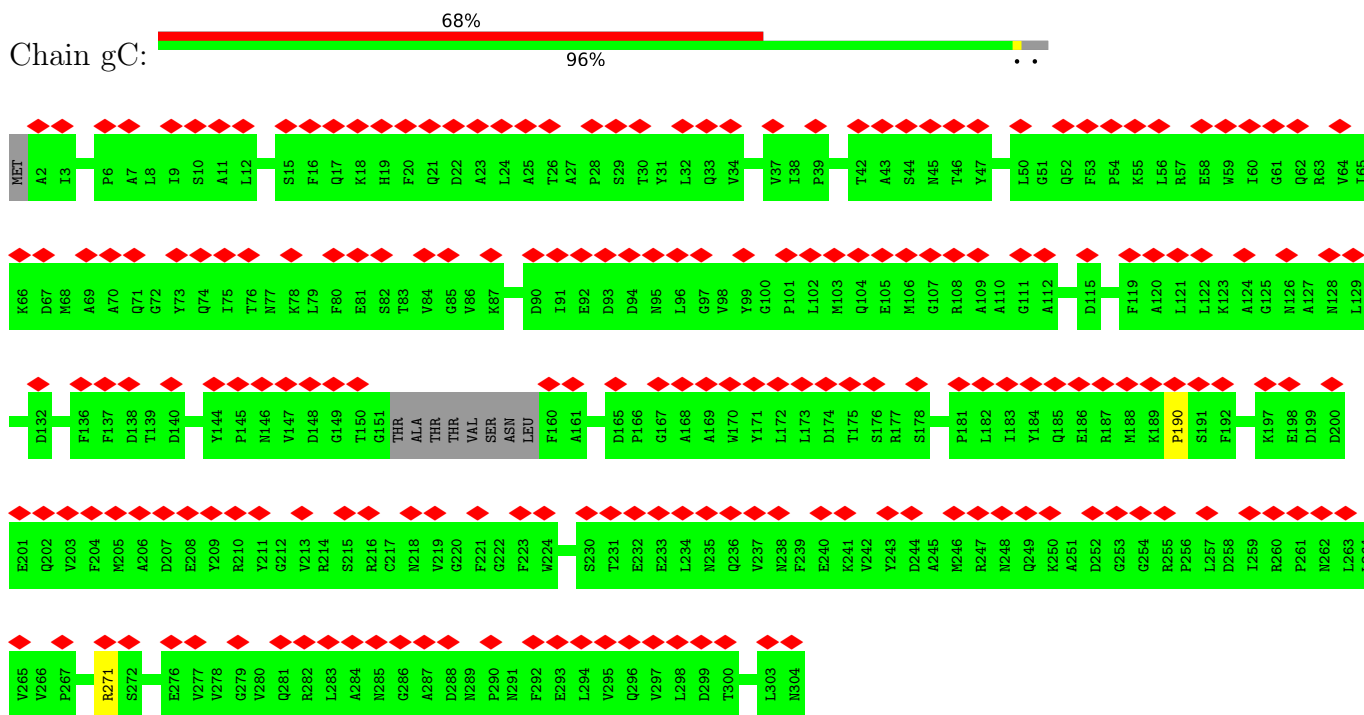

• Molecule 2: Bacteriophage Mu GpT domain-containing protein

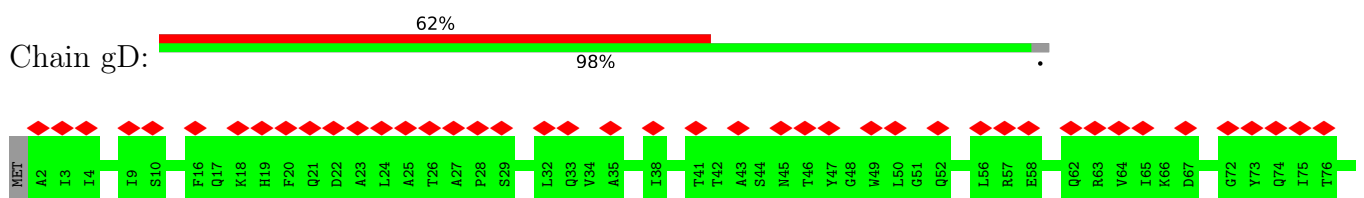

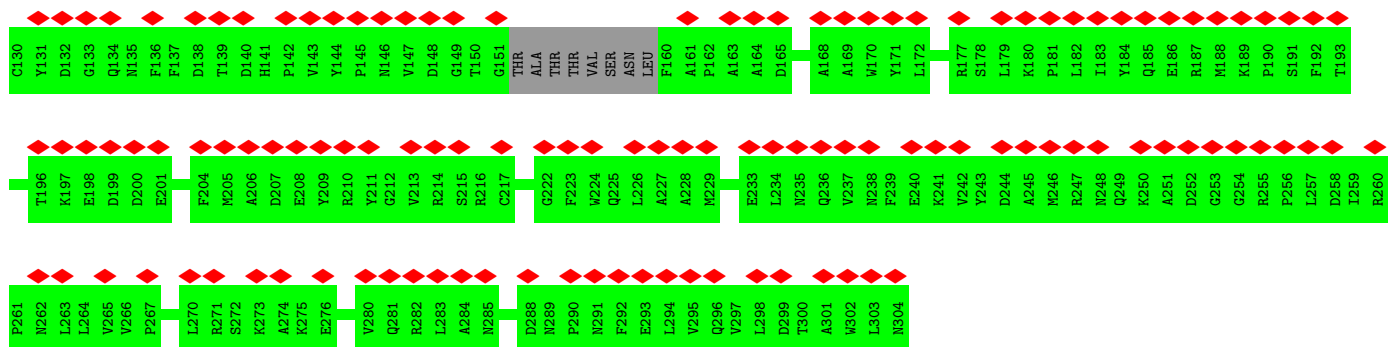

• Molecule 2: Bacteriophage Mu GpT domain-containing protein

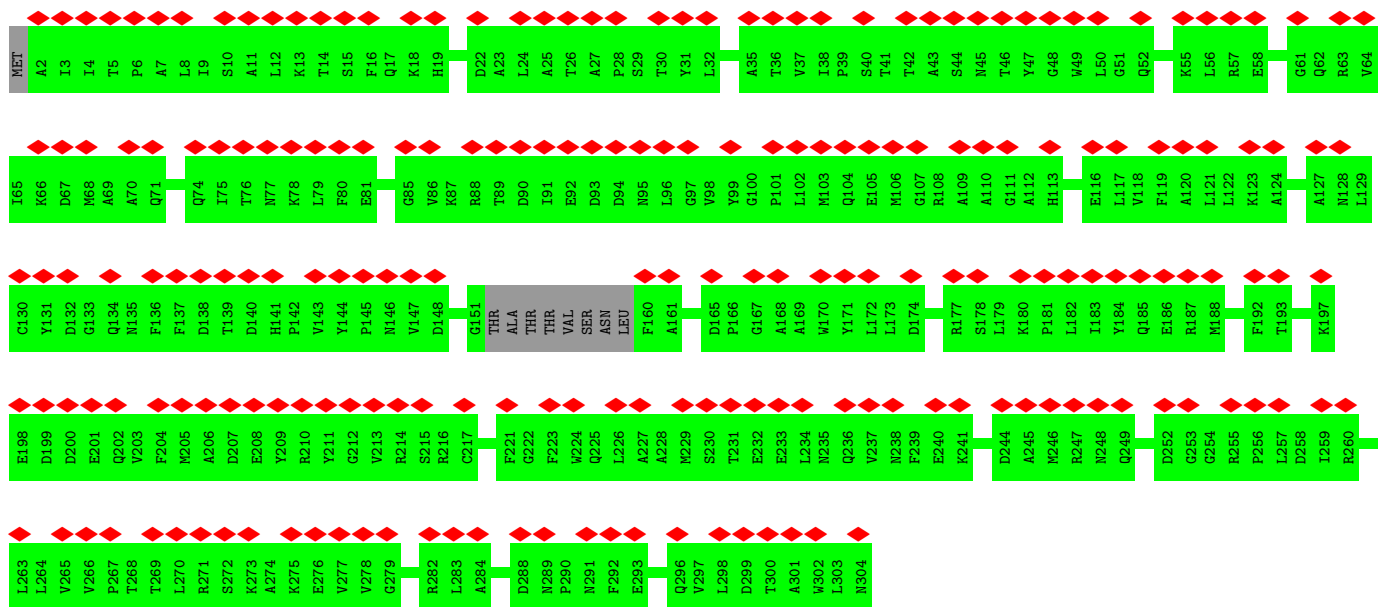

• Molecule 2: Bacteriophage Mu GpT domain-containing protein

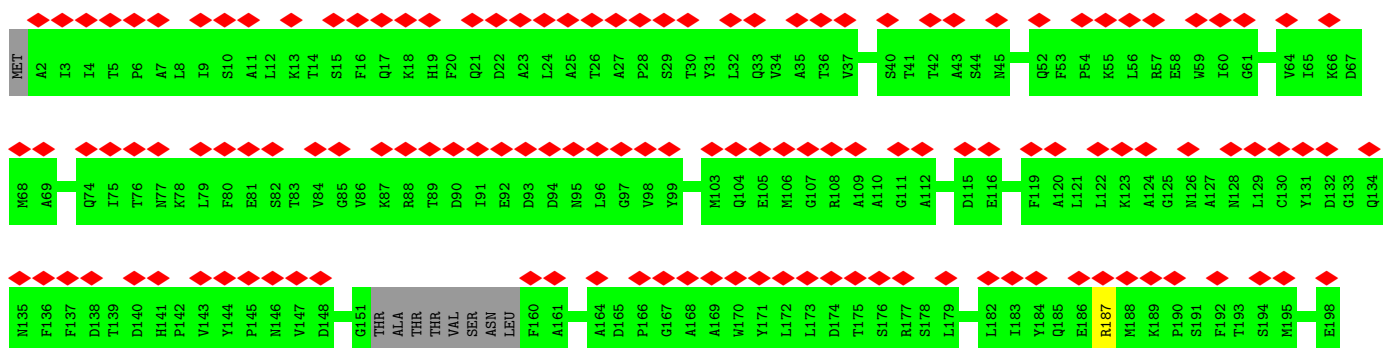



• Molecule 2: Bacteriophage Mu GpT domain-containing protein

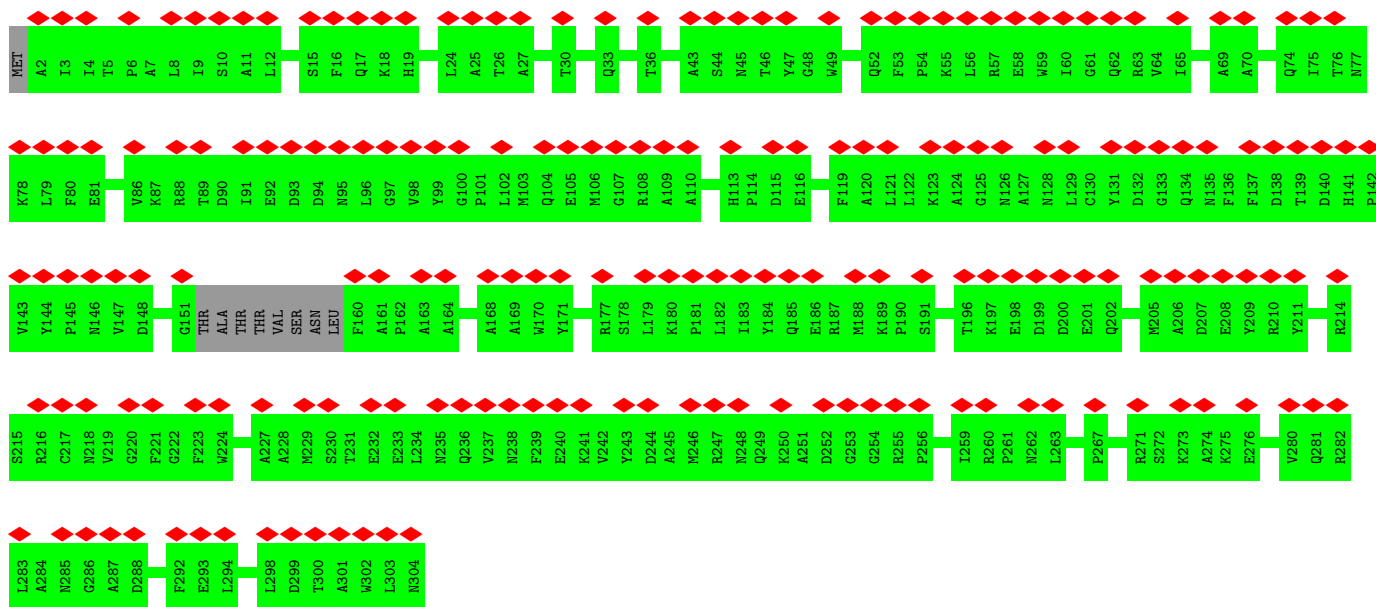

• Molecule 2: Bacteriophage Mu GpT domain-containing protein

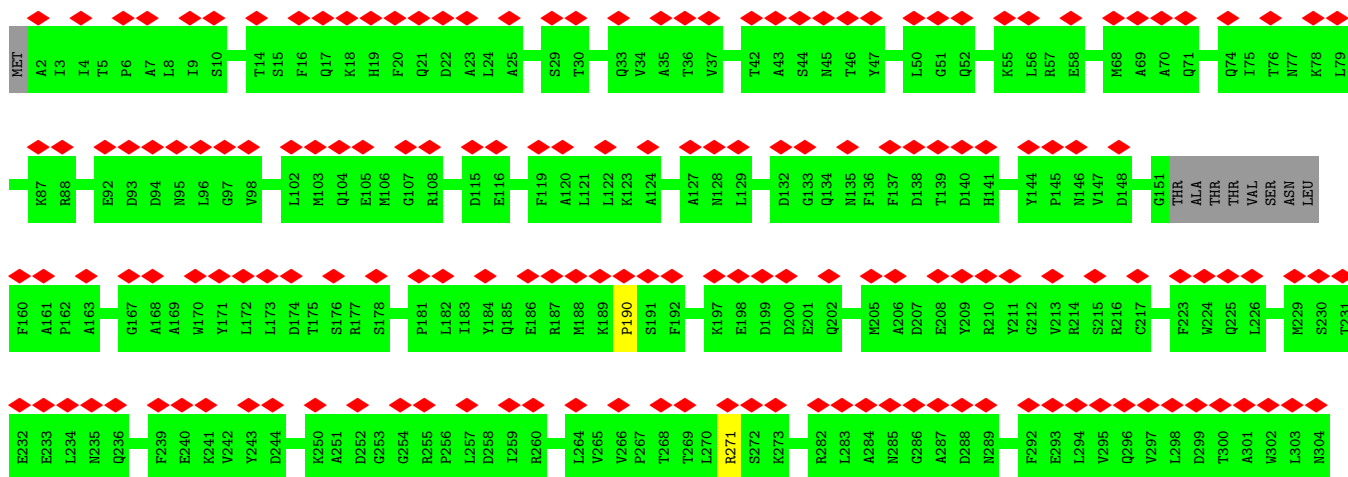

• Molecule 2: Bacteriophage Mu GpT domain-containing protein

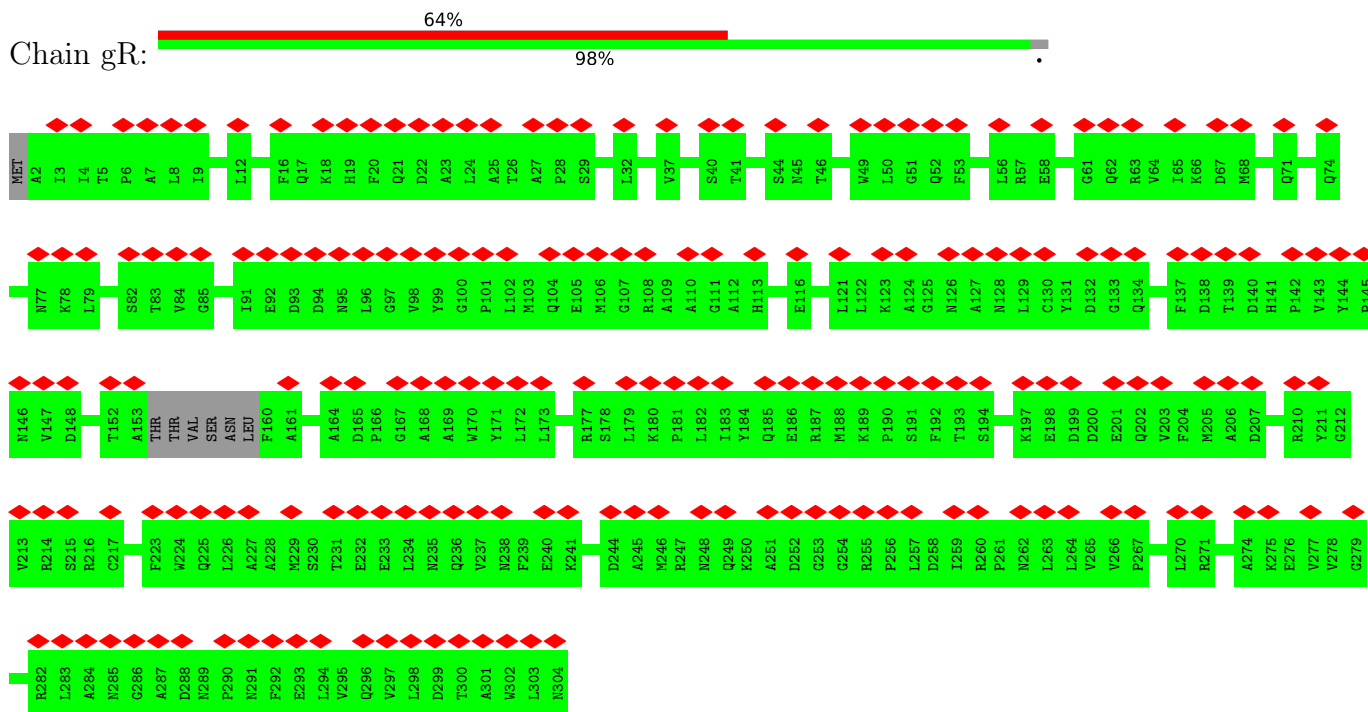

• Molecule 2: Bacteriophage Mu GpT domain-containing protein



• Molecule 2: Bacteriophage Mu GpT domain-containing protein

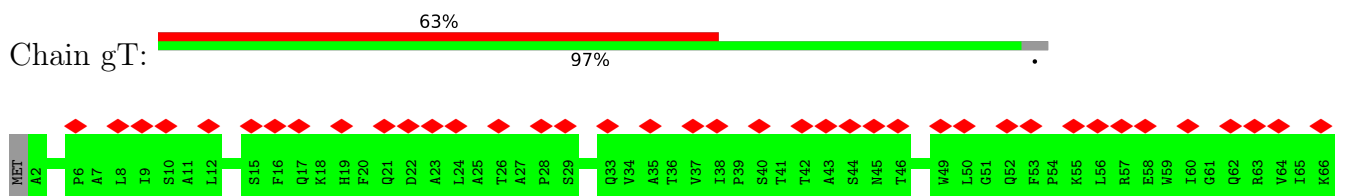

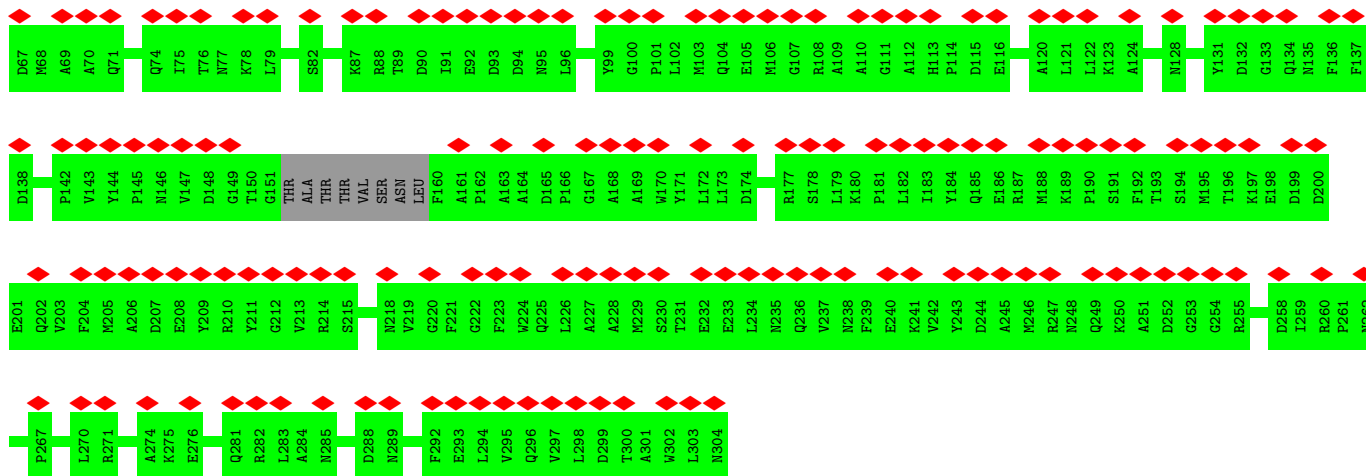

• Molecule 2: Bacteriophage Mu GpT domain-containing protein

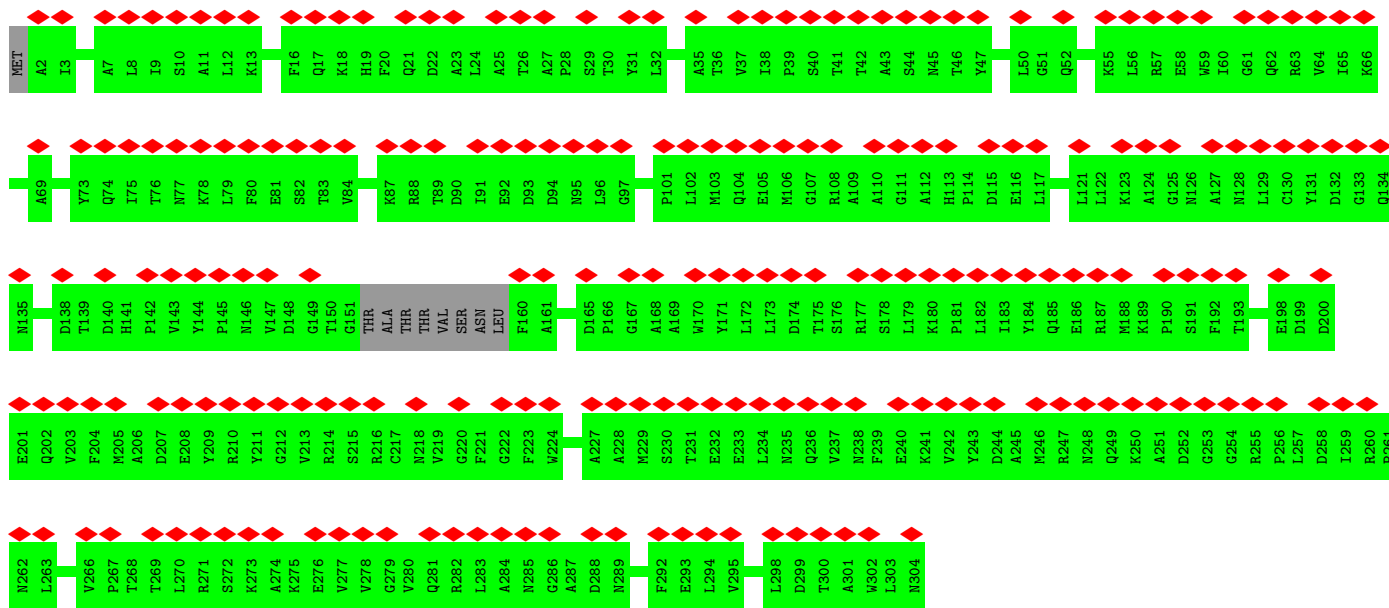
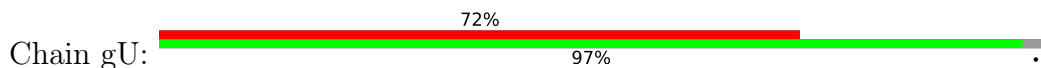

• Molecule 2: Bacteriophage Mu GpT domain-containing protein

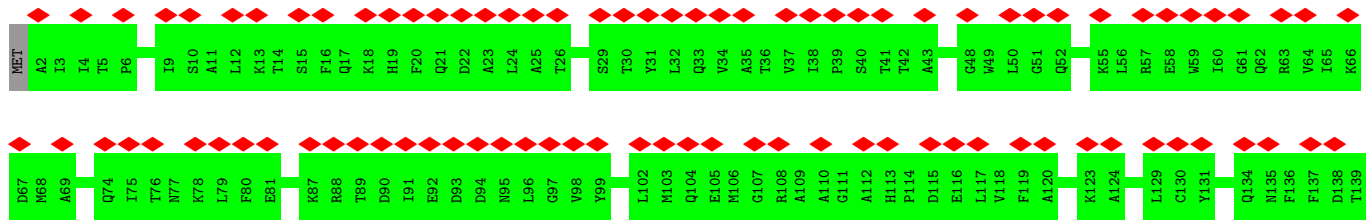

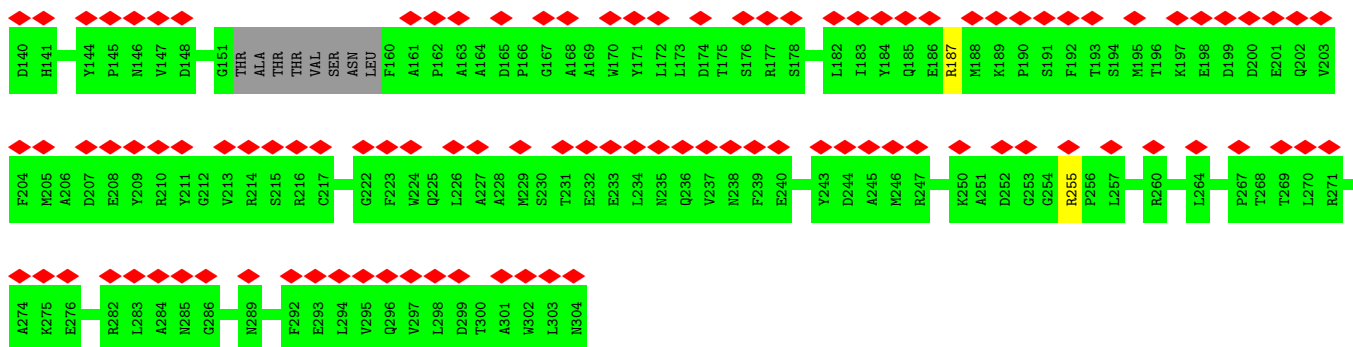

• Molecule 2: Bacteriophage Mu GpT domain-containing protein

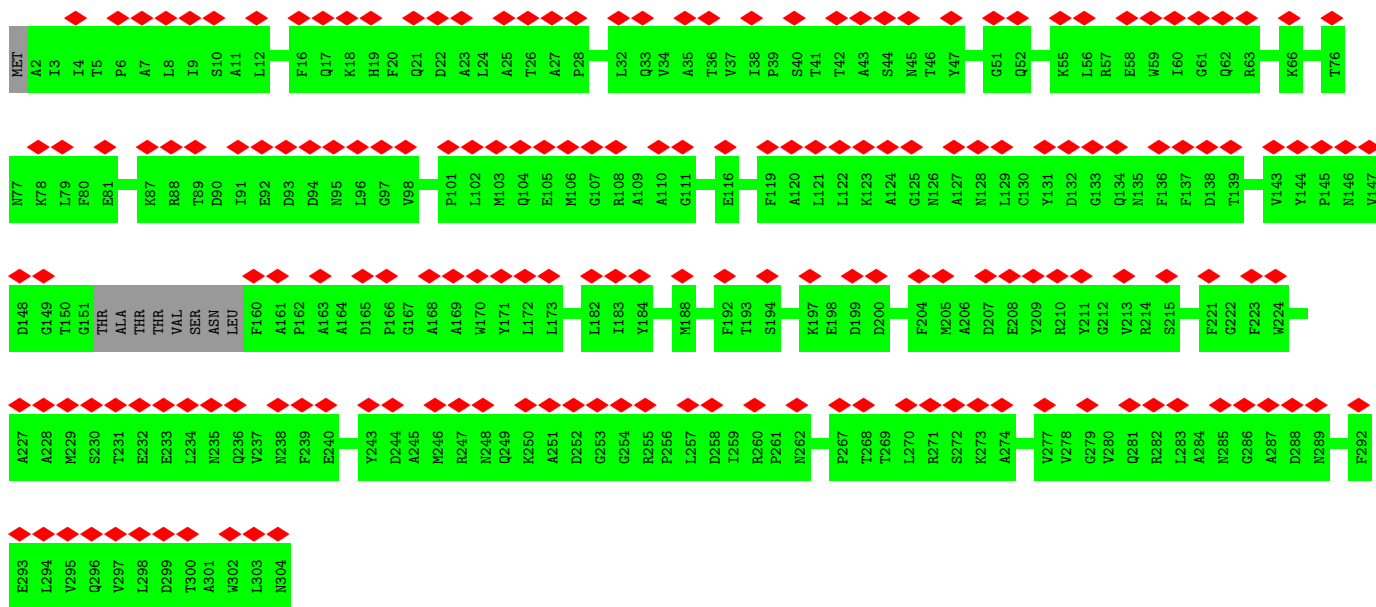

• Molecule 2: Bacteriophage Mu GpT domain-containing protein

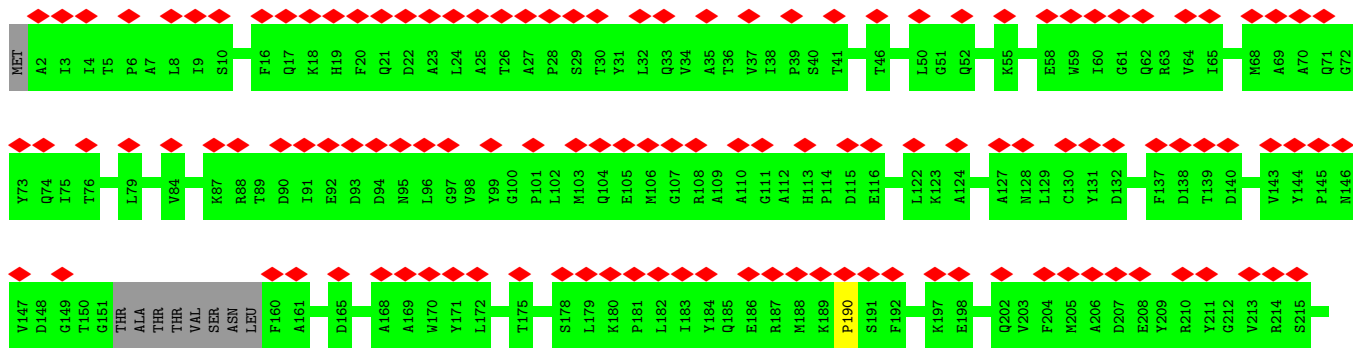

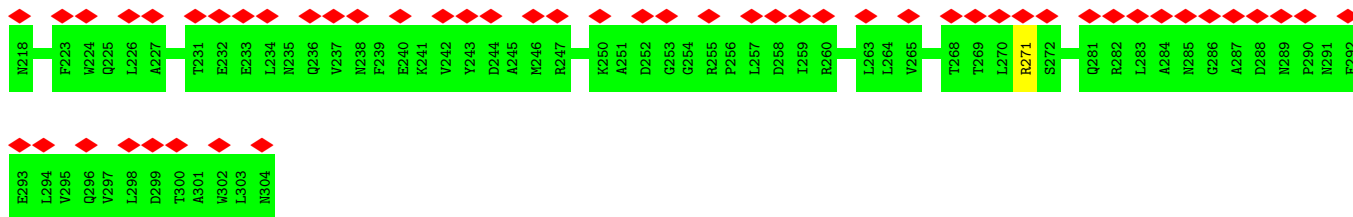

• Molecule 2: Bacteriophage Mu GpT domain-containing protein

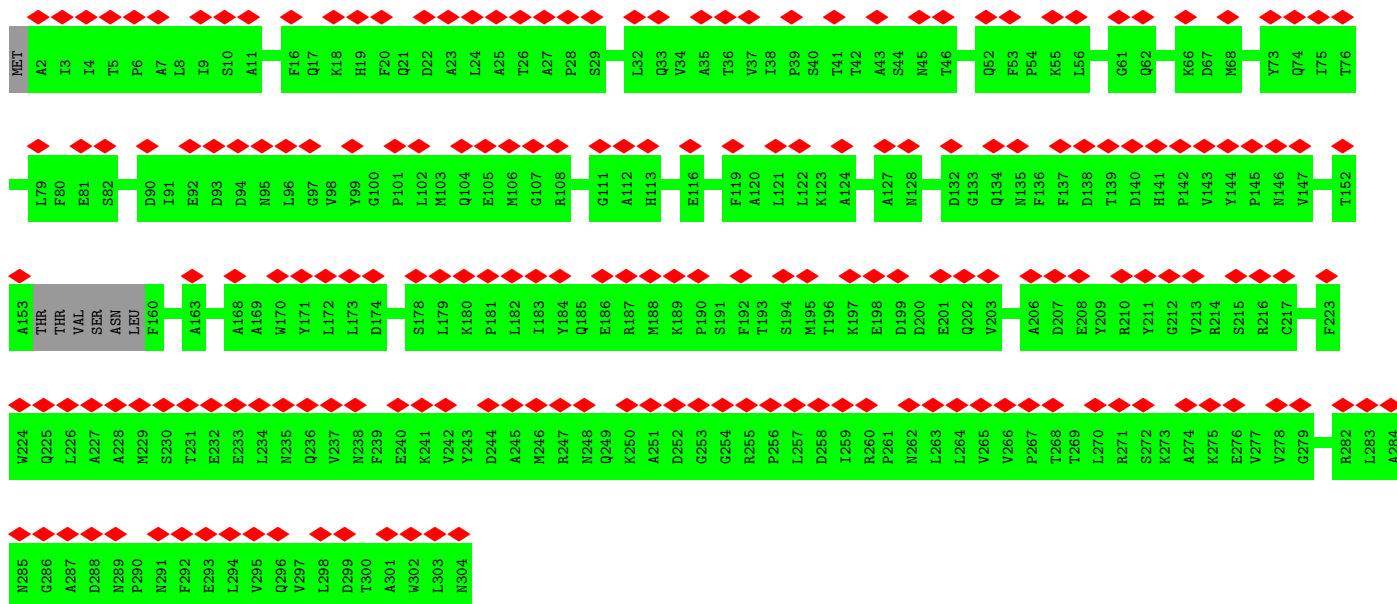

• Molecule 2: Bacteriophage Mu GpT domain-containing protein

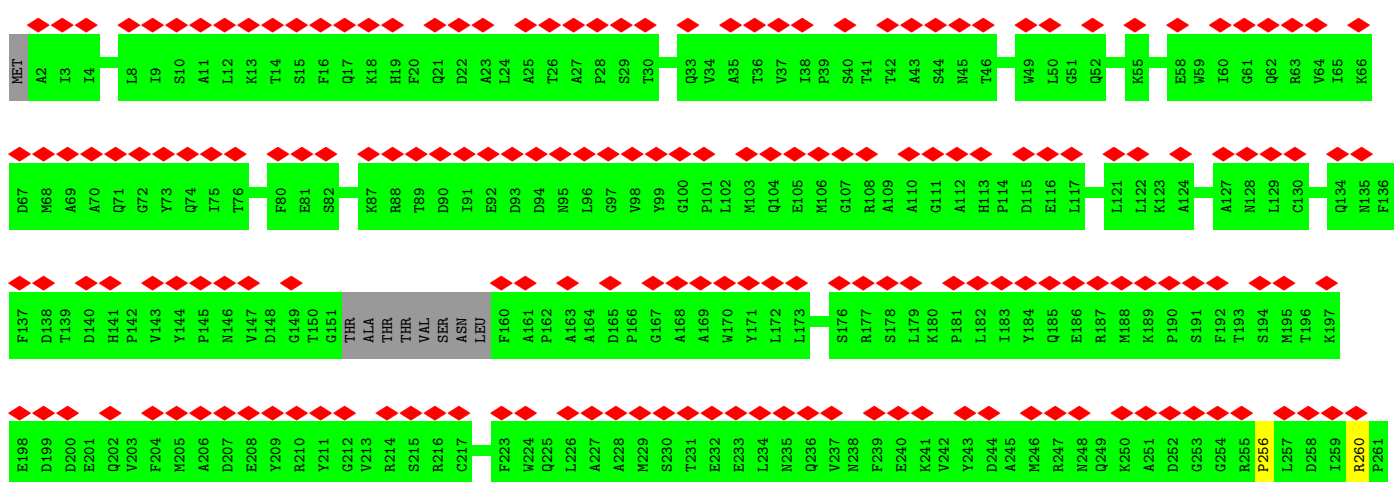
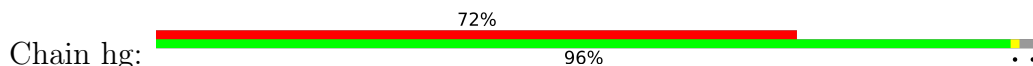

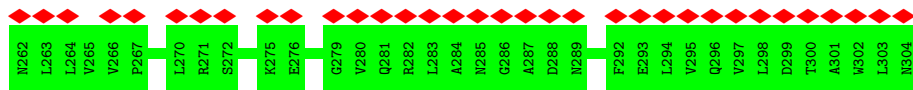

• Molecule 2: Bacteriophage Mu GpT domain-containing protein

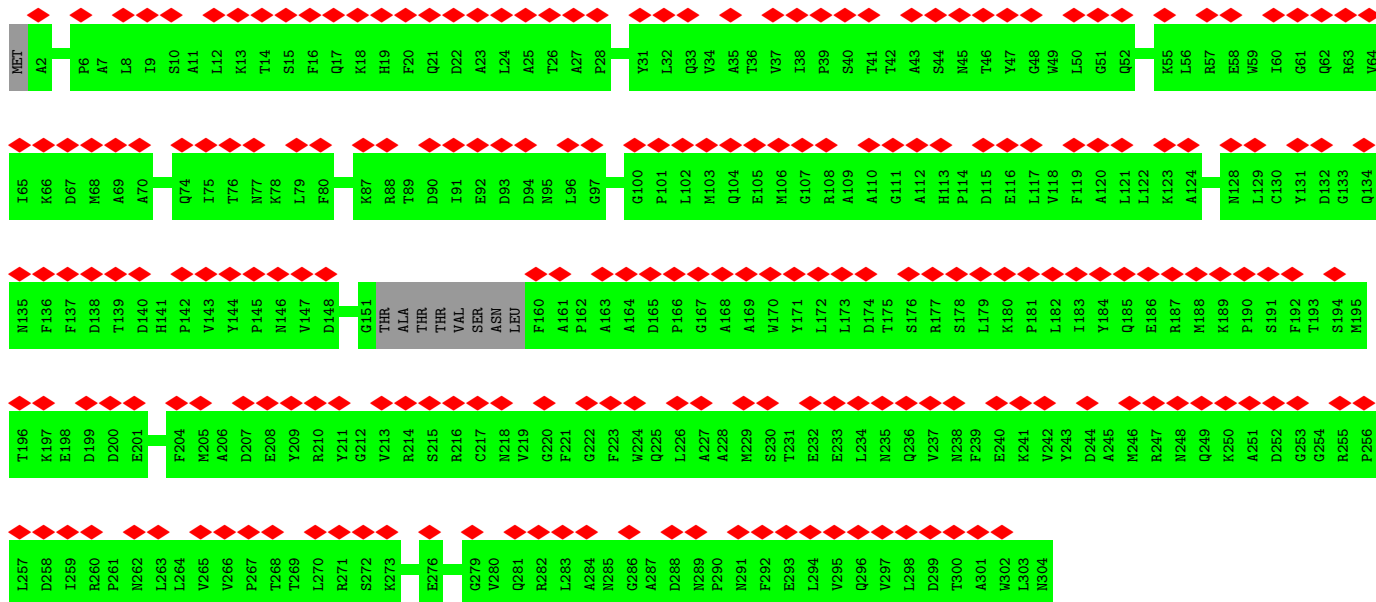
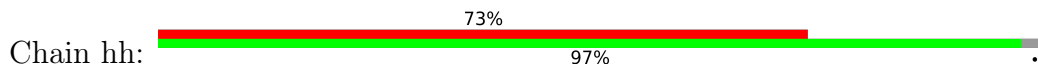

• Molecule 2: Bacteriophage Mu GpT domain-containing protein

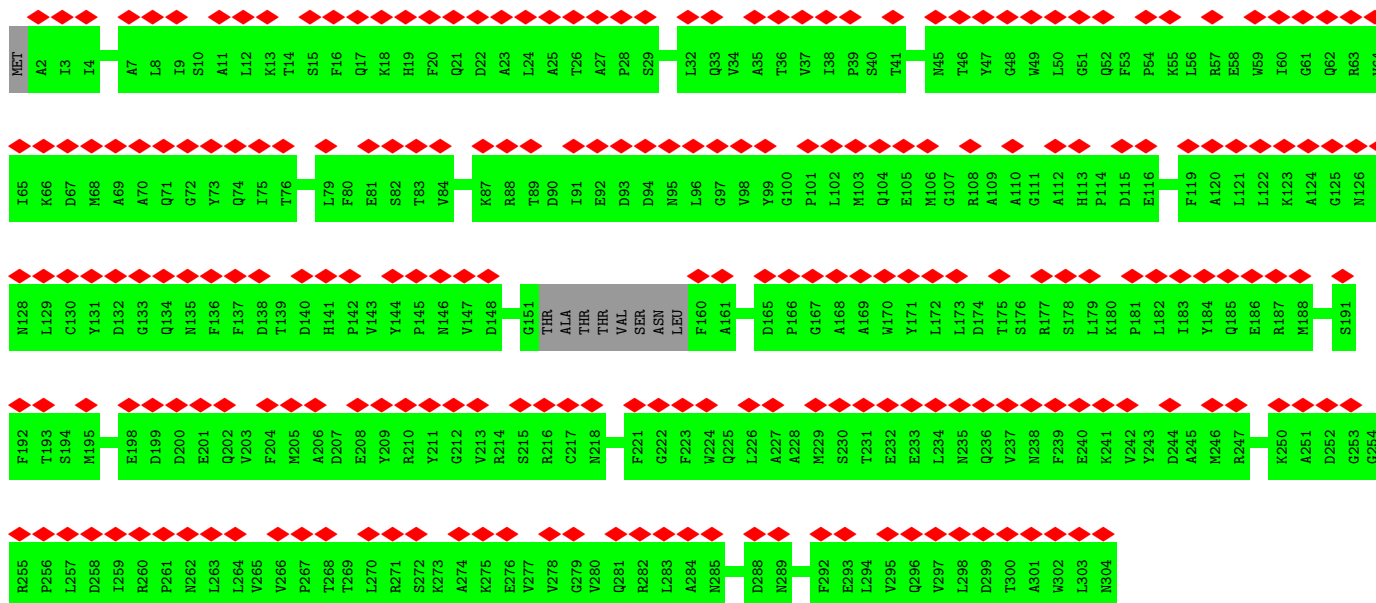
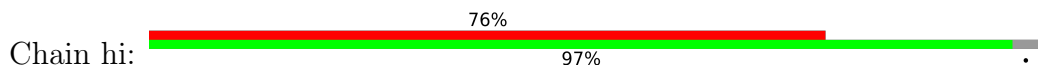

• Molecule 2: Bacteriophage Mu GpT domain-containing protein

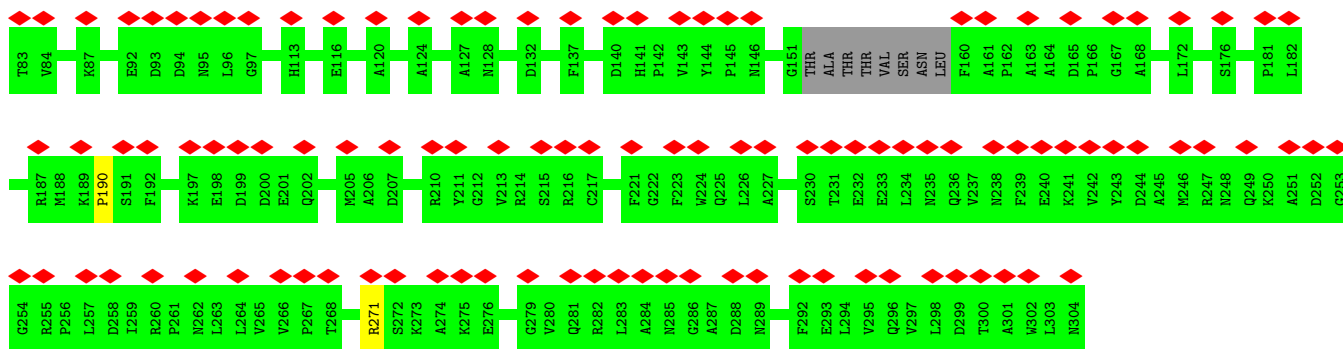

• Molecule 2: Bacteriophage Mu GpT domain-containing protein



• Molecule 2: Bacteriophage Mu GpT domain-containing protein

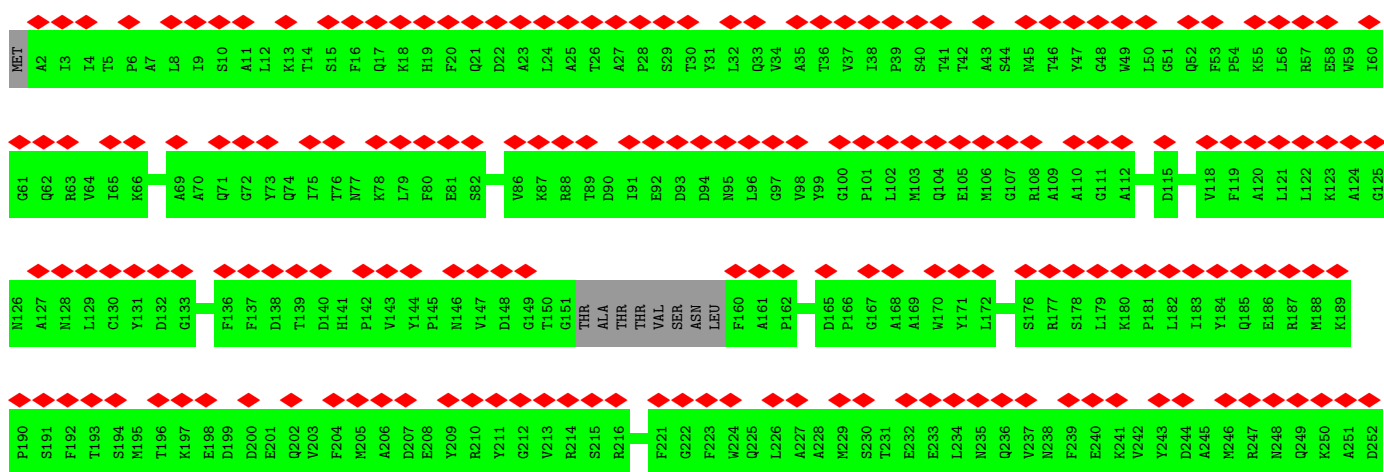
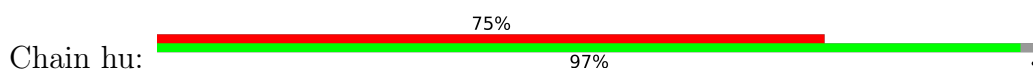

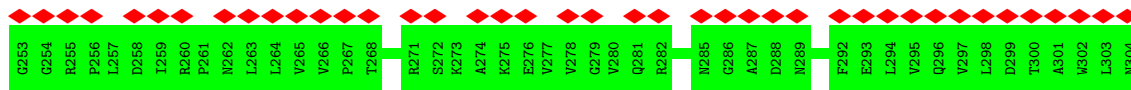

• Molecule 2: Bacteriophage Mu GpT domain-containing protein



• Molecule 2: Bacteriophage Mu GpT domain-containing protein



• Molecule 2: Bacteriophage Mu GpT domain-containing protein

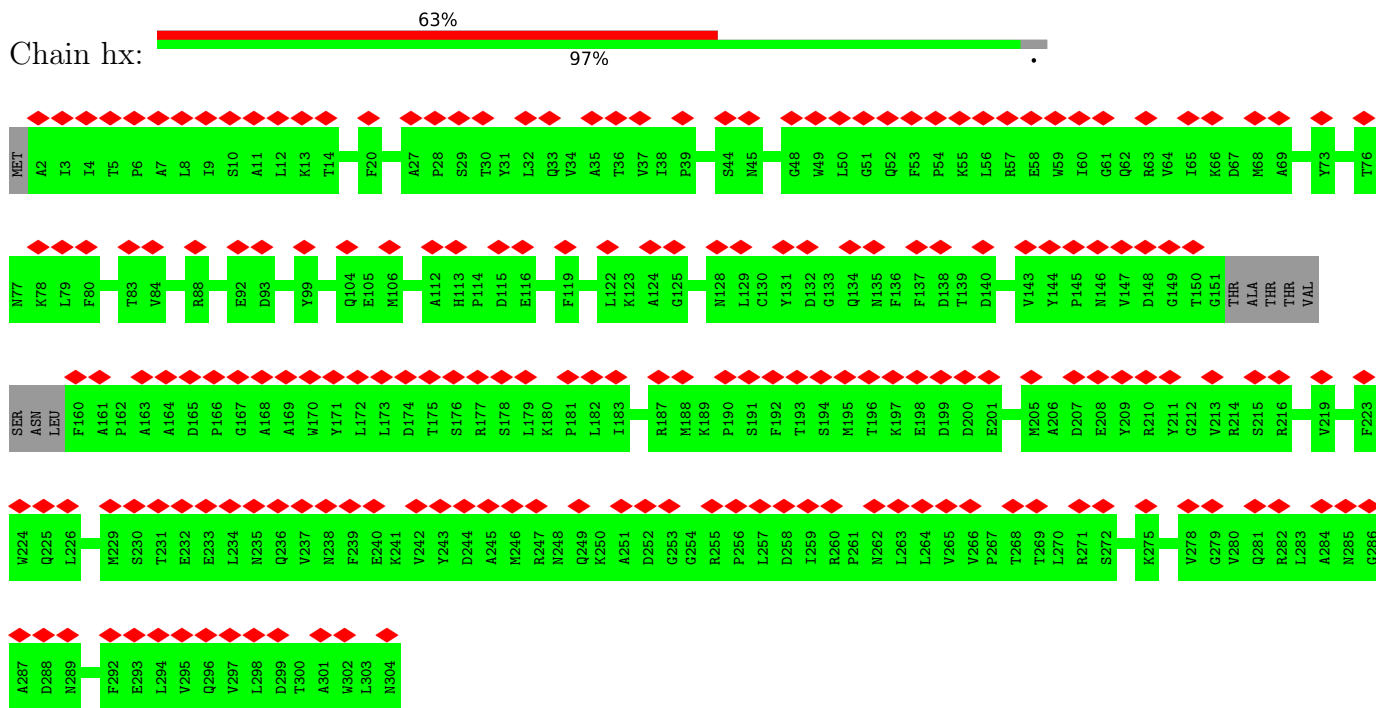

• Molecule 2: Bacteriophage Mu GpT domain-containing protein



• Molecule 2: Bacteriophage Mu GpT domain-containing protein

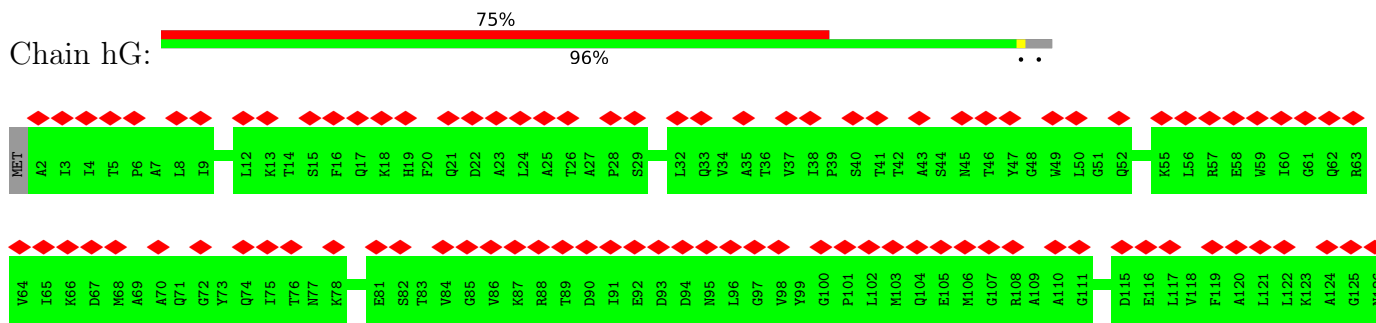

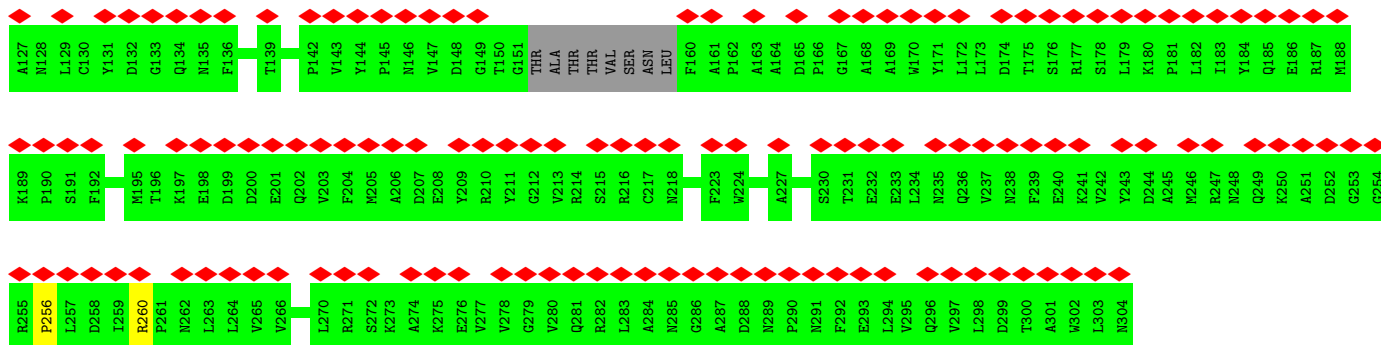

• Molecule 2: Bacteriophage Mu GpT domain-containing protein

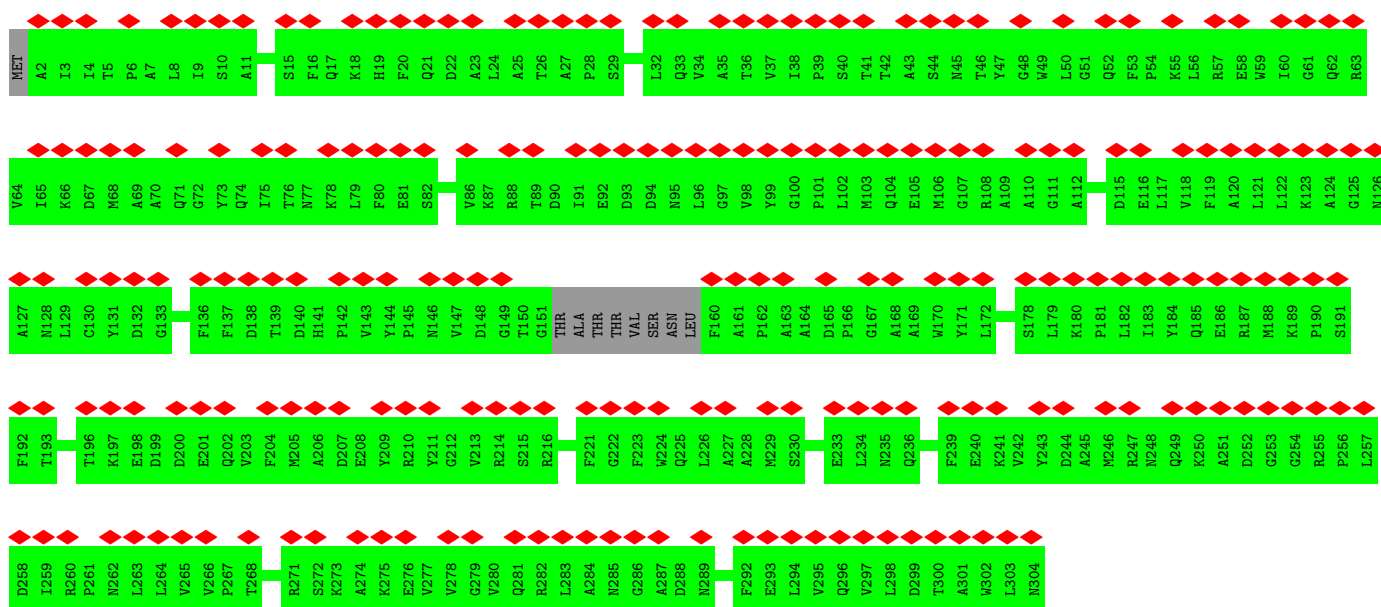
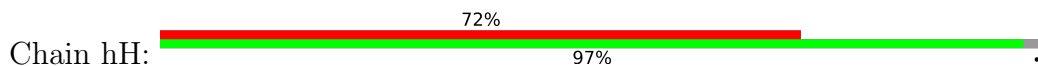

• Molecule 2: Bacteriophage Mu GpT domain-containing protein

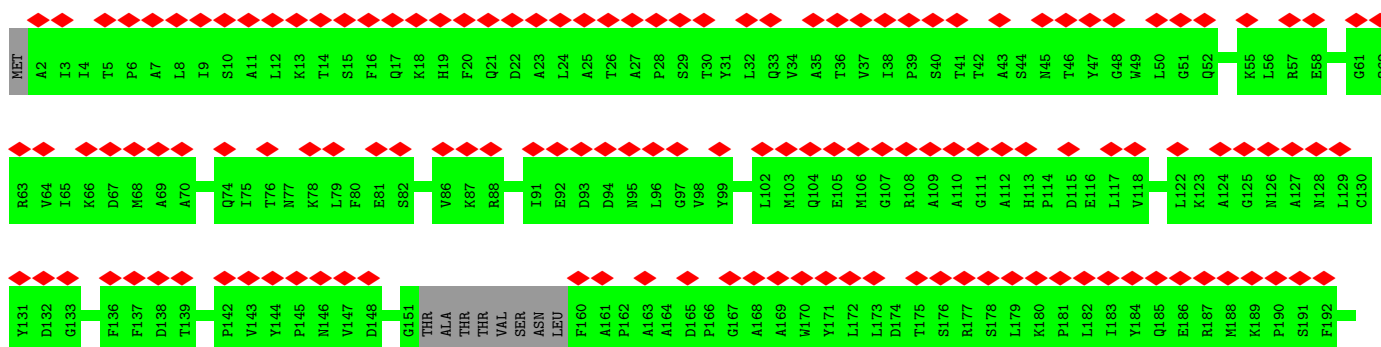
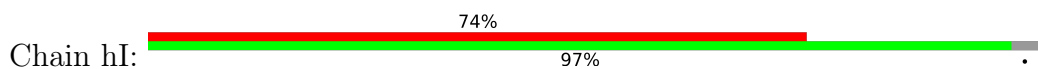

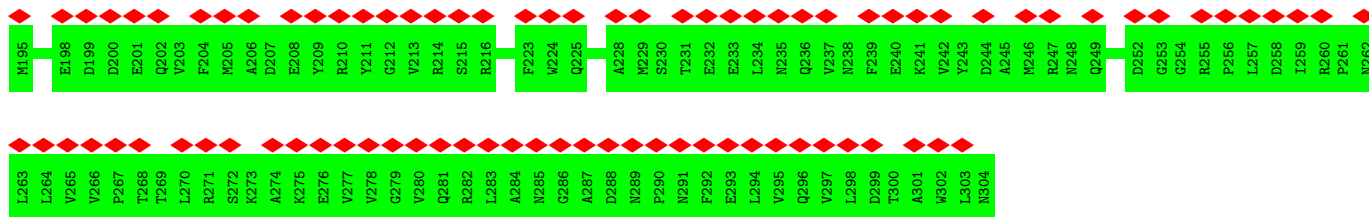

• Molecule 2: Bacteriophage Mu GpT domain-containing protein



• Molecule 2: Bacteriophage Mu GpT domain-containing protein

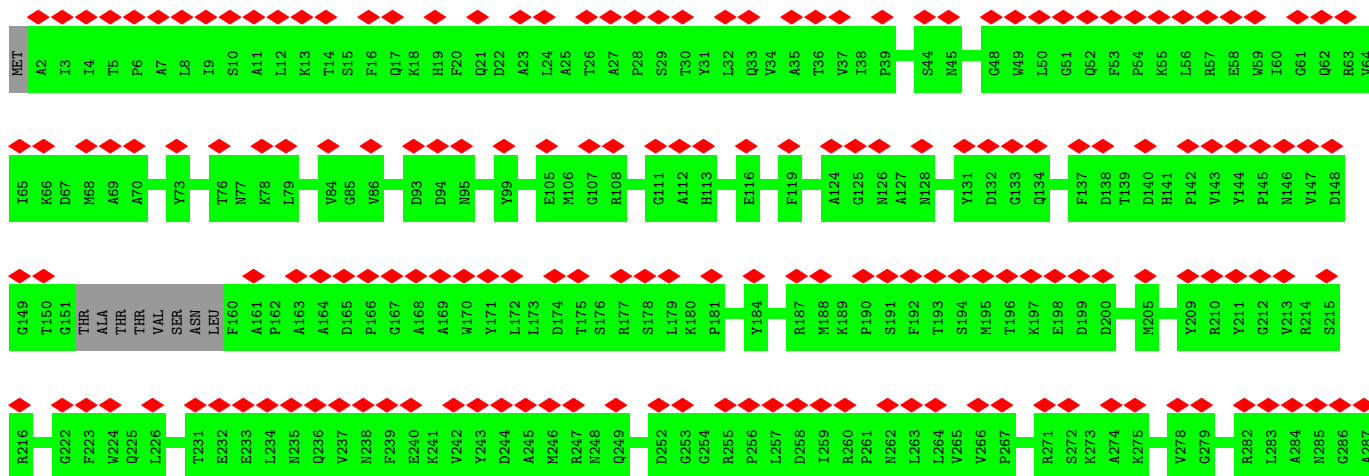

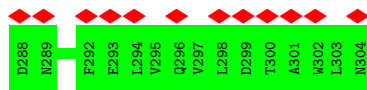

• Molecule 2: Bacteriophage Mu GpT domain-containing protein

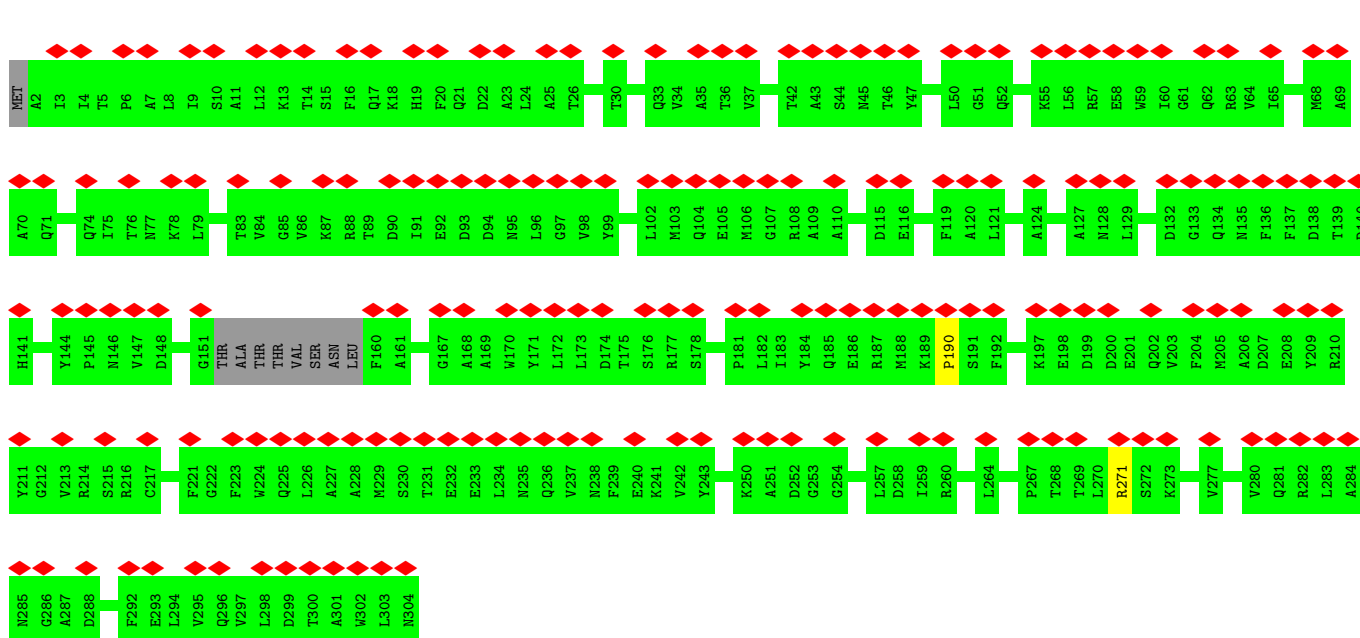

• Molecule 2: Bacteriophage Mu GpT domain-containing protein

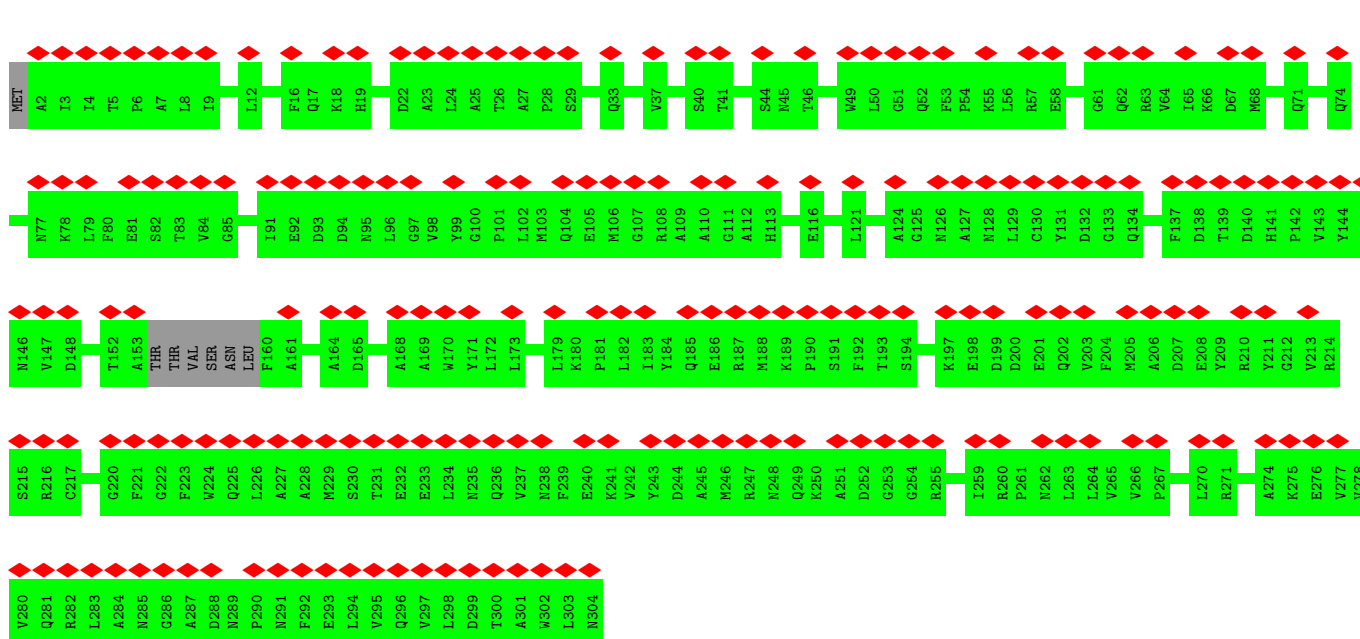

• Molecule 2: Bacteriophage Mu GpT domain-containing protein

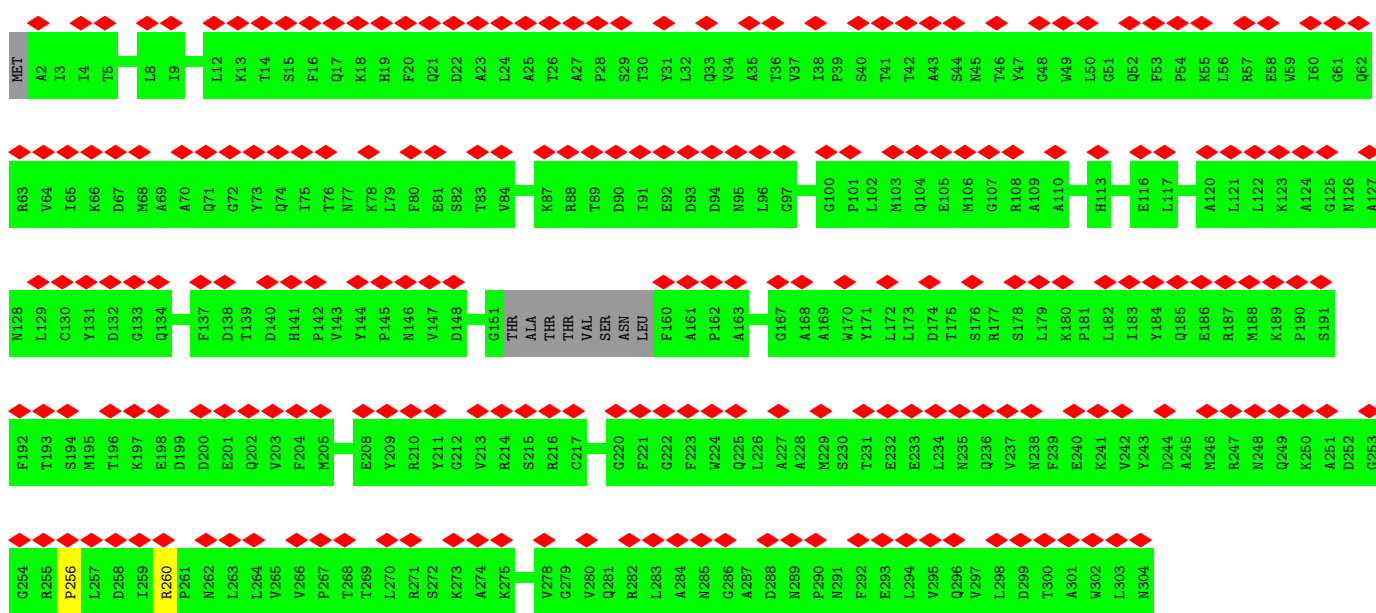
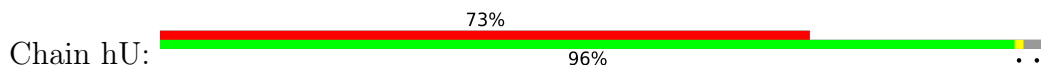

• Molecule 2: Bacteriophage Mu GpT domain-containing protein

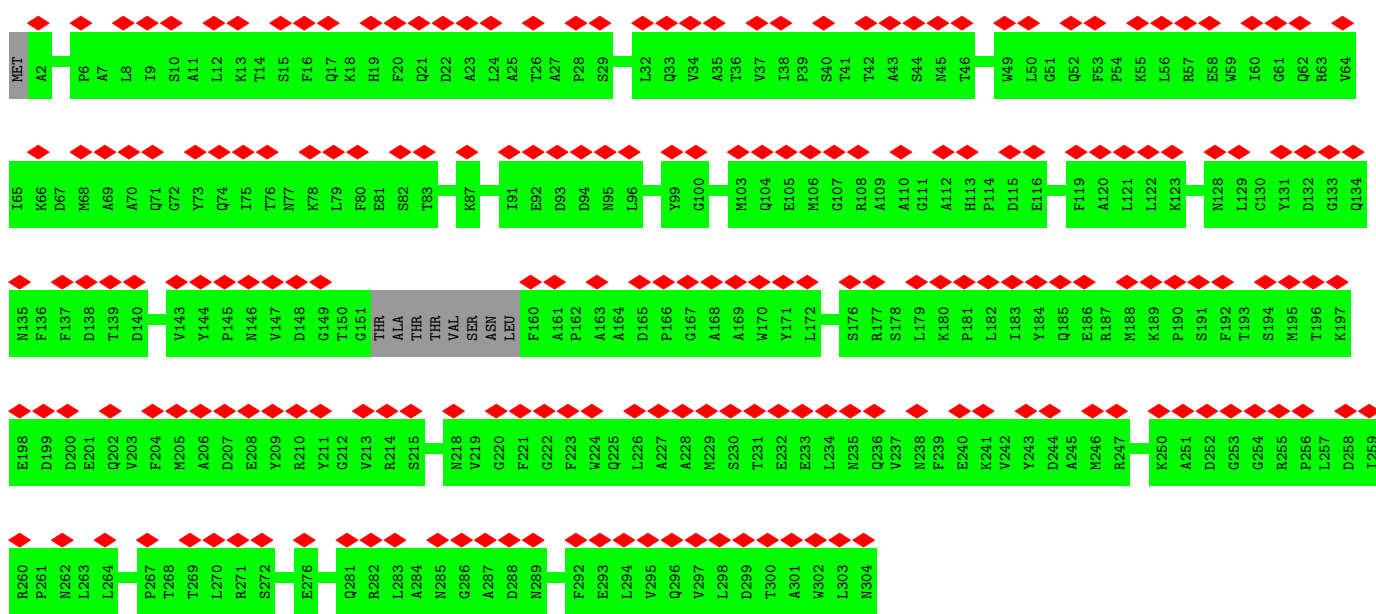

• Molecule 2: Bacteriophage Mu GpT domain-containing protein

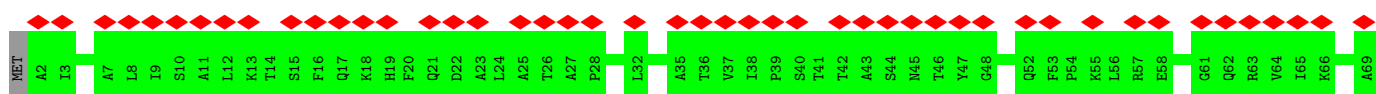
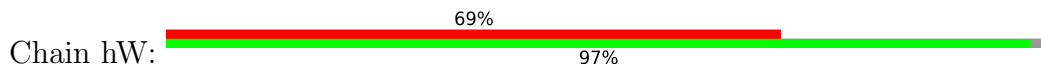

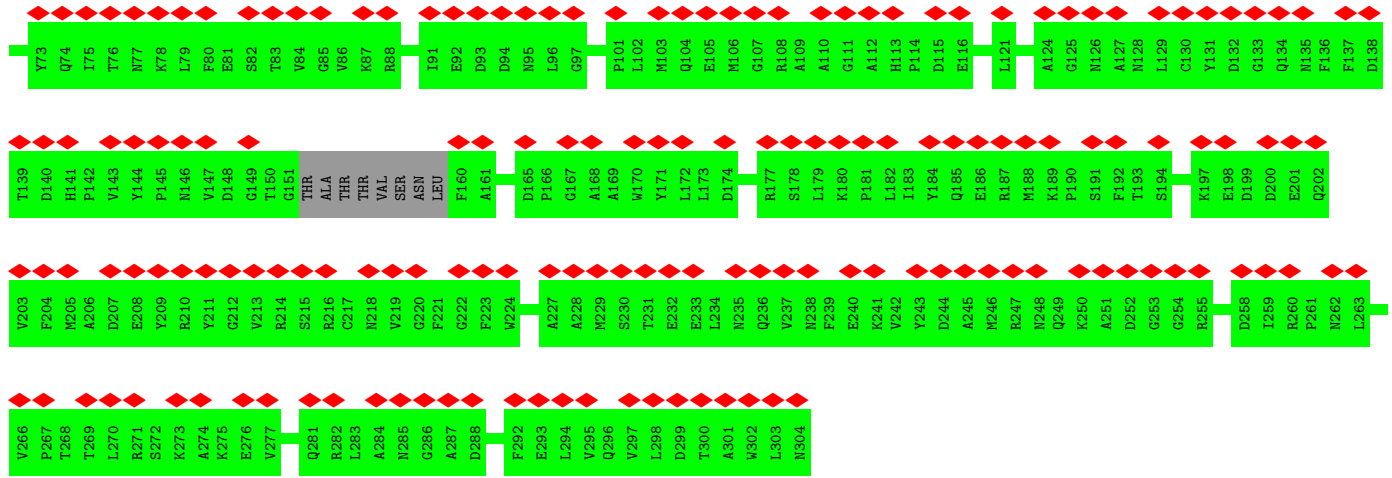

• Molecule 2: Bacteriophage Mu GpT domain-containing protein

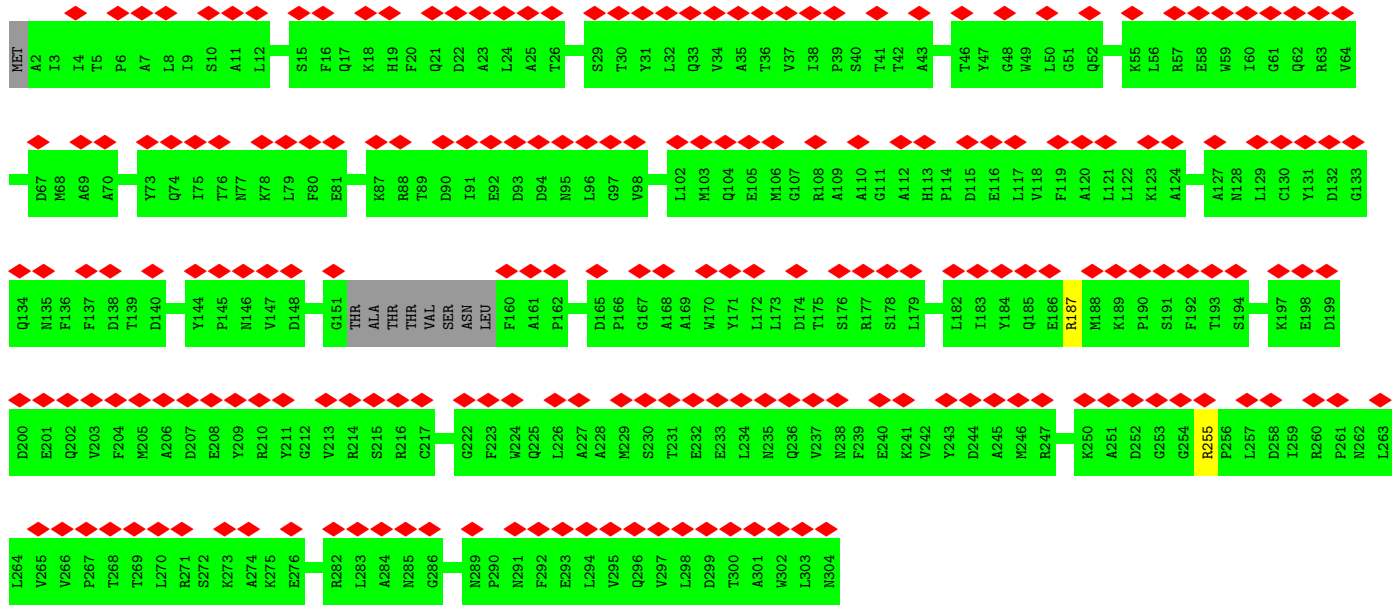

• Molecule 2: Bacteriophage Mu GpT domain-containing protein

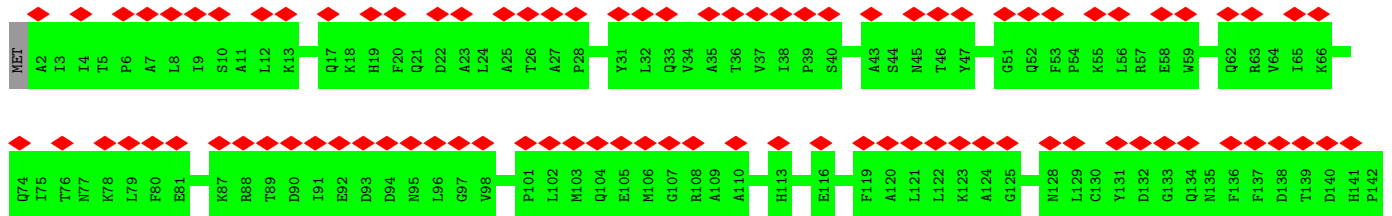

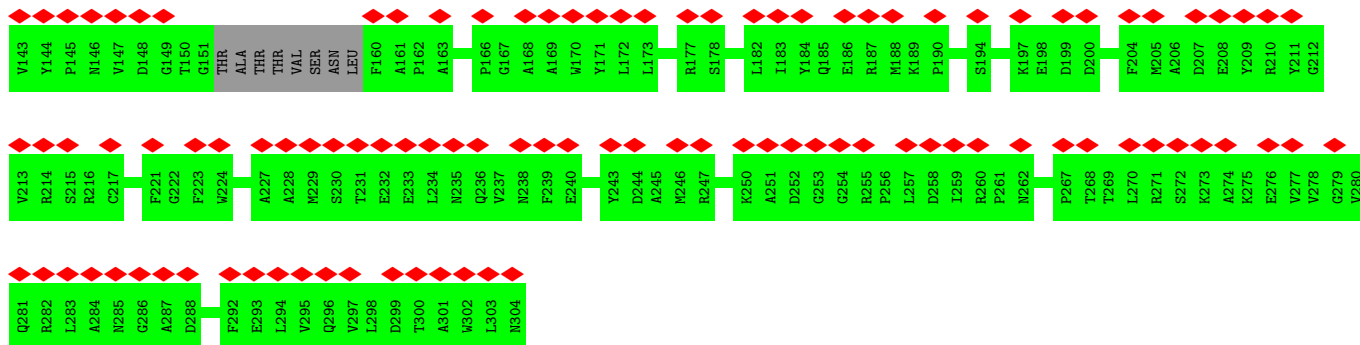

• Molecule 2: Bacteriophage Mu GpT domain-containing protein

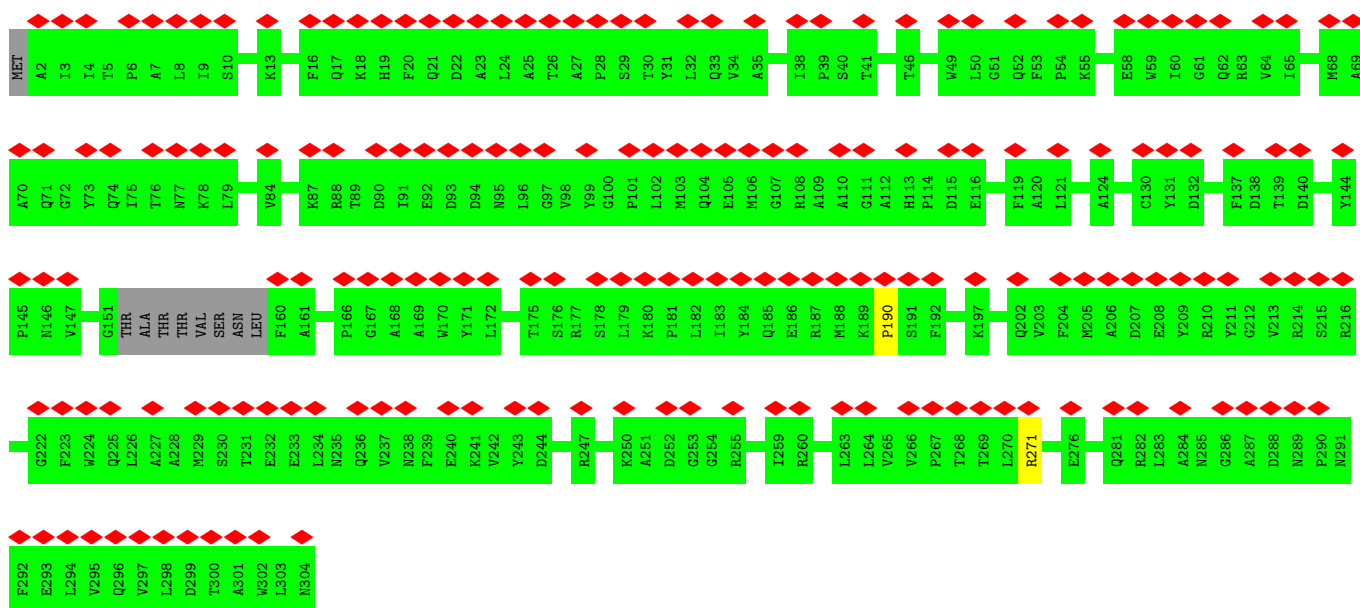

• Molecule 2: Bacteriophage Mu GpT domain-containing protein

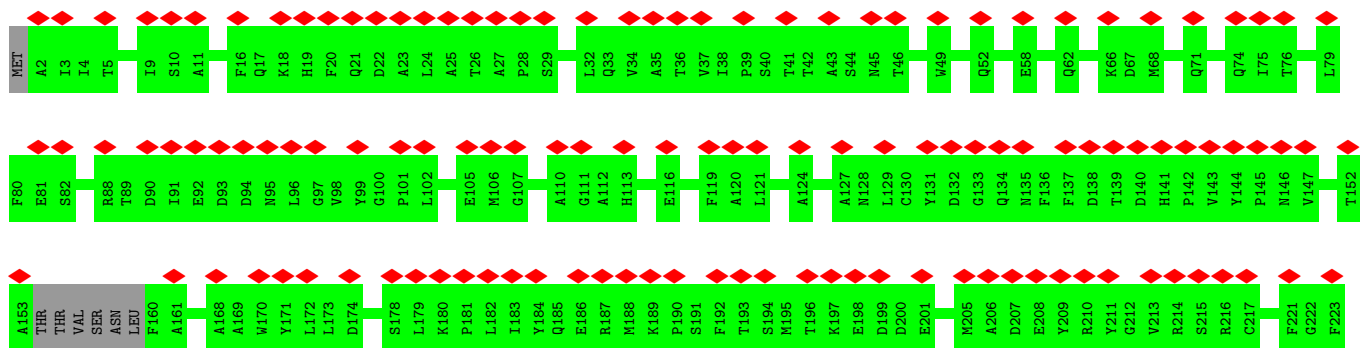



• Molecule 2: Bacteriophage Mu GpT domain-containing protein

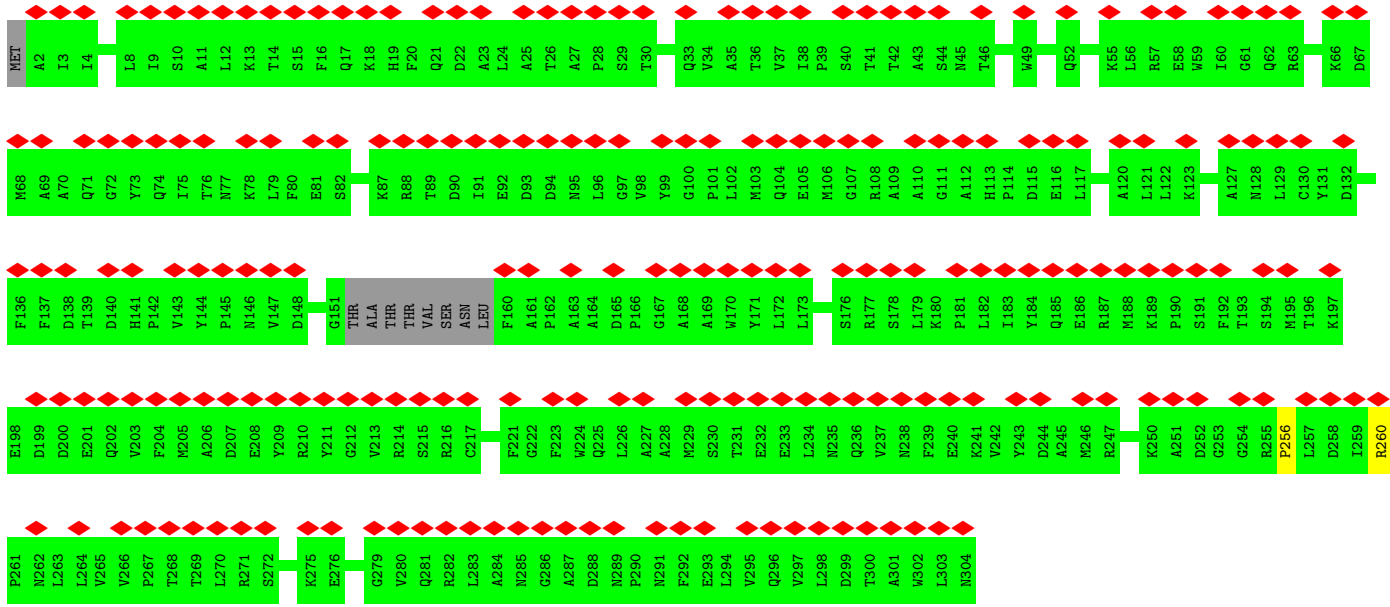

• Molecule 2: Bacteriophage Mu GpT domain-containing protein

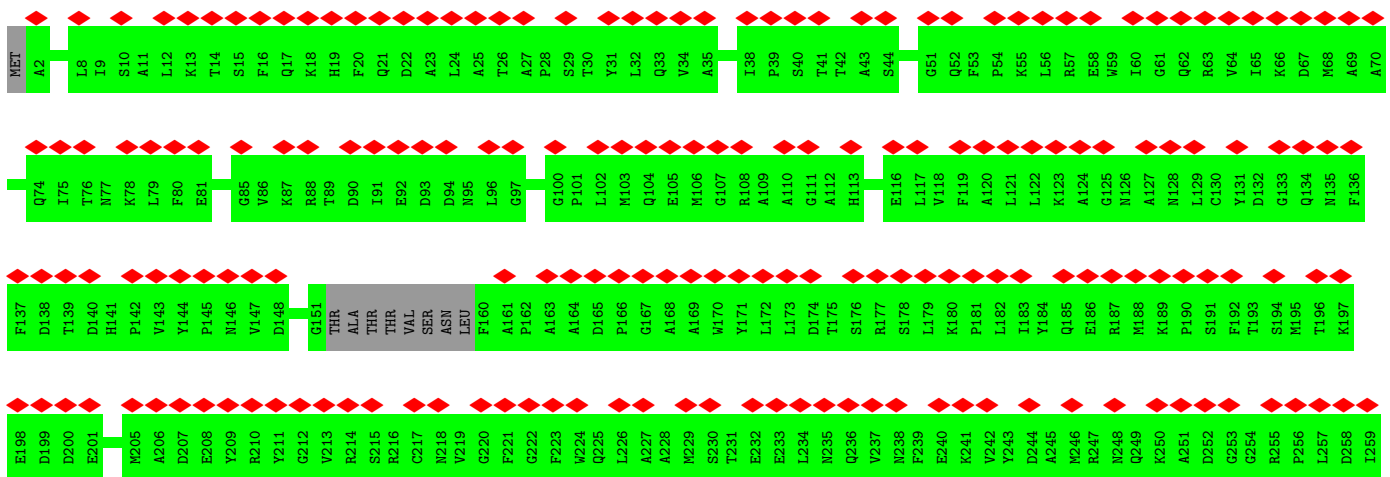

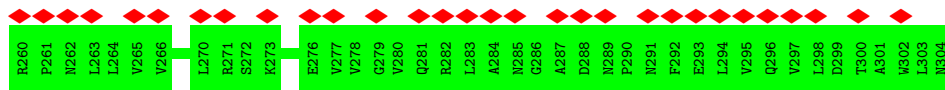

• Molecule 2: Bacteriophage Mu GpT domain-containing protein

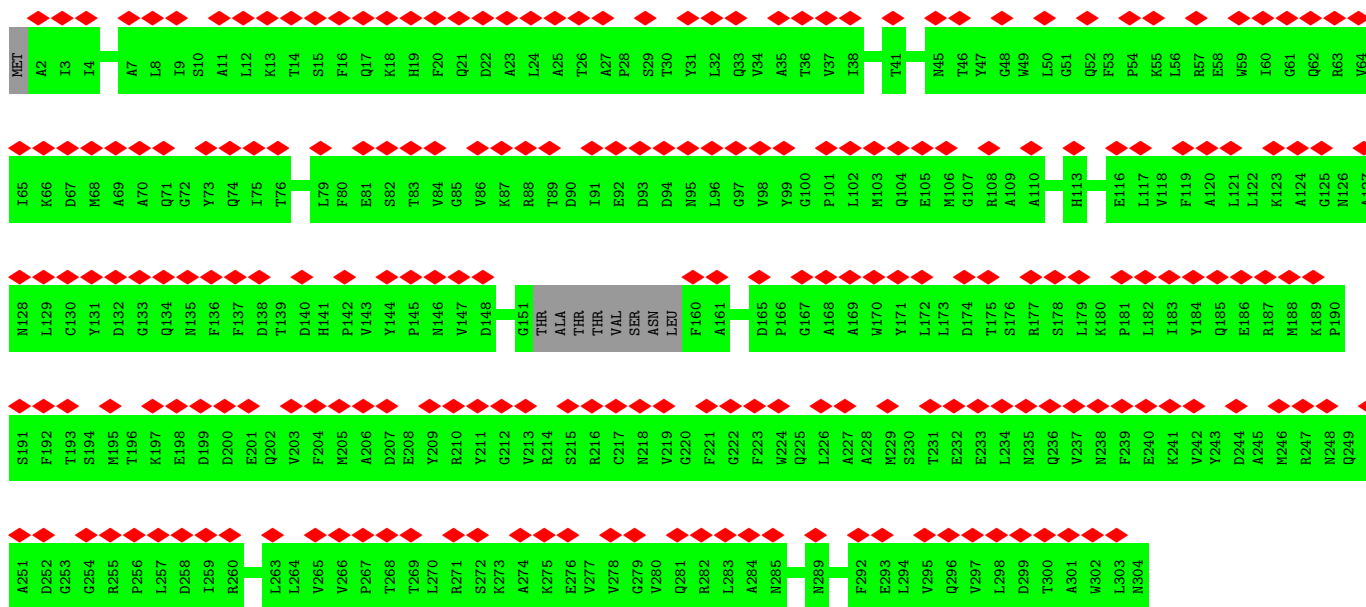
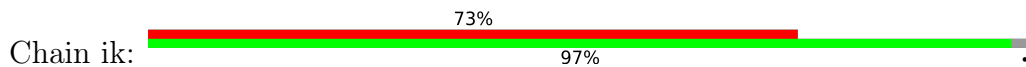

• Molecule 2: Bacteriophage Mu GpT domain-containing protein

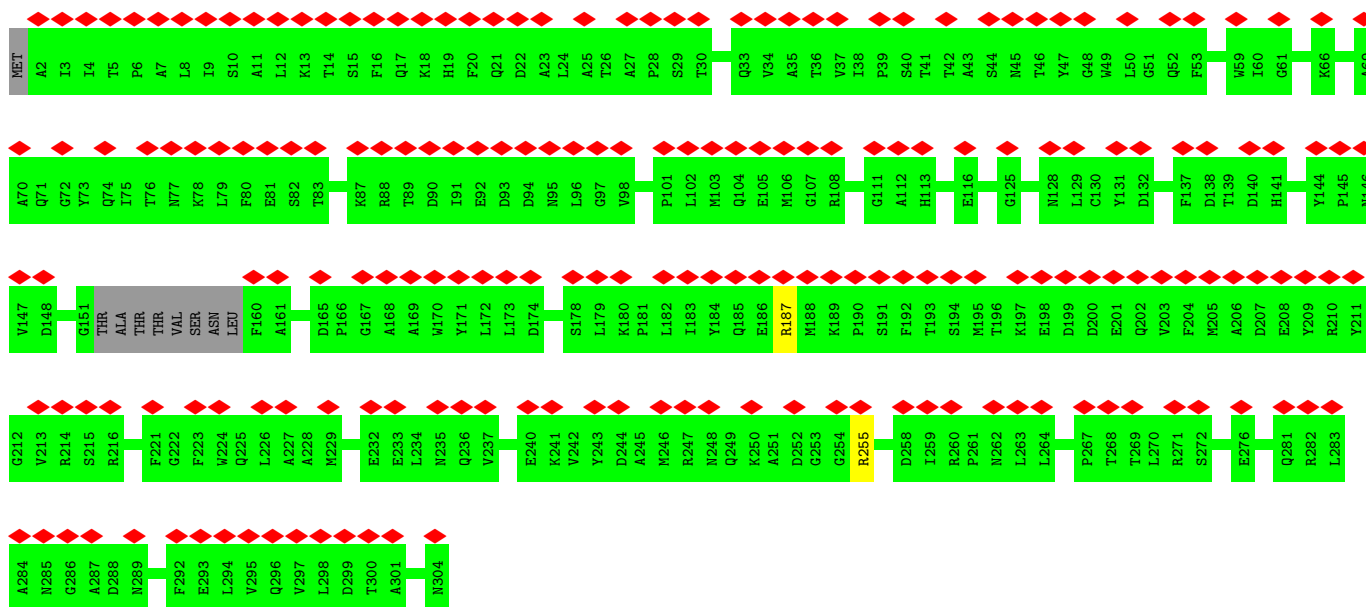

• Molecule 2: Bacteriophage Mu GpT domain-containing protein



• Molecule 2: Bacteriophage Mu GpT domain-containing protein

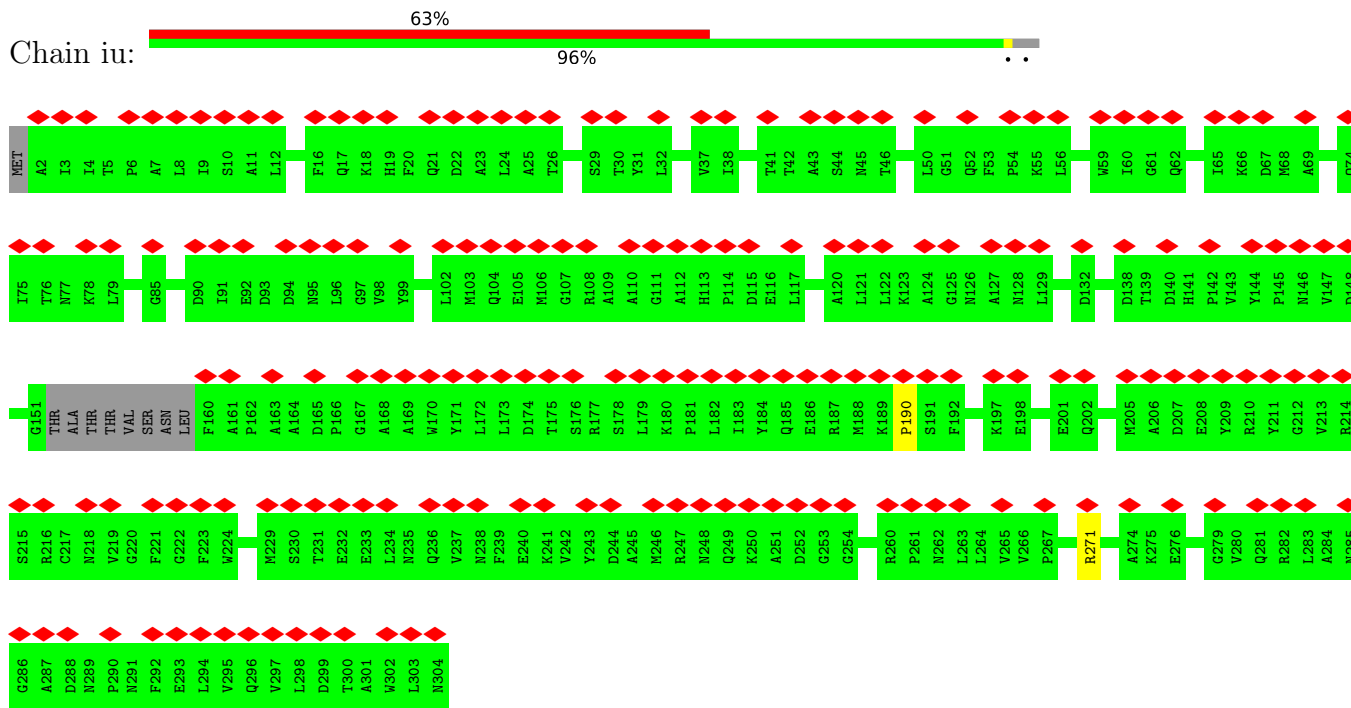

• Molecule 2: Bacteriophage Mu GpT domain-containing protein

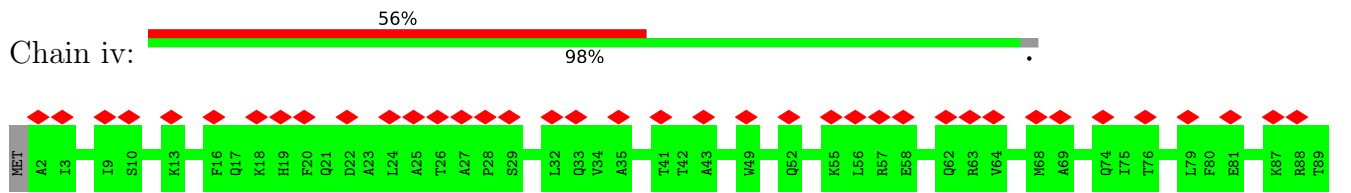

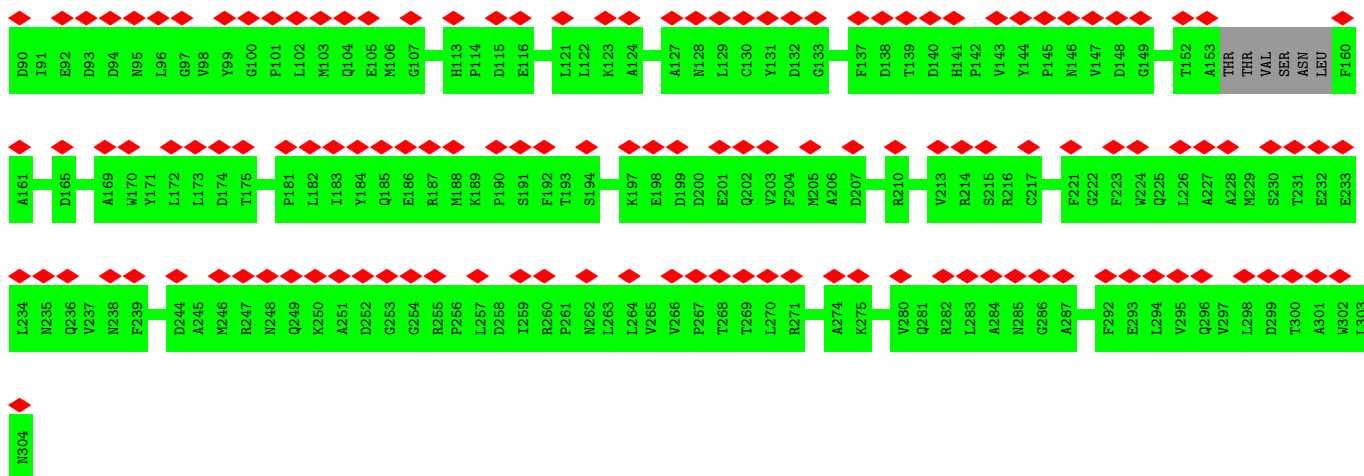

• Molecule 2: Bacteriophage Mu GpT domain-containing protein

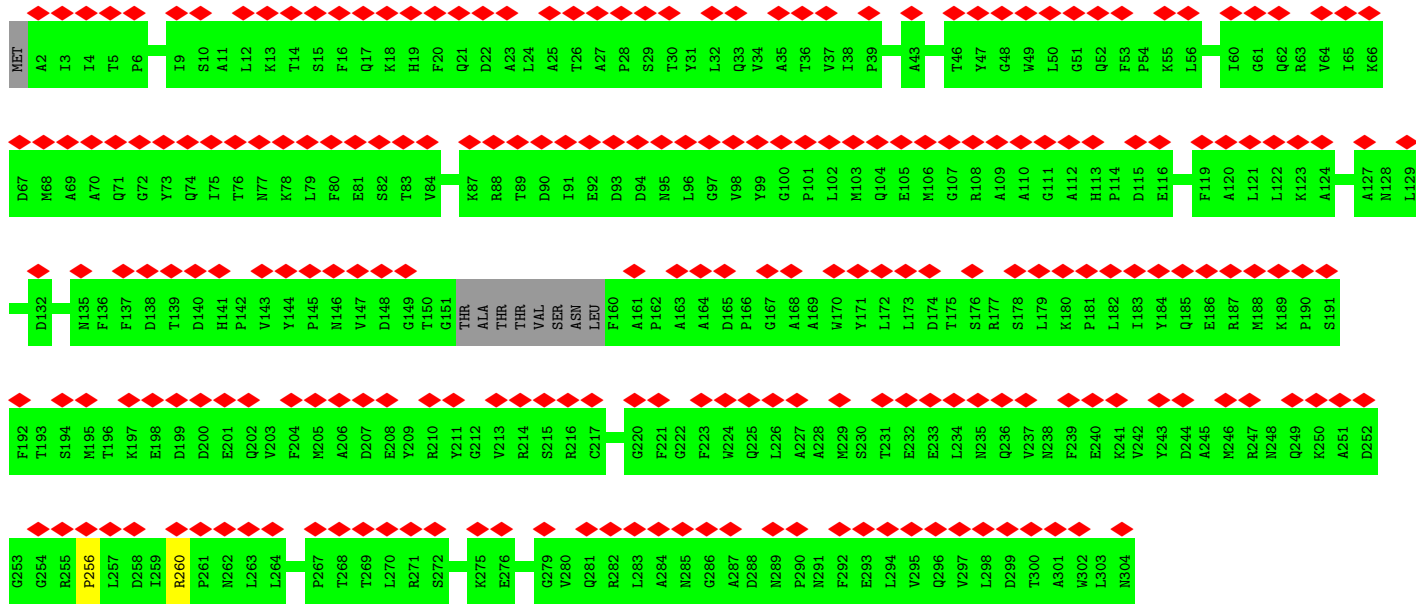
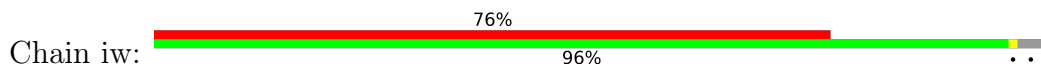

• Molecule 2: Bacteriophage Mu GpT domain-containing protein

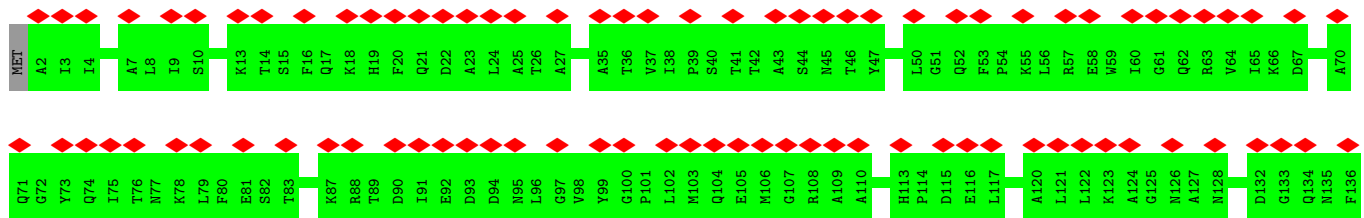

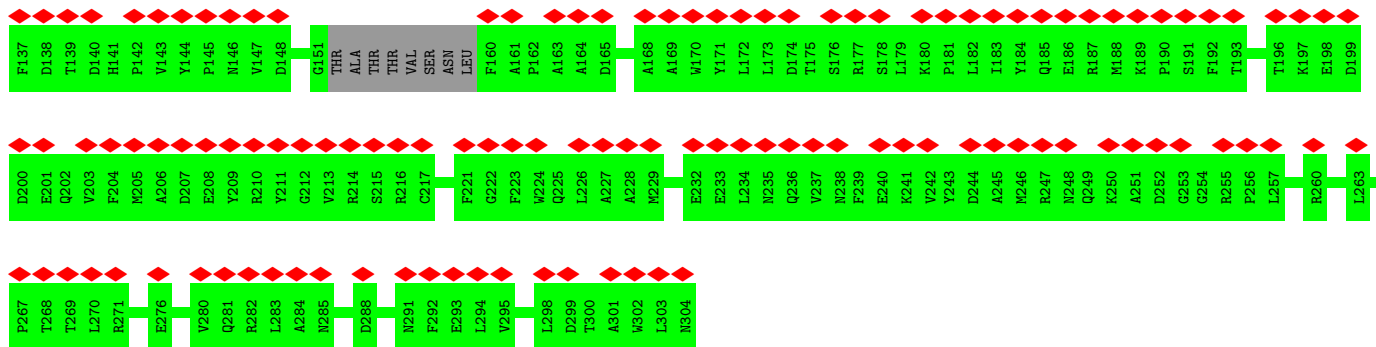

• Molecule 2: Bacteriophage Mu GpT domain-containing protein

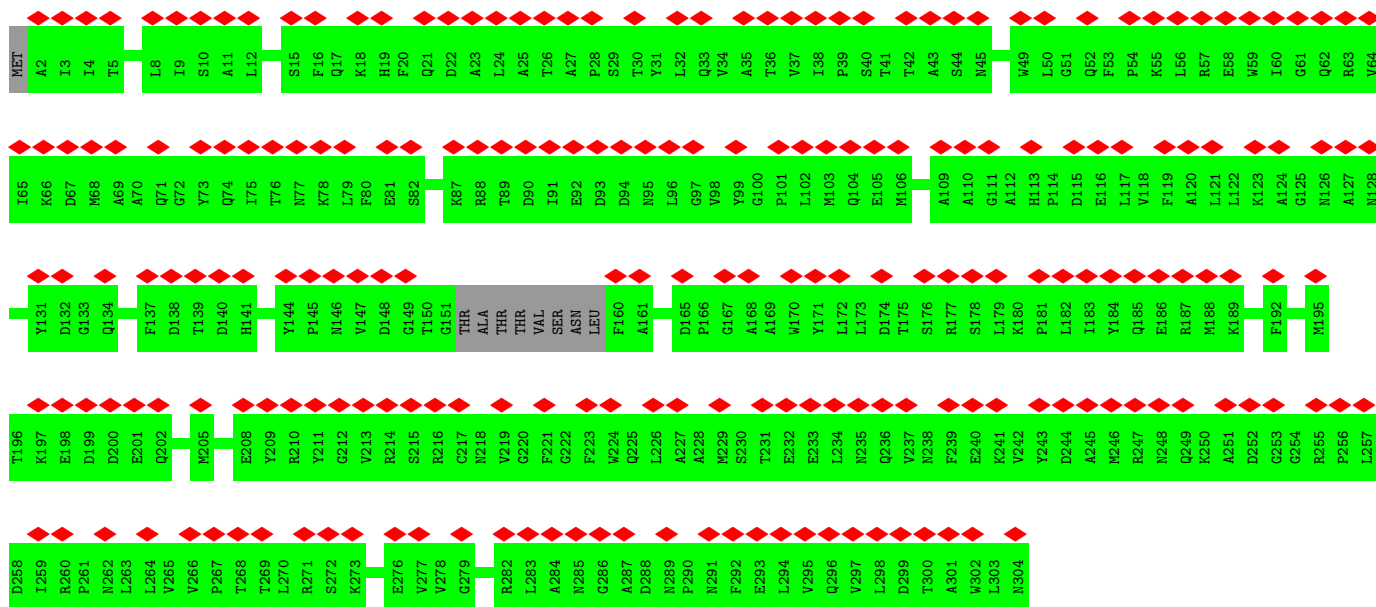

• Molecule 2: Bacteriophage Mu GpT domain-containing protein

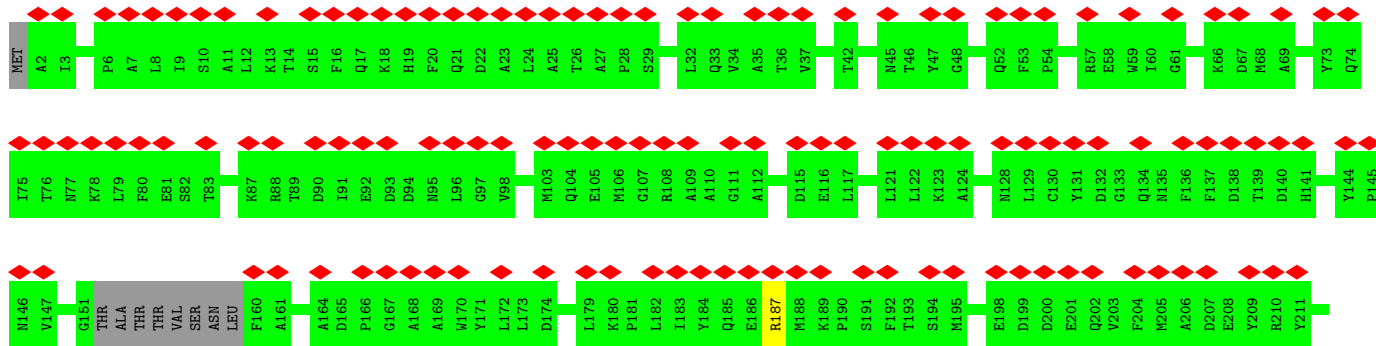

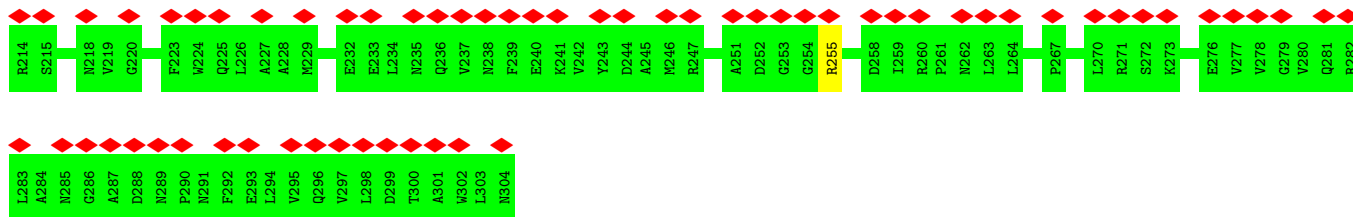

• Molecule 2: Bacteriophage Mu GpT domain-containing protein



Chain iA:

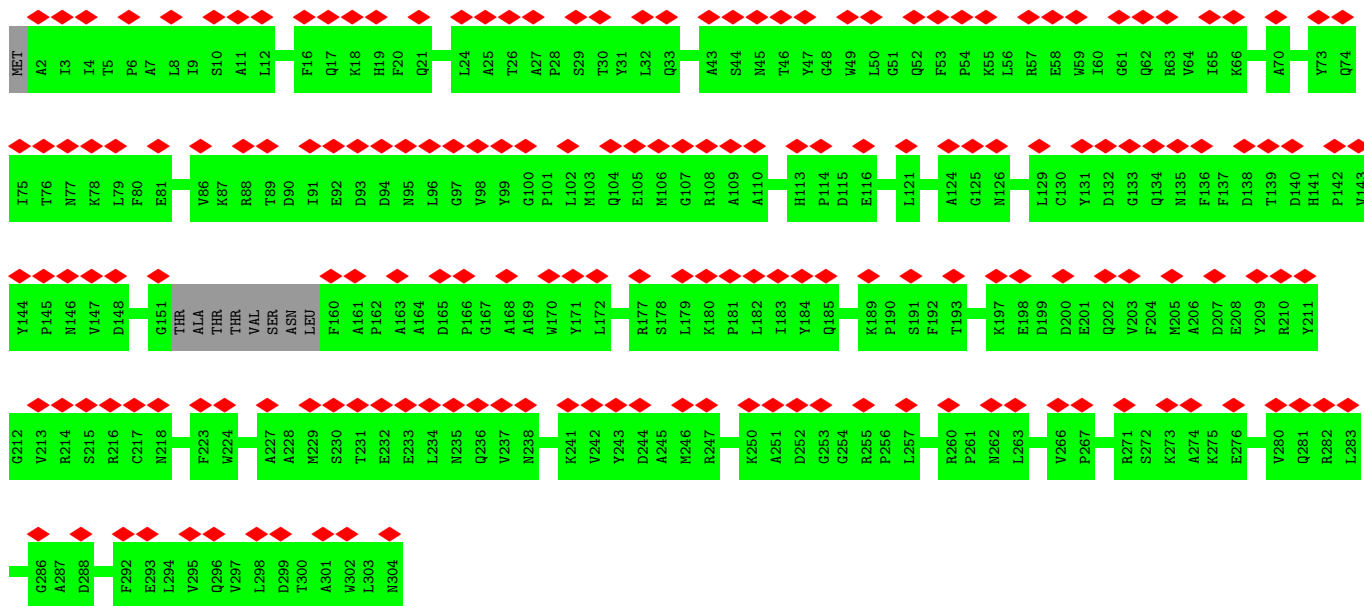

• Molecule 2: Bacteriophage Mu GpT domain-containing protein



Chain iI:

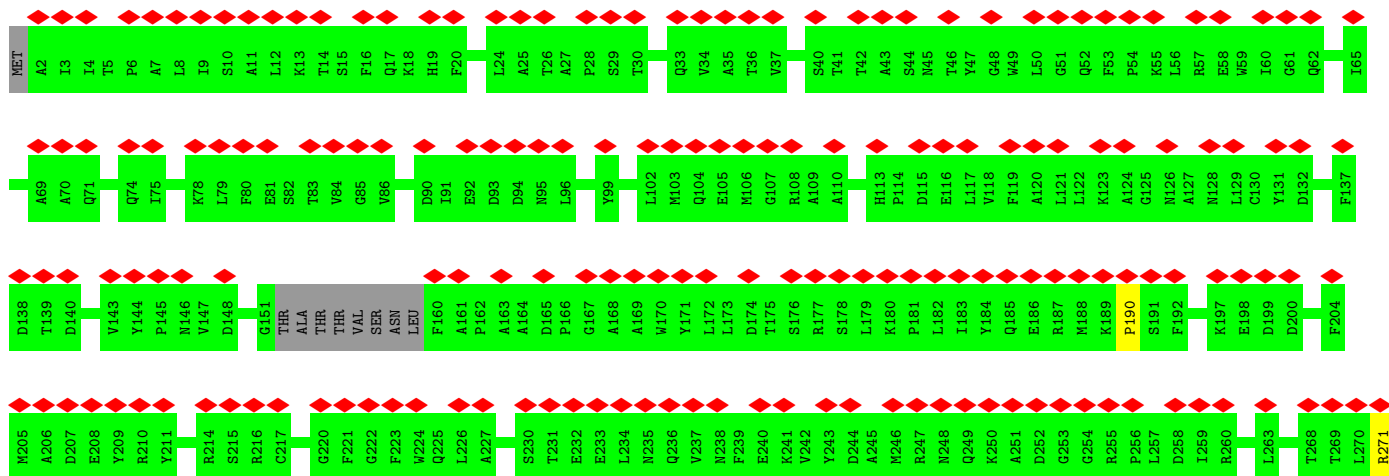

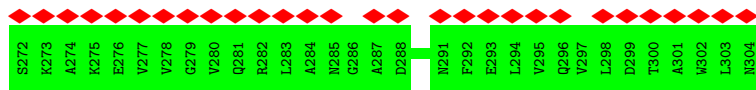

• Molecule 2: Bacteriophage Mu GpT domain-containing protein

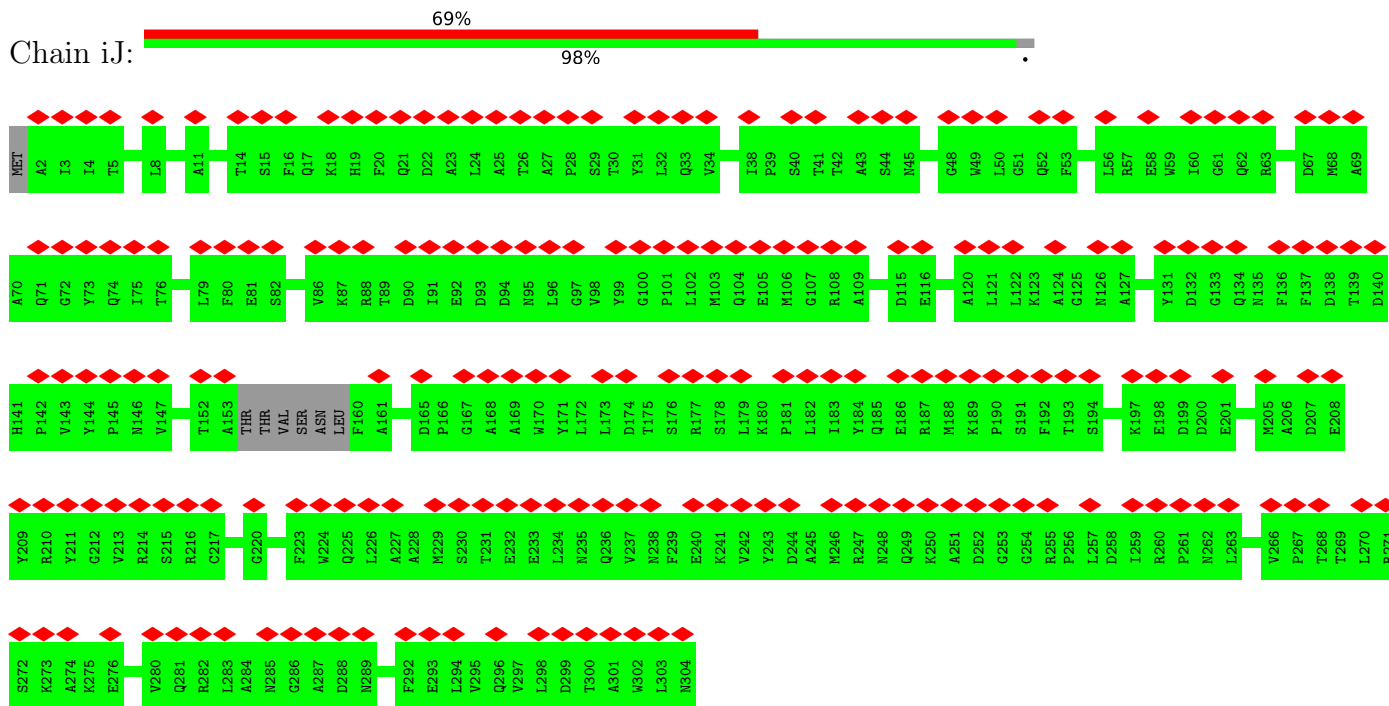

• Molecule 2: Bacteriophage Mu GpT domain-containing protein

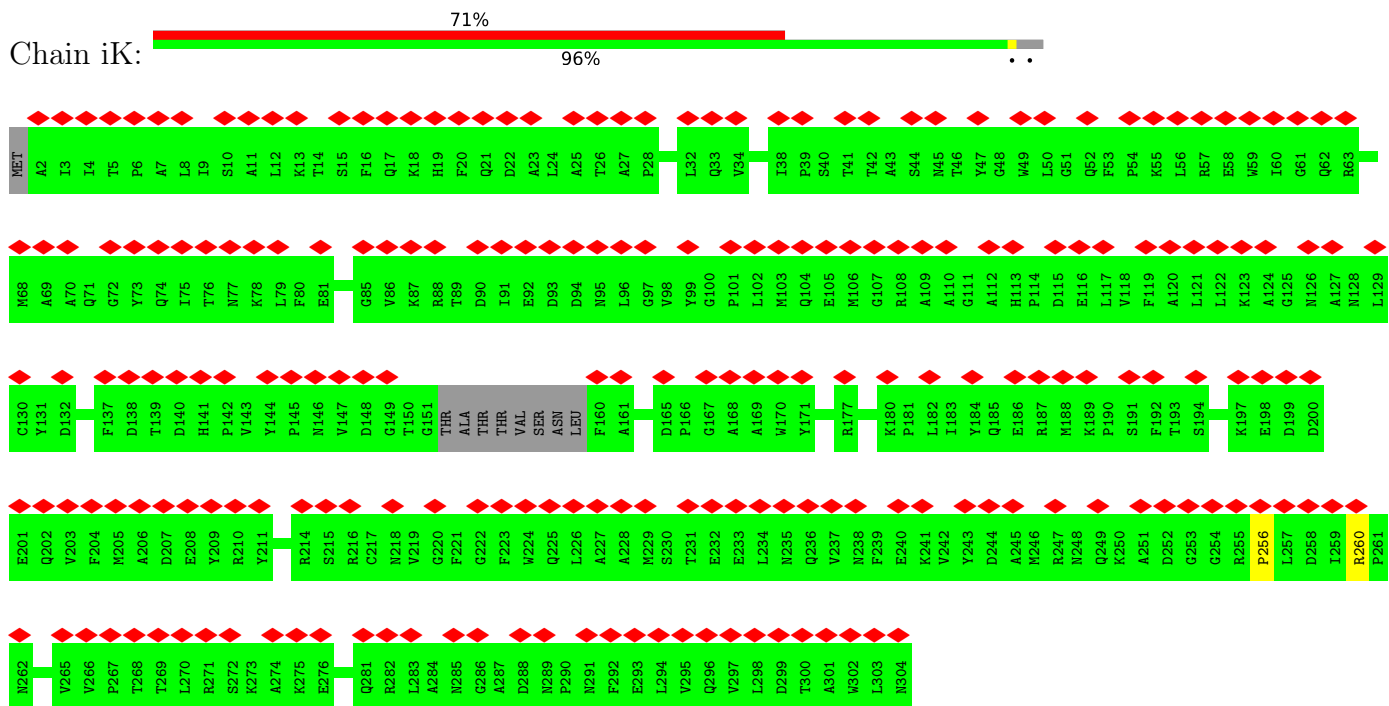

• Molecule 2: Bacteriophage Mu GpT domain-containing protein

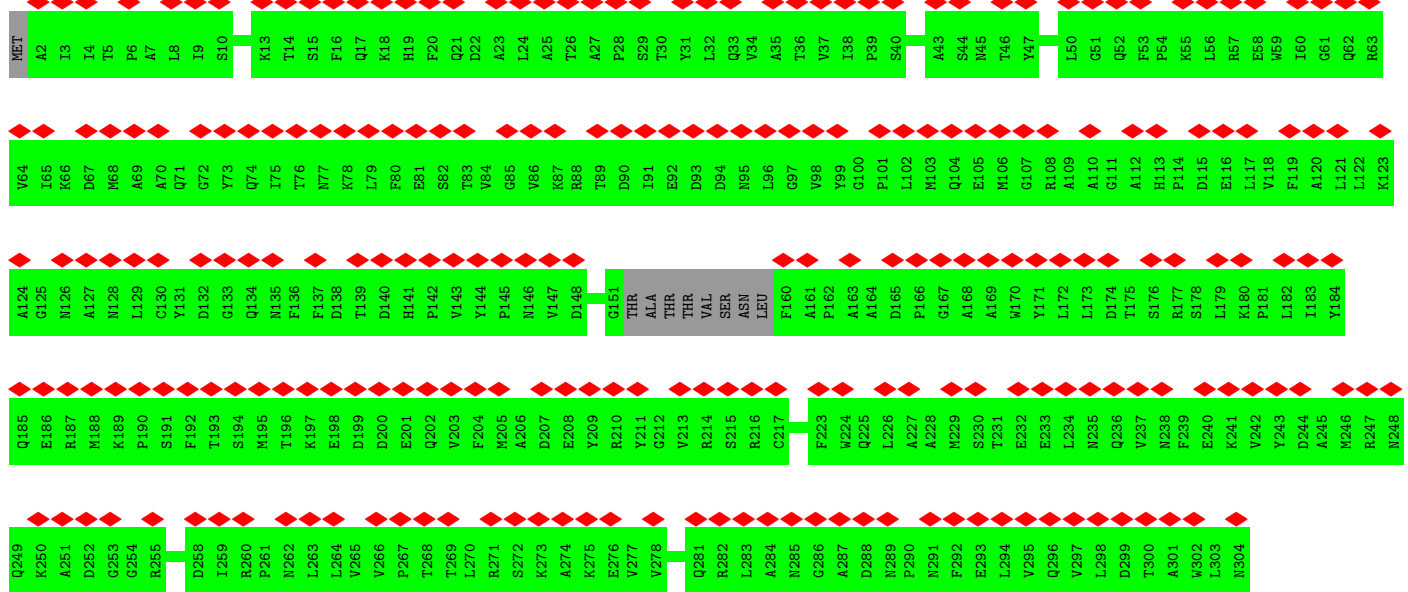
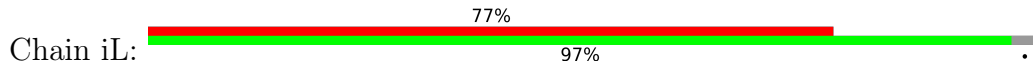

• Molecule 2: Bacteriophage Mu GpT domain-containing protein

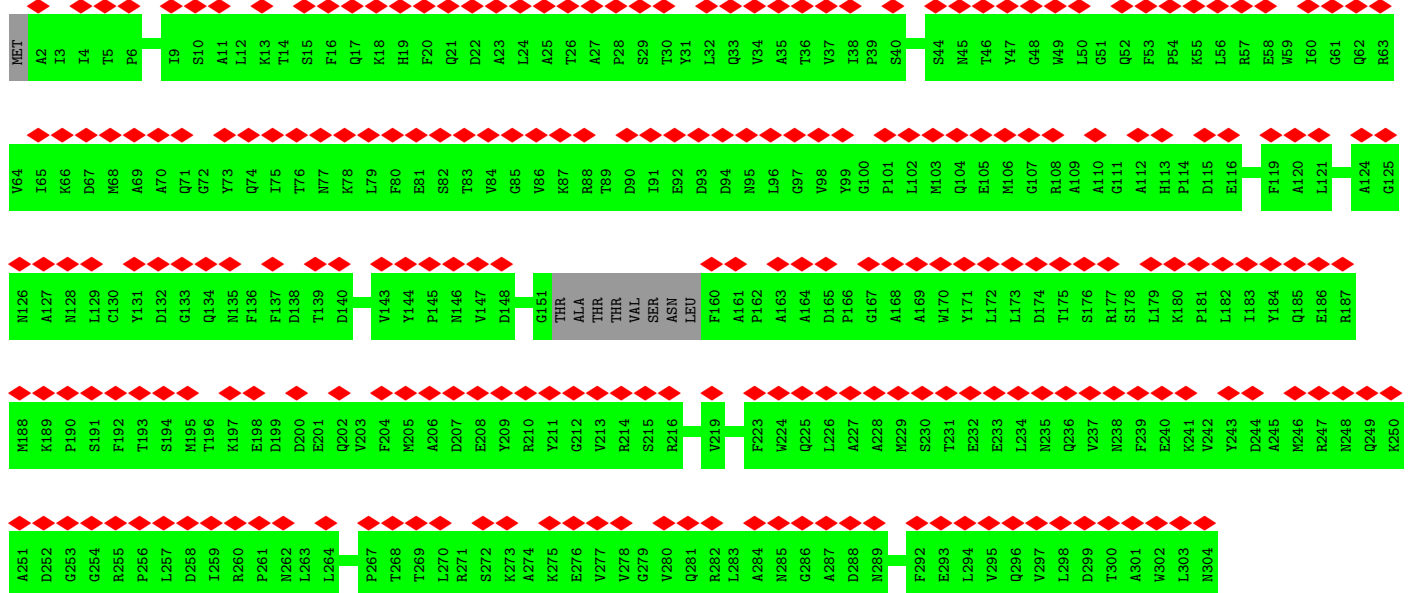
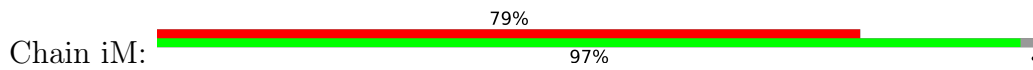

• Molecule 2: Bacteriophage Mu GpT domain-containing protein

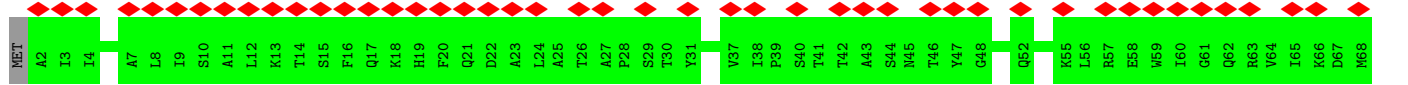
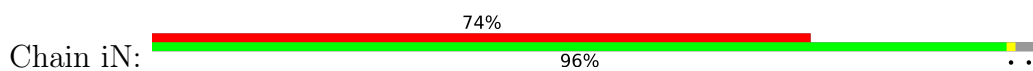



• Molecule 2: Bacteriophage Mu GpT domain-containing protein

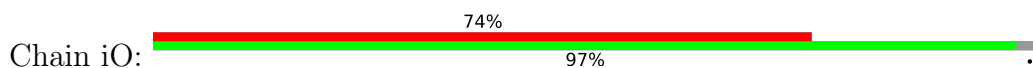

• Molecule 2: Bacteriophage Mu GpT domain-containing protein

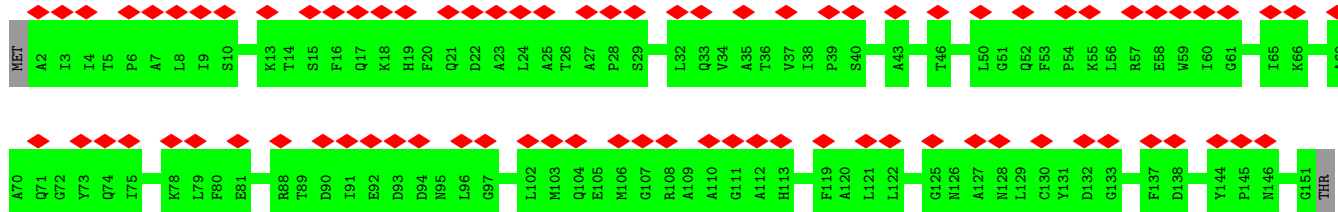

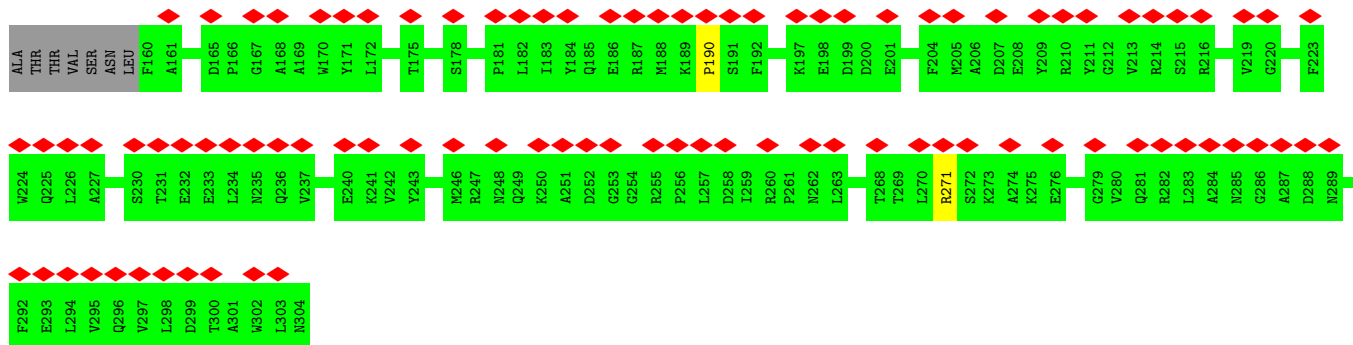

• Molecule 2: Bacteriophage Mu GpT domain-containing protein

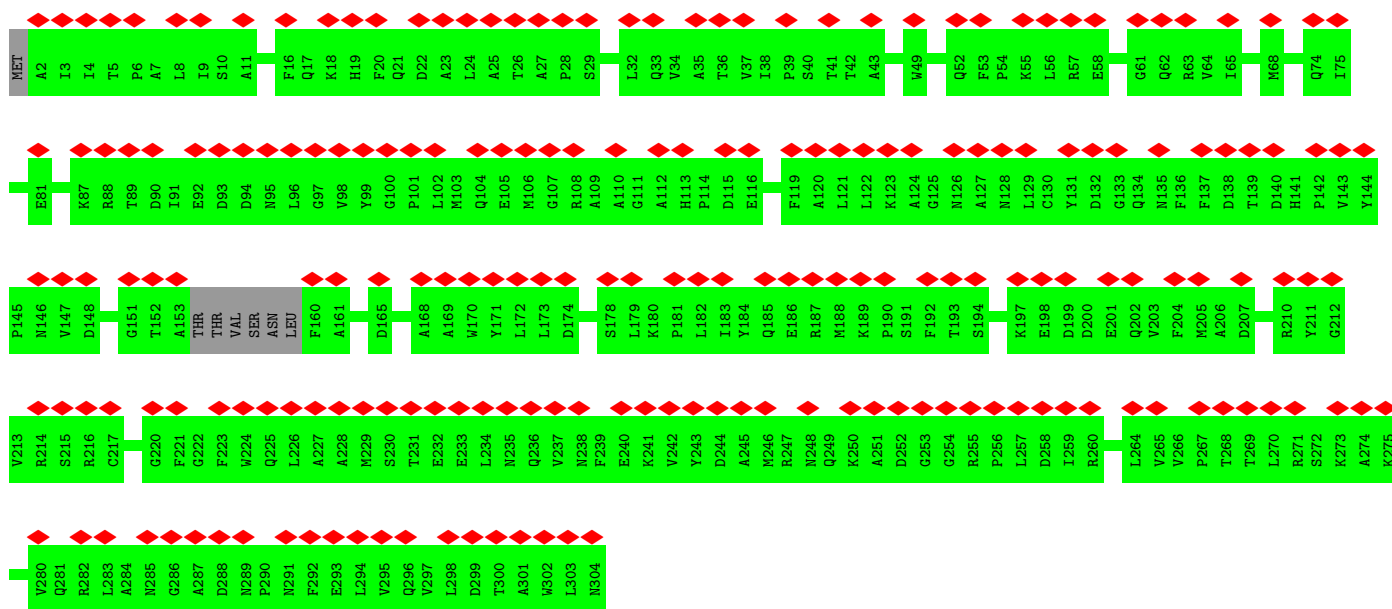

• Molecule 2: Bacteriophage Mu GpT domain-containing protein

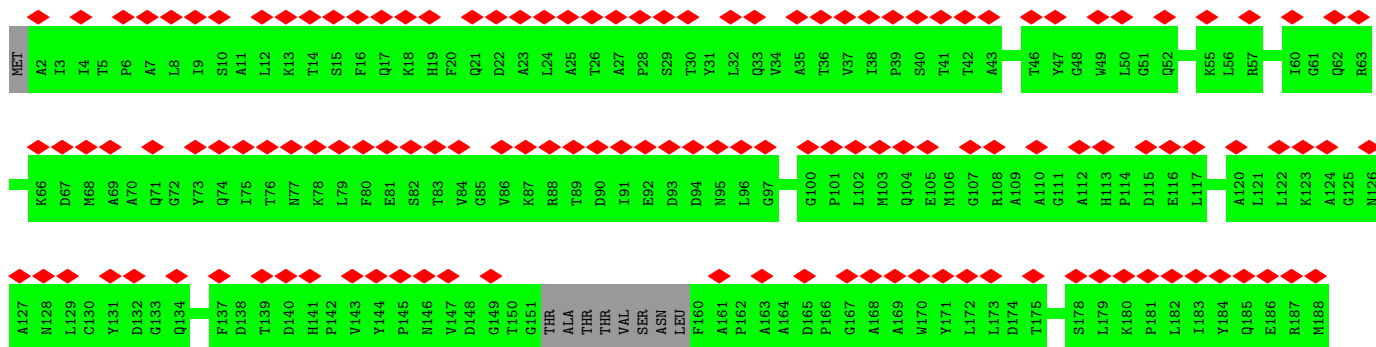

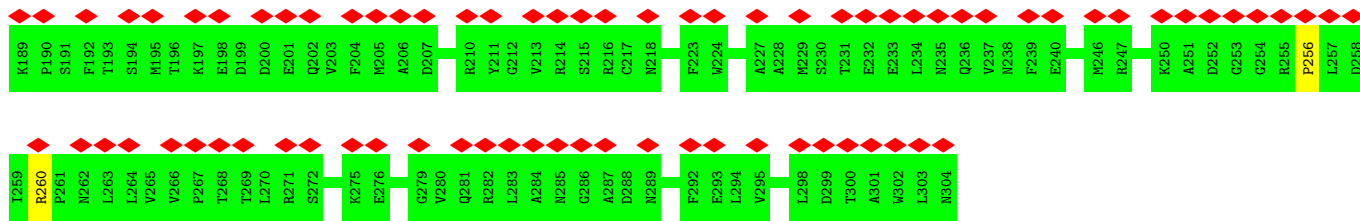

• Molecule 2: Bacteriophage Mu GpT domain-containing protein

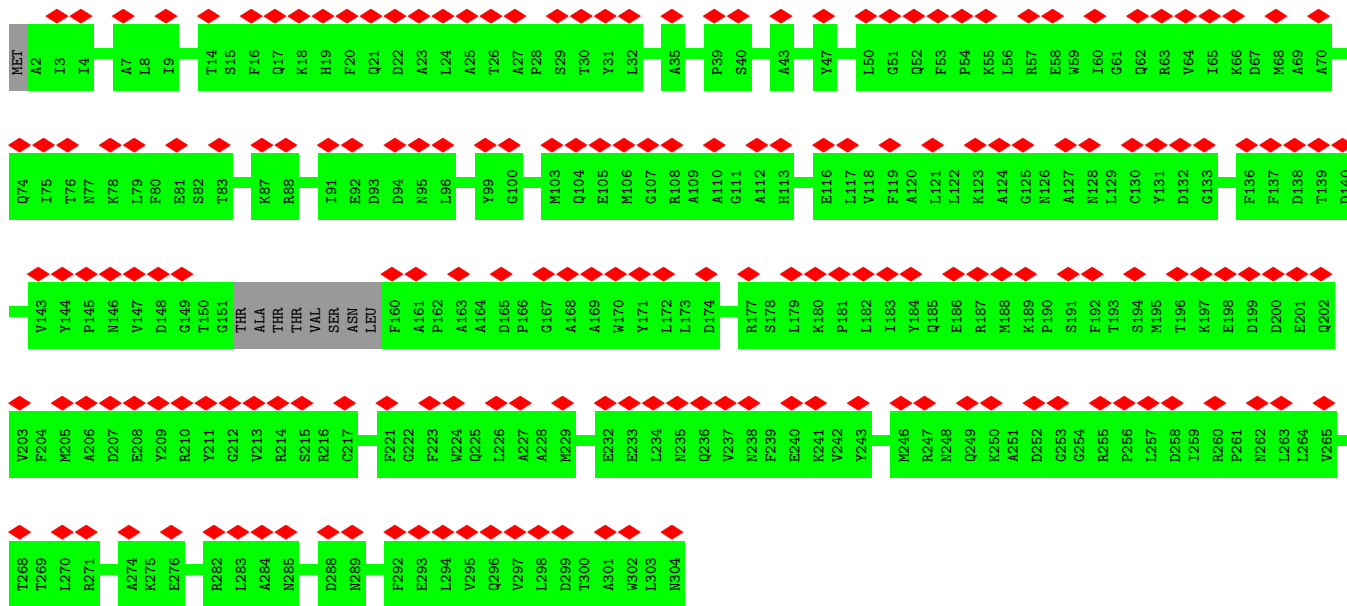

• Molecule 2: Bacteriophage Mu GpT domain-containing protein

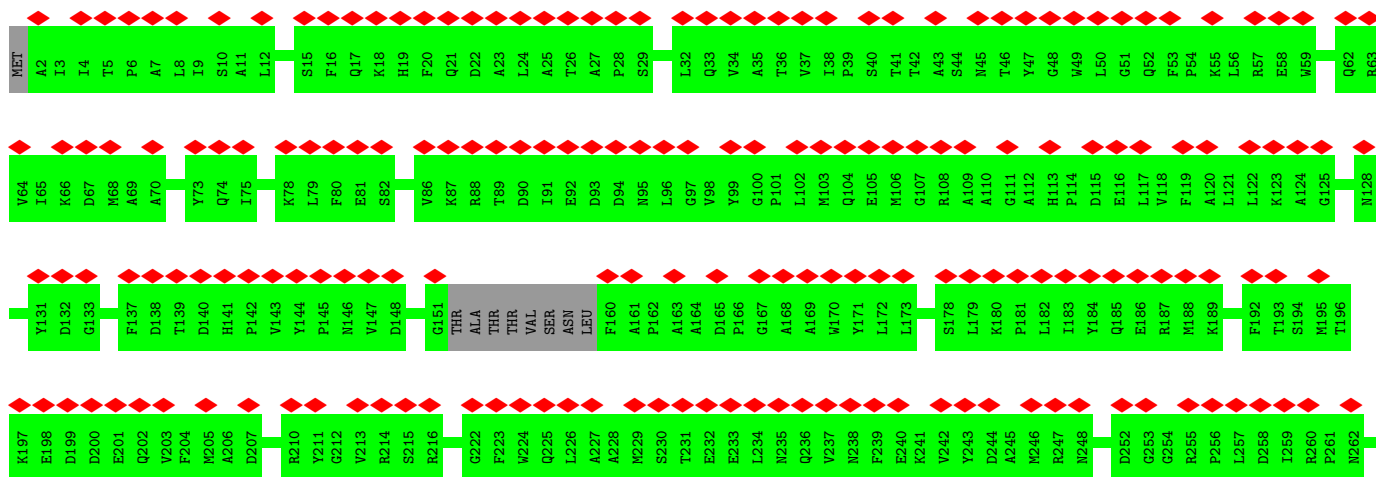

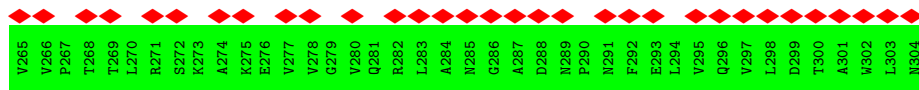

• Molecule 2: Bacteriophage Mu GpT domain-containing protein



• Molecule 2: Bacteriophage Mu GpT domain-containing protein

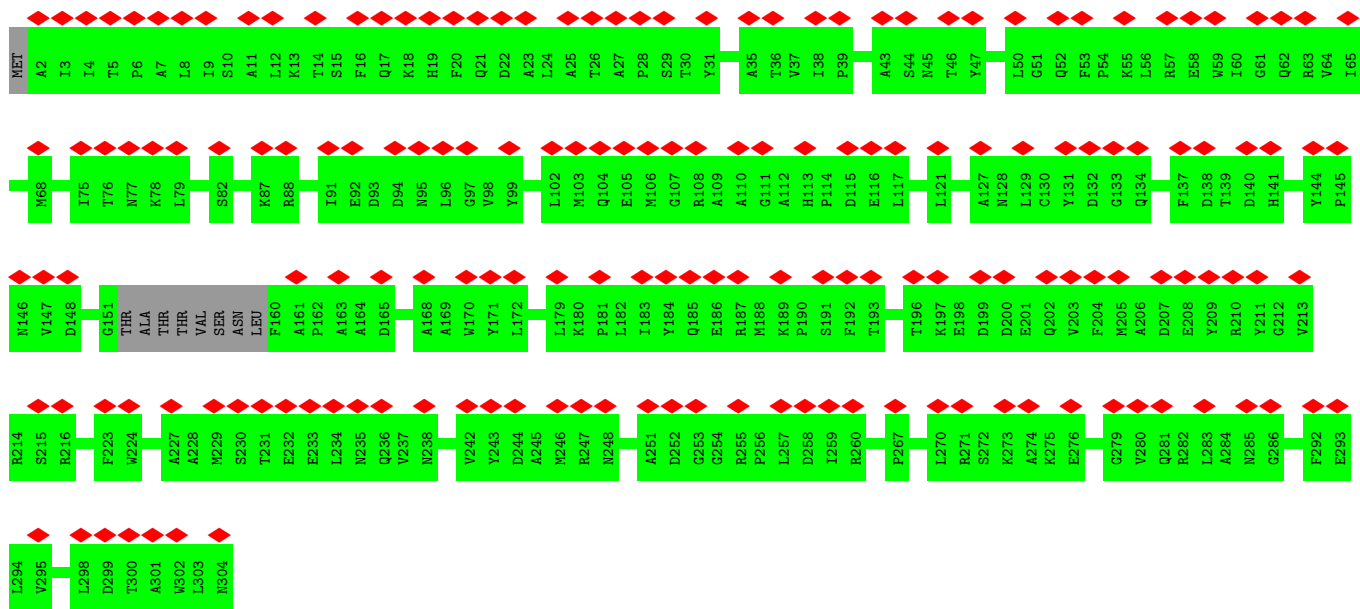

• Molecule 2: Bacteriophage Mu GpT domain-containing protein

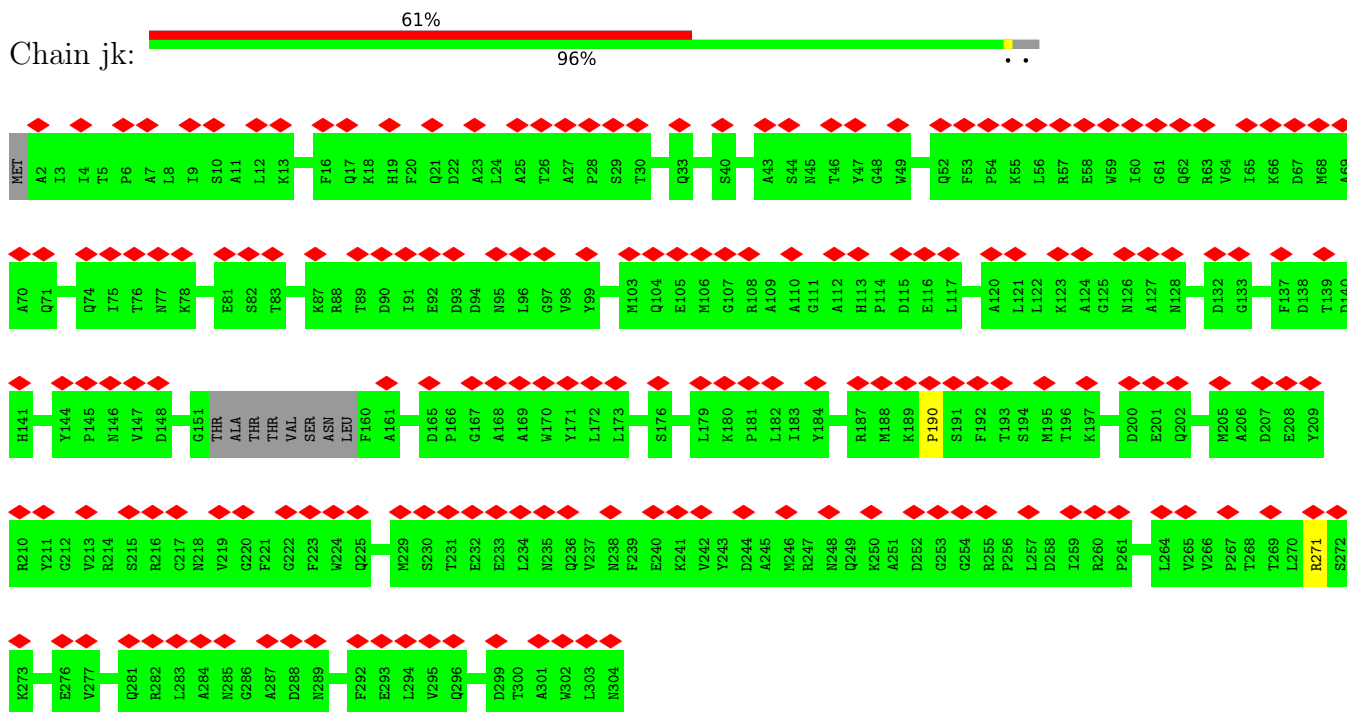

• Molecule 2: Bacteriophage Mu GpT domain-containing protein

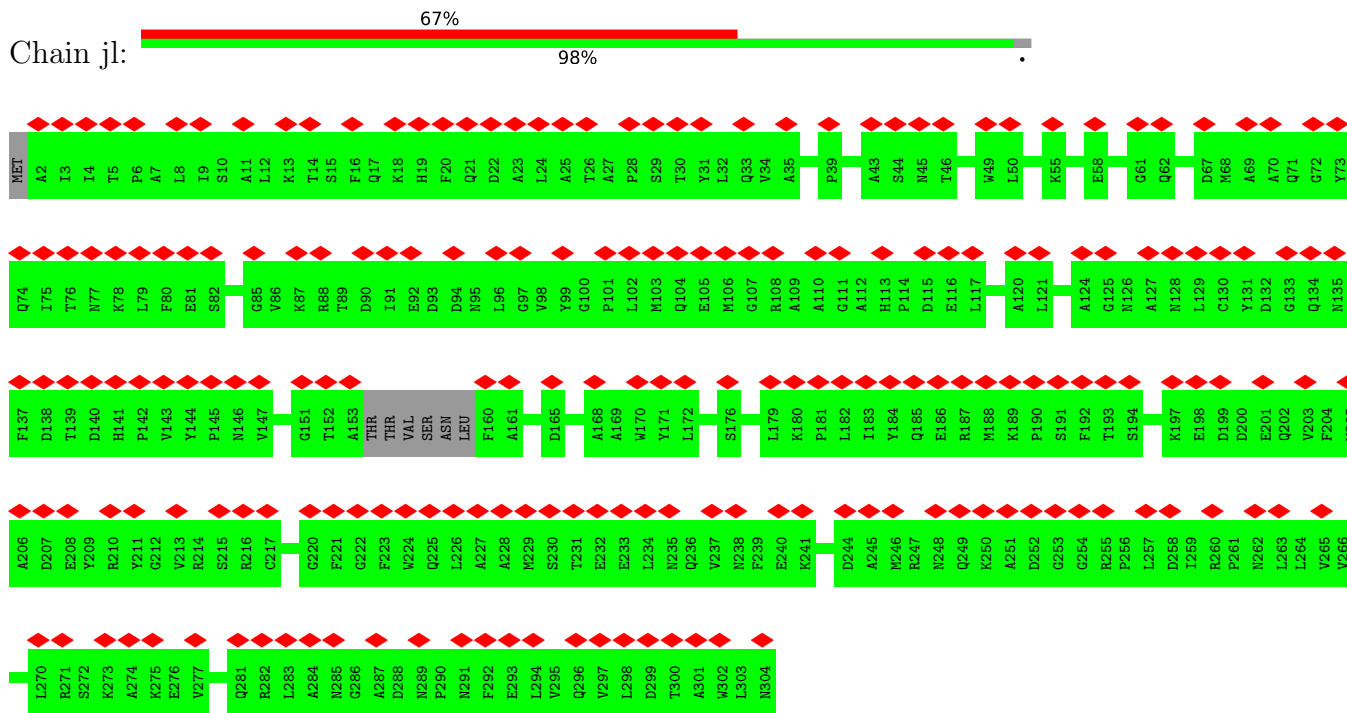

• Molecule 2: Bacteriophage Mu GpT domain-containing protein

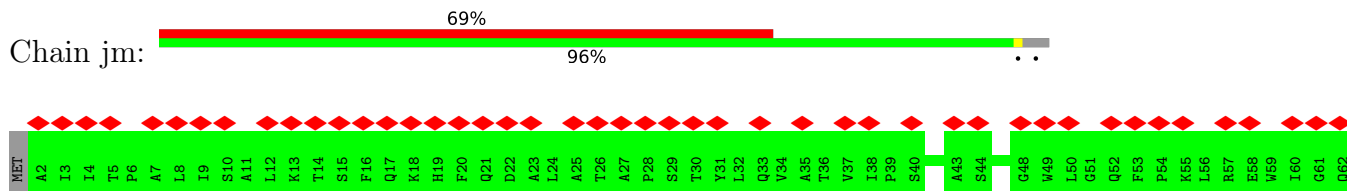

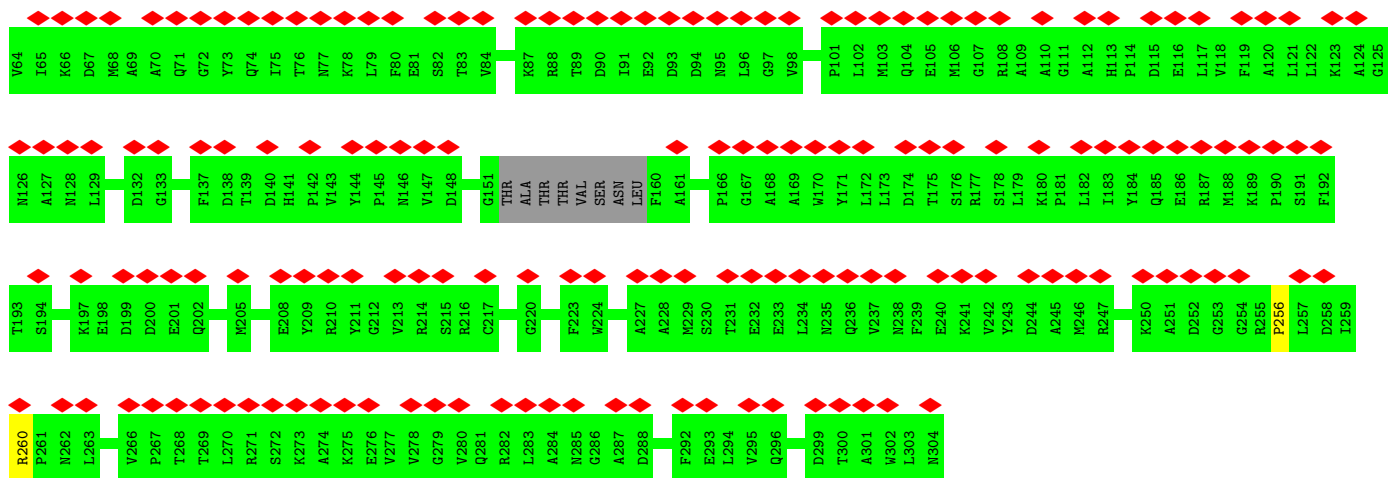

• Molecule 2: Bacteriophage Mu GpT domain-containing protein

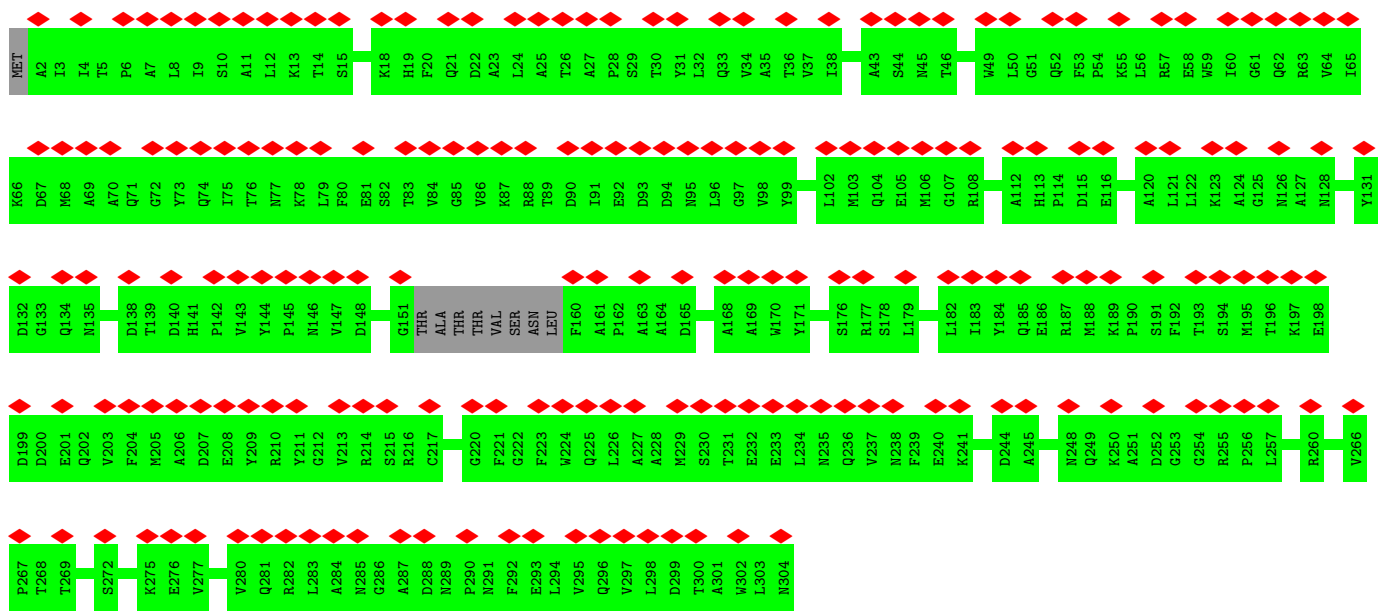

• Molecule 2: Bacteriophage Mu GpT domain-containing protein



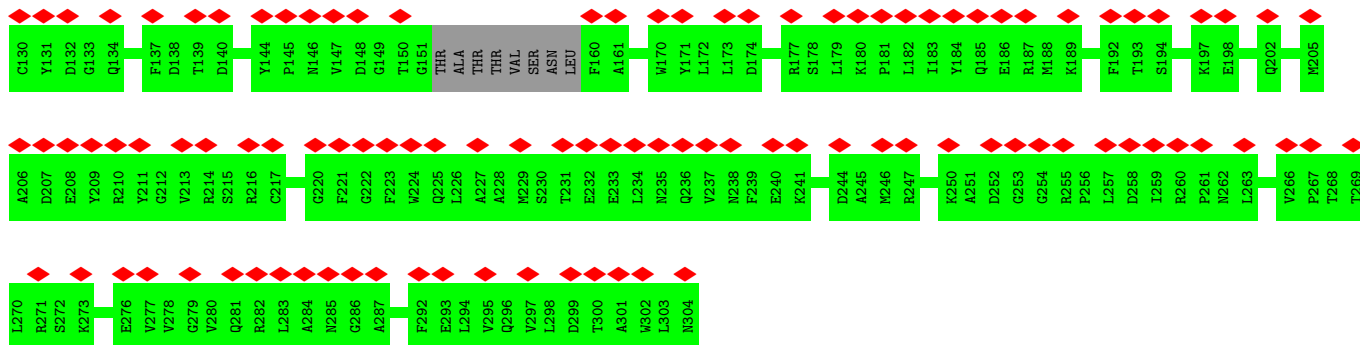

• Molecule 2: Bacteriophage Mu GpT domain-containing protein



• Molecule 2: Bacteriophage Mu GpT domain-containing protein

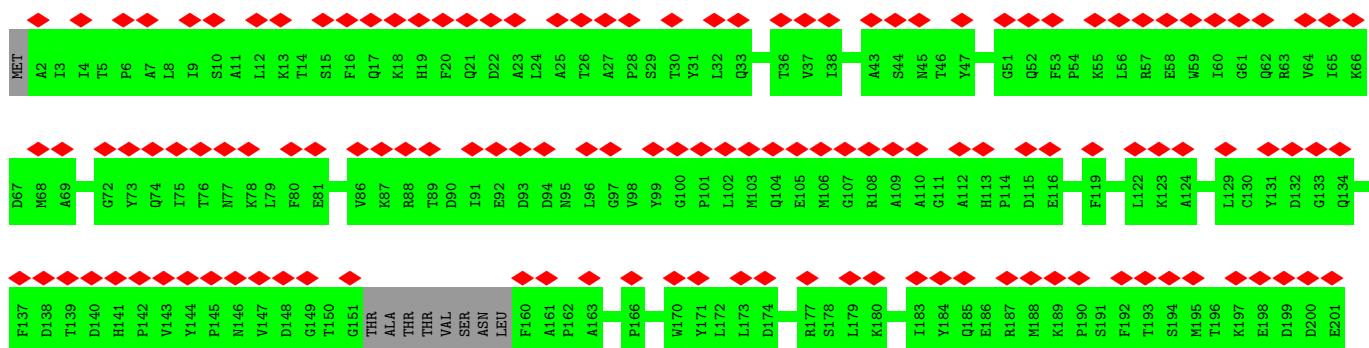

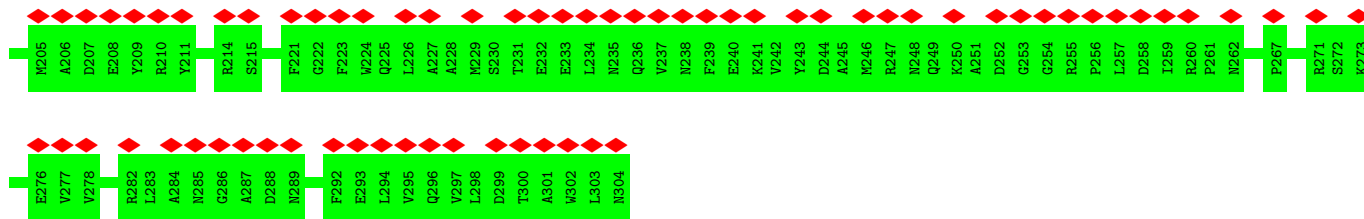

• Molecule 2: Bacteriophage Mu GpT domain-containing protein

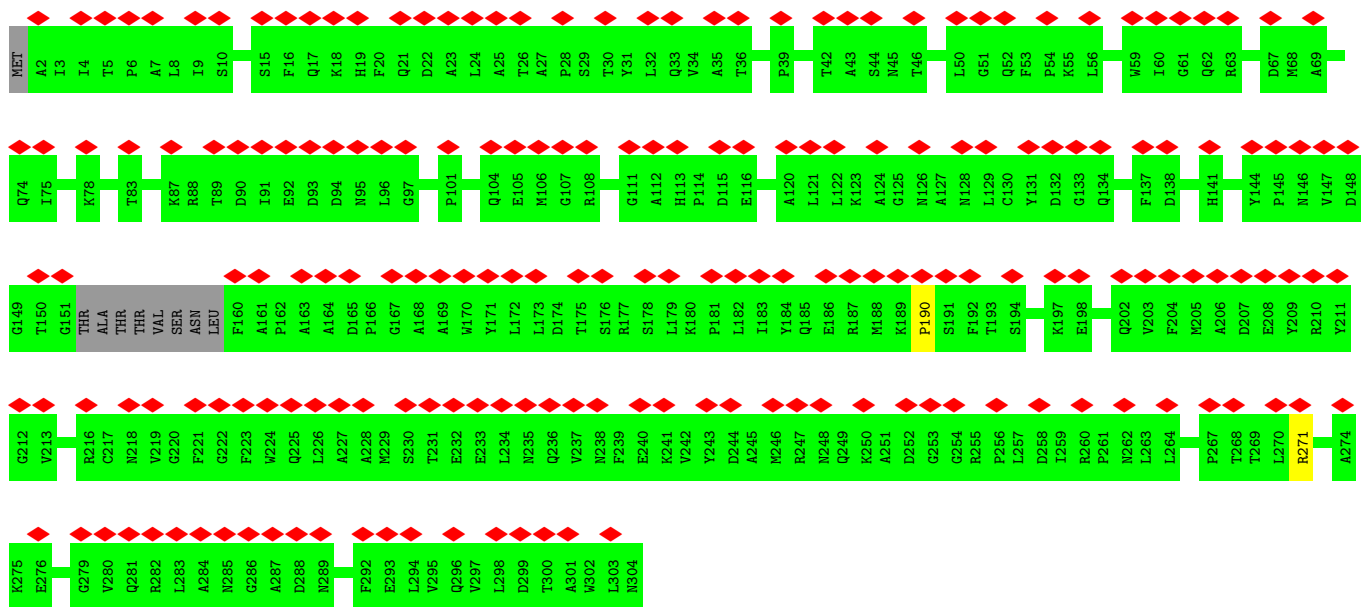

• Molecule 2: Bacteriophage Mu GpT domain-containing protein

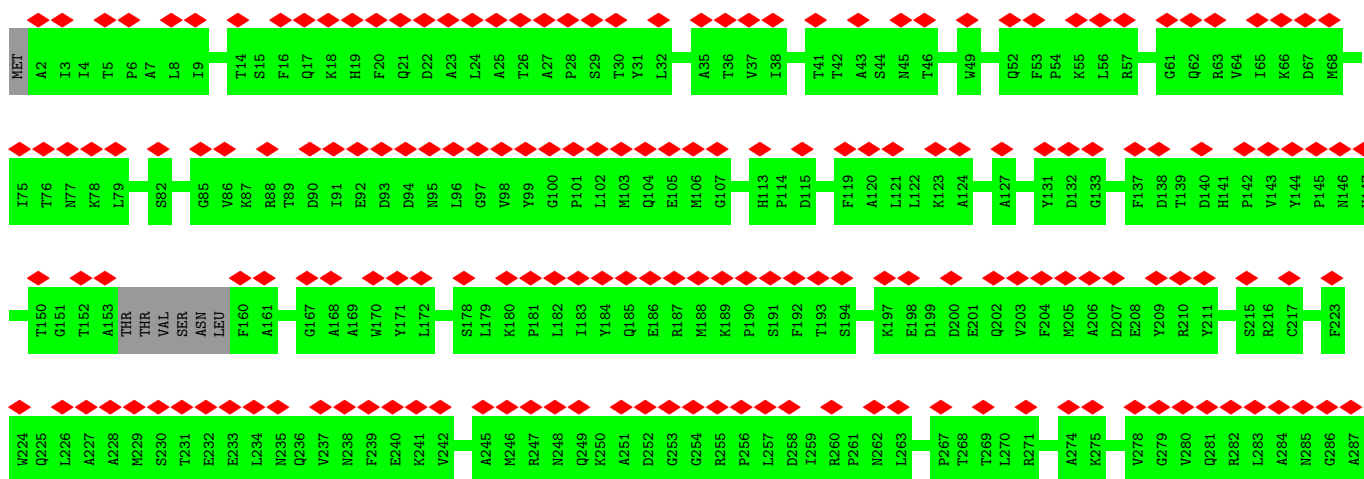

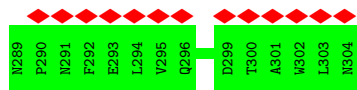

• Molecule 2: Bacteriophage Mu GpT domain-containing protein

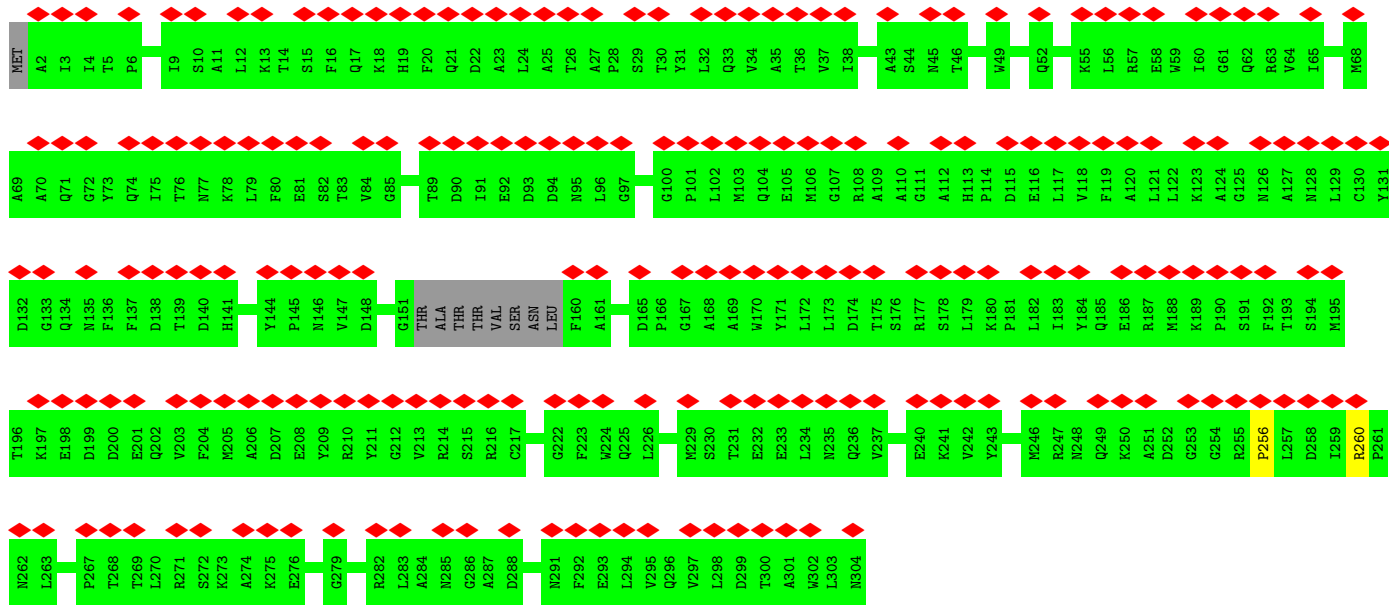

• Molecule 2: Bacteriophage Mu GpT domain-containing protein



• Molecule 2: Bacteriophage Mu GpT domain-containing protein



Chain jC:

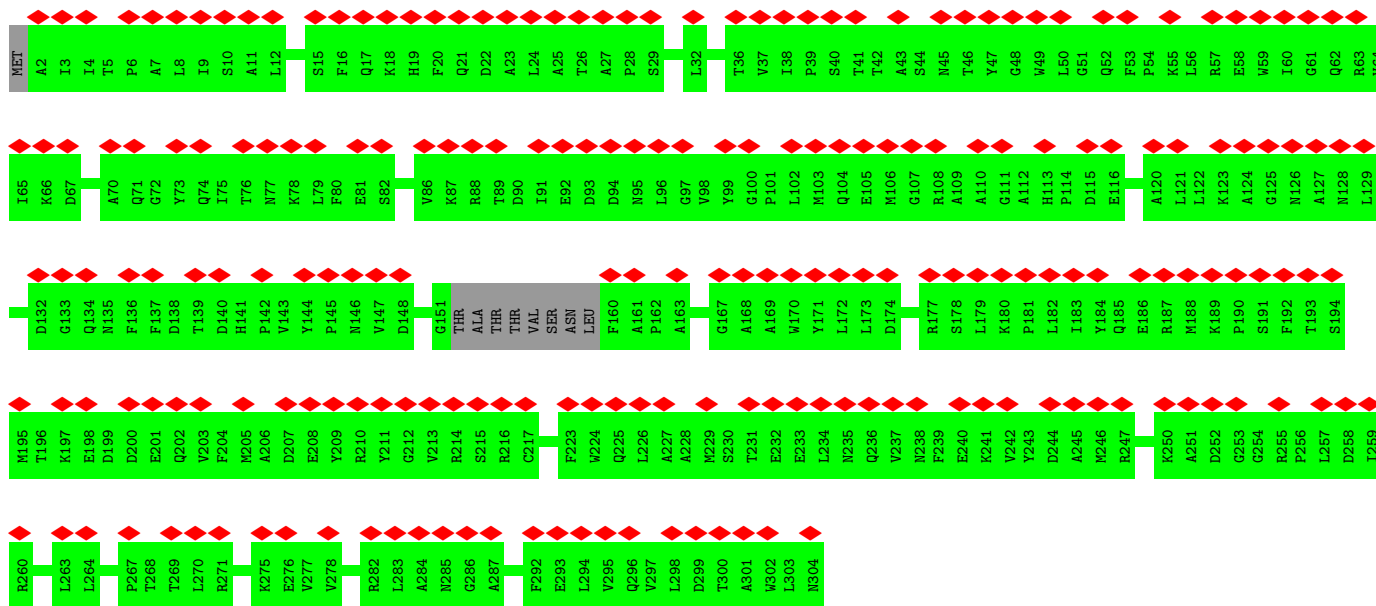

• Molecule 2: Bacteriophage Mu GpT domain-containing protein



Chain jD:



• Molecule 2: Bacteriophage Mu GpT domain-containing protein



Chain jE:

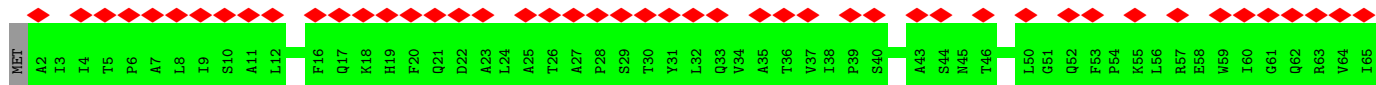

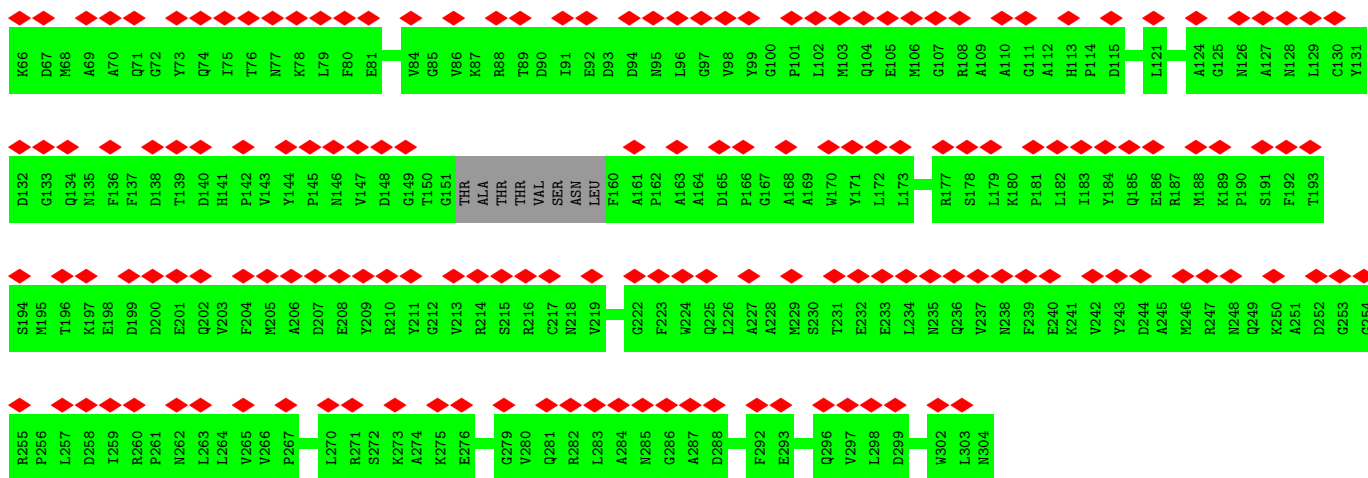

● Molecule 2: Bacteriophage Mu GpT domain-containing protein

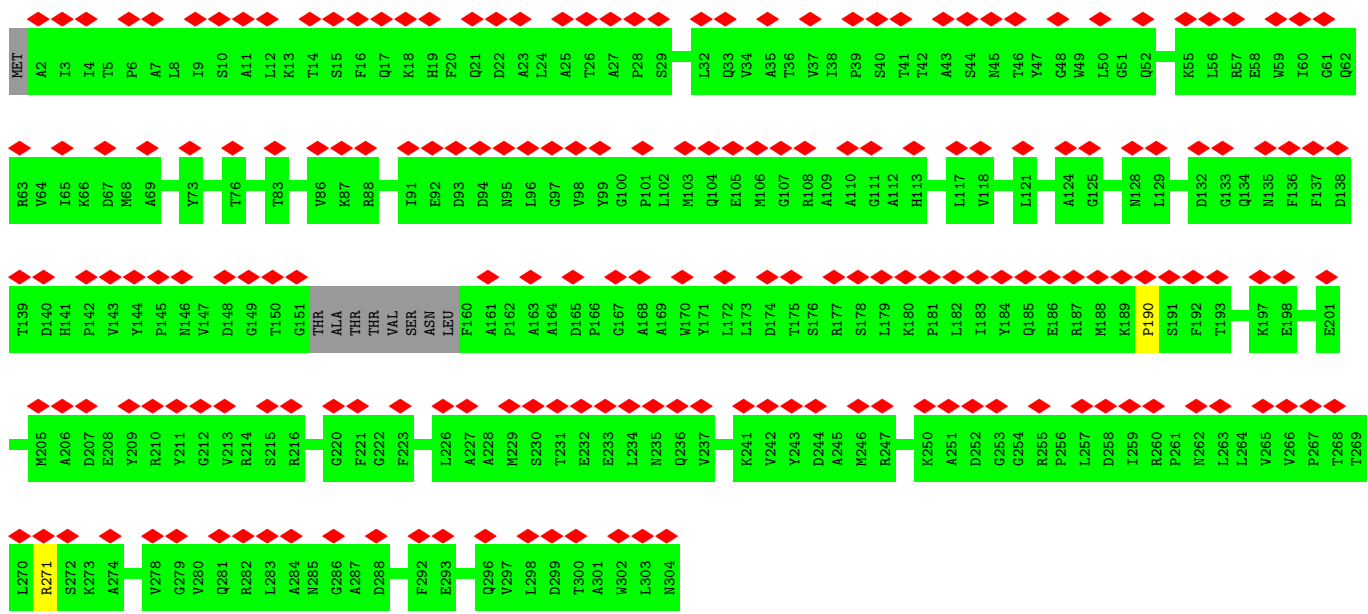

● Molecule 2: Bacteriophage Mu GpT domain-containing protein

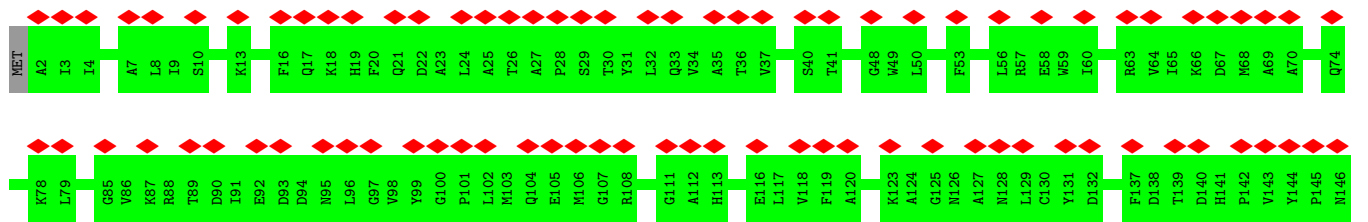

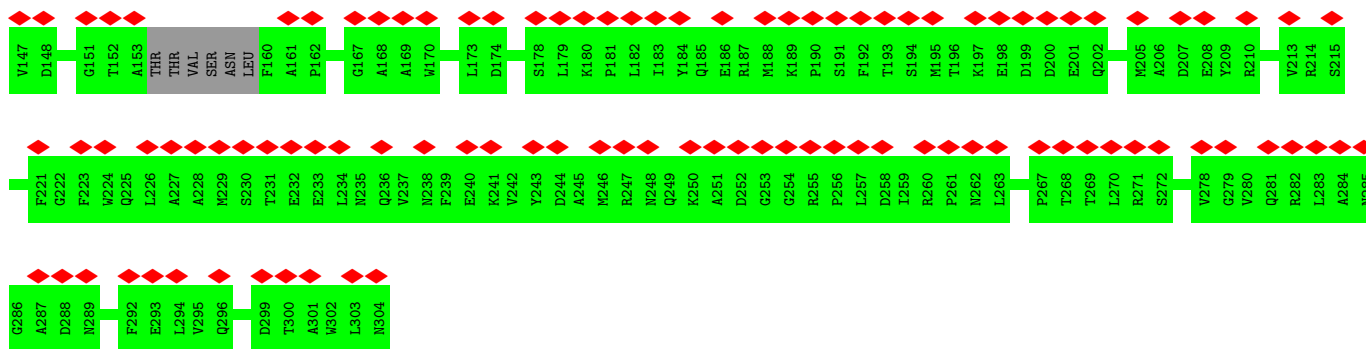

• Molecule 2: Bacteriophage Mu GpT domain-containing protein



• Molecule 2: Bacteriophage Mu GpT domain-containing protein

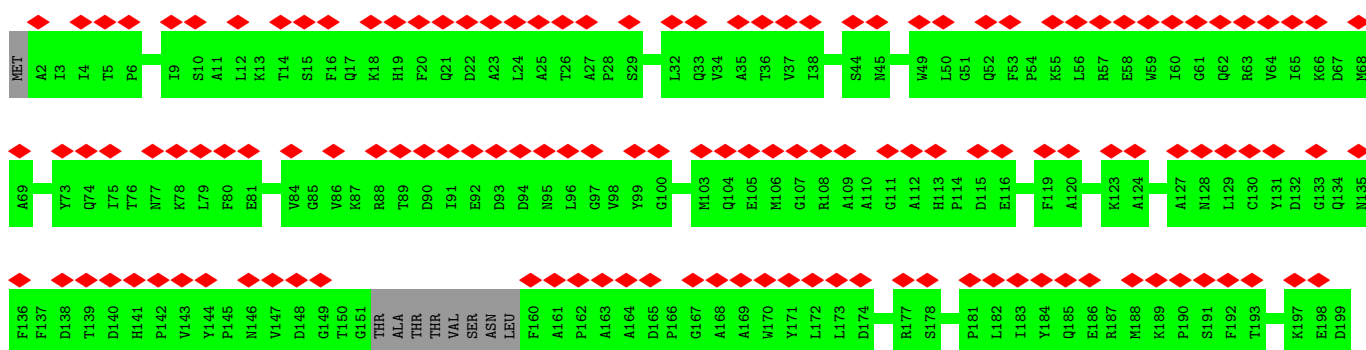

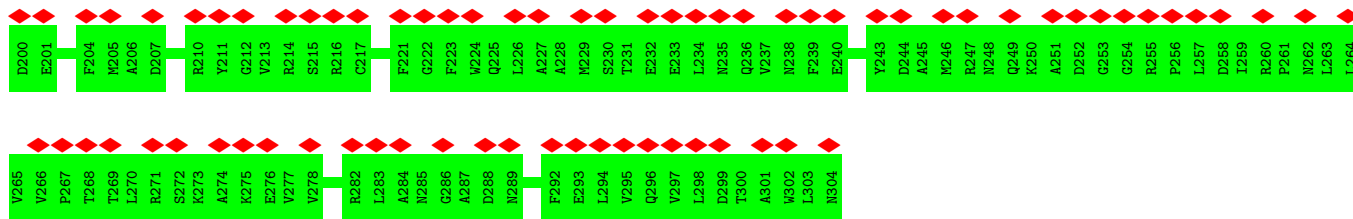

• Molecule 2: Bacteriophage Mu GpT domain-containing protein

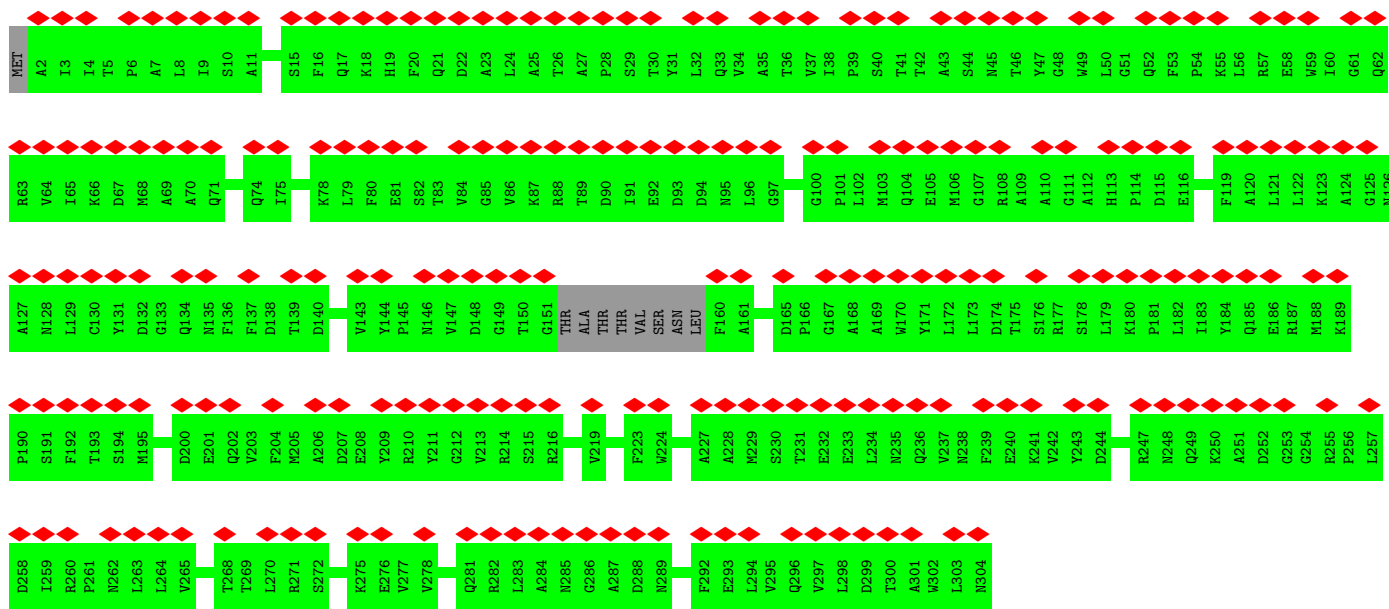
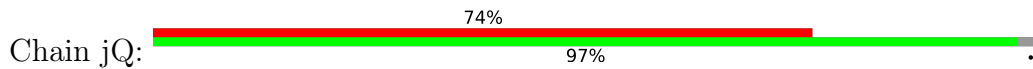

• Molecule 2: Bacteriophage Mu GpT domain-containing protein

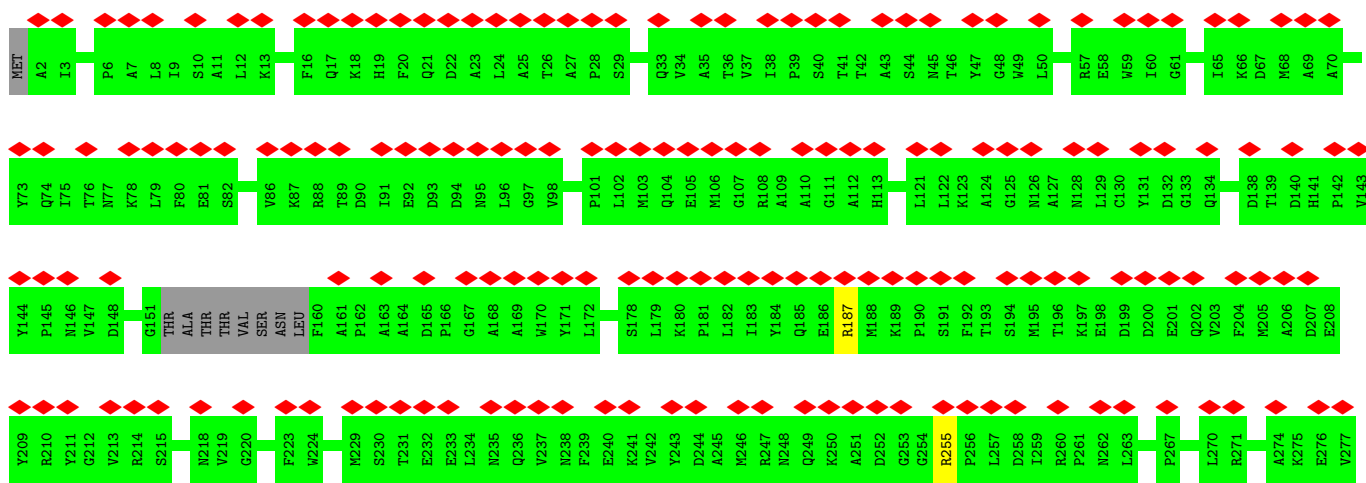

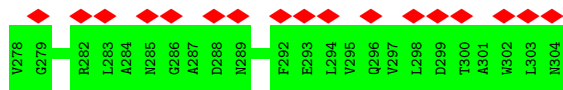

• Molecule 2: Bacteriophage Mu GpT domain-containing protein



• Molecule 2: Bacteriophage Mu GpT domain-containing protein



• Molecule 2: Bacteriophage Mu GpT domain-containing protein

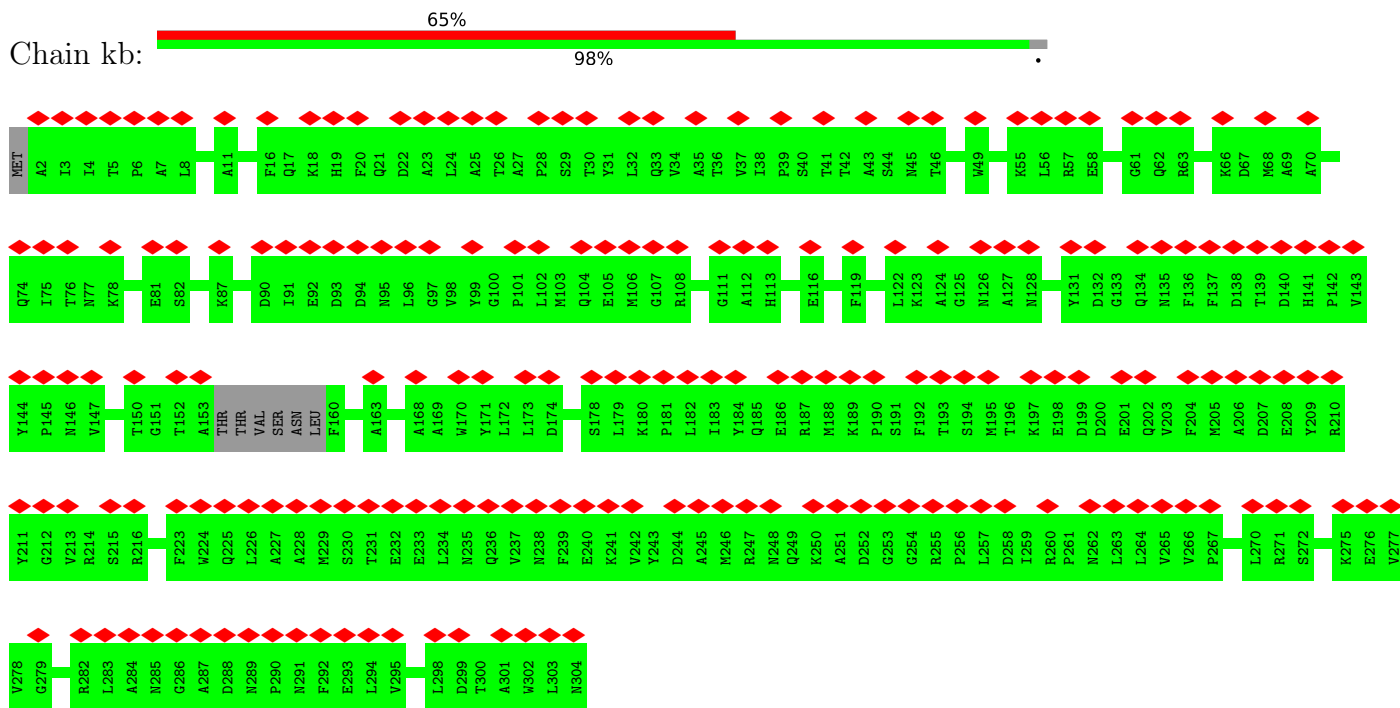

• Molecule 2: Bacteriophage Mu GpT domain-containing protein

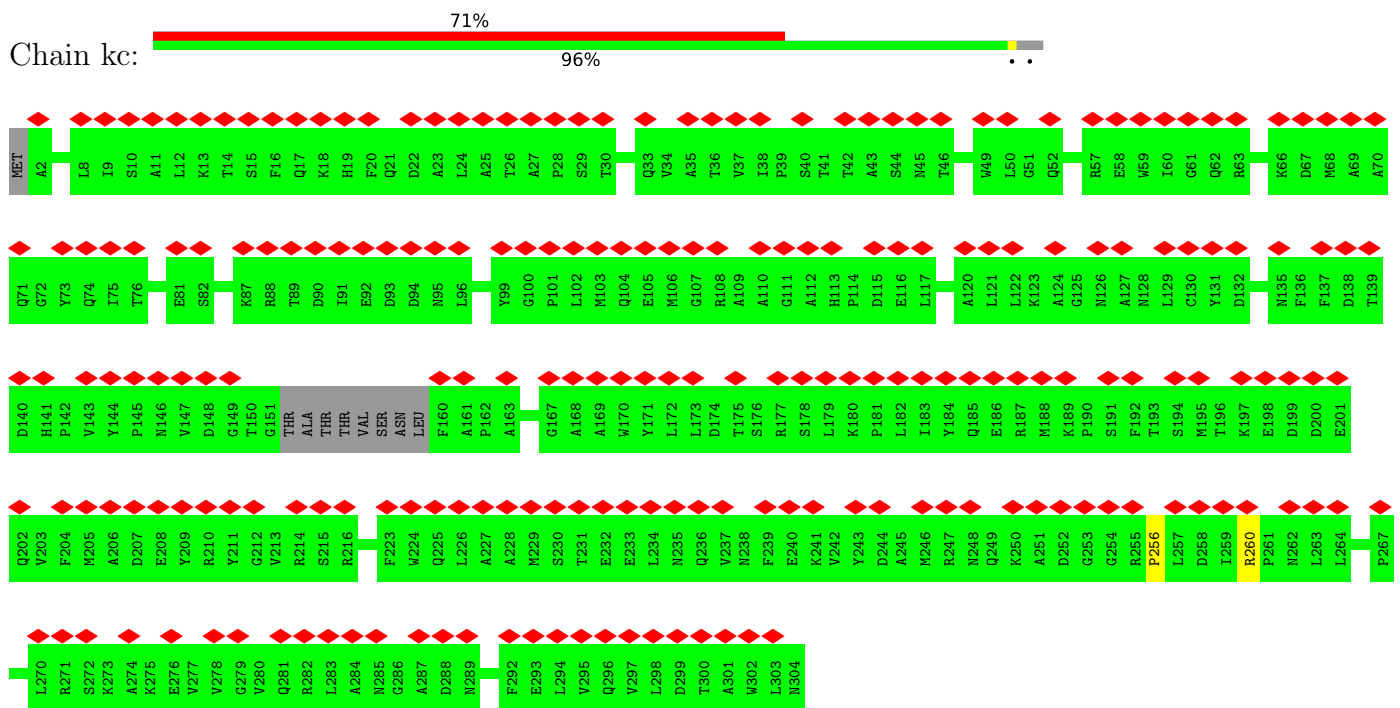

• Molecule 2: Bacteriophage Mu GpT domain-containing protein

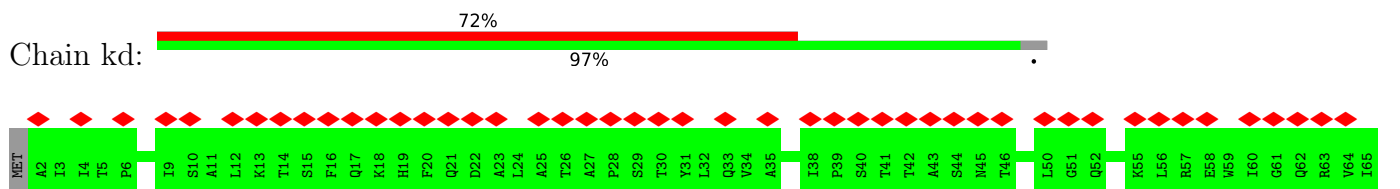

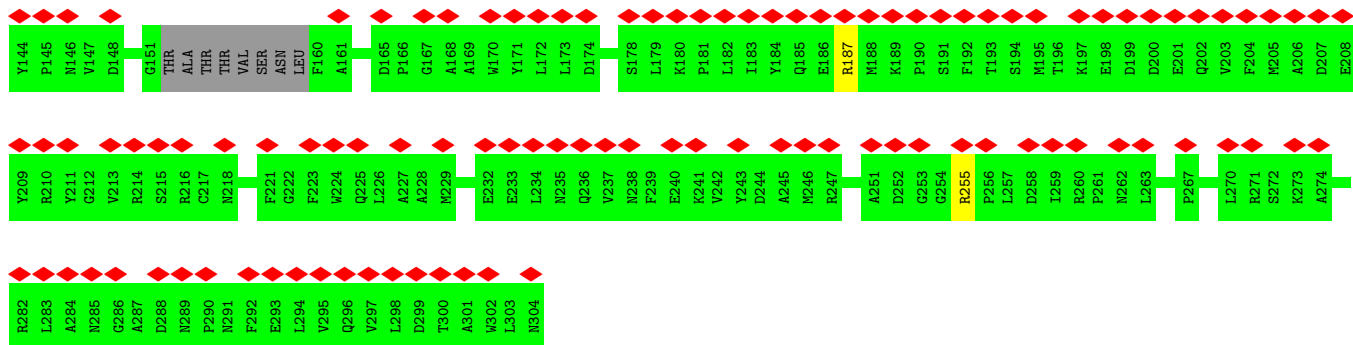

• Molecule 2: Bacteriophage Mu GpT domain-containing protein



• Molecule 2: Bacteriophage Mu GpT domain-containing protein

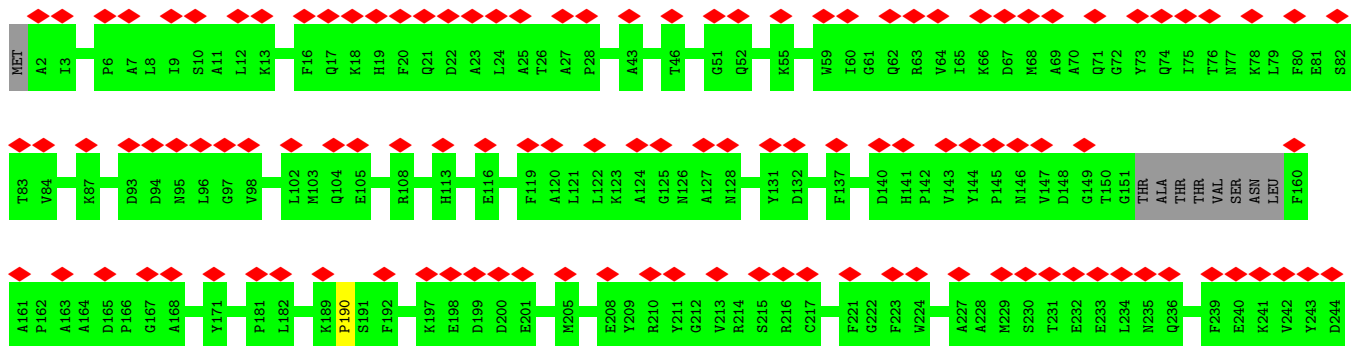

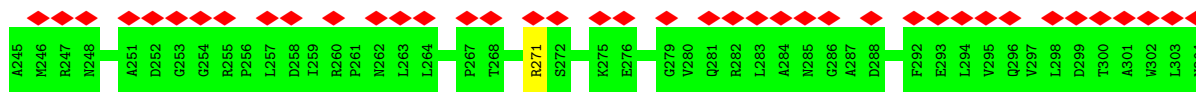

• Molecule 2: Bacteriophage Mu GpT domain-containing protein

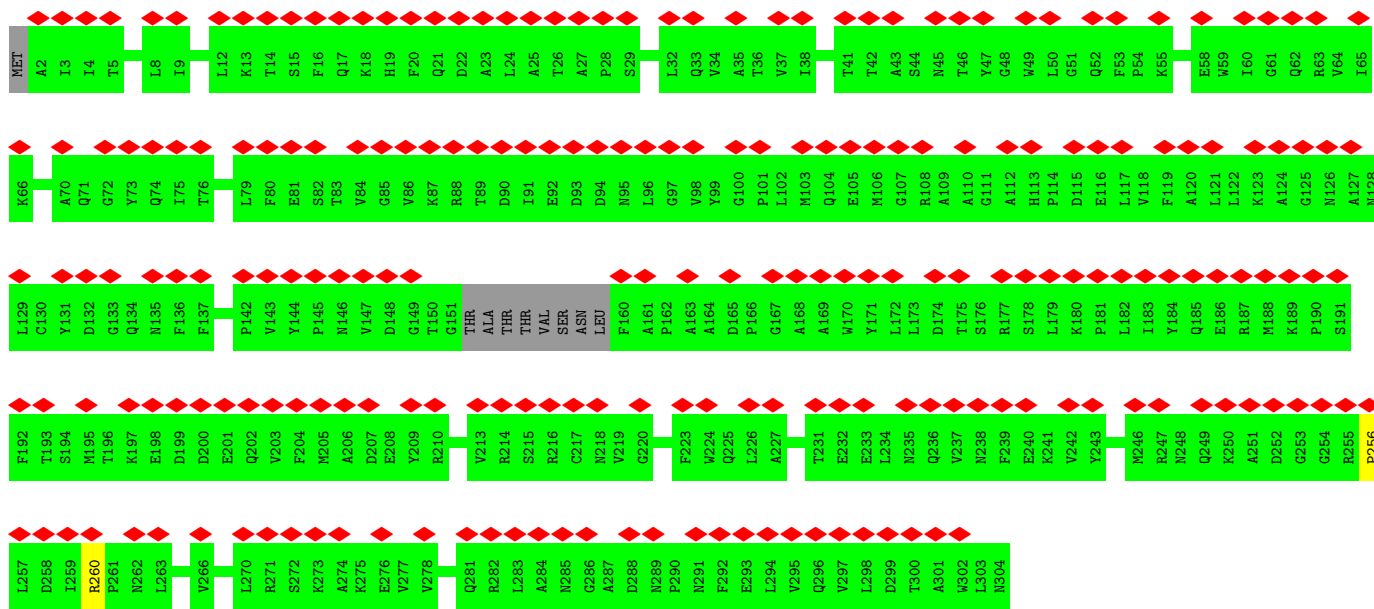
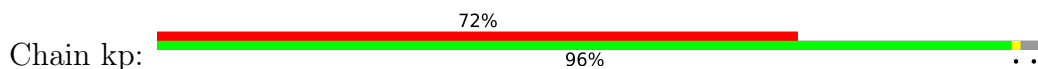

• Molecule 2: Bacteriophage Mu GpT domain-containing protein

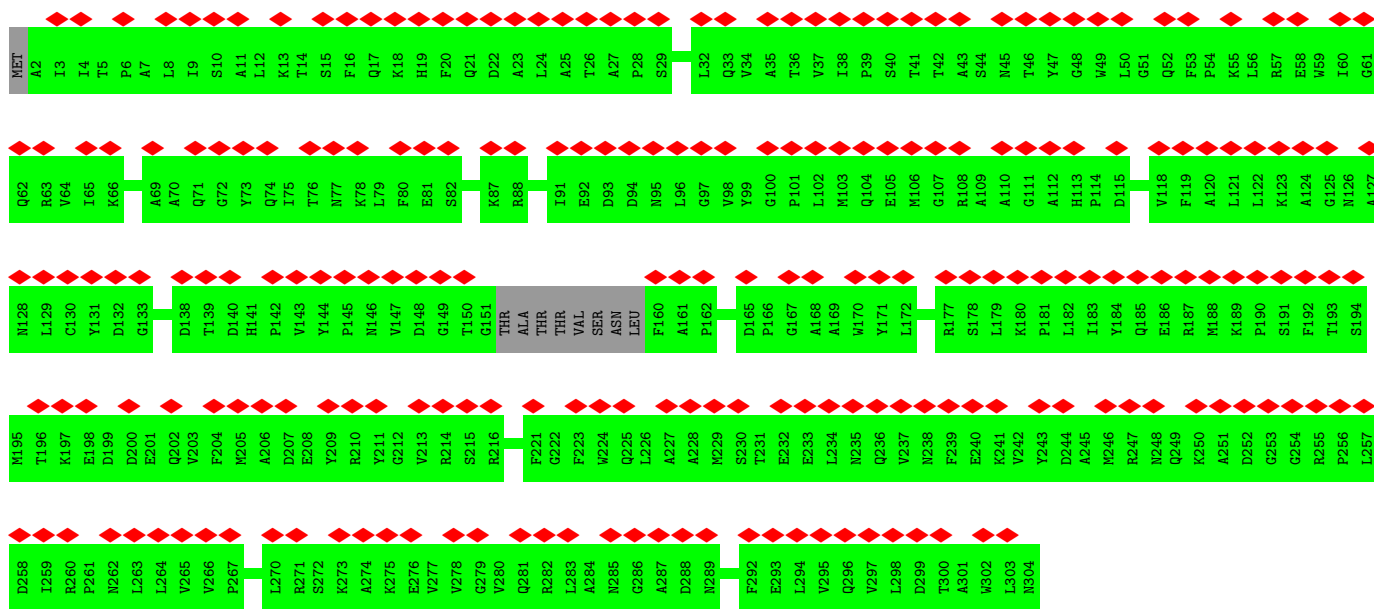
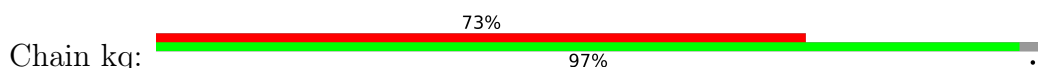

• Molecule 2: Bacteriophage Mu GpT domain-containing protein

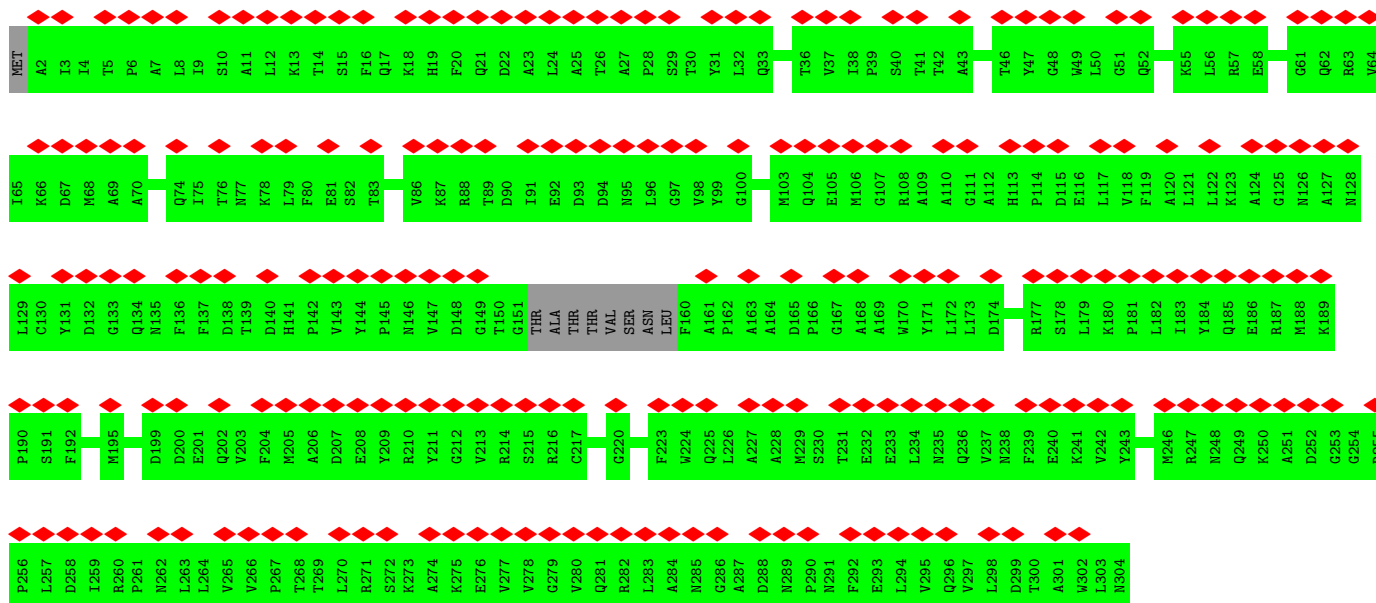
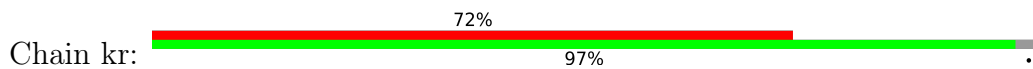

• Molecule 2: Bacteriophage Mu GpT domain-containing protein



• Molecule 2: Bacteriophage Mu GpT domain-containing protein

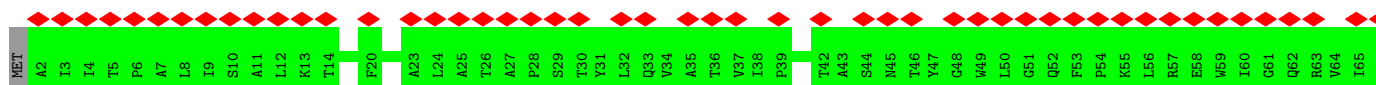



• Molecule 2: Bacteriophage Mu GpT domain-containing protein



• Molecule 2: Bacteriophage Mu GpT domain-containing protein

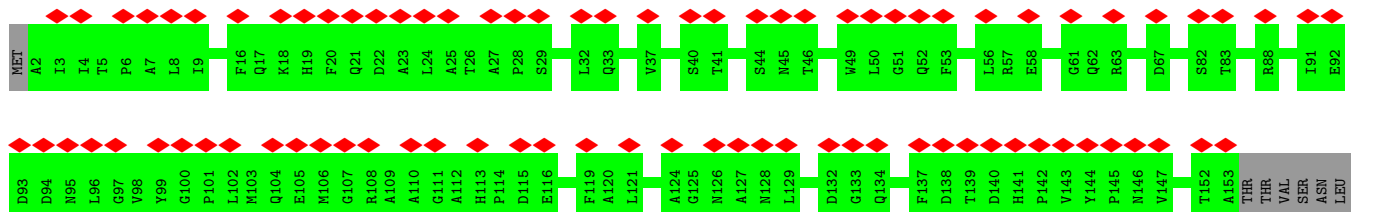

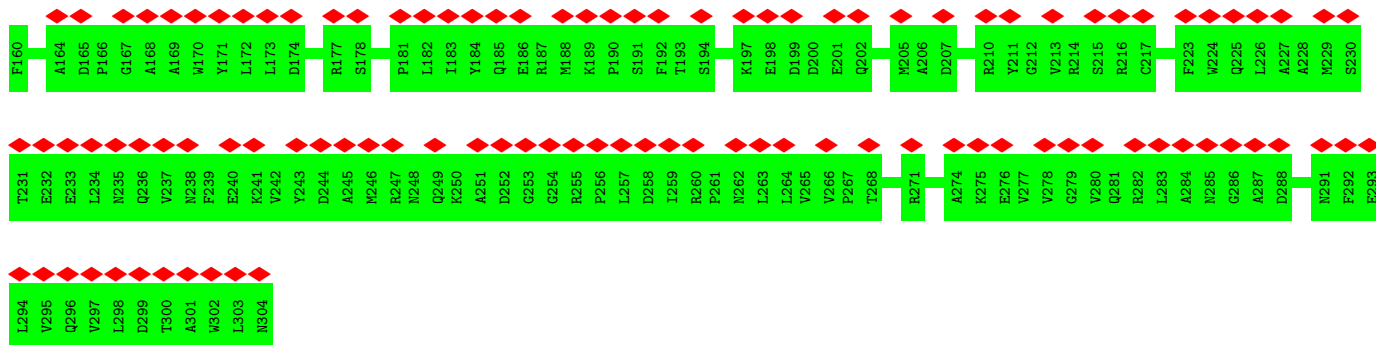

• Molecule 2: Bacteriophage Mu GpT domain-containing protein



• Molecule 2: Bacteriophage Mu GpT domain-containing protein

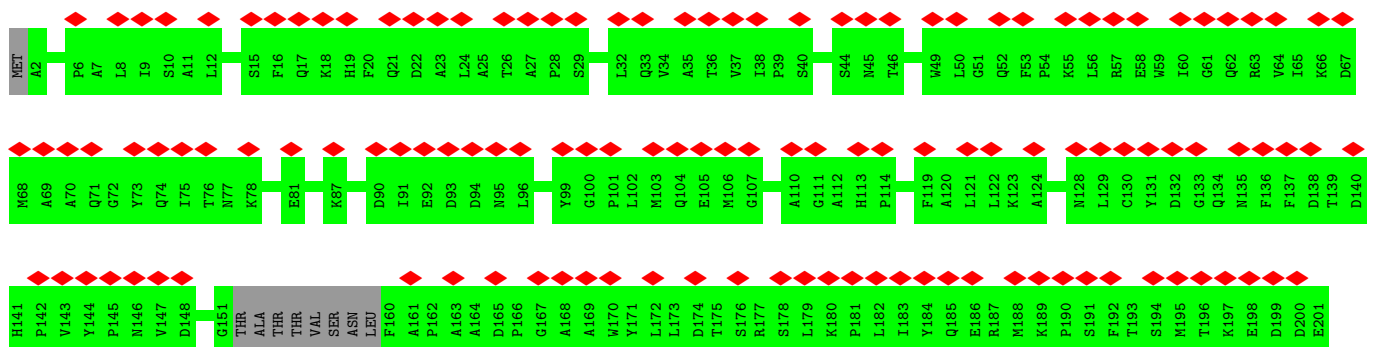

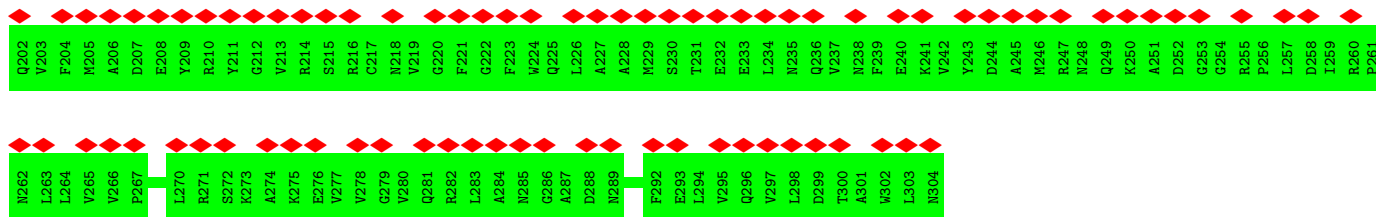

• Molecule 2: Bacteriophage Mu GpT domain-containing protein

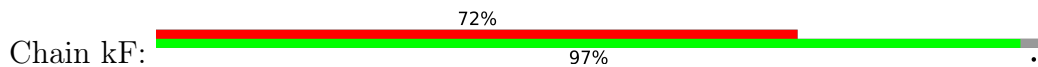

• Molecule 2: Bacteriophage Mu GpT domain-containing protein

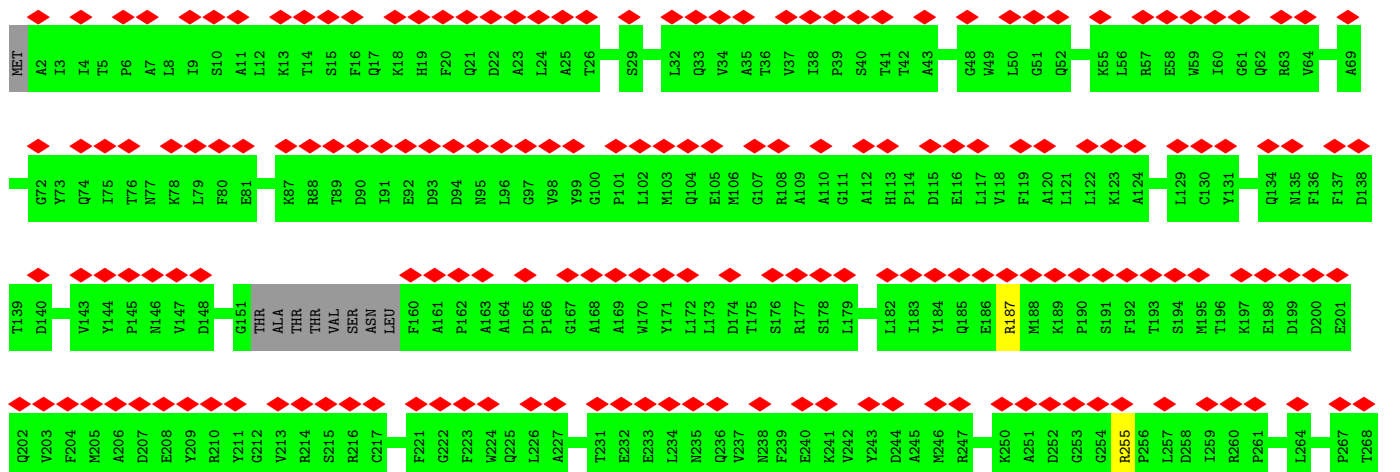

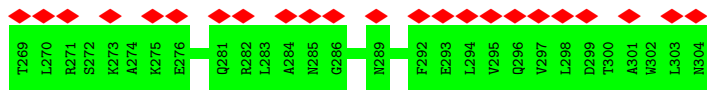

• Molecule 2: Bacteriophage Mu GpT domain-containing protein

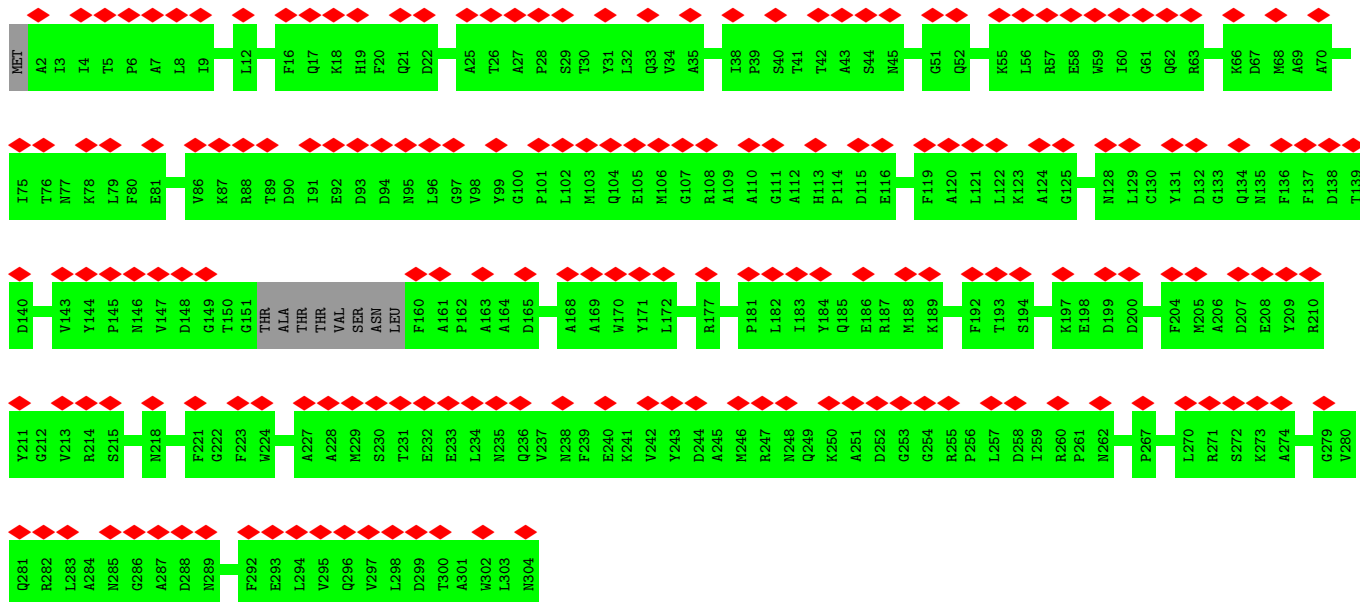

• Molecule 2: Bacteriophage Mu GpT domain-containing protein



• Molecule 2: Bacteriophage Mu GpT domain-containing protein

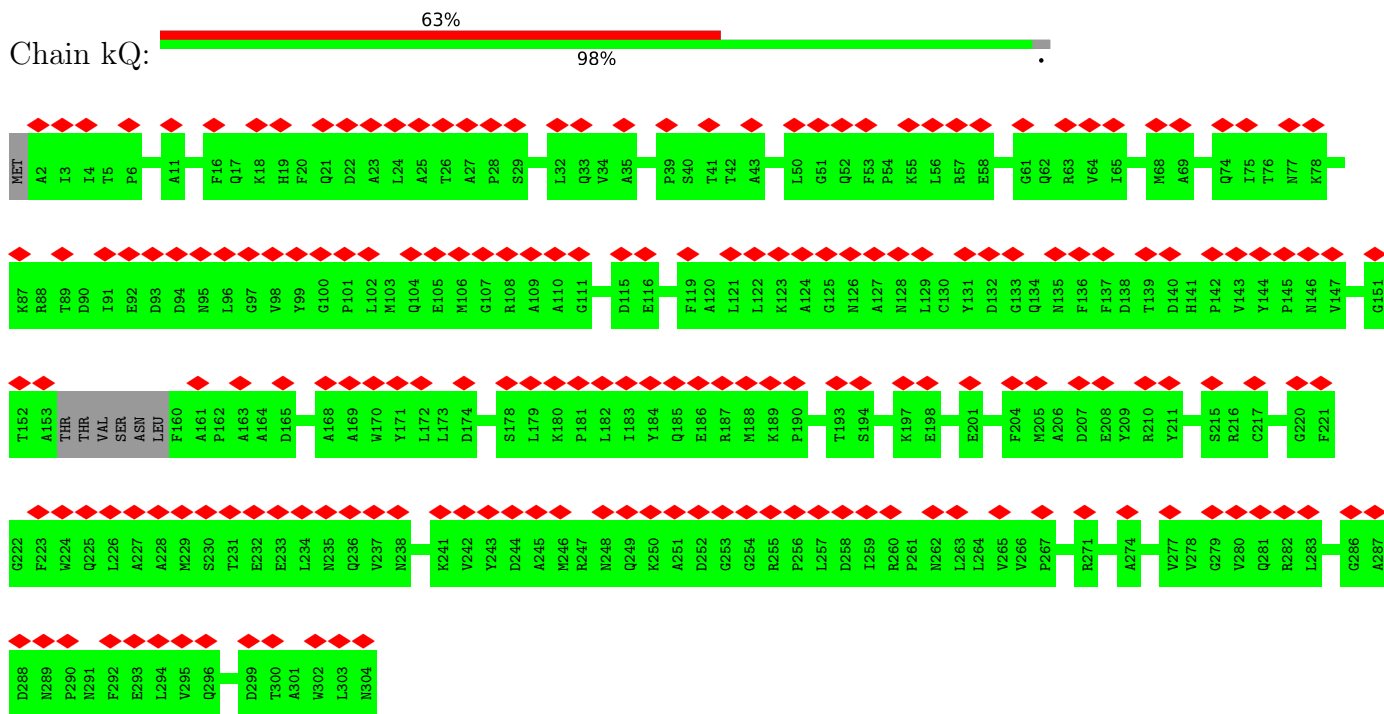

• Molecule 2: Bacteriophage Mu GpT domain-containing protein

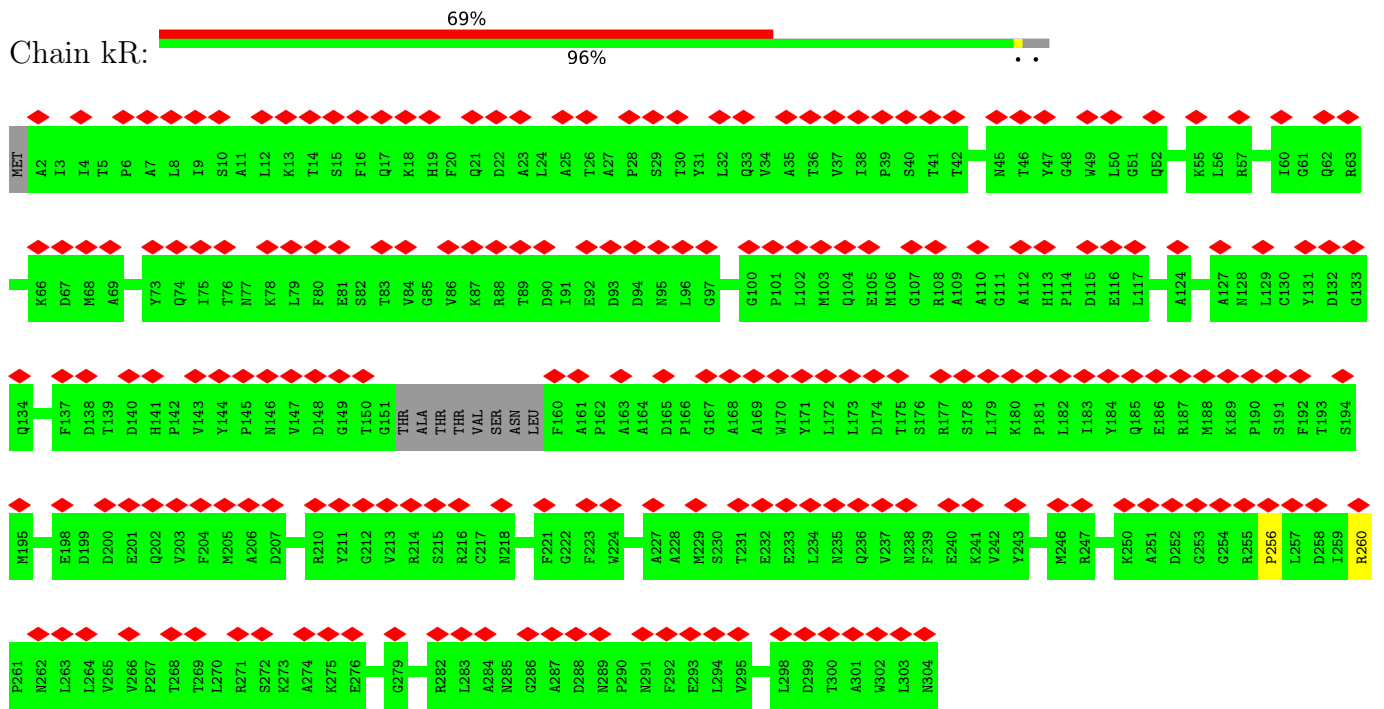

• Molecule 2: Bacteriophage Mu GpT domain-containing protein

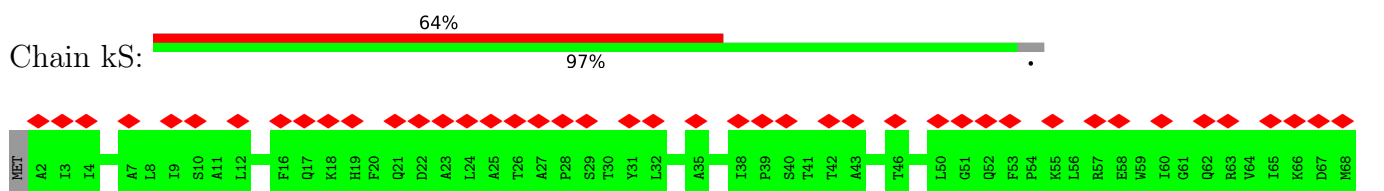

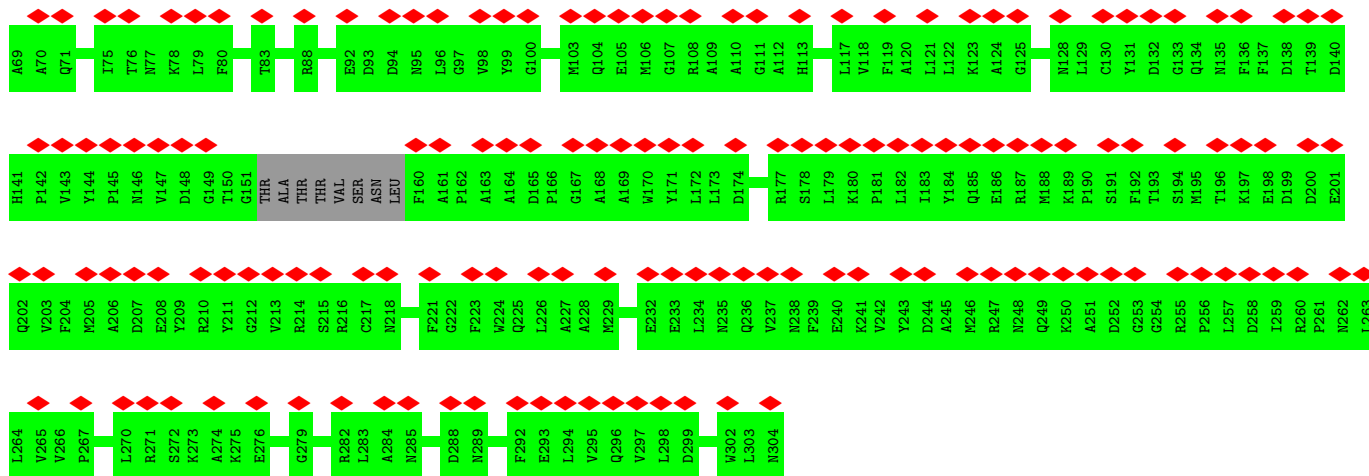

• Molecule 2: Bacteriophage Mu GpT domain-containing protein

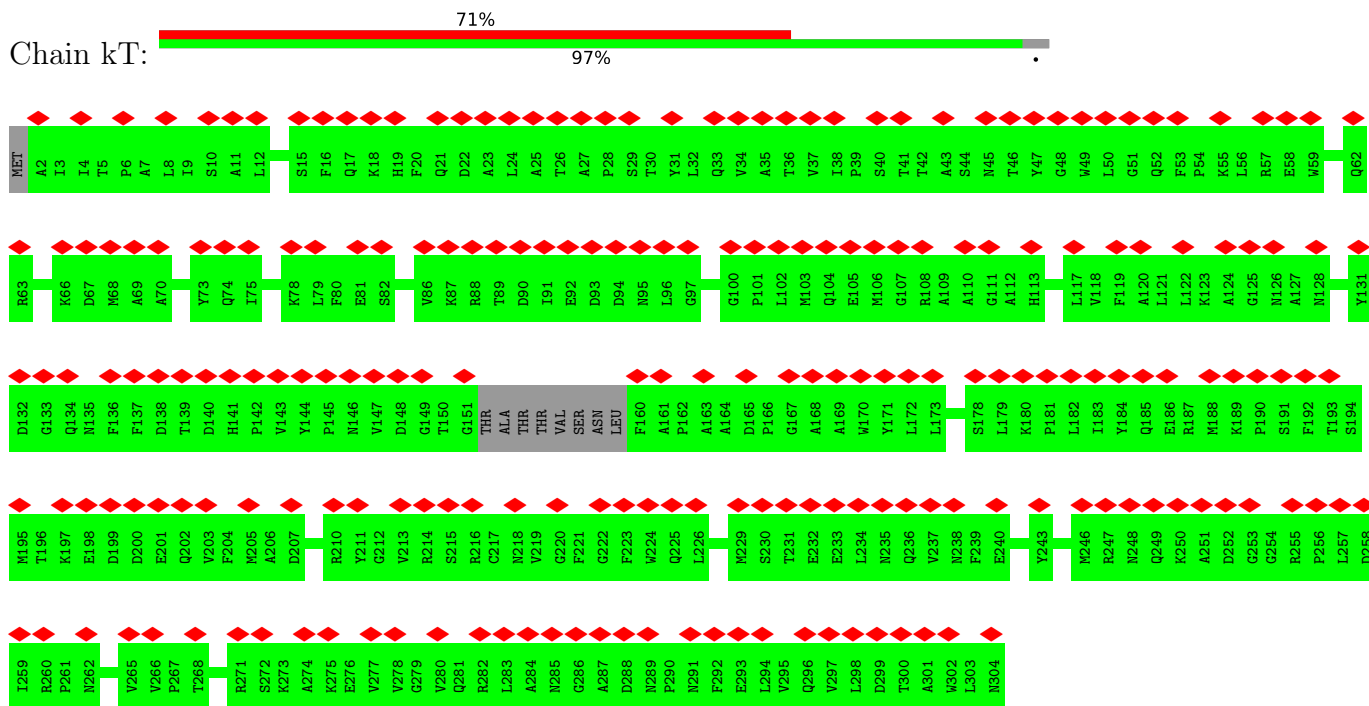

• Molecule 2: Bacteriophage Mu GpT domain-containing protein

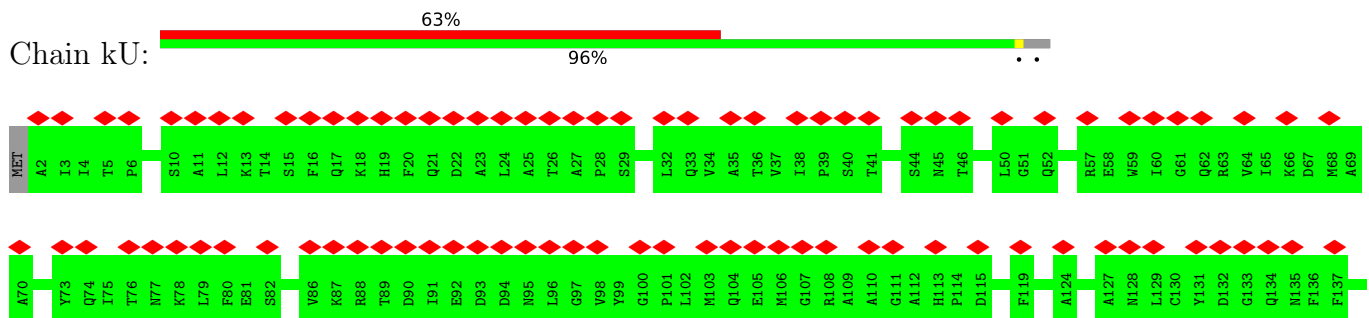

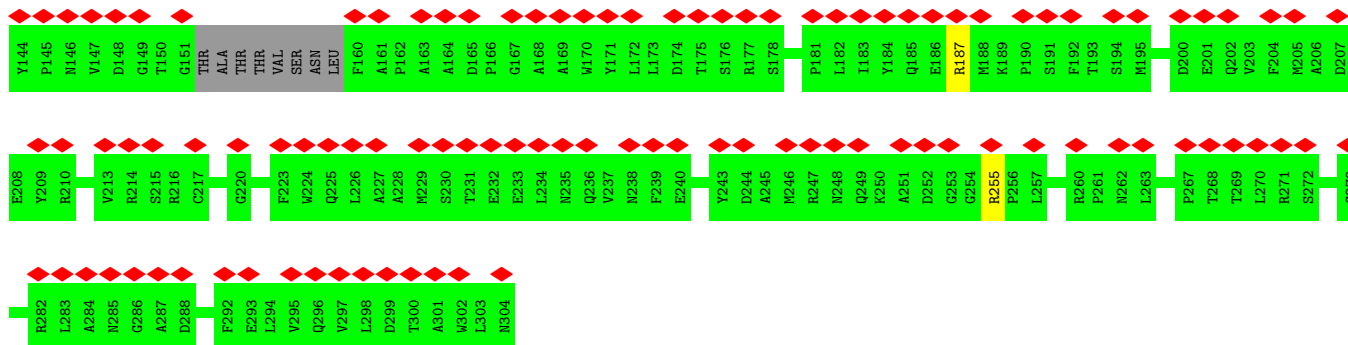

• Molecule 2: Bacteriophage Mu GpT domain-containing protein

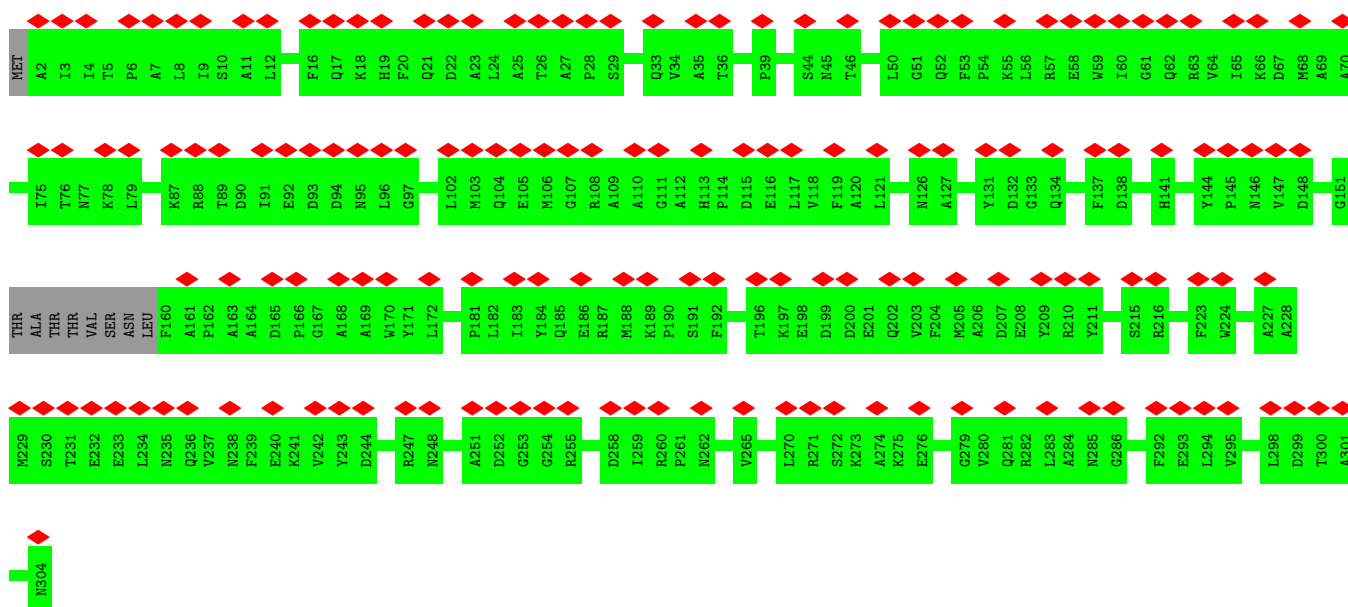

• Molecule 2: Bacteriophage Mu GpT domain-containing protein

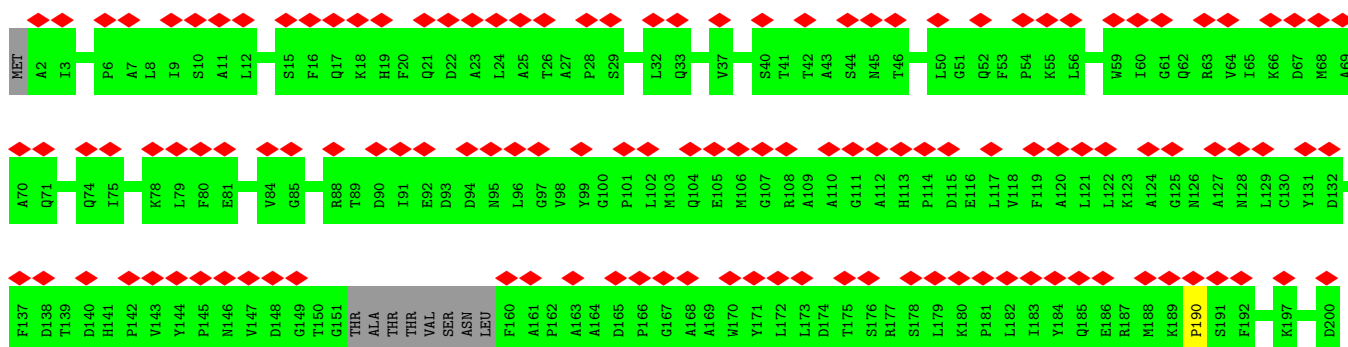

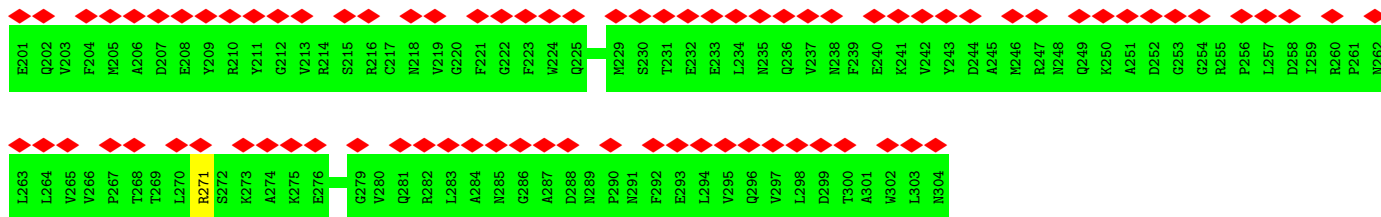

• Molecule 2: Bacteriophage Mu GpT domain-containing protein

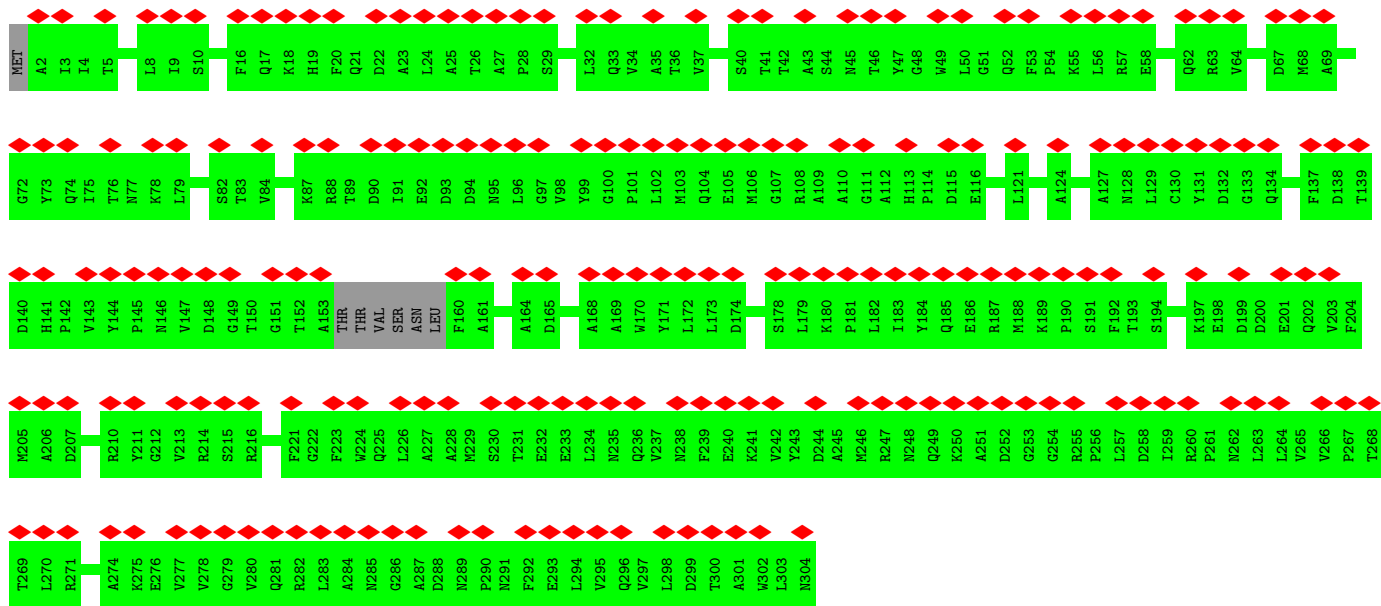

• Molecule 2: Bacteriophage Mu GpT domain-containing protein

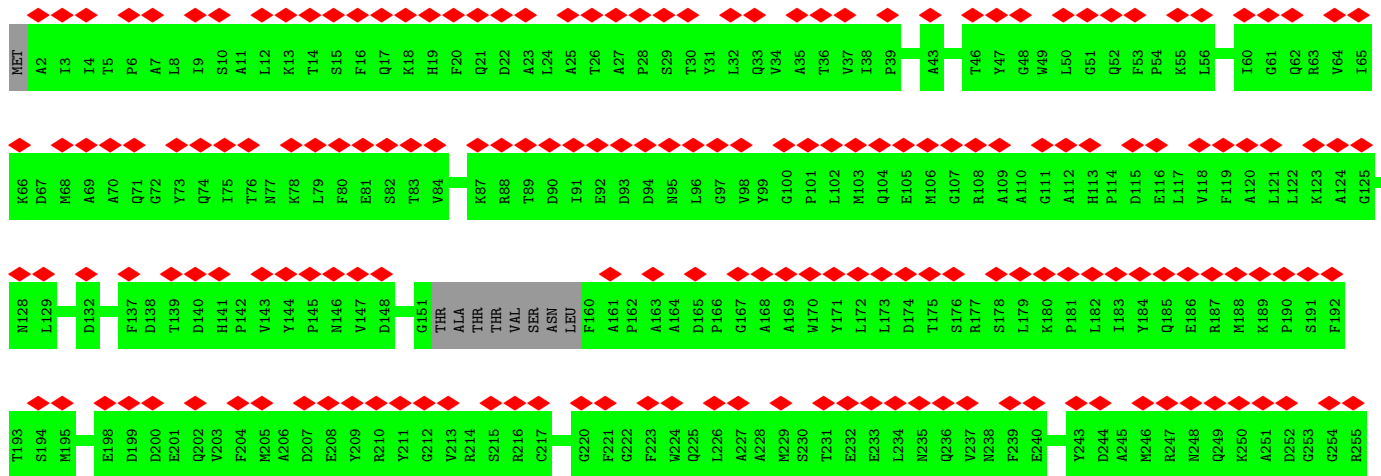

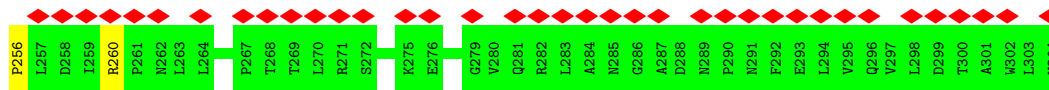

• Molecule 2: Bacteriophage Mu GpT domain-containing protein

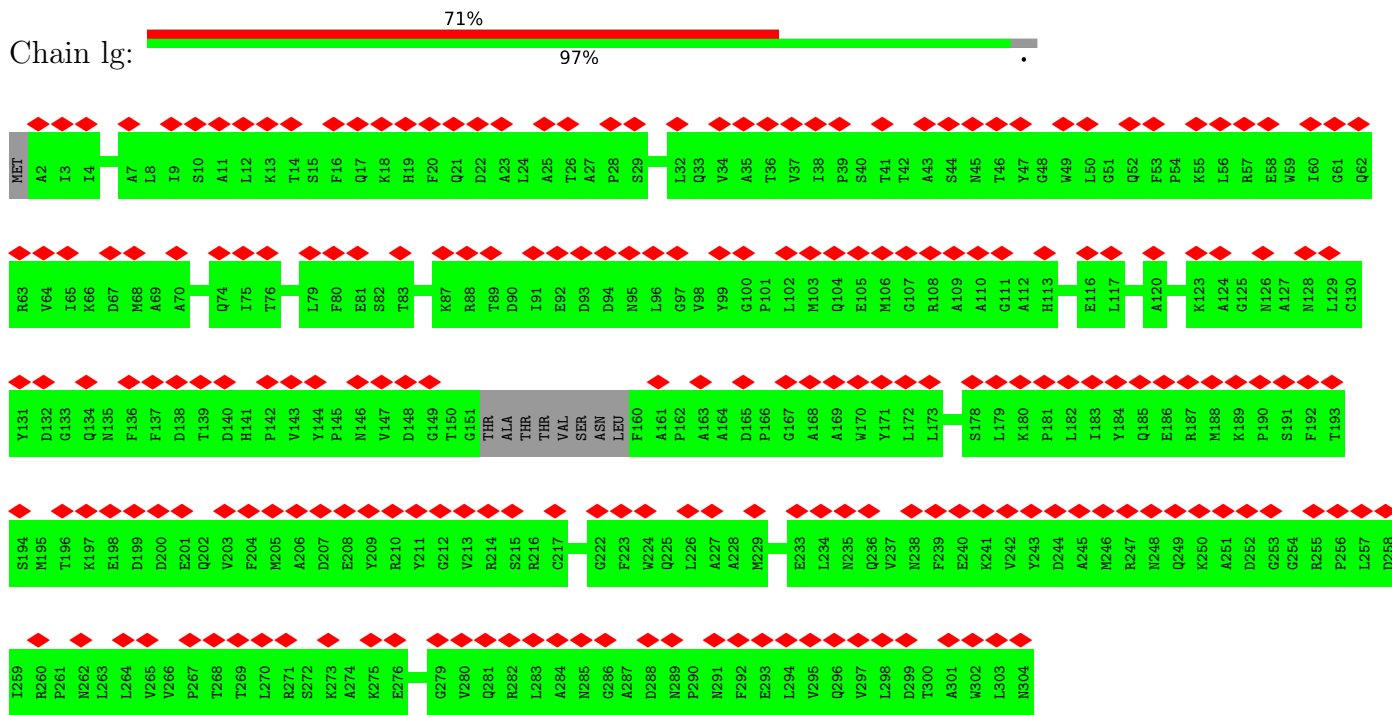

• Molecule 2: Bacteriophage Mu GpT domain-containing protein

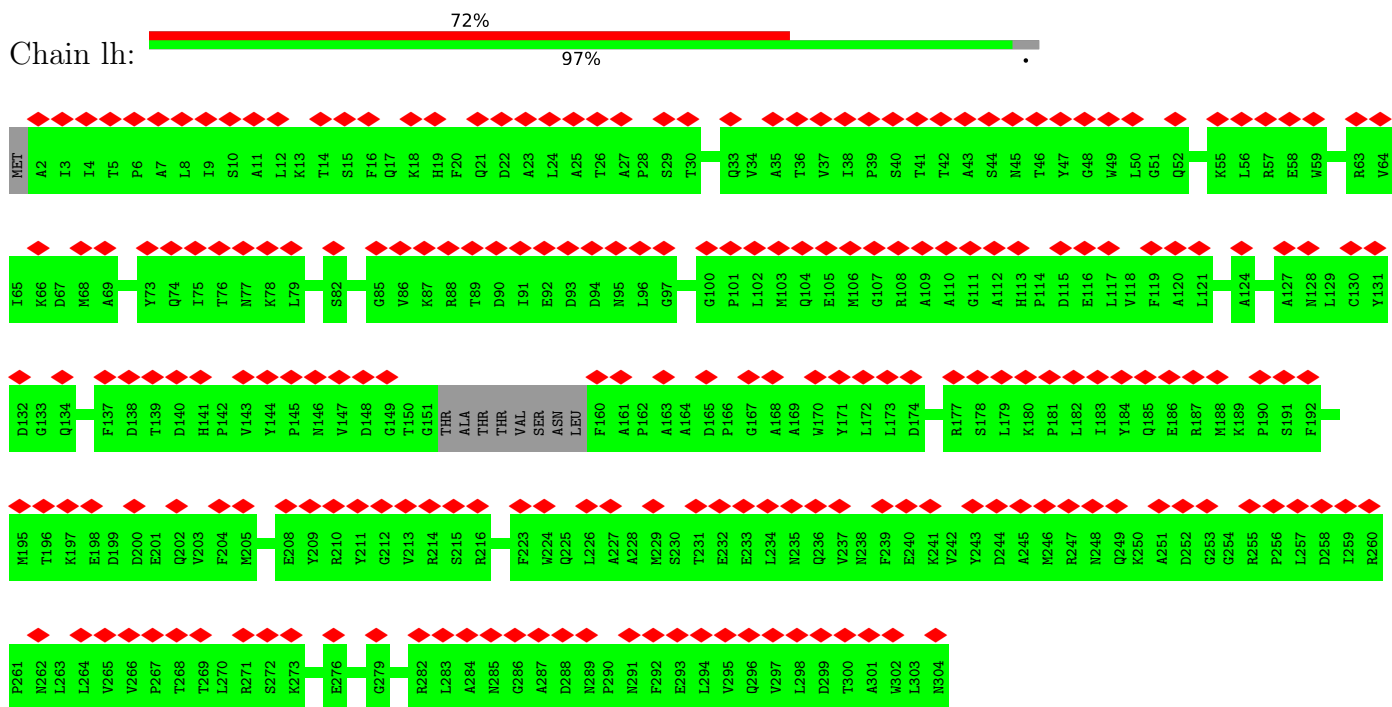

• Molecule 2: Bacteriophage Mu GpT domain-containing protein



• Molecule 2: Bacteriophage Mu GpT domain-containing protein

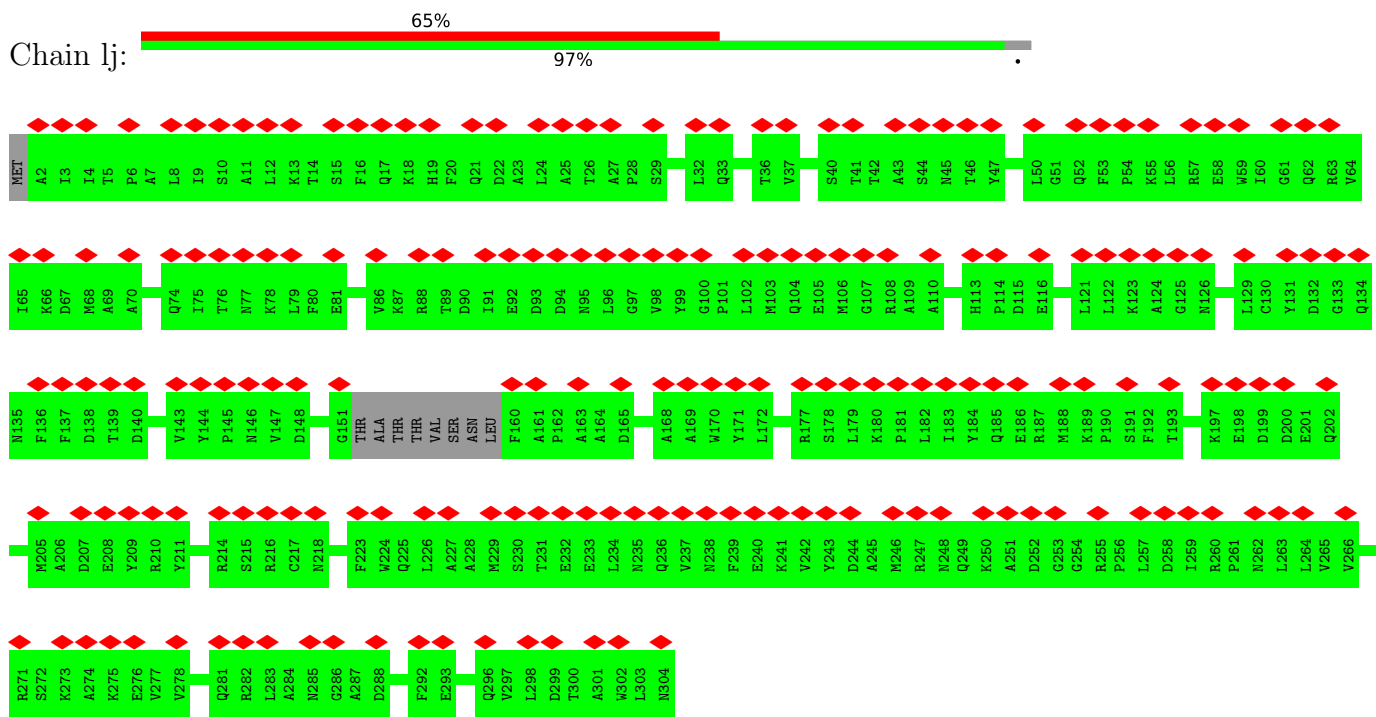

• Molecule 2: Bacteriophage Mu GpT domain-containing protein

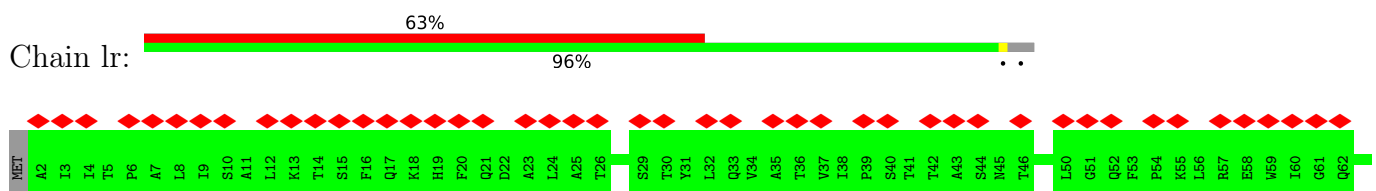

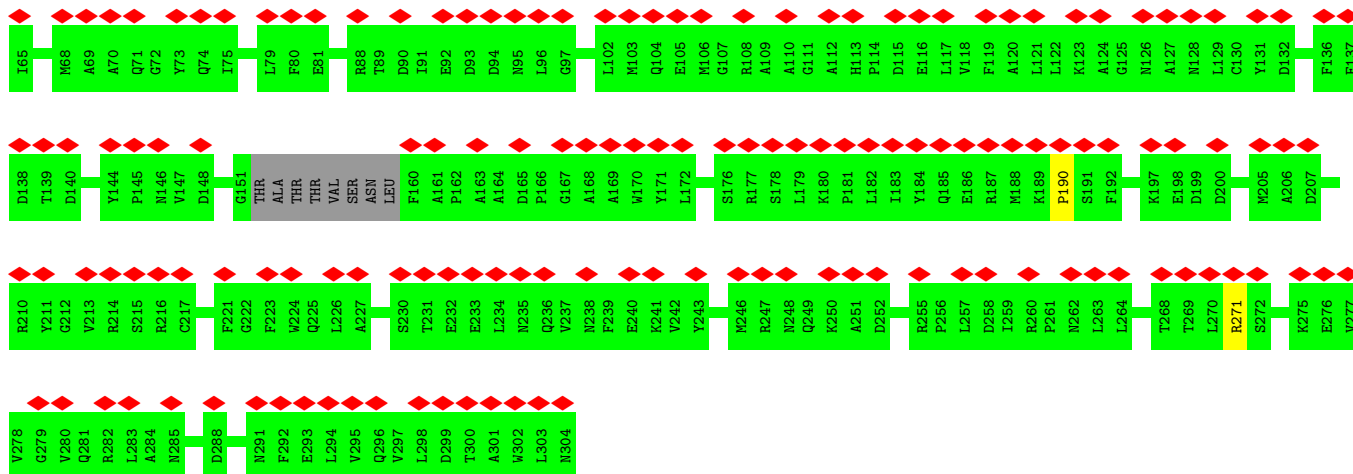

• Molecule 2: Bacteriophage Mu GpT domain-containing protein



• Molecule 2: Bacteriophage Mu GpT domain-containing protein

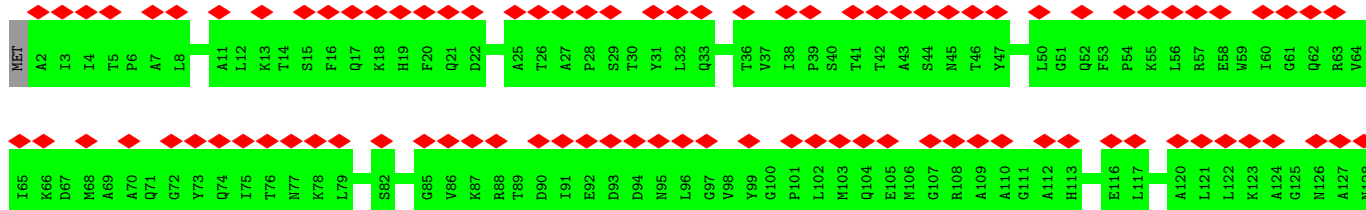

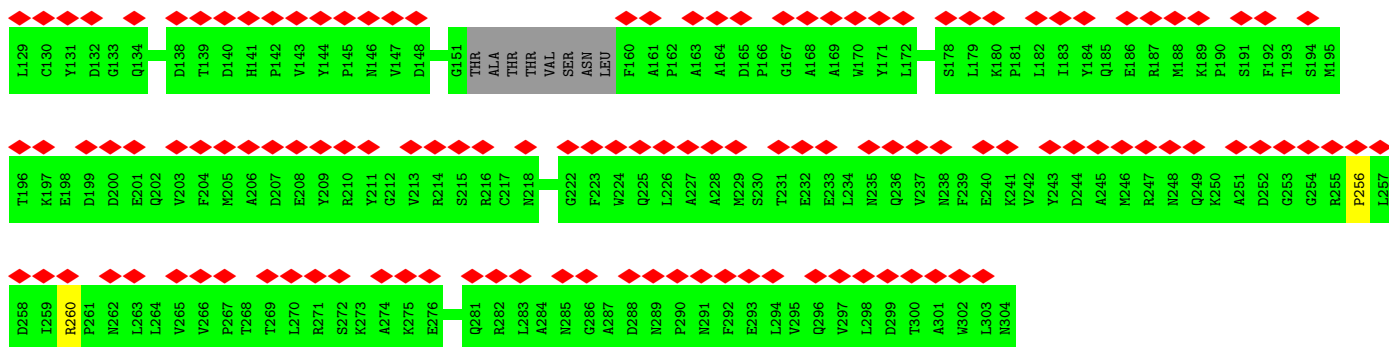

• Molecule 2: Bacteriophage Mu GpT domain-containing protein

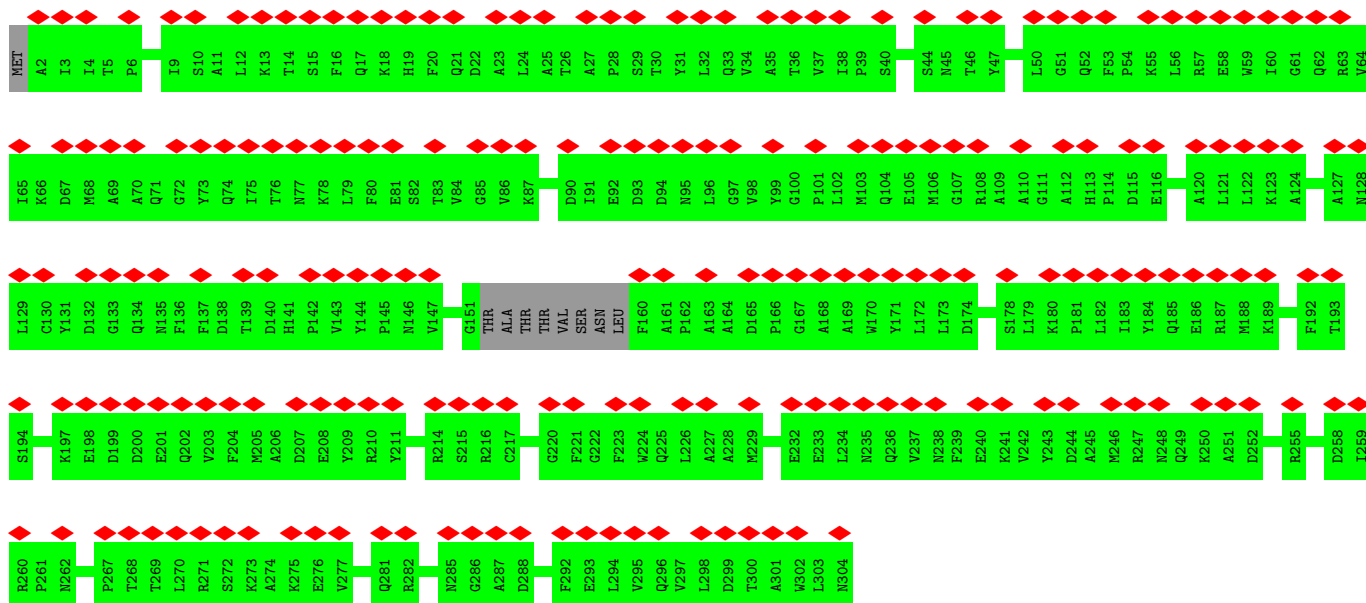

• Molecule 2: Bacteriophage Mu GpT domain-containing protein

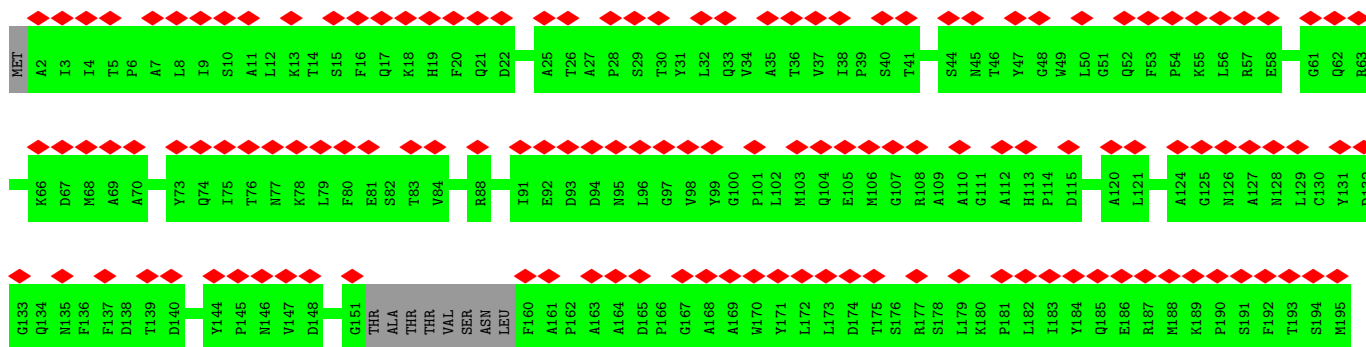

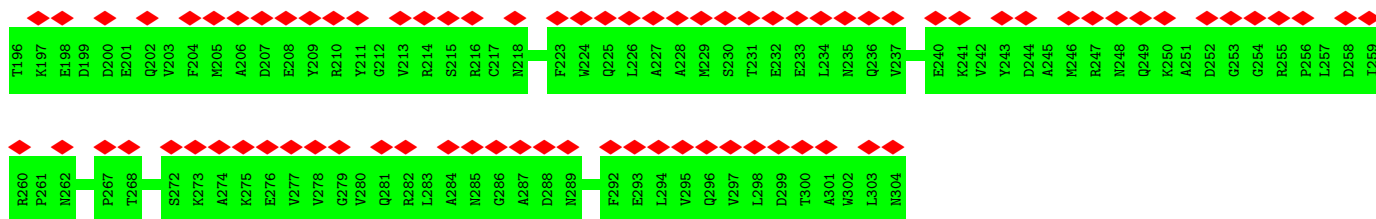

• Molecule 2: Bacteriophage Mu GpT domain-containing protein

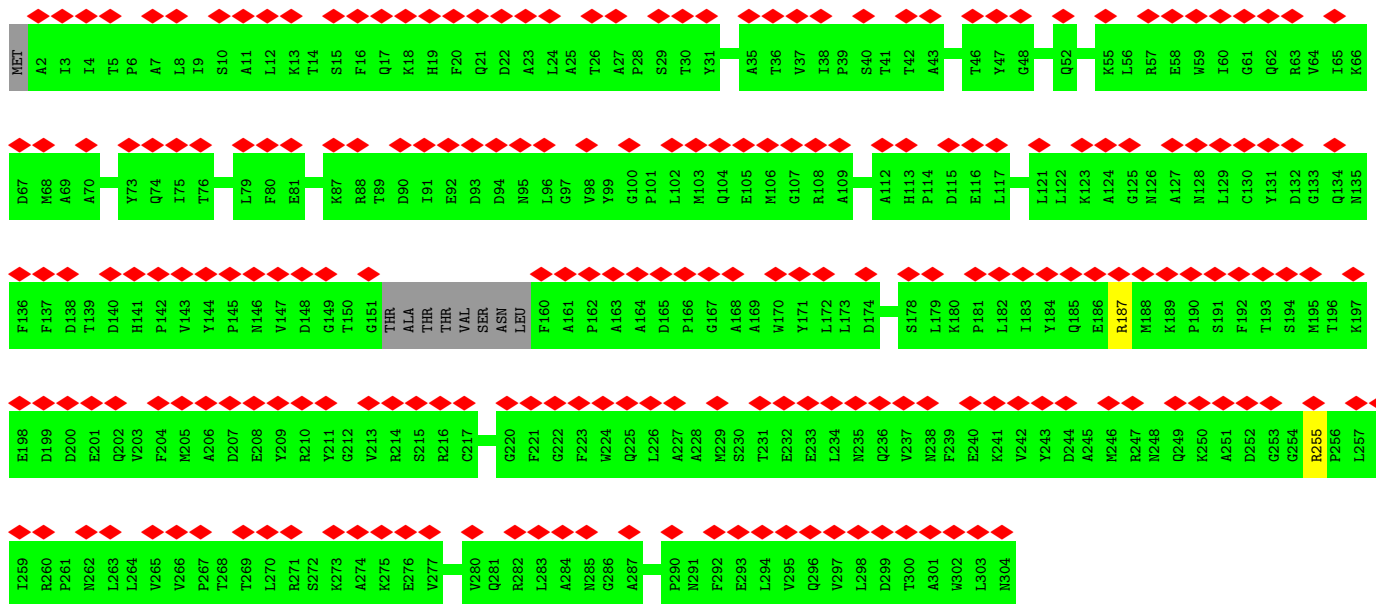

• Molecule 2: Bacteriophage Mu GpT domain-containing protein

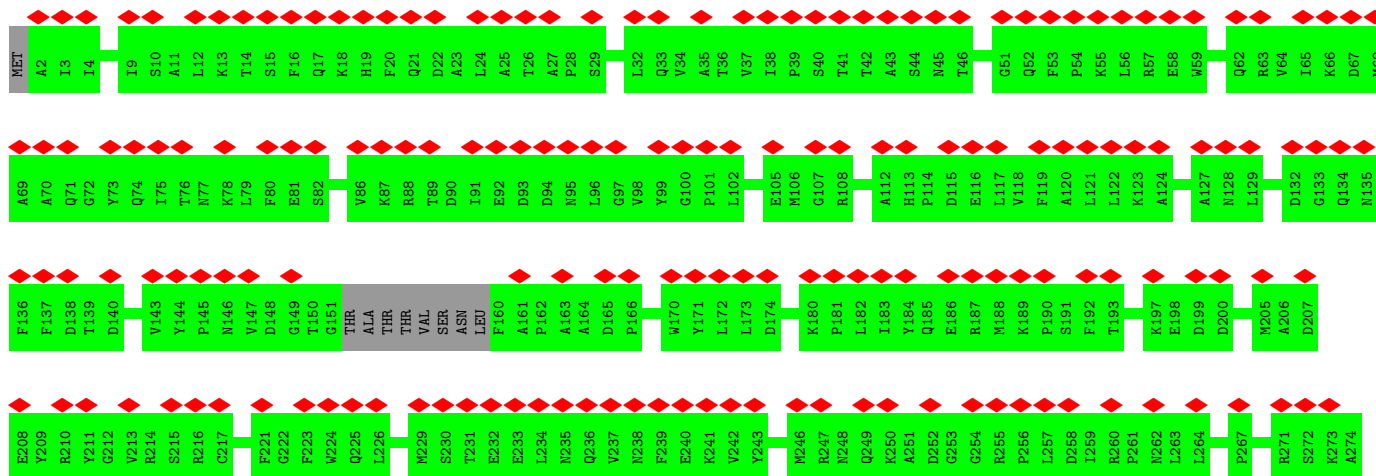

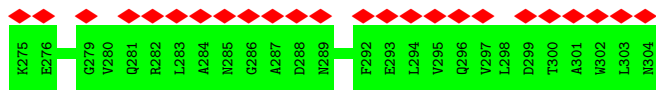

• Molecule 2: Bacteriophage Mu GpT domain-containing protein

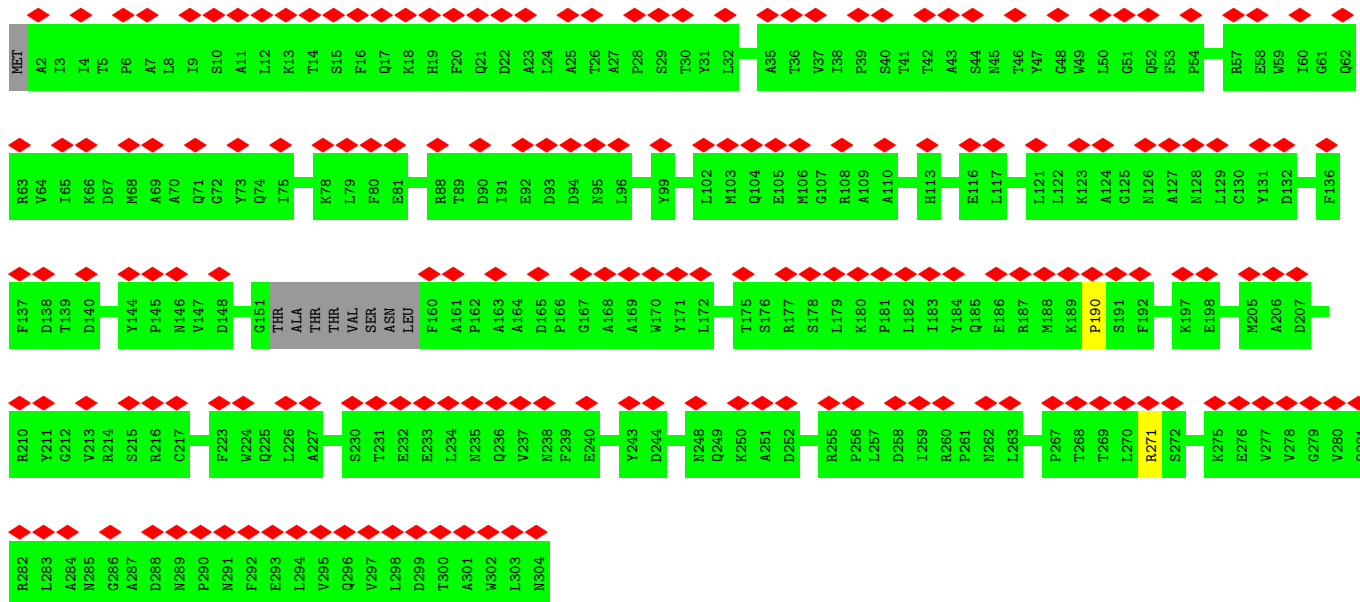

• Molecule 2: Bacteriophage Mu GpT domain-containing protein



• Molecule 2: Bacteriophage Mu GpT domain-containing protein



• Molecule 2: Bacteriophage Mu GpT domain-containing protein

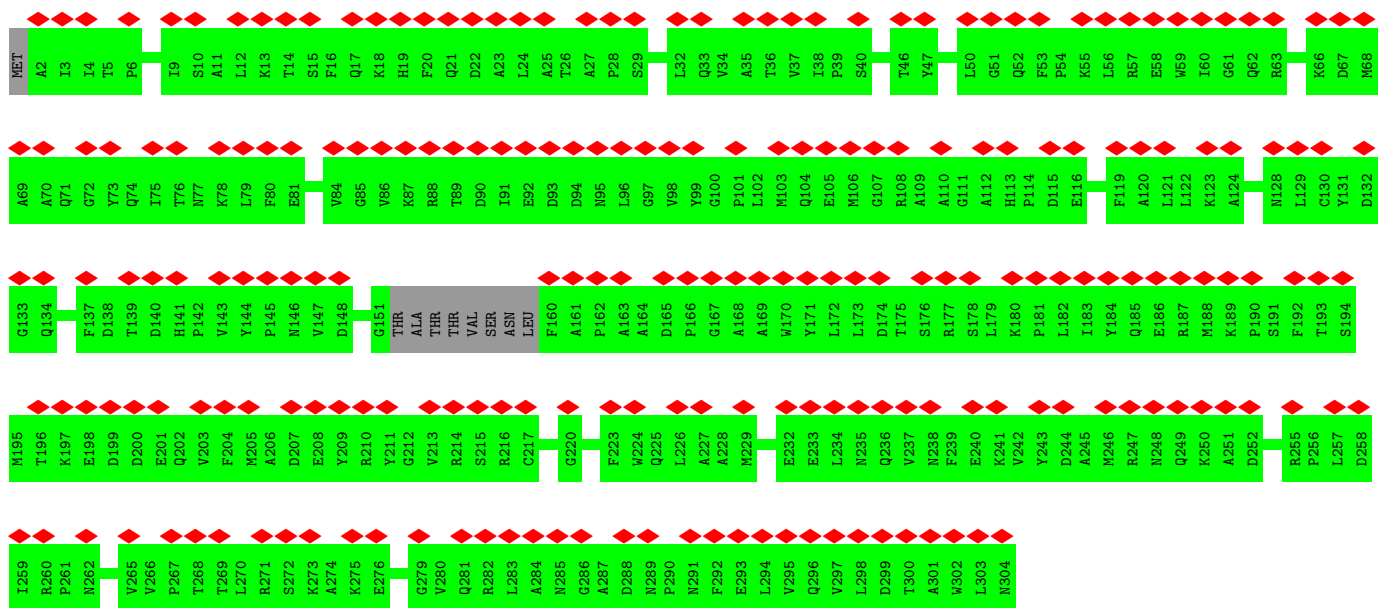

• Molecule 2: Bacteriophage Mu GpT domain-containing protein

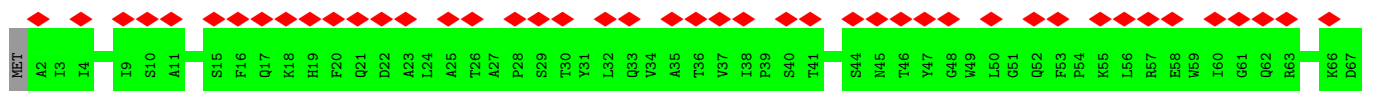

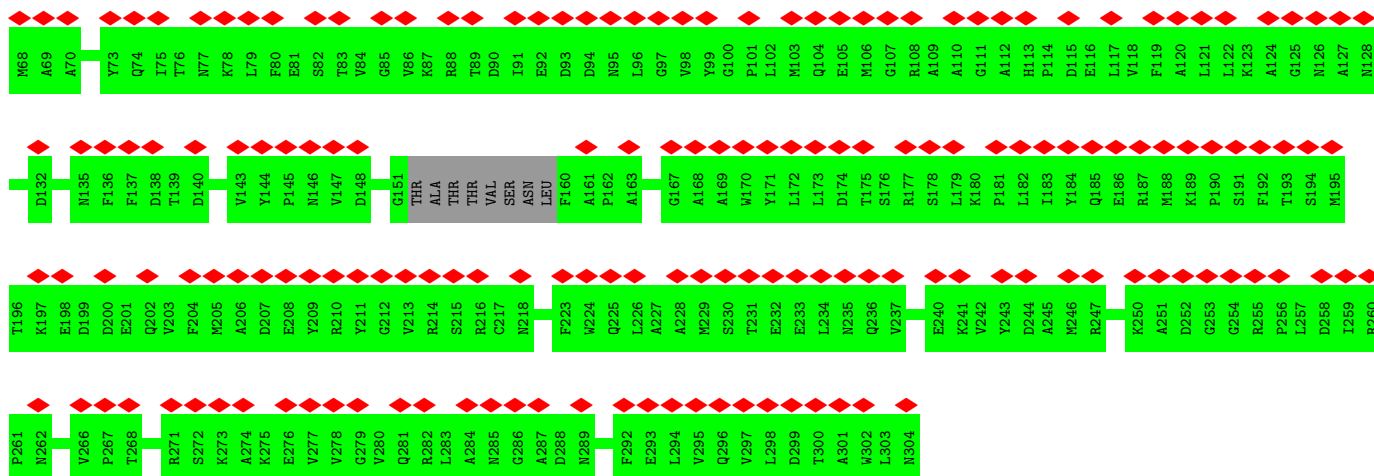

• Molecule 2: Bacteriophage Mu GpT domain-containing protein



• Molecule 2: Bacteriophage Mu GpT domain-containing protein

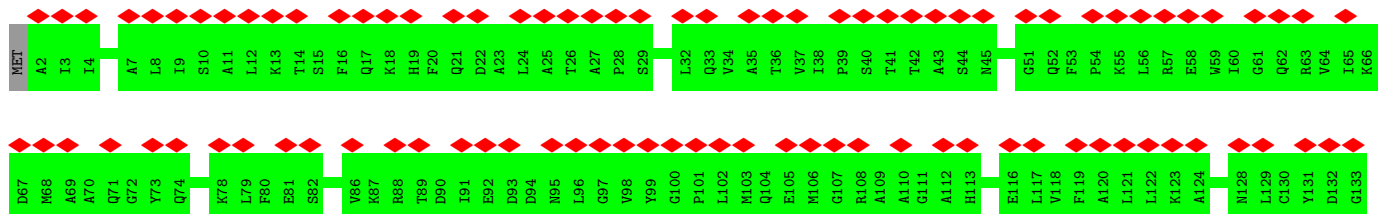

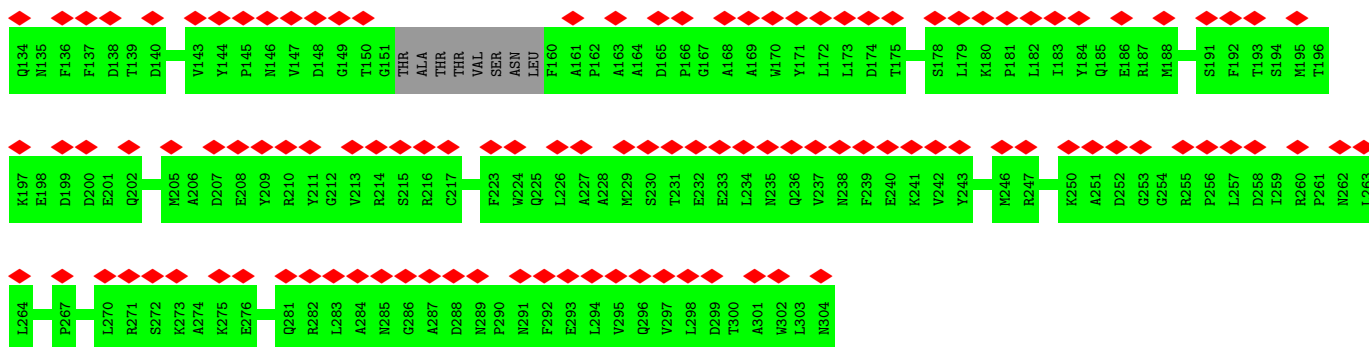

• Molecule 2: Bacteriophage Mu GpT domain-containing protein

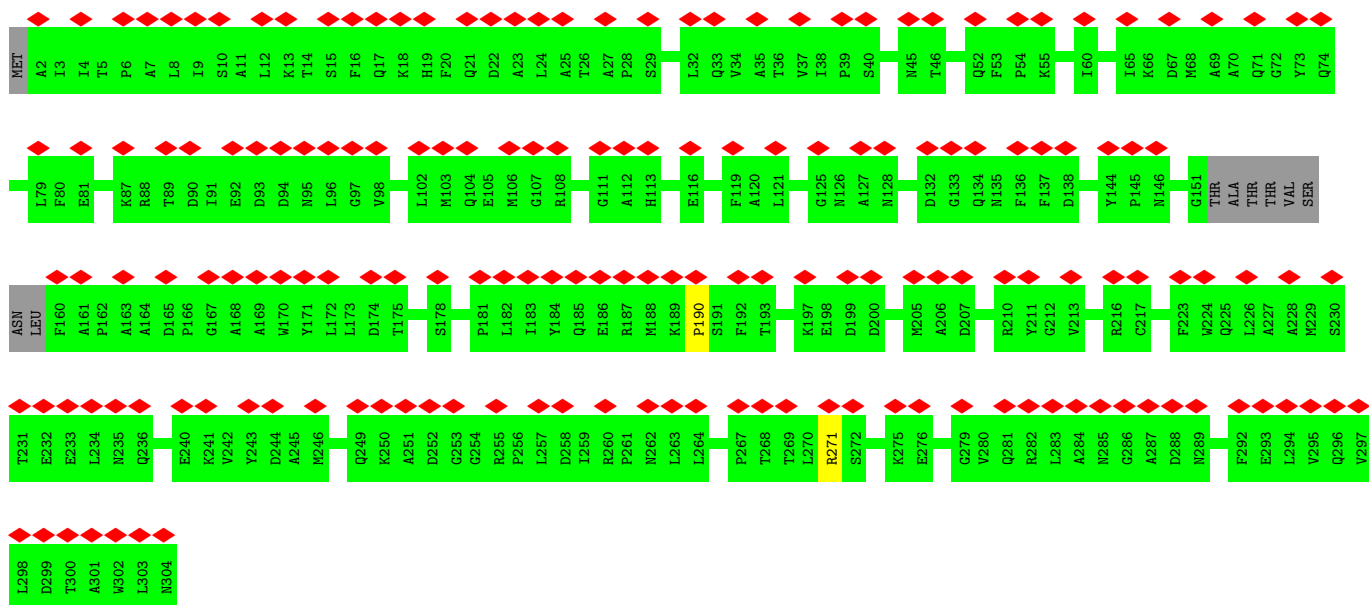

• Molecule 2: Bacteriophage Mu GpT domain-containing protein

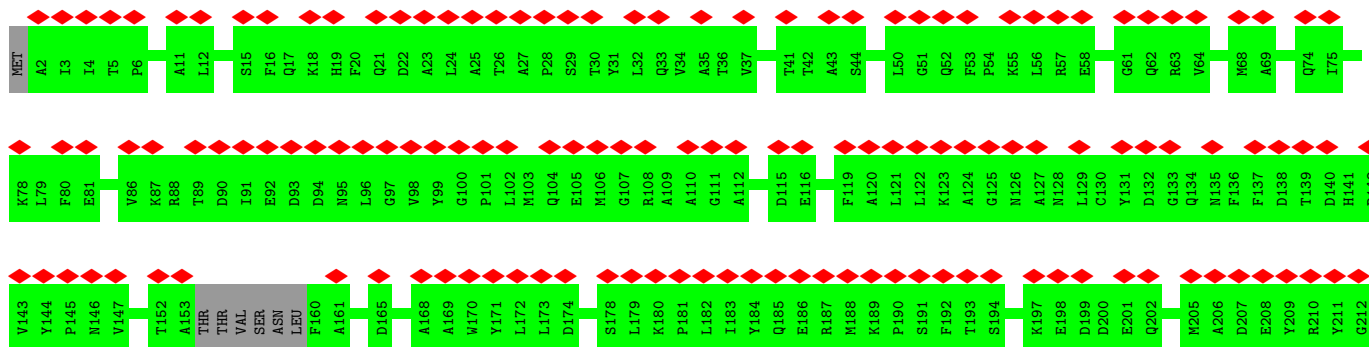

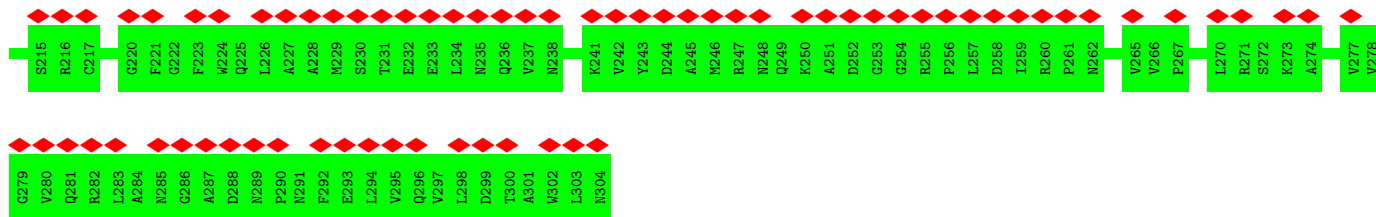

• Molecule 2: Bacteriophage Mu GpT domain-containing protein

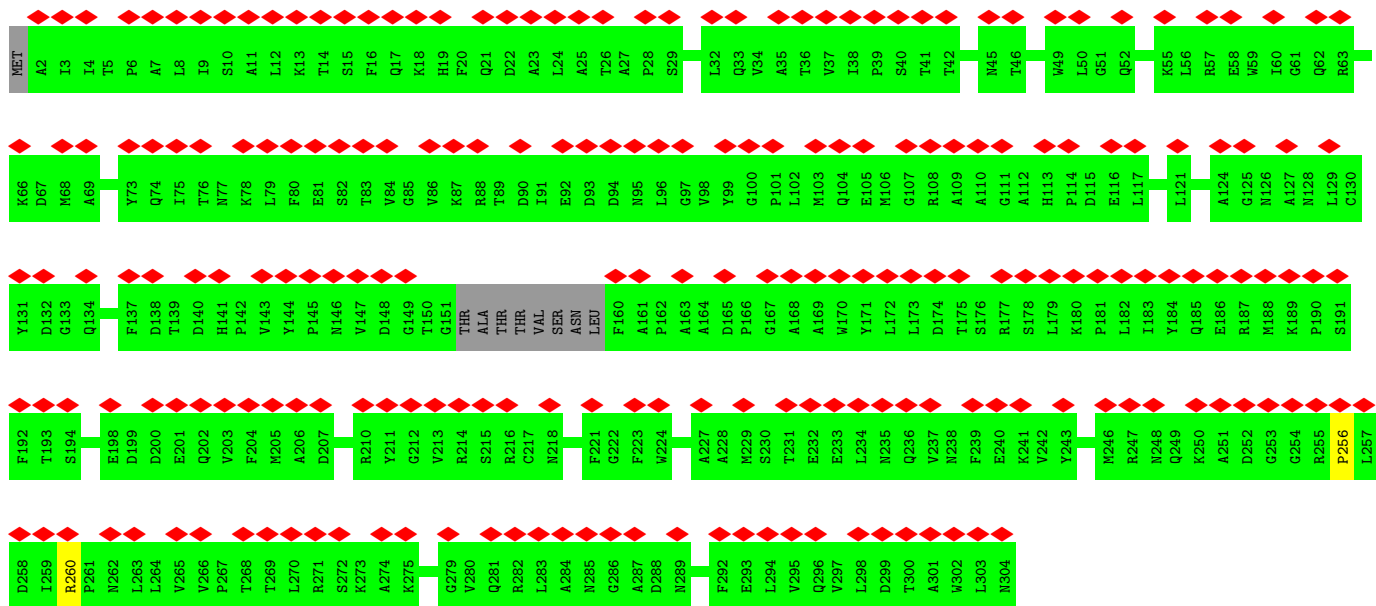

• Molecule 2: Bacteriophage Mu GpT domain-containing protein

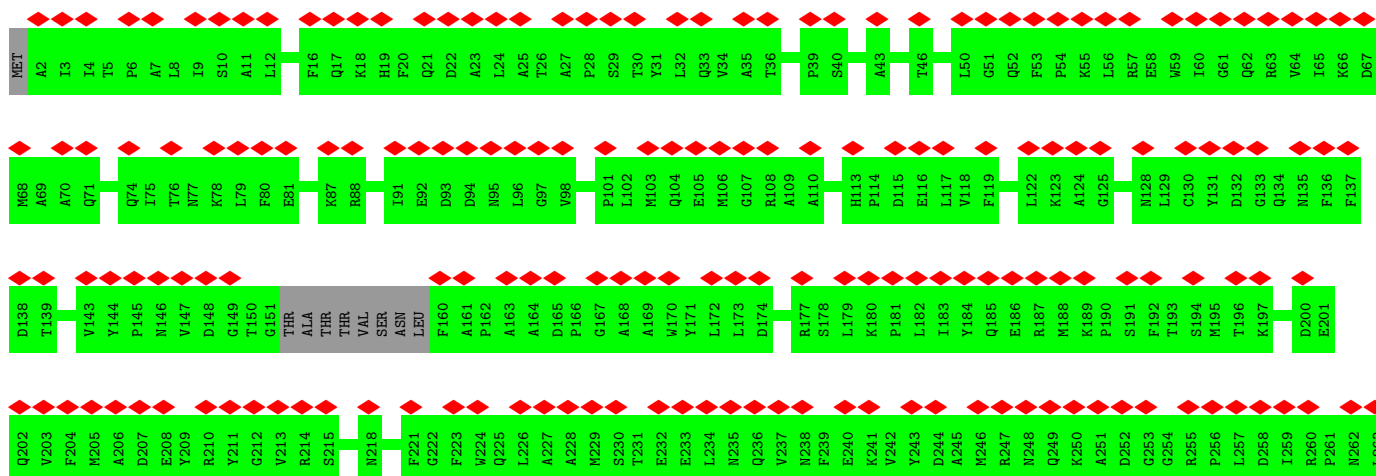

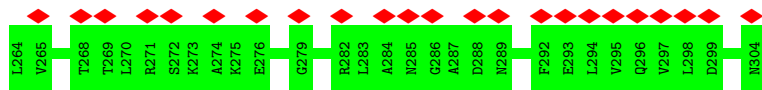

• Molecule 2: Bacteriophage Mu GpT domain-containing protein

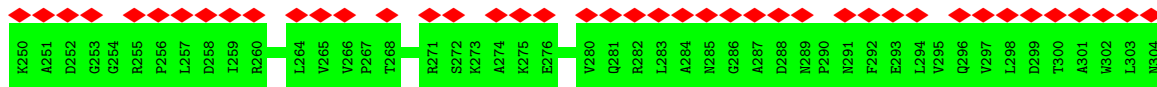
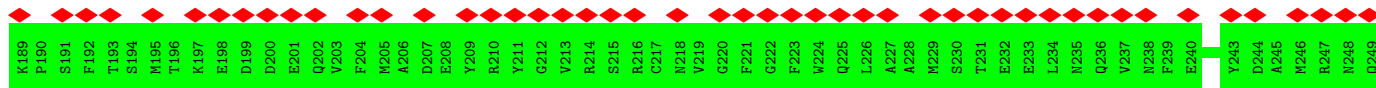
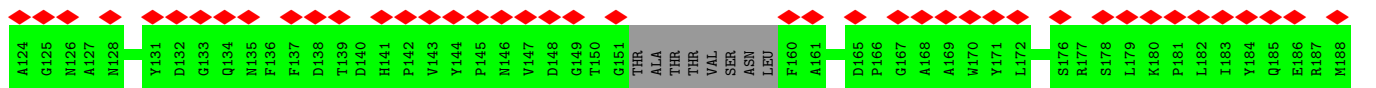
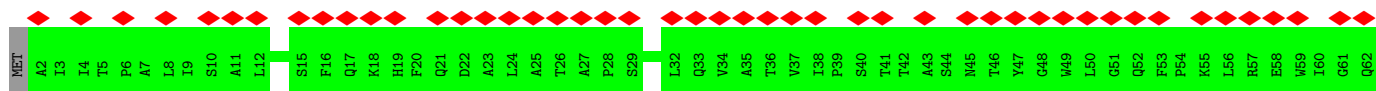
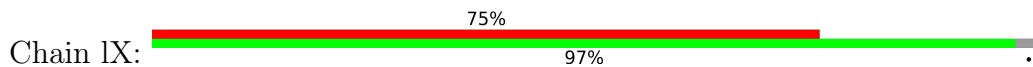

• Molecule 2: Bacteriophage Mu GpT domain-containing protein

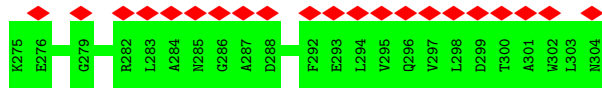
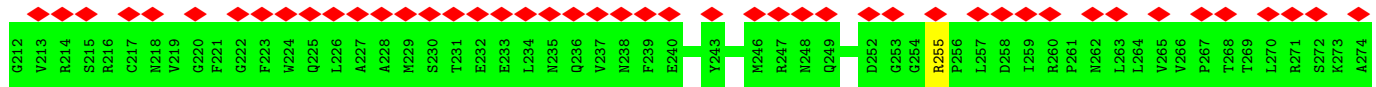
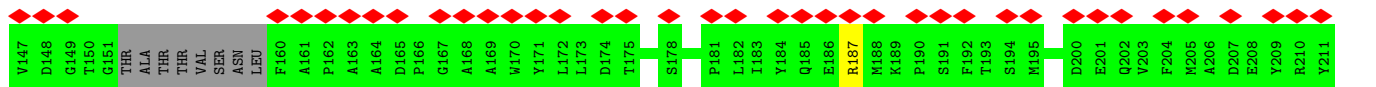
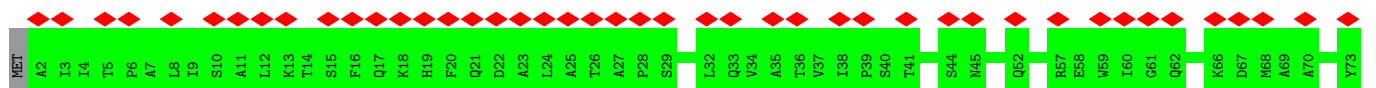

• Molecule 2: Bacteriophage Mu GpT domain-containing protein

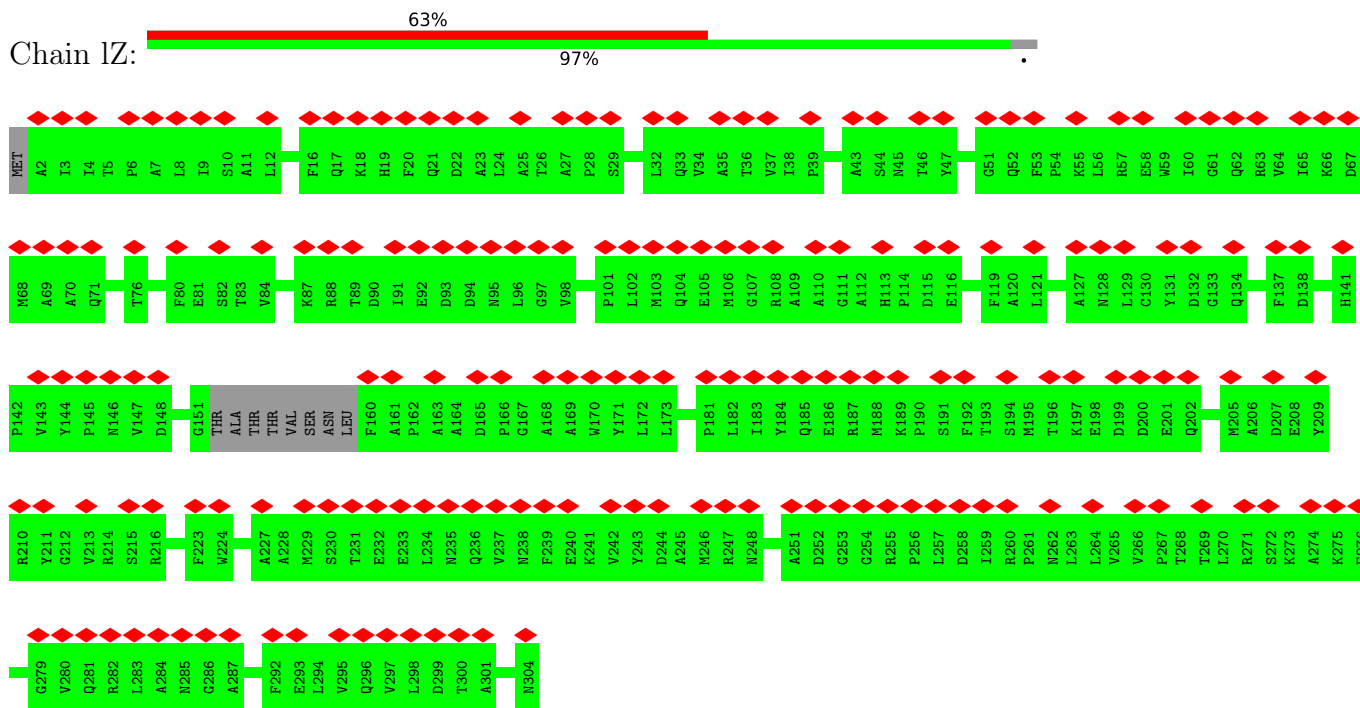

• Molecule 2: Bacteriophage Mu GpT domain-containing protein

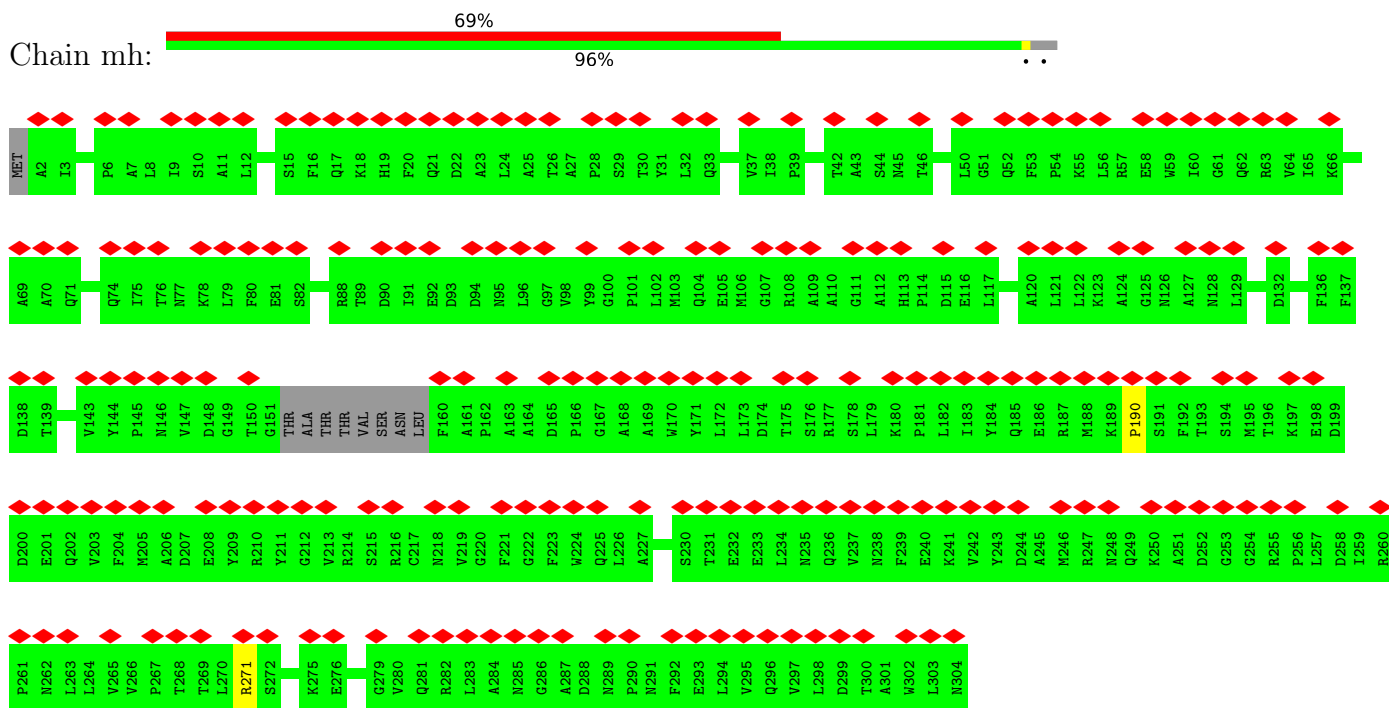

• Molecule 2: Bacteriophage Mu GpT domain-containing protein

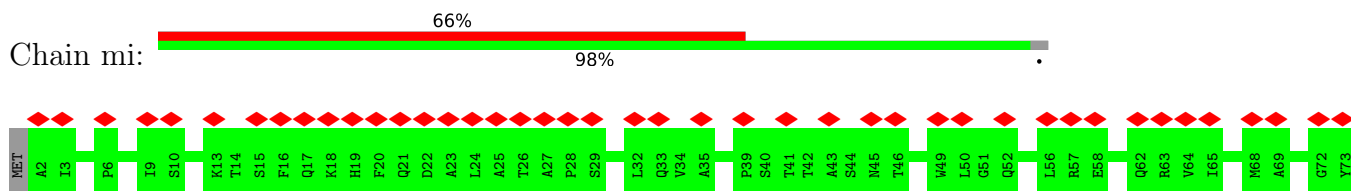

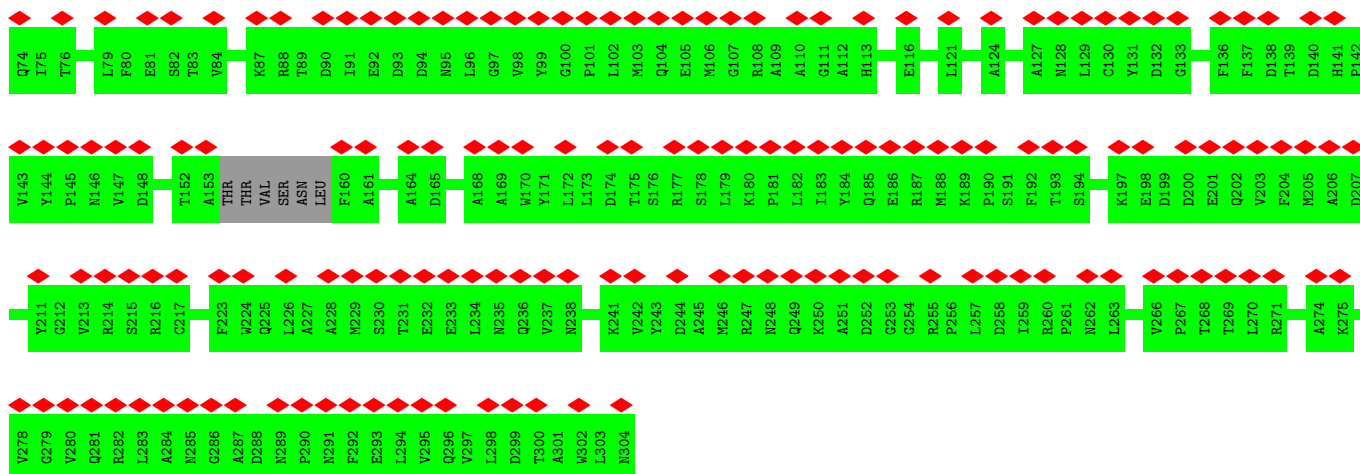

• Molecule 2: Bacteriophage Mu GpT domain-containing protein

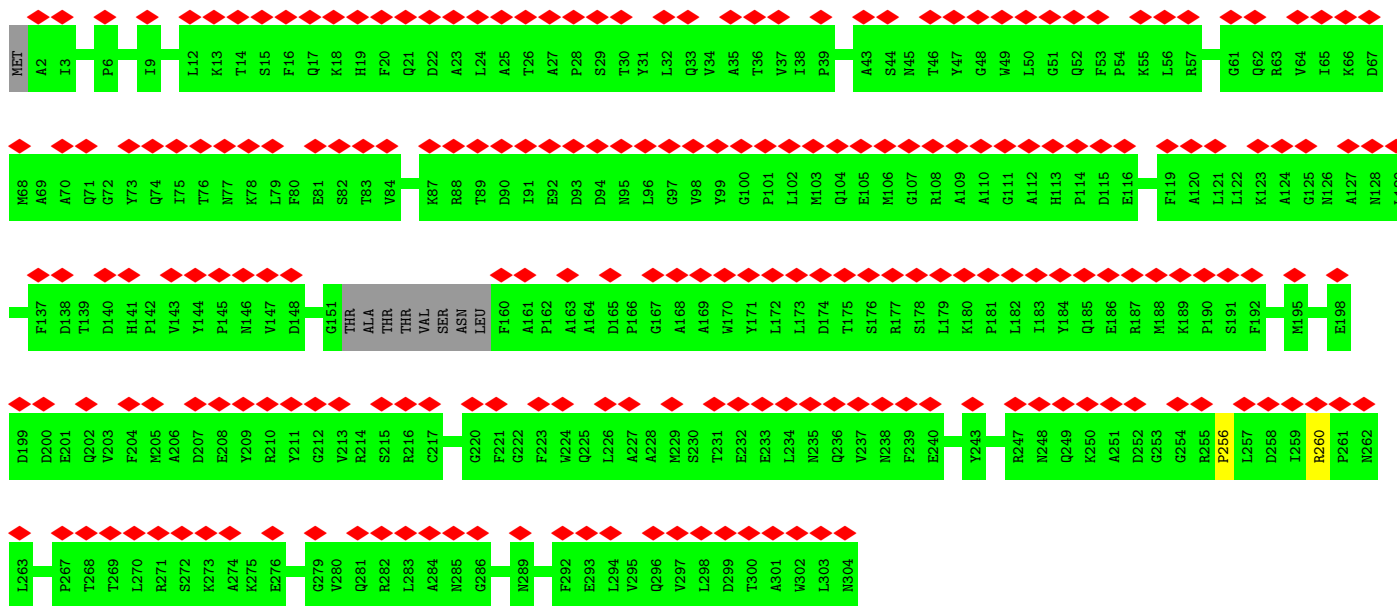
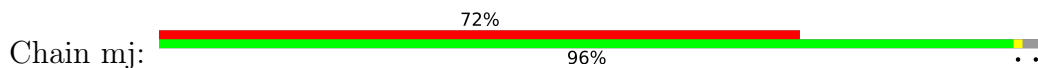

• Molecule 2: Bacteriophage Mu GpT domain-containing protein

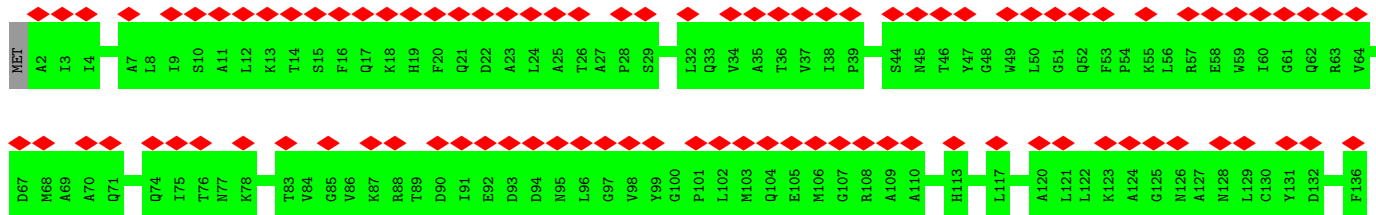
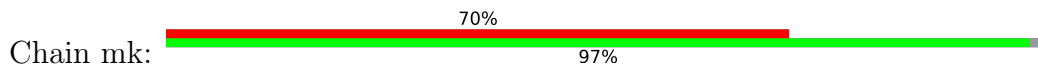

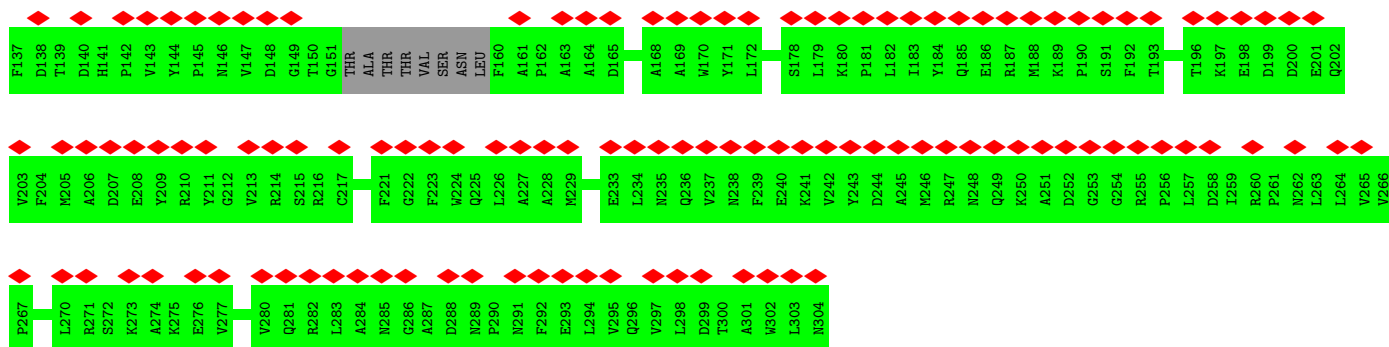

• Molecule 2: Bacteriophage Mu GpT domain-containing protein



• Molecule 2: Bacteriophage Mu GpT domain-containing protein

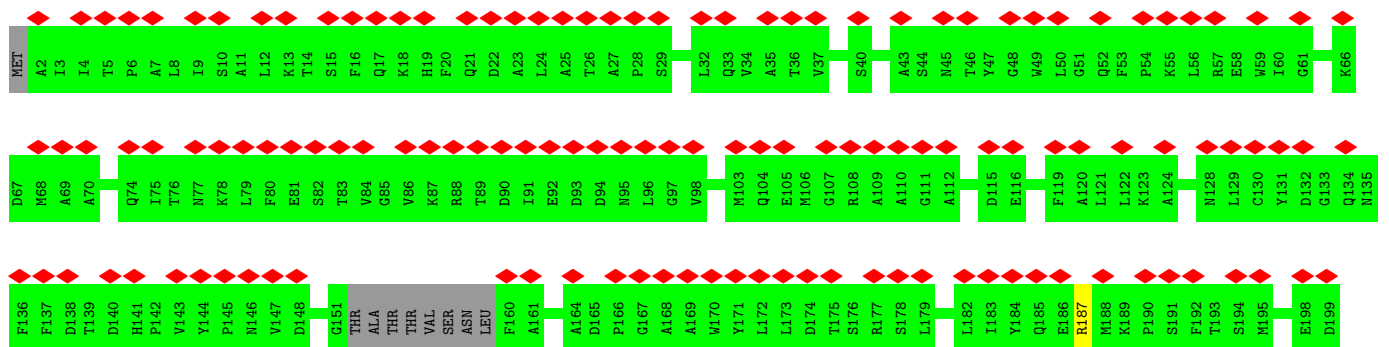

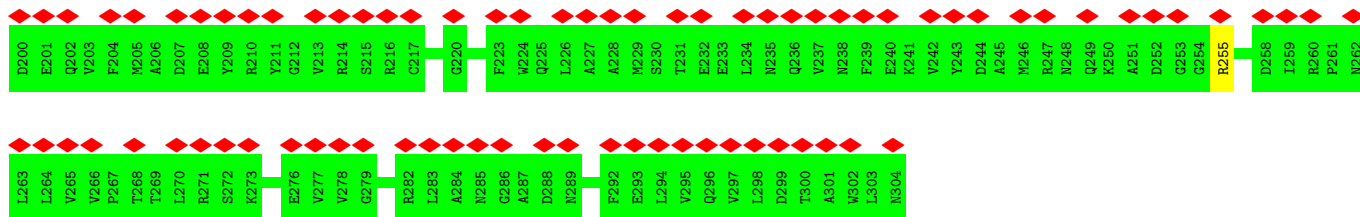

• Molecule 2: Bacteriophage Mu GpT domain-containing protein



• Molecule 2: Bacteriophage Mu GpT domain-containing protein

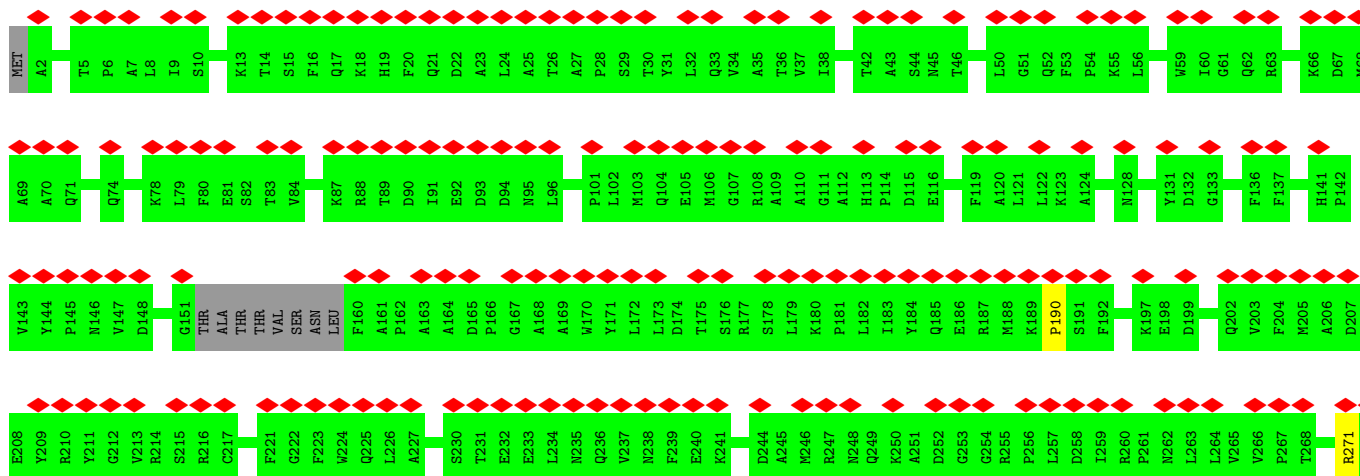

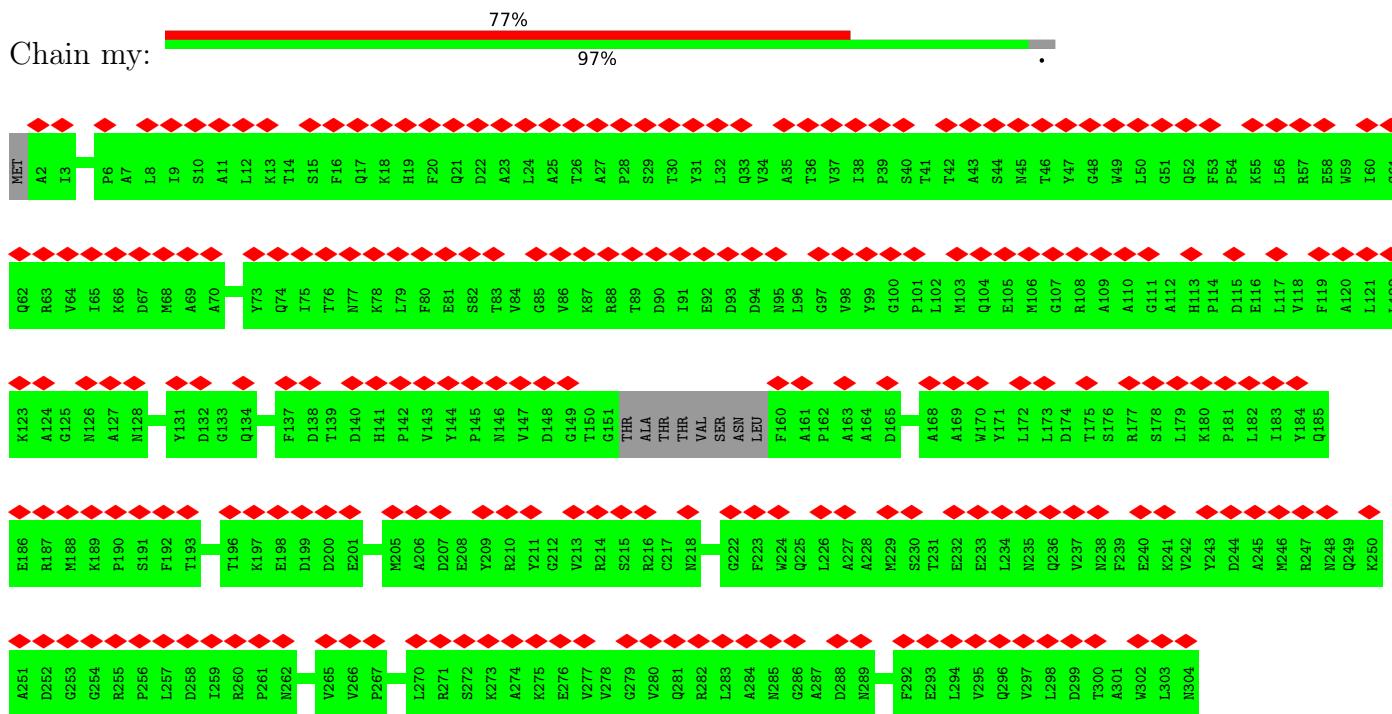

• Molecule 2: Bacteriophage Mu GpT domain-containing protein

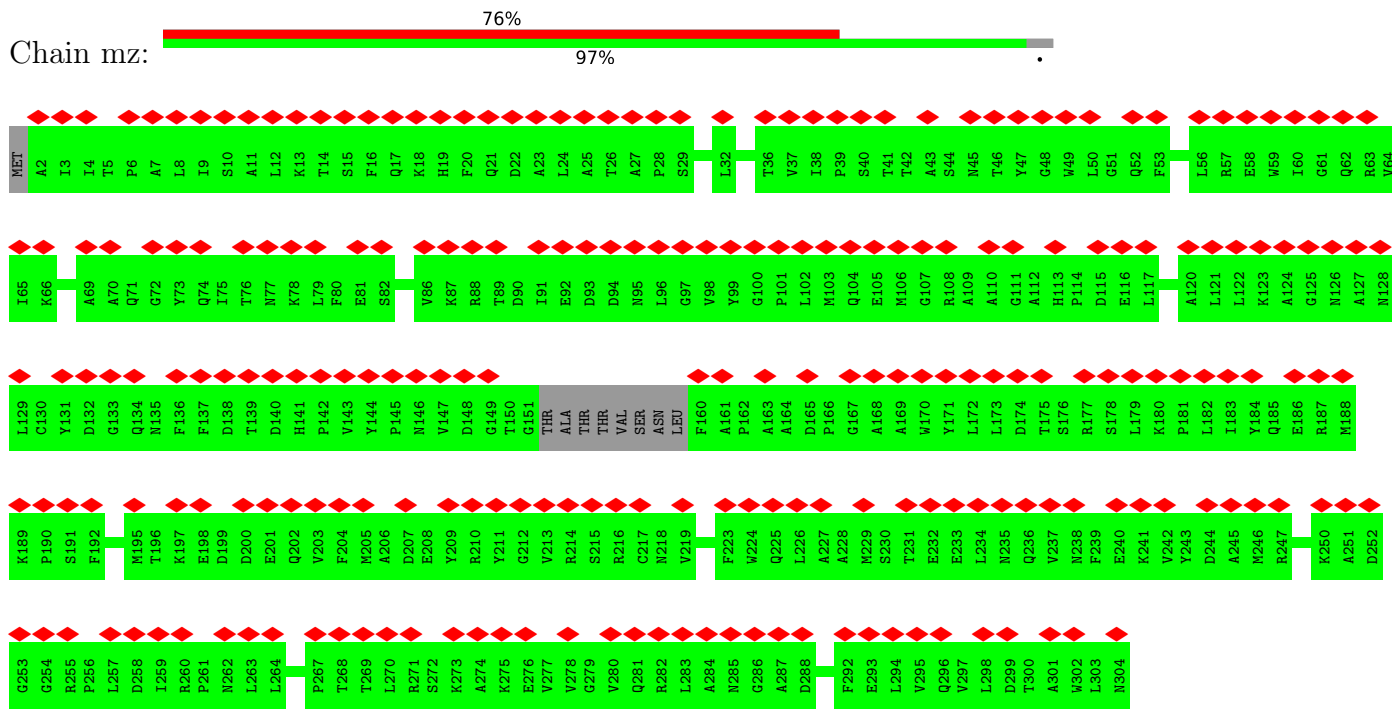

• Molecule 2: Bacteriophage Mu GpT domain-containing protein

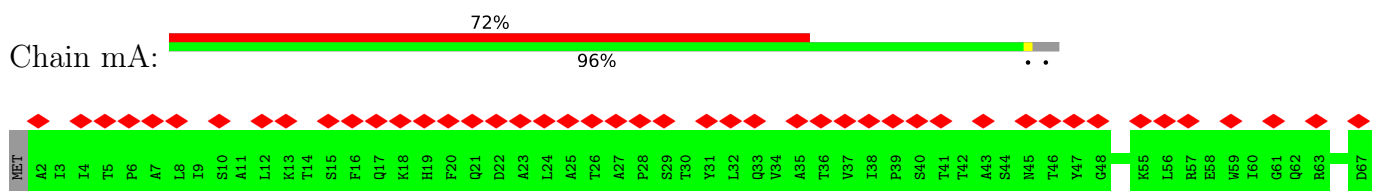

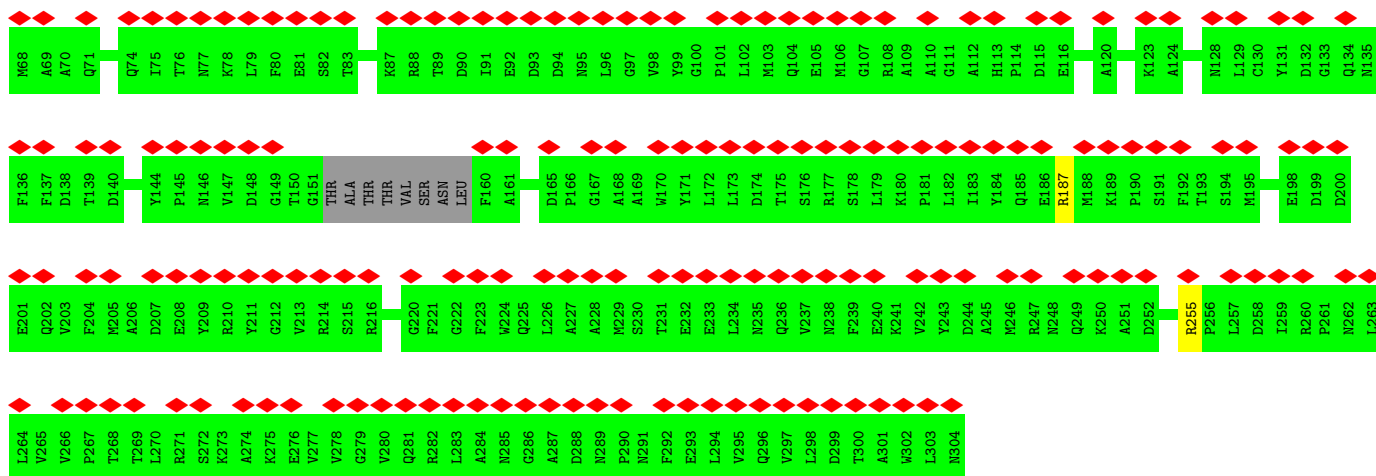

• Molecule 2: Bacteriophage Mu GpT domain-containing protein

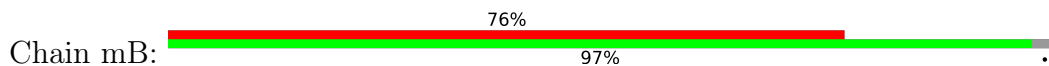

• Molecule 2: Bacteriophage Mu GpT domain-containing protein

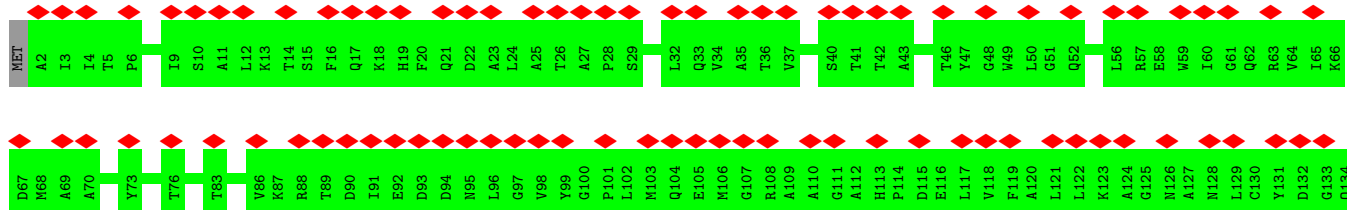

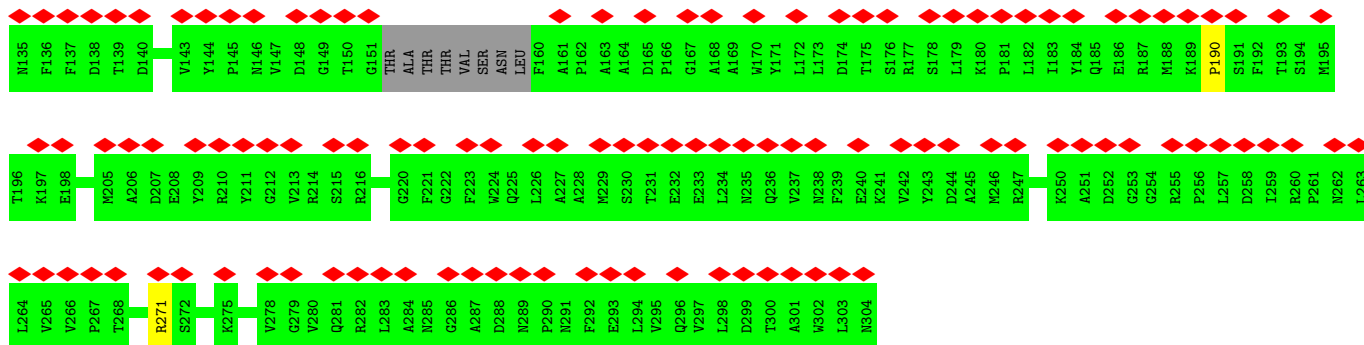

• Molecule 2: Bacteriophage Mu GpT domain-containing protein



• Molecule 2: Bacteriophage Mu GpT domain-containing protein

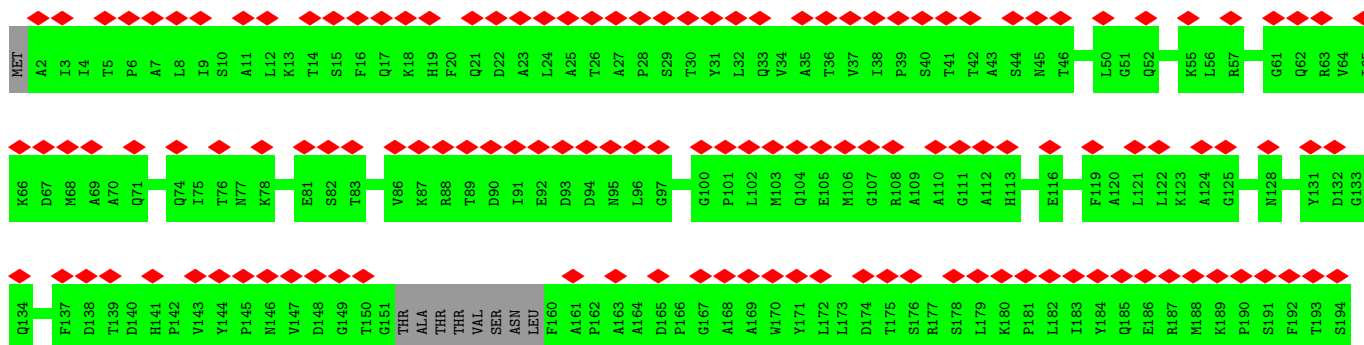

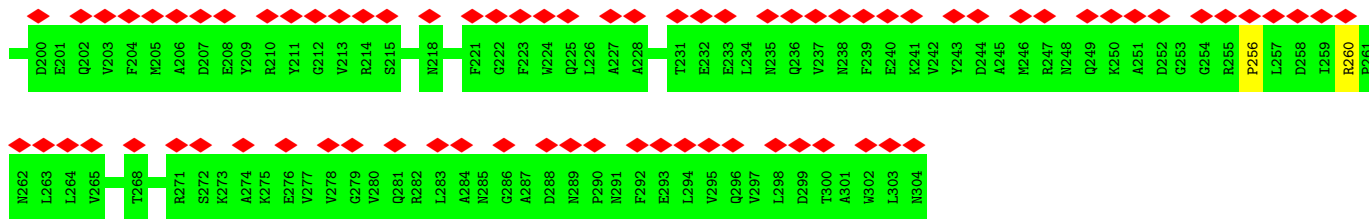

• Molecule 2: Bacteriophage Mu GpT domain-containing protein

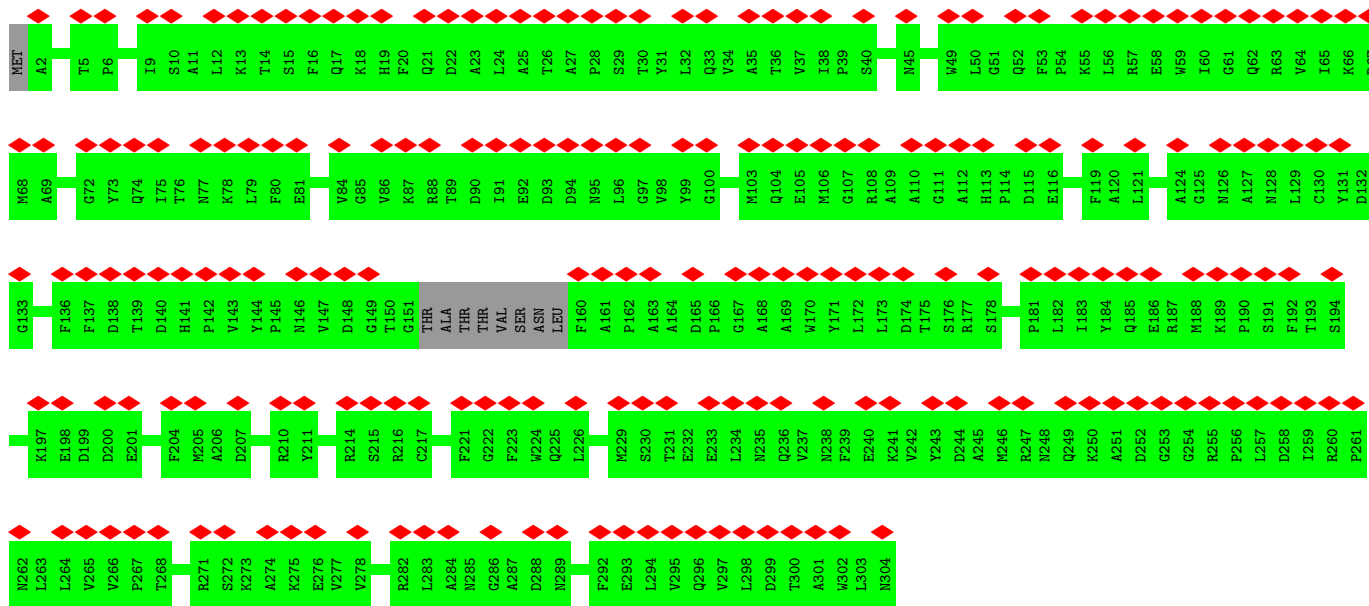
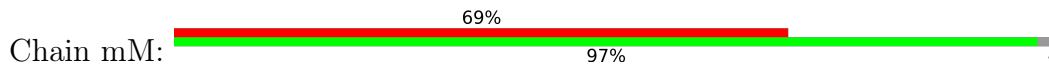

• Molecule 2: Bacteriophage Mu GpT domain-containing protein

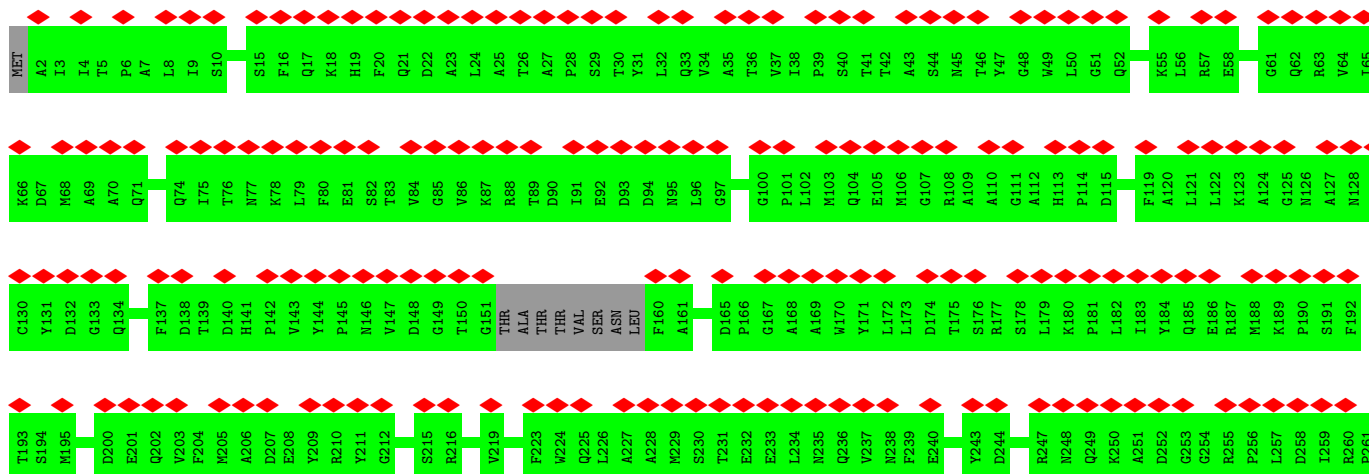
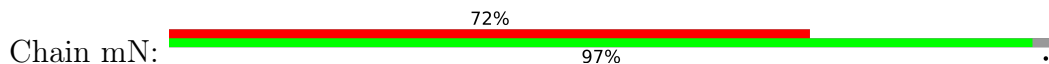

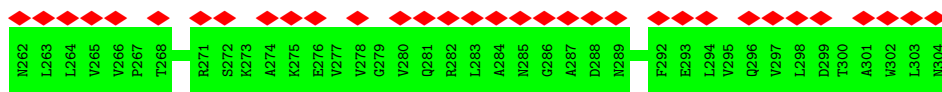

• Molecule 2: Bacteriophage Mu GpT domain-containing protein



• Molecule 2: Bacteriophage Mu GpT domain-containing protein



• Molecule 2: Bacteriophage Mu GpT domain-containing protein

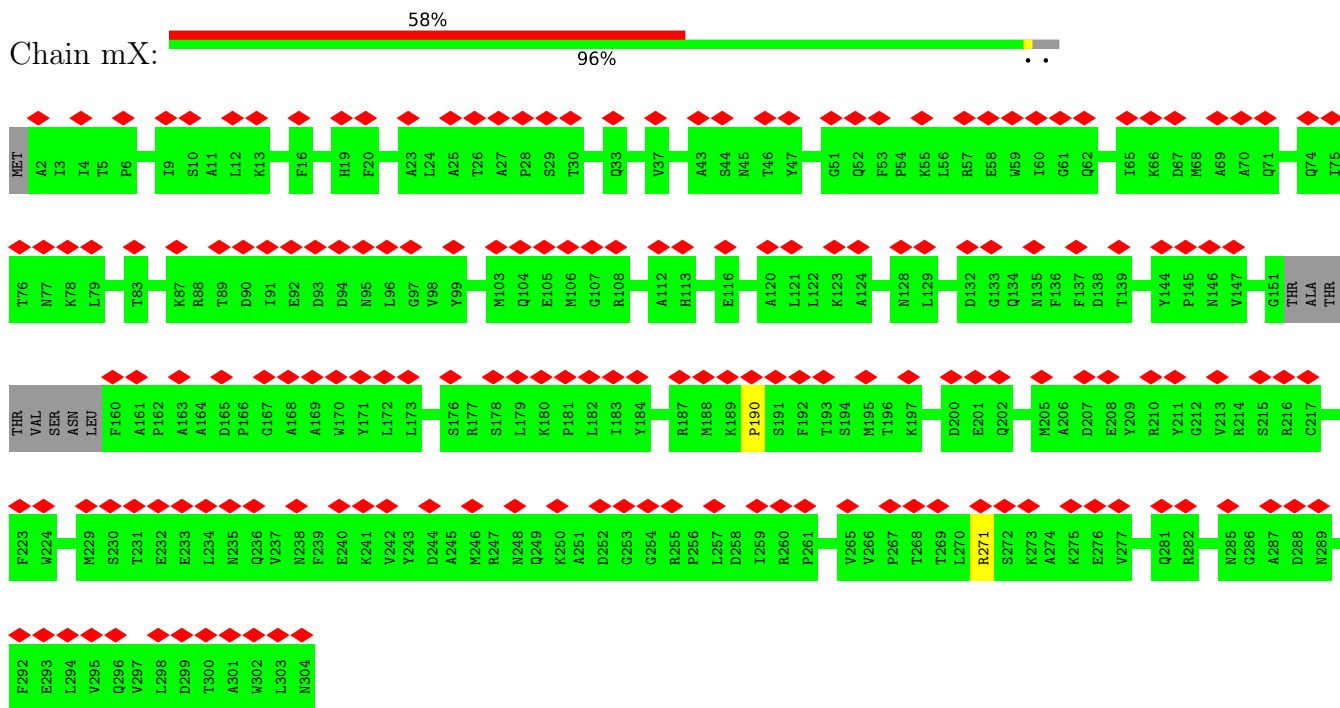

• Molecule 2: Bacteriophage Mu GpT domain-containing protein

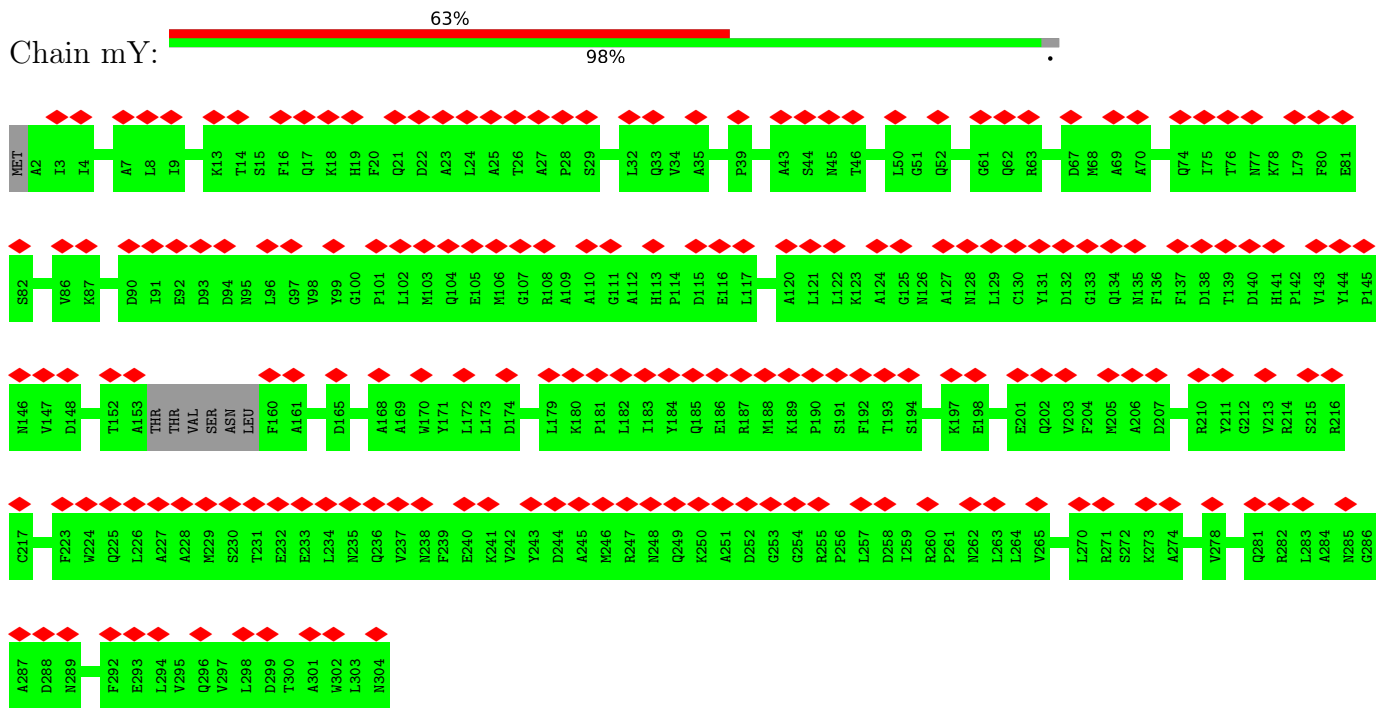

• Molecule 2: Bacteriophage Mu GpT domain-containing protein

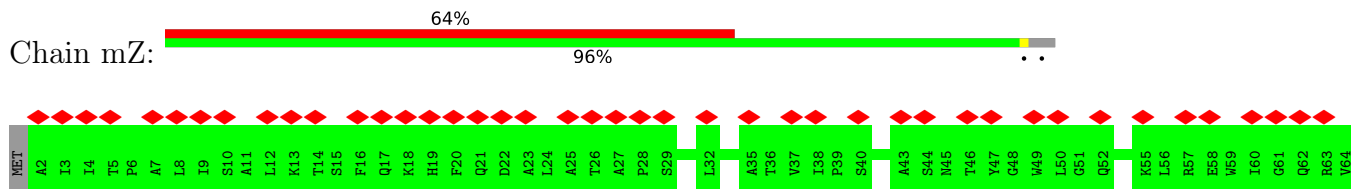

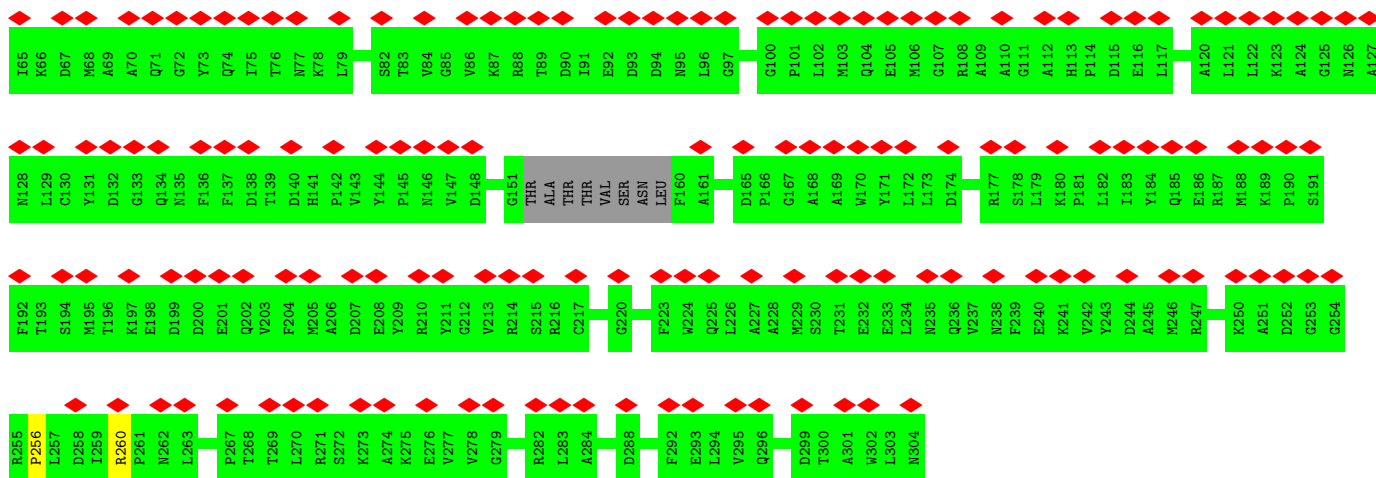

• Molecule 2: Bacteriophage Mu GpT domain-containing protein

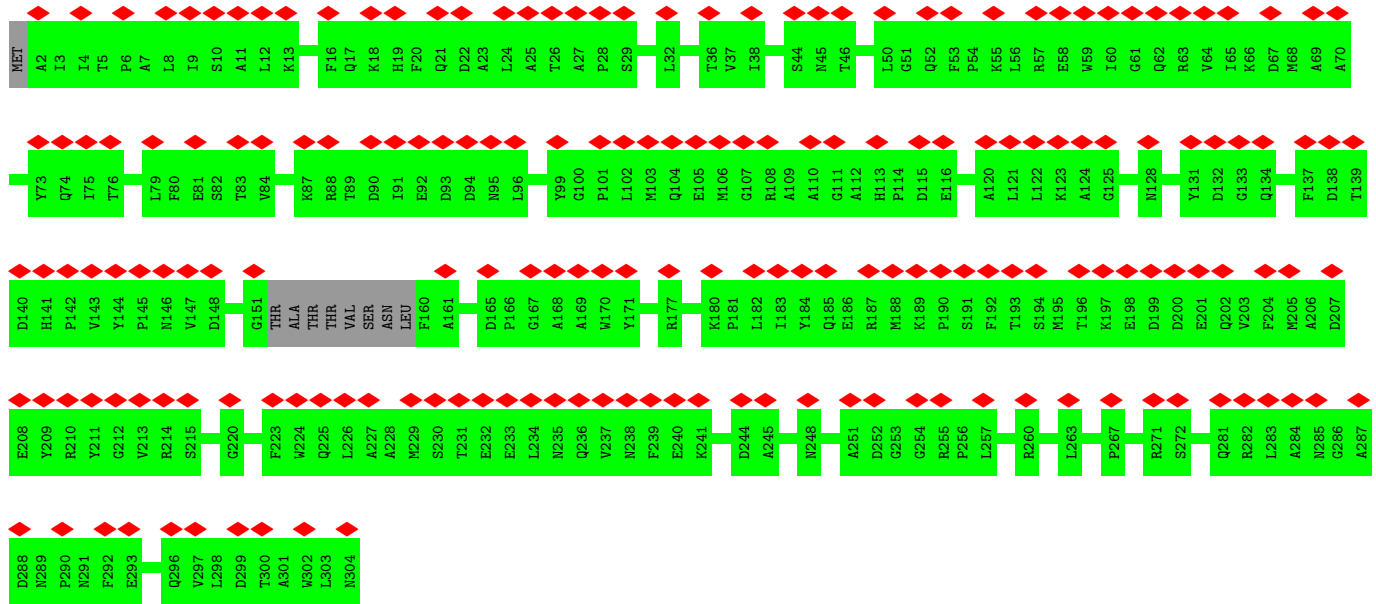

• Molecule 2: Bacteriophage Mu GpT domain-containing protein

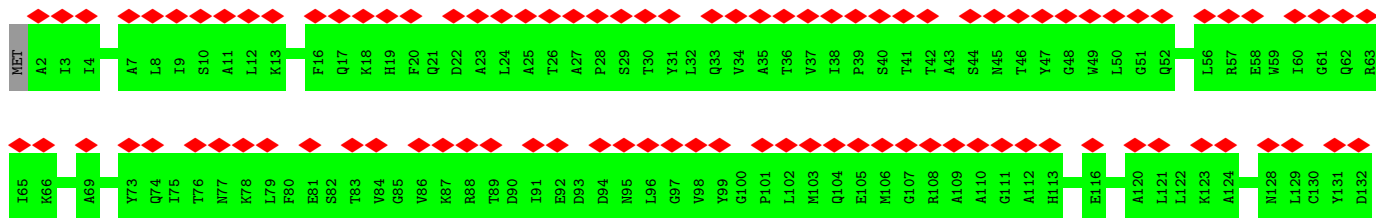

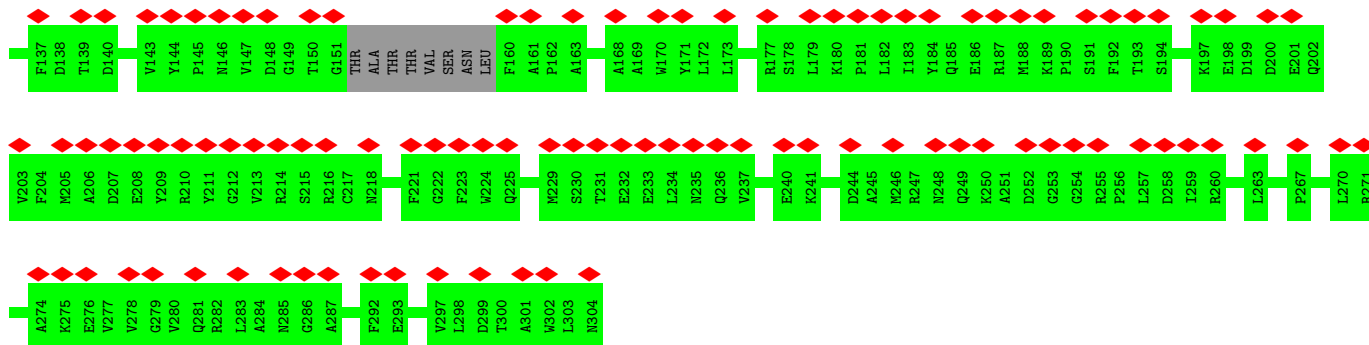

• Molecule 2: Bacteriophage Mu GpT domain-containing protein



• Molecule 2: Bacteriophage Mu GpT domain-containing protein

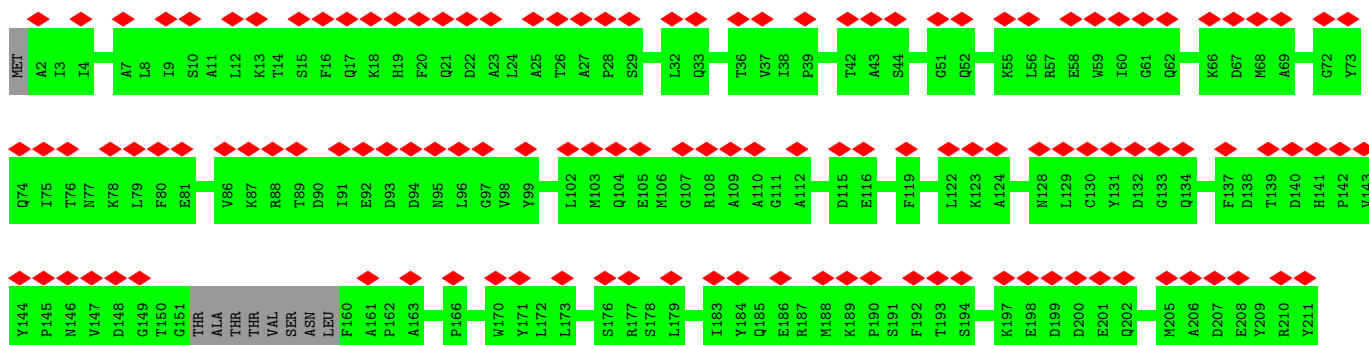

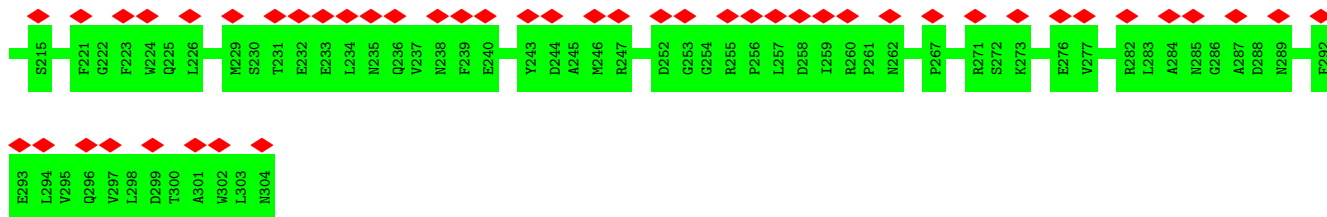

• Molecule 2: Bacteriophage Mu GpT domain-containing protein

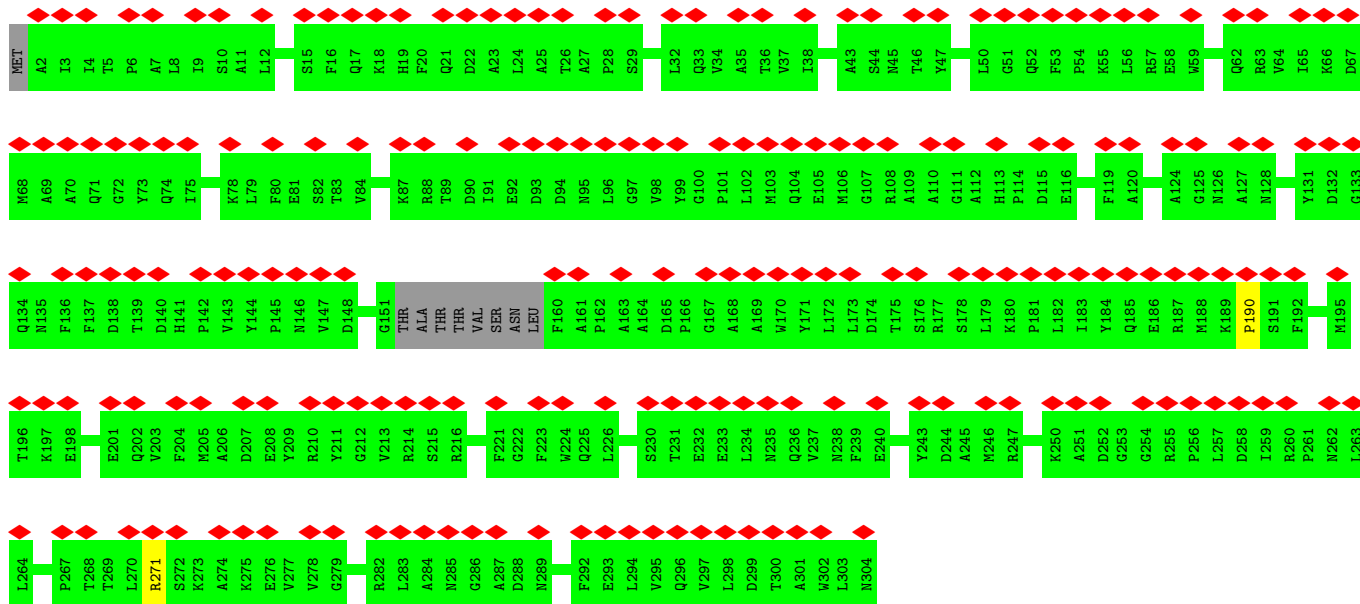

• Molecule 2: Bacteriophage Mu GpT domain-containing protein

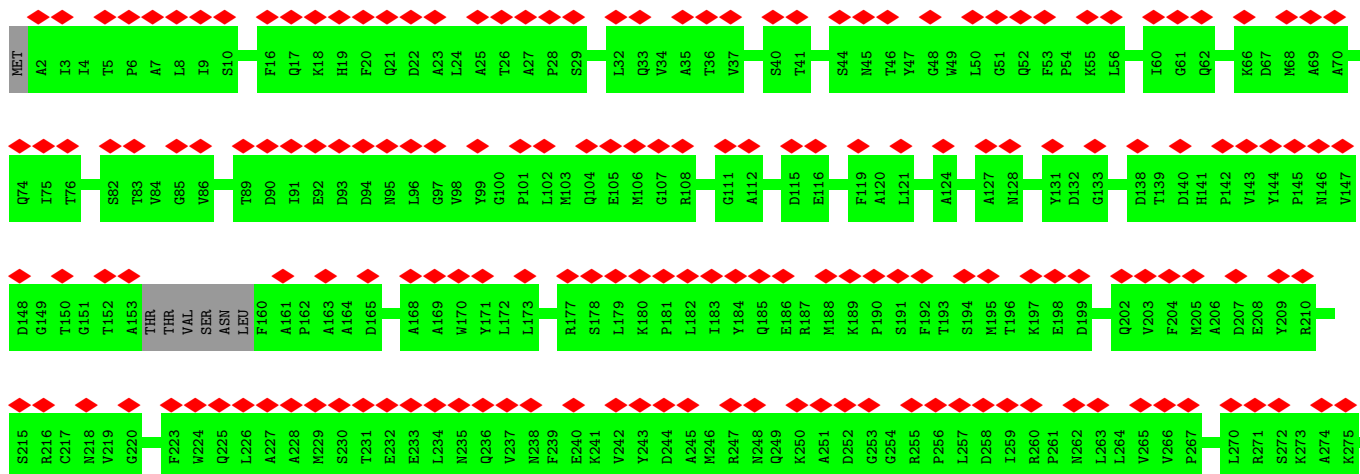

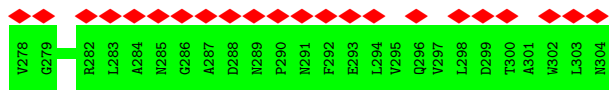

• Molecule 2: Bacteriophage Mu GpT domain-containing protein

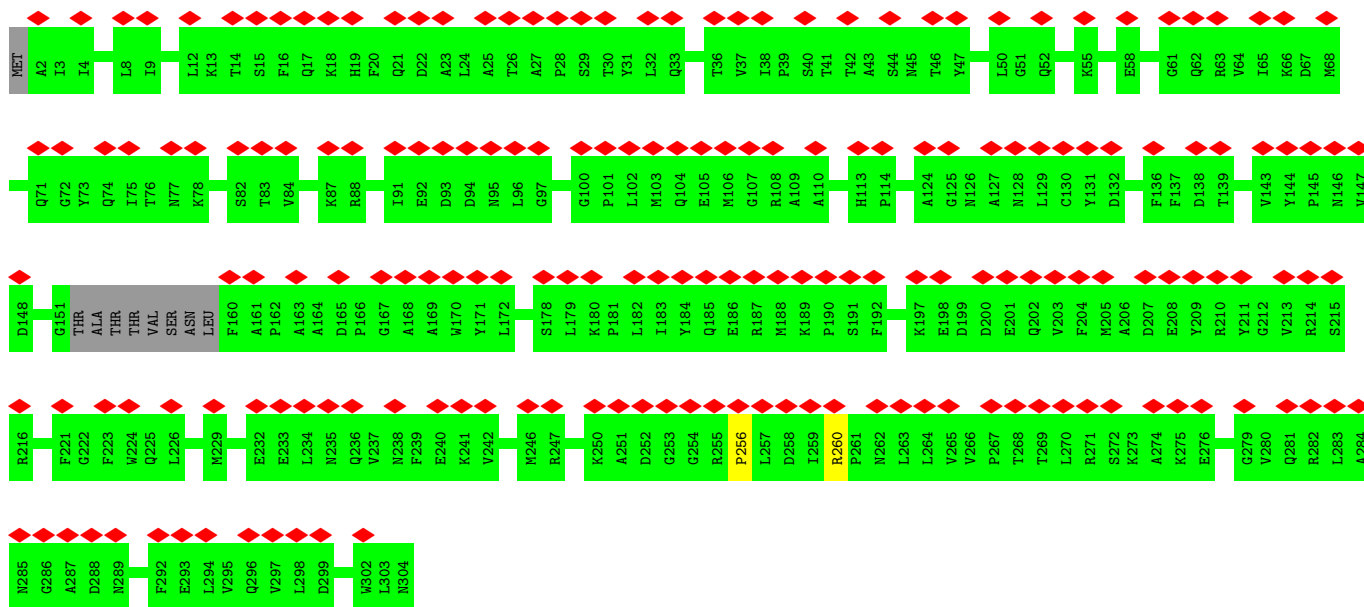

• Molecule 2: Bacteriophage Mu GpT domain-containing protein

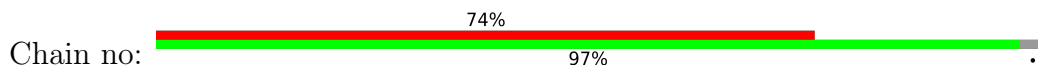

• Molecule 2: Bacteriophage Mu GpT domain-containing protein

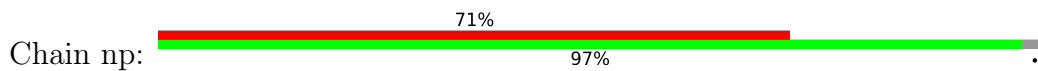

• Molecule 2: Bacteriophage Mu GpT domain-containing protein

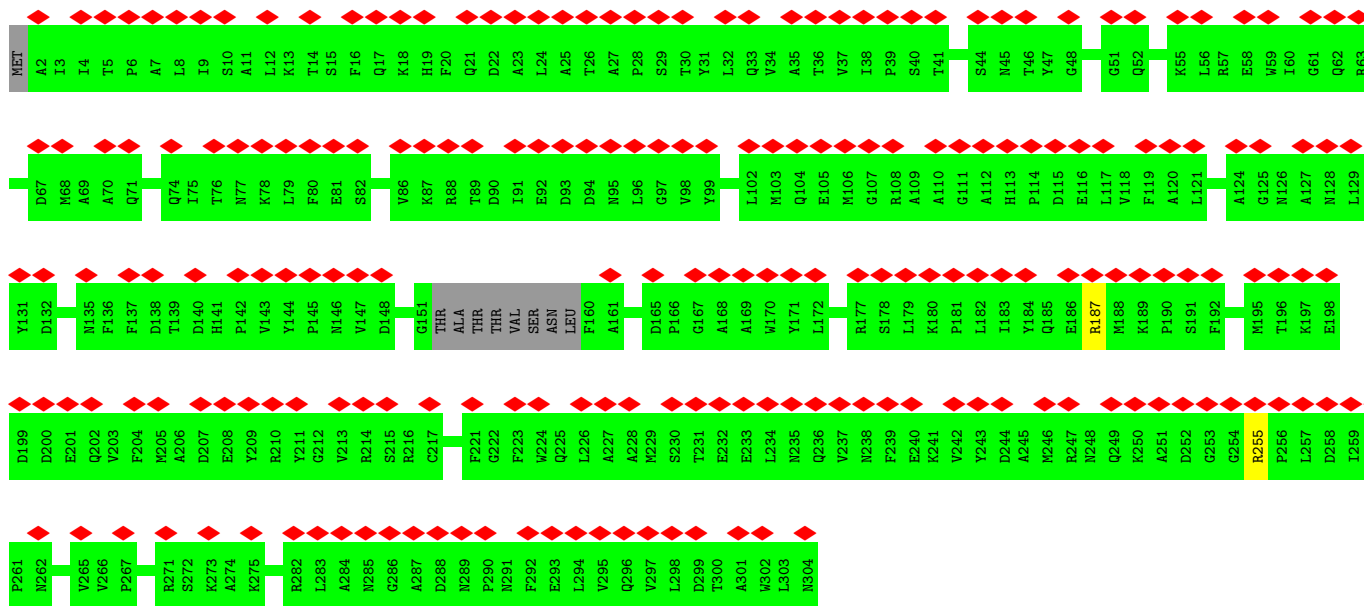

• Molecule 2: Bacteriophage Mu GpT domain-containing protein

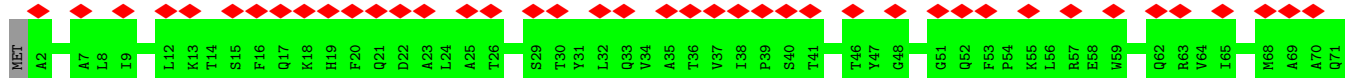

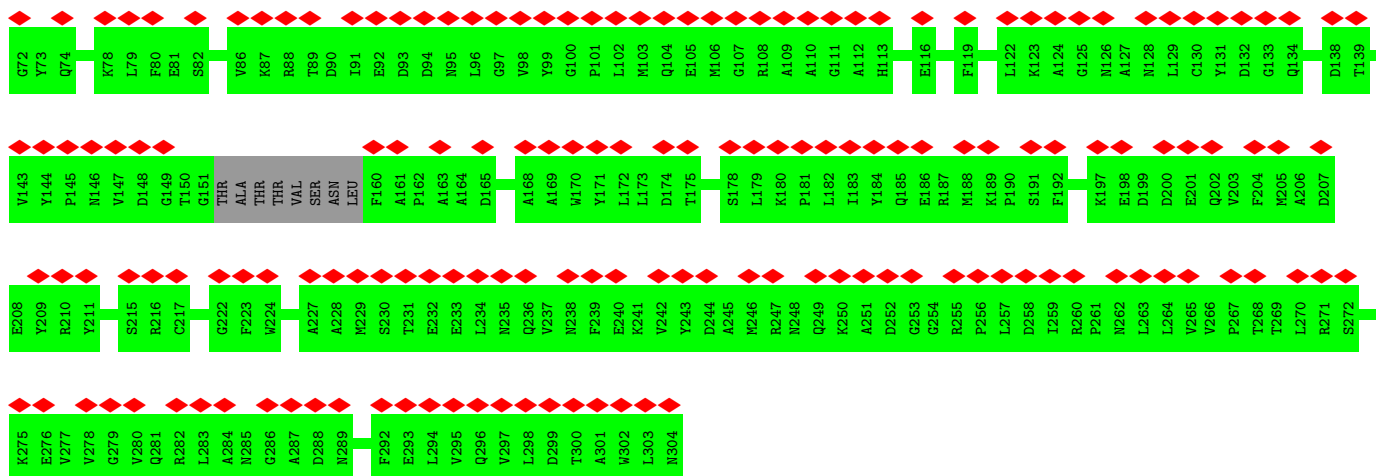

• Molecule 2: Bacteriophage Mu GpT domain-containing protein



• Molecule 2: Bacteriophage Mu GpT domain-containing protein

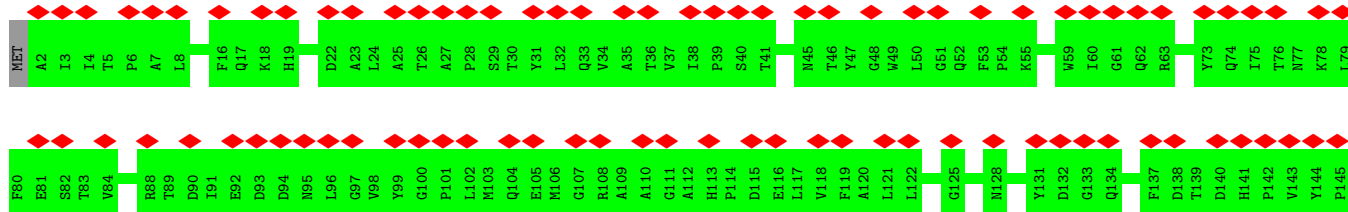

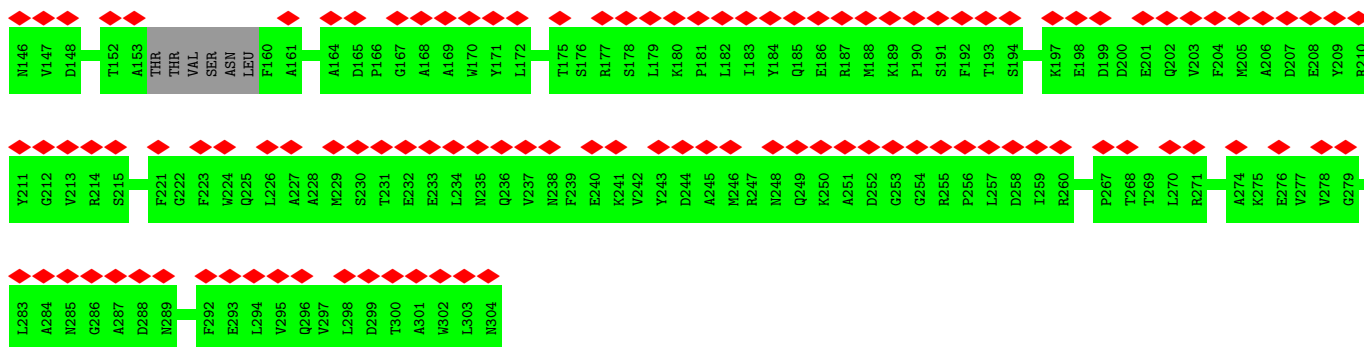

• Molecule 2: Bacteriophage Mu GpT domain-containing protein



• Molecule 2: Bacteriophage Mu GpT domain-containing protein

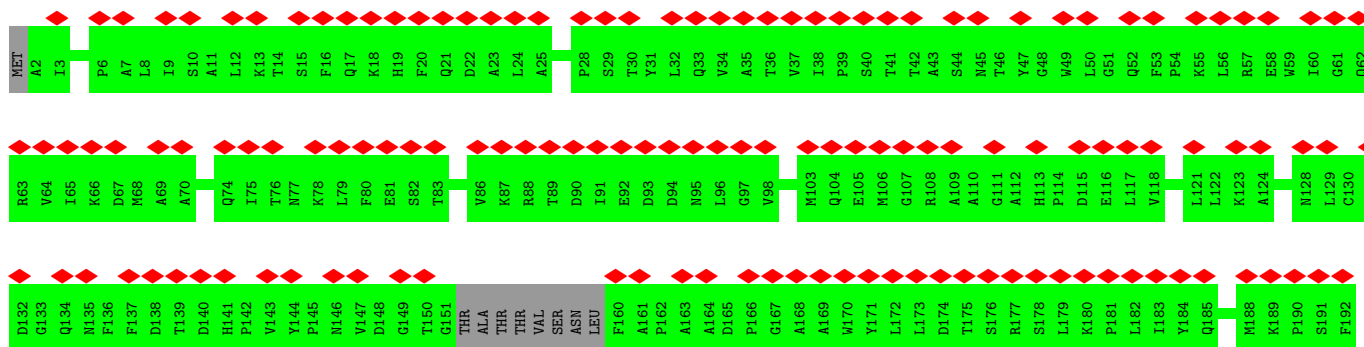
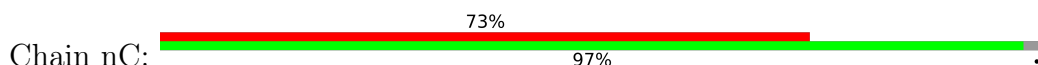

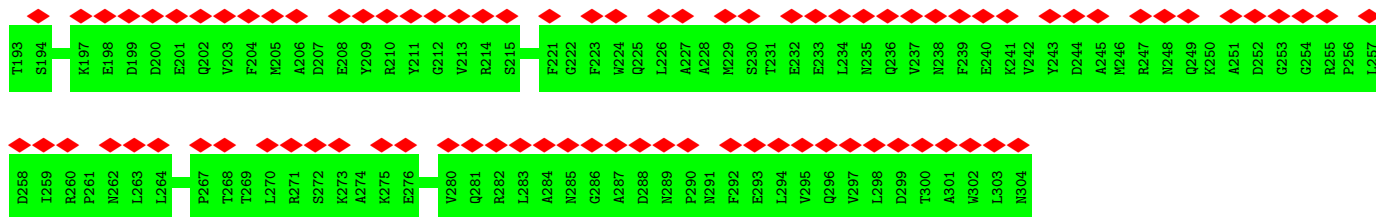

• Molecule 2: Bacteriophage Mu GpT domain-containing protein

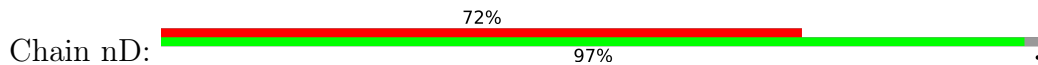

• Molecule 2: Bacteriophage Mu GpT domain-containing protein

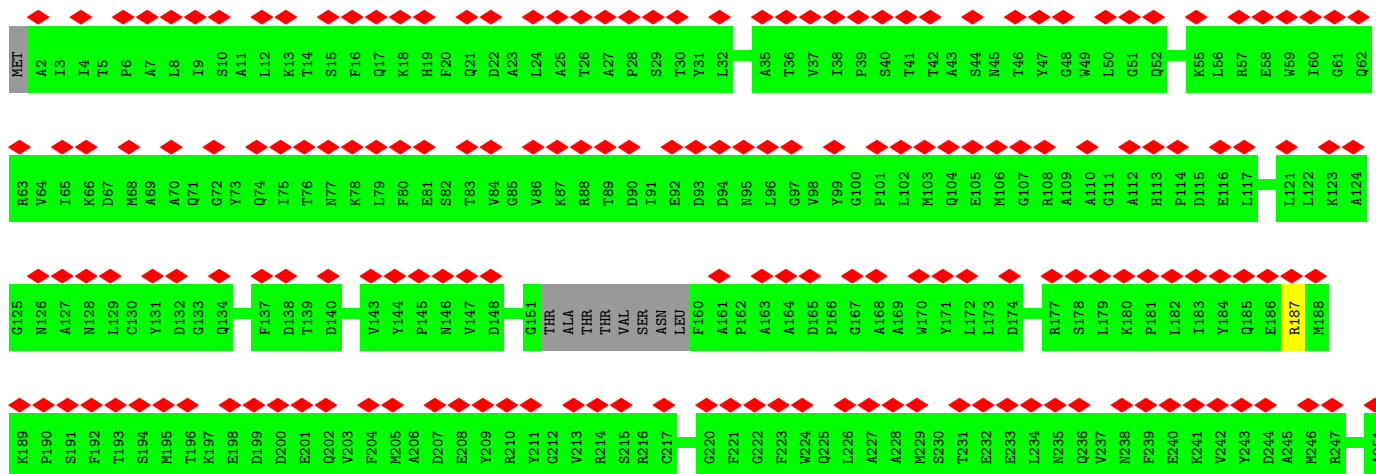
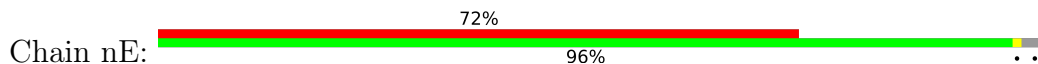

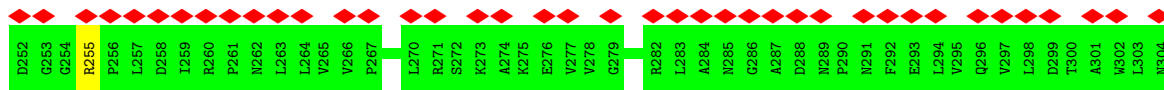

• Molecule 2: Bacteriophage Mu GpT domain-containing protein



• Molecule 2: Bacteriophage Mu GpT domain-containing protein

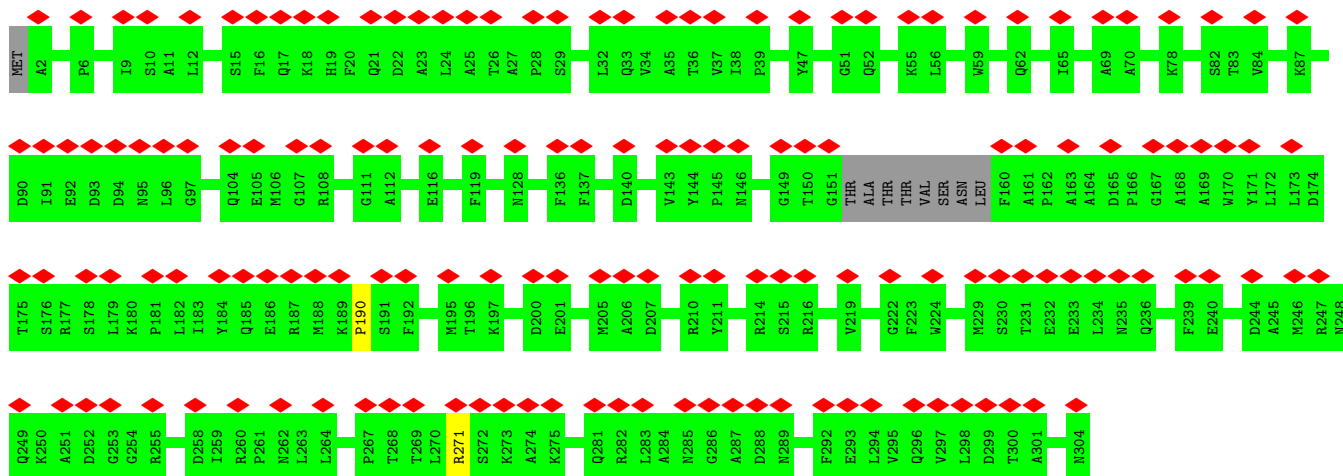

• Molecule 2: Bacteriophage Mu GpT domain-containing protein



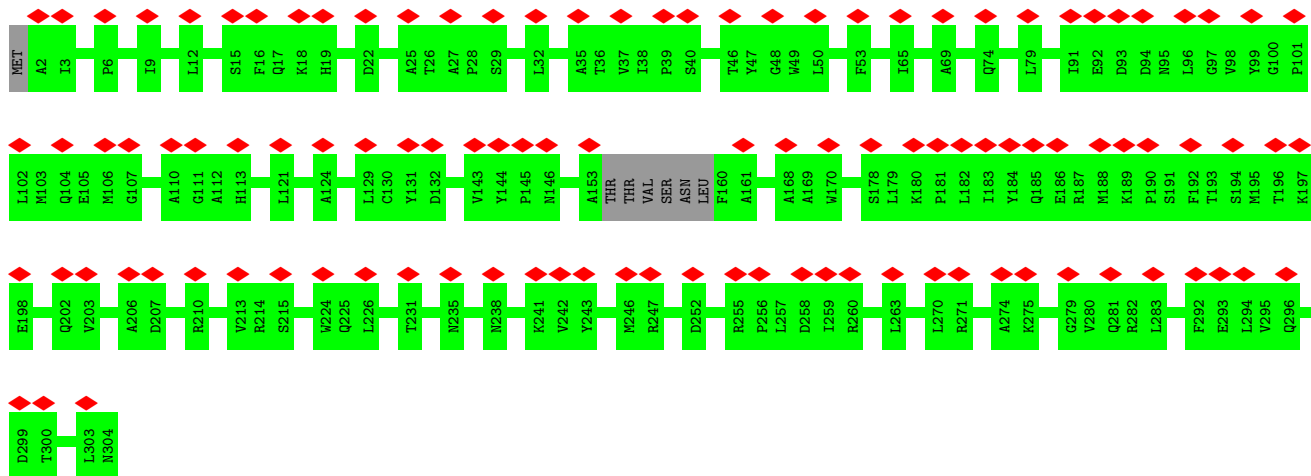

• Molecule 2: Bacteriophage Mu GpT domain-containing protein

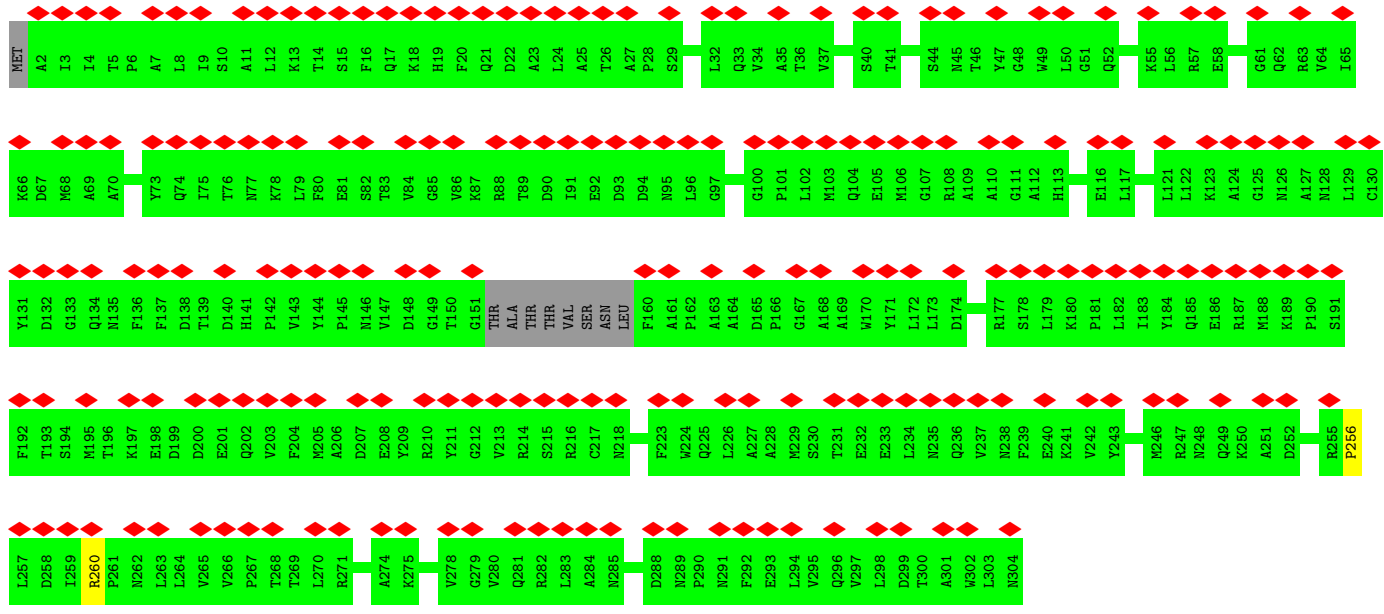

• Molecule 2: Bacteriophage Mu GpT domain-containing protein

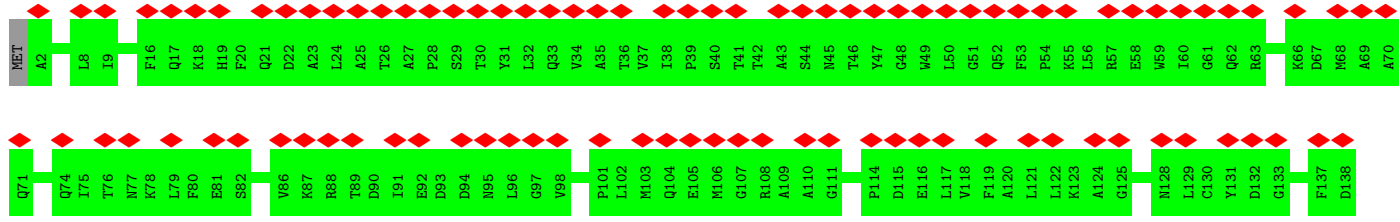

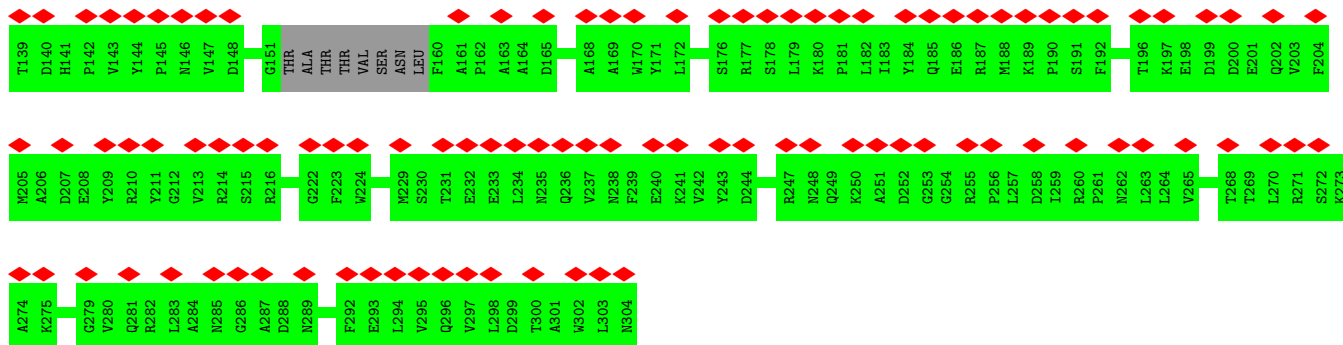

• Molecule 2: Bacteriophage Mu GpT domain-containing protein

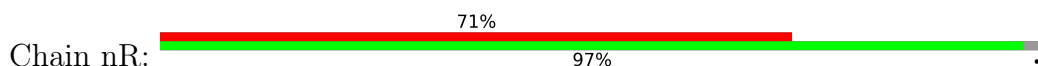

• Molecule 2: Bacteriophage Mu GpT domain-containing protein



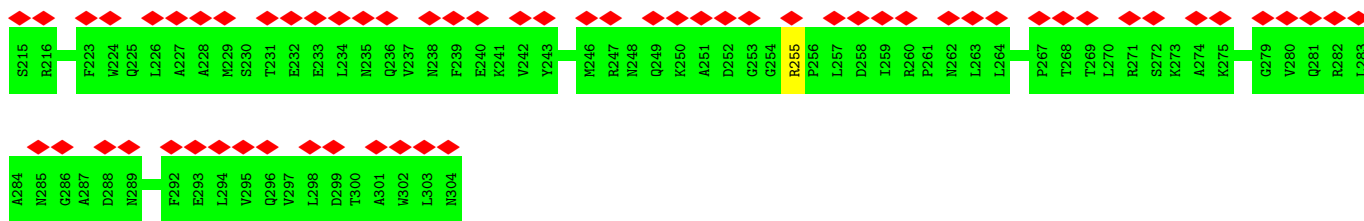

• Molecule 2: Bacteriophage Mu GpT domain-containing protein

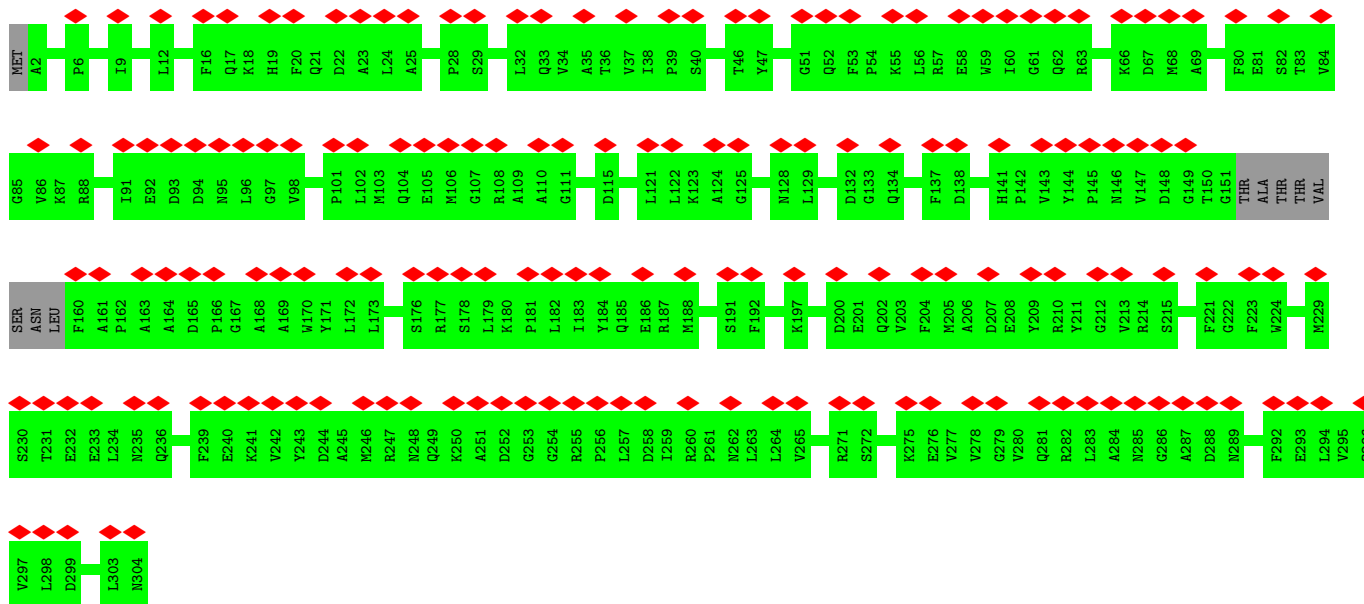

• Molecule 2: Bacteriophage Mu GpT domain-containing protein

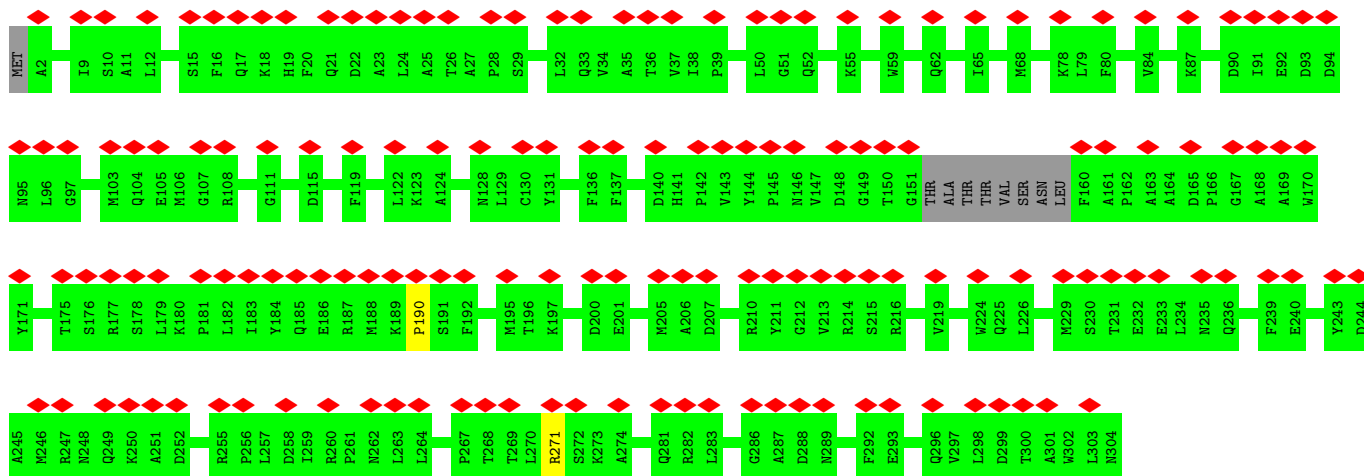

• Molecule 2: Bacteriophage Mu GpT domain-containing protein

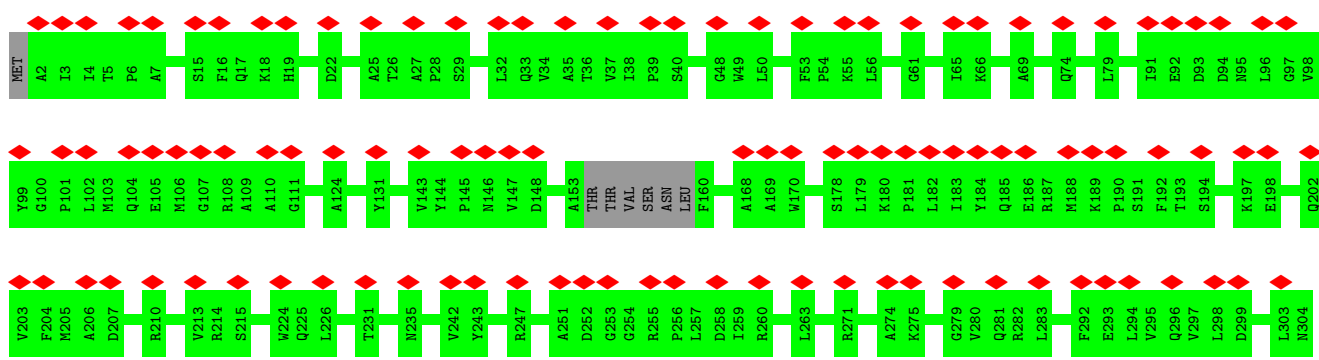

• Molecule 2: Bacteriophage Mu GpT domain-containing protein

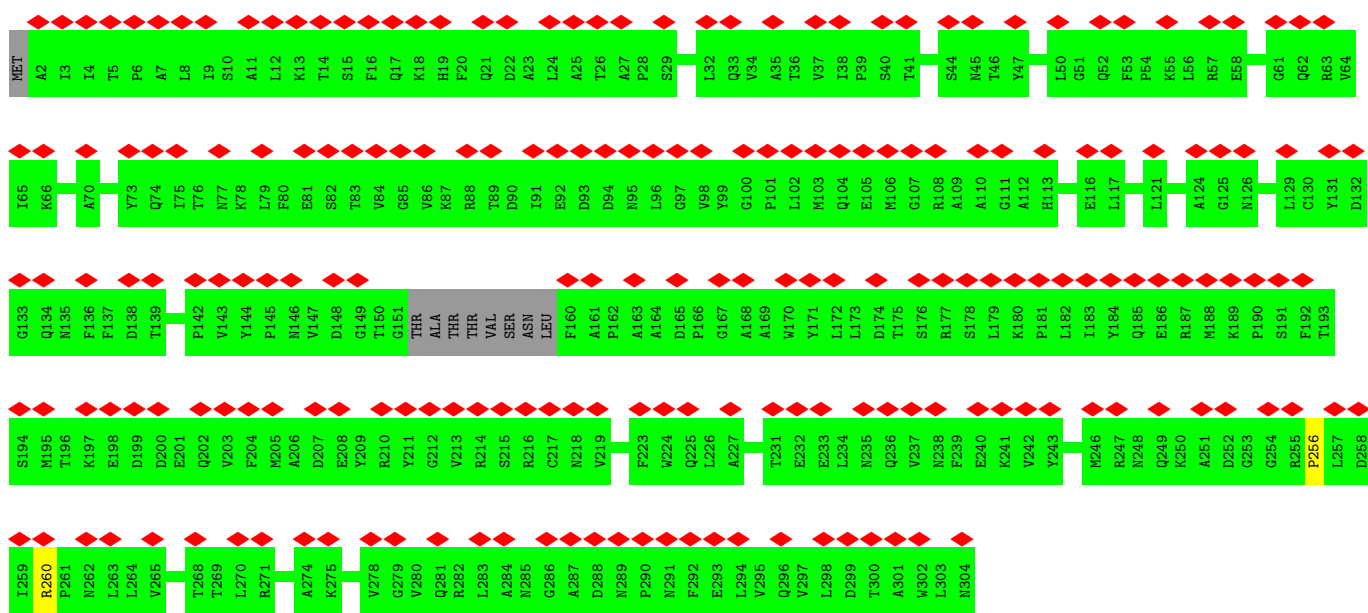

• Molecule 2: Bacteriophage Mu GpT domain-containing protein

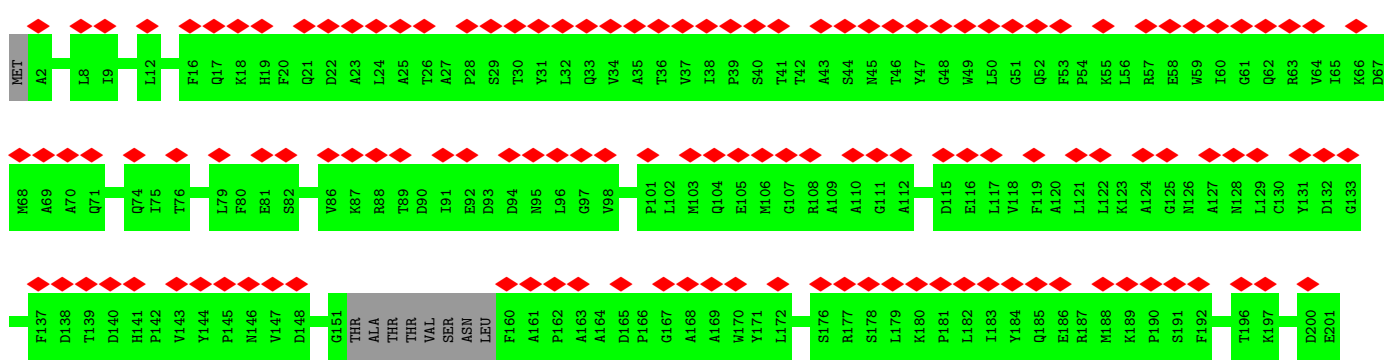

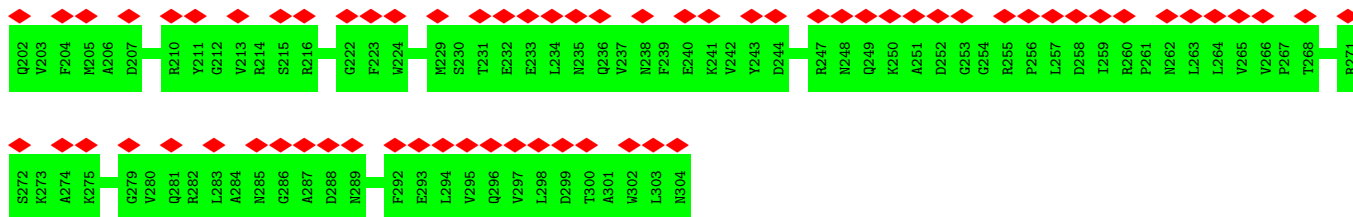

• Molecule 2: Bacteriophage Mu GpT domain-containing protein

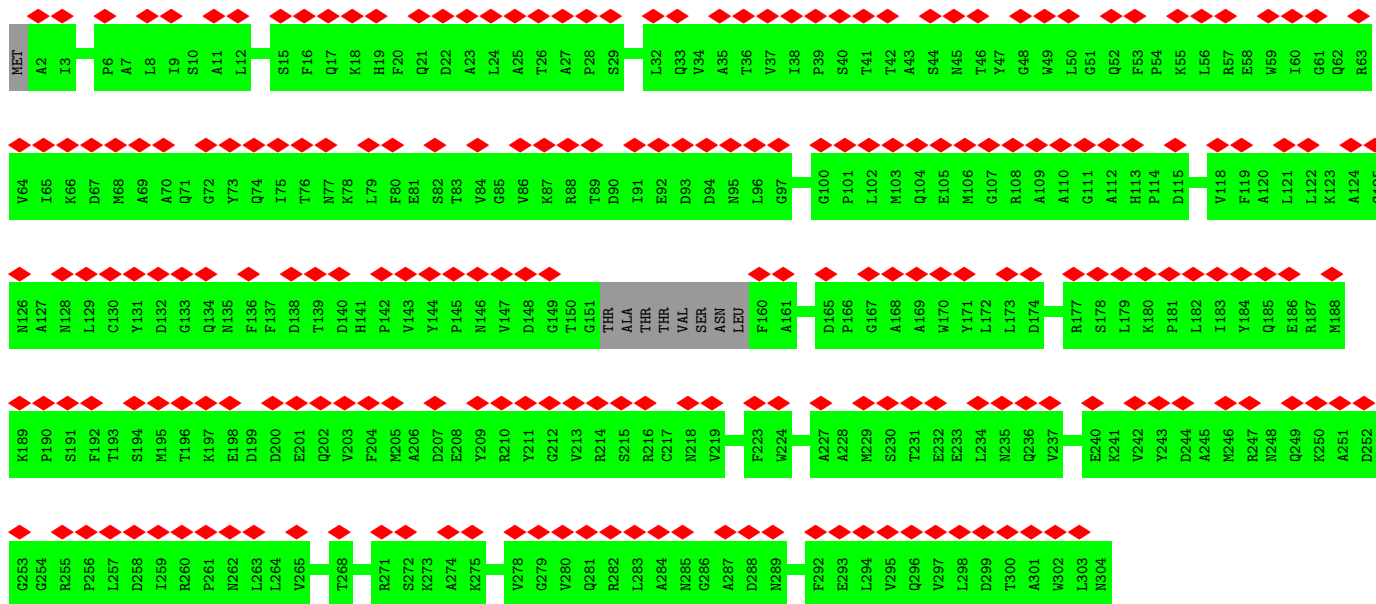
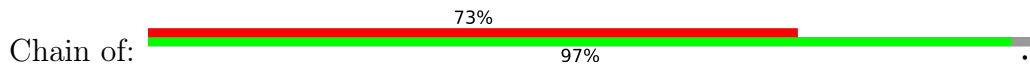

• Molecule 2: Bacteriophage Mu GpT domain-containing protein

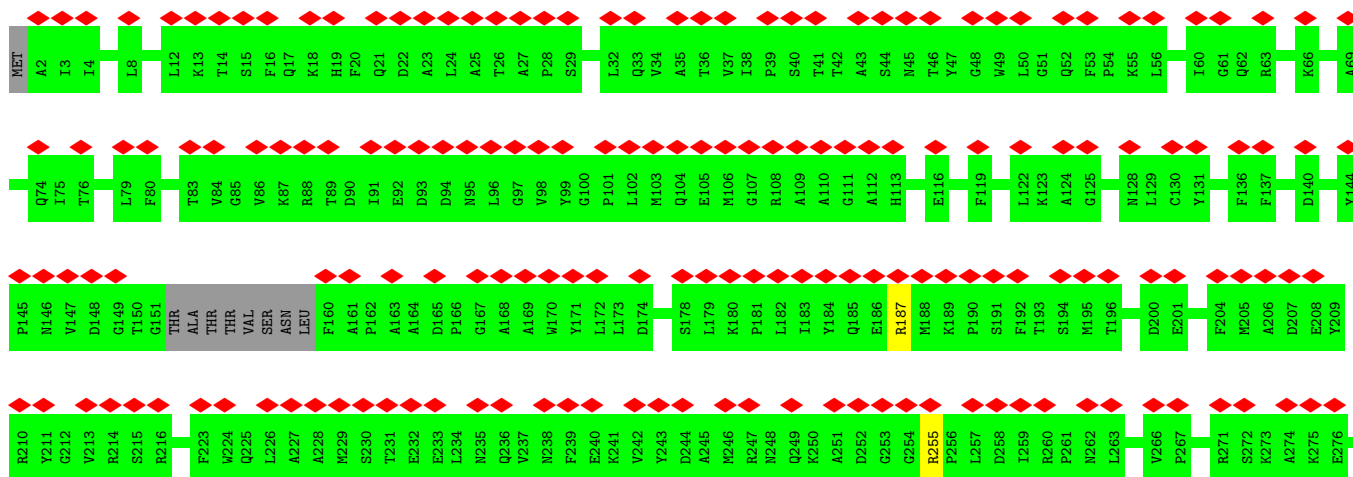

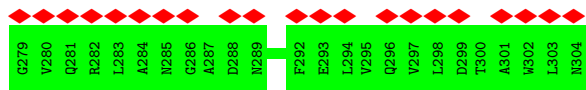

• Molecule 2: Bacteriophage Mu GpT domain-containing protein

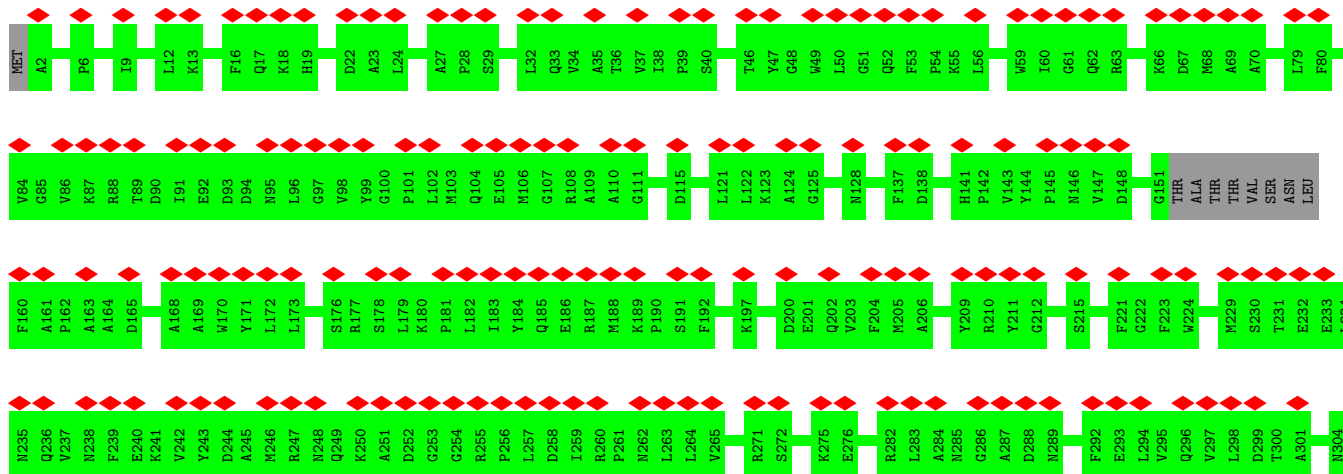

• Molecule 2: Bacteriophage Mu GpT domain-containing protein



• Molecule 2: Bacteriophage Mu GpT domain-containing protein



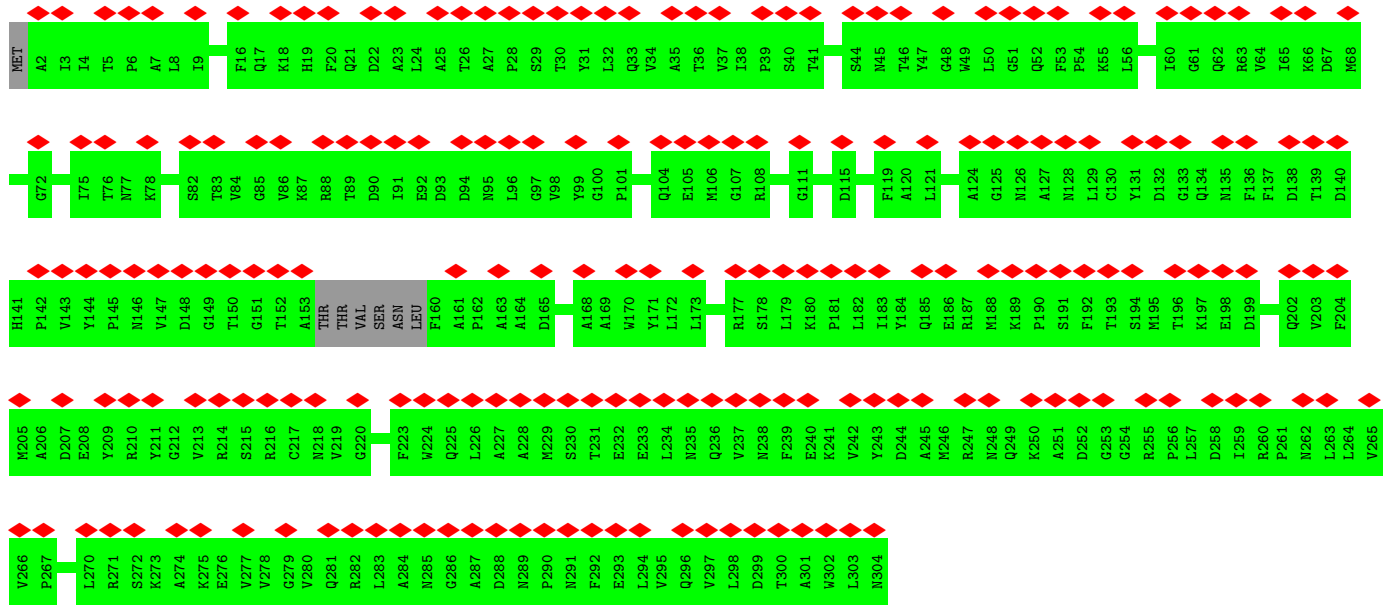

• Molecule 2: Bacteriophage Mu GpT domain-containing protein

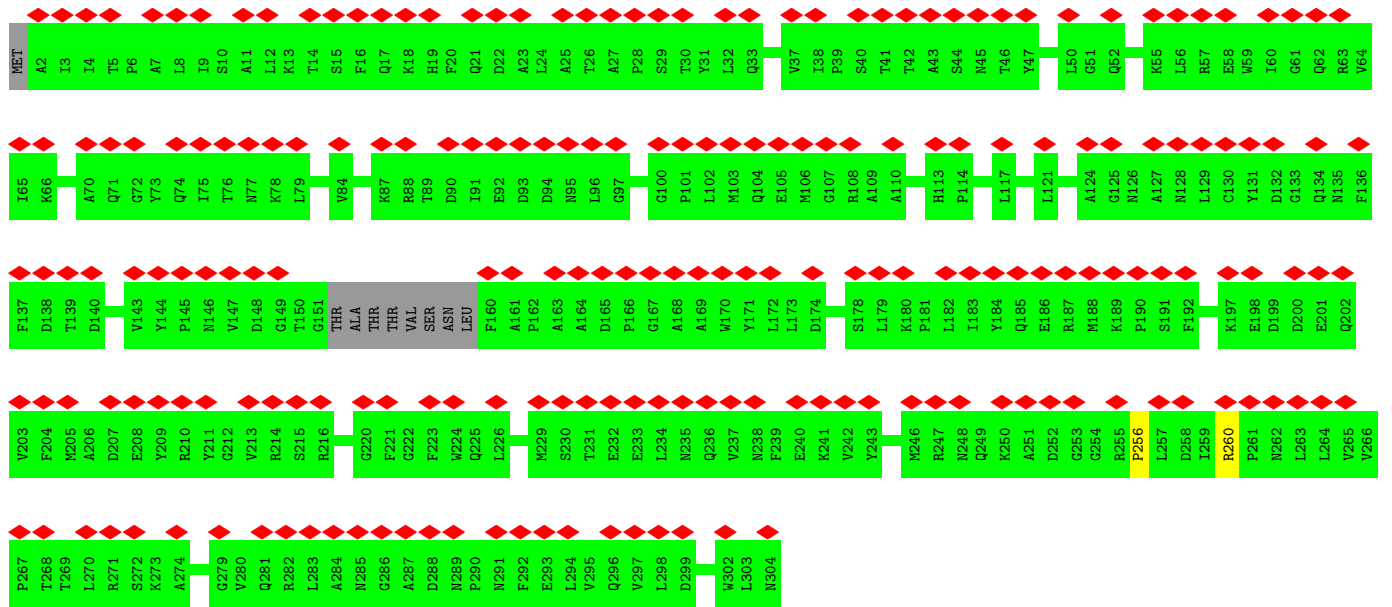

• Molecule 2: Bacteriophage Mu GpT domain-containing protein

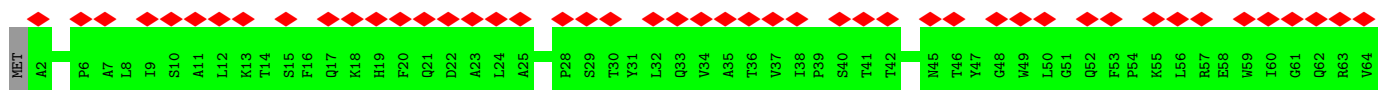
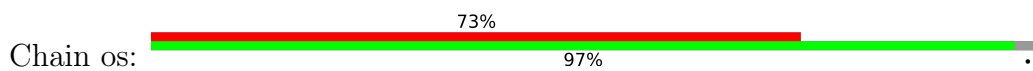

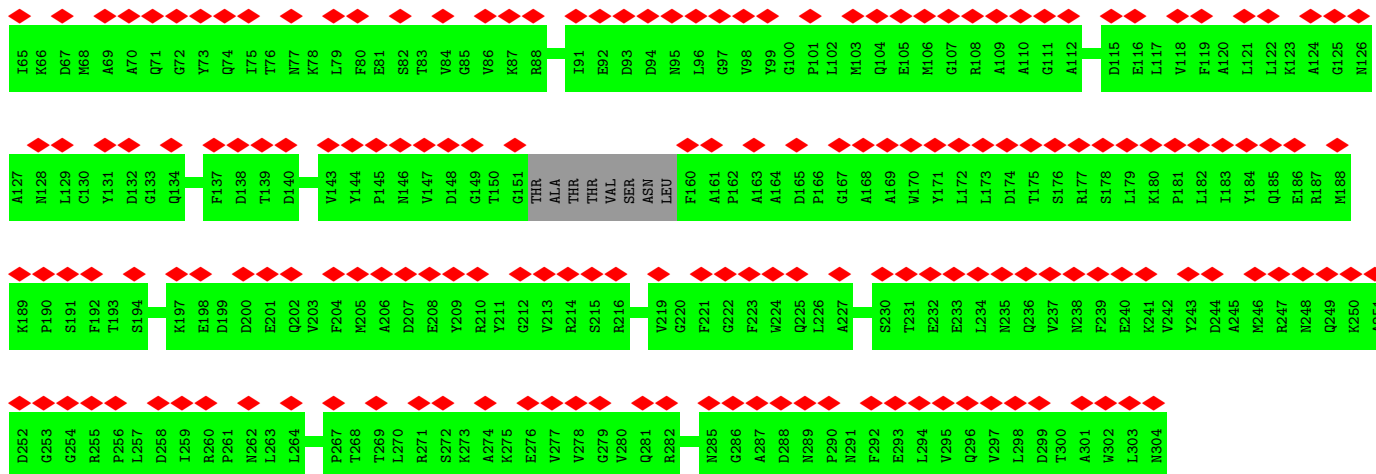

• Molecule 2: Bacteriophage Mu GpT domain-containing protein



• Molecule 2: Bacteriophage Mu GpT domain-containing protein

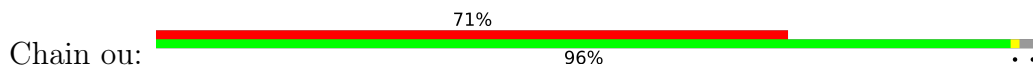

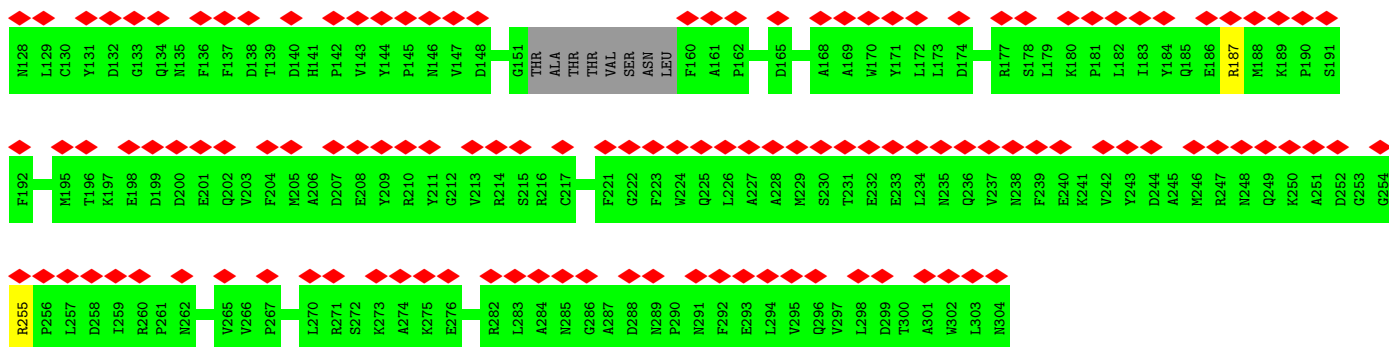

• Molecule 2: Bacteriophage Mu GpT domain-containing protein

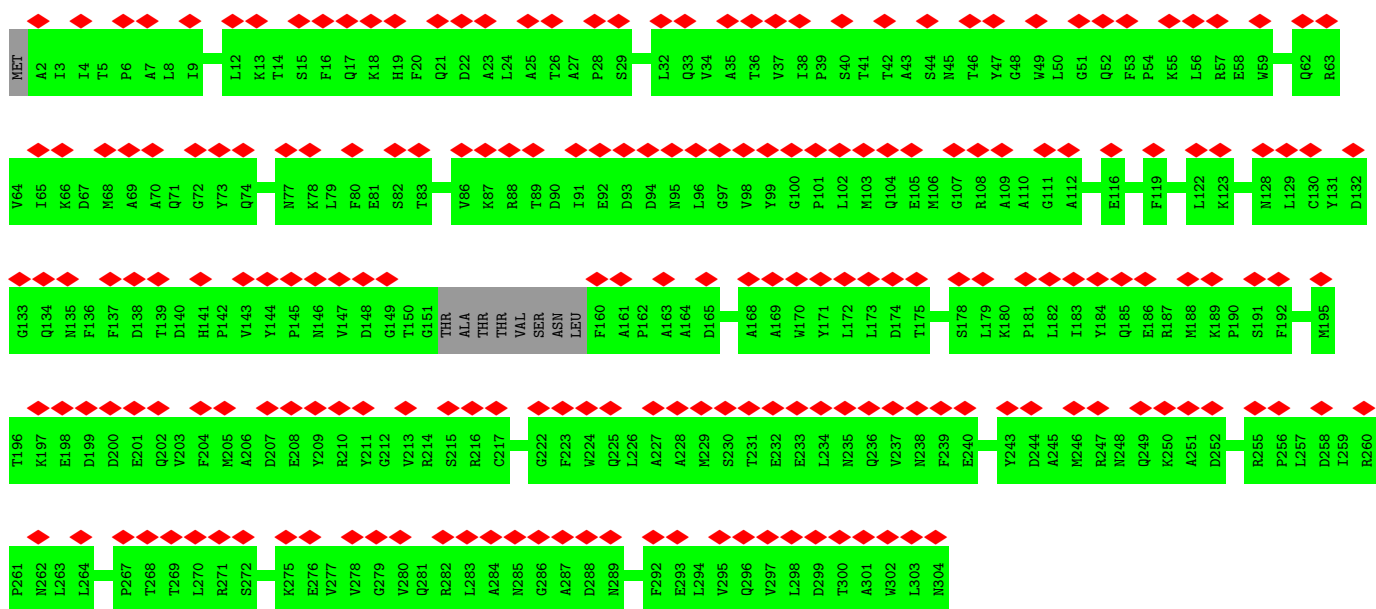

• Molecule 2: Bacteriophage Mu GpT domain-containing protein

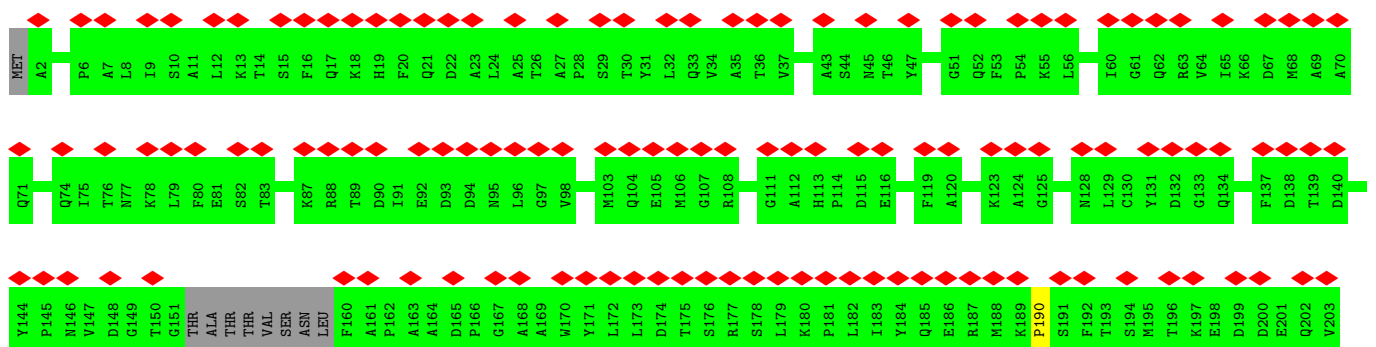

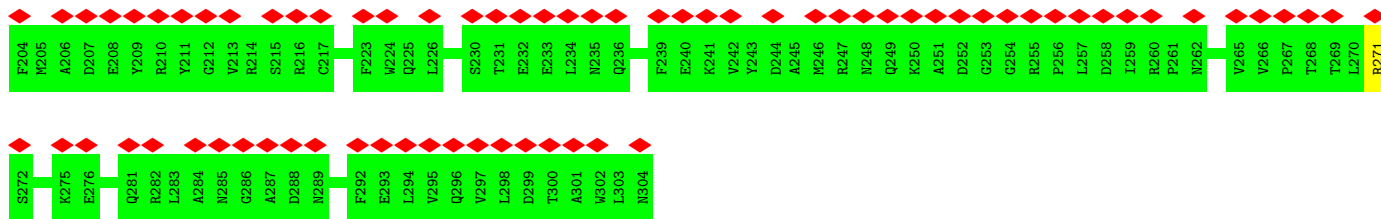

• Molecule 2: Bacteriophage Mu GpT domain-containing protein



• Molecule 2: Bacteriophage Mu GpT domain-containing protein

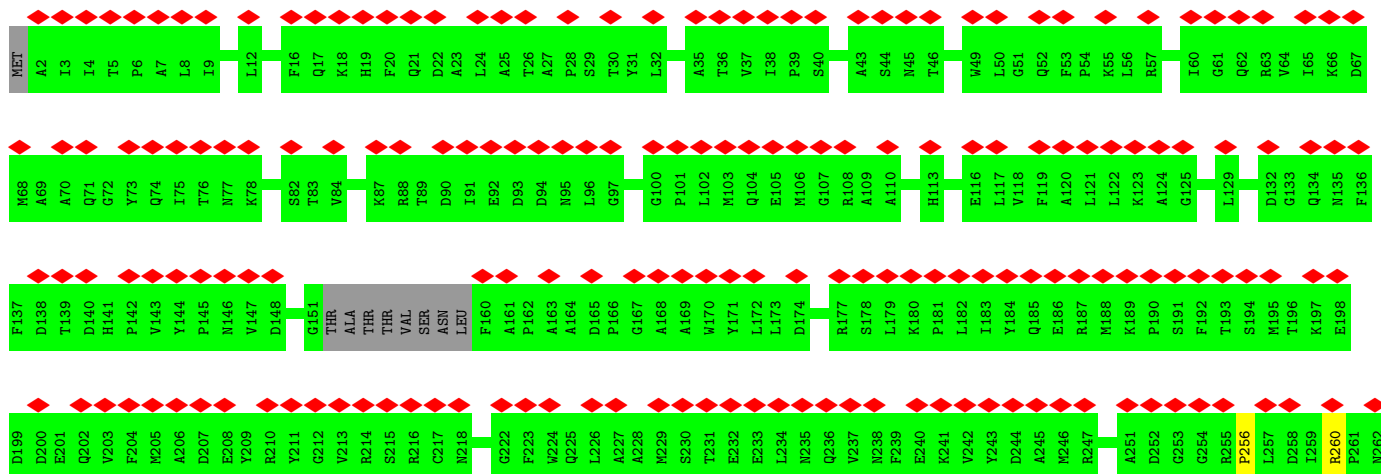

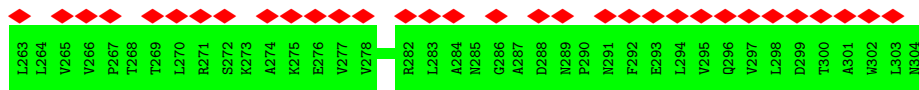

• Molecule 2: Bacteriophage Mu GpT domain-containing protein

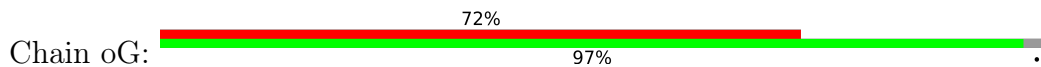

• Molecule 2: Bacteriophage Mu GpT domain-containing protein

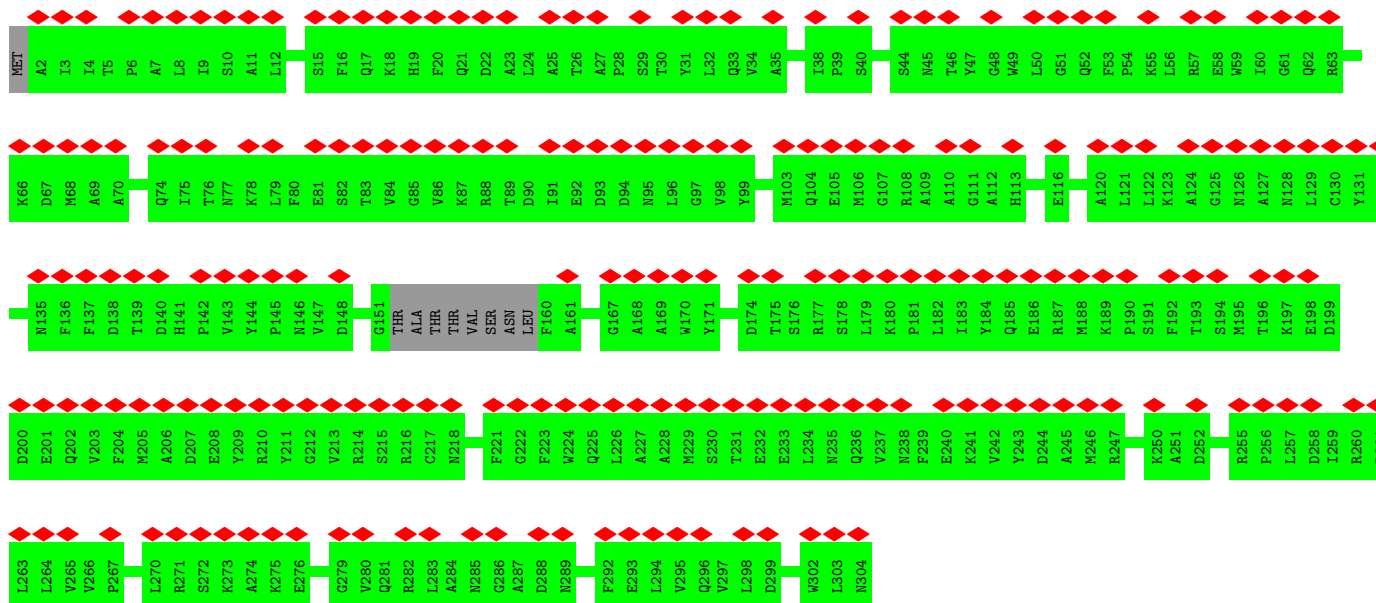
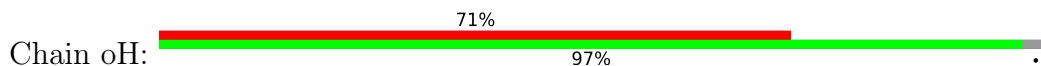

• Molecule 2: Bacteriophage Mu GpT domain-containing protein

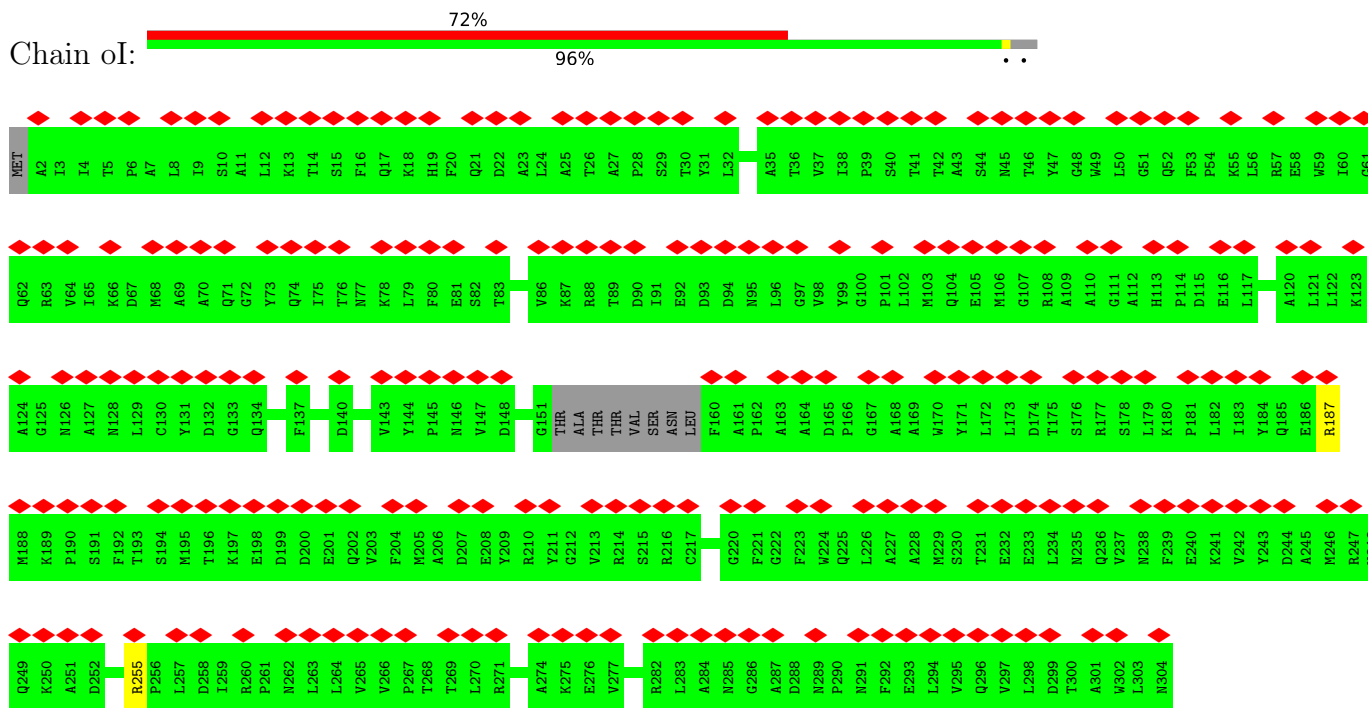

• Molecule 2: Bacteriophage Mu GpT domain-containing protein

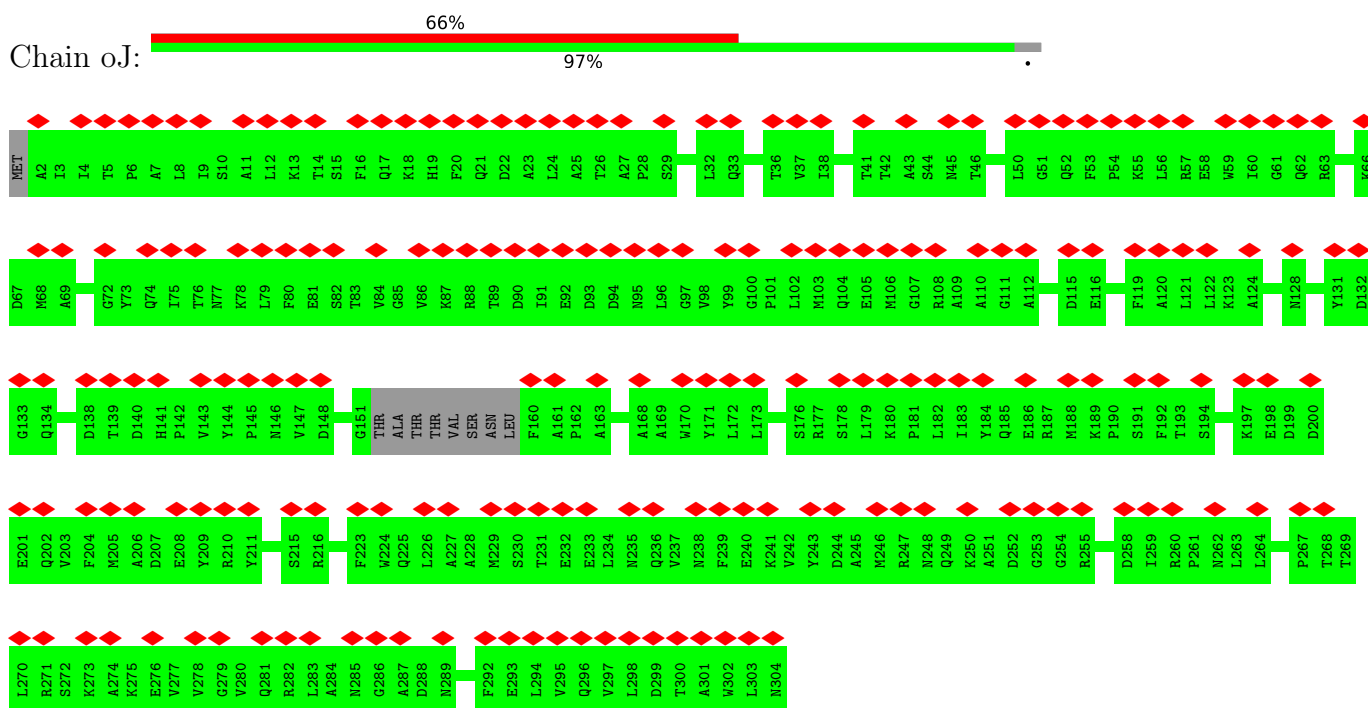

• Molecule 2: Bacteriophage Mu GpT domain-containing protein

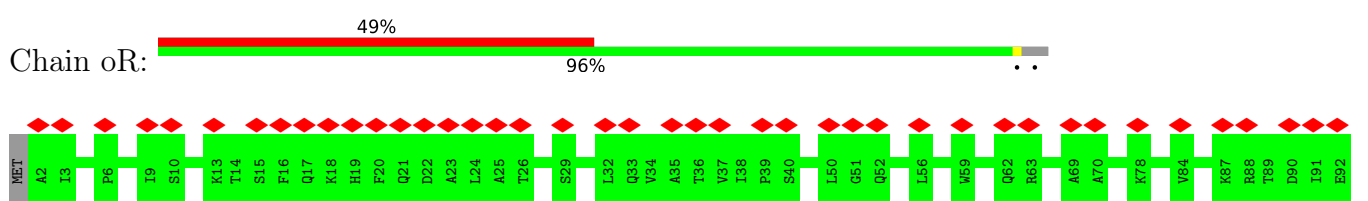

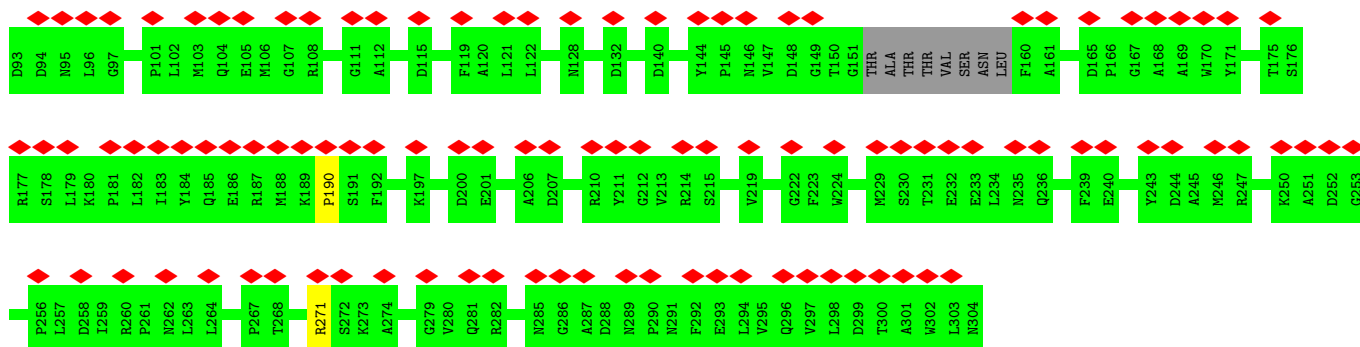

• Molecule 2: Bacteriophage Mu GpT domain-containing protein

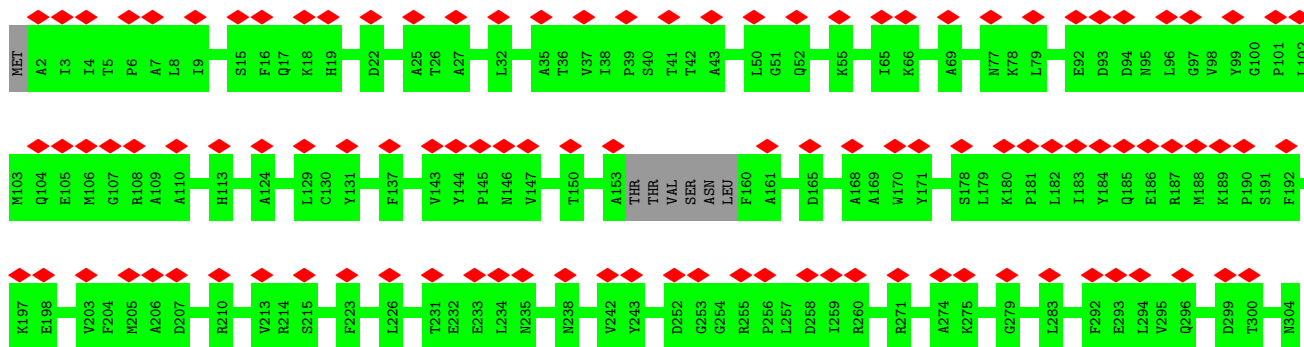

• Molecule 2: Bacteriophage Mu GpT domain-containing protein



• Molecule 2: Bacteriophage Mu GpT domain-containing protein

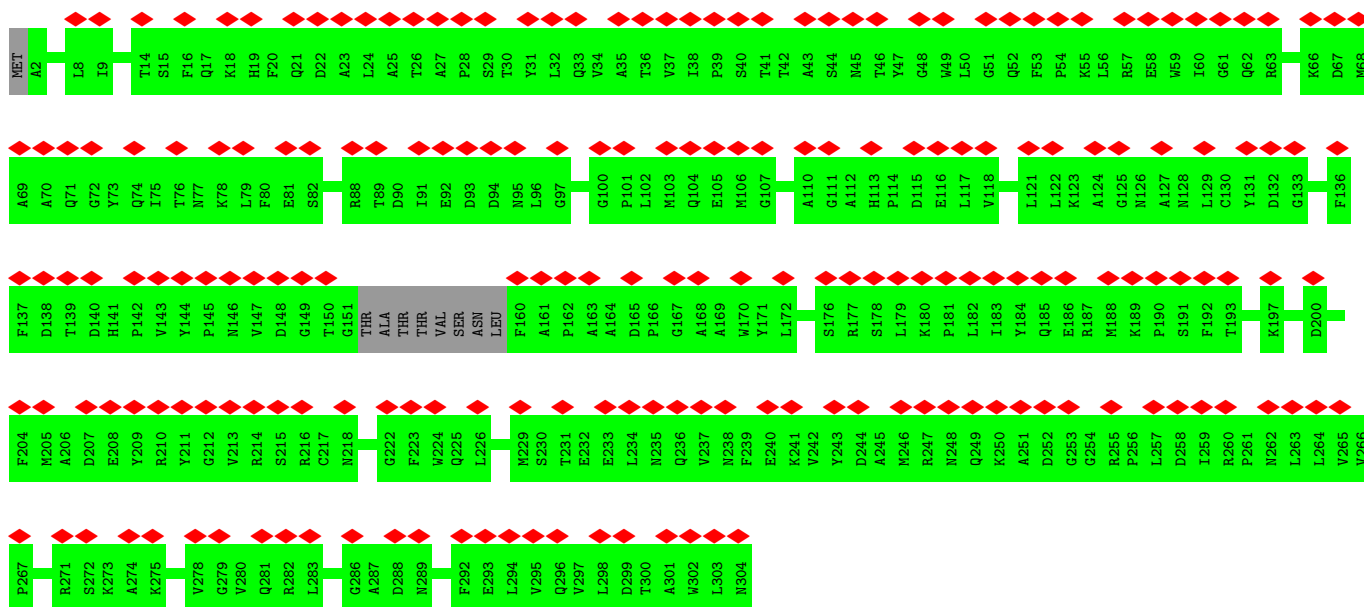

• Molecule 2: Bacteriophage Mu GpT domain-containing protein

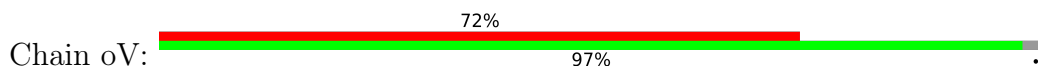

• Molecule 2: Bacteriophage Mu GpT domain-containing protein

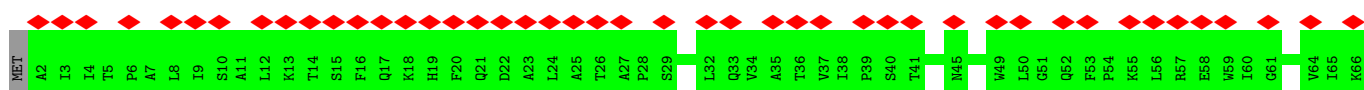

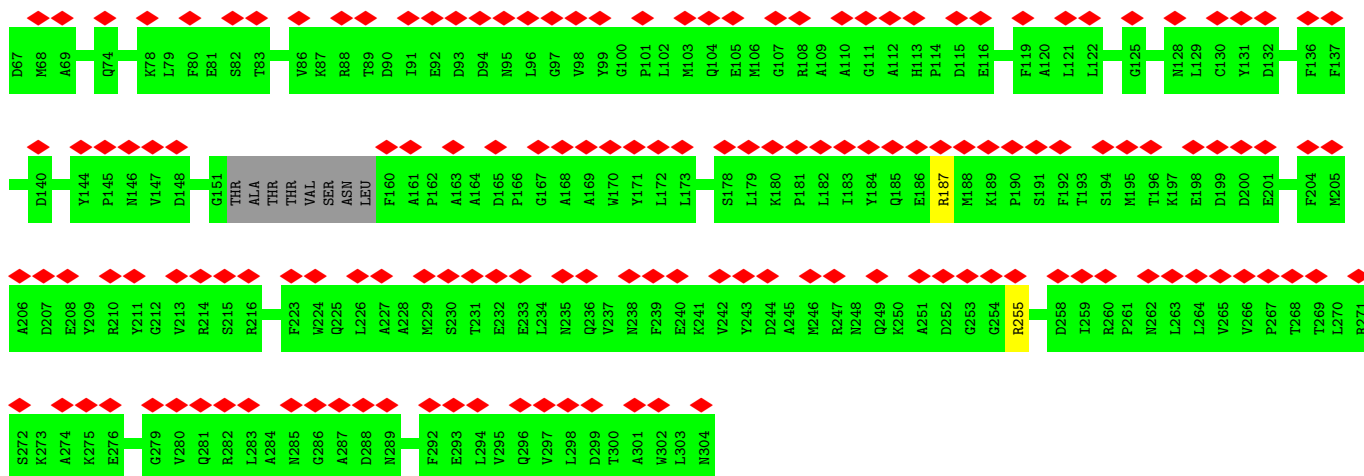

• Molecule 2: Bacteriophage Mu GpT domain-containing protein

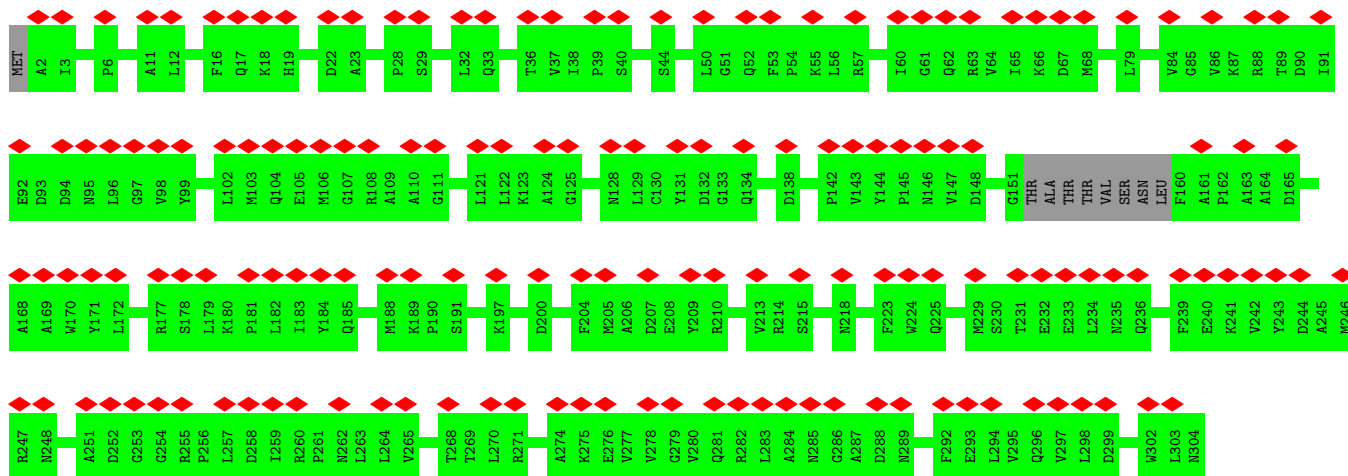

• Molecule 2: Bacteriophage Mu GpT domain-containing protein

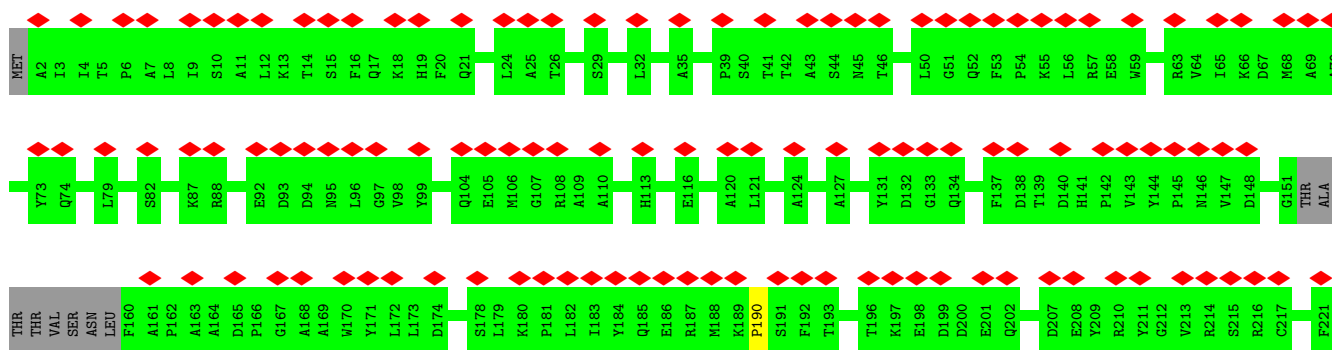



• Molecule 2: Bacteriophage Mu GpT domain-containing protein

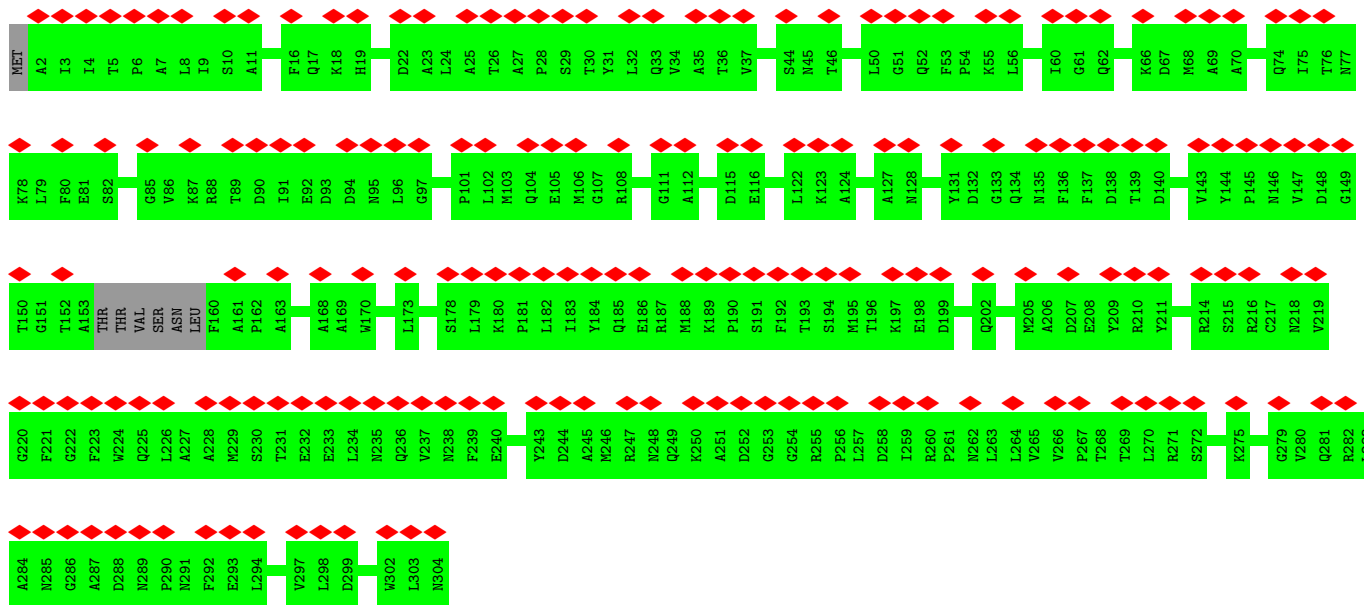

• Molecule 2: Bacteriophage Mu GpT domain-containing protein

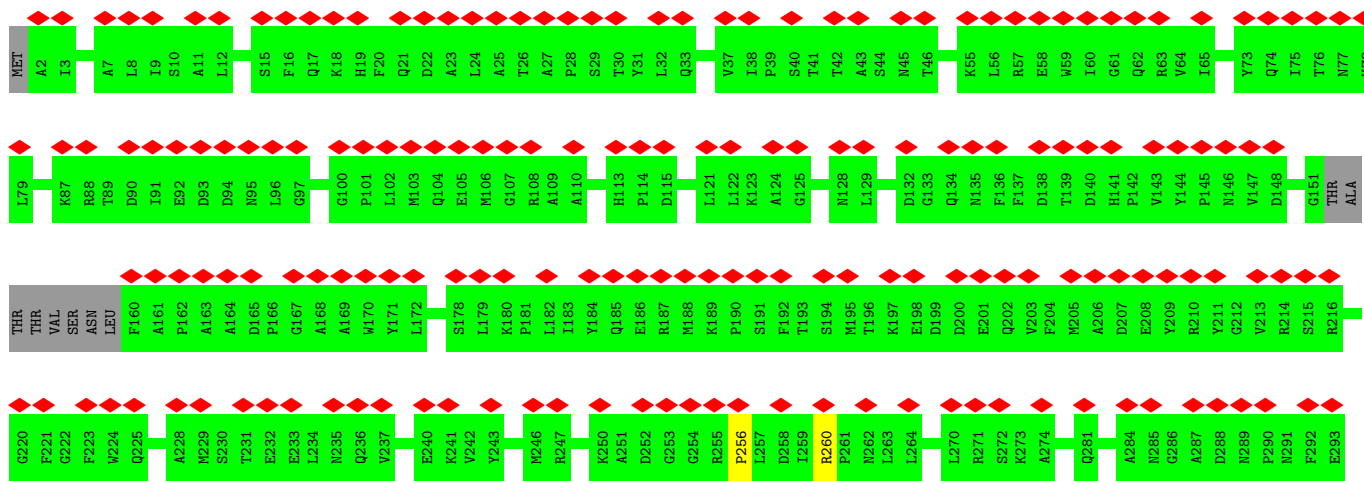

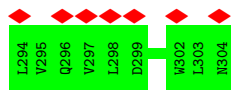

• Molecule 2: Bacteriophage Mu GpT domain-containing protein



• Molecule 2: Bacteriophage Mu GpT domain-containing protein

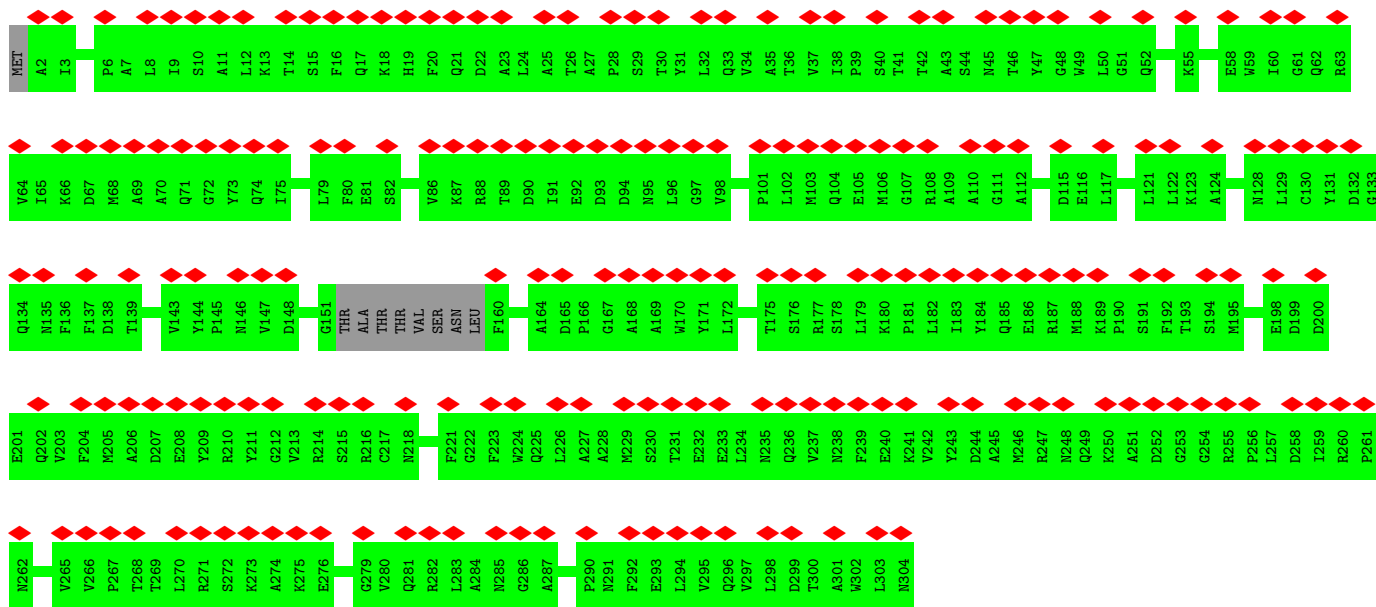

• Molecule 2: Bacteriophage Mu GpT domain-containing protein



• Molecule 2: Bacteriophage Mu GpT domain-containing protein



• Molecule 2: Bacteriophage Mu GpT domain-containing protein

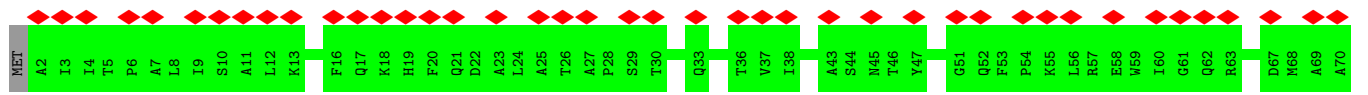

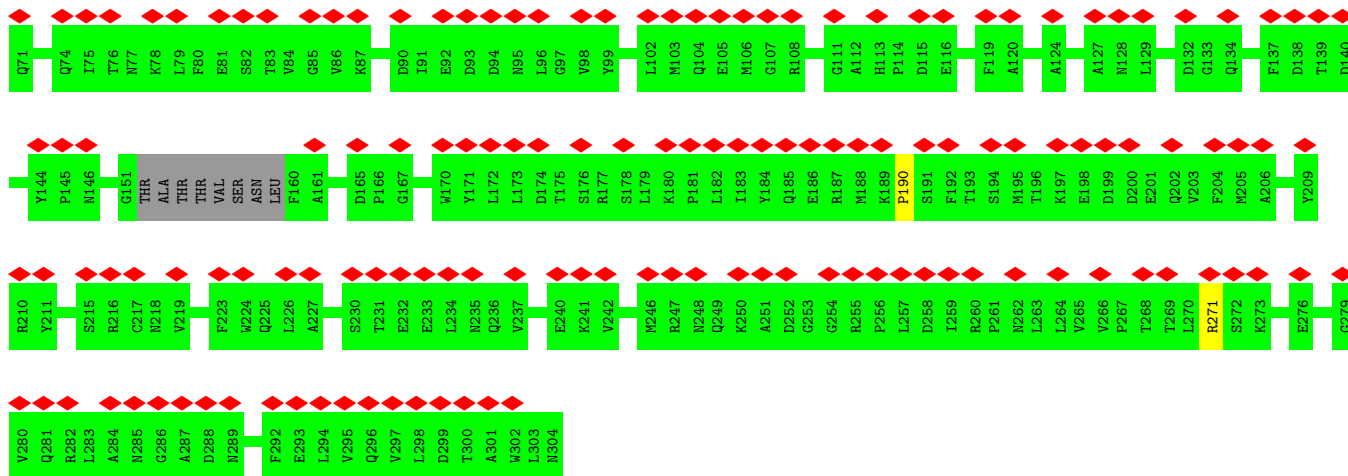

• Molecule 2: Bacteriophage Mu GpT domain-containing protein

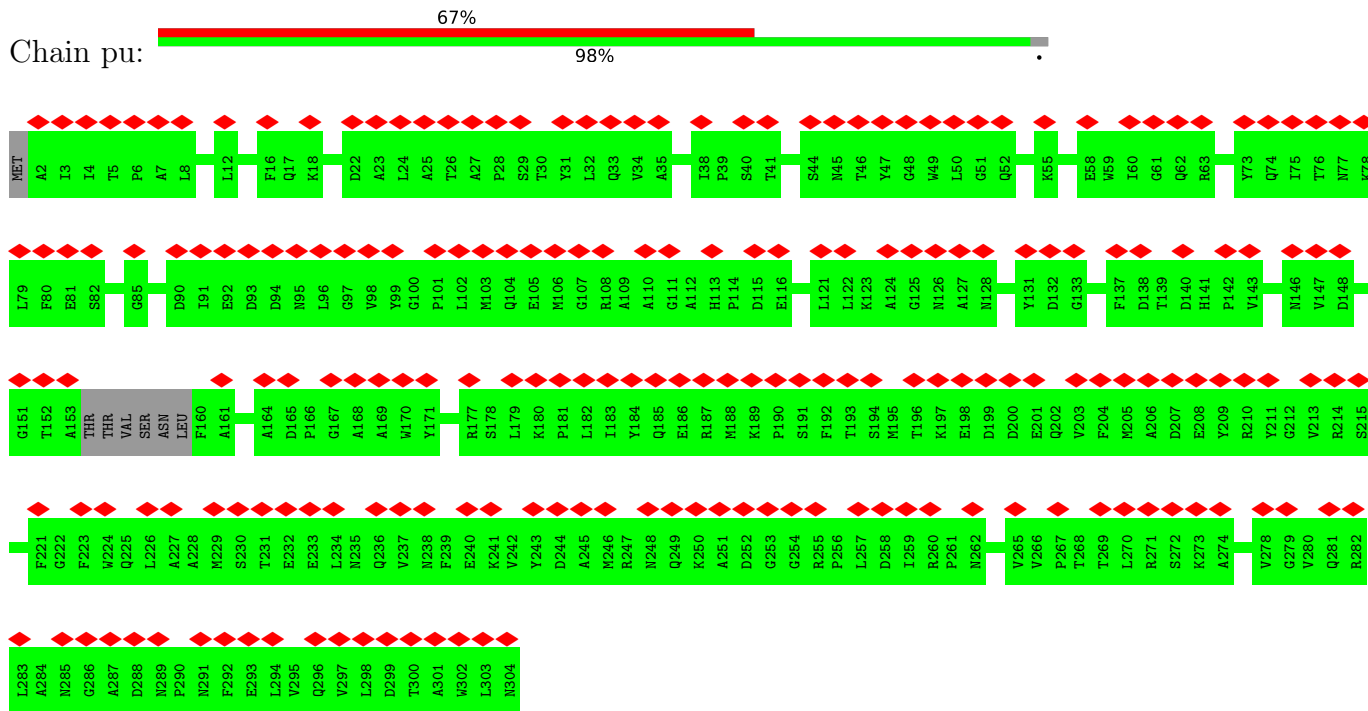

• Molecule 2: Bacteriophage Mu GpT domain-containing protein

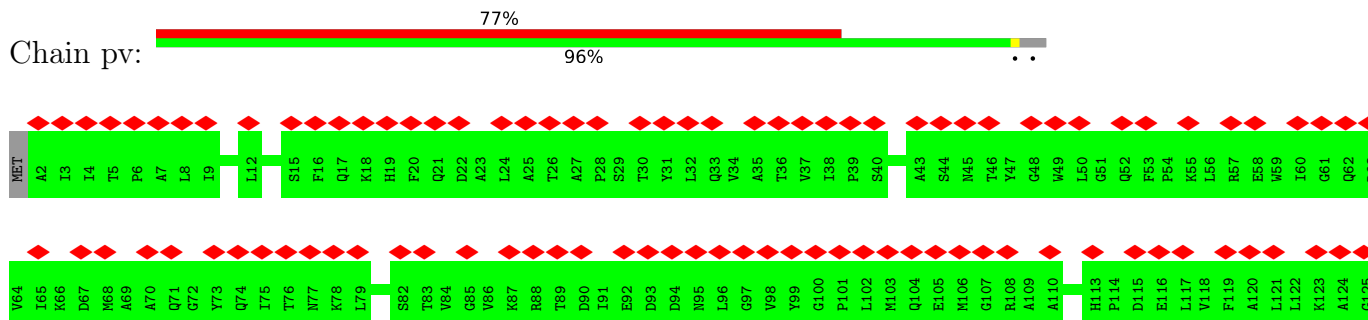

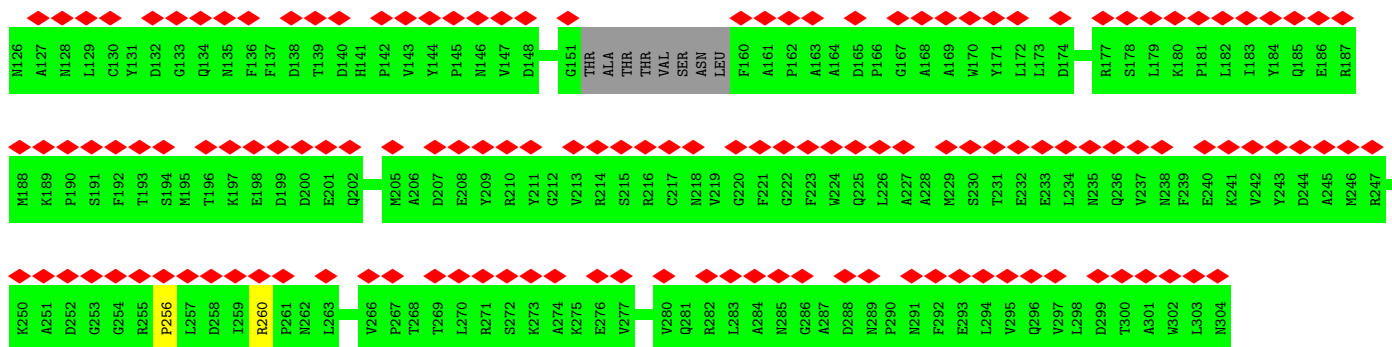

• Molecule 2: Bacteriophage Mu GpT domain-containing protein

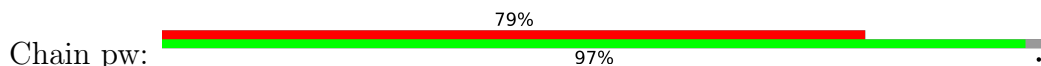

• Molecule 2: Bacteriophage Mu GpT domain-containing protein

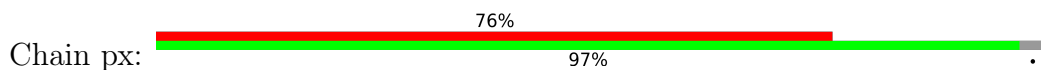

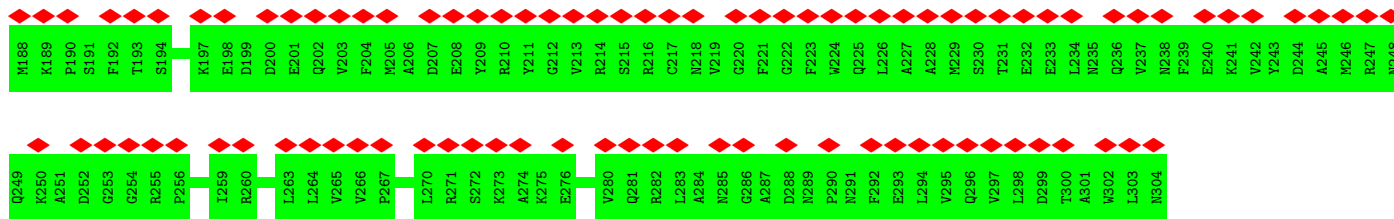

• Molecule 2: Bacteriophage Mu GpT domain-containing protein

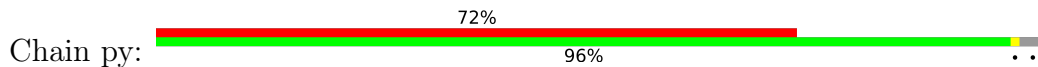

• Molecule 2: Bacteriophage Mu GpT domain-containing protein

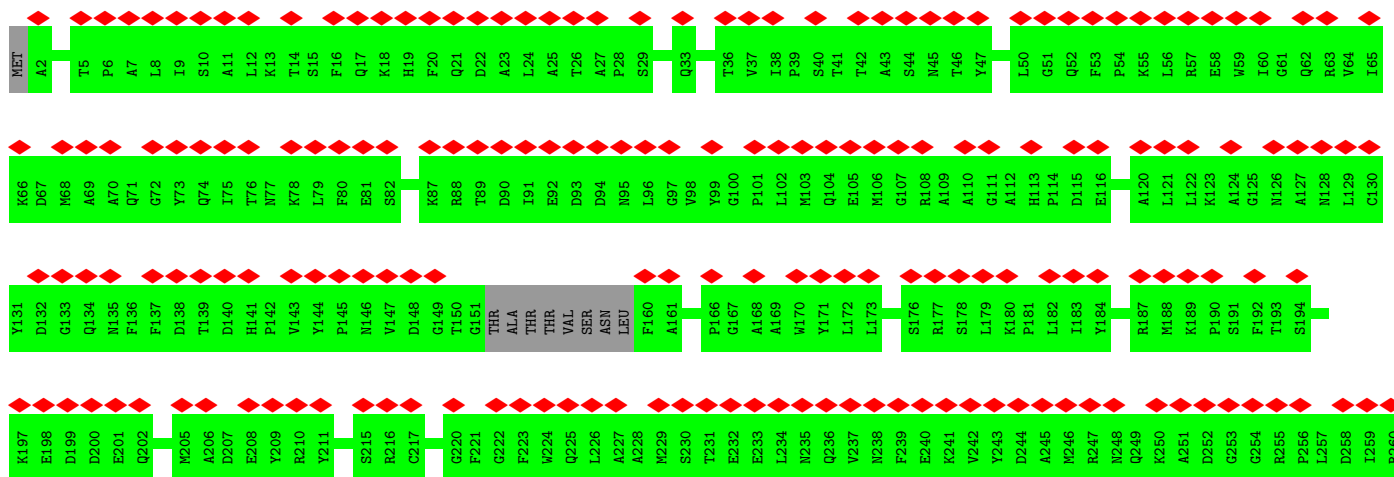
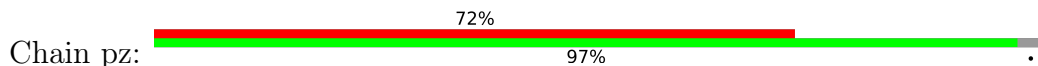

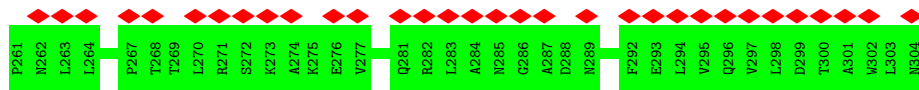

• Molecule 2: Bacteriophage Mu GpT domain-containing protein

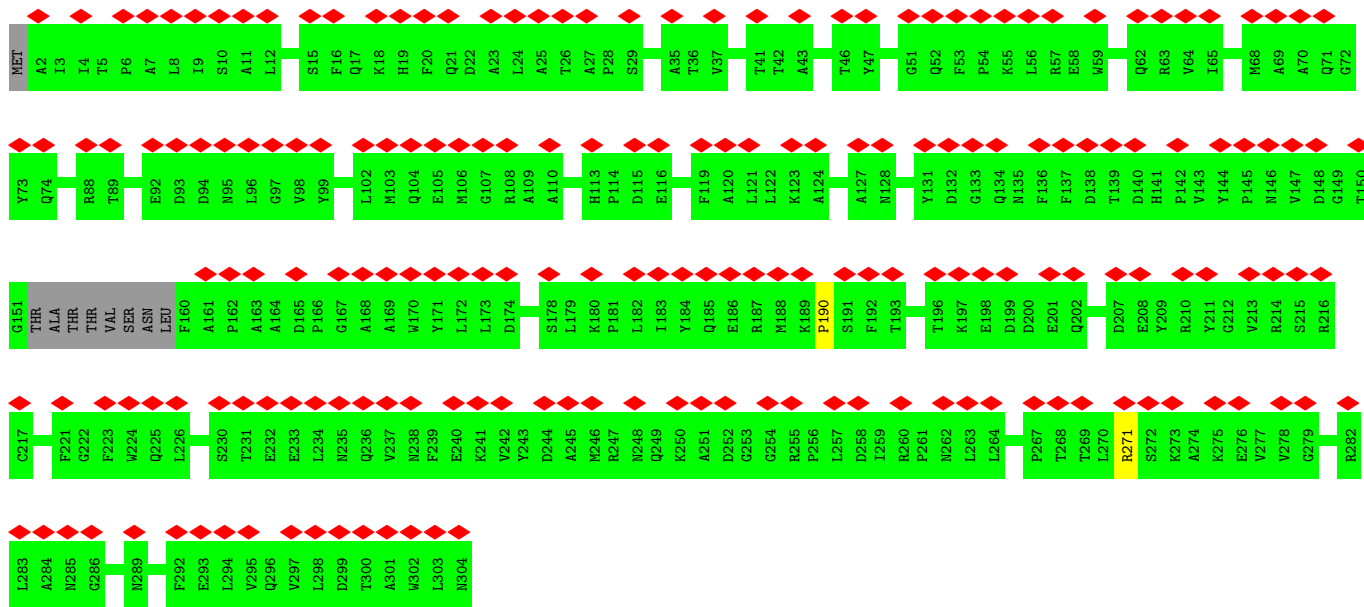

• Molecule 2: Bacteriophage Mu GpT domain-containing protein



• Molecule 2: Bacteriophage Mu GpT domain-containing protein

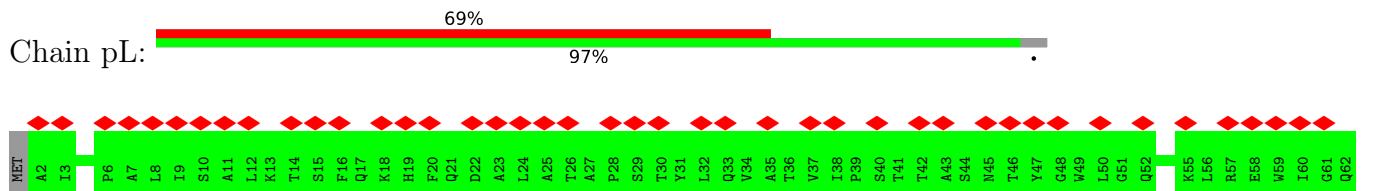
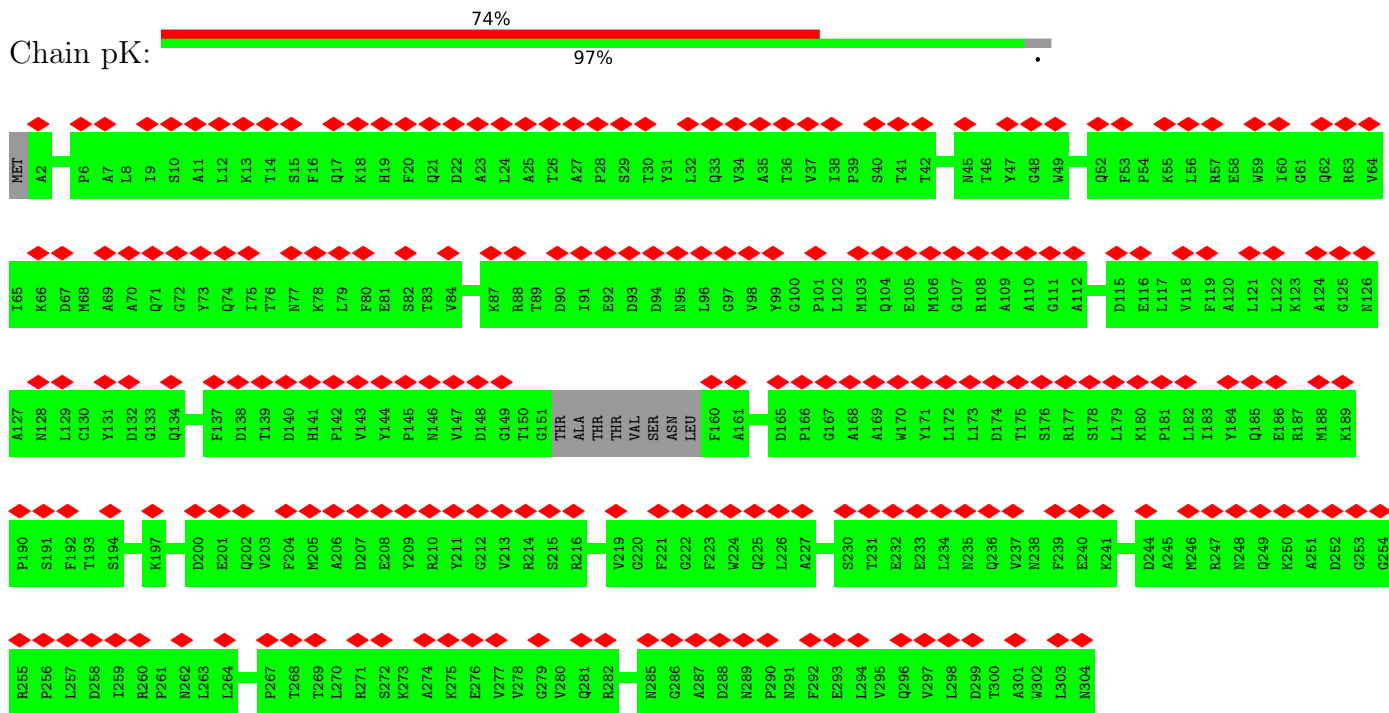
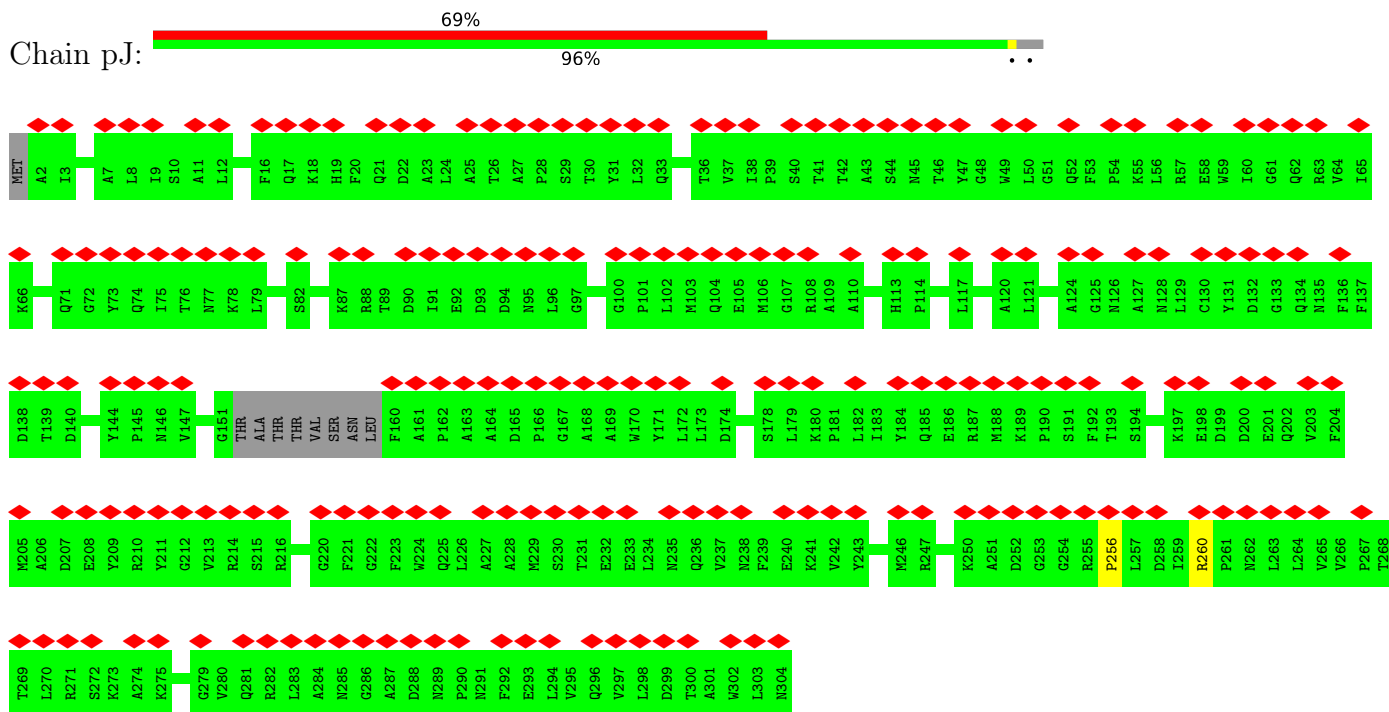

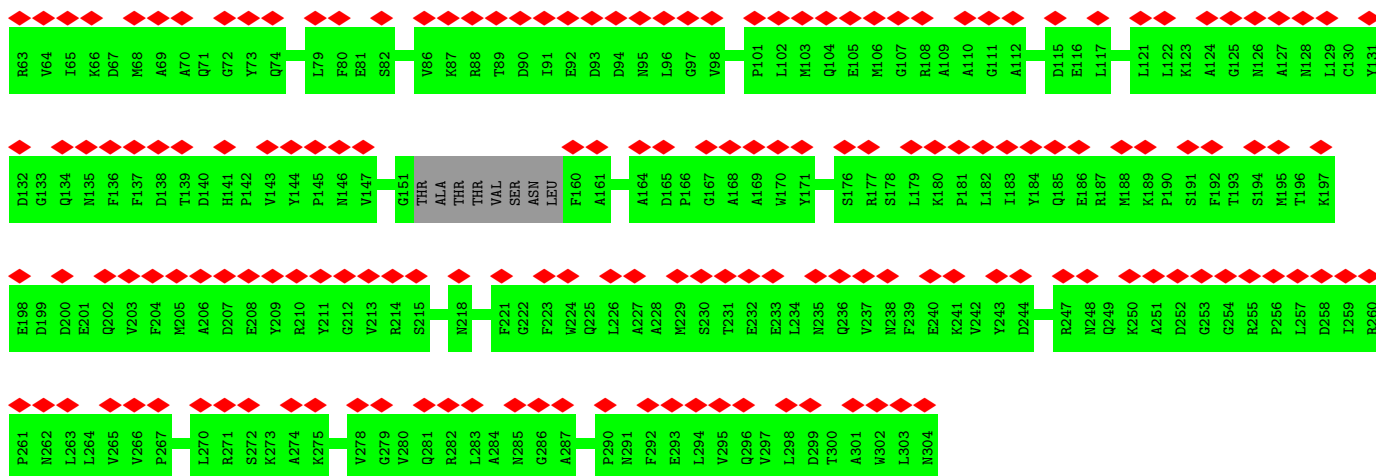

• Molecule 2: Bacteriophage Mu GpT domain-containing protein

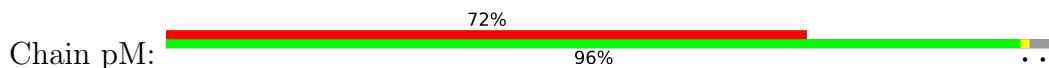

• Molecule 2: Bacteriophage Mu GpT domain-containing protein

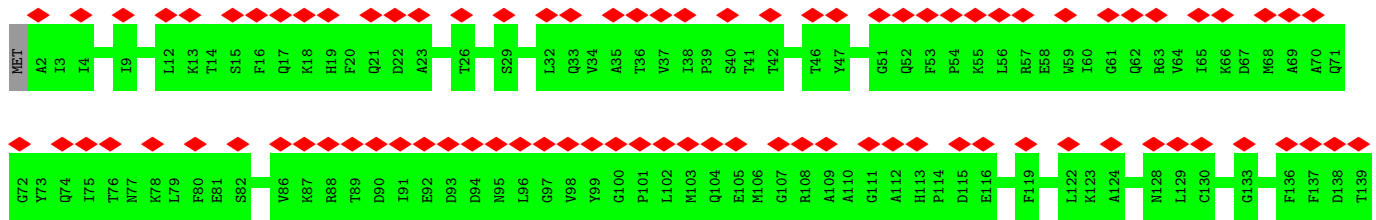

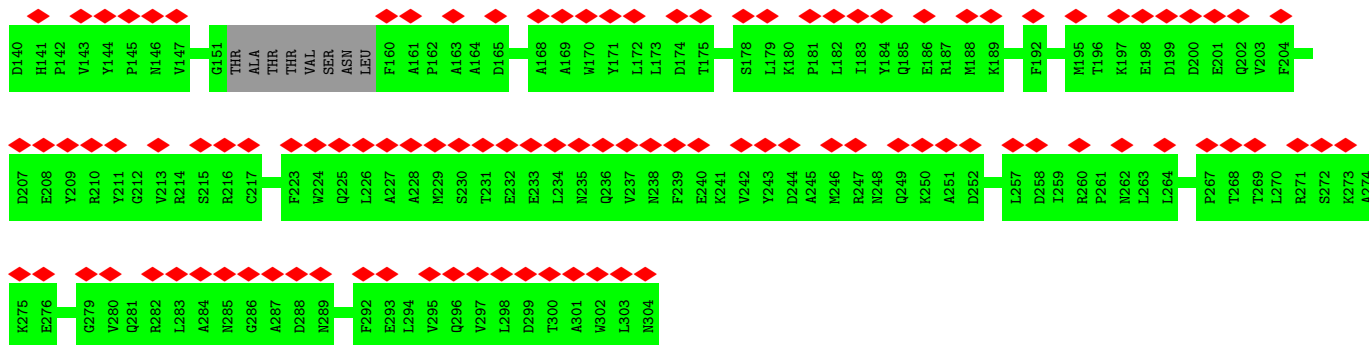

• Molecule 2: Bacteriophage Mu GpT domain-containing protein

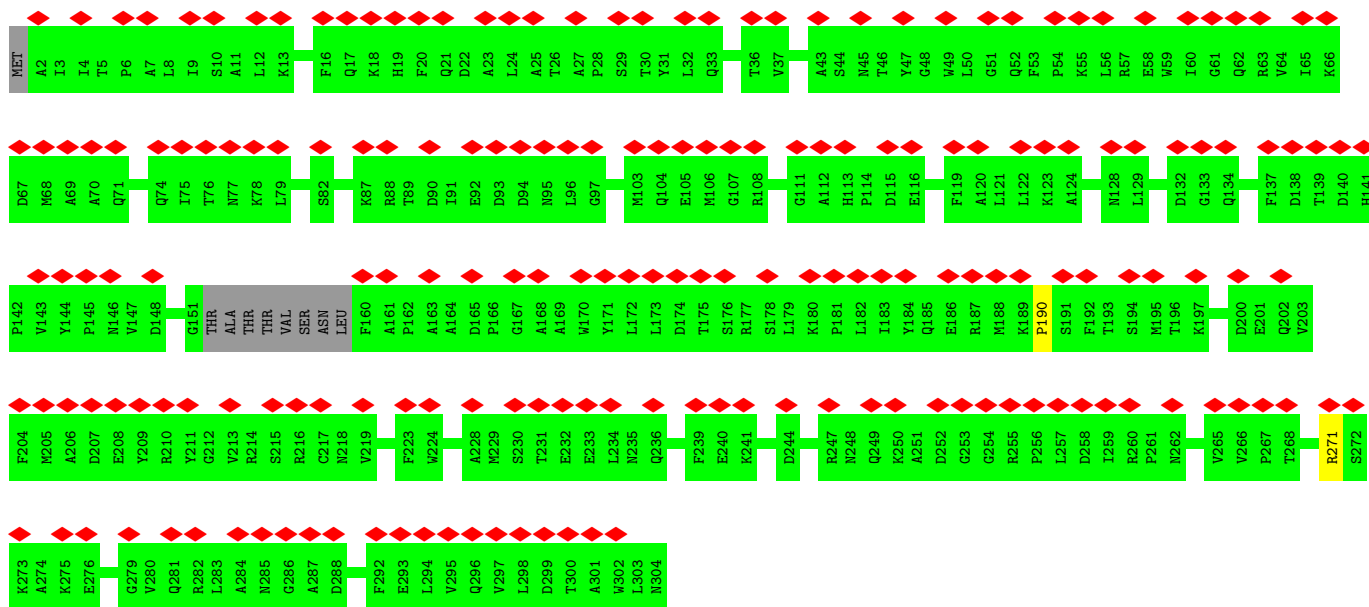

• Molecule 2: Bacteriophage Mu GpT domain-containing protein

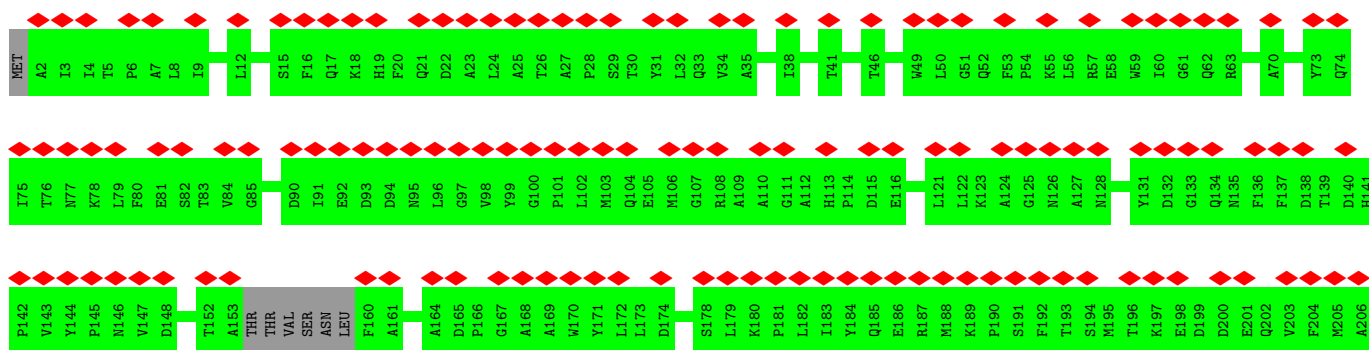
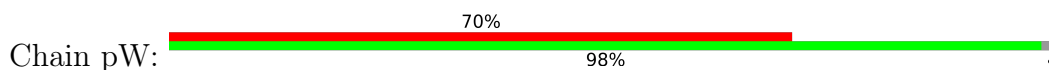

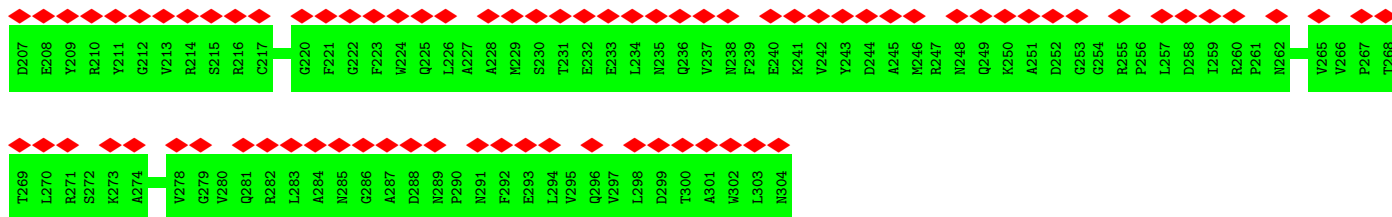

• Molecule 2: Bacteriophage Mu GpT domain-containing protein



• Molecule 2: Bacteriophage Mu GpT domain-containing protein

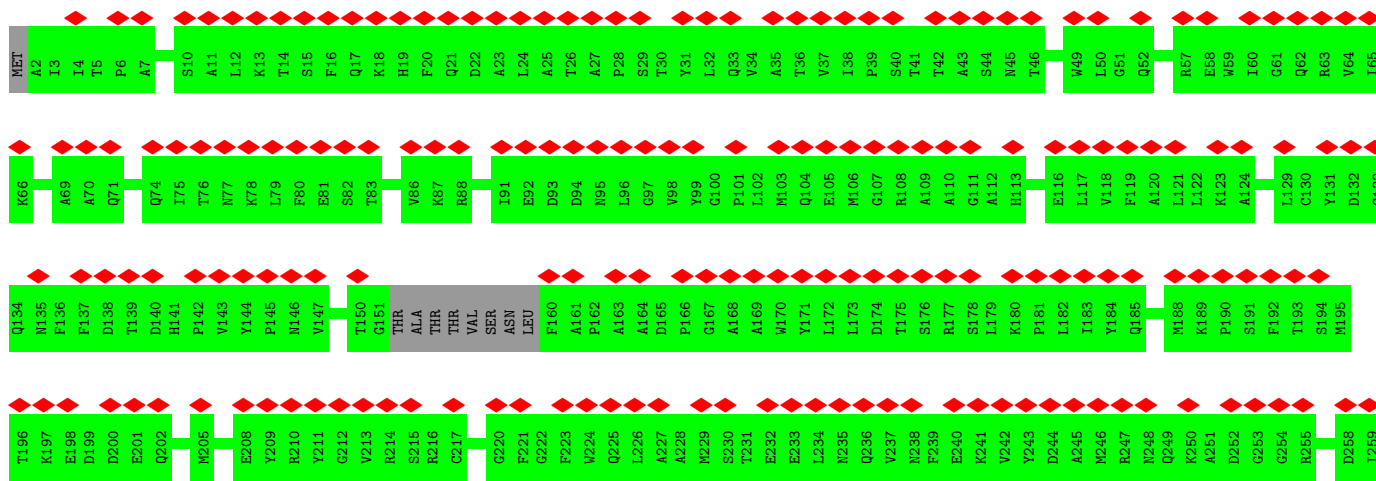
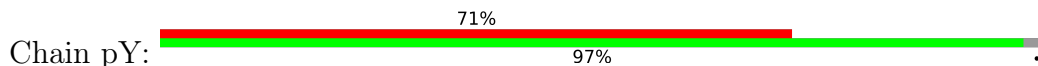

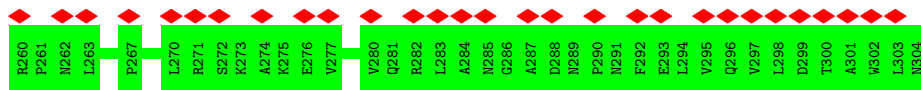

• Molecule 2: Bacteriophage Mu GpT domain-containing protein



• Molecule 2: Bacteriophage Mu GpT domain-containing protein

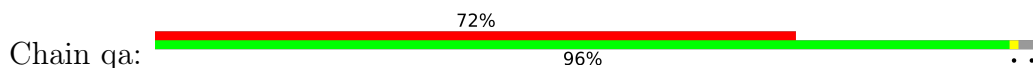

• Molecule 2: Bacteriophage Mu GpT domain-containing protein

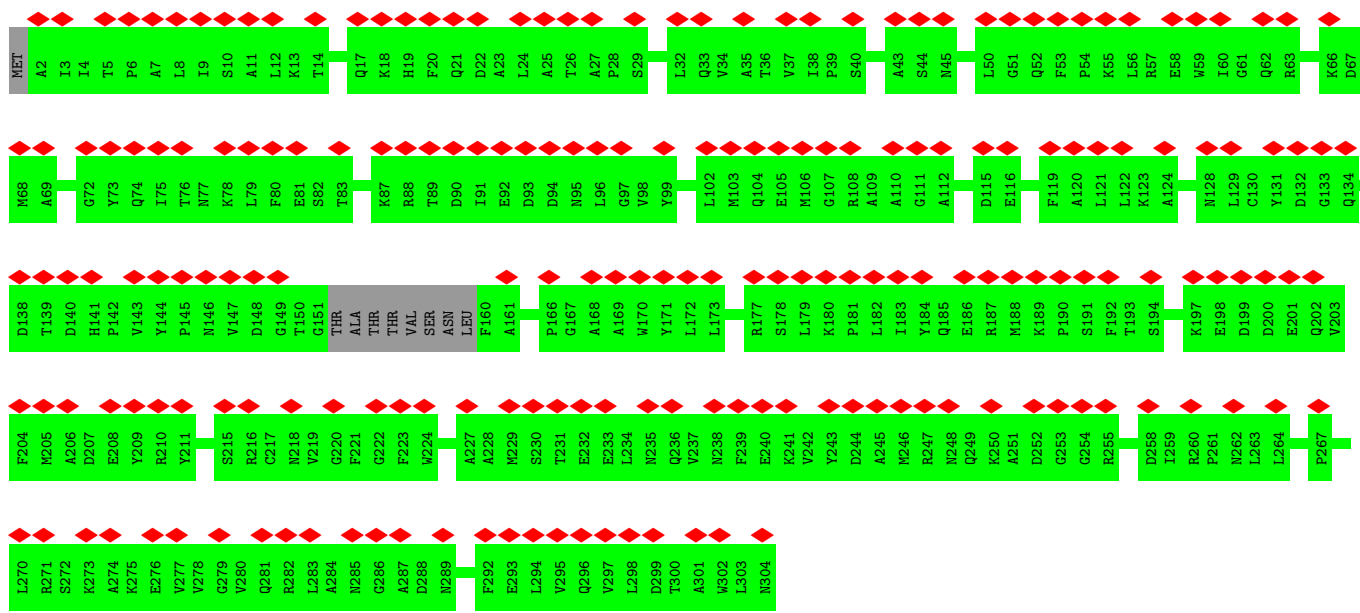

• Molecule 3: Stopper protein

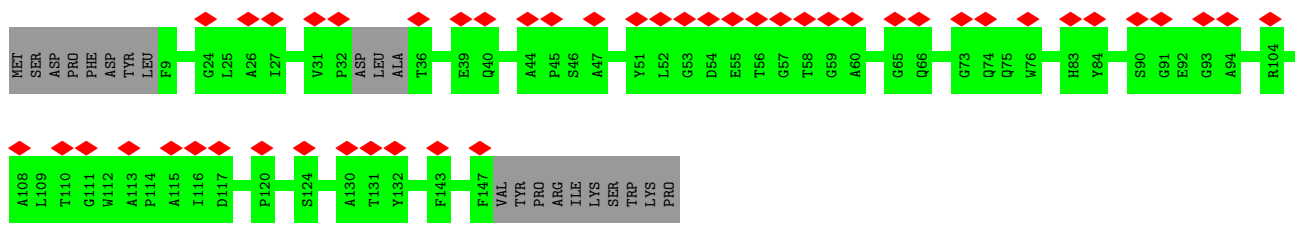
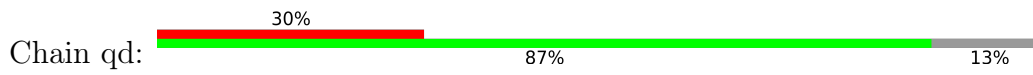

• Molecule 3: Stopper protein

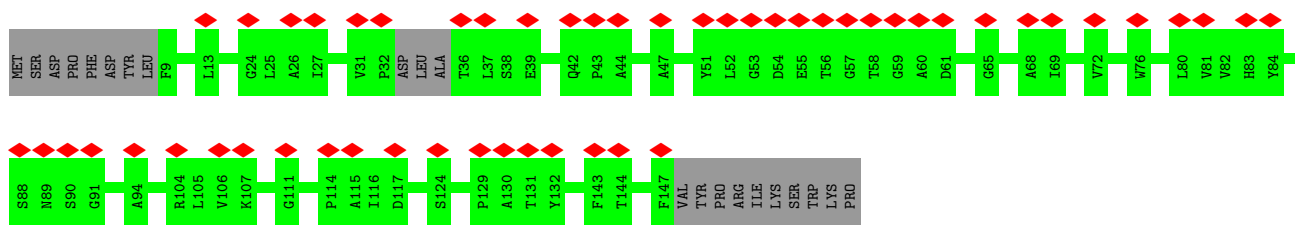
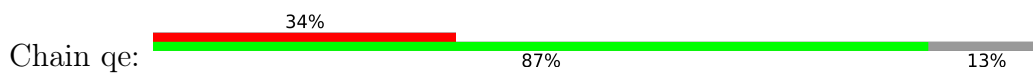

• Molecule 3: Stopper protein

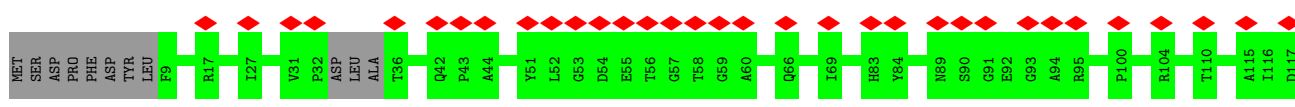
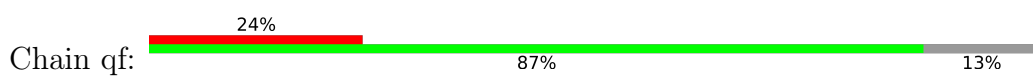

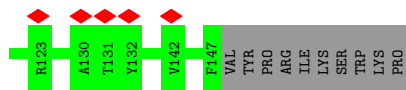

• Molecule 3: Stopper protein

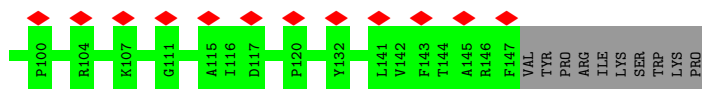
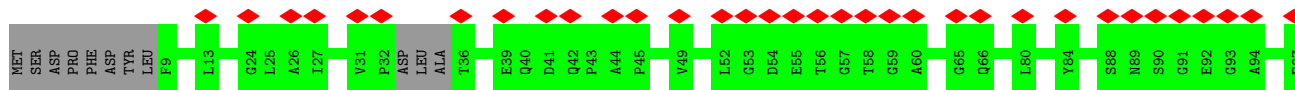
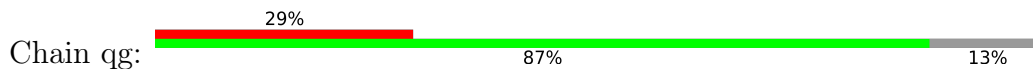

• Molecule 3: Stopper protein

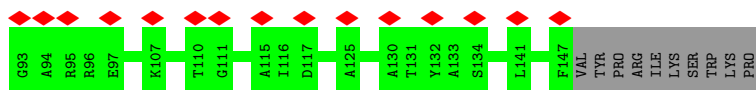
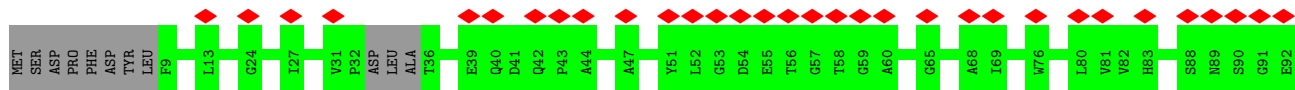
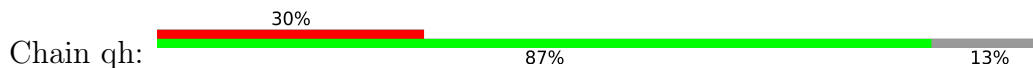

• Molecule 3: Stopper protein

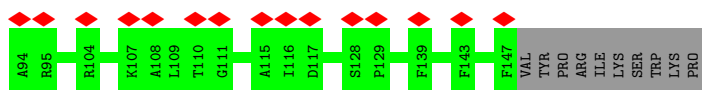
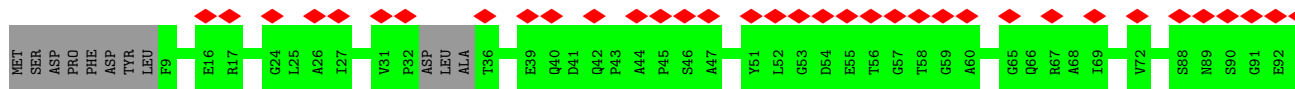
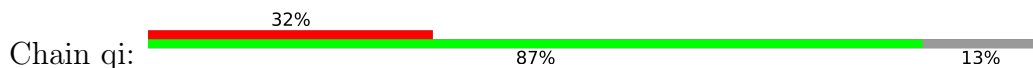

• Molecule 4: Virion structural protein

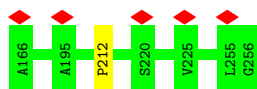
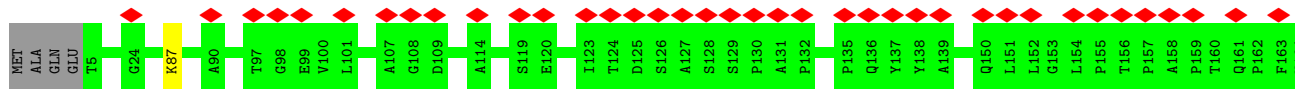

• Molecule 4: Virion structural protein

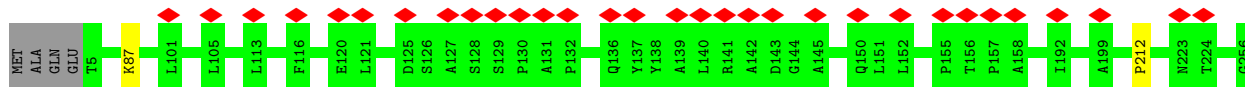

• Molecule 4: Virion structural protein

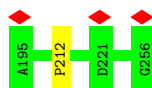
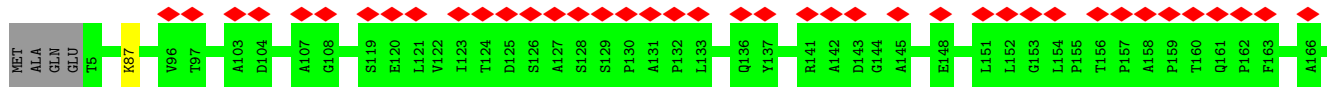

• Molecule 4: Virion structural protein

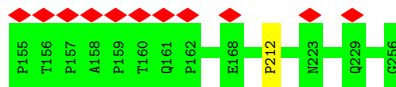
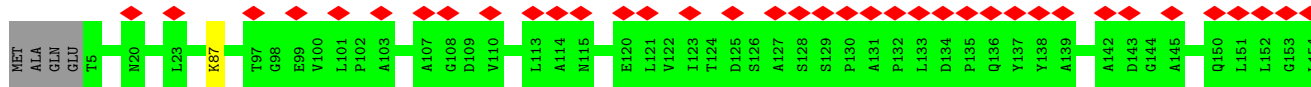

• Molecule 4: Virion structural protein

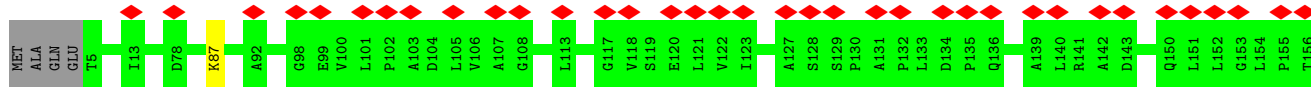

• Molecule 4: Virion structural protein

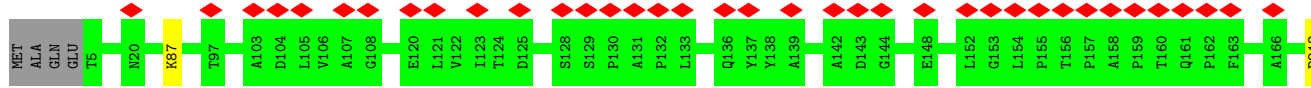

• Molecule 5: Portal protein

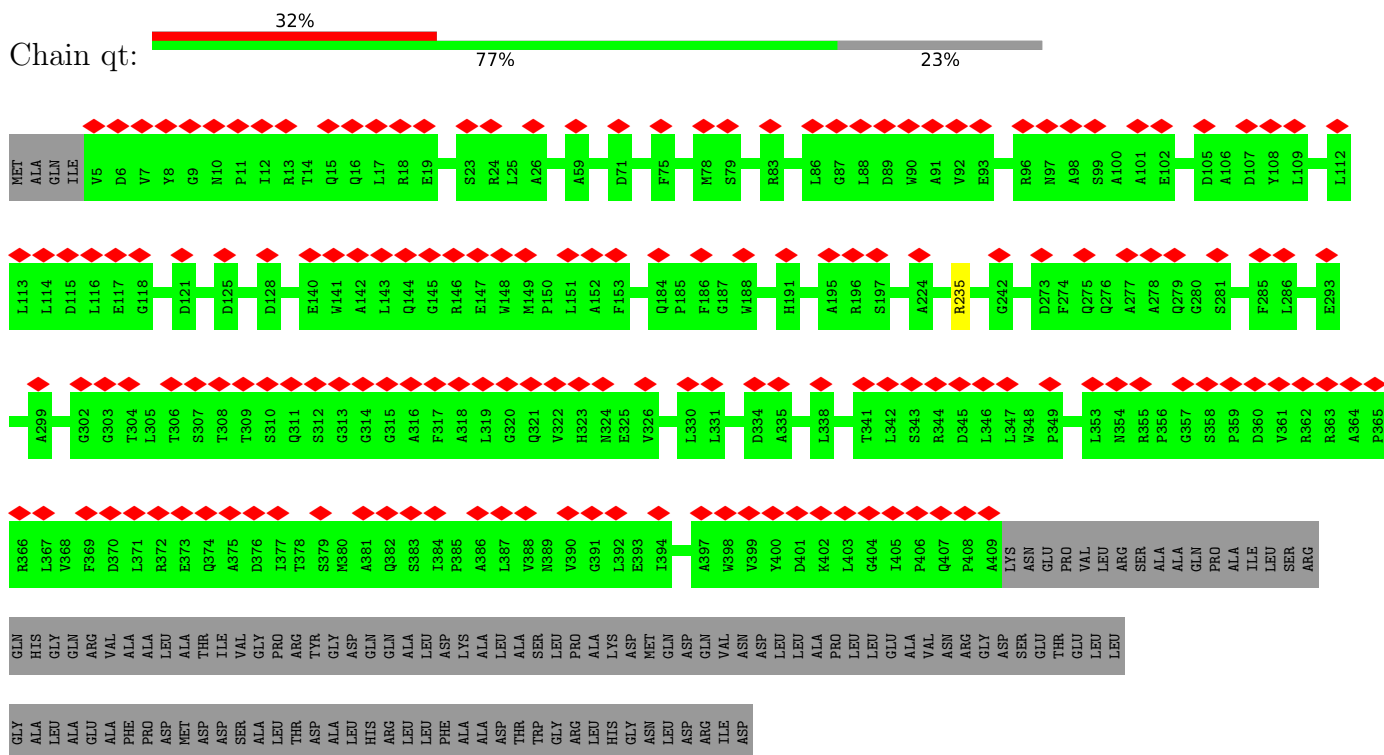

• Molecule 5: Portal protein

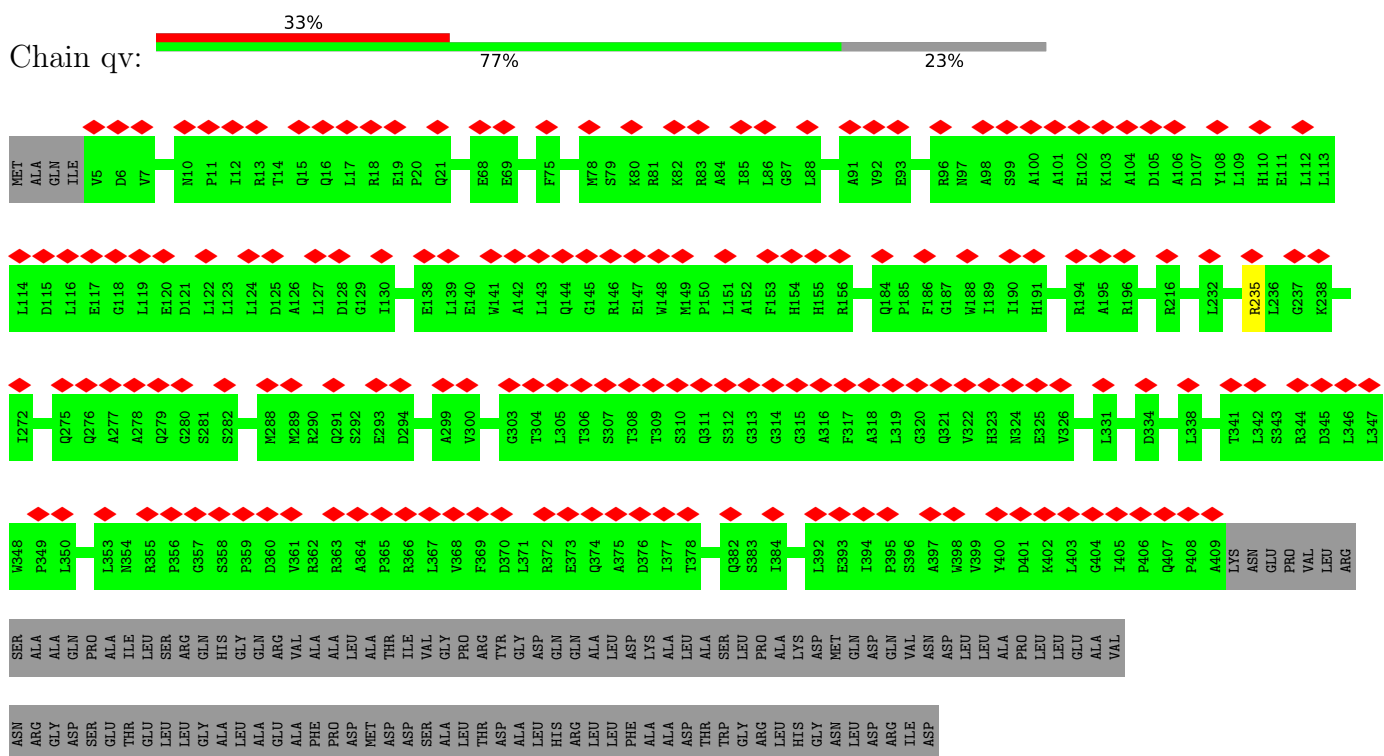

• Molecule 5: Portal protein



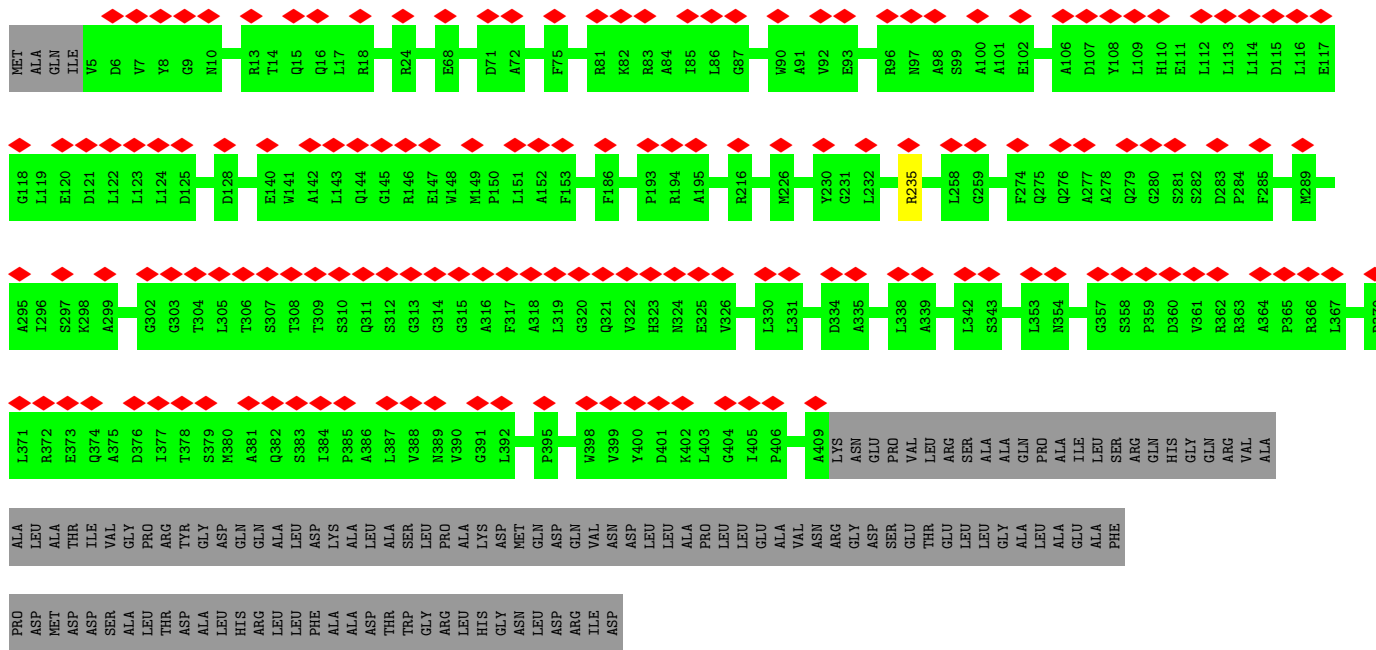

• Molecule 5: Portal protein

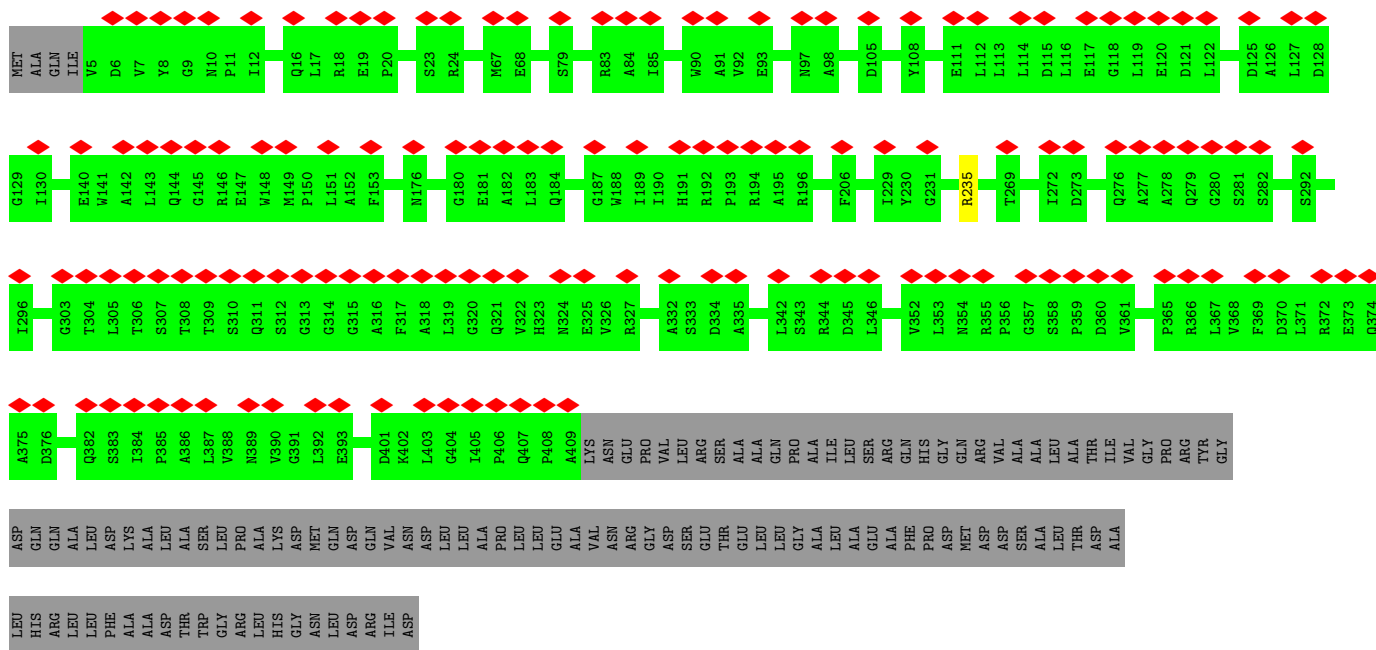
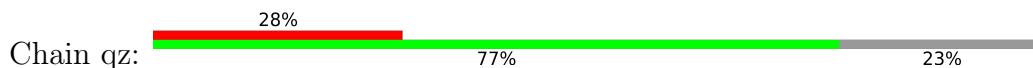

• Molecule 5: Portal protein

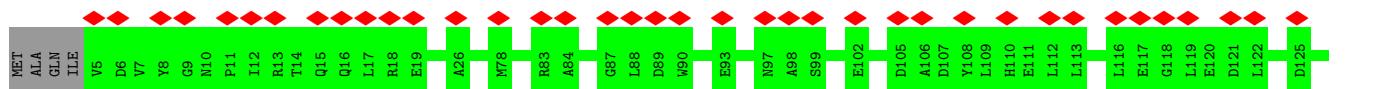
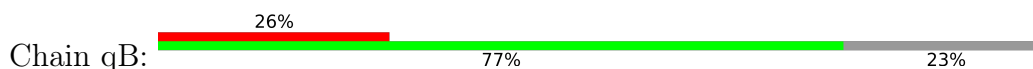

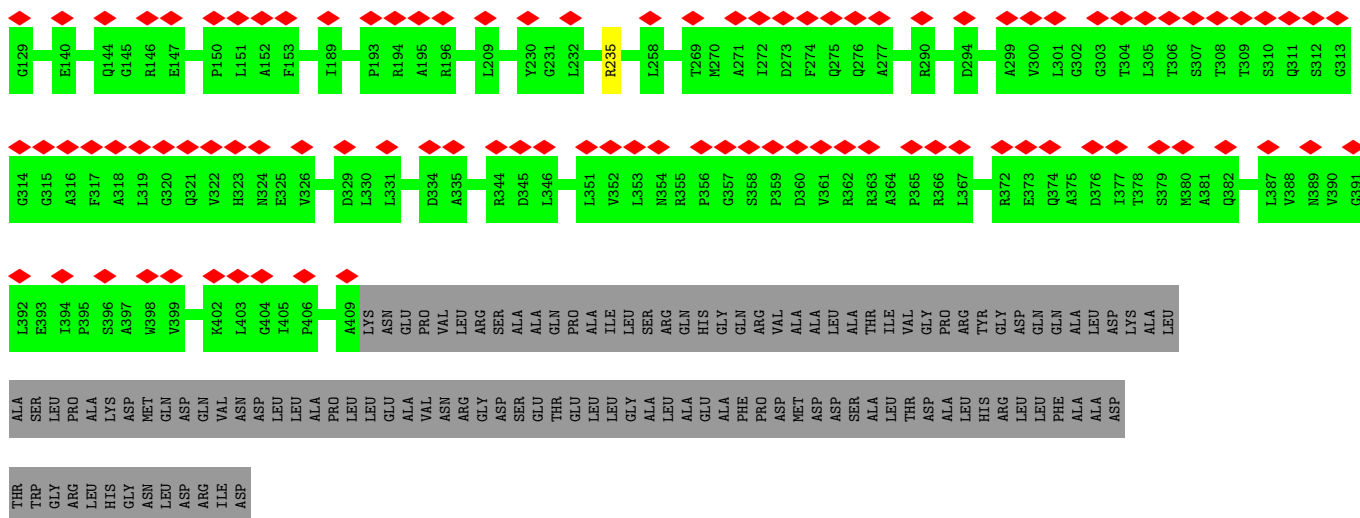

• Molecule 5: Portal protein

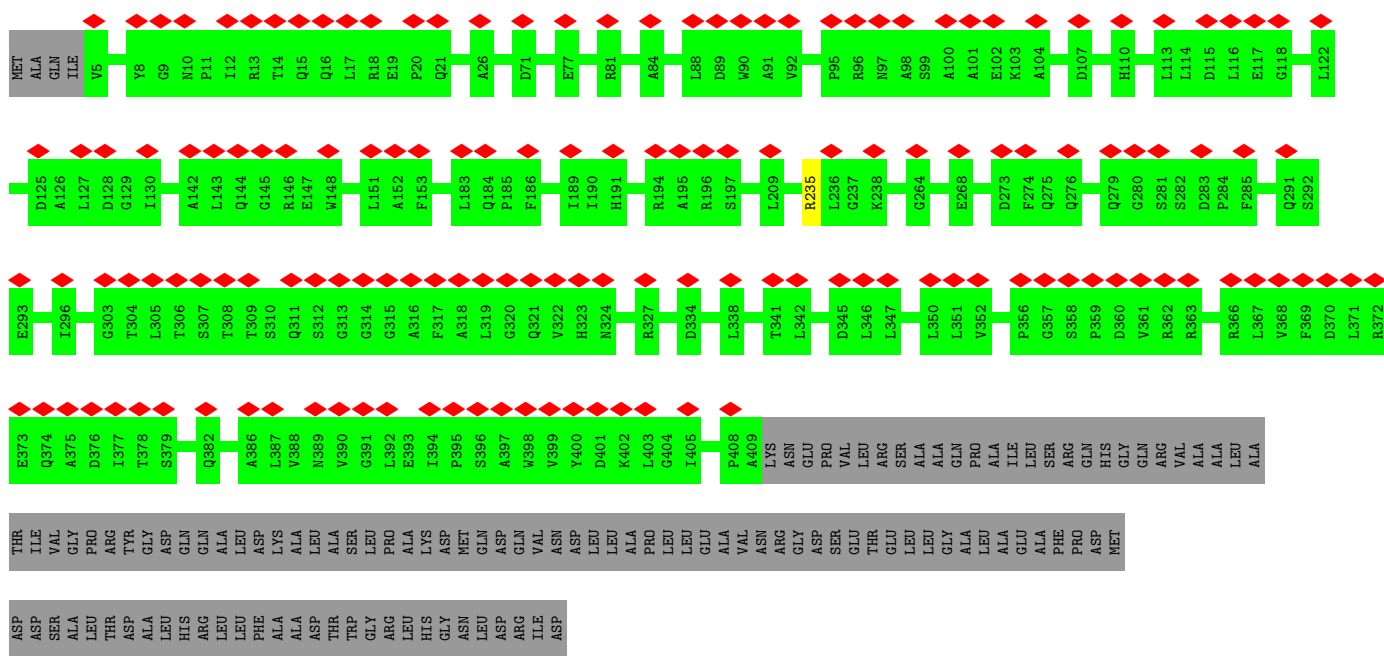
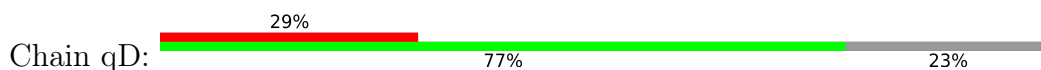

• Molecule 5: Portal protein

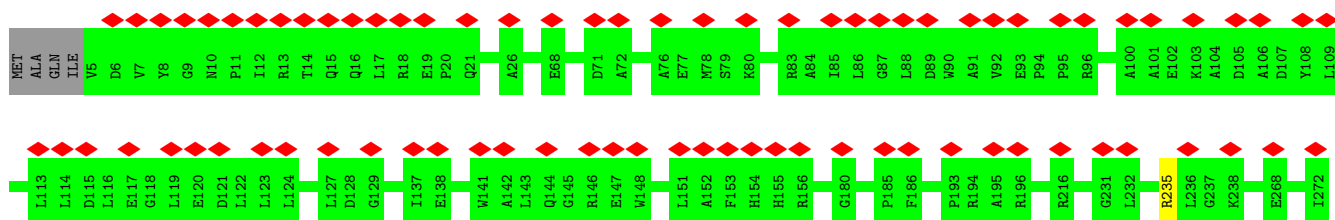
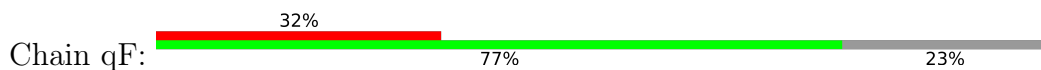

Chain qu:  5% 98%

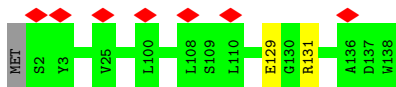

- Molecule 6: DUF1320 domain-containing protein

Chain qw:  98%

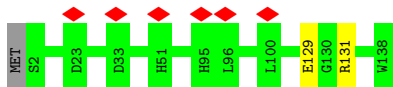

- Molecule 6: DUF1320 domain-containing protein

Chain qy:  7% 98%

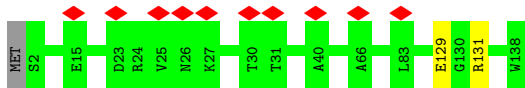

- Molecule 6: DUF1320 domain-containing protein

Chain qA:  98%

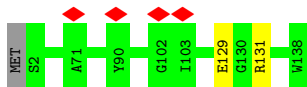

- Molecule 6: DUF1320 domain-containing protein

Chain qC:  98%

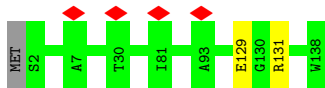

- Molecule 6: DUF1320 domain-containing protein

Chain qE:  98%

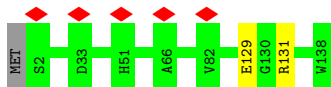

- Molecule 6: DUF1320 domain-containing protein

Chain qG:  98%

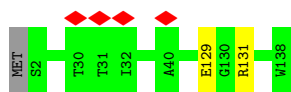

- Molecule 6: DUF1320 domain-containing protein

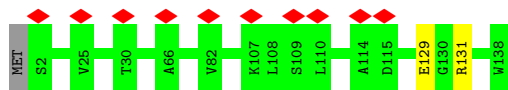

- Molecule 6: DUF1320 domain-containing protein

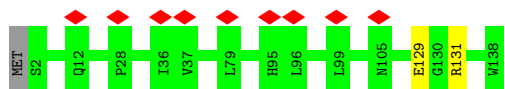

- Molecule 6: DUF1320 domain-containing protein

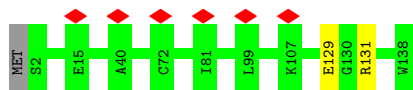

4 Experimental information

Property	Value	Source
EM reconstruction method	SINGLE PARTICLE	Depositor
Imposed symmetry	POINT, C1	Depositor
Number of particles used	2913	Depositor
Resolution determination method	FSC 0.143 CUT-OFF	Depositor
CTF correction method	PHASE FLIPPING ONLY	Depositor
Microscope	FEI TITAN KRIOS	Depositor
Voltage (kV)	300	Depositor
Electron dose ($e^-/\text{\AA}^2$)	30	Depositor
Minimum defocus (nm)	600	Depositor
Maximum defocus (nm)	1600	Depositor
Magnification	130000	Depositor
Image detector	GATAN K2 SUMMIT (4k x 4k)	Depositor
Maximum map value	0.048	Depositor
Minimum map value	-0.013	Depositor
Average map value	0.001	Depositor
Map value standard deviation	0.002	Depositor
Recommended contour level	0.013	Depositor
Map size (\AA)	873.6, 873.6, 873.6	wwPDB
Map dimensions	840, 840, 840	wwPDB
Map angles ($^\circ$)	90.0, 90.0, 90.0	wwPDB
Pixel spacing (\AA)	1.04, 1.04, 1.04	Depositor

5 Model quality [i](#)

5.1 Standard geometry [i](#)

The Z score for a bond length (or angle) is the number of standard deviations the observed value is removed from the expected value. A bond length (or angle) with $|Z| > 5$ is considered an outlier worth inspection. RMSZ is the root-mean-square of all Z scores of the bond lengths (or angles).

Mol	Chain	Bond lengths		Bond angles	
		RMSZ	# Z >5	RMSZ	# Z >5
1	aA	0.25	0/438	0.56	0/586
1	aB	0.24	0/438	0.56	0/586
1	aC	0.24	0/438	0.55	0/586
1	aD	0.24	0/438	0.55	0/586
1	aE	0.24	0/438	0.56	0/586
1	aF	0.25	0/438	0.57	0/586
1	aG	0.26	0/438	0.54	0/586
1	aO	0.25	0/438	0.56	0/586
1	aP	0.24	0/438	0.56	0/586
1	aQ	0.24	0/438	0.55	0/586
1	aR	0.24	0/438	0.54	0/586
1	aS	0.24	0/438	0.56	0/586
1	aT	0.25	0/438	0.57	0/586
1	aU	0.26	0/438	0.54	0/586
1	aa	0.24	0/438	0.56	0/586
1	ab	0.24	0/438	0.55	0/586
1	ac	0.24	0/438	0.54	0/586
1	ad	0.24	0/438	0.56	0/586
1	ae	0.25	0/438	0.57	0/586
1	af	0.26	0/438	0.54	0/586
1	an	0.25	0/438	0.56	0/586
1	ao	0.24	0/438	0.56	0/586
1	ap	0.24	0/438	0.55	0/586
1	aq	0.24	0/438	0.54	0/586
1	ar	0.24	0/438	0.56	0/586
1	as	0.25	0/438	0.57	0/586
1	at	0.26	0/438	0.54	0/586
1	bE	0.25	0/438	0.55	0/586
1	bF	0.24	0/438	0.56	0/586
1	bG	0.24	0/438	0.55	0/586
1	bH	0.24	0/438	0.55	0/586
1	bI	0.24	0/438	0.56	0/586
1	bJ	0.25	0/438	0.57	0/586
1	bK	0.26	0/438	0.53	0/586

Mol	Chain	Bond lengths		Bond angles	
		RMSZ	# Z >5	RMSZ	# Z >5
1	bR	0.25	0/438	0.56	0/586
1	bS	0.24	0/438	0.56	0/586
1	bT	0.24	0/438	0.55	0/586
1	bU	0.24	0/438	0.54	0/586
1	bV	0.24	0/438	0.56	0/586
1	bW	0.25	0/438	0.57	0/586
1	bX	0.26	0/438	0.54	0/586
1	bc	0.25	0/438	0.56	0/586
1	bd	0.24	0/438	0.56	0/586
1	be	0.24	0/438	0.55	0/586
1	bf	0.24	0/438	0.54	0/586
1	bg	0.24	0/438	0.56	0/586
1	bh	0.25	0/438	0.57	0/586
1	bi	0.26	0/438	0.54	0/586
1	bq	0.25	0/438	0.56	0/586
1	br	0.24	0/438	0.56	0/586
1	bs	0.24	0/438	0.55	0/586
1	bt	0.24	0/438	0.54	0/586
1	bu	0.24	0/438	0.56	0/586
1	bv	0.25	0/438	0.57	0/586
1	bw	0.26	0/438	0.54	0/586
1	cH	0.25	0/438	0.56	0/586
1	cI	0.24	0/438	0.56	0/586
1	cJ	0.24	0/438	0.55	0/586
1	cK	0.24	0/438	0.54	0/586
1	cL	0.24	0/438	0.56	0/586
1	cM	0.25	0/438	0.57	0/586
1	cN	0.26	0/438	0.54	0/586
1	cV	0.25	0/438	0.56	0/586
1	cW	0.25	0/438	0.56	0/586
1	cX	0.24	0/438	0.55	0/586
1	cY	0.24	0/438	0.54	0/586
1	cZ	0.24	0/438	0.56	0/586
1	cf	0.25	0/438	0.56	0/586
1	cg	0.24	0/438	0.56	0/586
1	ch	0.24	0/438	0.55	0/586
1	ci	0.24	0/438	0.54	0/586
1	cj	0.24	0/438	0.56	0/586
1	ck	0.25	0/438	0.57	0/586
1	cl	0.26	0/438	0.54	0/586
1	ct	0.25	0/438	0.56	0/586
1	cu	0.25	0/438	0.56	0/586
1	cv	0.24	0/438	0.55	0/586

Mol	Chain	Bond lengths		Bond angles	
		RMSZ	# Z >5	RMSZ	# Z >5
1	cw	0.24	0/438	0.54	0/586
1	cx	0.24	0/438	0.56	0/586
1	cy	0.25	0/438	0.57	0/586
1	cz	0.26	0/438	0.54	0/586
1	dA	0.24	0/438	0.54	0/586
1	dB	0.24	0/438	0.56	0/586
1	dC	0.25	0/438	0.57	0/586
1	dD	0.26	0/438	0.54	0/586
1	dL	0.25	0/438	0.56	0/586
1	dM	0.24	0/438	0.56	0/586
1	dN	0.24	0/438	0.55	0/586
1	dO	0.24	0/438	0.55	0/586
1	dP	0.24	0/438	0.56	0/586
1	dQ	0.25	0/438	0.57	0/586
1	dR	0.26	0/438	0.54	0/586
1	dZ	0.25	0/438	0.56	0/586
1	da	0.25	0/438	0.57	0/586
1	db	0.26	0/438	0.54	0/586
1	dj	0.25	0/438	0.56	0/586
1	dk	0.24	0/438	0.56	0/586
1	dl	0.24	0/438	0.55	0/586
1	dm	0.24	0/438	0.55	0/586
1	dn	0.24	0/438	0.56	0/586
1	do	0.25	0/438	0.57	0/586
1	dp	0.26	0/438	0.54	0/586
1	dx	0.25	0/438	0.56	0/586
1	dy	0.24	0/438	0.56	0/586
1	dz	0.24	0/438	0.55	0/586
1	eB	0.25	0/438	0.56	0/586
1	eC	0.25	0/438	0.55	0/586
1	eD	0.24	0/438	0.55	0/586
1	eE	0.24	0/438	0.54	0/586
1	eF	0.24	0/438	0.56	0/586
1	eG	0.25	0/438	0.57	0/586
1	eH	0.26	0/438	0.54	0/586
1	eP	0.25	0/438	0.56	0/586
1	eQ	0.25	0/438	0.56	0/586
1	eR	0.24	0/438	0.55	0/586
1	eS	0.24	0/438	0.54	0/586
1	eT	0.24	0/438	0.56	0/586
1	eU	0.25	0/438	0.57	0/586
1	eV	0.26	0/438	0.54	0/586
1	ea	0.24	0/438	0.56	0/586

Mol	Chain	Bond lengths		Bond angles	
		RMSZ	# Z >5	RMSZ	# Z >5
1	eb	0.24	0/438	0.55	0/586
1	ec	0.24	0/438	0.55	0/586
1	ed	0.24	0/438	0.56	0/586
1	ee	0.25	0/438	0.57	0/586
1	ef	0.26	0/438	0.54	0/586
1	en	0.25	0/438	0.56	0/586
1	eo	0.24	0/438	0.56	0/586
1	ep	0.24	0/438	0.55	0/586
1	eq	0.24	0/438	0.55	0/586
1	er	0.24	0/438	0.56	0/586
1	es	0.25	0/438	0.57	0/586
1	et	0.26	0/438	0.54	0/586
1	fF	0.25	0/438	0.56	0/586
1	fG	0.25	0/438	0.56	0/586
1	fH	0.24	0/438	0.55	0/586
1	fI	0.24	0/438	0.55	0/586
1	fJ	0.24	0/438	0.56	0/586
1	fK	0.25	0/438	0.57	0/586
1	fL	0.26	0/438	0.54	0/586
1	fT	0.25	0/438	0.56	0/586
1	fU	0.24	0/438	0.55	0/586
1	fV	0.24	0/438	0.55	0/586
1	fW	0.24	0/438	0.55	0/586
1	fX	0.24	0/438	0.56	0/586
1	fY	0.25	0/438	0.57	0/586
1	fZ	0.26	0/438	0.54	0/586
1	fd	0.25	0/438	0.56	0/586
1	fe	0.24	0/438	0.56	0/586
1	ff	0.24	0/438	0.55	0/586
1	fg	0.24	0/438	0.55	0/586
1	fh	0.24	0/438	0.55	0/586
1	fi	0.25	0/438	0.57	0/586
1	fj	0.26	0/438	0.54	0/586
1	fr	0.25	0/438	0.56	0/586
1	fs	0.24	0/438	0.56	0/586
1	ft	0.24	0/438	0.55	0/586
1	fu	0.24	0/438	0.54	0/586
1	fv	0.24	0/438	0.55	0/586
1	fw	0.25	0/438	0.57	0/586
1	fx	0.26	0/438	0.54	0/586
1	gA	0.25	0/438	0.57	0/586
1	gB	0.26	0/438	0.54	0/586
1	gJ	0.25	0/438	0.56	0/586

Mol	Chain	Bond lengths		Bond angles	
		RMSZ	# Z >5	RMSZ	# Z >5
1	gK	0.24	0/438	0.56	0/586
1	gL	0.24	0/438	0.55	0/586
1	gM	0.24	0/438	0.55	0/586
1	gN	0.24	0/438	0.56	0/586
1	gO	0.25	0/438	0.57	0/586
1	gP	0.26	0/438	0.54	0/586
1	gX	0.25	0/438	0.56	0/586
1	gY	0.24	0/438	0.56	0/586
1	gZ	0.24	0/438	0.55	0/586
1	gh	0.25	0/438	0.56	0/586
1	gi	0.24	0/438	0.55	0/586
1	gj	0.24	0/438	0.55	0/586
1	gk	0.24	0/438	0.54	0/586
1	gl	0.24	0/438	0.56	0/586
1	gm	0.25	0/438	0.57	0/586
1	gn	0.26	0/438	0.54	0/586
1	gv	0.25	0/438	0.56	0/586
1	gw	0.24	0/438	0.56	0/586
1	gx	0.24	0/438	0.55	0/586
1	gy	0.24	0/438	0.55	0/586
1	gz	0.24	0/438	0.56	0/586
1	hA	0.24	0/438	0.55	0/586
1	hB	0.24	0/438	0.55	0/586
1	hC	0.24	0/438	0.55	0/586
1	hD	0.25	0/438	0.57	0/586
1	hE	0.26	0/438	0.54	0/586
1	hL	0.25	0/438	0.56	0/586
1	hM	0.24	0/438	0.56	0/586
1	hN	0.24	0/438	0.55	0/586
1	hO	0.24	0/438	0.54	0/586
1	hP	0.24	0/438	0.56	0/586
1	hQ	0.25	0/438	0.57	0/586
1	hR	0.26	0/438	0.54	0/586
1	hZ	0.25	0/438	0.56	0/586
1	ha	0.24	0/438	0.54	0/586
1	hb	0.24	0/438	0.56	0/586
1	hc	0.25	0/438	0.57	0/586
1	hd	0.26	0/438	0.54	0/586
1	hl	0.25	0/438	0.56	0/586
1	hm	0.24	0/438	0.56	0/586
1	hn	0.24	0/438	0.55	0/586
1	ho	0.24	0/438	0.55	0/586
1	hp	0.24	0/438	0.56	0/586

Mol	Chain	Bond lengths		Bond angles	
		RMSZ	# Z >5	RMSZ	# Z >5
1	hq	0.25	0/438	0.57	0/586
1	hr	0.26	0/438	0.54	0/586
1	hy	0.25	0/438	0.56	0/586
1	hz	0.24	0/438	0.56	0/586
1	iB	0.25	0/438	0.56	0/586
1	iC	0.24	0/438	0.56	0/586
1	iD	0.24	0/438	0.55	0/586
1	iE	0.24	0/438	0.55	0/586
1	iF	0.24	0/438	0.56	0/586
1	iG	0.25	0/438	0.57	0/586
1	iH	0.26	0/438	0.53	0/586
1	iP	0.25	0/438	0.56	0/586
1	iQ	0.25	0/438	0.56	0/586
1	iR	0.24	0/438	0.55	0/586
1	iS	0.24	0/438	0.54	0/586
1	iT	0.24	0/438	0.56	0/586
1	iU	0.25	0/438	0.57	0/586
1	iV	0.26	0/438	0.54	0/586
1	ia	0.24	0/438	0.56	0/586
1	ib	0.24	0/438	0.55	0/586
1	ic	0.24	0/438	0.54	0/586
1	id	0.24	0/438	0.56	0/586
1	ie	0.25	0/438	0.57	0/586
1	if	0.26	0/438	0.54	0/586
1	in	0.25	0/438	0.56	0/586
1	io	0.24	0/438	0.56	0/586
1	ip	0.24	0/438	0.55	0/586
1	iq	0.24	0/438	0.54	0/586
1	ir	0.24	0/438	0.56	0/586
1	is	0.25	0/438	0.57	0/586
1	it	0.26	0/438	0.54	0/586
1	jF	0.25	0/438	0.56	0/586
1	jG	0.24	0/438	0.55	0/586
1	jH	0.24	0/438	0.55	0/586
1	jI	0.24	0/438	0.54	0/586
1	jJ	0.24	0/438	0.56	0/586
1	jK	0.25	0/438	0.57	0/586
1	jL	0.26	0/438	0.54	0/586
1	jT	0.25	0/438	0.56	0/586
1	jU	0.24	0/438	0.56	0/586
1	jV	0.24	0/438	0.55	0/586
1	jW	0.24	0/438	0.55	0/586
1	jX	0.24	0/438	0.56	0/586

Mol	Chain	Bond lengths		Bond angles	
		RMSZ	# Z >5	RMSZ	# Z >5
1	jY	0.25	0/438	0.57	0/586
1	jZ	0.26	0/438	0.54	0/586
1	jd	0.25	0/438	0.56	0/586
1	je	0.24	0/438	0.56	0/586
1	jf	0.24	0/438	0.55	0/586
1	jg	0.24	0/438	0.54	0/586
1	jh	0.24	0/438	0.56	0/586
1	ji	0.25	0/438	0.57	0/586
1	jj	0.26	0/438	0.54	0/586
1	jr	0.25	0/438	0.56	0/586
1	js	0.24	0/438	0.56	0/586
1	jt	0.24	0/438	0.55	0/586
1	ju	0.24	0/438	0.55	0/586
1	jv	0.24	0/438	0.56	0/586
1	jw	0.25	0/438	0.57	0/586
1	jx	0.26	0/438	0.54	0/586
1	kA	0.26	0/438	0.54	0/586
1	kI	0.25	0/438	0.56	0/586
1	kJ	0.24	0/438	0.56	0/586
1	kK	0.24	0/438	0.55	0/586
1	kL	0.24	0/438	0.55	0/586
1	kM	0.24	0/438	0.56	0/586
1	kN	0.25	0/438	0.57	0/586
1	kO	0.26	0/438	0.54	0/586
1	kW	0.25	0/438	0.56	0/586
1	kX	0.24	0/438	0.56	0/586
1	kY	0.24	0/438	0.55	0/586
1	kZ	0.24	0/438	0.55	0/586
1	kh	0.25	0/438	0.56	0/586
1	ki	0.24	0/438	0.56	0/586
1	kj	0.24	0/438	0.55	0/586
1	kk	0.24	0/438	0.54	0/586
1	kl	0.24	0/438	0.56	0/586
1	km	0.25	0/438	0.57	0/586
1	kn	0.26	0/438	0.54	0/586
1	ku	0.25	0/438	0.56	0/586
1	0.24	0/438	0.56	0/586	
1	kw	0.24	0/438	0.55	0/586
1	kx	0.24	0/438	0.55	0/586
1	ky	0.24	0/438	0.56	0/586
1	kz	0.25	0/438	0.57	0/586
1	lA	0.24	0/438	0.55	0/586
1	lB	0.24	0/438	0.54	0/586

Mol	Chain	Bond lengths		Bond angles	
		RMSZ	# Z >5	RMSZ	# Z >5
1	lC	0.24	0/438	0.56	0/586
1	lD	0.25	0/438	0.57	0/586
1	lE	0.26	0/438	0.54	0/586
1	lM	0.25	0/438	0.56	0/586
1	lN	0.24	0/438	0.56	0/586
1	lO	0.24	0/438	0.55	0/586
1	lP	0.24	0/438	0.54	0/586
1	lQ	0.24	0/438	0.56	0/586
1	lR	0.25	0/438	0.57	0/586
1	lS	0.26	0/438	0.54	0/586
1	la	0.24	0/438	0.56	0/586
1	lb	0.25	0/438	0.57	0/586
1	lc	0.26	0/438	0.54	0/586
1	lk	0.25	0/438	0.56	0/586
1	ll	0.24	0/438	0.55	0/586
1	lm	0.24	0/438	0.55	0/586
1	ln	0.24	0/438	0.54	0/586
1	lo	0.24	0/438	0.56	0/586
1	lp	0.25	0/438	0.57	0/586
1	lq	0.26	0/438	0.54	0/586
1	ly	0.25	0/438	0.56	0/586
1	lz	0.24	0/438	0.56	0/586
1	mC	0.25	0/438	0.56	0/586
1	mD	0.24	0/438	0.56	0/586
1	mE	0.24	0/438	0.55	0/586
1	mF	0.24	0/438	0.55	0/586
1	mG	0.24	0/438	0.56	0/586
1	mH	0.25	0/438	0.57	0/586
1	mI	0.26	0/438	0.54	0/586
1	mQ	0.25	0/438	0.56	0/586
1	mR	0.24	0/438	0.56	0/586
1	mS	0.24	0/438	0.55	0/586
1	mT	0.24	0/438	0.54	0/586
1	mU	0.24	0/438	0.56	0/586
1	mV	0.25	0/438	0.57	0/586
1	mW	0.26	0/438	0.54	0/586
1	ma	0.25	0/438	0.56	0/586
1	mb	0.24	0/438	0.56	0/586
1	mc	0.24	0/438	0.55	0/586
1	md	0.24	0/438	0.55	0/586
1	me	0.24	0/438	0.56	0/586
1	mf	0.25	0/438	0.57	0/586
1	mg	0.26	0/438	0.54	0/586

Mol	Chain	Bond lengths		Bond angles	
		RMSZ	# Z >5	RMSZ	# Z >5
1	mo	0.25	0/438	0.56	0/586
1	mp	0.24	0/438	0.56	0/586
1	mq	0.24	0/438	0.55	0/586
1	mr	0.24	0/438	0.54	0/586
1	ms	0.24	0/438	0.56	0/586
1	mt	0.25	0/438	0.57	0/586
1	mu	0.26	0/438	0.54	0/586
1	nG	0.25	0/438	0.56	0/586
1	nH	0.24	0/438	0.56	0/586
1	nI	0.24	0/438	0.55	0/586
1	nJ	0.24	0/438	0.55	0/586
1	nK	0.24	0/438	0.56	0/586
1	nL	0.25	0/438	0.57	0/586
1	nM	0.26	0/438	0.54	0/586
1	nU	0.25	0/438	0.56	0/586
1	nV	0.24	0/438	0.56	0/586
1	nW	0.24	0/438	0.55	0/586
1	nX	0.24	0/438	0.54	0/586
1	nY	0.24	0/438	0.56	0/586
1	nZ	0.25	0/438	0.57	0/586
1	ne	0.25	0/438	0.56	0/586
1	nf	0.24	0/438	0.56	0/586
1	ng	0.24	0/438	0.55	0/586
1	nh	0.24	0/438	0.54	0/586
1	ni	0.24	0/438	0.56	0/586
1	nj	0.25	0/438	0.57	0/586
1	nk	0.26	0/438	0.54	0/586
1	ns	0.25	0/438	0.56	0/586
1	nt	0.24	0/438	0.56	0/586
1	nu	0.24	0/438	0.55	0/586
1	nv	0.24	0/438	0.55	0/586
1	nw	0.24	0/438	0.56	0/586
1	nx	0.25	0/438	0.57	0/586
1	ny	0.26	0/438	0.54	0/586
1	oA	0.24	0/438	0.55	0/586
1	oB	0.25	0/438	0.57	0/586
1	oC	0.26	0/438	0.54	0/586
1	oK	0.25	0/438	0.56	0/586
1	oL	0.24	0/438	0.56	0/586
1	oM	0.24	0/438	0.55	0/586
1	oN	0.24	0/438	0.54	0/586
1	oO	0.24	0/438	0.55	0/586
1	oP	0.25	0/438	0.57	0/586

Mol	Chain	Bond lengths		Bond angles	
		RMSZ	# Z >5	RMSZ	# Z >5
1	oQ	0.26	0/438	0.54	0/586
1	oY	0.25	0/438	0.56	0/586
1	oZ	0.24	0/438	0.56	0/586
1	oa	0.26	0/438	0.54	0/586
1	oi	0.25	0/438	0.56	0/586
1	oj	0.24	0/438	0.56	0/586
1	ok	0.24	0/438	0.55	0/586
1	ol	0.24	0/438	0.54	0/586
1	om	0.24	0/438	0.56	0/586
1	on	0.25	0/438	0.57	0/586
1	oo	0.26	0/438	0.54	0/586
1	ow	0.25	0/438	0.56	0/586
1	ox	0.24	0/438	0.56	0/586
1	oy	0.24	0/438	0.55	0/586
1	oz	0.24	0/438	0.55	0/586
1	pA	0.25	0/438	0.56	0/586
1	pB	0.25	0/438	0.56	0/586
1	pC	0.24	0/438	0.55	0/586
1	pD	0.24	0/438	0.55	0/586
1	pE	0.24	0/438	0.56	0/586
1	pF	0.25	0/438	0.57	0/586
1	pG	0.26	0/438	0.54	0/586
1	pO	0.25	0/438	0.56	0/586
1	pP	0.24	0/438	0.56	0/586
1	pQ	0.24	0/438	0.55	0/586
1	pR	0.24	0/438	0.55	0/586
1	pS	0.24	0/438	0.55	0/586
1	pT	0.25	0/438	0.57	0/586
1	pU	0.26	0/438	0.54	0/586
1	pa	0.24	0/438	0.55	0/586
1	pb	0.24	0/438	0.55	0/586
1	pc	0.24	0/438	0.55	0/586
1	pd	0.25	0/438	0.57	0/586
1	pe	0.26	0/438	0.54	0/586
1	pm	0.25	0/438	0.56	0/586
1	pn	0.24	0/438	0.56	0/586
1	po	0.24	0/438	0.55	0/586
1	pp	0.24	0/438	0.54	0/586
1	pq	0.24	0/438	0.56	0/586
1	pr	0.25	0/438	0.57	0/586
1	ps	0.26	0/438	0.54	0/586
1	qc	0.25	0/438	0.56	0/586
2	aH	0.26	0/2357	0.52	0/3202

Mol	Chain	Bond lengths		Bond angles	
		RMSZ	# Z >5	RMSZ	# Z >5
2	aI	0.26	0/2369	0.51	0/3219
2	aJ	0.26	0/2357	0.55	2/3202 (0.1%)
2	aK	0.25	0/2357	0.50	0/3202
2	aL	0.26	0/2357	0.52	0/3202
2	aM	0.25	0/2357	0.51	0/3202
2	aN	0.25	0/2357	0.50	0/3202
2	aV	0.26	0/2357	0.51	0/3202
2	aW	0.26	0/2369	0.51	0/3219
2	aX	0.26	0/2357	0.55	2/3202 (0.1%)
2	aY	0.25	0/2357	0.49	0/3202
2	aZ	0.26	0/2357	0.52	0/3202
2	ag	0.26	0/2357	0.51	0/3202
2	ah	0.26	0/2369	0.51	0/3219
2	ai	0.26	0/2357	0.55	2/3202 (0.1%)
2	aj	0.25	0/2357	0.49	0/3202
2	ak	0.26	0/2357	0.52	0/3202
2	al	0.25	0/2357	0.51	0/3202
2	am	0.25	0/2357	0.50	0/3202
2	au	0.26	0/2357	0.51	0/3202
2	av	0.26	0/2357	0.55	2/3202 (0.1%)
2	aw	0.25	0/2357	0.49	0/3202
2	ax	0.26	0/2357	0.52	0/3202
2	ay	0.25	0/2357	0.51	0/3202
2	az	0.25	0/2357	0.50	0/3202
2	bA	0.25	0/2357	0.50	0/3202
2	bB	0.26	0/2357	0.52	0/3202
2	bC	0.25	0/2357	0.51	0/3202
2	bD	0.25	0/2357	0.50	0/3202
2	bL	0.26	0/2357	0.52	0/3202
2	bM	0.26	0/2357	0.55	2/3202 (0.1%)
2	bN	0.25	0/2357	0.49	0/3202
2	bO	0.26	0/2357	0.52	0/3202
2	bP	0.25	0/2357	0.51	0/3202
2	bQ	0.25	0/2357	0.50	0/3202
2	bY	0.26	0/2357	0.51	0/3202
2	bZ	0.26	0/2369	0.51	0/3219
2	ba	0.25	0/2357	0.51	0/3202
2	bb	0.25	0/2357	0.50	0/3202
2	bj	0.26	0/2357	0.51	0/3202
2	bk	0.26	0/2369	0.51	0/3219
2	bl	0.26	0/2357	0.55	2/3202 (0.1%)
2	bm	0.25	0/2357	0.49	0/3202
2	bn	0.26	0/2357	0.52	0/3202

Mol	Chain	Bond lengths		Bond angles	
		RMSZ	# Z >5	RMSZ	# Z >5
2	bo	0.25	0/2357	0.51	0/3202
2	bp	0.25	0/2357	0.50	0/3202
2	bx	0.26	0/2357	0.52	0/3202
2	by	0.26	0/2369	0.51	0/3219
2	bz	0.26	0/2357	0.55	2/3202 (0.1%)
2	cA	0.26	0/2357	0.52	0/3202
2	cB	0.26	0/2369	0.51	0/3219
2	cC	0.26	0/2357	0.55	2/3202 (0.1%)
2	cD	0.25	0/2357	0.49	0/3202
2	cE	0.26	0/2357	0.52	0/3202
2	cF	0.25	0/2357	0.51	0/3202
2	cG	0.25	0/2357	0.50	0/3202
2	cO	0.26	0/2357	0.52	0/3202
2	cP	0.26	0/2369	0.51	0/3219
2	cQ	0.26	0/2357	0.55	2/3202 (0.1%)
2	cR	0.25	0/2357	0.49	0/3202
2	cS	0.26	0/2357	0.52	0/3202
2	cT	0.25	0/2357	0.51	0/3202
2	cU	0.25	0/2357	0.50	0/3202
2	ca	0.26	0/2357	0.55	2/3202 (0.1%)
2	cb	0.25	0/2357	0.49	0/3202
2	cc	0.26	0/2357	0.52	0/3202
2	cd	0.25	0/2357	0.51	0/3202
2	ce	0.25	0/2357	0.50	0/3202
2	cm	0.26	0/2357	0.52	0/3202
2	cn	0.26	0/2369	0.51	0/3219
2	co	0.26	0/2357	0.55	2/3202 (0.1%)
2	cp	0.25	0/2357	0.50	0/3202
2	cq	0.26	0/2357	0.52	0/3202
2	cr	0.25	0/2357	0.51	0/3202
2	cs	0.25	0/2357	0.50	0/3202
2	dE	0.26	0/2357	0.51	0/3202
2	dF	0.26	0/2369	0.51	0/3219
2	dG	0.26	0/2357	0.55	2/3202 (0.1%)
2	dH	0.25	0/2357	0.49	0/3202
2	dI	0.26	0/2357	0.52	0/3202
2	dJ	0.25	0/2357	0.51	0/3202
2	dK	0.25	0/2357	0.50	0/3202
2	dS	0.26	0/2357	0.52	0/3202
2	dT	0.26	0/2369	0.51	0/3219
2	dU	0.26	0/2357	0.55	2/3202 (0.1%)
2	dV	0.25	0/2357	0.49	0/3202
2	dW	0.26	0/2357	0.52	0/3202

Mol	Chain	Bond lengths		Bond angles	
		RMSZ	# Z >5	RMSZ	# Z >5
2	dX	0.25	0/2357	0.51	0/3202
2	dY	0.25	0/2357	0.50	0/3202
2	dc	0.26	0/2357	0.52	0/3202
2	dd	0.26	0/2369	0.51	0/3219
2	de	0.26	0/2357	0.55	2/3202 (0.1%)
2	df	0.25	0/2357	0.49	0/3202
2	dg	0.26	0/2357	0.52	0/3202
2	dh	0.25	0/2357	0.51	0/3202
2	di	0.25	0/2357	0.50	0/3202
2	dq	0.26	0/2357	0.52	0/3202
2	dr	0.26	0/2369	0.51	0/3219
2	ds	0.26	0/2357	0.55	2/3202 (0.1%)
2	dt	0.25	0/2357	0.49	0/3202
2	du	0.26	0/2357	0.52	0/3202
2	dv	0.25	0/2357	0.51	0/3202
2	dw	0.25	0/2357	0.50	0/3202
2	eA	0.25	0/2357	0.50	0/3202
2	eI	0.26	0/2357	0.51	0/3202
2	eJ	0.26	0/2369	0.51	0/3219
2	eK	0.26	0/2357	0.55	2/3202 (0.1%)
2	eL	0.25	0/2357	0.50	0/3202
2	eM	0.26	0/2357	0.52	0/3202
2	eN	0.25	0/2357	0.51	0/3202
2	eO	0.25	0/2357	0.50	0/3202
2	eW	0.26	0/2357	0.51	0/3202
2	eX	0.26	0/2369	0.51	0/3219
2	eY	0.26	0/2357	0.55	2/3202 (0.1%)
2	eZ	0.25	0/2357	0.50	0/3202
2	eg	0.26	0/2357	0.51	0/3202
2	eh	0.26	0/2369	0.51	0/3219
2	ei	0.26	0/2357	0.55	2/3202 (0.1%)
2	ej	0.25	0/2357	0.50	0/3202
2	ek	0.26	0/2357	0.52	0/3202
2	el	0.25	0/2357	0.51	0/3202
2	em	0.25	0/2357	0.50	0/3202
2	eu	0.26	0/2357	0.51	0/3202
2	ev	0.26	0/2369	0.51	0/3219
2	ew	0.26	0/2357	0.55	2/3202 (0.1%)
2	ex	0.25	0/2357	0.49	0/3202
2	ey	0.26	0/2357	0.52	0/3202
2	ez	0.25	0/2357	0.51	0/3202
2	fA	0.26	0/2357	0.55	2/3202 (0.1%)
2	fB	0.25	0/2357	0.49	0/3202

Mol	Chain	Bond lengths		Bond angles	
		RMSZ	# Z >5	RMSZ	# Z >5
2	fC	0.26	0/2357	0.52	0/3202
2	fD	0.25	0/2357	0.51	0/3202
2	fE	0.25	0/2357	0.50	0/3202
2	fM	0.26	0/2357	0.51	0/3202
2	fN	0.26	0/2369	0.51	0/3219
2	fO	0.26	0/2357	0.55	2/3202 (0.1%)
2	fP	0.25	0/2357	0.49	0/3202
2	fQ	0.26	0/2357	0.52	0/3202
2	fR	0.25	0/2357	0.51	0/3202
2	fS	0.25	0/2357	0.50	0/3202
2	fa	0.26	0/2357	0.52	0/3202
2	fb	0.25	0/2357	0.51	0/3202
2	fc	0.25	0/2357	0.50	0/3202
2	fk	0.26	0/2357	0.52	0/3202
2	fl	0.26	0/2369	0.51	0/3219
2	fm	0.26	0/2357	0.55	2/3202 (0.1%)
2	fn	0.25	0/2357	0.49	0/3202
2	fo	0.26	0/2357	0.52	0/3202
2	fp	0.25	0/2357	0.51	0/3202
2	fq	0.25	0/2357	0.50	0/3202
2	fy	0.26	0/2357	0.51	0/3202
2	fz	0.26	0/2369	0.51	0/3219
2	gC	0.26	0/2357	0.51	0/3202
2	gD	0.26	0/2369	0.51	0/3219
2	gE	0.26	0/2357	0.55	2/3202 (0.1%)
2	gF	0.25	0/2357	0.50	0/3202
2	gG	0.26	0/2357	0.52	0/3202
2	gH	0.25	0/2357	0.51	0/3202
2	gI	0.25	0/2357	0.50	0/3202
2	gQ	0.26	0/2357	0.52	0/3202
2	gR	0.26	0/2369	0.51	0/3219
2	gS	0.26	0/2357	0.55	2/3202 (0.1%)
2	gT	0.25	0/2357	0.50	0/3202
2	gU	0.26	0/2357	0.52	0/3202
2	gV	0.25	0/2357	0.51	0/3202
2	gW	0.25	0/2357	0.50	0/3202
2	ga	0.26	0/2357	0.52	0/3202
2	gb	0.26	0/2369	0.51	0/3219
2	gc	0.26	0/2357	0.55	2/3202 (0.1%)
2	gd	0.25	0/2357	0.49	0/3202
2	ge	0.26	0/2357	0.52	0/3202
2	gf	0.25	0/2357	0.51	0/3202
2	gg	0.25	0/2357	0.50	0/3202

Mol	Chain	Bond lengths		Bond angles	
		RMSZ	# Z >5	RMSZ	# Z >5
2	go	0.26	0/2357	0.51	0/3202
2	gp	0.26	0/2369	0.51	0/3219
2	gq	0.26	0/2357	0.55	2/3202 (0.1%)
2	gr	0.25	0/2357	0.49	0/3202
2	gs	0.26	0/2357	0.52	0/3202
2	gt	0.25	0/2357	0.51	0/3202
2	gu	0.25	0/2357	0.50	0/3202
2	hF	0.26	0/2357	0.51	0/3202
2	hG	0.26	0/2357	0.55	2/3202 (0.1%)
2	hH	0.25	0/2357	0.50	0/3202
2	hI	0.26	0/2357	0.52	0/3202
2	hJ	0.25	0/2357	0.51	0/3202
2	hK	0.25	0/2357	0.50	0/3202
2	hS	0.26	0/2357	0.52	0/3202
2	hT	0.26	0/2369	0.51	0/3219
2	hU	0.26	0/2357	0.55	2/3202 (0.1%)
2	hV	0.25	0/2357	0.50	0/3202
2	hW	0.26	0/2357	0.52	0/3202
2	hX	0.25	0/2357	0.51	0/3202
2	hY	0.25	0/2357	0.50	0/3202
2	he	0.26	0/2357	0.51	0/3202
2	hf	0.26	0/2369	0.51	0/3219
2	hg	0.26	0/2357	0.55	2/3202 (0.1%)
2	hh	0.25	0/2357	0.49	0/3202
2	hi	0.26	0/2357	0.52	0/3202
2	hj	0.25	0/2357	0.51	0/3202
2	hk	0.25	0/2357	0.50	0/3202
2	hs	0.26	0/2357	0.51	0/3202
2	ht	0.26	0/2357	0.55	2/3202 (0.1%)
2	hu	0.25	0/2357	0.50	0/3202
2	hv	0.26	0/2357	0.52	0/3202
2	hw	0.25	0/2357	0.51	0/3202
2	hx	0.25	0/2357	0.50	0/3202
2	iA	0.25	0/2357	0.50	0/3202
2	iI	0.26	0/2357	0.52	0/3202
2	iJ	0.26	0/2369	0.51	0/3219
2	iK	0.26	0/2357	0.55	2/3202 (0.1%)
2	iL	0.25	0/2357	0.50	0/3202
2	iM	0.26	0/2357	0.52	0/3202
2	iN	0.25	0/2357	0.51	0/3202
2	iO	0.25	0/2357	0.50	0/3202
2	iW	0.26	0/2357	0.51	0/3202
2	iX	0.26	0/2369	0.51	0/3219

Mol	Chain	Bond lengths		Bond angles	
		RMSZ	# Z >5	RMSZ	# Z >5
2	iY	0.26	0/2357	0.55	2/3202 (0.1%)
2	iZ	0.25	0/2357	0.49	0/3202
2	ig	0.26	0/2357	0.51	0/3202
2	ih	0.26	0/2369	0.51	0/3219
2	ii	0.26	0/2357	0.55	2/3202 (0.1%)
2	ij	0.25	0/2357	0.49	0/3202
2	ik	0.26	0/2357	0.52	0/3202
2	il	0.25	0/2357	0.51	0/3202
2	im	0.25	0/2357	0.50	0/3202
2	iu	0.26	0/2357	0.51	0/3202
2	iv	0.26	0/2369	0.51	0/3219
2	iw	0.26	0/2357	0.55	2/3202 (0.1%)
2	ix	0.25	0/2357	0.49	0/3202
2	iy	0.26	0/2357	0.52	0/3202
2	iz	0.25	0/2357	0.51	0/3202
2	jA	0.26	0/2357	0.55	2/3202 (0.1%)
2	jB	0.25	0/2357	0.50	0/3202
2	jC	0.26	0/2357	0.52	0/3202
2	jD	0.25	0/2357	0.51	0/3202
2	jE	0.25	0/2357	0.50	0/3202
2	jM	0.26	0/2357	0.52	0/3202
2	jN	0.26	0/2369	0.51	0/3219
2	jO	0.26	0/2357	0.55	2/3202 (0.1%)
2	jP	0.25	0/2357	0.50	0/3202
2	jQ	0.26	0/2357	0.52	0/3202
2	jR	0.25	0/2357	0.51	0/3202
2	jS	0.25	0/2357	0.50	0/3202
2	ja	0.26	0/2357	0.52	0/3202
2	jb	0.25	0/2357	0.51	0/3202
2	jc	0.25	0/2357	0.50	0/3202
2	jk	0.26	0/2357	0.51	0/3202
2	jl	0.26	0/2369	0.51	0/3219
2	jm	0.26	0/2357	0.55	2/3202 (0.1%)
2	jn	0.25	0/2357	0.49	0/3202
2	jo	0.26	0/2357	0.52	0/3202
2	jp	0.25	0/2357	0.51	0/3202
2	jq	0.25	0/2357	0.50	0/3202
2	jy	0.26	0/2357	0.51	0/3202
2	jz	0.26	0/2369	0.51	0/3219
2	kB	0.26	0/2357	0.51	0/3202
2	kC	0.26	0/2369	0.51	0/3219
2	kD	0.26	0/2357	0.55	2/3202 (0.1%)
2	kE	0.25	0/2357	0.50	0/3202

Mol	Chain	Bond lengths		Bond angles	
		RMSZ	# Z >5	RMSZ	# Z >5
2	kF	0.26	0/2357	0.52	0/3202
2	kG	0.25	0/2357	0.51	0/3202
2	kH	0.25	0/2357	0.50	0/3202
2	kP	0.26	0/2357	0.51	0/3202
2	kQ	0.26	0/2369	0.51	0/3219
2	kR	0.26	0/2357	0.55	2/3202 (0.1%)
2	kS	0.25	0/2357	0.49	0/3202
2	kT	0.26	0/2357	0.52	0/3202
2	kU	0.25	0/2357	0.51	0/3202
2	kV	0.25	0/2357	0.50	0/3202
2	ka	0.26	0/2357	0.51	0/3202
2	kb	0.26	0/2369	0.51	0/3219
2	kc	0.26	0/2357	0.55	2/3202 (0.1%)
2	kd	0.25	0/2357	0.50	0/3202
2	ke	0.26	0/2357	0.52	0/3202
2	kf	0.25	0/2357	0.51	0/3202
2	kg	0.25	0/2357	0.50	0/3202
2	ko	0.26	0/2357	0.51	0/3202
2	kp	0.26	0/2357	0.55	2/3202 (0.1%)
2	kq	0.25	0/2357	0.49	0/3202
2	kr	0.26	0/2357	0.52	0/3202
2	ks	0.25	0/2357	0.51	0/3202
2	kt	0.25	0/2357	0.50	0/3202
2	lF	0.26	0/2357	0.52	0/3202
2	lG	0.26	0/2369	0.51	0/3219
2	lH	0.26	0/2357	0.55	2/3202 (0.1%)
2	lI	0.25	0/2357	0.50	0/3202
2	lJ	0.26	0/2357	0.52	0/3202
2	lK	0.25	0/2357	0.51	0/3202
2	lL	0.25	0/2357	0.50	0/3202
2	lT	0.26	0/2357	0.51	0/3202
2	lU	0.26	0/2369	0.51	0/3219
2	lV	0.26	0/2357	0.55	2/3202 (0.1%)
2	lW	0.25	0/2357	0.49	0/3202
2	lX	0.26	0/2357	0.52	0/3202
2	lY	0.25	0/2357	0.51	0/3202
2	lZ	0.25	0/2357	0.50	0/3202
2	ld	0.26	0/2357	0.52	0/3202
2	le	0.26	0/2369	0.51	0/3219
2	lf	0.26	0/2357	0.55	2/3202 (0.1%)
2	lg	0.25	0/2357	0.49	0/3202
2	lh	0.26	0/2357	0.52	0/3202
2	li	0.25	0/2357	0.51	0/3202

Mol	Chain	Bond lengths		Bond angles	
		RMSZ	# Z >5	RMSZ	# Z >5
2	lj	0.25	0/2357	0.50	0/3202
2	lr	0.26	0/2357	0.52	0/3202
2	ls	0.26	0/2369	0.51	0/3219
2	lt	0.26	0/2357	0.55	2/3202 (0.1%)
2	lu	0.25	0/2357	0.50	0/3202
2	lv	0.26	0/2357	0.52	0/3202
2	lw	0.25	0/2357	0.51	0/3202
2	lx	0.25	0/2357	0.50	0/3202
2	mA	0.25	0/2357	0.51	0/3202
2	mB	0.25	0/2357	0.50	0/3202
2	mJ	0.26	0/2357	0.51	0/3202
2	mK	0.26	0/2369	0.51	0/3219
2	mL	0.26	0/2357	0.55	2/3202 (0.1%)
2	mM	0.25	0/2357	0.49	0/3202
2	mN	0.26	0/2357	0.52	0/3202
2	mO	0.25	0/2357	0.51	0/3202
2	mP	0.25	0/2357	0.50	0/3202
2	mX	0.26	0/2357	0.51	0/3202
2	mY	0.26	0/2369	0.51	0/3219
2	mZ	0.26	0/2357	0.55	2/3202 (0.1%)
2	mh	0.26	0/2357	0.51	0/3202
2	mi	0.26	0/2369	0.51	0/3219
2	mj	0.26	0/2357	0.55	2/3202 (0.1%)
2	mk	0.25	0/2357	0.49	0/3202
2	ml	0.26	0/2357	0.52	0/3202
2	mm	0.25	0/2357	0.51	0/3202
2	mn	0.25	0/2357	0.50	0/3202
2	mv	0.26	0/2357	0.51	0/3202
2	mw	0.26	0/2369	0.51	0/3219
2	mx	0.26	0/2357	0.55	2/3202 (0.1%)
2	my	0.25	0/2357	0.50	0/3202
2	mz	0.26	0/2357	0.52	0/3202
2	nA	0.26	0/2369	0.51	0/3219
2	nB	0.26	0/2357	0.55	2/3202 (0.1%)
2	nC	0.25	0/2357	0.49	0/3202
2	nD	0.26	0/2357	0.52	0/3202
2	nE	0.25	0/2357	0.51	0/3202
2	nF	0.25	0/2357	0.50	0/3202
2	nN	0.26	0/2357	0.51	0/3202
2	nO	0.26	0/2369	0.51	0/3219
2	nP	0.26	0/2357	0.55	2/3202 (0.1%)
2	nQ	0.25	0/2357	0.49	0/3202
2	nR	0.26	0/2357	0.52	0/3202

Mol	Chain	Bond lengths		Bond angles	
		RMSZ	# Z >5	RMSZ	# Z >5
2	nS	0.25	0/2357	0.51	0/3202
2	nT	0.25	0/2357	0.50	0/3202
2	na	0.25	0/2357	0.49	0/3202
2	nb	0.26	0/2357	0.52	0/3202
2	nc	0.25	0/2357	0.51	0/3202
2	nd	0.25	0/2357	0.50	0/3202
2	nl	0.26	0/2357	0.51	0/3202
2	nm	0.26	0/2369	0.51	0/3219
2	nn	0.26	0/2357	0.55	2/3202 (0.1%)
2	no	0.25	0/2357	0.49	0/3202
2	np	0.26	0/2357	0.52	0/3202
2	nq	0.25	0/2357	0.51	0/3202
2	nr	0.25	0/2357	0.50	0/3202
2	nz	0.26	0/2357	0.52	0/3202
2	oD	0.26	0/2357	0.51	0/3202
2	oE	0.26	0/2369	0.51	0/3219
2	oF	0.26	0/2357	0.55	2/3202 (0.1%)
2	oG	0.25	0/2357	0.50	0/3202
2	oH	0.26	0/2357	0.52	0/3202
2	oI	0.25	0/2357	0.51	0/3202
2	oJ	0.25	0/2357	0.50	0/3202
2	oR	0.26	0/2357	0.51	0/3202
2	oS	0.26	0/2369	0.51	0/3219
2	oT	0.26	0/2357	0.55	2/3202 (0.1%)
2	oU	0.25	0/2357	0.49	0/3202
2	oV	0.26	0/2357	0.52	0/3202
2	oW	0.25	0/2357	0.51	0/3202
2	oX	0.25	0/2357	0.50	0/3202
2	ob	0.26	0/2357	0.52	0/3202
2	oc	0.26	0/2369	0.51	0/3219
2	od	0.26	0/2357	0.55	2/3202 (0.1%)
2	oe	0.25	0/2357	0.49	0/3202
2	of	0.26	0/2357	0.52	0/3202
2	og	0.25	0/2357	0.51	0/3202
2	oh	0.25	0/2357	0.50	0/3202
2	op	0.26	0/2357	0.52	0/3202
2	oq	0.26	0/2369	0.51	0/3219
2	or	0.26	0/2357	0.55	2/3202 (0.1%)
2	os	0.25	0/2357	0.50	0/3202
2	ot	0.26	0/2357	0.52	0/3202
2	ou	0.25	0/2357	0.51	0/3202
2	ov	0.25	0/2357	0.50	0/3202
2	pH	0.26	0/2357	0.51	0/3202

Mol	Chain	Bond lengths		Bond angles	
		RMSZ	# Z >5	RMSZ	# Z >5
2	pI	0.26	0/2369	0.51	0/3219
2	pJ	0.26	0/2357	0.55	2/3202 (0.1%)
2	pK	0.25	0/2357	0.49	0/3202
2	pL	0.26	0/2357	0.52	0/3202
2	pM	0.25	0/2357	0.51	0/3202
2	pN	0.25	0/2357	0.50	0/3202
2	pV	0.26	0/2357	0.51	0/3202
2	pW	0.26	0/2369	0.51	0/3219
2	pX	0.26	0/2357	0.55	2/3202 (0.1%)
2	pY	0.25	0/2357	0.49	0/3202
2	pZ	0.26	0/2357	0.52	0/3202
2	pf	0.26	0/2357	0.52	0/3202
2	pg	0.26	0/2369	0.51	0/3219
2	ph	0.26	0/2357	0.55	2/3202 (0.1%)
2	pi	0.25	0/2357	0.50	0/3202
2	pj	0.26	0/2357	0.52	0/3202
2	pk	0.25	0/2357	0.51	0/3202
2	pl	0.25	0/2357	0.50	0/3202
2	pt	0.26	0/2357	0.52	0/3202
2	pu	0.26	0/2369	0.51	0/3219
2	pv	0.26	0/2357	0.55	2/3202 (0.1%)
2	pw	0.25	0/2357	0.50	0/3202
2	px	0.26	0/2357	0.52	0/3202
2	py	0.25	0/2357	0.51	0/3202
2	pz	0.25	0/2357	0.50	0/3202
2	qa	0.25	0/2357	0.51	0/3202
2	qb	0.25	0/2357	0.50	0/3202
3	qd	0.25	0/1047	0.55	0/1430
3	qe	0.25	0/1047	0.55	0/1430
3	qf	0.25	0/1047	0.55	0/1430
3	qg	0.25	0/1047	0.55	0/1430
3	qh	0.25	0/1047	0.55	0/1430
3	qi	0.25	0/1047	0.55	0/1430
4	qj	0.26	0/1909	0.50	1/2603 (0.0%)
4	qk	0.26	0/1909	0.50	1/2603 (0.0%)
4	ql	0.26	0/1909	0.50	1/2603 (0.0%)
4	qm	0.26	0/1909	0.50	1/2603 (0.0%)
4	qn	0.26	0/1909	0.50	1/2603 (0.0%)
4	qo	0.26	0/1909	0.50	1/2603 (0.0%)
5	qB	0.24	0/3224	0.50	0/4382
5	qD	0.25	0/3224	0.49	0/4382
5	qF	0.24	0/3224	0.49	0/4382
5	qH	0.24	0/3224	0.49	0/4382

Mol	Chain	Bond lengths		Bond angles	
		RMSZ	# Z >5	RMSZ	# Z >5
5	qJ	0.25	0/3224	0.49	0/4382
5	qL	0.25	0/3224	0.50	0/4382
5	qp	0.24	0/3224	0.49	0/4382
5	qr	0.25	0/3224	0.49	0/4382
5	qt	0.25	0/3224	0.49	0/4382
5	qv	0.24	0/3224	0.49	0/4382
5	qx	0.25	0/3224	0.49	0/4382
5	qz	0.25	0/3224	0.49	0/4382
6	qA	0.24	0/1074	0.47	0/1462
6	qC	0.24	0/1074	0.47	0/1462
6	qE	0.24	0/1074	0.47	0/1462
6	qG	0.24	0/1074	0.47	0/1462
6	qI	0.24	0/1074	0.47	0/1462
6	qK	0.24	0/1074	0.47	0/1462
6	qM	0.24	0/1074	0.47	0/1462
6	qq	0.24	0/1074	0.47	0/1462
6	qs	0.24	0/1074	0.47	0/1462
6	qu	0.24	0/1074	0.47	0/1462
6	qw	0.24	0/1074	0.47	0/1462
6	qy	0.24	0/1074	0.47	0/1462
All	All	0.25	0/1232087	0.52	126/1670211 (0.0%)

There are no bond length outliers.

All (126) bond angle outliers are listed below:

Mol	Chain	Res	Type	Atoms	Z	Observed(°)	Ideal(°)
2	ii	256	PRO	N-CD-CG	-7.76	91.56	103.20
2	iY	256	PRO	N-CD-CG	-7.76	91.56	103.20
2	lt	256	PRO	N-CD-CG	-7.76	91.57	103.20
2	dG	256	PRO	N-CD-CG	-7.75	91.57	103.20
2	iw	256	PRO	N-CD-CG	-7.75	91.58	103.20
2	pv	256	PRO	N-CD-CG	-7.75	91.58	103.20
2	fO	256	PRO	N-CD-CG	-7.75	91.58	103.20
2	jO	256	PRO	N-CD-CG	-7.75	91.58	103.20
2	gq	256	PRO	N-CD-CG	-7.74	91.58	103.20
2	nB	256	PRO	N-CD-CG	-7.74	91.59	103.20
2	gE	256	PRO	N-CD-CG	-7.74	91.59	103.20
2	lH	256	PRO	N-CD-CG	-7.74	91.59	103.20
2	or	256	PRO	N-CD-CG	-7.74	91.59	103.20
2	oT	256	PRO	N-CD-CG	-7.74	91.59	103.20
2	pX	256	PRO	N-CD-CG	-7.74	91.59	103.20
2	ca	256	PRO	N-CD-CG	-7.74	91.60	103.20

Continued on next page...

Continued from previous page...

Mol	Chain	Res	Type	Atoms	Z	Observed(°)	Ideal(°)
2	mx	256	PRO	N-CD-CG	-7.74	91.60	103.20
2	kc	256	PRO	N-CD-CG	-7.73	91.60	103.20
2	fm	256	PRO	N-CD-CG	-7.73	91.60	103.20
2	nn	256	PRO	N-CD-CG	-7.73	91.60	103.20
2	av	256	PRO	N-CD-CG	-7.73	91.60	103.20
2	mZ	256	PRO	N-CD-CG	-7.73	91.61	103.20
2	eK	256	PRO	N-CD-CG	-7.73	91.61	103.20
2	gS	256	PRO	N-CD-CG	-7.73	91.61	103.20
2	ai	256	PRO	N-CD-CG	-7.73	91.61	103.20
2	bM	256	PRO	N-CD-CG	-7.73	91.61	103.20
2	hG	256	PRO	N-CD-CG	-7.73	91.61	103.20
2	iK	256	PRO	N-CD-CG	-7.73	91.61	103.20
2	oF	256	PRO	N-CD-CG	-7.73	91.61	103.20
2	co	256	PRO	N-CD-CG	-7.73	91.61	103.20
2	aX	256	PRO	N-CD-CG	-7.72	91.61	103.20
2	bz	256	PRO	N-CD-CG	-7.72	91.61	103.20
2	fA	256	PRO	N-CD-CG	-7.72	91.61	103.20
2	aJ	256	PRO	N-CD-CG	-7.72	91.61	103.20
2	jA	256	PRO	N-CD-CG	-7.72	91.62	103.20
2	jm	256	PRO	N-CD-CG	-7.72	91.62	103.20
2	pJ	256	PRO	N-CD-CG	-7.72	91.62	103.20
2	hU	256	PRO	N-CD-CG	-7.72	91.62	103.20
2	kD	256	PRO	N-CD-CG	-7.72	91.62	103.20
2	od	256	PRO	N-CD-CG	-7.72	91.62	103.20
2	mj	256	PRO	N-CD-CG	-7.72	91.62	103.20
2	bl	256	PRO	N-CD-CG	-7.72	91.62	103.20
2	dU	256	PRO	N-CD-CG	-7.72	91.63	103.20
2	hg	256	PRO	N-CD-CG	-7.72	91.62	103.20
2	lV	256	PRO	N-CD-CG	-7.72	91.63	103.20
2	eY	256	PRO	N-CD-CG	-7.71	91.63	103.20
2	kR	256	PRO	N-CD-CG	-7.71	91.63	103.20
2	lf	256	PRO	N-CD-CG	-7.71	91.63	103.20
2	cC	256	PRO	N-CD-CG	-7.71	91.63	103.20
2	ei	256	PRO	N-CD-CG	-7.71	91.63	103.20
2	de	256	PRO	N-CD-CG	-7.71	91.64	103.20
2	ph	256	PRO	N-CD-CG	-7.71	91.64	103.20
2	cQ	256	PRO	N-CD-CG	-7.71	91.64	103.20
2	gc	256	PRO	N-CD-CG	-7.71	91.64	103.20
2	ew	256	PRO	N-CD-CG	-7.71	91.64	103.20
2	ht	256	PRO	N-CD-CG	-7.71	91.64	103.20
2	kp	256	PRO	N-CD-CG	-7.71	91.64	103.20
2	ds	256	PRO	N-CD-CG	-7.70	91.64	103.20

Continued on next page...

Continued from previous page...

Mol	Chain	Res	Type	Atoms	Z	Observed(°)	Ideal(°)
2	mL	256	PRO	N-CD-CG	-7.70	91.65	103.20
2	nP	256	PRO	N-CD-CG	-7.70	91.65	103.20
2	fm	256	PRO	CA-CB-CG	-6.36	91.92	104.00
2	ii	256	PRO	CA-CB-CG	-6.35	91.93	104.00
2	av	256	PRO	CA-CB-CG	-6.35	91.94	104.00
2	pv	256	PRO	CA-CB-CG	-6.35	91.94	104.00
2	aJ	256	PRO	CA-CB-CG	-6.35	91.94	104.00
2	mx	256	PRO	CA-CB-CG	-6.35	91.94	104.00
2	co	256	PRO	CA-CB-CG	-6.34	91.95	104.00
2	cC	256	PRO	CA-CB-CG	-6.34	91.96	104.00
2	or	256	PRO	CA-CB-CG	-6.34	91.96	104.00
2	ew	256	PRO	CA-CB-CG	-6.34	91.96	104.00
2	gc	256	PRO	CA-CB-CG	-6.34	91.96	104.00
2	gS	256	PRO	CA-CB-CG	-6.34	91.96	104.00
2	kR	256	PRO	CA-CB-CG	-6.34	91.96	104.00
2	mj	256	PRO	CA-CB-CG	-6.34	91.96	104.00
2	fA	256	PRO	CA-CB-CG	-6.33	91.96	104.00
2	gE	256	PRO	CA-CB-CG	-6.33	91.96	104.00
2	bl	256	PRO	CA-CB-CG	-6.33	91.97	104.00
2	jO	256	PRO	CA-CB-CG	-6.33	91.97	104.00
2	lt	256	PRO	CA-CB-CG	-6.33	91.97	104.00
2	dU	256	PRO	CA-CB-CG	-6.33	91.97	104.00
2	iw	256	PRO	CA-CB-CG	-6.33	91.97	104.00
2	iY	256	PRO	CA-CB-CG	-6.33	91.97	104.00
2	mZ	256	PRO	CA-CB-CG	-6.33	91.97	104.00
2	hG	256	PRO	CA-CB-CG	-6.33	91.97	104.00
2	lH	256	PRO	CA-CB-CG	-6.33	91.97	104.00
2	pX	256	PRO	CA-CB-CG	-6.33	91.97	104.00
2	fO	256	PRO	CA-CB-CG	-6.33	91.97	104.00
2	od	256	PRO	CA-CB-CG	-6.33	91.97	104.00
2	iK	256	PRO	CA-CB-CG	-6.33	91.98	104.00
2	ai	256	PRO	CA-CB-CG	-6.33	91.98	104.00
2	ds	256	PRO	CA-CB-CG	-6.33	91.98	104.00
2	dG	256	PRO	CA-CB-CG	-6.33	91.98	104.00
2	gq	256	PRO	CA-CB-CG	-6.33	91.98	104.00
2	jA	256	PRO	CA-CB-CG	-6.33	91.98	104.00
2	kp	256	PRO	CA-CB-CG	-6.33	91.98	104.00
2	oF	256	PRO	CA-CB-CG	-6.33	91.98	104.00
2	hg	256	PRO	CA-CB-CG	-6.32	91.99	104.00
2	nB	256	PRO	CA-CB-CG	-6.32	91.99	104.00
2	bM	256	PRO	CA-CB-CG	-6.32	91.99	104.00
2	hU	256	PRO	CA-CB-CG	-6.32	91.99	104.00

Continued on next page...

Continued from previous page...

Mol	Chain	Res	Type	Atoms	Z	Observed(°)	Ideal(°)
2	mL	256	PRO	CA-CB-CG	-6.32	91.99	104.00
2	cQ	256	PRO	CA-CB-CG	-6.32	92.00	104.00
2	kD	256	PRO	CA-CB-CG	-6.32	91.99	104.00
2	de	256	PRO	CA-CB-CG	-6.32	92.00	104.00
2	jm	256	PRO	CA-CB-CG	-6.32	92.00	104.00
2	nn	256	PRO	CA-CB-CG	-6.32	92.00	104.00
2	oT	256	PRO	CA-CB-CG	-6.32	92.00	104.00
2	pJ	256	PRO	CA-CB-CG	-6.32	92.00	104.00
2	aX	256	PRO	CA-CB-CG	-6.32	92.00	104.00
2	ei	256	PRO	CA-CB-CG	-6.32	92.00	104.00
2	eY	256	PRO	CA-CB-CG	-6.32	92.00	104.00
2	ph	256	PRO	CA-CB-CG	-6.32	92.00	104.00
2	ca	256	PRO	CA-CB-CG	-6.31	92.00	104.00
2	ht	256	PRO	CA-CB-CG	-6.31	92.01	104.00
2	kc	256	PRO	CA-CB-CG	-6.31	92.00	104.00
2	nP	256	PRO	CA-CB-CG	-6.31	92.01	104.00
2	bz	256	PRO	CA-CB-CG	-6.31	92.01	104.00
2	eK	256	PRO	CA-CB-CG	-6.31	92.01	104.00
2	lf	256	PRO	CA-CB-CG	-6.30	92.02	104.00
2	lV	256	PRO	CA-CB-CG	-6.30	92.03	104.00
4	qm	212	PRO	CA-N-CD	-5.37	103.98	111.50
4	qj	212	PRO	CA-N-CD	-5.35	104.01	111.50
4	qk	212	PRO	CA-N-CD	-5.34	104.02	111.50
4	qo	212	PRO	CA-N-CD	-5.34	104.03	111.50
4	qn	212	PRO	CA-N-CD	-5.33	104.03	111.50
4	ql	212	PRO	CA-N-CD	-5.33	104.04	111.50

There are no chirality outliers.

There are no planarity outliers.

5.2 Too-close contacts

In the following table, the Non-H and H(model) columns list the number of non-hydrogen atoms and hydrogen atoms in the chain respectively. The H(added) column lists the number of hydrogen atoms added and optimized by MolProbity. The Clashes column lists the number of clashes within the asymmetric unit, whereas Symm-Clashes lists symmetry-related clashes.

Mol	Chain	Non-H	H(model)	H(added)	Clashes	Symm-Clashes
1	aA	433	0	411	0	0
1	aB	433	0	411	0	0
1	aC	433	0	411	0	0

Continued on next page...

Continued from previous page...

Mol	Chain	Non-H	H(model)	H(added)	Clashes	Symm-Clashes
1	aD	433	0	411	0	0
1	aE	433	0	411	0	0
1	aF	433	0	411	0	0
1	aG	433	0	411	0	0
1	aO	433	0	411	0	0
1	aP	433	0	411	0	0
1	aQ	433	0	411	0	0
1	aR	433	0	411	0	0
1	aS	433	0	411	0	0
1	aT	433	0	411	0	0
1	aU	433	0	411	0	0
1	aa	433	0	411	0	0
1	ab	433	0	411	0	0
1	ac	433	0	411	0	0
1	ad	433	0	411	0	0
1	ae	433	0	411	0	0
1	af	433	0	411	0	0
1	an	433	0	411	0	0
1	ao	433	0	411	0	0
1	ap	433	0	411	0	0
1	aq	433	0	411	0	0
1	ar	433	0	411	0	0
1	as	433	0	411	0	0
1	at	433	0	411	0	0
1	bE	433	0	411	0	0
1	bF	433	0	411	0	0
1	bG	433	0	411	0	0
1	bH	433	0	411	0	0
1	bI	433	0	411	0	0
1	bJ	433	0	411	0	0
1	bK	433	0	411	0	0
1	bR	433	0	411	0	0
1	bS	433	0	411	0	0
1	bT	433	0	411	0	0
1	bU	433	0	411	0	0
1	bV	433	0	411	0	0
1	bW	433	0	411	0	0
1	bX	433	0	411	0	0
1	bc	433	0	411	0	0
1	bd	433	0	411	0	0
1	be	433	0	411	0	0
1	bf	433	0	411	0	0

Continued on next page...

Continued from previous page...

Mol	Chain	Non-H	H(model)	H(added)	Clashes	Symm-Clashes
1	bg	433	0	411	0	0
1	bh	433	0	411	0	0
1	bi	433	0	411	0	0
1	bq	433	0	411	0	0
1	br	433	0	411	0	0
1	bs	433	0	411	0	0
1	bt	433	0	411	0	0
1	bu	433	0	411	0	0
1	bv	433	0	411	0	0
1	bw	433	0	411	0	0
1	cH	433	0	411	0	0
1	cI	433	0	411	0	0
1	cJ	433	0	411	0	0
1	cK	433	0	411	0	0
1	cL	433	0	411	0	0
1	cM	433	0	411	0	0
1	cN	433	0	411	0	0
1	cV	433	0	411	0	0
1	cW	433	0	411	0	0
1	cX	433	0	411	0	0
1	cY	433	0	411	0	0
1	cZ	433	0	411	0	0
1	cf	433	0	411	0	0
1	cg	433	0	411	0	0
1	ch	433	0	411	0	0
1	ci	433	0	411	0	0
1	cj	433	0	411	0	0
1	ck	433	0	411	0	0
1	cl	433	0	411	0	0
1	ct	433	0	411	0	0
1	cu	433	0	411	0	0
1	cv	433	0	411	0	0
1	cw	433	0	411	0	0
1	cx	433	0	411	0	0
1	cy	433	0	411	0	0
1	cz	433	0	411	0	0
1	dA	433	0	411	0	0
1	dB	433	0	411	0	0
1	dC	433	0	411	0	0
1	dD	433	0	411	0	0
1	dL	433	0	411	0	0
1	dM	433	0	411	0	0

Continued on next page...

Continued from previous page...

Mol	Chain	Non-H	H(model)	H(added)	Clashes	Symm-Clashes
1	dN	433	0	411	0	0
1	dO	433	0	411	0	0
1	dP	433	0	411	0	0
1	dQ	433	0	411	0	0
1	dR	433	0	411	0	0
1	dZ	433	0	411	0	0
1	da	433	0	411	0	0
1	db	433	0	411	0	0
1	dj	433	0	411	0	0
1	dk	433	0	411	0	0
1	dl	433	0	411	0	0
1	dm	433	0	411	0	0
1	dn	433	0	411	0	0
1	do	433	0	411	0	0
1	dp	433	0	411	0	0
1	dx	433	0	411	0	0
1	dy	433	0	411	0	0
1	dz	433	0	411	0	0
1	eB	433	0	411	0	0
1	eC	433	0	411	0	0
1	eD	433	0	411	0	0
1	eE	433	0	411	0	0
1	eF	433	0	411	0	0
1	eG	433	0	411	0	0
1	eH	433	0	411	0	0
1	eP	433	0	411	0	0
1	eQ	433	0	411	0	0
1	eR	433	0	411	0	0
1	eS	433	0	411	0	0
1	eT	433	0	411	0	0
1	eU	433	0	411	0	0
1	eV	433	0	411	0	0
1	ea	433	0	411	0	0
1	eb	433	0	411	0	0
1	ec	433	0	411	0	0
1	ed	433	0	411	0	0
1	ee	433	0	411	0	0
1	ef	433	0	411	0	0
1	en	433	0	411	0	0
1	eo	433	0	411	0	0
1	ep	433	0	411	0	0
1	eq	433	0	411	0	0

Continued on next page...

Continued from previous page...

Mol	Chain	Non-H	H(model)	H(added)	Clashes	Symm-Clashes
1	er	433	0	411	0	0
1	es	433	0	411	0	0
1	et	433	0	411	0	0
1	fF	433	0	411	0	0
1	fG	433	0	411	0	0
1	fH	433	0	411	0	0
1	fI	433	0	411	0	0
1	fJ	433	0	411	0	0
1	fK	433	0	411	0	0
1	fL	433	0	411	0	0
1	fT	433	0	411	0	0
1	fU	433	0	411	0	0
1	fV	433	0	411	0	0
1	fW	433	0	411	0	0
1	fX	433	0	411	0	0
1	fY	433	0	411	0	0
1	fZ	433	0	411	0	0
1	fd	433	0	411	0	0
1	fe	433	0	411	0	0
1	ff	433	0	411	0	0
1	fg	433	0	411	0	0
1	fh	433	0	411	0	0
1	fi	433	0	411	0	0
1	fj	433	0	411	0	0
1	fr	433	0	411	0	0
1	fs	433	0	411	0	0
1	ft	433	0	411	0	0
1	fu	433	0	411	0	0
1	fv	433	0	411	0	0
1	fw	433	0	411	0	0
1	fx	433	0	411	0	0
1	gA	433	0	411	0	0
1	gB	433	0	411	0	0
1	gJ	433	0	411	0	0
1	gK	433	0	411	0	0
1	gL	433	0	411	0	0
1	gM	433	0	411	0	0
1	gN	433	0	411	0	0
1	gO	433	0	411	0	0
1	gP	433	0	411	0	0
1	gX	433	0	411	0	0
1	gY	433	0	411	0	0

Continued on next page...

Continued from previous page...

Mol	Chain	Non-H	H(model)	H(added)	Clashes	Symm-Clashes
1	gZ	433	0	411	0	0
1	gh	433	0	411	0	0
1	gi	433	0	411	0	0
1	gj	433	0	411	0	0
1	gk	433	0	411	0	0
1	gl	433	0	411	0	0
1	gm	433	0	411	0	0
1	gn	433	0	411	0	0
1	gv	433	0	411	0	0
1	gw	433	0	411	0	0
1	gx	433	0	411	0	0
1	gy	433	0	411	0	0
1	gz	433	0	411	0	0
1	hA	433	0	411	0	0
1	hB	433	0	411	0	0
1	hC	433	0	411	0	0
1	hD	433	0	411	0	0
1	hE	433	0	411	0	0
1	hL	433	0	411	0	0
1	hM	433	0	411	0	0
1	hN	433	0	411	0	0
1	hO	433	0	411	0	0
1	hP	433	0	411	0	0
1	hQ	433	0	411	0	0
1	hR	433	0	411	0	0
1	hZ	433	0	411	0	0
1	ha	433	0	411	0	0
1	hb	433	0	411	0	0
1	hc	433	0	411	0	0
1	hd	433	0	411	0	0
1	hl	433	0	411	0	0
1	hm	433	0	411	0	0
1	hn	433	0	411	0	0
1	ho	433	0	411	0	0
1	hp	433	0	411	0	0
1	hq	433	0	411	0	0
1	hr	433	0	411	0	0
1	hy	433	0	411	0	0
1	hz	433	0	411	0	0
1	iB	433	0	411	0	0
1	iC	433	0	411	0	0
1	iD	433	0	411	0	0

Continued on next page...

Continued from previous page...

Mol	Chain	Non-H	H(model)	H(added)	Clashes	Symm-Clashes
1	iE	433	0	411	0	0
1	iF	433	0	411	0	0
1	iG	433	0	411	0	0
1	iH	433	0	411	0	0
1	iP	433	0	411	0	0
1	iQ	433	0	411	0	0
1	iR	433	0	411	0	0
1	iS	433	0	411	0	0
1	iT	433	0	411	0	0
1	iU	433	0	411	0	0
1	iV	433	0	411	0	0
1	ia	433	0	411	0	0
1	ib	433	0	411	0	0
1	ic	433	0	411	0	0
1	id	433	0	411	0	0
1	ie	433	0	411	0	0
1	if	433	0	411	0	0
1	in	433	0	411	0	0
1	io	433	0	411	0	0
1	ip	433	0	411	0	0
1	iq	433	0	411	0	0
1	ir	433	0	411	0	0
1	is	433	0	411	0	0
1	it	433	0	411	0	0
1	jF	433	0	411	0	0
1	jG	433	0	411	0	0
1	jH	433	0	411	0	0
1	jI	433	0	411	0	0
1	jJ	433	0	411	0	0
1	jK	433	0	411	0	0
1	jL	433	0	411	0	0
1	jT	433	0	411	0	0
1	jU	433	0	411	0	0
1	jV	433	0	411	0	0
1	jW	433	0	411	0	0
1	jX	433	0	411	0	0
1	jY	433	0	411	0	0
1	jZ	433	0	411	0	0
1	jd	433	0	411	0	0
1	je	433	0	411	0	0
1	jf	433	0	411	0	0
1	jg	433	0	411	0	0

Continued on next page...

Continued from previous page...

Mol	Chain	Non-H	H(model)	H(added)	Clashes	Symm-Clashes
1	jh	433	0	411	0	0
1	ji	433	0	411	0	0
1	jj	433	0	411	0	0
1	jr	433	0	411	0	0
1	js	433	0	411	0	0
1	jt	433	0	411	0	0
1	ju	433	0	411	0	0
1	jv	433	0	411	0	0
1	jw	433	0	411	0	0
1	jx	433	0	411	0	0
1	kA	433	0	411	0	0
1	kI	433	0	411	0	0
1	kJ	433	0	411	0	0
1	kK	433	0	411	0	0
1	kL	433	0	411	0	0
1	kM	433	0	411	0	0
1	kN	433	0	411	0	0
1	kO	433	0	411	0	0
1	kW	433	0	411	0	0
1	kX	433	0	411	0	0
1	kY	433	0	411	0	0
1	kZ	433	0	411	0	0
1	kh	433	0	411	0	0
1	ki	433	0	411	0	0
1	kj	433	0	411	0	0
1	kk	433	0	411	0	0
1	kl	433	0	411	0	0
1	km	433	0	411	0	0
1	kn	433	0	411	0	0
1	ku	433	0	411	0	0
1	433	0	411	0	0	
1	kw	433	0	411	0	0
1	kx	433	0	411	0	0
1	ky	433	0	411	0	0
1	kz	433	0	411	0	0
1	lA	433	0	411	0	0
1	lB	433	0	411	0	0
1	lC	433	0	411	0	0
1	lD	433	0	411	0	0
1	lE	433	0	411	0	0
1	lM	433	0	411	0	0
1	lN	433	0	411	0	0

Continued on next page...

Continued from previous page...

Mol	Chain	Non-H	H(model)	H(added)	Clashes	Symm-Clashes
1	lO	433	0	411	0	0
1	lP	433	0	411	0	0
1	lQ	433	0	411	0	0
1	lR	433	0	411	0	0
1	lS	433	0	411	0	0
1	la	433	0	411	0	0
1	lb	433	0	411	0	0
1	lc	433	0	411	0	0
1	lk	433	0	411	0	0
1	ll	433	0	411	0	0
1	lm	433	0	411	0	0
1	ln	433	0	411	0	0
1	lo	433	0	411	0	0
1	lp	433	0	411	0	0
1	lq	433	0	411	0	0
1	ly	433	0	411	0	0
1	lz	433	0	411	0	0
1	mC	433	0	411	0	0
1	mD	433	0	411	0	0
1	mE	433	0	411	0	0
1	mF	433	0	411	0	0
1	mG	433	0	411	0	0
1	mH	433	0	411	0	0
1	mI	433	0	411	0	0
1	mQ	433	0	411	0	0
1	mR	433	0	411	0	0
1	mS	433	0	411	0	0
1	mT	433	0	411	0	0
1	mU	433	0	411	0	0
1	mV	433	0	411	0	0
1	mW	433	0	411	0	0
1	ma	433	0	411	0	0
1	mb	433	0	411	0	0
1	mc	433	0	411	0	0
1	md	433	0	411	0	0
1	me	433	0	411	0	0
1	mf	433	0	411	0	0
1	mg	433	0	411	0	0
1	mo	433	0	411	0	0
1	mp	433	0	411	0	0
1	mq	433	0	411	0	0
1	mr	433	0	411	0	0

Continued on next page...

Continued from previous page...

Mol	Chain	Non-H	H(model)	H(added)	Clashes	Symm-Clashes
1	ms	433	0	411	0	0
1	mt	433	0	411	0	0
1	mu	433	0	411	0	0
1	nG	433	0	411	0	0
1	nH	433	0	411	0	0
1	nI	433	0	411	0	0
1	nJ	433	0	411	0	0
1	nK	433	0	411	0	0
1	nL	433	0	411	0	0
1	nM	433	0	411	0	0
1	nU	433	0	411	0	0
1	nV	433	0	411	0	0
1	nW	433	0	411	0	0
1	nX	433	0	411	0	0
1	nY	433	0	411	0	0
1	nZ	433	0	411	0	0
1	ne	433	0	411	0	0
1	nf	433	0	411	0	0
1	ng	433	0	411	0	0
1	nh	433	0	411	0	0
1	ni	433	0	411	0	0
1	nj	433	0	411	0	0
1	nk	433	0	411	0	0
1	ns	433	0	411	0	0
1	nt	433	0	411	0	0
1	nu	433	0	411	0	0
1	nv	433	0	411	0	0
1	nw	433	0	411	0	0
1	nx	433	0	411	0	0
1	ny	433	0	411	0	0
1	oA	433	0	411	0	0
1	oB	433	0	411	0	0
1	oC	433	0	411	0	0
1	oK	433	0	411	0	0
1	oL	433	0	411	0	0
1	oM	433	0	411	0	0
1	oN	433	0	411	0	0
1	oO	433	0	411	0	0
1	oP	433	0	411	0	0
1	oQ	433	0	411	0	0
1	oY	433	0	411	0	0
1	oZ	433	0	411	0	0

Continued on next page...

Continued from previous page...

Mol	Chain	Non-H	H(model)	H(added)	Clashes	Symm-Clashes
1	oa	433	0	411	0	0
1	oi	433	0	411	0	0
1	oj	433	0	411	0	0
1	ok	433	0	411	0	0
1	ol	433	0	411	0	0
1	om	433	0	411	0	0
1	on	433	0	411	0	0
1	oo	433	0	411	0	0
1	ow	433	0	411	0	0
1	ox	433	0	411	0	0
1	oy	433	0	411	0	0
1	oz	433	0	411	0	0
1	pA	433	0	411	0	0
1	pB	433	0	411	0	0
1	pC	433	0	411	0	0
1	pD	433	0	411	0	0
1	pE	433	0	411	0	0
1	pF	433	0	411	0	0
1	pG	433	0	411	0	0
1	pO	433	0	411	0	0
1	pP	433	0	411	0	0
1	pQ	433	0	411	0	0
1	pR	433	0	411	0	0
1	pS	433	0	411	0	0
1	pT	433	0	411	0	0
1	pU	433	0	411	0	0
1	pa	433	0	411	0	0
1	pb	433	0	411	0	0
1	pc	433	0	411	0	0
1	pd	433	0	411	0	0
1	pe	433	0	411	0	0
1	pm	433	0	411	0	0
1	pn	433	0	411	0	0
1	po	433	0	411	0	0
1	pp	433	0	411	0	0
1	pq	433	0	411	0	0
1	pr	433	0	411	0	0
1	ps	433	0	411	0	0
1	qc	433	0	411	0	0
2	aH	2305	0	2250	0	0
2	aI	2317	0	2257	0	0
2	aJ	2305	0	2250	0	0

Continued on next page...

Continued from previous page...

Mol	Chain	Non-H	H(model)	H(added)	Clashes	Symm-Clashes
2	aK	2305	0	2250	0	0
2	aL	2305	0	2250	0	0
2	aM	2305	0	2250	0	0
2	aN	2305	0	2247	0	0
2	aV	2305	0	2250	0	0
2	aW	2317	0	2257	0	0
2	aX	2305	0	2250	0	0
2	aY	2305	0	2250	0	0
2	aZ	2305	0	2250	0	0
2	ag	2305	0	2250	0	0
2	ah	2317	0	2257	0	0
2	ai	2305	0	2250	0	0
2	aj	2305	0	2250	0	0
2	ak	2305	0	2250	0	0
2	al	2305	0	2250	0	0
2	am	2305	0	2247	0	0
2	au	2305	0	2248	0	0
2	av	2305	0	2250	0	0
2	aw	2305	0	2250	0	0
2	ax	2305	0	2250	0	0
2	ay	2305	0	2250	0	0
2	az	2305	0	2247	0	0
2	bA	2305	0	2250	0	0
2	bB	2305	0	2250	0	0
2	bC	2305	0	2250	0	0
2	bD	2305	0	2247	0	0
2	bL	2305	0	2250	0	0
2	bM	2305	0	2250	0	0
2	bN	2305	0	2250	0	0
2	bO	2305	0	2250	0	0
2	bP	2305	0	2250	0	0
2	bQ	2305	0	2244	0	0
2	bY	2305	0	2250	0	0
2	bZ	2317	0	2257	0	0
2	ba	2305	0	2250	0	0
2	bb	2305	0	2247	0	0
2	bj	2305	0	2250	0	0
2	bk	2317	0	2257	0	0
2	bl	2305	0	2250	0	0
2	bm	2305	0	2250	0	0
2	bn	2305	0	2250	0	0
2	bo	2305	0	2250	0	0

Continued on next page...

Continued from previous page...

Mol	Chain	Non-H	H(model)	H(added)	Clashes	Symm-Clashes
2	bp	2305	0	2247	0	0
2	bx	2305	0	2250	0	0
2	by	2317	0	2257	0	0
2	bz	2305	0	2250	0	0
2	cA	2305	0	2250	0	0
2	cB	2317	0	2257	0	0
2	cC	2305	0	2250	0	0
2	cD	2305	0	2250	0	0
2	cE	2305	0	2250	0	0
2	cF	2305	0	2250	0	0
2	cG	2305	0	2247	0	0
2	cO	2305	0	2250	0	0
2	cP	2317	0	2257	0	0
2	cQ	2305	0	2250	0	0
2	cR	2305	0	2250	0	0
2	cS	2305	0	2250	0	0
2	cT	2305	0	2250	0	0
2	cU	2305	0	2247	0	0
2	ca	2305	0	2250	0	0
2	cb	2305	0	2250	0	0
2	cc	2305	0	2250	0	0
2	cd	2305	0	2250	0	0
2	ce	2305	0	2247	0	0
2	cm	2305	0	2250	0	0
2	cn	2317	0	2257	0	0
2	co	2305	0	2250	0	0
2	cp	2305	0	2250	0	0
2	cq	2305	0	2250	0	0
2	cr	2305	0	2250	0	0
2	cs	2305	0	2247	0	0
2	dE	2305	0	2250	0	0
2	dF	2317	0	2257	0	0
2	dG	2305	0	2250	0	0
2	dH	2305	0	2250	0	0
2	dI	2305	0	2250	0	0
2	dJ	2305	0	2250	0	0
2	dK	2305	0	2247	0	0
2	dS	2305	0	2250	0	0
2	dT	2317	0	2257	0	0
2	dU	2305	0	2250	0	0
2	dV	2305	0	2250	0	0
2	dW	2305	0	2250	0	0

Continued on next page...

Continued from previous page...

Mol	Chain	Non-H	H(model)	H(added)	Clashes	Symm-Clashes
2	dX	2305	0	2250	0	0
2	dY	2305	0	2247	0	0
2	dc	2305	0	2250	0	0
2	dd	2317	0	2257	0	0
2	de	2305	0	2250	0	0
2	df	2305	0	2250	0	0
2	dg	2305	0	2250	0	0
2	dh	2305	0	2250	0	0
2	di	2305	0	2247	0	0
2	dq	2305	0	2250	0	0
2	dr	2317	0	2257	0	0
2	ds	2305	0	2250	0	0
2	dt	2305	0	2250	0	0
2	du	2305	0	2250	0	0
2	dv	2305	0	2250	0	0
2	dw	2305	0	2247	0	0
2	eA	2305	0	2247	0	0
2	eI	2305	0	2250	0	0
2	eJ	2317	0	2257	0	0
2	eK	2305	0	2250	0	0
2	eL	2305	0	2250	0	0
2	eM	2305	0	2250	0	0
2	eN	2305	0	2250	0	0
2	eO	2305	0	2247	0	0
2	eW	2305	0	2250	0	0
2	eX	2317	0	2257	0	0
2	eY	2305	0	2250	0	0
2	eZ	2305	0	2250	0	0
2	eg	2305	0	2250	0	0
2	eh	2317	0	2257	0	0
2	ei	2305	0	2250	0	0
2	ej	2305	0	2250	0	0
2	ek	2305	0	2250	0	0
2	el	2305	0	2250	0	0
2	em	2305	0	2247	0	0
2	eu	2305	0	2250	0	0
2	ev	2317	0	2257	0	0
2	ew	2305	0	2250	0	0
2	ex	2305	0	2250	0	0
2	ey	2305	0	2250	0	0
2	ez	2305	0	2250	0	0
2	fA	2305	0	2250	0	0

Continued on next page...

Continued from previous page...

Mol	Chain	Non-H	H(model)	H(added)	Clashes	Symm-Clashes
2	fB	2305	0	2250	0	0
2	fC	2305	0	2250	0	0
2	fD	2305	0	2250	0	0
2	fE	2305	0	2247	0	0
2	fM	2305	0	2250	0	0
2	fN	2317	0	2257	0	0
2	fO	2305	0	2250	0	0
2	fP	2305	0	2250	0	0
2	fQ	2305	0	2250	0	0
2	fR	2305	0	2250	0	0
2	fS	2305	0	2247	0	0
2	fa	2305	0	2250	0	0
2	fb	2305	0	2250	0	0
2	fc	2305	0	2247	0	0
2	fk	2305	0	2250	0	0
2	fl	2317	0	2257	0	0
2	fm	2305	0	2250	0	0
2	fn	2305	0	2250	0	0
2	fo	2305	0	2250	0	0
2	fp	2305	0	2250	0	0
2	fq	2305	0	2247	0	0
2	fy	2305	0	2250	0	0
2	fz	2317	0	2257	0	0
2	gC	2305	0	2250	0	0
2	gD	2317	0	2257	0	0
2	gE	2305	0	2250	0	0
2	gF	2305	0	2250	0	0
2	gG	2305	0	2250	0	0
2	gH	2305	0	2250	0	0
2	gI	2305	0	2247	0	0
2	gQ	2305	0	2250	0	0
2	gR	2317	0	2257	0	0
2	gS	2305	0	2250	0	0
2	gT	2305	0	2250	0	0
2	gU	2305	0	2250	0	0
2	gV	2305	0	2250	0	0
2	gW	2305	0	2247	0	0
2	ga	2305	0	2250	0	0
2	gb	2317	0	2257	0	0
2	gc	2305	0	2250	0	0
2	gd	2305	0	2250	0	0
2	ge	2305	0	2250	0	0

Continued on next page...

Continued from previous page...

Mol	Chain	Non-H	H(model)	H(added)	Clashes	Symm-Clashes
2	gf	2305	0	2250	0	0
2	gg	2305	0	2247	0	0
2	go	2305	0	2250	0	0
2	gp	2317	0	2257	0	0
2	gq	2305	0	2250	0	0
2	gr	2305	0	2250	0	0
2	gs	2305	0	2250	0	0
2	gt	2305	0	2250	0	0
2	gu	2305	0	2247	0	0
2	hF	2305	0	2250	0	0
2	hG	2305	0	2250	0	0
2	hH	2305	0	2250	0	0
2	hI	2305	0	2250	0	0
2	hJ	2305	0	2250	0	0
2	hK	2305	0	2247	0	0
2	hS	2305	0	2250	0	0
2	hT	2317	0	2257	0	0
2	hU	2305	0	2250	0	0
2	hV	2305	0	2250	0	0
2	hW	2305	0	2250	0	0
2	hX	2305	0	2250	0	0
2	hY	2305	0	2247	0	0
2	he	2305	0	2250	0	0
2	hf	2317	0	2257	0	0
2	hg	2305	0	2250	0	0
2	hh	2305	0	2250	0	0
2	hi	2305	0	2250	0	0
2	hj	2305	0	2250	0	0
2	hk	2305	0	2247	0	0
2	hs	2305	0	2249	0	0
2	ht	2305	0	2250	0	0
2	hu	2305	0	2250	0	0
2	hv	2305	0	2250	0	0
2	hw	2305	0	2250	0	0
2	hx	2305	0	2245	0	0
2	iA	2305	0	2247	0	0
2	iI	2305	0	2250	0	0
2	iJ	2317	0	2257	0	0
2	iK	2305	0	2250	0	0
2	iL	2305	0	2250	0	0
2	iM	2305	0	2250	0	0
2	iN	2305	0	2250	0	0

Continued on next page...

Continued from previous page...

Mol	Chain	Non-H	H(model)	H(added)	Clashes	Symm-Clashes
2	iO	2305	0	2247	0	0
2	iW	2305	0	2250	0	0
2	iX	2317	0	2257	0	0
2	iY	2305	0	2250	0	0
2	iZ	2305	0	2250	0	0
2	ig	2305	0	2250	0	0
2	ih	2317	0	2257	0	0
2	ii	2305	0	2250	0	0
2	ij	2305	0	2250	0	0
2	ik	2305	0	2250	0	0
2	il	2305	0	2250	0	0
2	im	2305	0	2247	0	0
2	iu	2305	0	2250	0	0
2	iv	2317	0	2257	0	0
2	iw	2305	0	2250	0	0
2	ix	2305	0	2250	0	0
2	iy	2305	0	2250	0	0
2	iz	2305	0	2250	0	0
2	jA	2305	0	2250	0	0
2	jB	2305	0	2250	0	0
2	jC	2305	0	2250	0	0
2	jD	2305	0	2250	0	0
2	jE	2305	0	2247	0	0
2	jM	2305	0	2250	0	0
2	jN	2317	0	2257	0	0
2	jO	2305	0	2250	0	0
2	jP	2305	0	2250	0	0
2	jQ	2305	0	2250	0	0
2	jR	2305	0	2250	0	0
2	jS	2305	0	2247	0	0
2	ja	2305	0	2250	0	0
2	jb	2305	0	2250	0	0
2	jc	2305	0	2247	0	0
2	jk	2305	0	2250	0	0
2	jl	2317	0	2257	0	0
2	jm	2305	0	2250	0	0
2	jn	2305	0	2250	0	0
2	jo	2305	0	2250	0	0
2	jp	2305	0	2250	0	0
2	jq	2305	0	2247	0	0
2	jy	2305	0	2250	0	0
2	jz	2317	0	2257	0	0

Continued on next page...

Continued from previous page...

Mol	Chain	Non-H	H(model)	H(added)	Clashes	Symm-Clashes
2	kB	2305	0	2250	0	0
2	kC	2317	0	2257	0	0
2	kD	2305	0	2250	0	0
2	kE	2305	0	2250	0	0
2	kF	2305	0	2250	0	0
2	kG	2305	0	2250	0	0
2	kH	2305	0	2247	0	0
2	kP	2305	0	2250	0	0
2	kQ	2317	0	2257	0	0
2	kR	2305	0	2250	0	0
2	kS	2305	0	2250	0	0
2	kT	2305	0	2250	0	0
2	kU	2305	0	2250	0	0
2	kV	2305	0	2247	0	0
2	ka	2305	0	2250	0	0
2	kb	2317	0	2257	0	0
2	kc	2305	0	2250	0	0
2	kd	2305	0	2250	0	0
2	ke	2305	0	2250	0	0
2	kf	2305	0	2250	0	0
2	kg	2305	0	2247	0	0
2	ko	2305	0	2250	0	0
2	kp	2305	0	2250	0	0
2	kq	2305	0	2250	0	0
2	kr	2305	0	2250	0	0
2	ks	2305	0	2250	0	0
2	kt	2305	0	2245	0	0
2	lF	2305	0	2250	0	0
2	lG	2317	0	2257	0	0
2	lH	2305	0	2250	0	0
2	lI	2305	0	2250	0	0
2	lJ	2305	0	2250	0	0
2	lK	2305	0	2250	0	0
2	lL	2305	0	2247	0	0
2	lT	2305	0	2250	0	0
2	lU	2317	0	2257	0	0
2	lV	2305	0	2250	0	0
2	lW	2305	0	2250	0	0
2	lX	2305	0	2250	0	0
2	lY	2305	0	2250	0	0
2	lZ	2305	0	2247	0	0
2	ld	2305	0	2250	0	0

Continued on next page...

Continued from previous page...

Mol	Chain	Non-H	H(model)	H(added)	Clashes	Symm-Clashes
2	le	2317	0	2257	0	0
2	lf	2305	0	2250	0	0
2	lg	2305	0	2250	0	0
2	lh	2305	0	2250	0	0
2	li	2305	0	2250	0	0
2	lj	2305	0	2247	0	0
2	lr	2305	0	2250	0	0
2	ls	2317	0	2257	0	0
2	lt	2305	0	2250	0	0
2	lu	2305	0	2250	0	0
2	lv	2305	0	2250	0	0
2	lw	2305	0	2250	0	0
2	lx	2305	0	2247	0	0
2	mA	2305	0	2250	0	0
2	mB	2305	0	2247	0	0
2	mJ	2305	0	2250	0	0
2	mK	2317	0	2257	0	0
2	mL	2305	0	2250	0	0
2	mM	2305	0	2250	0	0
2	mN	2305	0	2250	0	0
2	mO	2305	0	2250	0	0
2	mP	2305	0	2247	0	0
2	mX	2305	0	2250	0	0
2	mY	2317	0	2257	0	0
2	mZ	2305	0	2250	0	0
2	mh	2305	0	2250	0	0
2	mi	2317	0	2257	0	0
2	mj	2305	0	2250	0	0
2	mk	2305	0	2250	0	0
2	ml	2305	0	2250	0	0
2	mm	2305	0	2250	0	0
2	mn	2305	0	2247	0	0
2	mv	2305	0	2250	0	0
2	mw	2317	0	2257	0	0
2	mx	2305	0	2250	0	0
2	my	2305	0	2250	0	0
2	mz	2305	0	2250	0	0
2	nA	2317	0	2257	0	0
2	nB	2305	0	2250	0	0
2	nC	2305	0	2250	0	0
2	nD	2305	0	2250	0	0
2	nE	2305	0	2250	0	0

Continued on next page...

Continued from previous page...

Mol	Chain	Non-H	H(model)	H(added)	Clashes	Symm-Clashes
2	nF	2305	0	2247	0	0
2	nN	2305	0	2250	0	0
2	nO	2317	0	2257	0	0
2	nP	2305	0	2250	0	0
2	nQ	2305	0	2250	0	0
2	nR	2305	0	2250	0	0
2	nS	2305	0	2250	0	0
2	nT	2305	0	2247	0	0
2	na	2305	0	2250	0	0
2	nb	2305	0	2250	0	0
2	nc	2305	0	2250	0	0
2	nd	2305	0	2247	0	0
2	nl	2305	0	2250	0	0
2	nm	2317	0	2257	0	0
2	nn	2305	0	2250	0	0
2	no	2305	0	2250	0	0
2	np	2305	0	2250	0	0
2	nq	2305	0	2250	0	0
2	nr	2305	0	2247	0	0
2	nz	2305	0	2250	0	0
2	oD	2305	0	2250	0	0
2	oE	2317	0	2257	0	0
2	oF	2305	0	2250	0	0
2	oG	2305	0	2250	0	0
2	oH	2305	0	2250	0	0
2	oI	2305	0	2250	0	0
2	oJ	2305	0	2247	0	0
2	oR	2305	0	2250	0	0
2	oS	2317	0	2257	0	0
2	oT	2305	0	2250	0	0
2	oU	2305	0	2250	0	0
2	oV	2305	0	2250	0	0
2	oW	2305	0	2250	0	0
2	oX	2305	0	2247	0	0
2	ob	2305	0	2250	0	0
2	oc	2317	0	2257	0	0
2	od	2305	0	2250	0	0
2	oe	2305	0	2250	0	0
2	of	2305	0	2250	0	0
2	og	2305	0	2250	0	0
2	oh	2305	0	2247	0	0
2	op	2305	0	2250	0	0

Continued on next page...

Continued from previous page...

Mol	Chain	Non-H	H(model)	H(added)	Clashes	Symm-Clashes
2	oq	2317	0	2257	0	0
2	or	2305	0	2250	0	0
2	os	2305	0	2250	0	0
2	ot	2305	0	2250	0	0
2	ou	2305	0	2250	0	0
2	ov	2305	0	2247	0	0
2	pH	2305	0	2250	0	0
2	pI	2317	0	2257	0	0
2	pJ	2305	0	2250	0	0
2	pK	2305	0	2250	0	0
2	pL	2305	0	2250	0	0
2	pM	2305	0	2250	0	0
2	pN	2305	0	2247	0	0
2	pV	2305	0	2250	0	0
2	pW	2317	0	2257	0	0
2	pX	2305	0	2250	0	0
2	pY	2305	0	2250	0	0
2	pZ	2305	0	2250	0	0
2	pf	2305	0	2250	0	0
2	pg	2317	0	2257	0	0
2	ph	2305	0	2250	0	0
2	pi	2305	0	2250	0	0
2	pj	2305	0	2250	0	0
2	pk	2305	0	2250	0	0
2	pl	2305	0	2247	0	0
2	pt	2305	0	2250	0	0
2	pu	2317	0	2257	0	0
2	pV	2305	0	2250	0	0
2	pW	2305	0	2250	0	0
2	pX	2305	0	2250	0	0
2	pY	2305	0	2250	0	0
2	pZ	2305	0	2247	0	0
2	qa	2305	0	2250	0	0
2	qb	2305	0	2247	0	0
3	qd	1023	1013	1008	0	0
3	qe	1023	1013	1009	0	0
3	qf	1023	1013	1010	0	0
3	qg	1023	1013	1010	0	0
3	qh	1023	1013	1010	0	0
3	qi	1023	1013	1009	0	0
4	qj	1871	1896	1885	0	0
4	qk	1871	1896	1884	0	0

Continued on next page...

Continued from previous page...

Mol	Chain	Non-H	H(model)	H(added)	Clashes	Symm-Clashes
4	ql	1871	1896	1883	0	0
4	qm	1871	1896	1883	0	0
4	qn	1871	1896	1883	0	0
4	qo	1871	1896	1883	0	0
5	qB	3151	0	3100	0	0
5	qD	3151	0	3094	0	0
5	qF	3151	0	3100	0	0
5	qH	3151	0	3100	0	0
5	qJ	3151	0	3100	0	0
5	qL	3151	0	3097	0	0
5	qp	3151	0	3099	0	0
5	qr	3151	0	3100	0	0
5	qt	3151	0	3099	0	0
5	qv	3151	0	3100	0	0
5	qx	3151	0	3099	0	0
5	qz	3151	0	3100	0	0
6	qA	1056	0	1057	0	0
6	qC	1056	0	1059	0	0
6	qE	1056	0	1057	0	0
6	qG	1056	0	1059	0	0
6	qI	1056	0	1056	0	0
6	qK	1056	0	1059	0	0
6	qM	1056	0	1057	0	0
6	qq	1056	0	1059	0	0
6	qs	1056	0	1057	0	0
6	qu	1056	0	1059	0	0
6	qw	1056	0	1057	0	0
6	qy	1056	0	1059	0	0
All	All	1206943	17454	1173805	0	0

The all-atom clashscore is defined as the number of clashes found per 1000 atoms (including hydrogen atoms). The all-atom clashscore for this structure is 18.

There are no clashes within the asymmetric unit.

There are no symmetry-related clashes.

5.3 Torsion angles [i](#)

5.3.1 Protein backbone [i](#)

In the following table, the Percentiles column shows the percent Ramachandran outliers of the chain as a percentile score with respect to all PDB entries followed by that with respect to all EM

entries.

The Analysed column shows the number of residues for which the backbone conformation was analysed, and the total number of residues.

Mol	Chain	Analysed	Favoured	Allowed	Outliers	Percentiles	
1	aA	54/113 (48%)	44 (82%)	10 (18%)	0	100	100
1	aB	54/113 (48%)	47 (87%)	7 (13%)	0	100	100
1	aC	54/113 (48%)	45 (83%)	9 (17%)	0	100	100
1	aD	54/113 (48%)	46 (85%)	8 (15%)	0	100	100
1	aE	54/113 (48%)	48 (89%)	6 (11%)	0	100	100
1	aF	54/113 (48%)	43 (80%)	11 (20%)	0	100	100
1	aG	54/113 (48%)	46 (85%)	8 (15%)	0	100	100
1	aO	54/113 (48%)	44 (82%)	10 (18%)	0	100	100
1	aP	54/113 (48%)	47 (87%)	7 (13%)	0	100	100
1	aQ	54/113 (48%)	45 (83%)	9 (17%)	0	100	100
1	aR	54/113 (48%)	46 (85%)	8 (15%)	0	100	100
1	aS	54/113 (48%)	48 (89%)	6 (11%)	0	100	100
1	aT	54/113 (48%)	43 (80%)	11 (20%)	0	100	100
1	aU	54/113 (48%)	46 (85%)	8 (15%)	0	100	100
1	aa	54/113 (48%)	47 (87%)	7 (13%)	0	100	100
1	ab	54/113 (48%)	45 (83%)	9 (17%)	0	100	100
1	ac	54/113 (48%)	46 (85%)	8 (15%)	0	100	100
1	ad	54/113 (48%)	48 (89%)	6 (11%)	0	100	100
1	ae	54/113 (48%)	43 (80%)	11 (20%)	0	100	100
1	af	54/113 (48%)	46 (85%)	8 (15%)	0	100	100
1	an	54/113 (48%)	44 (82%)	10 (18%)	0	100	100
1	ao	54/113 (48%)	47 (87%)	7 (13%)	0	100	100
1	ap	54/113 (48%)	45 (83%)	9 (17%)	0	100	100
1	aq	54/113 (48%)	46 (85%)	8 (15%)	0	100	100
1	ar	54/113 (48%)	48 (89%)	6 (11%)	0	100	100
1	as	54/113 (48%)	43 (80%)	11 (20%)	0	100	100
1	at	54/113 (48%)	46 (85%)	8 (15%)	0	100	100
1	bE	54/113 (48%)	44 (82%)	10 (18%)	0	100	100
1	bF	54/113 (48%)	47 (87%)	7 (13%)	0	100	100

Continued on next page...

Continued from previous page...

Mol	Chain	Analysed	Favoured	Allowed	Outliers	Percentiles	
1	bG	54/113 (48%)	45 (83%)	9 (17%)	0	100	100
1	bH	54/113 (48%)	46 (85%)	8 (15%)	0	100	100
1	bI	54/113 (48%)	48 (89%)	6 (11%)	0	100	100
1	bJ	54/113 (48%)	43 (80%)	11 (20%)	0	100	100
1	bK	54/113 (48%)	46 (85%)	8 (15%)	0	100	100
1	bR	54/113 (48%)	44 (82%)	10 (18%)	0	100	100
1	bS	54/113 (48%)	47 (87%)	7 (13%)	0	100	100
1	bT	54/113 (48%)	45 (83%)	9 (17%)	0	100	100
1	bU	54/113 (48%)	46 (85%)	8 (15%)	0	100	100
1	bV	54/113 (48%)	48 (89%)	6 (11%)	0	100	100
1	bW	54/113 (48%)	43 (80%)	11 (20%)	0	100	100
1	bX	54/113 (48%)	46 (85%)	8 (15%)	0	100	100
1	bc	54/113 (48%)	44 (82%)	10 (18%)	0	100	100
1	bd	54/113 (48%)	47 (87%)	7 (13%)	0	100	100
1	be	54/113 (48%)	45 (83%)	9 (17%)	0	100	100
1	bf	54/113 (48%)	46 (85%)	8 (15%)	0	100	100
1	bg	54/113 (48%)	48 (89%)	6 (11%)	0	100	100
1	bh	54/113 (48%)	43 (80%)	11 (20%)	0	100	100
1	bi	54/113 (48%)	46 (85%)	8 (15%)	0	100	100
1	bq	54/113 (48%)	44 (82%)	10 (18%)	0	100	100
1	br	54/113 (48%)	47 (87%)	7 (13%)	0	100	100
1	bs	54/113 (48%)	45 (83%)	9 (17%)	0	100	100
1	bt	54/113 (48%)	46 (85%)	8 (15%)	0	100	100
1	bu	54/113 (48%)	48 (89%)	6 (11%)	0	100	100
1	bv	54/113 (48%)	43 (80%)	11 (20%)	0	100	100
1	bw	54/113 (48%)	46 (85%)	8 (15%)	0	100	100
1	cH	54/113 (48%)	44 (82%)	10 (18%)	0	100	100
1	cI	54/113 (48%)	47 (87%)	7 (13%)	0	100	100
1	cJ	54/113 (48%)	45 (83%)	9 (17%)	0	100	100
1	cK	54/113 (48%)	46 (85%)	8 (15%)	0	100	100
1	cL	54/113 (48%)	48 (89%)	6 (11%)	0	100	100

Continued on next page...

Continued from previous page...

Mol	Chain	Analysed	Favoured	Allowed	Outliers	Percentiles	
1	cM	54/113 (48%)	43 (80%)	11 (20%)	0	100	100
1	cN	54/113 (48%)	46 (85%)	8 (15%)	0	100	100
1	cV	54/113 (48%)	44 (82%)	10 (18%)	0	100	100
1	cW	54/113 (48%)	47 (87%)	7 (13%)	0	100	100
1	cX	54/113 (48%)	45 (83%)	9 (17%)	0	100	100
1	cY	54/113 (48%)	46 (85%)	8 (15%)	0	100	100
1	cZ	54/113 (48%)	48 (89%)	6 (11%)	0	100	100
1	cf	54/113 (48%)	44 (82%)	10 (18%)	0	100	100
1	cg	54/113 (48%)	47 (87%)	7 (13%)	0	100	100
1	ch	54/113 (48%)	45 (83%)	9 (17%)	0	100	100
1	ci	54/113 (48%)	46 (85%)	8 (15%)	0	100	100
1	cj	54/113 (48%)	48 (89%)	6 (11%)	0	100	100
1	ck	54/113 (48%)	43 (80%)	11 (20%)	0	100	100
1	cl	54/113 (48%)	46 (85%)	8 (15%)	0	100	100
1	ct	54/113 (48%)	44 (82%)	10 (18%)	0	100	100
1	cu	54/113 (48%)	47 (87%)	7 (13%)	0	100	100
1	cv	54/113 (48%)	45 (83%)	9 (17%)	0	100	100
1	cw	54/113 (48%)	46 (85%)	8 (15%)	0	100	100
1	cx	54/113 (48%)	48 (89%)	6 (11%)	0	100	100
1	cy	54/113 (48%)	43 (80%)	11 (20%)	0	100	100
1	cz	54/113 (48%)	46 (85%)	8 (15%)	0	100	100
1	dA	54/113 (48%)	46 (85%)	8 (15%)	0	100	100
1	dB	54/113 (48%)	48 (89%)	6 (11%)	0	100	100
1	dC	54/113 (48%)	43 (80%)	11 (20%)	0	100	100
1	dD	54/113 (48%)	46 (85%)	8 (15%)	0	100	100
1	dL	54/113 (48%)	44 (82%)	10 (18%)	0	100	100
1	dM	54/113 (48%)	47 (87%)	7 (13%)	0	100	100
1	dN	54/113 (48%)	45 (83%)	9 (17%)	0	100	100
1	dO	54/113 (48%)	46 (85%)	8 (15%)	0	100	100
1	dP	54/113 (48%)	48 (89%)	6 (11%)	0	100	100
1	dQ	54/113 (48%)	43 (80%)	11 (20%)	0	100	100

Continued on next page...

Continued from previous page...

Mol	Chain	Analysed	Favoured	Allowed	Outliers	Percentiles	
1	dR	54/113 (48%)	46 (85%)	8 (15%)	0	100	100
1	dZ	54/113 (48%)	44 (82%)	10 (18%)	0	100	100
1	da	54/113 (48%)	43 (80%)	11 (20%)	0	100	100
1	db	54/113 (48%)	46 (85%)	8 (15%)	0	100	100
1	dj	54/113 (48%)	44 (82%)	10 (18%)	0	100	100
1	dk	54/113 (48%)	47 (87%)	7 (13%)	0	100	100
1	dl	54/113 (48%)	45 (83%)	9 (17%)	0	100	100
1	dm	54/113 (48%)	46 (85%)	8 (15%)	0	100	100
1	dn	54/113 (48%)	48 (89%)	6 (11%)	0	100	100
1	do	54/113 (48%)	43 (80%)	11 (20%)	0	100	100
1	dp	54/113 (48%)	46 (85%)	8 (15%)	0	100	100
1	dx	54/113 (48%)	44 (82%)	10 (18%)	0	100	100
1	dy	54/113 (48%)	47 (87%)	7 (13%)	0	100	100
1	dz	54/113 (48%)	45 (83%)	9 (17%)	0	100	100
1	eB	54/113 (48%)	44 (82%)	10 (18%)	0	100	100
1	eC	54/113 (48%)	47 (87%)	7 (13%)	0	100	100
1	eD	54/113 (48%)	45 (83%)	9 (17%)	0	100	100
1	eE	54/113 (48%)	46 (85%)	8 (15%)	0	100	100
1	eF	54/113 (48%)	48 (89%)	6 (11%)	0	100	100
1	eG	54/113 (48%)	43 (80%)	11 (20%)	0	100	100
1	eH	54/113 (48%)	46 (85%)	8 (15%)	0	100	100
1	eP	54/113 (48%)	44 (82%)	10 (18%)	0	100	100
1	eQ	54/113 (48%)	47 (87%)	7 (13%)	0	100	100
1	eR	54/113 (48%)	45 (83%)	9 (17%)	0	100	100
1	eS	54/113 (48%)	46 (85%)	8 (15%)	0	100	100
1	eT	54/113 (48%)	48 (89%)	6 (11%)	0	100	100
1	eU	54/113 (48%)	43 (80%)	11 (20%)	0	100	100
1	eV	54/113 (48%)	46 (85%)	8 (15%)	0	100	100
1	ea	54/113 (48%)	47 (87%)	7 (13%)	0	100	100
1	eb	54/113 (48%)	45 (83%)	9 (17%)	0	100	100
1	ec	54/113 (48%)	46 (85%)	8 (15%)	0	100	100

Continued on next page...

Continued from previous page...

Mol	Chain	Analysed	Favoured	Allowed	Outliers	Percentiles	
1	ed	54/113 (48%)	47 (87%)	7 (13%)	0	100	100
1	ee	54/113 (48%)	43 (80%)	11 (20%)	0	100	100
1	ef	54/113 (48%)	46 (85%)	8 (15%)	0	100	100
1	en	54/113 (48%)	44 (82%)	10 (18%)	0	100	100
1	eo	54/113 (48%)	47 (87%)	7 (13%)	0	100	100
1	ep	54/113 (48%)	45 (83%)	9 (17%)	0	100	100
1	eq	54/113 (48%)	46 (85%)	8 (15%)	0	100	100
1	er	54/113 (48%)	48 (89%)	6 (11%)	0	100	100
1	es	54/113 (48%)	43 (80%)	11 (20%)	0	100	100
1	et	54/113 (48%)	46 (85%)	8 (15%)	0	100	100
1	fF	54/113 (48%)	44 (82%)	10 (18%)	0	100	100
1	fG	54/113 (48%)	47 (87%)	7 (13%)	0	100	100
1	fH	54/113 (48%)	45 (83%)	9 (17%)	0	100	100
1	fI	54/113 (48%)	46 (85%)	8 (15%)	0	100	100
1	fJ	54/113 (48%)	48 (89%)	6 (11%)	0	100	100
1	fK	54/113 (48%)	43 (80%)	11 (20%)	0	100	100
1	fL	54/113 (48%)	46 (85%)	8 (15%)	0	100	100
1	fT	54/113 (48%)	44 (82%)	10 (18%)	0	100	100
1	fU	54/113 (48%)	47 (87%)	7 (13%)	0	100	100
1	fV	54/113 (48%)	45 (83%)	9 (17%)	0	100	100
1	fW	54/113 (48%)	46 (85%)	8 (15%)	0	100	100
1	fX	54/113 (48%)	47 (87%)	7 (13%)	0	100	100
1	fY	54/113 (48%)	43 (80%)	11 (20%)	0	100	100
1	fZ	54/113 (48%)	46 (85%)	8 (15%)	0	100	100
1	fd	54/113 (48%)	44 (82%)	10 (18%)	0	100	100
1	fe	54/113 (48%)	47 (87%)	7 (13%)	0	100	100
1	ff	54/113 (48%)	45 (83%)	9 (17%)	0	100	100
1	fg	54/113 (48%)	46 (85%)	8 (15%)	0	100	100
1	fh	54/113 (48%)	48 (89%)	6 (11%)	0	100	100
1	fi	54/113 (48%)	43 (80%)	11 (20%)	0	100	100
1	fj	54/113 (48%)	46 (85%)	8 (15%)	0	100	100

Continued on next page...

Continued from previous page...

Mol	Chain	Analysed	Favoured	Allowed	Outliers	Percentiles	
1	fr	54/113 (48%)	44 (82%)	10 (18%)	0	100	100
1	fs	54/113 (48%)	47 (87%)	7 (13%)	0	100	100
1	ft	54/113 (48%)	45 (83%)	9 (17%)	0	100	100
1	fu	54/113 (48%)	46 (85%)	8 (15%)	0	100	100
1	fv	54/113 (48%)	48 (89%)	6 (11%)	0	100	100
1	fw	54/113 (48%)	43 (80%)	11 (20%)	0	100	100
1	fx	54/113 (48%)	46 (85%)	8 (15%)	0	100	100
1	gA	54/113 (48%)	43 (80%)	11 (20%)	0	100	100
1	gB	54/113 (48%)	46 (85%)	8 (15%)	0	100	100
1	gJ	54/113 (48%)	44 (82%)	10 (18%)	0	100	100
1	gK	54/113 (48%)	47 (87%)	7 (13%)	0	100	100
1	gL	54/113 (48%)	45 (83%)	9 (17%)	0	100	100
1	gM	54/113 (48%)	46 (85%)	8 (15%)	0	100	100
1	gN	54/113 (48%)	48 (89%)	6 (11%)	0	100	100
1	gO	54/113 (48%)	43 (80%)	11 (20%)	0	100	100
1	gP	54/113 (48%)	46 (85%)	8 (15%)	0	100	100
1	gX	54/113 (48%)	44 (82%)	10 (18%)	0	100	100
1	gY	54/113 (48%)	47 (87%)	7 (13%)	0	100	100
1	gZ	54/113 (48%)	45 (83%)	9 (17%)	0	100	100
1	gh	54/113 (48%)	44 (82%)	10 (18%)	0	100	100
1	gi	54/113 (48%)	47 (87%)	7 (13%)	0	100	100
1	gj	54/113 (48%)	45 (83%)	9 (17%)	0	100	100
1	gk	54/113 (48%)	46 (85%)	8 (15%)	0	100	100
1	gl	54/113 (48%)	48 (89%)	6 (11%)	0	100	100
1	gm	54/113 (48%)	43 (80%)	11 (20%)	0	100	100
1	gn	54/113 (48%)	46 (85%)	8 (15%)	0	100	100
1	gv	54/113 (48%)	44 (82%)	10 (18%)	0	100	100
1	gw	54/113 (48%)	47 (87%)	7 (13%)	0	100	100
1	gx	54/113 (48%)	45 (83%)	9 (17%)	0	100	100
1	gy	54/113 (48%)	46 (85%)	8 (15%)	0	100	100
1	gz	54/113 (48%)	48 (89%)	6 (11%)	0	100	100

Continued on next page...

Continued from previous page...

Mol	Chain	Analysed	Favoured	Allowed	Outliers	Percentiles	
1	hA	54/113 (48%)	45 (83%)	9 (17%)	0	100	100
1	hB	54/113 (48%)	46 (85%)	8 (15%)	0	100	100
1	hC	54/113 (48%)	48 (89%)	6 (11%)	0	100	100
1	hD	54/113 (48%)	43 (80%)	11 (20%)	0	100	100
1	hE	54/113 (48%)	46 (85%)	8 (15%)	0	100	100
1	hL	54/113 (48%)	44 (82%)	10 (18%)	0	100	100
1	hM	54/113 (48%)	47 (87%)	7 (13%)	0	100	100
1	hN	54/113 (48%)	45 (83%)	9 (17%)	0	100	100
1	hO	54/113 (48%)	46 (85%)	8 (15%)	0	100	100
1	hP	54/113 (48%)	48 (89%)	6 (11%)	0	100	100
1	hQ	54/113 (48%)	43 (80%)	11 (20%)	0	100	100
1	hR	54/113 (48%)	46 (85%)	8 (15%)	0	100	100
1	hZ	54/113 (48%)	44 (82%)	10 (18%)	0	100	100
1	ha	54/113 (48%)	46 (85%)	8 (15%)	0	100	100
1	hb	54/113 (48%)	48 (89%)	6 (11%)	0	100	100
1	hc	54/113 (48%)	43 (80%)	11 (20%)	0	100	100
1	hd	54/113 (48%)	46 (85%)	8 (15%)	0	100	100
1	hl	54/113 (48%)	44 (82%)	10 (18%)	0	100	100
1	hm	54/113 (48%)	47 (87%)	7 (13%)	0	100	100
1	hn	54/113 (48%)	45 (83%)	9 (17%)	0	100	100
1	ho	54/113 (48%)	46 (85%)	8 (15%)	0	100	100
1	hp	54/113 (48%)	48 (89%)	6 (11%)	0	100	100
1	hq	54/113 (48%)	43 (80%)	11 (20%)	0	100	100
1	hr	54/113 (48%)	46 (85%)	8 (15%)	0	100	100
1	hy	54/113 (48%)	44 (82%)	10 (18%)	0	100	100
1	hz	54/113 (48%)	47 (87%)	7 (13%)	0	100	100
1	iB	54/113 (48%)	44 (82%)	10 (18%)	0	100	100
1	iC	54/113 (48%)	47 (87%)	7 (13%)	0	100	100
1	iD	54/113 (48%)	45 (83%)	9 (17%)	0	100	100
1	iE	54/113 (48%)	46 (85%)	8 (15%)	0	100	100
1	iF	54/113 (48%)	48 (89%)	6 (11%)	0	100	100

Continued on next page...

Continued from previous page...

Mol	Chain	Analysed	Favoured	Allowed	Outliers	Percentiles	
1	iG	54/113 (48%)	43 (80%)	11 (20%)	0	100	100
1	iH	54/113 (48%)	46 (85%)	8 (15%)	0	100	100
1	iP	54/113 (48%)	44 (82%)	10 (18%)	0	100	100
1	iQ	54/113 (48%)	47 (87%)	7 (13%)	0	100	100
1	iR	54/113 (48%)	45 (83%)	9 (17%)	0	100	100
1	iS	54/113 (48%)	46 (85%)	8 (15%)	0	100	100
1	iT	54/113 (48%)	48 (89%)	6 (11%)	0	100	100
1	iU	54/113 (48%)	43 (80%)	11 (20%)	0	100	100
1	iV	54/113 (48%)	46 (85%)	8 (15%)	0	100	100
1	ia	54/113 (48%)	47 (87%)	7 (13%)	0	100	100
1	ib	54/113 (48%)	45 (83%)	9 (17%)	0	100	100
1	ic	54/113 (48%)	46 (85%)	8 (15%)	0	100	100
1	id	54/113 (48%)	48 (89%)	6 (11%)	0	100	100
1	ie	54/113 (48%)	43 (80%)	11 (20%)	0	100	100
1	if	54/113 (48%)	46 (85%)	8 (15%)	0	100	100
1	in	54/113 (48%)	44 (82%)	10 (18%)	0	100	100
1	io	54/113 (48%)	47 (87%)	7 (13%)	0	100	100
1	ip	54/113 (48%)	45 (83%)	9 (17%)	0	100	100
1	iq	54/113 (48%)	46 (85%)	8 (15%)	0	100	100
1	ir	54/113 (48%)	48 (89%)	6 (11%)	0	100	100
1	is	54/113 (48%)	43 (80%)	11 (20%)	0	100	100
1	it	54/113 (48%)	46 (85%)	8 (15%)	0	100	100
1	jF	54/113 (48%)	44 (82%)	10 (18%)	0	100	100
1	jG	54/113 (48%)	47 (87%)	7 (13%)	0	100	100
1	jH	54/113 (48%)	45 (83%)	9 (17%)	0	100	100
1	jI	54/113 (48%)	46 (85%)	8 (15%)	0	100	100
1	jJ	54/113 (48%)	48 (89%)	6 (11%)	0	100	100
1	jK	54/113 (48%)	43 (80%)	11 (20%)	0	100	100
1	jL	54/113 (48%)	46 (85%)	8 (15%)	0	100	100
1	jT	54/113 (48%)	44 (82%)	10 (18%)	0	100	100
1	jU	54/113 (48%)	47 (87%)	7 (13%)	0	100	100

Continued on next page...

Continued from previous page...

Mol	Chain	Analysed	Favoured	Allowed	Outliers	Percentiles	
1	jV	54/113 (48%)	45 (83%)	9 (17%)	0	100	100
1	jW	54/113 (48%)	46 (85%)	8 (15%)	0	100	100
1	jX	54/113 (48%)	48 (89%)	6 (11%)	0	100	100
1	jY	54/113 (48%)	43 (80%)	11 (20%)	0	100	100
1	jZ	54/113 (48%)	46 (85%)	8 (15%)	0	100	100
1	jd	54/113 (48%)	44 (82%)	10 (18%)	0	100	100
1	je	54/113 (48%)	47 (87%)	7 (13%)	0	100	100
1	jf	54/113 (48%)	45 (83%)	9 (17%)	0	100	100
1	jj	54/113 (48%)	46 (85%)	8 (15%)	0	100	100
1	jj	54/113 (48%)	46 (85%)	8 (15%)	0	100	100
1	jr	54/113 (48%)	44 (82%)	10 (18%)	0	100	100
1	js	54/113 (48%)	47 (87%)	7 (13%)	0	100	100
1	jt	54/113 (48%)	45 (83%)	9 (17%)	0	100	100
1	ju	54/113 (48%)	46 (85%)	8 (15%)	0	100	100
1	jv	54/113 (48%)	48 (89%)	6 (11%)	0	100	100
1	jw	54/113 (48%)	43 (80%)	11 (20%)	0	100	100
1	jx	54/113 (48%)	46 (85%)	8 (15%)	0	100	100
1	kA	54/113 (48%)	46 (85%)	8 (15%)	0	100	100
1	kI	54/113 (48%)	44 (82%)	10 (18%)	0	100	100
1	kJ	54/113 (48%)	47 (87%)	7 (13%)	0	100	100
1	kK	54/113 (48%)	45 (83%)	9 (17%)	0	100	100
1	kL	54/113 (48%)	46 (85%)	8 (15%)	0	100	100
1	kM	54/113 (48%)	48 (89%)	6 (11%)	0	100	100
1	kN	54/113 (48%)	43 (80%)	11 (20%)	0	100	100
1	kO	54/113 (48%)	46 (85%)	8 (15%)	0	100	100
1	kW	54/113 (48%)	44 (82%)	10 (18%)	0	100	100
1	kX	54/113 (48%)	47 (87%)	7 (13%)	0	100	100
1	kY	54/113 (48%)	45 (83%)	9 (17%)	0	100	100
1	kZ	54/113 (48%)	46 (85%)	8 (15%)	0	100	100

Continued on next page...

Continued from previous page...

Mol	Chain	Analysed	Favoured	Allowed	Outliers	Percentiles	
1	kh	54/113 (48%)	44 (82%)	10 (18%)	0	100	100
1	ki	54/113 (48%)	47 (87%)	7 (13%)	0	100	100
1	kj	54/113 (48%)	45 (83%)	9 (17%)	0	100	100
1	kk	54/113 (48%)	46 (85%)	8 (15%)	0	100	100
1	kl	54/113 (48%)	48 (89%)	6 (11%)	0	100	100
1	km	54/113 (48%)	43 (80%)	11 (20%)	0	100	100
1	kn	54/113 (48%)	46 (85%)	8 (15%)	0	100	100
1	ku	54/113 (48%)	44 (82%)	10 (18%)	0	100	100
1	54/113 (48%)	47 (87%)	7 (13%)	0	100	100	
1	kw	54/113 (48%)	45 (83%)	9 (17%)	0	100	100
1	kx	54/113 (48%)	46 (85%)	8 (15%)	0	100	100
1	ky	54/113 (48%)	48 (89%)	6 (11%)	0	100	100
1	kz	54/113 (48%)	43 (80%)	11 (20%)	0	100	100
1	lA	54/113 (48%)	45 (83%)	9 (17%)	0	100	100
1	lB	54/113 (48%)	46 (85%)	8 (15%)	0	100	100
1	lC	54/113 (48%)	48 (89%)	6 (11%)	0	100	100
1	lD	54/113 (48%)	43 (80%)	11 (20%)	0	100	100
1	lE	54/113 (48%)	46 (85%)	8 (15%)	0	100	100
1	lM	54/113 (48%)	44 (82%)	10 (18%)	0	100	100
1	lN	54/113 (48%)	47 (87%)	7 (13%)	0	100	100
1	lO	54/113 (48%)	45 (83%)	9 (17%)	0	100	100
1	lP	54/113 (48%)	46 (85%)	8 (15%)	0	100	100
1	lQ	54/113 (48%)	48 (89%)	6 (11%)	0	100	100
1	lR	54/113 (48%)	43 (80%)	11 (20%)	0	100	100
1	lS	54/113 (48%)	46 (85%)	8 (15%)	0	100	100
1	la	54/113 (48%)	48 (89%)	6 (11%)	0	100	100
1	lb	54/113 (48%)	43 (80%)	11 (20%)	0	100	100
1	lc	54/113 (48%)	46 (85%)	8 (15%)	0	100	100
1	lk	54/113 (48%)	44 (82%)	10 (18%)	0	100	100
1	ll	54/113 (48%)	47 (87%)	7 (13%)	0	100	100
1	lm	54/113 (48%)	45 (83%)	9 (17%)	0	100	100

Continued on next page...

Continued from previous page...

Mol	Chain	Analysed	Favoured	Allowed	Outliers	Percentiles	
1	ln	54/113 (48%)	46 (85%)	8 (15%)	0	100	100
1	lo	54/113 (48%)	48 (89%)	6 (11%)	0	100	100
1	lp	54/113 (48%)	43 (80%)	11 (20%)	0	100	100
1	lq	54/113 (48%)	46 (85%)	8 (15%)	0	100	100
1	ly	54/113 (48%)	44 (82%)	10 (18%)	0	100	100
1	lz	54/113 (48%)	47 (87%)	7 (13%)	0	100	100
1	mC	54/113 (48%)	44 (82%)	10 (18%)	0	100	100
1	mD	54/113 (48%)	47 (87%)	7 (13%)	0	100	100
1	mE	54/113 (48%)	45 (83%)	9 (17%)	0	100	100
1	mF	54/113 (48%)	46 (85%)	8 (15%)	0	100	100
1	mG	54/113 (48%)	48 (89%)	6 (11%)	0	100	100
1	mH	54/113 (48%)	43 (80%)	11 (20%)	0	100	100
1	mI	54/113 (48%)	47 (87%)	7 (13%)	0	100	100
1	mQ	54/113 (48%)	44 (82%)	10 (18%)	0	100	100
1	mR	54/113 (48%)	47 (87%)	7 (13%)	0	100	100
1	mS	54/113 (48%)	45 (83%)	9 (17%)	0	100	100
1	mT	54/113 (48%)	46 (85%)	8 (15%)	0	100	100
1	mU	54/113 (48%)	48 (89%)	6 (11%)	0	100	100
1	mV	54/113 (48%)	43 (80%)	11 (20%)	0	100	100
1	mW	54/113 (48%)	46 (85%)	8 (15%)	0	100	100
1	ma	54/113 (48%)	44 (82%)	10 (18%)	0	100	100
1	mb	54/113 (48%)	47 (87%)	7 (13%)	0	100	100
1	mc	54/113 (48%)	45 (83%)	9 (17%)	0	100	100
1	md	54/113 (48%)	46 (85%)	8 (15%)	0	100	100
1	me	54/113 (48%)	48 (89%)	6 (11%)	0	100	100
1	mf	54/113 (48%)	43 (80%)	11 (20%)	0	100	100
1	mg	54/113 (48%)	46 (85%)	8 (15%)	0	100	100
1	mo	54/113 (48%)	44 (82%)	10 (18%)	0	100	100
1	mp	54/113 (48%)	47 (87%)	7 (13%)	0	100	100
1	mq	54/113 (48%)	45 (83%)	9 (17%)	0	100	100
1	mr	54/113 (48%)	46 (85%)	8 (15%)	0	100	100

Continued on next page...

Continued from previous page...

Mol	Chain	Analysed	Favoured	Allowed	Outliers	Percentiles	
1	ms	54/113 (48%)	48 (89%)	6 (11%)	0	100	100
1	mt	54/113 (48%)	43 (80%)	11 (20%)	0	100	100
1	mu	54/113 (48%)	46 (85%)	8 (15%)	0	100	100
1	nG	54/113 (48%)	44 (82%)	10 (18%)	0	100	100
1	nH	54/113 (48%)	47 (87%)	7 (13%)	0	100	100
1	nI	54/113 (48%)	45 (83%)	9 (17%)	0	100	100
1	nJ	54/113 (48%)	46 (85%)	8 (15%)	0	100	100
1	nK	54/113 (48%)	48 (89%)	6 (11%)	0	100	100
1	nL	54/113 (48%)	43 (80%)	11 (20%)	0	100	100
1	nM	54/113 (48%)	46 (85%)	8 (15%)	0	100	100
1	nU	54/113 (48%)	44 (82%)	10 (18%)	0	100	100
1	nV	54/113 (48%)	47 (87%)	7 (13%)	0	100	100
1	nW	54/113 (48%)	45 (83%)	9 (17%)	0	100	100
1	nX	54/113 (48%)	46 (85%)	8 (15%)	0	100	100
1	nY	54/113 (48%)	48 (89%)	6 (11%)	0	100	100
1	nZ	54/113 (48%)	43 (80%)	11 (20%)	0	100	100
1	ne	54/113 (48%)	44 (82%)	10 (18%)	0	100	100
1	nf	54/113 (48%)	47 (87%)	7 (13%)	0	100	100
1	ng	54/113 (48%)	45 (83%)	9 (17%)	0	100	100
1	nh	54/113 (48%)	46 (85%)	8 (15%)	0	100	100
1	ni	54/113 (48%)	48 (89%)	6 (11%)	0	100	100
1	nj	54/113 (48%)	43 (80%)	11 (20%)	0	100	100
1	nk	54/113 (48%)	47 (87%)	7 (13%)	0	100	100
1	ns	54/113 (48%)	44 (82%)	10 (18%)	0	100	100
1	nt	54/113 (48%)	47 (87%)	7 (13%)	0	100	100
1	nu	54/113 (48%)	45 (83%)	9 (17%)	0	100	100
1	nv	54/113 (48%)	46 (85%)	8 (15%)	0	100	100
1	nw	54/113 (48%)	48 (89%)	6 (11%)	0	100	100
1	nx	54/113 (48%)	43 (80%)	11 (20%)	0	100	100
1	ny	54/113 (48%)	47 (87%)	7 (13%)	0	100	100
1	oA	54/113 (48%)	48 (89%)	6 (11%)	0	100	100

Continued on next page...

Continued from previous page...

Mol	Chain	Analysed	Favoured	Allowed	Outliers	Percentiles	
1	oB	54/113 (48%)	43 (80%)	11 (20%)	0	100	100
1	oC	54/113 (48%)	46 (85%)	8 (15%)	0	100	100
1	oK	54/113 (48%)	44 (82%)	10 (18%)	0	100	100
1	oL	54/113 (48%)	47 (87%)	7 (13%)	0	100	100
1	oM	54/113 (48%)	45 (83%)	9 (17%)	0	100	100
1	oN	54/113 (48%)	46 (85%)	8 (15%)	0	100	100
1	oO	54/113 (48%)	48 (89%)	6 (11%)	0	100	100
1	oP	54/113 (48%)	43 (80%)	11 (20%)	0	100	100
1	oQ	54/113 (48%)	46 (85%)	8 (15%)	0	100	100
1	oY	54/113 (48%)	44 (82%)	10 (18%)	0	100	100
1	oZ	54/113 (48%)	47 (87%)	7 (13%)	0	100	100
1	oa	54/113 (48%)	46 (85%)	8 (15%)	0	100	100
1	oi	54/113 (48%)	44 (82%)	10 (18%)	0	100	100
1	oj	54/113 (48%)	47 (87%)	7 (13%)	0	100	100
1	ok	54/113 (48%)	45 (83%)	9 (17%)	0	100	100
1	ol	54/113 (48%)	46 (85%)	8 (15%)	0	100	100
1	om	54/113 (48%)	48 (89%)	6 (11%)	0	100	100
1	on	54/113 (48%)	43 (80%)	11 (20%)	0	100	100
1	oo	54/113 (48%)	46 (85%)	8 (15%)	0	100	100
1	ow	54/113 (48%)	44 (82%)	10 (18%)	0	100	100
1	ox	54/113 (48%)	47 (87%)	7 (13%)	0	100	100
1	oy	54/113 (48%)	45 (83%)	9 (17%)	0	100	100
1	oz	54/113 (48%)	46 (85%)	8 (15%)	0	100	100
1	pA	54/113 (48%)	44 (82%)	10 (18%)	0	100	100
1	pB	54/113 (48%)	47 (87%)	7 (13%)	0	100	100
1	pC	54/113 (48%)	45 (83%)	9 (17%)	0	100	100
1	pD	54/113 (48%)	46 (85%)	8 (15%)	0	100	100
1	pE	54/113 (48%)	48 (89%)	6 (11%)	0	100	100
1	pF	54/113 (48%)	43 (80%)	11 (20%)	0	100	100
1	pG	54/113 (48%)	46 (85%)	8 (15%)	0	100	100
1	pO	54/113 (48%)	44 (82%)	10 (18%)	0	100	100

Continued on next page...

Continued from previous page...

Mol	Chain	Analysed	Favoured	Allowed	Outliers	Percentiles	
1	pP	54/113 (48%)	47 (87%)	7 (13%)	0	100	100
1	pQ	54/113 (48%)	45 (83%)	9 (17%)	0	100	100
1	pR	54/113 (48%)	46 (85%)	8 (15%)	0	100	100
1	pS	54/113 (48%)	48 (89%)	6 (11%)	0	100	100
1	pT	54/113 (48%)	43 (80%)	11 (20%)	0	100	100
1	pU	54/113 (48%)	46 (85%)	8 (15%)	0	100	100
1	pa	54/113 (48%)	45 (83%)	9 (17%)	0	100	100
1	pb	54/113 (48%)	46 (85%)	8 (15%)	0	100	100
1	pc	54/113 (48%)	47 (87%)	7 (13%)	0	100	100
1	pd	54/113 (48%)	43 (80%)	11 (20%)	0	100	100
1	pe	54/113 (48%)	46 (85%)	8 (15%)	0	100	100
1	pm	54/113 (48%)	44 (82%)	10 (18%)	0	100	100
1	pn	54/113 (48%)	47 (87%)	7 (13%)	0	100	100
1	po	54/113 (48%)	45 (83%)	9 (17%)	0	100	100
1	pp	54/113 (48%)	46 (85%)	8 (15%)	0	100	100
1	pq	54/113 (48%)	48 (89%)	6 (11%)	0	100	100
1	pr	54/113 (48%)	43 (80%)	11 (20%)	0	100	100
1	ps	54/113 (48%)	46 (85%)	8 (15%)	0	100	100
1	qc	54/113 (48%)	44 (82%)	10 (18%)	0	100	100
2	aH	291/304 (96%)	260 (89%)	30 (10%)	1 (0%)	37	73
2	aI	293/304 (96%)	260 (89%)	33 (11%)	0	100	100
2	aJ	291/304 (96%)	264 (91%)	27 (9%)	0	100	100
2	aK	291/304 (96%)	265 (91%)	26 (9%)	0	100	100
2	aL	291/304 (96%)	270 (93%)	21 (7%)	0	100	100
2	aM	291/304 (96%)	261 (90%)	30 (10%)	0	100	100
2	aN	291/304 (96%)	267 (92%)	24 (8%)	0	100	100
2	aV	291/304 (96%)	260 (89%)	30 (10%)	1 (0%)	37	73
2	aW	293/304 (96%)	261 (89%)	32 (11%)	0	100	100
2	aX	291/304 (96%)	264 (91%)	27 (9%)	0	100	100
2	aY	291/304 (96%)	265 (91%)	26 (9%)	0	100	100
2	aZ	291/304 (96%)	269 (92%)	22 (8%)	0	100	100

Continued on next page...

Continued from previous page...

Mol	Chain	Analysed	Favoured	Allowed	Outliers	Percentiles	
2	ag	291/304 (96%)	260 (89%)	30 (10%)	1 (0%)	37	73
2	ah	293/304 (96%)	260 (89%)	33 (11%)	0	100	100
2	ai	291/304 (96%)	264 (91%)	27 (9%)	0	100	100
2	aj	291/304 (96%)	264 (91%)	27 (9%)	0	100	100
2	ak	291/304 (96%)	270 (93%)	21 (7%)	0	100	100
2	al	291/304 (96%)	261 (90%)	30 (10%)	0	100	100
2	am	291/304 (96%)	268 (92%)	23 (8%)	0	100	100
2	au	291/304 (96%)	260 (89%)	30 (10%)	1 (0%)	37	73
2	av	291/304 (96%)	264 (91%)	27 (9%)	0	100	100
2	aw	291/304 (96%)	265 (91%)	26 (9%)	0	100	100
2	ax	291/304 (96%)	270 (93%)	21 (7%)	0	100	100
2	ay	291/304 (96%)	261 (90%)	30 (10%)	0	100	100
2	az	291/304 (96%)	268 (92%)	23 (8%)	0	100	100
2	bA	291/304 (96%)	264 (91%)	27 (9%)	0	100	100
2	bB	291/304 (96%)	270 (93%)	21 (7%)	0	100	100
2	bC	291/304 (96%)	261 (90%)	30 (10%)	0	100	100
2	bD	291/304 (96%)	268 (92%)	23 (8%)	0	100	100
2	bL	291/304 (96%)	260 (89%)	30 (10%)	1 (0%)	37	73
2	bM	291/304 (96%)	264 (91%)	27 (9%)	0	100	100
2	bN	291/304 (96%)	264 (91%)	27 (9%)	0	100	100
2	bO	291/304 (96%)	270 (93%)	21 (7%)	0	100	100
2	bP	291/304 (96%)	261 (90%)	30 (10%)	0	100	100
2	bQ	291/304 (96%)	268 (92%)	23 (8%)	0	100	100
2	bY	291/304 (96%)	260 (89%)	30 (10%)	1 (0%)	37	73
2	bZ	293/304 (96%)	260 (89%)	33 (11%)	0	100	100
2	ba	291/304 (96%)	261 (90%)	30 (10%)	0	100	100
2	bb	291/304 (96%)	268 (92%)	23 (8%)	0	100	100
2	bj	291/304 (96%)	260 (89%)	30 (10%)	1 (0%)	37	73
2	bk	293/304 (96%)	260 (89%)	33 (11%)	0	100	100
2	bl	291/304 (96%)	264 (91%)	27 (9%)	0	100	100
2	bm	291/304 (96%)	264 (91%)	27 (9%)	0	100	100

Continued on next page...

Continued from previous page...

Mol	Chain	Analysed	Favoured	Allowed	Outliers	Percentiles	
2	bn	291/304 (96%)	270 (93%)	21 (7%)	0	100	100
2	bo	291/304 (96%)	261 (90%)	30 (10%)	0	100	100
2	bp	291/304 (96%)	268 (92%)	23 (8%)	0	100	100
2	bx	291/304 (96%)	260 (89%)	30 (10%)	1 (0%)	37	73
2	by	293/304 (96%)	260 (89%)	33 (11%)	0	100	100
2	bz	291/304 (96%)	264 (91%)	27 (9%)	0	100	100
2	cA	291/304 (96%)	260 (89%)	30 (10%)	1 (0%)	37	73
2	cB	293/304 (96%)	260 (89%)	33 (11%)	0	100	100
2	cC	291/304 (96%)	264 (91%)	27 (9%)	0	100	100
2	cD	291/304 (96%)	265 (91%)	26 (9%)	0	100	100
2	cE	291/304 (96%)	269 (92%)	22 (8%)	0	100	100
2	cF	291/304 (96%)	261 (90%)	30 (10%)	0	100	100
2	cG	291/304 (96%)	268 (92%)	23 (8%)	0	100	100
2	cO	291/304 (96%)	260 (89%)	30 (10%)	1 (0%)	37	73
2	cP	293/304 (96%)	260 (89%)	33 (11%)	0	100	100
2	cQ	291/304 (96%)	264 (91%)	27 (9%)	0	100	100
2	cR	291/304 (96%)	264 (91%)	27 (9%)	0	100	100
2	cS	291/304 (96%)	270 (93%)	21 (7%)	0	100	100
2	cT	291/304 (96%)	261 (90%)	30 (10%)	0	100	100
2	cU	291/304 (96%)	268 (92%)	23 (8%)	0	100	100
2	ca	291/304 (96%)	264 (91%)	27 (9%)	0	100	100
2	cb	291/304 (96%)	265 (91%)	26 (9%)	0	100	100
2	cc	291/304 (96%)	270 (93%)	21 (7%)	0	100	100
2	cd	291/304 (96%)	261 (90%)	30 (10%)	0	100	100
2	ce	291/304 (96%)	268 (92%)	23 (8%)	0	100	100
2	cm	291/304 (96%)	260 (89%)	30 (10%)	1 (0%)	37	73
2	cn	293/304 (96%)	260 (89%)	33 (11%)	0	100	100
2	co	291/304 (96%)	264 (91%)	27 (9%)	0	100	100
2	cp	291/304 (96%)	264 (91%)	27 (9%)	0	100	100
2	cq	291/304 (96%)	270 (93%)	21 (7%)	0	100	100
2	cr	291/304 (96%)	261 (90%)	30 (10%)	0	100	100

Continued on next page...

Continued from previous page...

Mol	Chain	Analysed	Favoured	Allowed	Outliers	Percentiles	
2	cs	291/304 (96%)	268 (92%)	23 (8%)	0	100	100
2	dE	291/304 (96%)	260 (89%)	30 (10%)	1 (0%)	37	73
2	dF	293/304 (96%)	260 (89%)	33 (11%)	0	100	100
2	dG	291/304 (96%)	264 (91%)	27 (9%)	0	100	100
2	dH	291/304 (96%)	264 (91%)	27 (9%)	0	100	100
2	dI	291/304 (96%)	269 (92%)	22 (8%)	0	100	100
2	dJ	291/304 (96%)	261 (90%)	30 (10%)	0	100	100
2	dK	291/304 (96%)	268 (92%)	23 (8%)	0	100	100
2	dS	291/304 (96%)	260 (89%)	30 (10%)	1 (0%)	37	73
2	dT	293/304 (96%)	260 (89%)	33 (11%)	0	100	100
2	dU	291/304 (96%)	264 (91%)	27 (9%)	0	100	100
2	dV	291/304 (96%)	264 (91%)	27 (9%)	0	100	100
2	dW	291/304 (96%)	270 (93%)	21 (7%)	0	100	100
2	dX	291/304 (96%)	261 (90%)	30 (10%)	0	100	100
2	dY	291/304 (96%)	268 (92%)	23 (8%)	0	100	100
2	dc	291/304 (96%)	260 (89%)	30 (10%)	1 (0%)	37	73
2	dd	293/304 (96%)	260 (89%)	33 (11%)	0	100	100
2	de	291/304 (96%)	264 (91%)	27 (9%)	0	100	100
2	df	291/304 (96%)	264 (91%)	27 (9%)	0	100	100
2	dg	291/304 (96%)	269 (92%)	22 (8%)	0	100	100
2	dh	291/304 (96%)	261 (90%)	30 (10%)	0	100	100
2	di	291/304 (96%)	268 (92%)	23 (8%)	0	100	100
2	dq	291/304 (96%)	260 (89%)	30 (10%)	1 (0%)	37	73
2	dr	293/304 (96%)	260 (89%)	33 (11%)	0	100	100
2	ds	291/304 (96%)	264 (91%)	27 (9%)	0	100	100
2	dt	291/304 (96%)	265 (91%)	26 (9%)	0	100	100
2	du	291/304 (96%)	270 (93%)	21 (7%)	0	100	100
2	dv	291/304 (96%)	261 (90%)	30 (10%)	0	100	100
2	dw	291/304 (96%)	268 (92%)	23 (8%)	0	100	100
2	eA	291/304 (96%)	268 (92%)	23 (8%)	0	100	100
2	eI	291/304 (96%)	260 (89%)	30 (10%)	1 (0%)	37	73

Continued on next page...

Continued from previous page...

Mol	Chain	Analysed	Favoured	Allowed	Outliers	Percentiles	
2	eJ	293/304 (96%)	260 (89%)	33 (11%)	0	100	100
2	eK	291/304 (96%)	264 (91%)	27 (9%)	0	100	100
2	eL	291/304 (96%)	264 (91%)	27 (9%)	0	100	100
2	eM	291/304 (96%)	269 (92%)	22 (8%)	0	100	100
2	eN	291/304 (96%)	261 (90%)	30 (10%)	0	100	100
2	eO	291/304 (96%)	267 (92%)	24 (8%)	0	100	100
2	eW	291/304 (96%)	260 (89%)	30 (10%)	1 (0%)	37	73
2	eX	293/304 (96%)	260 (89%)	33 (11%)	0	100	100
2	eY	291/304 (96%)	264 (91%)	27 (9%)	0	100	100
2	eZ	291/304 (96%)	264 (91%)	27 (9%)	0	100	100
2	eg	291/304 (96%)	260 (89%)	30 (10%)	1 (0%)	37	73
2	eh	293/304 (96%)	260 (89%)	33 (11%)	0	100	100
2	ei	291/304 (96%)	264 (91%)	27 (9%)	0	100	100
2	ej	291/304 (96%)	264 (91%)	27 (9%)	0	100	100
2	ek	291/304 (96%)	270 (93%)	21 (7%)	0	100	100
2	el	291/304 (96%)	261 (90%)	30 (10%)	0	100	100
2	em	291/304 (96%)	268 (92%)	23 (8%)	0	100	100
2	eu	291/304 (96%)	260 (89%)	30 (10%)	1 (0%)	37	73
2	ev	293/304 (96%)	260 (89%)	33 (11%)	0	100	100
2	ew	291/304 (96%)	264 (91%)	27 (9%)	0	100	100
2	ex	291/304 (96%)	264 (91%)	27 (9%)	0	100	100
2	ey	291/304 (96%)	269 (92%)	22 (8%)	0	100	100
2	ez	291/304 (96%)	261 (90%)	30 (10%)	0	100	100
2	fA	291/304 (96%)	264 (91%)	27 (9%)	0	100	100
2	fB	291/304 (96%)	264 (91%)	27 (9%)	0	100	100
2	fC	291/304 (96%)	270 (93%)	21 (7%)	0	100	100
2	fD	291/304 (96%)	261 (90%)	30 (10%)	0	100	100
2	fE	291/304 (96%)	267 (92%)	24 (8%)	0	100	100
2	fM	291/304 (96%)	260 (89%)	30 (10%)	1 (0%)	37	73
2	fN	293/304 (96%)	260 (89%)	33 (11%)	0	100	100
2	fO	291/304 (96%)	264 (91%)	27 (9%)	0	100	100

Continued on next page...

Continued from previous page...

Mol	Chain	Analysed	Favoured	Allowed	Outliers	Percentiles	
2	fP	291/304 (96%)	265 (91%)	26 (9%)	0	100	100
2	fQ	291/304 (96%)	270 (93%)	21 (7%)	0	100	100
2	fR	291/304 (96%)	261 (90%)	30 (10%)	0	100	100
2	fS	291/304 (96%)	267 (92%)	24 (8%)	0	100	100
2	fa	291/304 (96%)	270 (93%)	21 (7%)	0	100	100
2	fb	291/304 (96%)	261 (90%)	30 (10%)	0	100	100
2	fc	291/304 (96%)	268 (92%)	23 (8%)	0	100	100
2	fk	291/304 (96%)	260 (89%)	30 (10%)	1 (0%)	37	73
2	fl	293/304 (96%)	260 (89%)	33 (11%)	0	100	100
2	fm	291/304 (96%)	264 (91%)	27 (9%)	0	100	100
2	fn	291/304 (96%)	264 (91%)	27 (9%)	0	100	100
2	fo	291/304 (96%)	270 (93%)	21 (7%)	0	100	100
2	fp	291/304 (96%)	261 (90%)	30 (10%)	0	100	100
2	fq	291/304 (96%)	267 (92%)	24 (8%)	0	100	100
2	fy	291/304 (96%)	260 (89%)	30 (10%)	1 (0%)	37	73
2	fz	293/304 (96%)	260 (89%)	33 (11%)	0	100	100
2	gC	291/304 (96%)	260 (89%)	30 (10%)	1 (0%)	37	73
2	gD	293/304 (96%)	260 (89%)	33 (11%)	0	100	100
2	gE	291/304 (96%)	264 (91%)	27 (9%)	0	100	100
2	gF	291/304 (96%)	265 (91%)	26 (9%)	0	100	100
2	gG	291/304 (96%)	270 (93%)	21 (7%)	0	100	100
2	gH	291/304 (96%)	261 (90%)	30 (10%)	0	100	100
2	gI	291/304 (96%)	268 (92%)	23 (8%)	0	100	100
2	gQ	291/304 (96%)	260 (89%)	30 (10%)	1 (0%)	37	73
2	gR	293/304 (96%)	260 (89%)	33 (11%)	0	100	100
2	gS	291/304 (96%)	264 (91%)	27 (9%)	0	100	100
2	gT	291/304 (96%)	265 (91%)	26 (9%)	0	100	100
2	gU	291/304 (96%)	270 (93%)	21 (7%)	0	100	100
2	gV	291/304 (96%)	261 (90%)	30 (10%)	0	100	100
2	gW	291/304 (96%)	268 (92%)	23 (8%)	0	100	100
2	ga	291/304 (96%)	260 (89%)	30 (10%)	1 (0%)	37	73

Continued on next page...

Continued from previous page...

Mol	Chain	Analysed	Favoured	Allowed	Outliers	Percentiles	
2	gb	293/304 (96%)	260 (89%)	33 (11%)	0	100	100
2	gc	291/304 (96%)	264 (91%)	27 (9%)	0	100	100
2	gd	291/304 (96%)	264 (91%)	27 (9%)	0	100	100
2	ge	291/304 (96%)	270 (93%)	21 (7%)	0	100	100
2	gf	291/304 (96%)	261 (90%)	30 (10%)	0	100	100
2	gg	291/304 (96%)	268 (92%)	23 (8%)	0	100	100
2	go	291/304 (96%)	260 (89%)	30 (10%)	1 (0%)	37	73
2	gp	293/304 (96%)	260 (89%)	33 (11%)	0	100	100
2	gq	291/304 (96%)	264 (91%)	27 (9%)	0	100	100
2	gr	291/304 (96%)	264 (91%)	27 (9%)	0	100	100
2	gs	291/304 (96%)	270 (93%)	21 (7%)	0	100	100
2	gt	291/304 (96%)	261 (90%)	30 (10%)	0	100	100
2	gu	291/304 (96%)	268 (92%)	23 (8%)	0	100	100
2	hF	291/304 (96%)	260 (89%)	30 (10%)	1 (0%)	37	73
2	hG	291/304 (96%)	264 (91%)	27 (9%)	0	100	100
2	hH	291/304 (96%)	264 (91%)	27 (9%)	0	100	100
2	hI	291/304 (96%)	270 (93%)	21 (7%)	0	100	100
2	hJ	291/304 (96%)	261 (90%)	30 (10%)	0	100	100
2	hK	291/304 (96%)	268 (92%)	23 (8%)	0	100	100
2	hS	291/304 (96%)	260 (89%)	30 (10%)	1 (0%)	37	73
2	hT	293/304 (96%)	260 (89%)	33 (11%)	0	100	100
2	hU	291/304 (96%)	264 (91%)	27 (9%)	0	100	100
2	hV	291/304 (96%)	264 (91%)	27 (9%)	0	100	100
2	hW	291/304 (96%)	269 (92%)	22 (8%)	0	100	100
2	hX	291/304 (96%)	261 (90%)	30 (10%)	0	100	100
2	hY	291/304 (96%)	268 (92%)	23 (8%)	0	100	100
2	he	291/304 (96%)	260 (89%)	30 (10%)	1 (0%)	37	73
2	hf	293/304 (96%)	260 (89%)	33 (11%)	0	100	100
2	hg	291/304 (96%)	264 (91%)	27 (9%)	0	100	100
2	hh	291/304 (96%)	264 (91%)	27 (9%)	0	100	100
2	hi	291/304 (96%)	270 (93%)	21 (7%)	0	100	100

Continued on next page...

Continued from previous page...

Mol	Chain	Analysed	Favoured	Allowed	Outliers	Percentiles	
2	hj	291/304 (96%)	261 (90%)	30 (10%)	0	100	100
2	hk	291/304 (96%)	267 (92%)	24 (8%)	0	100	100
2	hs	291/304 (96%)	260 (89%)	30 (10%)	1 (0%)	37	73
2	ht	291/304 (96%)	264 (91%)	27 (9%)	0	100	100
2	hu	291/304 (96%)	264 (91%)	27 (9%)	0	100	100
2	hv	291/304 (96%)	269 (92%)	22 (8%)	0	100	100
2	hw	291/304 (96%)	261 (90%)	30 (10%)	0	100	100
2	hx	291/304 (96%)	267 (92%)	24 (8%)	0	100	100
2	iA	291/304 (96%)	268 (92%)	23 (8%)	0	100	100
2	iI	291/304 (96%)	260 (89%)	30 (10%)	1 (0%)	37	73
2	iJ	293/304 (96%)	260 (89%)	33 (11%)	0	100	100
2	iK	291/304 (96%)	264 (91%)	27 (9%)	0	100	100
2	iL	291/304 (96%)	264 (91%)	27 (9%)	0	100	100
2	iM	291/304 (96%)	270 (93%)	21 (7%)	0	100	100
2	iN	291/304 (96%)	261 (90%)	30 (10%)	0	100	100
2	iO	291/304 (96%)	268 (92%)	23 (8%)	0	100	100
2	iW	291/304 (96%)	260 (89%)	30 (10%)	1 (0%)	37	73
2	iX	293/304 (96%)	260 (89%)	33 (11%)	0	100	100
2	iY	291/304 (96%)	264 (91%)	27 (9%)	0	100	100
2	iZ	291/304 (96%)	264 (91%)	27 (9%)	0	100	100
2	ig	291/304 (96%)	260 (89%)	30 (10%)	1 (0%)	37	73
2	ih	293/304 (96%)	260 (89%)	33 (11%)	0	100	100
2	ii	291/304 (96%)	264 (91%)	27 (9%)	0	100	100
2	ij	291/304 (96%)	264 (91%)	27 (9%)	0	100	100
2	ik	291/304 (96%)	270 (93%)	21 (7%)	0	100	100
2	il	291/304 (96%)	261 (90%)	30 (10%)	0	100	100
2	im	291/304 (96%)	267 (92%)	24 (8%)	0	100	100
2	iu	291/304 (96%)	260 (89%)	30 (10%)	1 (0%)	37	73
2	iv	293/304 (96%)	260 (89%)	33 (11%)	0	100	100
2	iw	291/304 (96%)	264 (91%)	27 (9%)	0	100	100
2	ix	291/304 (96%)	265 (91%)	26 (9%)	0	100	100

Continued on next page...

Continued from previous page...

Mol	Chain	Analysed	Favoured	Allowed	Outliers	Percentiles	
2	iy	291/304 (96%)	270 (93%)	21 (7%)	0	100	100
2	iz	291/304 (96%)	261 (90%)	30 (10%)	0	100	100
2	jA	291/304 (96%)	264 (91%)	27 (9%)	0	100	100
2	jB	291/304 (96%)	264 (91%)	27 (9%)	0	100	100
2	jC	291/304 (96%)	270 (93%)	21 (7%)	0	100	100
2	jD	291/304 (96%)	261 (90%)	30 (10%)	0	100	100
2	jE	291/304 (96%)	267 (92%)	24 (8%)	0	100	100
2	jM	291/304 (96%)	260 (89%)	30 (10%)	1 (0%)	37	73
2	jN	293/304 (96%)	260 (89%)	33 (11%)	0	100	100
2	jO	291/304 (96%)	264 (91%)	27 (9%)	0	100	100
2	jP	291/304 (96%)	265 (91%)	26 (9%)	0	100	100
2	jQ	291/304 (96%)	269 (92%)	22 (8%)	0	100	100
2	jR	291/304 (96%)	261 (90%)	30 (10%)	0	100	100
2	jS	291/304 (96%)	268 (92%)	23 (8%)	0	100	100
2	ja	291/304 (96%)	269 (92%)	22 (8%)	0	100	100
2	jb	291/304 (96%)	261 (90%)	30 (10%)	0	100	100
2	jc	291/304 (96%)	267 (92%)	24 (8%)	0	100	100
2	jk	291/304 (96%)	260 (89%)	30 (10%)	1 (0%)	37	73
2	jl	293/304 (96%)	259 (88%)	34 (12%)	0	100	100
2	jm	291/304 (96%)	264 (91%)	27 (9%)	0	100	100
2	jn	291/304 (96%)	264 (91%)	27 (9%)	0	100	100
2	jo	291/304 (96%)	270 (93%)	21 (7%)	0	100	100
2	jp	291/304 (96%)	261 (90%)	30 (10%)	0	100	100
2	jq	291/304 (96%)	268 (92%)	23 (8%)	0	100	100
2	jy	291/304 (96%)	260 (89%)	30 (10%)	1 (0%)	37	73
2	jz	293/304 (96%)	260 (89%)	33 (11%)	0	100	100
2	kB	291/304 (96%)	260 (89%)	30 (10%)	1 (0%)	37	73
2	kC	293/304 (96%)	260 (89%)	33 (11%)	0	100	100
2	kD	291/304 (96%)	264 (91%)	27 (9%)	0	100	100
2	kE	291/304 (96%)	264 (91%)	27 (9%)	0	100	100
2	kF	291/304 (96%)	269 (92%)	22 (8%)	0	100	100

Continued on next page...

Continued from previous page...

Mol	Chain	Analysed	Favoured	Allowed	Outliers	Percentiles	
2	kG	291/304 (96%)	261 (90%)	30 (10%)	0	100	100
2	kH	291/304 (96%)	267 (92%)	24 (8%)	0	100	100
2	kP	291/304 (96%)	260 (89%)	30 (10%)	1 (0%)	37	73
2	kQ	293/304 (96%)	260 (89%)	33 (11%)	0	100	100
2	kR	291/304 (96%)	264 (91%)	27 (9%)	0	100	100
2	kS	291/304 (96%)	264 (91%)	27 (9%)	0	100	100
2	kT	291/304 (96%)	269 (92%)	22 (8%)	0	100	100
2	kU	291/304 (96%)	261 (90%)	30 (10%)	0	100	100
2	kV	291/304 (96%)	268 (92%)	23 (8%)	0	100	100
2	ka	291/304 (96%)	260 (89%)	30 (10%)	1 (0%)	37	73
2	kb	293/304 (96%)	260 (89%)	33 (11%)	0	100	100
2	kc	291/304 (96%)	264 (91%)	27 (9%)	0	100	100
2	kd	291/304 (96%)	264 (91%)	27 (9%)	0	100	100
2	ke	291/304 (96%)	269 (92%)	22 (8%)	0	100	100
2	kf	291/304 (96%)	261 (90%)	30 (10%)	0	100	100
2	kg	291/304 (96%)	268 (92%)	23 (8%)	0	100	100
2	ko	291/304 (96%)	260 (89%)	30 (10%)	1 (0%)	37	73
2	kp	291/304 (96%)	264 (91%)	27 (9%)	0	100	100
2	kq	291/304 (96%)	264 (91%)	27 (9%)	0	100	100
2	kr	291/304 (96%)	269 (92%)	22 (8%)	0	100	100
2	ks	291/304 (96%)	261 (90%)	30 (10%)	0	100	100
2	kt	291/304 (96%)	267 (92%)	24 (8%)	0	100	100
2	lF	291/304 (96%)	260 (89%)	30 (10%)	1 (0%)	37	73
2	lG	293/304 (96%)	260 (89%)	33 (11%)	0	100	100
2	lH	291/304 (96%)	264 (91%)	27 (9%)	0	100	100
2	lI	291/304 (96%)	264 (91%)	27 (9%)	0	100	100
2	lJ	291/304 (96%)	270 (93%)	21 (7%)	0	100	100
2	lK	291/304 (96%)	261 (90%)	30 (10%)	0	100	100
2	lL	291/304 (96%)	268 (92%)	23 (8%)	0	100	100
2	lT	291/304 (96%)	260 (89%)	30 (10%)	1 (0%)	37	73
2	lU	293/304 (96%)	260 (89%)	33 (11%)	0	100	100

Continued on next page...

Continued from previous page...

Mol	Chain	Analysed	Favoured	Allowed	Outliers	Percentiles	
2	IV	291/304 (96%)	264 (91%)	27 (9%)	0	100	100
2	IW	291/304 (96%)	264 (91%)	27 (9%)	0	100	100
2	IX	291/304 (96%)	270 (93%)	21 (7%)	0	100	100
2	IY	291/304 (96%)	261 (90%)	30 (10%)	0	100	100
2	IZ	291/304 (96%)	268 (92%)	23 (8%)	0	100	100
2	ld	291/304 (96%)	260 (89%)	30 (10%)	1 (0%)	37	73
2	le	293/304 (96%)	260 (89%)	33 (11%)	0	100	100
2	lf	291/304 (96%)	264 (91%)	27 (9%)	0	100	100
2	lg	291/304 (96%)	265 (91%)	26 (9%)	0	100	100
2	lh	291/304 (96%)	270 (93%)	21 (7%)	0	100	100
2	li	291/304 (96%)	261 (90%)	30 (10%)	0	100	100
2	lj	291/304 (96%)	267 (92%)	24 (8%)	0	100	100
2	lr	291/304 (96%)	260 (89%)	30 (10%)	1 (0%)	37	73
2	ls	293/304 (96%)	260 (89%)	33 (11%)	0	100	100
2	lt	291/304 (96%)	264 (91%)	27 (9%)	0	100	100
2	lu	291/304 (96%)	265 (91%)	26 (9%)	0	100	100
2	lv	291/304 (96%)	269 (92%)	22 (8%)	0	100	100
2	lw	291/304 (96%)	261 (90%)	30 (10%)	0	100	100
2	lx	291/304 (96%)	268 (92%)	23 (8%)	0	100	100
2	mA	291/304 (96%)	261 (90%)	30 (10%)	0	100	100
2	mB	291/304 (96%)	267 (92%)	24 (8%)	0	100	100
2	mJ	291/304 (96%)	260 (89%)	30 (10%)	1 (0%)	37	73
2	mK	293/304 (96%)	260 (89%)	33 (11%)	0	100	100
2	mL	291/304 (96%)	264 (91%)	27 (9%)	0	100	100
2	mM	291/304 (96%)	265 (91%)	26 (9%)	0	100	100
2	mN	291/304 (96%)	269 (92%)	22 (8%)	0	100	100
2	mO	291/304 (96%)	261 (90%)	30 (10%)	0	100	100
2	mP	291/304 (96%)	268 (92%)	23 (8%)	0	100	100
2	mX	291/304 (96%)	260 (89%)	30 (10%)	1 (0%)	37	73
2	mY	293/304 (96%)	260 (89%)	33 (11%)	0	100	100
2	mZ	291/304 (96%)	264 (91%)	27 (9%)	0	100	100

Continued on next page...

Continued from previous page...

Mol	Chain	Analysed	Favoured	Allowed	Outliers	Percentiles	
2	mh	291/304 (96%)	260 (89%)	30 (10%)	1 (0%)	37	73
2	mi	293/304 (96%)	260 (89%)	33 (11%)	0	100	100
2	mj	291/304 (96%)	264 (91%)	27 (9%)	0	100	100
2	mk	291/304 (96%)	264 (91%)	27 (9%)	0	100	100
2	ml	291/304 (96%)	270 (93%)	21 (7%)	0	100	100
2	mm	291/304 (96%)	261 (90%)	30 (10%)	0	100	100
2	mn	291/304 (96%)	268 (92%)	23 (8%)	0	100	100
2	mv	291/304 (96%)	260 (89%)	30 (10%)	1 (0%)	37	73
2	mw	293/304 (96%)	260 (89%)	33 (11%)	0	100	100
2	mx	291/304 (96%)	264 (91%)	27 (9%)	0	100	100
2	my	291/304 (96%)	265 (91%)	26 (9%)	0	100	100
2	mz	291/304 (96%)	269 (92%)	22 (8%)	0	100	100
2	nA	293/304 (96%)	260 (89%)	33 (11%)	0	100	100
2	nB	291/304 (96%)	264 (91%)	27 (9%)	0	100	100
2	nC	291/304 (96%)	264 (91%)	27 (9%)	0	100	100
2	nD	291/304 (96%)	270 (93%)	21 (7%)	0	100	100
2	nE	291/304 (96%)	261 (90%)	30 (10%)	0	100	100
2	nF	291/304 (96%)	267 (92%)	24 (8%)	0	100	100
2	nN	291/304 (96%)	260 (89%)	30 (10%)	1 (0%)	37	73
2	nO	293/304 (96%)	260 (89%)	33 (11%)	0	100	100
2	nP	291/304 (96%)	264 (91%)	27 (9%)	0	100	100
2	nQ	291/304 (96%)	264 (91%)	27 (9%)	0	100	100
2	nR	291/304 (96%)	270 (93%)	21 (7%)	0	100	100
2	nS	291/304 (96%)	261 (90%)	30 (10%)	0	100	100
2	nT	291/304 (96%)	267 (92%)	24 (8%)	0	100	100
2	na	291/304 (96%)	264 (91%)	27 (9%)	0	100	100
2	nb	291/304 (96%)	270 (93%)	21 (7%)	0	100	100
2	nc	291/304 (96%)	261 (90%)	30 (10%)	0	100	100
2	nd	291/304 (96%)	267 (92%)	24 (8%)	0	100	100
2	nl	291/304 (96%)	260 (89%)	30 (10%)	1 (0%)	37	73
2	nm	293/304 (96%)	260 (89%)	33 (11%)	0	100	100

Continued on next page...

Continued from previous page...

Mol	Chain	Analysed	Favoured	Allowed	Outliers	Percentiles	
2	nn	291/304 (96%)	264 (91%)	27 (9%)	0	100	100
2	no	291/304 (96%)	264 (91%)	27 (9%)	0	100	100
2	np	291/304 (96%)	270 (93%)	21 (7%)	0	100	100
2	nq	291/304 (96%)	261 (90%)	30 (10%)	0	100	100
2	nr	291/304 (96%)	268 (92%)	23 (8%)	0	100	100
2	nz	291/304 (96%)	260 (89%)	30 (10%)	1 (0%)	37	73
2	oD	291/304 (96%)	260 (89%)	30 (10%)	1 (0%)	37	73
2	oE	293/304 (96%)	260 (89%)	33 (11%)	0	100	100
2	oF	291/304 (96%)	264 (91%)	27 (9%)	0	100	100
2	oG	291/304 (96%)	264 (91%)	27 (9%)	0	100	100
2	oH	291/304 (96%)	270 (93%)	21 (7%)	0	100	100
2	oI	291/304 (96%)	261 (90%)	30 (10%)	0	100	100
2	oJ	291/304 (96%)	268 (92%)	23 (8%)	0	100	100
2	oR	291/304 (96%)	260 (89%)	30 (10%)	1 (0%)	37	73
2	oS	293/304 (96%)	260 (89%)	33 (11%)	0	100	100
2	oT	291/304 (96%)	264 (91%)	27 (9%)	0	100	100
2	oU	291/304 (96%)	264 (91%)	27 (9%)	0	100	100
2	oV	291/304 (96%)	269 (92%)	22 (8%)	0	100	100
2	oW	291/304 (96%)	261 (90%)	30 (10%)	0	100	100
2	oX	291/304 (96%)	267 (92%)	24 (8%)	0	100	100
2	ob	291/304 (96%)	260 (89%)	30 (10%)	1 (0%)	37	73
2	oc	293/304 (96%)	260 (89%)	33 (11%)	0	100	100
2	od	291/304 (96%)	264 (91%)	27 (9%)	0	100	100
2	oe	291/304 (96%)	265 (91%)	26 (9%)	0	100	100
2	of	291/304 (96%)	270 (93%)	21 (7%)	0	100	100
2	og	291/304 (96%)	261 (90%)	30 (10%)	0	100	100
2	oh	291/304 (96%)	268 (92%)	23 (8%)	0	100	100
2	op	291/304 (96%)	260 (89%)	30 (10%)	1 (0%)	37	73
2	oq	293/304 (96%)	260 (89%)	33 (11%)	0	100	100
2	or	291/304 (96%)	264 (91%)	27 (9%)	0	100	100
2	os	291/304 (96%)	265 (91%)	26 (9%)	0	100	100

Continued on next page...

Continued from previous page...

Mol	Chain	Analysed	Favoured	Allowed	Outliers	Percentiles	
2	ot	291/304 (96%)	270 (93%)	21 (7%)	0	100	100
2	ou	291/304 (96%)	261 (90%)	30 (10%)	0	100	100
2	ov	291/304 (96%)	268 (92%)	23 (8%)	0	100	100
2	pH	291/304 (96%)	260 (89%)	30 (10%)	1 (0%)	37	73
2	pI	293/304 (96%)	260 (89%)	33 (11%)	0	100	100
2	pJ	291/304 (96%)	264 (91%)	27 (9%)	0	100	100
2	pK	291/304 (96%)	265 (91%)	26 (9%)	0	100	100
2	pL	291/304 (96%)	270 (93%)	21 (7%)	0	100	100
2	pM	291/304 (96%)	261 (90%)	30 (10%)	0	100	100
2	pN	291/304 (96%)	267 (92%)	24 (8%)	0	100	100
2	pV	291/304 (96%)	260 (89%)	30 (10%)	1 (0%)	37	73
2	pW	293/304 (96%)	260 (89%)	33 (11%)	0	100	100
2	pX	291/304 (96%)	264 (91%)	27 (9%)	0	100	100
2	pY	291/304 (96%)	264 (91%)	27 (9%)	0	100	100
2	pZ	291/304 (96%)	270 (93%)	21 (7%)	0	100	100
2	pf	291/304 (96%)	260 (89%)	30 (10%)	1 (0%)	37	73
2	pg	293/304 (96%)	260 (89%)	33 (11%)	0	100	100
2	ph	291/304 (96%)	264 (91%)	27 (9%)	0	100	100
2	pi	291/304 (96%)	265 (91%)	26 (9%)	0	100	100
2	pj	291/304 (96%)	269 (92%)	22 (8%)	0	100	100
2	pk	291/304 (96%)	261 (90%)	30 (10%)	0	100	100
2	pl	291/304 (96%)	268 (92%)	23 (8%)	0	100	100
2	pt	291/304 (96%)	260 (89%)	30 (10%)	1 (0%)	37	73
2	pu	293/304 (96%)	260 (89%)	33 (11%)	0	100	100
2	pV	291/304 (96%)	264 (91%)	27 (9%)	0	100	100
2	pW	291/304 (96%)	265 (91%)	26 (9%)	0	100	100
2	pX	291/304 (96%)	270 (93%)	21 (7%)	0	100	100
2	pY	291/304 (96%)	261 (90%)	30 (10%)	0	100	100
2	pZ	291/304 (96%)	268 (92%)	23 (8%)	0	100	100
2	qa	291/304 (96%)	261 (90%)	30 (10%)	0	100	100
2	qb	291/304 (96%)	268 (92%)	23 (8%)	0	100	100

Continued on next page...

Continued from previous page...

Mol	Chain	Analysed	Favoured	Allowed	Outliers	Percentiles	
3	qd	132/157 (84%)	115 (87%)	17 (13%)	0	100	100
3	qe	132/157 (84%)	115 (87%)	17 (13%)	0	100	100
3	qf	132/157 (84%)	115 (87%)	17 (13%)	0	100	100
3	qg	132/157 (84%)	115 (87%)	17 (13%)	0	100	100
3	qh	132/157 (84%)	115 (87%)	17 (13%)	0	100	100
3	qi	132/157 (84%)	115 (87%)	17 (13%)	0	100	100
4	qj	250/256 (98%)	242 (97%)	8 (3%)	0	100	100
4	qk	250/256 (98%)	242 (97%)	8 (3%)	0	100	100
4	ql	250/256 (98%)	242 (97%)	8 (3%)	0	100	100
4	qm	250/256 (98%)	242 (97%)	8 (3%)	0	100	100
4	qn	250/256 (98%)	242 (97%)	8 (3%)	0	100	100
4	qo	250/256 (98%)	242 (97%)	8 (3%)	0	100	100
5	qB	403/526 (77%)	389 (96%)	14 (4%)	0	100	100
5	qD	403/526 (77%)	389 (96%)	14 (4%)	0	100	100
5	qF	403/526 (77%)	389 (96%)	14 (4%)	0	100	100
5	qH	403/526 (77%)	389 (96%)	14 (4%)	0	100	100
5	qJ	403/526 (77%)	389 (96%)	14 (4%)	0	100	100
5	qL	403/526 (77%)	389 (96%)	14 (4%)	0	100	100
5	qP	403/526 (77%)	389 (96%)	14 (4%)	0	100	100
5	qR	403/526 (77%)	389 (96%)	14 (4%)	0	100	100
5	qT	403/526 (77%)	389 (96%)	14 (4%)	0	100	100
5	qV	403/526 (77%)	389 (96%)	14 (4%)	0	100	100
5	qX	403/526 (77%)	389 (96%)	14 (4%)	0	100	100
5	qZ	403/526 (77%)	389 (96%)	14 (4%)	0	100	100
6	qA	135/138 (98%)	124 (92%)	10 (7%)	1 (1%)	19	57
6	qC	135/138 (98%)	124 (92%)	10 (7%)	1 (1%)	19	57
6	qE	135/138 (98%)	124 (92%)	10 (7%)	1 (1%)	19	57
6	qG	135/138 (98%)	124 (92%)	10 (7%)	1 (1%)	19	57
6	qI	135/138 (98%)	124 (92%)	10 (7%)	1 (1%)	19	57
6	qK	135/138 (98%)	124 (92%)	10 (7%)	1 (1%)	19	57
6	qM	135/138 (98%)	124 (92%)	10 (7%)	1 (1%)	19	57

Continued on next page...

Continued from previous page...

Mol	Chain	Analysed	Favoured	Allowed	Outliers	Percentiles	
6	qq	135/138 (98%)	124 (92%)	10 (7%)	1 (1%)	19	57
6	qs	135/138 (98%)	124 (92%)	10 (7%)	1 (1%)	19	57
6	qu	135/138 (98%)	124 (92%)	10 (7%)	1 (1%)	19	57
6	qw	135/138 (98%)	124 (92%)	10 (7%)	1 (1%)	19	57
6	qy	135/138 (98%)	124 (92%)	10 (7%)	1 (1%)	19	57
All	All	152303/184066 (83%)	136940 (90%)	15291 (10%)	72 (0%)	100	100

All (72) Ramachandran outliers are listed below:

Mol	Chain	Res	Type
2	ag	190	PRO
2	au	190	PRO
2	aH	190	PRO
2	aV	190	PRO
2	bj	190	PRO
2	bx	190	PRO
2	bL	190	PRO
2	bY	190	PRO
2	cm	190	PRO
2	cA	190	PRO
2	cO	190	PRO
2	dc	190	PRO
2	dq	190	PRO
2	dE	190	PRO
2	dS	190	PRO
2	eg	190	PRO
2	eu	190	PRO
2	eI	190	PRO
2	eW	190	PRO
2	fk	190	PRO
2	fy	190	PRO
2	fM	190	PRO
2	ga	190	PRO
2	go	190	PRO
2	gC	190	PRO
2	gQ	190	PRO
2	he	190	PRO
2	hs	190	PRO
2	hF	190	PRO
2	hS	190	PRO

Continued on next page...

Continued from previous page...

Mol	Chain	Res	Type
2	ig	190	PRO
2	iu	190	PRO
2	iI	190	PRO
2	iW	190	PRO
2	jk	190	PRO
2	jy	190	PRO
2	jM	190	PRO
2	ka	190	PRO
2	ko	190	PRO
2	kB	190	PRO
2	kP	190	PRO
2	ld	190	PRO
2	lr	190	PRO
2	lF	190	PRO
2	lT	190	PRO
2	mh	190	PRO
2	mv	190	PRO
2	mJ	190	PRO
2	mX	190	PRO
2	nl	190	PRO
2	nz	190	PRO
2	nN	190	PRO
2	ob	190	PRO
2	op	190	PRO
2	oD	190	PRO
2	oR	190	PRO
2	pf	190	PRO
2	pt	190	PRO
2	pH	190	PRO
2	pV	190	PRO
6	qq	129	GLU
6	qs	129	GLU
6	qu	129	GLU
6	qw	129	GLU
6	qy	129	GLU
6	qA	129	GLU
6	qC	129	GLU
6	qE	129	GLU
6	qG	129	GLU
6	qI	129	GLU
6	qK	129	GLU
6	qM	129	GLU

5.3.2 Protein sidechains [i](#)

In the following table, the Percentiles column shows the percent sidechain outliers of the chain as a percentile score with respect to all PDB entries followed by that with respect to all EM entries.

The Analysed column shows the number of residues for which the sidechain conformation was analysed, and the total number of residues.

Mol	Chain	Analysed	Rotameric	Outliers	Percentiles	
1	aA	46/93 (50%)	45 (98%)	1 (2%)	47	65
1	aB	46/93 (50%)	46 (100%)	0	100	100
1	aC	46/93 (50%)	46 (100%)	0	100	100
1	aD	46/93 (50%)	46 (100%)	0	100	100
1	aE	46/93 (50%)	46 (100%)	0	100	100
1	aF	46/93 (50%)	46 (100%)	0	100	100
1	aG	46/93 (50%)	45 (98%)	1 (2%)	47	65
1	aO	46/93 (50%)	45 (98%)	1 (2%)	47	65
1	aP	46/93 (50%)	46 (100%)	0	100	100
1	aQ	46/93 (50%)	46 (100%)	0	100	100
1	aR	46/93 (50%)	46 (100%)	0	100	100
1	aS	46/93 (50%)	46 (100%)	0	100	100
1	aT	46/93 (50%)	46 (100%)	0	100	100
1	aU	46/93 (50%)	45 (98%)	1 (2%)	47	65
1	aa	46/93 (50%)	46 (100%)	0	100	100
1	ab	46/93 (50%)	46 (100%)	0	100	100
1	ac	46/93 (50%)	46 (100%)	0	100	100
1	ad	46/93 (50%)	46 (100%)	0	100	100
1	ae	46/93 (50%)	46 (100%)	0	100	100
1	af	46/93 (50%)	45 (98%)	1 (2%)	47	65
1	an	46/93 (50%)	45 (98%)	1 (2%)	47	65
1	ao	46/93 (50%)	46 (100%)	0	100	100
1	ap	46/93 (50%)	46 (100%)	0	100	100
1	aq	46/93 (50%)	46 (100%)	0	100	100
1	ar	46/93 (50%)	46 (100%)	0	100	100
1	as	46/93 (50%)	46 (100%)	0	100	100

Continued on next page...

Continued from previous page...

Mol	Chain	Analysed	Rotameric	Outliers	Percentiles	
1	at	46/93 (50%)	45 (98%)	1 (2%)	47	65
1	bE	46/93 (50%)	45 (98%)	1 (2%)	47	65
1	bF	46/93 (50%)	46 (100%)	0	100	100
1	bG	46/93 (50%)	46 (100%)	0	100	100
1	bH	46/93 (50%)	46 (100%)	0	100	100
1	bI	46/93 (50%)	46 (100%)	0	100	100
1	bJ	46/93 (50%)	46 (100%)	0	100	100
1	bK	46/93 (50%)	45 (98%)	1 (2%)	47	65
1	bR	46/93 (50%)	45 (98%)	1 (2%)	47	65
1	bS	46/93 (50%)	46 (100%)	0	100	100
1	bT	46/93 (50%)	46 (100%)	0	100	100
1	bU	46/93 (50%)	46 (100%)	0	100	100
1	bV	46/93 (50%)	46 (100%)	0	100	100
1	bW	46/93 (50%)	46 (100%)	0	100	100
1	bX	46/93 (50%)	45 (98%)	1 (2%)	47	65
1	bc	46/93 (50%)	45 (98%)	1 (2%)	47	65
1	bd	46/93 (50%)	46 (100%)	0	100	100
1	be	46/93 (50%)	46 (100%)	0	100	100
1	bf	46/93 (50%)	46 (100%)	0	100	100
1	bg	46/93 (50%)	46 (100%)	0	100	100
1	bh	46/93 (50%)	46 (100%)	0	100	100
1	bi	46/93 (50%)	45 (98%)	1 (2%)	47	65
1	bq	46/93 (50%)	45 (98%)	1 (2%)	47	65
1	br	46/93 (50%)	46 (100%)	0	100	100
1	bs	46/93 (50%)	46 (100%)	0	100	100
1	bt	46/93 (50%)	46 (100%)	0	100	100
1	bu	46/93 (50%)	46 (100%)	0	100	100
1	bv	46/93 (50%)	46 (100%)	0	100	100
1	bw	46/93 (50%)	45 (98%)	1 (2%)	47	65
1	cH	46/93 (50%)	45 (98%)	1 (2%)	47	65
1	cI	46/93 (50%)	46 (100%)	0	100	100

Continued on next page...

Continued from previous page...

Mol	Chain	Analysed	Rotameric	Outliers	Percentiles	
1	cJ	46/93 (50%)	46 (100%)	0	100	100
1	cK	46/93 (50%)	46 (100%)	0	100	100
1	cL	46/93 (50%)	46 (100%)	0	100	100
1	cM	46/93 (50%)	46 (100%)	0	100	100
1	cN	46/93 (50%)	45 (98%)	1 (2%)	47	65
1	cV	46/93 (50%)	45 (98%)	1 (2%)	47	65
1	cW	46/93 (50%)	46 (100%)	0	100	100
1	cX	46/93 (50%)	46 (100%)	0	100	100
1	cY	46/93 (50%)	46 (100%)	0	100	100
1	cZ	46/93 (50%)	46 (100%)	0	100	100
1	cf	46/93 (50%)	45 (98%)	1 (2%)	47	65
1	cg	46/93 (50%)	46 (100%)	0	100	100
1	ch	46/93 (50%)	46 (100%)	0	100	100
1	ci	46/93 (50%)	46 (100%)	0	100	100
1	cj	46/93 (50%)	46 (100%)	0	100	100
1	ck	46/93 (50%)	46 (100%)	0	100	100
1	cl	46/93 (50%)	45 (98%)	1 (2%)	47	65
1	ct	46/93 (50%)	45 (98%)	1 (2%)	47	65
1	cu	46/93 (50%)	46 (100%)	0	100	100
1	cv	46/93 (50%)	46 (100%)	0	100	100
1	cw	46/93 (50%)	46 (100%)	0	100	100
1	cx	46/93 (50%)	46 (100%)	0	100	100
1	cy	46/93 (50%)	46 (100%)	0	100	100
1	cz	46/93 (50%)	45 (98%)	1 (2%)	47	65
1	dA	46/93 (50%)	46 (100%)	0	100	100
1	dB	46/93 (50%)	46 (100%)	0	100	100
1	dC	46/93 (50%)	46 (100%)	0	100	100
1	dD	46/93 (50%)	45 (98%)	1 (2%)	47	65
1	dL	46/93 (50%)	45 (98%)	1 (2%)	47	65
1	dM	46/93 (50%)	46 (100%)	0	100	100
1	dN	46/93 (50%)	46 (100%)	0	100	100

Continued on next page...

Continued from previous page...

Mol	Chain	Analysed	Rotameric	Outliers	Percentiles	
1	dO	46/93 (50%)	46 (100%)	0	100	100
1	dP	46/93 (50%)	46 (100%)	0	100	100
1	dQ	46/93 (50%)	46 (100%)	0	100	100
1	dR	46/93 (50%)	45 (98%)	1 (2%)	47	65
1	dZ	46/93 (50%)	45 (98%)	1 (2%)	47	65
1	da	46/93 (50%)	46 (100%)	0	100	100
1	db	46/93 (50%)	45 (98%)	1 (2%)	47	65
1	dj	46/93 (50%)	45 (98%)	1 (2%)	47	65
1	dk	46/93 (50%)	46 (100%)	0	100	100
1	dl	46/93 (50%)	46 (100%)	0	100	100
1	dm	46/93 (50%)	46 (100%)	0	100	100
1	dn	46/93 (50%)	46 (100%)	0	100	100
1	do	46/93 (50%)	46 (100%)	0	100	100
1	dp	46/93 (50%)	45 (98%)	1 (2%)	47	65
1	dx	46/93 (50%)	45 (98%)	1 (2%)	47	65
1	dy	46/93 (50%)	46 (100%)	0	100	100
1	dz	46/93 (50%)	46 (100%)	0	100	100
1	eB	46/93 (50%)	45 (98%)	1 (2%)	47	65
1	eC	46/93 (50%)	46 (100%)	0	100	100
1	eD	46/93 (50%)	46 (100%)	0	100	100
1	eE	46/93 (50%)	46 (100%)	0	100	100
1	eF	46/93 (50%)	46 (100%)	0	100	100
1	eG	46/93 (50%)	46 (100%)	0	100	100
1	eH	46/93 (50%)	45 (98%)	1 (2%)	47	65
1	eP	46/93 (50%)	45 (98%)	1 (2%)	47	65
1	eQ	46/93 (50%)	46 (100%)	0	100	100
1	eR	46/93 (50%)	46 (100%)	0	100	100
1	eS	46/93 (50%)	46 (100%)	0	100	100
1	eT	46/93 (50%)	46 (100%)	0	100	100
1	eU	46/93 (50%)	46 (100%)	0	100	100
1	eV	46/93 (50%)	45 (98%)	1 (2%)	47	65

Continued on next page...

Continued from previous page...

Mol	Chain	Analysed	Rotameric	Outliers	Percentiles	
1	ea	46/93 (50%)	46 (100%)	0	100	100
1	eb	46/93 (50%)	46 (100%)	0	100	100
1	ec	46/93 (50%)	46 (100%)	0	100	100
1	ed	46/93 (50%)	46 (100%)	0	100	100
1	ee	46/93 (50%)	46 (100%)	0	100	100
1	ef	46/93 (50%)	45 (98%)	1 (2%)	47	65
1	en	46/93 (50%)	45 (98%)	1 (2%)	47	65
1	eo	46/93 (50%)	46 (100%)	0	100	100
1	ep	46/93 (50%)	46 (100%)	0	100	100
1	eq	46/93 (50%)	46 (100%)	0	100	100
1	er	46/93 (50%)	46 (100%)	0	100	100
1	es	46/93 (50%)	46 (100%)	0	100	100
1	et	46/93 (50%)	45 (98%)	1 (2%)	47	65
1	fF	46/93 (50%)	45 (98%)	1 (2%)	47	65
1	fG	46/93 (50%)	46 (100%)	0	100	100
1	fH	46/93 (50%)	46 (100%)	0	100	100
1	fI	46/93 (50%)	46 (100%)	0	100	100
1	fJ	46/93 (50%)	46 (100%)	0	100	100
1	fK	46/93 (50%)	46 (100%)	0	100	100
1	fL	46/93 (50%)	45 (98%)	1 (2%)	47	65
1	fT	46/93 (50%)	45 (98%)	1 (2%)	47	65
1	fU	46/93 (50%)	46 (100%)	0	100	100
1	fV	46/93 (50%)	46 (100%)	0	100	100
1	fW	46/93 (50%)	46 (100%)	0	100	100
1	fX	46/93 (50%)	46 (100%)	0	100	100
1	fY	46/93 (50%)	46 (100%)	0	100	100
1	fZ	46/93 (50%)	45 (98%)	1 (2%)	47	65
1	fd	46/93 (50%)	45 (98%)	1 (2%)	47	65
1	fe	46/93 (50%)	46 (100%)	0	100	100
1	ff	46/93 (50%)	46 (100%)	0	100	100
1	fg	46/93 (50%)	46 (100%)	0	100	100

Continued on next page...

Continued from previous page...

Mol	Chain	Analysed	Rotameric	Outliers	Percentiles	
1	fh	46/93 (50%)	46 (100%)	0	100	100
1	fi	46/93 (50%)	46 (100%)	0	100	100
1	fj	46/93 (50%)	45 (98%)	1 (2%)	47	65
1	fr	46/93 (50%)	45 (98%)	1 (2%)	47	65
1	fs	46/93 (50%)	46 (100%)	0	100	100
1	ft	46/93 (50%)	46 (100%)	0	100	100
1	fu	46/93 (50%)	46 (100%)	0	100	100
1	fv	46/93 (50%)	46 (100%)	0	100	100
1	fw	46/93 (50%)	46 (100%)	0	100	100
1	fx	46/93 (50%)	45 (98%)	1 (2%)	47	65
1	gA	46/93 (50%)	46 (100%)	0	100	100
1	gB	46/93 (50%)	45 (98%)	1 (2%)	47	65
1	gJ	46/93 (50%)	45 (98%)	1 (2%)	47	65
1	gK	46/93 (50%)	46 (100%)	0	100	100
1	gL	46/93 (50%)	46 (100%)	0	100	100
1	gM	46/93 (50%)	46 (100%)	0	100	100
1	gN	46/93 (50%)	46 (100%)	0	100	100
1	gO	46/93 (50%)	46 (100%)	0	100	100
1	gP	46/93 (50%)	45 (98%)	1 (2%)	47	65
1	gX	46/93 (50%)	45 (98%)	1 (2%)	47	65
1	gY	46/93 (50%)	46 (100%)	0	100	100
1	gZ	46/93 (50%)	46 (100%)	0	100	100
1	gh	46/93 (50%)	45 (98%)	1 (2%)	47	65
1	gi	46/93 (50%)	46 (100%)	0	100	100
1	gj	46/93 (50%)	46 (100%)	0	100	100
1	gk	46/93 (50%)	46 (100%)	0	100	100
1	gl	46/93 (50%)	46 (100%)	0	100	100
1	gm	46/93 (50%)	46 (100%)	0	100	100
1	gn	46/93 (50%)	45 (98%)	1 (2%)	47	65
1	gv	46/93 (50%)	45 (98%)	1 (2%)	47	65
1	gw	46/93 (50%)	46 (100%)	0	100	100

Continued on next page...

Continued from previous page...

Mol	Chain	Analysed	Rotameric	Outliers	Percentiles	
1	gx	46/93 (50%)	46 (100%)	0	100	100
1	gy	46/93 (50%)	46 (100%)	0	100	100
1	gz	46/93 (50%)	46 (100%)	0	100	100
1	hA	46/93 (50%)	46 (100%)	0	100	100
1	hB	46/93 (50%)	46 (100%)	0	100	100
1	hC	46/93 (50%)	46 (100%)	0	100	100
1	hD	46/93 (50%)	46 (100%)	0	100	100
1	hE	46/93 (50%)	45 (98%)	1 (2%)	47	65
1	hL	46/93 (50%)	45 (98%)	1 (2%)	47	65
1	hM	46/93 (50%)	46 (100%)	0	100	100
1	hN	46/93 (50%)	46 (100%)	0	100	100
1	hO	46/93 (50%)	46 (100%)	0	100	100
1	hP	46/93 (50%)	46 (100%)	0	100	100
1	hQ	46/93 (50%)	46 (100%)	0	100	100
1	hR	46/93 (50%)	45 (98%)	1 (2%)	47	65
1	hZ	46/93 (50%)	45 (98%)	1 (2%)	47	65
1	ha	46/93 (50%)	46 (100%)	0	100	100
1	hb	46/93 (50%)	46 (100%)	0	100	100
1	hc	46/93 (50%)	46 (100%)	0	100	100
1	hd	46/93 (50%)	45 (98%)	1 (2%)	47	65
1	hl	46/93 (50%)	45 (98%)	1 (2%)	47	65
1	hm	46/93 (50%)	46 (100%)	0	100	100
1	hn	46/93 (50%)	46 (100%)	0	100	100
1	ho	46/93 (50%)	46 (100%)	0	100	100
1	hp	46/93 (50%)	46 (100%)	0	100	100
1	hq	46/93 (50%)	46 (100%)	0	100	100
1	hr	46/93 (50%)	45 (98%)	1 (2%)	47	65
1	hy	46/93 (50%)	45 (98%)	1 (2%)	47	65
1	hz	46/93 (50%)	46 (100%)	0	100	100
1	iB	46/93 (50%)	45 (98%)	1 (2%)	47	65
1	iC	46/93 (50%)	46 (100%)	0	100	100

Continued on next page...

Continued from previous page...

Mol	Chain	Analysed	Rotameric	Outliers	Percentiles	
1	iD	46/93 (50%)	46 (100%)	0	100	100
1	iE	46/93 (50%)	46 (100%)	0	100	100
1	iF	46/93 (50%)	46 (100%)	0	100	100
1	iG	46/93 (50%)	46 (100%)	0	100	100
1	iH	46/93 (50%)	45 (98%)	1 (2%)	47	65
1	iP	46/93 (50%)	45 (98%)	1 (2%)	47	65
1	iQ	46/93 (50%)	46 (100%)	0	100	100
1	iR	46/93 (50%)	46 (100%)	0	100	100
1	iS	46/93 (50%)	46 (100%)	0	100	100
1	iT	46/93 (50%)	46 (100%)	0	100	100
1	iU	46/93 (50%)	46 (100%)	0	100	100
1	iV	46/93 (50%)	45 (98%)	1 (2%)	47	65
1	ia	46/93 (50%)	46 (100%)	0	100	100
1	ib	46/93 (50%)	46 (100%)	0	100	100
1	ic	46/93 (50%)	46 (100%)	0	100	100
1	id	46/93 (50%)	46 (100%)	0	100	100
1	ie	46/93 (50%)	46 (100%)	0	100	100
1	if	46/93 (50%)	45 (98%)	1 (2%)	47	65
1	in	46/93 (50%)	45 (98%)	1 (2%)	47	65
1	io	46/93 (50%)	46 (100%)	0	100	100
1	ip	46/93 (50%)	46 (100%)	0	100	100
1	iq	46/93 (50%)	46 (100%)	0	100	100
1	ir	46/93 (50%)	46 (100%)	0	100	100
1	is	46/93 (50%)	46 (100%)	0	100	100
1	it	46/93 (50%)	45 (98%)	1 (2%)	47	65
1	jF	46/93 (50%)	45 (98%)	1 (2%)	47	65
1	jG	46/93 (50%)	46 (100%)	0	100	100
1	jH	46/93 (50%)	46 (100%)	0	100	100
1	jI	46/93 (50%)	46 (100%)	0	100	100
1	jJ	46/93 (50%)	46 (100%)	0	100	100
1	jK	46/93 (50%)	46 (100%)	0	100	100

Continued on next page...

Continued from previous page...

Mol	Chain	Analysed	Rotameric	Outliers	Percentiles	
1	jL	46/93 (50%)	45 (98%)	1 (2%)	47	65
1	jT	46/93 (50%)	45 (98%)	1 (2%)	47	65
1	jU	46/93 (50%)	46 (100%)	0	100	100
1	jV	46/93 (50%)	46 (100%)	0	100	100
1	jW	46/93 (50%)	46 (100%)	0	100	100
1	jX	46/93 (50%)	46 (100%)	0	100	100
1	jY	46/93 (50%)	46 (100%)	0	100	100
1	jZ	46/93 (50%)	45 (98%)	1 (2%)	47	65
1	jd	46/93 (50%)	45 (98%)	1 (2%)	47	65
1	je	46/93 (50%)	46 (100%)	0	100	100
1	jf	46/93 (50%)	46 (100%)	0	100	100
1	yg	46/93 (50%)	46 (100%)	0	100	100
1	jh	46/93 (50%)	46 (100%)	0	100	100
1	ji	46/93 (50%)	46 (100%)	0	100	100
1	jj	46/93 (50%)	45 (98%)	1 (2%)	47	65
1	jr	46/93 (50%)	45 (98%)	1 (2%)	47	65
1	js	46/93 (50%)	46 (100%)	0	100	100
1	jt	46/93 (50%)	46 (100%)	0	100	100
1	ju	46/93 (50%)	46 (100%)	0	100	100
1	jv	46/93 (50%)	46 (100%)	0	100	100
1	jw	46/93 (50%)	46 (100%)	0	100	100
1	jx	46/93 (50%)	45 (98%)	1 (2%)	47	65
1	kA	46/93 (50%)	45 (98%)	1 (2%)	47	65
1	kI	46/93 (50%)	45 (98%)	1 (2%)	47	65
1	kJ	46/93 (50%)	46 (100%)	0	100	100
1	kK	46/93 (50%)	46 (100%)	0	100	100
1	kL	46/93 (50%)	46 (100%)	0	100	100
1	kM	46/93 (50%)	46 (100%)	0	100	100
1	kN	46/93 (50%)	46 (100%)	0	100	100
1	kO	46/93 (50%)	45 (98%)	1 (2%)	47	65
1	kW	46/93 (50%)	45 (98%)	1 (2%)	47	65

Continued on next page...

Continued from previous page...

Mol	Chain	Analysed	Rotameric	Outliers	Percentiles	
1	kX	46/93 (50%)	46 (100%)	0	100	100
1	kY	46/93 (50%)	46 (100%)	0	100	100
1	kZ	46/93 (50%)	46 (100%)	0	100	100
1	kh	46/93 (50%)	45 (98%)	1 (2%)	47	65
1	ki	46/93 (50%)	46 (100%)	0	100	100
1	kj	46/93 (50%)	46 (100%)	0	100	100
1	kk	46/93 (50%)	46 (100%)	0	100	100
1	kl	46/93 (50%)	46 (100%)	0	100	100
1	km	46/93 (50%)	46 (100%)	0	100	100
1	kn	46/93 (50%)	45 (98%)	1 (2%)	47	65
1	ku	46/93 (50%)	45 (98%)	1 (2%)	47	65
1	46/93 (50%)	46 (100%)	0	100	100	
1	kw	46/93 (50%)	46 (100%)	0	100	100
1	kx	46/93 (50%)	46 (100%)	0	100	100
1	ky	46/93 (50%)	46 (100%)	0	100	100
1	kz	46/93 (50%)	46 (100%)	0	100	100
1	lA	46/93 (50%)	46 (100%)	0	100	100
1	lB	46/93 (50%)	46 (100%)	0	100	100
1	lC	46/93 (50%)	46 (100%)	0	100	100
1	lD	46/93 (50%)	46 (100%)	0	100	100
1	lE	46/93 (50%)	45 (98%)	1 (2%)	47	65
1	lM	46/93 (50%)	45 (98%)	1 (2%)	47	65
1	lN	46/93 (50%)	46 (100%)	0	100	100
1	lO	46/93 (50%)	46 (100%)	0	100	100
1	lP	46/93 (50%)	46 (100%)	0	100	100
1	lQ	46/93 (50%)	46 (100%)	0	100	100
1	lR	46/93 (50%)	46 (100%)	0	100	100
1	lS	46/93 (50%)	45 (98%)	1 (2%)	47	65
1	la	46/93 (50%)	46 (100%)	0	100	100
1	lb	46/93 (50%)	46 (100%)	0	100	100
1	lc	46/93 (50%)	45 (98%)	1 (2%)	47	65

Continued on next page...

Continued from previous page...

Mol	Chain	Analysed	Rotameric	Outliers	Percentiles	
1	lk	46/93 (50%)	45 (98%)	1 (2%)	47	65
1	ll	46/93 (50%)	46 (100%)	0	100	100
1	lm	46/93 (50%)	46 (100%)	0	100	100
1	ln	46/93 (50%)	46 (100%)	0	100	100
1	lo	46/93 (50%)	46 (100%)	0	100	100
1	lp	46/93 (50%)	46 (100%)	0	100	100
1	lq	46/93 (50%)	45 (98%)	1 (2%)	47	65
1	ly	46/93 (50%)	45 (98%)	1 (2%)	47	65
1	lz	46/93 (50%)	46 (100%)	0	100	100
1	mC	46/93 (50%)	45 (98%)	1 (2%)	47	65
1	mD	46/93 (50%)	46 (100%)	0	100	100
1	mE	46/93 (50%)	46 (100%)	0	100	100
1	mF	46/93 (50%)	46 (100%)	0	100	100
1	mG	46/93 (50%)	46 (100%)	0	100	100
1	mH	46/93 (50%)	46 (100%)	0	100	100
1	mI	46/93 (50%)	45 (98%)	1 (2%)	47	65
1	mQ	46/93 (50%)	45 (98%)	1 (2%)	47	65
1	mR	46/93 (50%)	46 (100%)	0	100	100
1	mS	46/93 (50%)	46 (100%)	0	100	100
1	mT	46/93 (50%)	46 (100%)	0	100	100
1	mU	46/93 (50%)	46 (100%)	0	100	100
1	mV	46/93 (50%)	46 (100%)	0	100	100
1	mW	46/93 (50%)	45 (98%)	1 (2%)	47	65
1	ma	46/93 (50%)	45 (98%)	1 (2%)	47	65
1	mb	46/93 (50%)	46 (100%)	0	100	100
1	mc	46/93 (50%)	46 (100%)	0	100	100
1	md	46/93 (50%)	46 (100%)	0	100	100
1	me	46/93 (50%)	46 (100%)	0	100	100
1	mf	46/93 (50%)	46 (100%)	0	100	100
1	mg	46/93 (50%)	45 (98%)	1 (2%)	47	65
1	mo	46/93 (50%)	45 (98%)	1 (2%)	47	65

Continued on next page...

Continued from previous page...

Mol	Chain	Analysed	Rotameric	Outliers	Percentiles	
1	mp	46/93 (50%)	46 (100%)	0	100	100
1	mq	46/93 (50%)	46 (100%)	0	100	100
1	mr	46/93 (50%)	46 (100%)	0	100	100
1	ms	46/93 (50%)	46 (100%)	0	100	100
1	mt	46/93 (50%)	46 (100%)	0	100	100
1	mu	46/93 (50%)	45 (98%)	1 (2%)	47	65
1	nG	46/93 (50%)	45 (98%)	1 (2%)	47	65
1	nH	46/93 (50%)	46 (100%)	0	100	100
1	nI	46/93 (50%)	46 (100%)	0	100	100
1	nJ	46/93 (50%)	46 (100%)	0	100	100
1	nK	46/93 (50%)	46 (100%)	0	100	100
1	nL	46/93 (50%)	46 (100%)	0	100	100
1	nM	46/93 (50%)	45 (98%)	1 (2%)	47	65
1	nU	46/93 (50%)	45 (98%)	1 (2%)	47	65
1	nV	46/93 (50%)	46 (100%)	0	100	100
1	nW	46/93 (50%)	46 (100%)	0	100	100
1	nX	46/93 (50%)	46 (100%)	0	100	100
1	nY	46/93 (50%)	46 (100%)	0	100	100
1	nZ	46/93 (50%)	46 (100%)	0	100	100
1	ne	46/93 (50%)	45 (98%)	1 (2%)	47	65
1	nf	46/93 (50%)	46 (100%)	0	100	100
1	ng	46/93 (50%)	46 (100%)	0	100	100
1	nh	46/93 (50%)	46 (100%)	0	100	100
1	ni	46/93 (50%)	46 (100%)	0	100	100
1	nj	46/93 (50%)	46 (100%)	0	100	100
1	nk	46/93 (50%)	45 (98%)	1 (2%)	47	65
1	ns	46/93 (50%)	45 (98%)	1 (2%)	47	65
1	nt	46/93 (50%)	46 (100%)	0	100	100
1	nu	46/93 (50%)	46 (100%)	0	100	100
1	nv	46/93 (50%)	46 (100%)	0	100	100
1	nw	46/93 (50%)	46 (100%)	0	100	100

Continued on next page...

Continued from previous page...

Mol	Chain	Analysed	Rotameric	Outliers	Percentiles	
1	nx	46/93 (50%)	46 (100%)	0	100	100
1	ny	46/93 (50%)	45 (98%)	1 (2%)	47	65
1	oA	46/93 (50%)	46 (100%)	0	100	100
1	oB	46/93 (50%)	46 (100%)	0	100	100
1	oC	46/93 (50%)	45 (98%)	1 (2%)	47	65
1	oK	46/93 (50%)	45 (98%)	1 (2%)	47	65
1	oL	46/93 (50%)	46 (100%)	0	100	100
1	oM	46/93 (50%)	46 (100%)	0	100	100
1	oN	46/93 (50%)	46 (100%)	0	100	100
1	oO	46/93 (50%)	46 (100%)	0	100	100
1	oP	46/93 (50%)	46 (100%)	0	100	100
1	oQ	46/93 (50%)	45 (98%)	1 (2%)	47	65
1	oY	46/93 (50%)	45 (98%)	1 (2%)	47	65
1	oZ	46/93 (50%)	46 (100%)	0	100	100
1	oa	46/93 (50%)	45 (98%)	1 (2%)	47	65
1	oi	46/93 (50%)	45 (98%)	1 (2%)	47	65
1	oj	46/93 (50%)	46 (100%)	0	100	100
1	ok	46/93 (50%)	46 (100%)	0	100	100
1	ol	46/93 (50%)	46 (100%)	0	100	100
1	om	46/93 (50%)	46 (100%)	0	100	100
1	on	46/93 (50%)	46 (100%)	0	100	100
1	oo	46/93 (50%)	45 (98%)	1 (2%)	47	65
1	ow	46/93 (50%)	45 (98%)	1 (2%)	47	65
1	ox	46/93 (50%)	46 (100%)	0	100	100
1	oy	46/93 (50%)	46 (100%)	0	100	100
1	oz	46/93 (50%)	46 (100%)	0	100	100
1	pA	46/93 (50%)	45 (98%)	1 (2%)	47	65
1	pB	46/93 (50%)	46 (100%)	0	100	100
1	pC	46/93 (50%)	46 (100%)	0	100	100
1	pD	46/93 (50%)	46 (100%)	0	100	100
1	pE	46/93 (50%)	46 (100%)	0	100	100

Continued on next page...

Continued from previous page...

Mol	Chain	Analysed	Rotameric	Outliers	Percentiles	
1	pF	46/93 (50%)	46 (100%)	0	100	100
1	pG	46/93 (50%)	45 (98%)	1 (2%)	47	65
1	pO	46/93 (50%)	45 (98%)	1 (2%)	47	65
1	pP	46/93 (50%)	46 (100%)	0	100	100
1	pQ	46/93 (50%)	46 (100%)	0	100	100
1	pR	46/93 (50%)	46 (100%)	0	100	100
1	pS	46/93 (50%)	46 (100%)	0	100	100
1	pT	46/93 (50%)	46 (100%)	0	100	100
1	pU	46/93 (50%)	45 (98%)	1 (2%)	47	65
1	pa	46/93 (50%)	46 (100%)	0	100	100
1	pb	46/93 (50%)	46 (100%)	0	100	100
1	pc	46/93 (50%)	46 (100%)	0	100	100
1	pd	46/93 (50%)	46 (100%)	0	100	100
1	pe	46/93 (50%)	45 (98%)	1 (2%)	47	65
1	pm	46/93 (50%)	45 (98%)	1 (2%)	47	65
1	pn	46/93 (50%)	46 (100%)	0	100	100
1	po	46/93 (50%)	46 (100%)	0	100	100
1	pp	46/93 (50%)	46 (100%)	0	100	100
1	pq	46/93 (50%)	46 (100%)	0	100	100
1	pr	46/93 (50%)	46 (100%)	0	100	100
1	ps	46/93 (50%)	45 (98%)	1 (2%)	47	65
1	qc	46/93 (50%)	45 (98%)	1 (2%)	47	65
2	aH	243/252 (96%)	242 (100%)	1 (0%)	89	91
2	aI	244/252 (97%)	244 (100%)	0	100	100
2	aJ	243/252 (96%)	242 (100%)	1 (0%)	89	91
2	aK	243/252 (96%)	243 (100%)	0	100	100
2	aL	243/252 (96%)	243 (100%)	0	100	100
2	aM	243/252 (96%)	241 (99%)	2 (1%)	79	85
2	aN	243/252 (96%)	243 (100%)	0	100	100
2	aV	243/252 (96%)	242 (100%)	1 (0%)	89	91
2	aW	244/252 (97%)	244 (100%)	0	100	100

Continued on next page...

Continued from previous page...

Mol	Chain	Analysed	Rotameric	Outliers	Percentiles	
2	aX	243/252 (96%)	242 (100%)	1 (0%)	89	91
2	aY	243/252 (96%)	243 (100%)	0	100	100
2	aZ	243/252 (96%)	243 (100%)	0	100	100
2	ag	243/252 (96%)	242 (100%)	1 (0%)	89	91
2	ah	244/252 (97%)	244 (100%)	0	100	100
2	ai	243/252 (96%)	242 (100%)	1 (0%)	89	91
2	aj	243/252 (96%)	243 (100%)	0	100	100
2	ak	243/252 (96%)	243 (100%)	0	100	100
2	al	243/252 (96%)	241 (99%)	2 (1%)	79	85
2	am	243/252 (96%)	243 (100%)	0	100	100
2	au	243/252 (96%)	242 (100%)	1 (0%)	89	91
2	av	243/252 (96%)	242 (100%)	1 (0%)	89	91
2	aw	243/252 (96%)	243 (100%)	0	100	100
2	ax	243/252 (96%)	243 (100%)	0	100	100
2	ay	243/252 (96%)	241 (99%)	2 (1%)	79	85
2	az	243/252 (96%)	243 (100%)	0	100	100
2	bA	243/252 (96%)	243 (100%)	0	100	100
2	bB	243/252 (96%)	243 (100%)	0	100	100
2	bC	243/252 (96%)	241 (99%)	2 (1%)	79	85
2	bD	243/252 (96%)	243 (100%)	0	100	100
2	bL	243/252 (96%)	242 (100%)	1 (0%)	89	91
2	bM	243/252 (96%)	242 (100%)	1 (0%)	89	91
2	bN	243/252 (96%)	243 (100%)	0	100	100
2	bO	243/252 (96%)	243 (100%)	0	100	100
2	bP	243/252 (96%)	241 (99%)	2 (1%)	79	85
2	bQ	243/252 (96%)	243 (100%)	0	100	100
2	bY	243/252 (96%)	242 (100%)	1 (0%)	89	91
2	bZ	244/252 (97%)	244 (100%)	0	100	100
2	ba	243/252 (96%)	241 (99%)	2 (1%)	79	85
2	bb	243/252 (96%)	243 (100%)	0	100	100
2	bj	243/252 (96%)	242 (100%)	1 (0%)	89	91

Continued on next page...

Continued from previous page...

Mol	Chain	Analysed	Rotameric	Outliers	Percentiles	
2	bk	244/252 (97%)	244 (100%)	0	100	100
2	bl	243/252 (96%)	242 (100%)	1 (0%)	89	91
2	bm	243/252 (96%)	243 (100%)	0	100	100
2	bn	243/252 (96%)	243 (100%)	0	100	100
2	bo	243/252 (96%)	241 (99%)	2 (1%)	79	85
2	bp	243/252 (96%)	243 (100%)	0	100	100
2	bx	243/252 (96%)	242 (100%)	1 (0%)	89	91
2	by	244/252 (97%)	244 (100%)	0	100	100
2	bz	243/252 (96%)	242 (100%)	1 (0%)	89	91
2	cA	243/252 (96%)	242 (100%)	1 (0%)	89	91
2	cB	244/252 (97%)	244 (100%)	0	100	100
2	cC	243/252 (96%)	242 (100%)	1 (0%)	89	91
2	cD	243/252 (96%)	243 (100%)	0	100	100
2	cE	243/252 (96%)	243 (100%)	0	100	100
2	cF	243/252 (96%)	241 (99%)	2 (1%)	79	85
2	cG	243/252 (96%)	243 (100%)	0	100	100
2	cO	243/252 (96%)	242 (100%)	1 (0%)	89	91
2	cP	244/252 (97%)	244 (100%)	0	100	100
2	cQ	243/252 (96%)	242 (100%)	1 (0%)	89	91
2	cR	243/252 (96%)	243 (100%)	0	100	100
2	cS	243/252 (96%)	243 (100%)	0	100	100
2	cT	243/252 (96%)	241 (99%)	2 (1%)	79	85
2	cU	243/252 (96%)	243 (100%)	0	100	100
2	ca	243/252 (96%)	242 (100%)	1 (0%)	89	91
2	cb	243/252 (96%)	243 (100%)	0	100	100
2	cc	243/252 (96%)	243 (100%)	0	100	100
2	cd	243/252 (96%)	241 (99%)	2 (1%)	79	85
2	ce	243/252 (96%)	243 (100%)	0	100	100
2	cm	243/252 (96%)	242 (100%)	1 (0%)	89	91
2	cn	244/252 (97%)	244 (100%)	0	100	100
2	co	243/252 (96%)	242 (100%)	1 (0%)	89	91

Continued on next page...

Continued from previous page...

Mol	Chain	Analysed	Rotameric	Outliers	Percentiles	
2	cp	243/252 (96%)	243 (100%)	0	100	100
2	cq	243/252 (96%)	243 (100%)	0	100	100
2	cr	243/252 (96%)	241 (99%)	2 (1%)	79	85
2	cs	243/252 (96%)	243 (100%)	0	100	100
2	dE	243/252 (96%)	242 (100%)	1 (0%)	89	91
2	dF	244/252 (97%)	244 (100%)	0	100	100
2	dG	243/252 (96%)	242 (100%)	1 (0%)	89	91
2	dH	243/252 (96%)	243 (100%)	0	100	100
2	dI	243/252 (96%)	243 (100%)	0	100	100
2	dJ	243/252 (96%)	241 (99%)	2 (1%)	79	85
2	dK	243/252 (96%)	243 (100%)	0	100	100
2	dS	243/252 (96%)	242 (100%)	1 (0%)	89	91
2	dT	244/252 (97%)	244 (100%)	0	100	100
2	dU	243/252 (96%)	242 (100%)	1 (0%)	89	91
2	dV	243/252 (96%)	243 (100%)	0	100	100
2	dW	243/252 (96%)	243 (100%)	0	100	100
2	dX	243/252 (96%)	241 (99%)	2 (1%)	79	85
2	dY	243/252 (96%)	243 (100%)	0	100	100
2	dc	243/252 (96%)	242 (100%)	1 (0%)	89	91
2	dd	244/252 (97%)	244 (100%)	0	100	100
2	de	243/252 (96%)	242 (100%)	1 (0%)	89	91
2	df	243/252 (96%)	243 (100%)	0	100	100
2	dg	243/252 (96%)	243 (100%)	0	100	100
2	dh	243/252 (96%)	241 (99%)	2 (1%)	79	85
2	di	243/252 (96%)	243 (100%)	0	100	100
2	dq	243/252 (96%)	242 (100%)	1 (0%)	89	91
2	dr	244/252 (97%)	244 (100%)	0	100	100
2	ds	243/252 (96%)	242 (100%)	1 (0%)	89	91
2	dt	243/252 (96%)	243 (100%)	0	100	100
2	du	243/252 (96%)	243 (100%)	0	100	100
2	dv	243/252 (96%)	241 (99%)	2 (1%)	79	85

Continued on next page...

Continued from previous page...

Mol	Chain	Analysed	Rotameric	Outliers	Percentiles	
2	dw	243/252 (96%)	243 (100%)	0	100	100
2	eA	243/252 (96%)	243 (100%)	0	100	100
2	eI	243/252 (96%)	242 (100%)	1 (0%)	89	91
2	eJ	244/252 (97%)	244 (100%)	0	100	100
2	eK	243/252 (96%)	242 (100%)	1 (0%)	89	91
2	eL	243/252 (96%)	243 (100%)	0	100	100
2	eM	243/252 (96%)	243 (100%)	0	100	100
2	eN	243/252 (96%)	241 (99%)	2 (1%)	79	85
2	eO	243/252 (96%)	243 (100%)	0	100	100
2	eW	243/252 (96%)	242 (100%)	1 (0%)	89	91
2	eX	244/252 (97%)	244 (100%)	0	100	100
2	eY	243/252 (96%)	242 (100%)	1 (0%)	89	91
2	eZ	243/252 (96%)	243 (100%)	0	100	100
2	eg	243/252 (96%)	242 (100%)	1 (0%)	89	91
2	eh	244/252 (97%)	244 (100%)	0	100	100
2	ei	243/252 (96%)	242 (100%)	1 (0%)	89	91
2	ej	243/252 (96%)	243 (100%)	0	100	100
2	ek	243/252 (96%)	243 (100%)	0	100	100
2	el	243/252 (96%)	241 (99%)	2 (1%)	79	85
2	em	243/252 (96%)	243 (100%)	0	100	100
2	eu	243/252 (96%)	242 (100%)	1 (0%)	89	91
2	ev	244/252 (97%)	244 (100%)	0	100	100
2	ew	243/252 (96%)	242 (100%)	1 (0%)	89	91
2	ex	243/252 (96%)	243 (100%)	0	100	100
2	ey	243/252 (96%)	243 (100%)	0	100	100
2	ez	243/252 (96%)	241 (99%)	2 (1%)	79	85
2	fA	243/252 (96%)	242 (100%)	1 (0%)	89	91
2	fB	243/252 (96%)	243 (100%)	0	100	100
2	fC	243/252 (96%)	243 (100%)	0	100	100
2	fD	243/252 (96%)	241 (99%)	2 (1%)	79	85
2	fE	243/252 (96%)	243 (100%)	0	100	100

Continued on next page...

Continued from previous page...

Mol	Chain	Analysed	Rotameric	Outliers	Percentiles	
2	fM	243/252 (96%)	242 (100%)	1 (0%)	89	91
2	fN	244/252 (97%)	244 (100%)	0	100	100
2	fO	243/252 (96%)	242 (100%)	1 (0%)	89	91
2	fP	243/252 (96%)	243 (100%)	0	100	100
2	fQ	243/252 (96%)	243 (100%)	0	100	100
2	fR	243/252 (96%)	241 (99%)	2 (1%)	79	85
2	fS	243/252 (96%)	243 (100%)	0	100	100
2	fa	243/252 (96%)	243 (100%)	0	100	100
2	fb	243/252 (96%)	241 (99%)	2 (1%)	79	85
2	fc	243/252 (96%)	243 (100%)	0	100	100
2	fk	243/252 (96%)	242 (100%)	1 (0%)	89	91
2	fl	244/252 (97%)	244 (100%)	0	100	100
2	fm	243/252 (96%)	242 (100%)	1 (0%)	89	91
2	fn	243/252 (96%)	243 (100%)	0	100	100
2	fo	243/252 (96%)	243 (100%)	0	100	100
2	fp	243/252 (96%)	241 (99%)	2 (1%)	79	85
2	fq	243/252 (96%)	243 (100%)	0	100	100
2	fy	243/252 (96%)	242 (100%)	1 (0%)	89	91
2	fz	244/252 (97%)	244 (100%)	0	100	100
2	gC	243/252 (96%)	242 (100%)	1 (0%)	89	91
2	gD	244/252 (97%)	244 (100%)	0	100	100
2	gE	243/252 (96%)	242 (100%)	1 (0%)	89	91
2	gF	243/252 (96%)	243 (100%)	0	100	100
2	gG	243/252 (96%)	243 (100%)	0	100	100
2	gH	243/252 (96%)	241 (99%)	2 (1%)	79	85
2	gI	243/252 (96%)	243 (100%)	0	100	100
2	gQ	243/252 (96%)	242 (100%)	1 (0%)	89	91
2	gR	244/252 (97%)	244 (100%)	0	100	100
2	gS	243/252 (96%)	242 (100%)	1 (0%)	89	91
2	gT	243/252 (96%)	243 (100%)	0	100	100
2	gU	243/252 (96%)	243 (100%)	0	100	100

Continued on next page...

Continued from previous page...

Mol	Chain	Analysed	Rotameric	Outliers	Percentiles	
2	gV	243/252 (96%)	241 (99%)	2 (1%)	79	85
2	gW	243/252 (96%)	243 (100%)	0	100	100
2	ga	243/252 (96%)	242 (100%)	1 (0%)	89	91
2	gb	244/252 (97%)	244 (100%)	0	100	100
2	gc	243/252 (96%)	242 (100%)	1 (0%)	89	91
2	gd	243/252 (96%)	243 (100%)	0	100	100
2	ge	243/252 (96%)	243 (100%)	0	100	100
2	gf	243/252 (96%)	241 (99%)	2 (1%)	79	85
2	gg	243/252 (96%)	243 (100%)	0	100	100
2	go	243/252 (96%)	242 (100%)	1 (0%)	89	91
2	gp	244/252 (97%)	244 (100%)	0	100	100
2	gq	243/252 (96%)	242 (100%)	1 (0%)	89	91
2	gr	243/252 (96%)	243 (100%)	0	100	100
2	gs	243/252 (96%)	243 (100%)	0	100	100
2	gt	243/252 (96%)	241 (99%)	2 (1%)	79	85
2	gu	243/252 (96%)	243 (100%)	0	100	100
2	hF	243/252 (96%)	242 (100%)	1 (0%)	89	91
2	hG	243/252 (96%)	242 (100%)	1 (0%)	89	91
2	hH	243/252 (96%)	243 (100%)	0	100	100
2	hI	243/252 (96%)	243 (100%)	0	100	100
2	hJ	243/252 (96%)	241 (99%)	2 (1%)	79	85
2	hK	243/252 (96%)	243 (100%)	0	100	100
2	hS	243/252 (96%)	242 (100%)	1 (0%)	89	91
2	hT	244/252 (97%)	244 (100%)	0	100	100
2	hU	243/252 (96%)	242 (100%)	1 (0%)	89	91
2	hV	243/252 (96%)	243 (100%)	0	100	100
2	hW	243/252 (96%)	243 (100%)	0	100	100
2	hX	243/252 (96%)	241 (99%)	2 (1%)	79	85
2	hY	243/252 (96%)	243 (100%)	0	100	100
2	he	243/252 (96%)	242 (100%)	1 (0%)	89	91
2	hf	244/252 (97%)	244 (100%)	0	100	100

Continued on next page...

Continued from previous page...

Mol	Chain	Analysed	Rotameric	Outliers	Percentiles	
2	hg	243/252 (96%)	242 (100%)	1 (0%)	89	91
2	hh	243/252 (96%)	243 (100%)	0	100	100
2	hi	243/252 (96%)	243 (100%)	0	100	100
2	hj	243/252 (96%)	241 (99%)	2 (1%)	79	85
2	hk	243/252 (96%)	243 (100%)	0	100	100
2	hs	243/252 (96%)	242 (100%)	1 (0%)	89	91
2	ht	243/252 (96%)	242 (100%)	1 (0%)	89	91
2	hu	243/252 (96%)	243 (100%)	0	100	100
2	hv	243/252 (96%)	243 (100%)	0	100	100
2	hw	243/252 (96%)	241 (99%)	2 (1%)	79	85
2	hx	243/252 (96%)	243 (100%)	0	100	100
2	iA	243/252 (96%)	243 (100%)	0	100	100
2	iI	243/252 (96%)	242 (100%)	1 (0%)	89	91
2	iJ	244/252 (97%)	244 (100%)	0	100	100
2	iK	243/252 (96%)	242 (100%)	1 (0%)	89	91
2	iL	243/252 (96%)	243 (100%)	0	100	100
2	iM	243/252 (96%)	243 (100%)	0	100	100
2	iN	243/252 (96%)	241 (99%)	2 (1%)	79	85
2	iO	243/252 (96%)	243 (100%)	0	100	100
2	iW	243/252 (96%)	242 (100%)	1 (0%)	89	91
2	iX	244/252 (97%)	244 (100%)	0	100	100
2	iY	243/252 (96%)	242 (100%)	1 (0%)	89	91
2	iZ	243/252 (96%)	243 (100%)	0	100	100
2	ig	243/252 (96%)	242 (100%)	1 (0%)	89	91
2	ih	244/252 (97%)	244 (100%)	0	100	100
2	ii	243/252 (96%)	242 (100%)	1 (0%)	89	91
2	ij	243/252 (96%)	243 (100%)	0	100	100
2	ik	243/252 (96%)	243 (100%)	0	100	100
2	il	243/252 (96%)	241 (99%)	2 (1%)	79	85
2	im	243/252 (96%)	243 (100%)	0	100	100
2	iu	243/252 (96%)	242 (100%)	1 (0%)	89	91

Continued on next page...

Continued from previous page...

Mol	Chain	Analysed	Rotameric	Outliers	Percentiles	
2	iv	244/252 (97%)	244 (100%)	0	100	100
2	iw	243/252 (96%)	242 (100%)	1 (0%)	89	91
2	ix	243/252 (96%)	243 (100%)	0	100	100
2	iy	243/252 (96%)	243 (100%)	0	100	100
2	iz	243/252 (96%)	241 (99%)	2 (1%)	79	85
2	jA	243/252 (96%)	242 (100%)	1 (0%)	89	91
2	jB	243/252 (96%)	243 (100%)	0	100	100
2	jC	243/252 (96%)	243 (100%)	0	100	100
2	jD	243/252 (96%)	241 (99%)	2 (1%)	79	85
2	jE	243/252 (96%)	243 (100%)	0	100	100
2	jM	243/252 (96%)	242 (100%)	1 (0%)	89	91
2	jN	244/252 (97%)	244 (100%)	0	100	100
2	jO	243/252 (96%)	242 (100%)	1 (0%)	89	91
2	jP	243/252 (96%)	243 (100%)	0	100	100
2	jQ	243/252 (96%)	243 (100%)	0	100	100
2	jR	243/252 (96%)	241 (99%)	2 (1%)	79	85
2	jS	243/252 (96%)	243 (100%)	0	100	100
2	ja	243/252 (96%)	243 (100%)	0	100	100
2	jb	243/252 (96%)	241 (99%)	2 (1%)	79	85
2	jc	243/252 (96%)	243 (100%)	0	100	100
2	jk	243/252 (96%)	242 (100%)	1 (0%)	89	91
2	jl	244/252 (97%)	244 (100%)	0	100	100
2	jm	243/252 (96%)	242 (100%)	1 (0%)	89	91
2	jn	243/252 (96%)	243 (100%)	0	100	100
2	jo	243/252 (96%)	243 (100%)	0	100	100
2	jp	243/252 (96%)	241 (99%)	2 (1%)	79	85
2	jq	243/252 (96%)	243 (100%)	0	100	100
2	jy	243/252 (96%)	242 (100%)	1 (0%)	89	91
2	jz	244/252 (97%)	244 (100%)	0	100	100
2	kB	243/252 (96%)	242 (100%)	1 (0%)	89	91
2	kC	244/252 (97%)	244 (100%)	0	100	100

Continued on next page...

Continued from previous page...

Mol	Chain	Analysed	Rotameric	Outliers	Percentiles	
2	kD	243/252 (96%)	242 (100%)	1 (0%)	89	91
2	kE	243/252 (96%)	243 (100%)	0	100	100
2	kF	243/252 (96%)	243 (100%)	0	100	100
2	kG	243/252 (96%)	241 (99%)	2 (1%)	79	85
2	kH	243/252 (96%)	243 (100%)	0	100	100
2	kP	243/252 (96%)	242 (100%)	1 (0%)	89	91
2	kQ	244/252 (97%)	244 (100%)	0	100	100
2	kR	243/252 (96%)	242 (100%)	1 (0%)	89	91
2	kS	243/252 (96%)	243 (100%)	0	100	100
2	kT	243/252 (96%)	243 (100%)	0	100	100
2	kU	243/252 (96%)	241 (99%)	2 (1%)	79	85
2	kV	243/252 (96%)	243 (100%)	0	100	100
2	ka	243/252 (96%)	242 (100%)	1 (0%)	89	91
2	kb	244/252 (97%)	244 (100%)	0	100	100
2	kc	243/252 (96%)	242 (100%)	1 (0%)	89	91
2	kd	243/252 (96%)	243 (100%)	0	100	100
2	ke	243/252 (96%)	243 (100%)	0	100	100
2	kf	243/252 (96%)	241 (99%)	2 (1%)	79	85
2	kg	243/252 (96%)	243 (100%)	0	100	100
2	ko	243/252 (96%)	242 (100%)	1 (0%)	89	91
2	kp	243/252 (96%)	242 (100%)	1 (0%)	89	91
2	kq	243/252 (96%)	243 (100%)	0	100	100
2	kr	243/252 (96%)	243 (100%)	0	100	100
2	ks	243/252 (96%)	241 (99%)	2 (1%)	79	85
2	kt	243/252 (96%)	243 (100%)	0	100	100
2	lF	243/252 (96%)	242 (100%)	1 (0%)	89	91
2	lG	244/252 (97%)	244 (100%)	0	100	100
2	lH	243/252 (96%)	242 (100%)	1 (0%)	89	91
2	lI	243/252 (96%)	243 (100%)	0	100	100
2	lJ	243/252 (96%)	243 (100%)	0	100	100
2	lK	243/252 (96%)	241 (99%)	2 (1%)	79	85

Continued on next page...

Continued from previous page...

Mol	Chain	Analysed	Rotameric	Outliers	Percentiles	
2	lL	243/252 (96%)	243 (100%)	0	100	100
2	lT	243/252 (96%)	242 (100%)	1 (0%)	89	91
2	lU	244/252 (97%)	244 (100%)	0	100	100
2	lV	243/252 (96%)	242 (100%)	1 (0%)	89	91
2	lW	243/252 (96%)	243 (100%)	0	100	100
2	lX	243/252 (96%)	243 (100%)	0	100	100
2	lY	243/252 (96%)	241 (99%)	2 (1%)	79	85
2	lZ	243/252 (96%)	243 (100%)	0	100	100
2	ld	243/252 (96%)	242 (100%)	1 (0%)	89	91
2	le	244/252 (97%)	244 (100%)	0	100	100
2	lf	243/252 (96%)	242 (100%)	1 (0%)	89	91
2	lg	243/252 (96%)	243 (100%)	0	100	100
2	lh	243/252 (96%)	243 (100%)	0	100	100
2	li	243/252 (96%)	241 (99%)	2 (1%)	79	85
2	lj	243/252 (96%)	243 (100%)	0	100	100
2	lr	243/252 (96%)	242 (100%)	1 (0%)	89	91
2	ls	244/252 (97%)	244 (100%)	0	100	100
2	lt	243/252 (96%)	242 (100%)	1 (0%)	89	91
2	lu	243/252 (96%)	243 (100%)	0	100	100
2	lv	243/252 (96%)	243 (100%)	0	100	100
2	lw	243/252 (96%)	241 (99%)	2 (1%)	79	85
2	lx	243/252 (96%)	243 (100%)	0	100	100
2	mA	243/252 (96%)	241 (99%)	2 (1%)	79	85
2	mB	243/252 (96%)	243 (100%)	0	100	100
2	mJ	243/252 (96%)	242 (100%)	1 (0%)	89	91
2	mK	244/252 (97%)	244 (100%)	0	100	100
2	mL	243/252 (96%)	242 (100%)	1 (0%)	89	91
2	mM	243/252 (96%)	243 (100%)	0	100	100
2	mN	243/252 (96%)	243 (100%)	0	100	100
2	mO	243/252 (96%)	241 (99%)	2 (1%)	79	85
2	mP	243/252 (96%)	243 (100%)	0	100	100

Continued on next page...

Continued from previous page...

Mol	Chain	Analysed	Rotameric	Outliers	Percentiles	
2	mX	243/252 (96%)	242 (100%)	1 (0%)	89	91
2	mY	244/252 (97%)	244 (100%)	0	100	100
2	mZ	243/252 (96%)	242 (100%)	1 (0%)	89	91
2	mh	243/252 (96%)	242 (100%)	1 (0%)	89	91
2	mi	244/252 (97%)	244 (100%)	0	100	100
2	mj	243/252 (96%)	242 (100%)	1 (0%)	89	91
2	mk	243/252 (96%)	243 (100%)	0	100	100
2	ml	243/252 (96%)	243 (100%)	0	100	100
2	mm	243/252 (96%)	241 (99%)	2 (1%)	79	85
2	mn	243/252 (96%)	243 (100%)	0	100	100
2	mv	243/252 (96%)	242 (100%)	1 (0%)	89	91
2	mw	244/252 (97%)	244 (100%)	0	100	100
2	mx	243/252 (96%)	242 (100%)	1 (0%)	89	91
2	my	243/252 (96%)	243 (100%)	0	100	100
2	mz	243/252 (96%)	243 (100%)	0	100	100
2	nA	244/252 (97%)	244 (100%)	0	100	100
2	nB	243/252 (96%)	242 (100%)	1 (0%)	89	91
2	nC	243/252 (96%)	243 (100%)	0	100	100
2	nD	243/252 (96%)	243 (100%)	0	100	100
2	nE	243/252 (96%)	241 (99%)	2 (1%)	79	85
2	nF	243/252 (96%)	243 (100%)	0	100	100
2	nN	243/252 (96%)	242 (100%)	1 (0%)	89	91
2	nO	244/252 (97%)	244 (100%)	0	100	100
2	nP	243/252 (96%)	242 (100%)	1 (0%)	89	91
2	nQ	243/252 (96%)	243 (100%)	0	100	100
2	nR	243/252 (96%)	243 (100%)	0	100	100
2	nS	243/252 (96%)	241 (99%)	2 (1%)	79	85
2	nT	243/252 (96%)	243 (100%)	0	100	100
2	na	243/252 (96%)	243 (100%)	0	100	100
2	nb	243/252 (96%)	243 (100%)	0	100	100
2	nc	243/252 (96%)	241 (99%)	2 (1%)	79	85

Continued on next page...

Continued from previous page...

Mol	Chain	Analysed	Rotameric	Outliers	Percentiles	
2	nd	243/252 (96%)	243 (100%)	0	100	100
2	nl	243/252 (96%)	242 (100%)	1 (0%)	89	91
2	nm	244/252 (97%)	244 (100%)	0	100	100
2	nn	243/252 (96%)	242 (100%)	1 (0%)	89	91
2	no	243/252 (96%)	243 (100%)	0	100	100
2	np	243/252 (96%)	243 (100%)	0	100	100
2	nq	243/252 (96%)	241 (99%)	2 (1%)	79	85
2	nr	243/252 (96%)	243 (100%)	0	100	100
2	nz	243/252 (96%)	242 (100%)	1 (0%)	89	91
2	oD	243/252 (96%)	242 (100%)	1 (0%)	89	91
2	oE	244/252 (97%)	244 (100%)	0	100	100
2	oF	243/252 (96%)	242 (100%)	1 (0%)	89	91
2	oG	243/252 (96%)	243 (100%)	0	100	100
2	oH	243/252 (96%)	243 (100%)	0	100	100
2	oI	243/252 (96%)	241 (99%)	2 (1%)	79	85
2	oJ	243/252 (96%)	243 (100%)	0	100	100
2	oR	243/252 (96%)	242 (100%)	1 (0%)	89	91
2	oS	244/252 (97%)	244 (100%)	0	100	100
2	oT	243/252 (96%)	242 (100%)	1 (0%)	89	91
2	oU	243/252 (96%)	243 (100%)	0	100	100
2	oV	243/252 (96%)	243 (100%)	0	100	100
2	oW	243/252 (96%)	241 (99%)	2 (1%)	79	85
2	oX	243/252 (96%)	243 (100%)	0	100	100
2	ob	243/252 (96%)	242 (100%)	1 (0%)	89	91
2	oc	244/252 (97%)	244 (100%)	0	100	100
2	od	243/252 (96%)	242 (100%)	1 (0%)	89	91
2	oe	243/252 (96%)	243 (100%)	0	100	100
2	of	243/252 (96%)	243 (100%)	0	100	100
2	og	243/252 (96%)	241 (99%)	2 (1%)	79	85
2	oh	243/252 (96%)	243 (100%)	0	100	100
2	op	243/252 (96%)	242 (100%)	1 (0%)	89	91

Continued on next page...

Continued from previous page...

Mol	Chain	Analysed	Rotameric	Outliers	Percentiles	
2	oq	244/252 (97%)	244 (100%)	0	100	100
2	or	243/252 (96%)	242 (100%)	1 (0%)	89	91
2	os	243/252 (96%)	243 (100%)	0	100	100
2	ot	243/252 (96%)	243 (100%)	0	100	100
2	ou	243/252 (96%)	241 (99%)	2 (1%)	79	85
2	ov	243/252 (96%)	243 (100%)	0	100	100
2	pH	243/252 (96%)	242 (100%)	1 (0%)	89	91
2	pI	244/252 (97%)	244 (100%)	0	100	100
2	pJ	243/252 (96%)	242 (100%)	1 (0%)	89	91
2	pK	243/252 (96%)	243 (100%)	0	100	100
2	pL	243/252 (96%)	243 (100%)	0	100	100
2	pM	243/252 (96%)	241 (99%)	2 (1%)	79	85
2	pN	243/252 (96%)	243 (100%)	0	100	100
2	pV	243/252 (96%)	242 (100%)	1 (0%)	89	91
2	pW	244/252 (97%)	244 (100%)	0	100	100
2	pX	243/252 (96%)	242 (100%)	1 (0%)	89	91
2	pY	243/252 (96%)	243 (100%)	0	100	100
2	pZ	243/252 (96%)	243 (100%)	0	100	100
2	pf	243/252 (96%)	242 (100%)	1 (0%)	89	91
2	pg	244/252 (97%)	244 (100%)	0	100	100
2	ph	243/252 (96%)	242 (100%)	1 (0%)	89	91
2	pi	243/252 (96%)	243 (100%)	0	100	100
2	pj	243/252 (96%)	243 (100%)	0	100	100
2	pk	243/252 (96%)	241 (99%)	2 (1%)	79	85
2	pl	243/252 (96%)	243 (100%)	0	100	100
2	pt	243/252 (96%)	242 (100%)	1 (0%)	89	91
2	pu	244/252 (97%)	244 (100%)	0	100	100
2	pV	243/252 (96%)	242 (100%)	1 (0%)	89	91
2	pW	243/252 (96%)	243 (100%)	0	100	100
2	pX	243/252 (96%)	243 (100%)	0	100	100
2	py	243/252 (96%)	241 (99%)	2 (1%)	79	85

Continued on next page...

Continued from previous page...

Mol	Chain	Analysed	Rotameric	Outliers	Percentiles	
2	pz	243/252 (96%)	243 (100%)	0	100	100
2	qa	243/252 (96%)	241 (99%)	2 (1%)	79	85
2	qb	243/252 (96%)	243 (100%)	0	100	100
3	qd	104/124 (84%)	104 (100%)	0	100	100
3	qe	104/124 (84%)	104 (100%)	0	100	100
3	qf	104/124 (84%)	104 (100%)	0	100	100
3	qg	104/124 (84%)	104 (100%)	0	100	100
3	qh	104/124 (84%)	104 (100%)	0	100	100
3	qi	104/124 (84%)	104 (100%)	0	100	100
4	qj	195/198 (98%)	194 (100%)	1 (0%)	86	89
4	qk	195/198 (98%)	194 (100%)	1 (0%)	86	89
4	ql	195/198 (98%)	194 (100%)	1 (0%)	86	89
4	qm	195/198 (98%)	194 (100%)	1 (0%)	86	89
4	qn	195/198 (98%)	194 (100%)	1 (0%)	86	89
4	qo	195/198 (98%)	194 (100%)	1 (0%)	86	89
5	qB	323/417 (78%)	322 (100%)	1 (0%)	91	92
5	qD	323/417 (78%)	322 (100%)	1 (0%)	91	92
5	qF	323/417 (78%)	322 (100%)	1 (0%)	91	92
5	qH	323/417 (78%)	322 (100%)	1 (0%)	91	92
5	qJ	323/417 (78%)	322 (100%)	1 (0%)	91	92
5	qL	323/417 (78%)	322 (100%)	1 (0%)	91	92
5	qP	323/417 (78%)	322 (100%)	1 (0%)	91	92
5	qR	323/417 (78%)	322 (100%)	1 (0%)	91	92
5	qT	323/417 (78%)	322 (100%)	1 (0%)	91	92
5	qV	323/417 (78%)	322 (100%)	1 (0%)	91	92
5	qX	323/417 (78%)	322 (100%)	1 (0%)	91	92
5	qZ	323/417 (78%)	322 (100%)	1 (0%)	91	92
6	qA	113/114 (99%)	112 (99%)	1 (1%)	75	83
6	qC	113/114 (99%)	112 (99%)	1 (1%)	75	83
6	qE	113/114 (99%)	112 (99%)	1 (1%)	75	83
6	qG	113/114 (99%)	112 (99%)	1 (1%)	75	83

Continued on next page...

Continued from previous page...

Mol	Chain	Analysed	Rotameric	Outliers	Percentiles	
6	qI	113/114 (99%)	112 (99%)	1 (1%)	75	83
6	qK	113/114 (99%)	112 (99%)	1 (1%)	75	83
6	qM	113/114 (99%)	112 (99%)	1 (1%)	75	83
6	qq	113/114 (99%)	112 (99%)	1 (1%)	75	83
6	qs	113/114 (99%)	112 (99%)	1 (1%)	75	83
6	qu	113/114 (99%)	112 (99%)	1 (1%)	75	83
6	qw	113/114 (99%)	112 (99%)	1 (1%)	75	83
6	qy	113/114 (99%)	112 (99%)	1 (1%)	75	83
All	All	127246/151944 (84%)	126856 (100%)	390 (0%)	90	92

All (390) residues with a non-rotameric sidechain are listed below:

Mol	Chain	Res	Type
1	af	68	ARG
2	ag	271	ARG
2	ai	260	ARG
2	al	187	ARG
2	al	255	ARG
1	an	60	ARG
1	at	68	ARG
2	au	271	ARG
2	av	260	ARG
2	ay	187	ARG
2	ay	255	ARG
1	aA	60	ARG
1	aG	68	ARG
2	aH	271	ARG
2	aJ	260	ARG
2	aM	187	ARG
2	aM	255	ARG
1	aO	60	ARG
1	aU	68	ARG
2	aV	271	ARG
2	aX	260	ARG
2	ba	187	ARG
2	ba	255	ARG
1	bc	60	ARG
1	bi	68	ARG
2	bj	271	ARG

Continued on next page...

Continued from previous page...

Mol	Chain	Res	Type
2	bl	260	ARG
2	bo	187	ARG
2	bo	255	ARG
1	bq	60	ARG
1	bw	68	ARG
2	bx	271	ARG
2	bz	260	ARG
2	bC	187	ARG
2	bC	255	ARG
1	bE	60	ARG
1	bK	68	ARG
2	bL	271	ARG
2	bM	260	ARG
2	bP	187	ARG
2	bP	255	ARG
1	bR	60	ARG
1	bX	68	ARG
2	bY	271	ARG
2	ca	260	ARG
2	cd	187	ARG
2	cd	255	ARG
1	cf	60	ARG
1	cl	68	ARG
2	cm	271	ARG
2	co	260	ARG
2	cr	187	ARG
2	cr	255	ARG
1	ct	60	ARG
1	cz	68	ARG
2	cA	271	ARG
2	cC	260	ARG
2	cF	187	ARG
2	cF	255	ARG
1	cH	60	ARG
1	cN	68	ARG
2	cO	271	ARG
2	cQ	260	ARG
2	cT	187	ARG
2	cT	255	ARG
1	cV	60	ARG
1	db	68	ARG
2	dc	271	ARG

Continued on next page...

Continued from previous page...

Mol	Chain	Res	Type
2	de	260	ARG
2	dh	187	ARG
2	dh	255	ARG
1	dj	60	ARG
1	dp	68	ARG
2	dq	271	ARG
2	ds	260	ARG
2	dv	187	ARG
2	dv	255	ARG
1	dx	60	ARG
1	dD	68	ARG
2	dE	271	ARG
2	dG	260	ARG
2	dJ	187	ARG
2	dJ	255	ARG
1	dL	60	ARG
1	dR	68	ARG
2	dS	271	ARG
2	dU	260	ARG
2	dX	187	ARG
2	dX	255	ARG
1	dZ	60	ARG
1	ef	68	ARG
2	eg	271	ARG
2	ei	260	ARG
2	el	187	ARG
2	el	255	ARG
1	en	60	ARG
1	et	68	ARG
2	eu	271	ARG
2	ew	260	ARG
2	ez	187	ARG
2	ez	255	ARG
1	eB	60	ARG
1	eH	68	ARG
2	eI	271	ARG
2	eK	260	ARG
2	eN	187	ARG
2	eN	255	ARG
1	eP	60	ARG
1	eV	68	ARG
2	eW	271	ARG

Continued on next page...

Continued from previous page...

Mol	Chain	Res	Type
2	eY	260	ARG
2	fb	187	ARG
2	fb	255	ARG
1	fd	60	ARG
1	fj	68	ARG
2	fk	271	ARG
2	fm	260	ARG
2	fp	187	ARG
2	fp	255	ARG
1	fr	60	ARG
1	fx	68	ARG
2	fy	271	ARG
2	fA	260	ARG
2	fD	187	ARG
2	fD	255	ARG
1	fF	60	ARG
1	fL	68	ARG
2	fM	271	ARG
2	fO	260	ARG
2	fR	187	ARG
2	fR	255	ARG
1	fT	60	ARG
1	fZ	68	ARG
2	ga	271	ARG
2	gc	260	ARG
2	gf	187	ARG
2	gf	255	ARG
1	gh	60	ARG
1	gn	68	ARG
2	go	271	ARG
2	gq	260	ARG
2	gt	187	ARG
2	gt	255	ARG
1	gv	60	ARG
1	gB	68	ARG
2	gC	271	ARG
2	gE	260	ARG
2	gH	187	ARG
2	gH	255	ARG
1	gJ	60	ARG
1	gP	68	ARG
2	gQ	271	ARG

Continued on next page...

Continued from previous page...

Mol	Chain	Res	Type
2	gS	260	ARG
2	gV	187	ARG
2	gV	255	ARG
1	gX	60	ARG
1	hd	68	ARG
2	he	271	ARG
2	hg	260	ARG
2	hj	187	ARG
2	hj	255	ARG
1	hl	60	ARG
1	hr	68	ARG
2	hs	271	ARG
2	ht	260	ARG
2	hw	187	ARG
2	hw	255	ARG
1	hy	60	ARG
1	hE	68	ARG
2	hF	271	ARG
2	hG	260	ARG
2	hJ	187	ARG
2	hJ	255	ARG
1	hL	60	ARG
1	hR	68	ARG
2	hS	271	ARG
2	hU	260	ARG
2	hX	187	ARG
2	hX	255	ARG
1	hZ	60	ARG
1	if	68	ARG
2	ig	271	ARG
2	ii	260	ARG
2	il	187	ARG
2	il	255	ARG
1	in	60	ARG
1	it	68	ARG
2	iu	271	ARG
2	iw	260	ARG
2	iz	187	ARG
2	iz	255	ARG
1	iB	60	ARG
1	iH	68	ARG
2	iI	271	ARG

Continued on next page...

Continued from previous page...

Mol	Chain	Res	Type
2	iK	260	ARG
2	iN	187	ARG
2	iN	255	ARG
1	iP	60	ARG
1	iV	68	ARG
2	iW	271	ARG
2	iY	260	ARG
2	jb	187	ARG
2	jb	255	ARG
1	jd	60	ARG
1	jj	68	ARG
2	jk	271	ARG
2	jm	260	ARG
2	jp	187	ARG
2	jp	255	ARG
1	jr	60	ARG
1	jx	68	ARG
2	jy	271	ARG
2	jA	260	ARG
2	jD	187	ARG
2	jD	255	ARG
1	jF	60	ARG
1	jL	68	ARG
2	jM	271	ARG
2	jO	260	ARG
2	jR	187	ARG
2	jR	255	ARG
1	jT	60	ARG
1	jZ	68	ARG
2	ka	271	ARG
2	kc	260	ARG
2	kf	187	ARG
2	kf	255	ARG
1	kh	60	ARG
1	kn	68	ARG
2	ko	271	ARG
2	kp	260	ARG
2	ks	187	ARG
2	ks	255	ARG
1	ku	60	ARG
1	kA	68	ARG
2	kB	271	ARG

Continued on next page...

Continued from previous page...

Mol	Chain	Res	Type
2	kD	260	ARG
2	kG	187	ARG
2	kG	255	ARG
1	kI	60	ARG
1	kO	68	ARG
2	kP	271	ARG
2	kR	260	ARG
2	kU	187	ARG
2	kU	255	ARG
1	kW	60	ARG
1	lc	68	ARG
2	ld	271	ARG
2	lf	260	ARG
2	li	187	ARG
2	li	255	ARG
1	lk	60	ARG
1	lq	68	ARG
2	lr	271	ARG
2	lt	260	ARG
2	lw	187	ARG
2	lw	255	ARG
1	ly	60	ARG
1	lE	68	ARG
2	lF	271	ARG
2	lH	260	ARG
2	lK	187	ARG
2	lK	255	ARG
1	lM	60	ARG
1	lS	68	ARG
2	lT	271	ARG
2	lV	260	ARG
2	lY	187	ARG
2	lY	255	ARG
1	ma	60	ARG
1	mg	68	ARG
2	mh	271	ARG
2	mj	260	ARG
2	mm	187	ARG
2	mm	255	ARG
1	mo	60	ARG
1	mu	68	ARG
2	mv	271	ARG

Continued on next page...

Continued from previous page...

Mol	Chain	Res	Type
2	mx	260	ARG
2	mA	187	ARG
2	mA	255	ARG
1	mC	60	ARG
1	mI	68	ARG
2	mJ	271	ARG
2	mL	260	ARG
2	mO	187	ARG
2	mO	255	ARG
1	mQ	60	ARG
1	mW	68	ARG
2	mX	271	ARG
2	mZ	260	ARG
2	nc	187	ARG
2	nc	255	ARG
1	ne	60	ARG
1	nk	68	ARG
2	nl	271	ARG
2	nn	260	ARG
2	nq	187	ARG
2	nq	255	ARG
1	ns	60	ARG
1	ny	68	ARG
2	nz	271	ARG
2	nB	260	ARG
2	nE	187	ARG
2	nE	255	ARG
1	nG	60	ARG
1	nM	68	ARG
2	nN	271	ARG
2	nP	260	ARG
2	nS	187	ARG
2	nS	255	ARG
1	nU	60	ARG
1	oa	68	ARG
2	ob	271	ARG
2	od	260	ARG
2	og	187	ARG
2	og	255	ARG
1	oi	60	ARG
1	oo	68	ARG
2	op	271	ARG

Continued on next page...

Continued from previous page...

Mol	Chain	Res	Type
2	or	260	ARG
2	ou	187	ARG
2	ou	255	ARG
1	ow	60	ARG
1	oC	68	ARG
2	oD	271	ARG
2	oF	260	ARG
2	oI	187	ARG
2	oI	255	ARG
1	oK	60	ARG
1	oQ	68	ARG
2	oR	271	ARG
2	oT	260	ARG
2	oW	187	ARG
2	oW	255	ARG
1	oY	60	ARG
1	pe	68	ARG
2	pf	271	ARG
2	ph	260	ARG
2	pk	187	ARG
2	pk	255	ARG
1	pm	60	ARG
1	ps	68	ARG
2	pt	271	ARG
2	pv	260	ARG
2	py	187	ARG
2	py	255	ARG
1	pA	60	ARG
1	pG	68	ARG
2	pH	271	ARG
2	pJ	260	ARG
2	pM	187	ARG
2	pM	255	ARG
1	pO	60	ARG
1	pU	68	ARG
2	pV	271	ARG
2	pX	260	ARG
2	qa	187	ARG
2	qa	255	ARG
1	qc	60	ARG
4	qj	87	LYS
4	qk	87	LYS

Continued on next page...

Continued from previous page...

Mol	Chain	Res	Type
4	ql	87	LYS
4	qm	87	LYS
4	qn	87	LYS
4	qo	87	LYS
5	qp	235	ARG
6	qq	131	ARG
5	qr	235	ARG
6	qs	131	ARG
5	qt	235	ARG
6	qu	131	ARG
5	qv	235	ARG
6	qw	131	ARG
5	qx	235	ARG
6	qy	131	ARG
5	qz	235	ARG
6	qA	131	ARG
5	qB	235	ARG
6	qC	131	ARG
5	qD	235	ARG
6	qE	131	ARG
5	qF	235	ARG
6	qG	131	ARG
5	qH	235	ARG
6	qI	131	ARG
5	qJ	235	ARG
6	qK	131	ARG
5	qL	235	ARG
6	qM	131	ARG

Sometimes sidechains can be flipped to improve hydrogen bonding and reduce clashes. All (569) such sidechains are listed below:

Mol	Chain	Res	Type
2	ag	238	ASN
2	ai	235	ASN
2	ai	238	ASN
2	ak	62	GLN
2	ak	235	ASN
2	al	235	ASN
2	am	235	ASN
2	am	291	ASN
2	au	238	ASN
2	av	17	GLN

Continued on next page...

Continued from previous page...

Mol	Chain	Res	Type
2	av	235	ASN
2	av	238	ASN
2	ax	62	GLN
2	ax	235	ASN
2	ay	235	ASN
2	az	235	ASN
2	az	291	ASN
2	aH	238	ASN
2	aJ	17	GLN
2	aJ	235	ASN
2	aJ	238	ASN
2	aL	62	GLN
2	aL	128	ASN
2	aL	235	ASN
2	aM	235	ASN
2	aN	235	ASN
2	aN	291	ASN
2	aV	238	ASN
2	aX	235	ASN
2	aZ	62	GLN
2	aZ	128	ASN
2	aZ	235	ASN
2	ba	235	ASN
2	bj	238	ASN
2	bl	17	GLN
2	bl	235	ASN
2	bn	62	GLN
2	bn	235	ASN
2	bo	235	ASN
2	bp	235	ASN
2	bp	291	ASN
2	bx	238	ASN
2	bz	17	GLN
2	bz	235	ASN
2	bz	238	ASN
2	bB	62	GLN
2	bB	128	ASN
2	bB	235	ASN
2	bC	235	ASN
2	bD	235	ASN
2	bD	291	ASN
2	bL	238	ASN

Continued on next page...

Continued from previous page...

Mol	Chain	Res	Type
2	bM	235	ASN
2	bM	238	ASN
2	bO	62	GLN
2	bO	128	ASN
2	bO	235	ASN
2	bP	235	ASN
2	bQ	235	ASN
2	bQ	291	ASN
2	bY	238	ASN
2	ca	235	ASN
2	ca	238	ASN
2	cc	62	GLN
2	cc	235	ASN
2	cd	235	ASN
2	ce	235	ASN
2	ce	291	ASN
2	cm	238	ASN
2	co	235	ASN
2	co	238	ASN
2	cq	62	GLN
2	cq	128	ASN
2	cq	235	ASN
2	cr	235	ASN
2	cs	235	ASN
2	cs	291	ASN
2	cA	238	ASN
2	cC	235	ASN
2	cC	238	ASN
2	cE	62	GLN
2	cE	235	ASN
2	cF	235	ASN
2	cG	235	ASN
2	cG	291	ASN
2	cO	238	ASN
2	cQ	235	ASN
2	cQ	238	ASN
2	cS	62	GLN
2	cS	235	ASN
2	cT	235	ASN
2	cT	296	GLN
2	dc	238	ASN
2	de	235	ASN

Continued on next page...

Continued from previous page...

Mol	Chain	Res	Type
2	de	238	ASN
2	dg	62	GLN
2	dg	128	ASN
2	dg	235	ASN
2	dh	235	ASN
2	di	235	ASN
2	di	291	ASN
2	dq	238	ASN
2	ds	235	ASN
2	ds	238	ASN
2	du	62	GLN
2	du	128	ASN
2	du	235	ASN
2	dv	235	ASN
2	dw	235	ASN
2	dw	291	ASN
2	dE	238	ASN
2	dG	235	ASN
2	dG	238	ASN
2	dI	62	GLN
2	dI	128	ASN
2	dI	235	ASN
2	dJ	235	ASN
2	dK	235	ASN
2	dK	291	ASN
2	dS	238	ASN
2	dU	235	ASN
2	dW	62	GLN
2	dW	235	ASN
2	dX	235	ASN
2	dY	235	ASN
2	dY	291	ASN
2	eg	238	ASN
2	ei	235	ASN
2	ei	238	ASN
2	ek	62	GLN
2	ek	128	ASN
2	ek	235	ASN
2	el	235	ASN
2	em	235	ASN
2	em	291	ASN
2	eu	238	ASN

Continued on next page...

Continued from previous page...

Mol	Chain	Res	Type
2	ew	17	GLN
2	ew	235	ASN
2	ey	62	GLN
2	ey	235	ASN
2	ez	235	ASN
2	eA	235	ASN
2	eA	291	ASN
2	eI	238	ASN
2	eK	17	GLN
2	eK	235	ASN
2	eK	238	ASN
2	eM	62	GLN
2	eM	235	ASN
2	eN	235	ASN
2	eO	235	ASN
2	eO	291	ASN
2	eW	238	ASN
2	eY	235	ASN
2	eY	238	ASN
2	fa	62	GLN
2	fa	235	ASN
2	fb	235	ASN
2	fc	235	ASN
2	fc	291	ASN
2	fk	238	ASN
2	fm	235	ASN
2	fo	62	GLN
2	fo	235	ASN
2	fp	235	ASN
2	fq	235	ASN
2	fq	291	ASN
2	fy	238	ASN
2	fA	235	ASN
2	fA	238	ASN
2	fC	62	GLN
2	fC	235	ASN
2	fD	235	ASN
2	fM	238	ASN
2	fO	235	ASN
2	fO	238	ASN
2	fQ	62	GLN
2	fQ	235	ASN

Continued on next page...

Continued from previous page...

Mol	Chain	Res	Type
2	fR	235	ASN
2	fS	235	ASN
2	fS	291	ASN
2	ga	238	ASN
2	gc	235	ASN
2	ge	62	GLN
2	ge	235	ASN
2	gf	235	ASN
2	gg	235	ASN
2	gg	291	ASN
2	go	238	ASN
2	gq	235	ASN
2	gq	238	ASN
2	gs	62	GLN
2	gs	128	ASN
2	gs	235	ASN
2	gt	235	ASN
2	gu	235	ASN
2	gu	291	ASN
2	gC	238	ASN
2	gE	235	ASN
2	gE	238	ASN
2	gG	62	GLN
2	gG	235	ASN
2	gH	235	ASN
2	gI	235	ASN
2	gI	291	ASN
2	gQ	238	ASN
2	gS	17	GLN
2	gS	235	ASN
2	gU	62	GLN
2	gU	128	ASN
2	gU	235	ASN
2	gV	235	ASN
2	gW	235	ASN
2	gW	291	ASN
2	he	238	ASN
2	hg	235	ASN
2	hg	238	ASN
2	hi	62	GLN
2	hi	235	ASN
2	hj	235	ASN

Continued on next page...

Continued from previous page...

Mol	Chain	Res	Type
2	hk	235	ASN
2	hk	291	ASN
2	hs	104	GLN
2	hs	238	ASN
2	ht	17	GLN
2	ht	235	ASN
2	ht	238	ASN
2	hv	62	GLN
2	hv	128	ASN
2	hv	235	ASN
2	hw	235	ASN
2	hx	235	ASN
2	hx	291	ASN
2	hF	238	ASN
2	hG	235	ASN
2	hG	238	ASN
2	hI	62	GLN
2	hI	128	ASN
2	hI	235	ASN
2	hJ	235	ASN
2	hK	95	ASN
2	hS	238	ASN
2	hU	235	ASN
2	hU	238	ASN
2	hW	62	GLN
2	hW	235	ASN
2	hX	235	ASN
2	hY	235	ASN
2	hY	291	ASN
2	ig	238	ASN
2	ii	235	ASN
2	ii	238	ASN
2	ik	17	GLN
2	ik	62	GLN
2	ik	128	ASN
2	ik	235	ASN
2	il	235	ASN
2	im	235	ASN
2	im	291	ASN
2	iu	238	ASN
2	iw	17	GLN
2	iw	235	ASN

Continued on next page...

Continued from previous page...

Mol	Chain	Res	Type
2	iw	238	ASN
2	iy	62	GLN
2	iy	235	ASN
2	iz	235	ASN
2	iA	235	ASN
2	iA	291	ASN
2	iI	238	ASN
2	iK	235	ASN
2	iK	238	ASN
2	iM	62	GLN
2	iM	128	ASN
2	iM	235	ASN
2	iN	235	ASN
2	iO	235	ASN
2	iO	291	ASN
2	iW	238	ASN
2	iY	235	ASN
2	iY	238	ASN
2	ja	62	GLN
2	ja	128	ASN
2	ja	235	ASN
2	jb	235	ASN
2	jc	235	ASN
2	jc	291	ASN
2	jk	238	ASN
2	jm	235	ASN
2	jo	62	GLN
2	jo	235	ASN
2	jp	235	ASN
2	jq	235	ASN
2	jq	291	ASN
2	jy	238	ASN
2	jA	235	ASN
2	jC	62	GLN
2	jC	128	ASN
2	jC	235	ASN
2	jD	235	ASN
2	jE	235	ASN
2	jE	291	ASN
2	jM	238	ASN
2	jO	235	ASN
2	jO	238	ASN

Continued on next page...

Continued from previous page...

Mol	Chain	Res	Type
2	jQ	62	GLN
2	jQ	128	ASN
2	jQ	235	ASN
2	jR	235	ASN
2	jR	296	GLN
2	jS	235	ASN
2	jS	291	ASN
2	ka	238	ASN
2	kc	235	ASN
2	kc	238	ASN
2	ke	62	GLN
2	ke	128	ASN
2	ke	235	ASN
2	kf	235	ASN
2	kg	235	ASN
2	kg	291	ASN
2	ko	104	GLN
2	ko	238	ASN
2	kp	17	GLN
2	kp	235	ASN
2	kr	62	GLN
2	kr	235	ASN
2	ks	235	ASN
2	kt	235	ASN
2	kt	291	ASN
2	kB	238	ASN
2	kD	235	ASN
2	kD	238	ASN
2	kF	62	GLN
2	kF	128	ASN
2	kF	235	ASN
2	kG	235	ASN
2	kH	235	ASN
2	kH	291	ASN
2	kP	238	ASN
2	kR	235	ASN
2	kR	238	ASN
2	kT	62	GLN
2	kT	235	ASN
2	kU	235	ASN
2	kV	235	ASN
2	kV	291	ASN

Continued on next page...

Continued from previous page...

Mol	Chain	Res	Type
2	ld	238	ASN
2	lf	17	GLN
2	lf	235	ASN
2	lf	238	ASN
2	lh	62	GLN
2	lh	235	ASN
2	li	235	ASN
2	lj	235	ASN
2	lj	291	ASN
2	lr	238	ASN
2	ls	235	ASN
2	lt	17	GLN
2	lt	235	ASN
2	lt	238	ASN
2	lv	62	GLN
2	lv	235	ASN
2	lw	235	ASN
2	lx	235	ASN
2	lx	291	ASN
2	lF	238	ASN
2	lH	235	ASN
2	lH	238	ASN
2	lJ	62	GLN
2	lJ	235	ASN
2	lK	235	ASN
2	lL	235	ASN
2	lL	291	ASN
2	lT	238	ASN
2	lV	235	ASN
2	lV	238	ASN
2	lX	62	GLN
2	lX	235	ASN
2	lY	235	ASN
2	lZ	235	ASN
2	lZ	291	ASN
2	mh	238	ASN
2	mj	235	ASN
2	mj	238	ASN
2	ml	62	GLN
2	ml	235	ASN
2	mm	235	ASN
2	mn	235	ASN

Continued on next page...

Continued from previous page...

Mol	Chain	Res	Type
2	mn	291	ASN
2	mv	238	ASN
2	mx	235	ASN
2	mz	62	GLN
2	mz	128	ASN
2	mz	235	ASN
2	mA	235	ASN
2	mJ	238	ASN
2	mL	235	ASN
2	mL	238	ASN
2	mN	62	GLN
2	mN	235	ASN
2	mO	235	ASN
2	mP	235	ASN
2	mP	291	ASN
2	mX	238	ASN
2	mZ	235	ASN
2	mZ	238	ASN
2	nb	62	GLN
2	nb	235	ASN
2	nc	235	ASN
2	nd	235	ASN
2	nd	291	ASN
2	nl	238	ASN
2	nn	235	ASN
2	nn	238	ASN
2	np	62	GLN
2	np	235	ASN
2	nq	235	ASN
2	nr	235	ASN
2	nr	291	ASN
2	nz	238	ASN
2	nB	235	ASN
2	nB	238	ASN
2	nD	62	GLN
2	nD	128	ASN
2	nD	235	ASN
2	nE	235	ASN
2	nF	235	ASN
2	nF	291	ASN
2	nN	238	ASN
2	nP	17	GLN

Continued on next page...

Continued from previous page...

Mol	Chain	Res	Type
2	nP	235	ASN
2	nP	238	ASN
2	nR	62	GLN
2	nR	235	ASN
2	nS	235	ASN
2	ob	238	ASN
2	od	17	GLN
2	od	235	ASN
2	od	238	ASN
2	of	62	GLN
2	of	235	ASN
2	og	235	ASN
2	oh	235	ASN
2	oh	291	ASN
2	op	238	ASN
2	or	235	ASN
2	or	238	ASN
2	ot	62	GLN
2	ot	128	ASN
2	ot	235	ASN
2	ou	235	ASN
2	ov	235	ASN
2	ov	291	ASN
2	oD	238	ASN
2	oF	235	ASN
2	oF	238	ASN
2	oH	62	GLN
2	oH	235	ASN
2	oI	235	ASN
2	oJ	235	ASN
2	oJ	291	ASN
2	oR	238	ASN
2	oT	235	ASN
2	oT	238	ASN
2	oV	62	GLN
2	oV	128	ASN
2	oV	235	ASN
2	oW	235	ASN
2	oX	235	ASN
2	oX	291	ASN
2	pf	238	ASN
2	ph	17	GLN

Continued on next page...

Continued from previous page...

Mol	Chain	Res	Type
2	ph	235	ASN
2	pj	62	GLN
2	pj	235	ASN
2	pk	235	ASN
2	pl	235	ASN
2	pl	291	ASN
2	pt	238	ASN
2	pV	17	GLN
2	pV	235	ASN
2	pV	238	ASN
2	px	17	GLN
2	px	62	GLN
2	px	128	ASN
2	px	235	ASN
2	py	235	ASN
2	pz	235	ASN
2	pz	291	ASN
2	pH	238	ASN
2	pJ	235	ASN
2	pJ	238	ASN
2	pL	62	GLN
2	pL	235	ASN
2	pM	235	ASN
2	pN	235	ASN
2	pN	291	ASN
2	pV	238	ASN
2	pX	235	ASN
2	pX	238	ASN
2	pZ	17	GLN
2	pZ	62	GLN
2	pZ	235	ASN
2	qa	235	ASN
2	qb	235	ASN
2	qb	291	ASN
3	qf	63	GLN
3	qg	63	GLN
4	qj	10	GLN
4	qj	223	ASN
4	qk	10	GLN
4	qk	223	ASN
4	ql	10	GLN
4	ql	223	ASN

Continued on next page...

Continued from previous page...

Mol	Chain	Res	Type
4	qm	10	GLN
4	qm	223	ASN
4	qn	10	GLN
4	qn	223	ASN
4	qo	10	GLN
4	qo	223	ASN
5	qp	34	GLN
5	qp	217	HIS
5	qp	323	HIS
6	qq	53	HIS
5	qr	176	ASN
5	qr	217	HIS
5	qr	323	HIS
6	qs	53	HIS
5	qt	54	GLN
5	qt	176	ASN
5	qt	217	HIS
5	qt	323	HIS
6	qu	53	HIS
5	qv	217	HIS
5	qv	323	HIS
6	qw	53	HIS
5	qx	54	GLN
5	qx	217	HIS
5	qx	323	HIS
6	qy	53	HIS
5	qz	34	GLN
5	qz	58	GLN
5	qz	176	ASN
5	qz	217	HIS
5	qz	323	HIS
6	qA	53	HIS
5	qB	162	GLN
5	qB	176	ASN
5	qB	217	HIS
5	qB	323	HIS
6	qC	53	HIS
5	qD	217	HIS
5	qD	323	HIS
6	qE	53	HIS
5	qF	176	ASN
5	qF	217	HIS

Continued on next page...

Continued from previous page...

Mol	Chain	Res	Type
5	qF	323	HIS
6	qG	53	HIS
5	qH	176	ASN
5	qH	217	HIS
5	qH	323	HIS
6	qI	53	HIS
5	qJ	217	HIS
5	qJ	323	HIS
6	qK	53	HIS
5	qL	54	GLN
5	qL	217	HIS
5	qL	323	HIS
6	qM	53	HIS

5.3.3 RNA [i](#)

There are no RNA molecules in this entry.

5.4 Non-standard residues in protein, DNA, RNA chains [i](#)

There are no non-standard protein/DNA/RNA residues in this entry.

5.5 Carbohydrates [i](#)

There are no oligosaccharides in this entry.

5.6 Ligand geometry [i](#)

There are no ligands in this entry.

5.7 Other polymers [i](#)

There are no such residues in this entry.

5.8 Polymer linkage issues [i](#)

There are no chain breaks in this entry.

6 Map visualisation [i](#)

This section contains visualisations of the EMDB entry EMD-19439. These allow visual inspection of the internal detail of the map and identification of artifacts.

No raw map or half-maps were deposited for this entry and therefore no images, graphs, etc. pertaining to the raw map can be shown.

6.1 Orthogonal projections [i](#)

6.1.1 Primary map

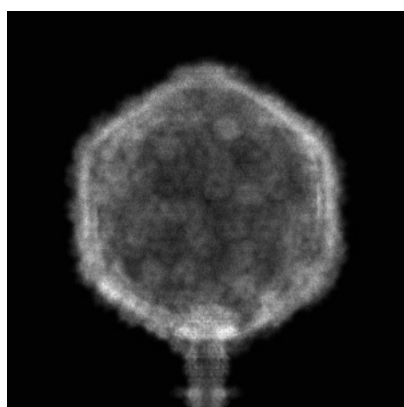

X

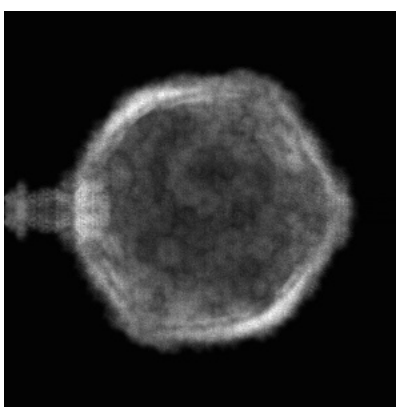

Y

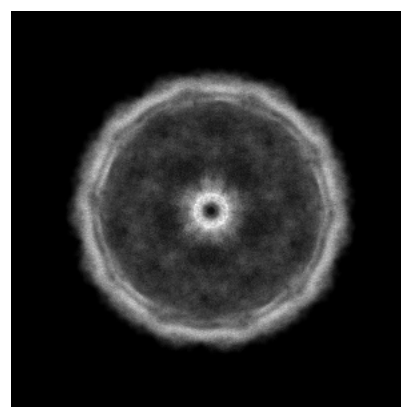

Z

The images above show the map projected in three orthogonal directions.

6.2 Central slices [i](#)

6.2.1 Primary map



X Index: 420

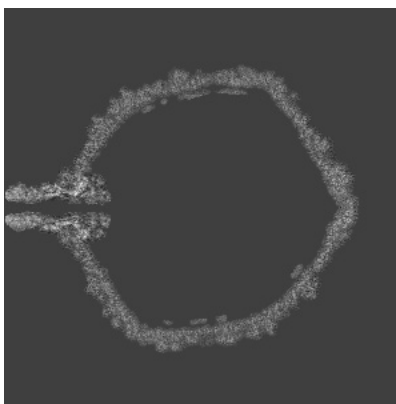

Y Index: 420

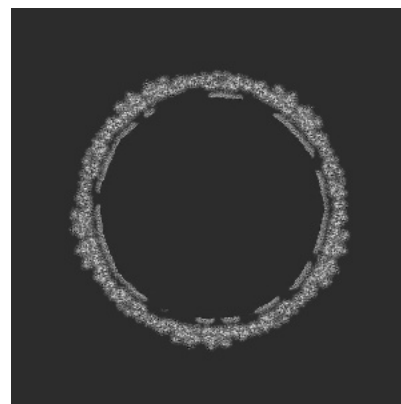

Z Index: 420

The images above show central slices of the map in three orthogonal directions.

6.3 Largest variance slices [\(i\)](#)

6.3.1 Primary map



X Index: 442

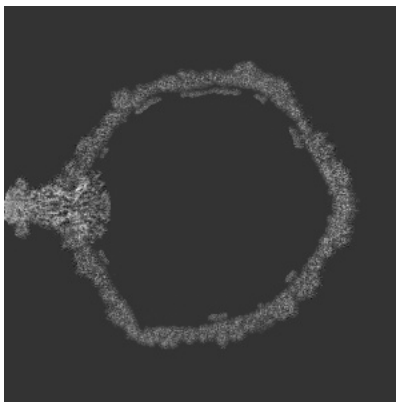

Y Index: 443

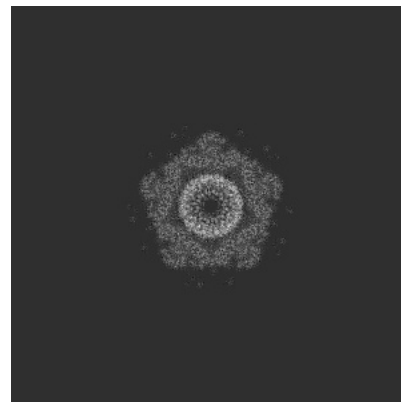

Z Index: 169

The images above show the largest variance slices of the map in three orthogonal directions.

6.4 Orthogonal standard-deviation projections (False-color) [\(i\)](#)

6.4.1 Primary map

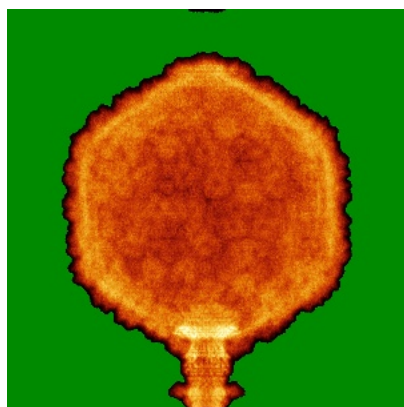

X

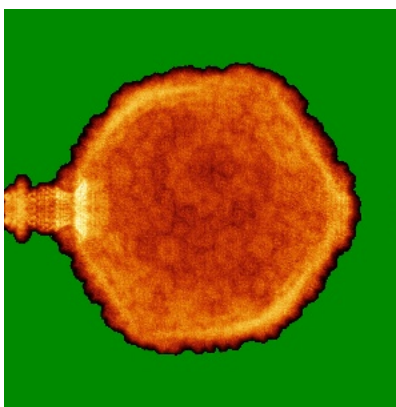

Y

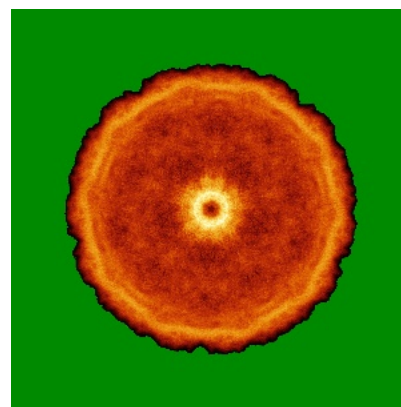

Z

The images above show the map standard deviation projections with false color in three orthogonal directions. Minimum values are shown in green, max in blue, and dark to light orange shades represent small to large values respectively.

6.5 Orthogonal surface views [i](#)

6.5.1 Primary map

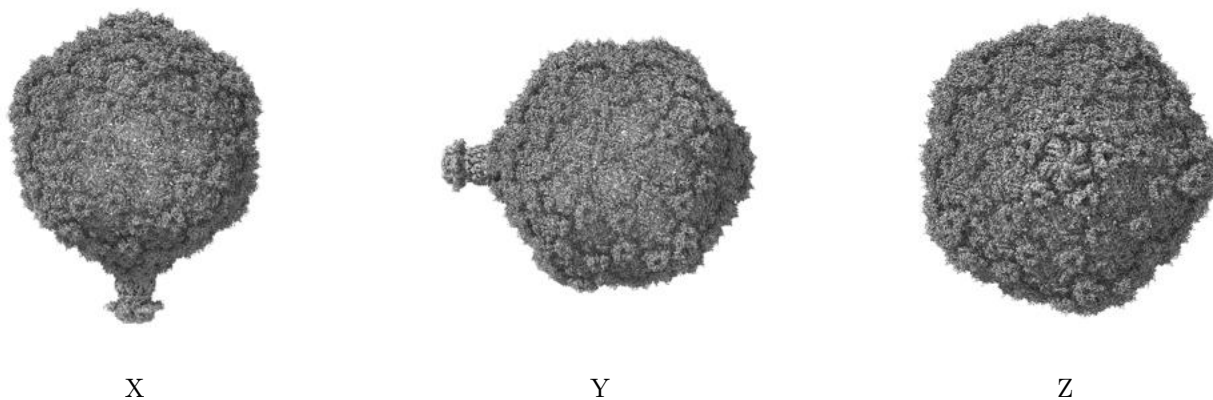

The images above show the 3D surface view of the map at the recommended contour level 0.013. These images, in conjunction with the slice images, may facilitate assessment of whether an appropriate contour level has been provided.

6.6 Mask visualisation [i](#)

This section was not generated. No masks/segmentation were deposited.

7 Map analysis [i](#)

This section contains the results of statistical analysis of the map.

7.1 Map-value distribution [i](#)

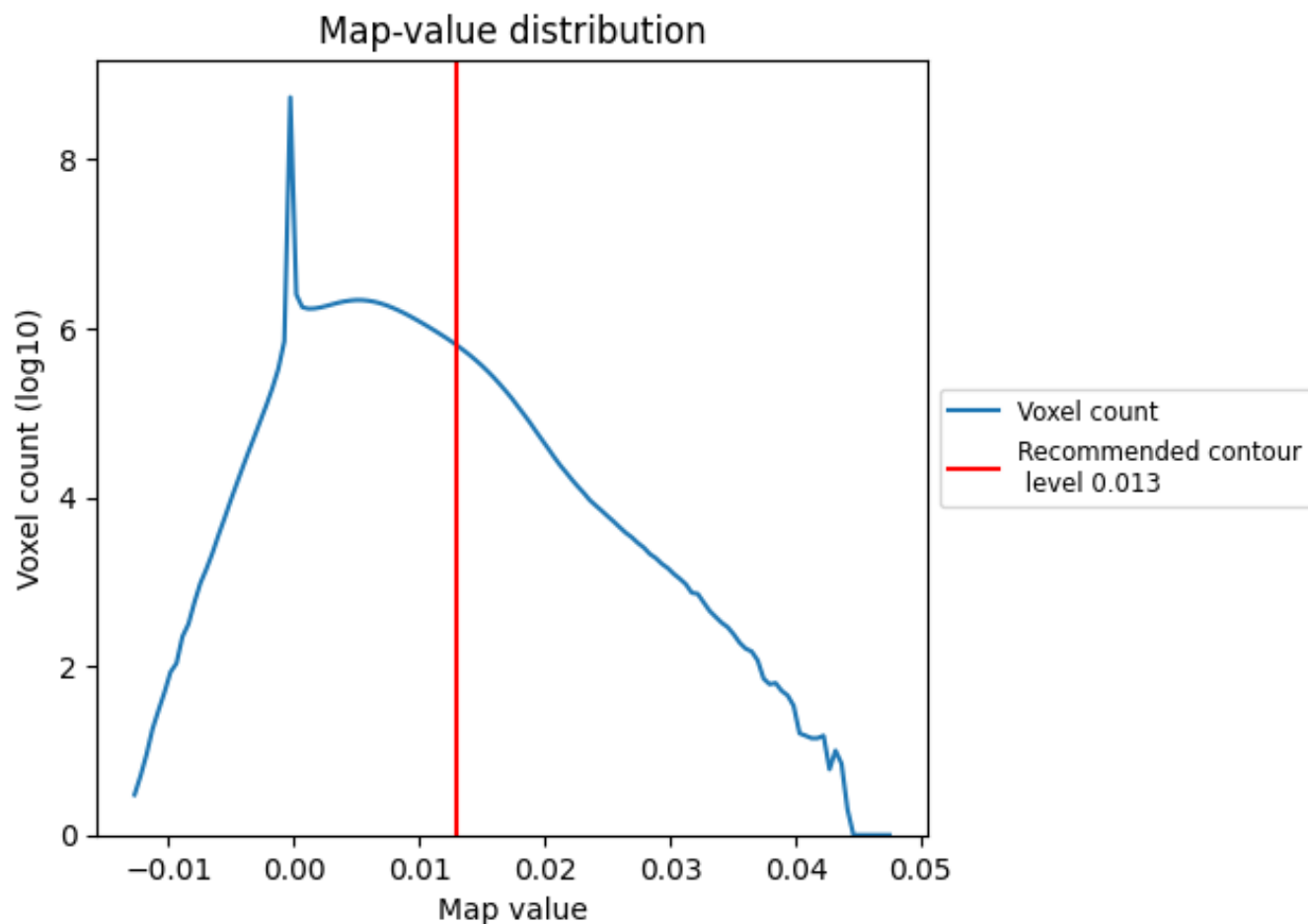

The map-value distribution is plotted in 128 intervals along the x-axis. The y-axis is logarithmic. A spike in this graph at zero usually indicates that the volume has been masked.

7.2 Volume estimate [\(i\)](#)

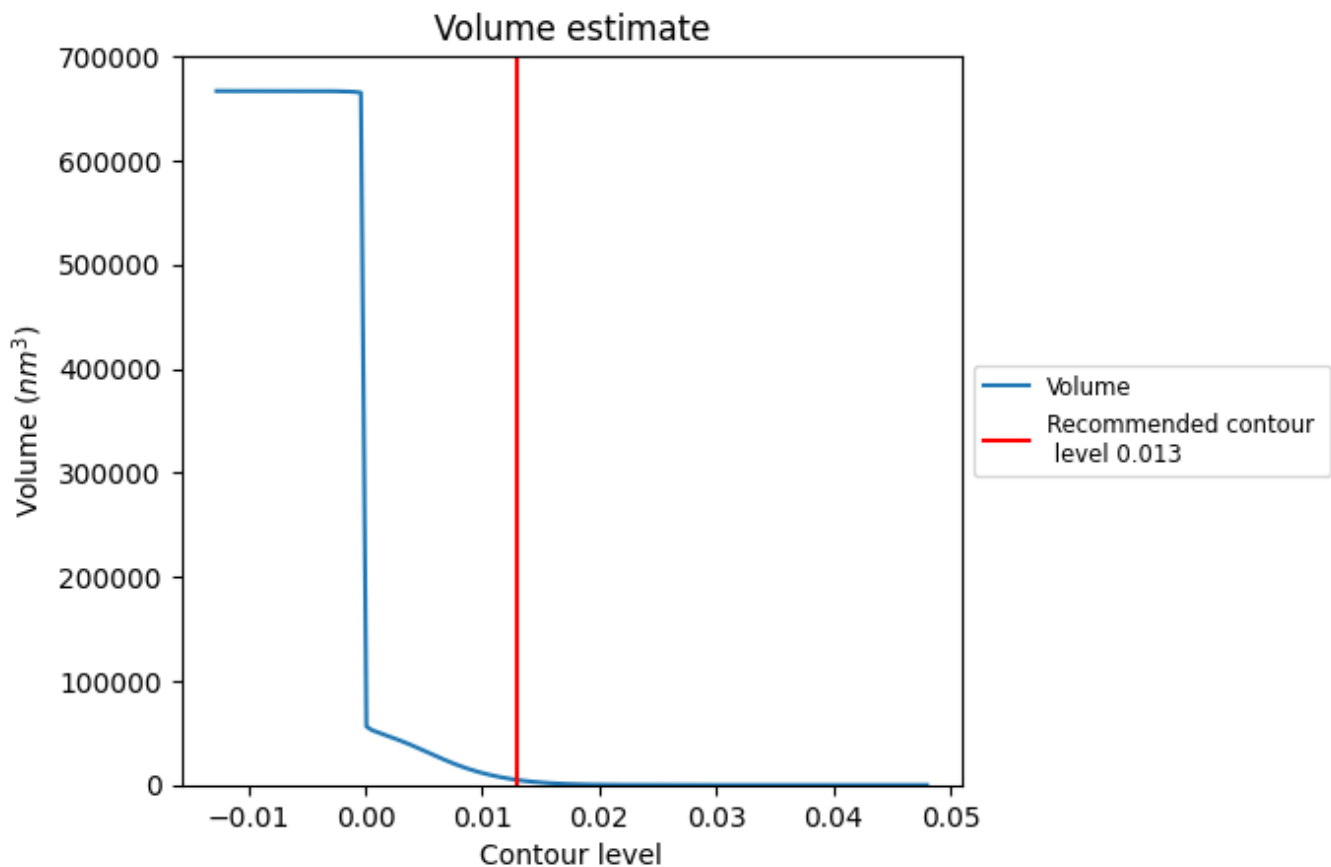

The volume at the recommended contour level is 4824 nm³; this corresponds to an approximate mass of 4358 kDa.

The volume estimate graph shows how the enclosed volume varies with the contour level. The recommended contour level is shown as a vertical line and the intersection between the line and the curve gives the volume of the enclosed surface at the given level.

7.3 Rotationally averaged power spectrum i

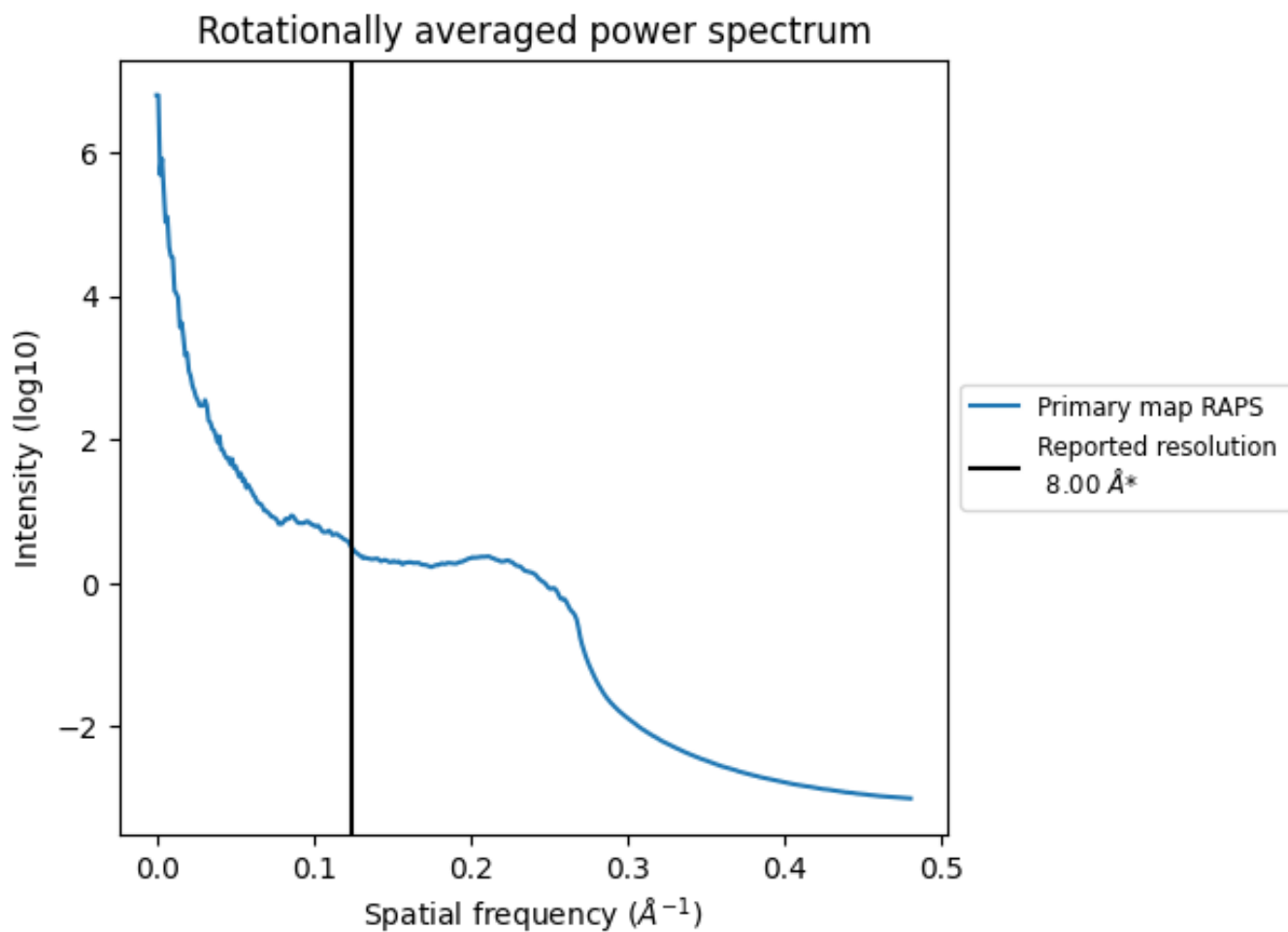

*Reported resolution corresponds to spatial frequency of 0.125 Å⁻¹

8 Fourier-Shell correlation

This section was not generated. No FSC curve or half-maps provided.

9 Map-model fit [i](#)

This section contains information regarding the fit between EMDB map EMD-19439 and PDB model 8RQE. Per-residue inclusion information can be found in section 3 on page 81.

9.1 Map-model overlay [i](#)

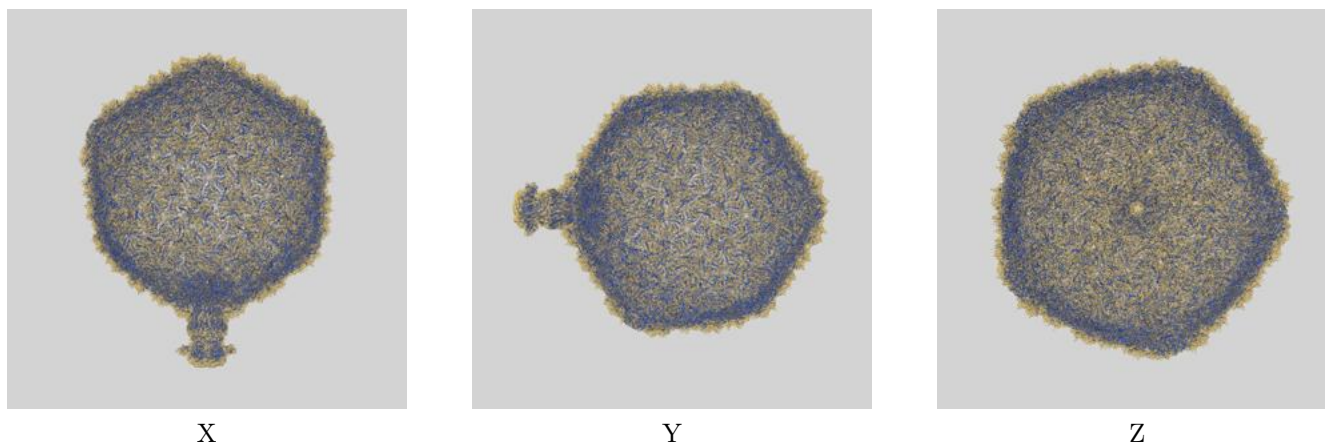

The images above show the 3D surface view of the map at the recommended contour level 0.013 at 50% transparency in yellow overlaid with a ribbon representation of the model coloured in blue. These images allow for the visual assessment of the quality of fit between the atomic model and the map.

9.2 Q-score mapped to coordinate model [\(i\)](#)

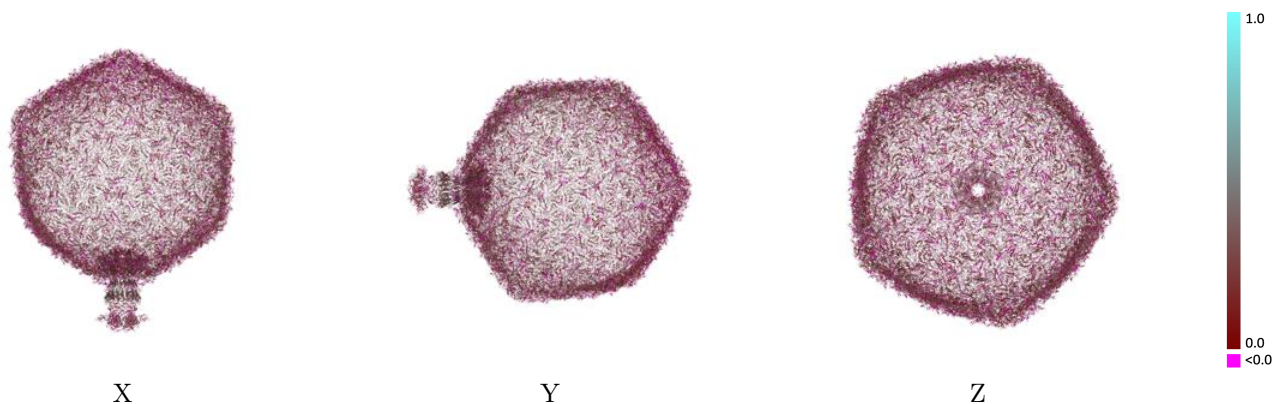

The images above show the model with each residue coloured according to its Q-score. This shows their resolvability in the map with higher Q-score values reflecting better resolvability. Please note: Q-score is calculating the resolvability of atoms, and thus high values are only expected at resolutions at which atoms can be resolved. Low Q-score values may therefore be expected for many entries.

9.3 Atom inclusion mapped to coordinate model [\(i\)](#)

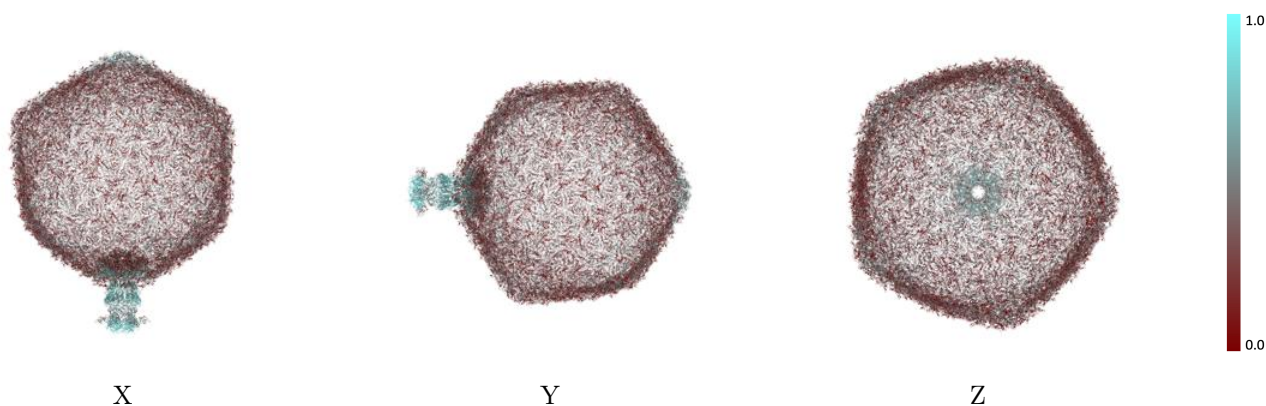

The images above show the model with each residue coloured according to its atom inclusion. This shows to what extent they are inside the map at the recommended contour level (0.013).

9.4 Atom inclusion [i](#)

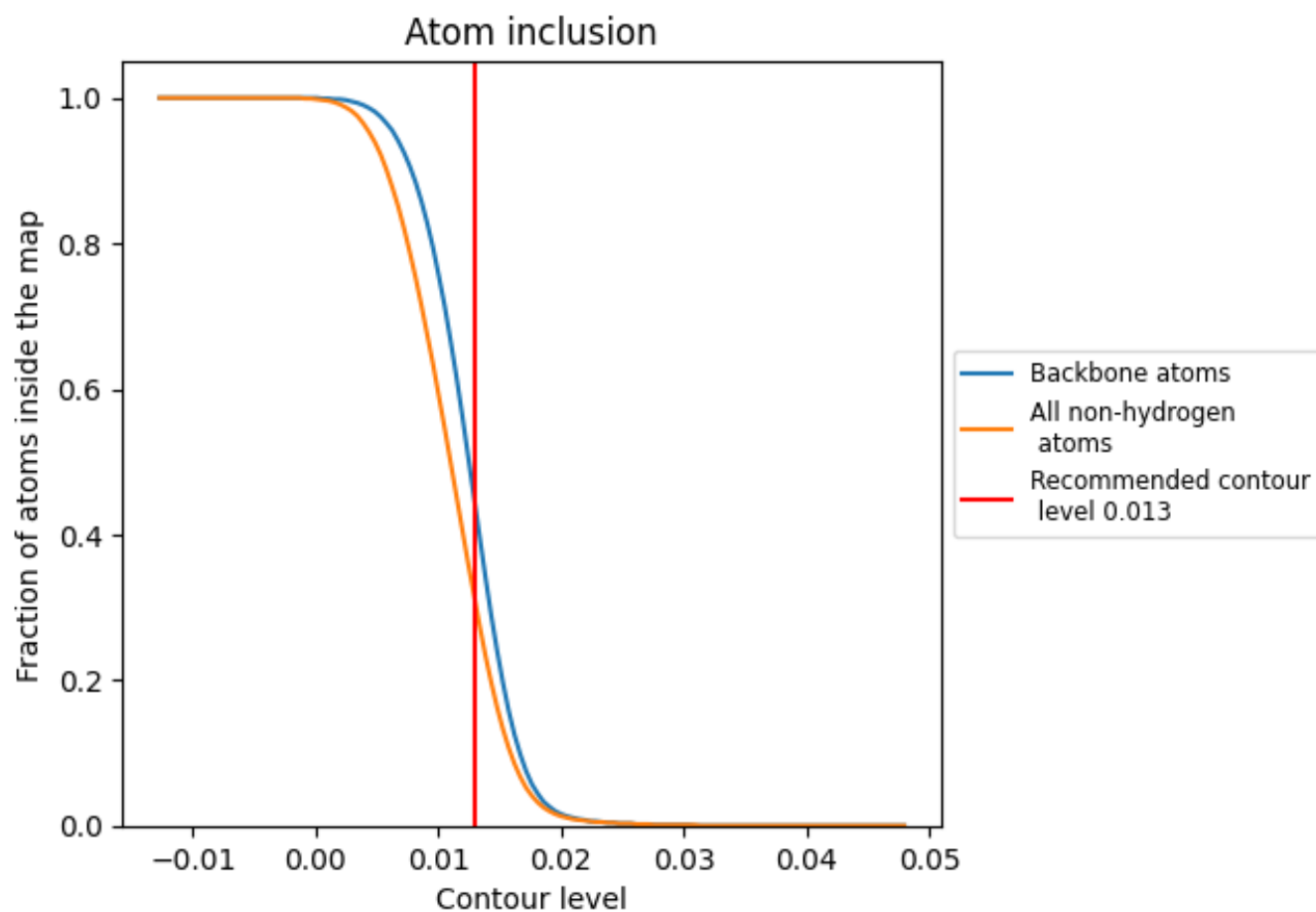

At the recommended contour level, 44% of all backbone atoms, 31% of all non-hydrogen atoms, are inside the map.

9.5 Map-model fit summary

The table lists the average atom inclusion at the recommended contour level (0.013) and Q-score for the entire model and for each chain.

Chain	Atom inclusion	Q-score
All	0.3090	0.2000
aA	0.1750	0.0600
aB	0.2550	0.1450
aC	0.2270	0.1090
aD	0.2510	0.1740
aE	0.2480	0.1390
aF	0.1820	0.0950
aG	0.1870	0.0800
aH	0.3500	0.2490
aI	0.3130	0.2190
aJ	0.3130	0.2360
aK	0.3090	0.2360
aL	0.3060	0.2340
aM	0.3270	0.2350
aN	0.3330	0.2410
aO	0.2360	0.1160
aP	0.2290	0.1080
aQ	0.1960	0.0970
aR	0.1920	0.0690
aS	0.2650	0.1500
aT	0.1580	0.1250
aU	0.2410	0.1050
aV	0.3210	0.2470
aW	0.3020	0.2160
aX	0.2670	0.2350
aY	0.2890	0.2380
aZ	0.2760	0.2530
aa	0.2620	0.1480
ab	0.2010	0.0910
ac	0.2740	0.1050
ad	0.3810	0.1150
ae	0.2320	0.1190
af	0.3950	0.0860
ag	0.3950	0.1530
ah	0.4960	0.1450



Continued on next page...

Continued from previous page...

Chain	Atom inclusion	Q-score
ai	0.2720	0.1590
aj	0.3170	0.1760
ak	0.2610	0.1530
al	0.3040	0.1530
am	0.3650	0.1390
an	0.3710	0.0980
ao	0.2460	0.1800
ap	0.2150	0.1400
aq	0.2250	0.1260
ar	0.1840	0.0720
as	0.2130	0.1390
at	0.1490	0.0160
au	0.4040	0.2070
av	0.2940	0.2130
aw	0.2700	0.2090
ax	0.2790	0.2110
ay	0.2980	0.2010
az	0.3460	0.1900
bA	0.2930	0.2410
bB	0.2670	0.2420
bC	0.2980	0.2430
bD	0.3020	0.2400
bE	0.2270	0.1130
bF	0.2580	0.1580
bG	0.1940	0.1320
bH	0.2340	0.1450
bI	0.2220	0.1080
bJ	0.2150	0.1390
bK	0.1610	0.0350
bL	0.3990	0.2200
bM	0.2740	0.2030
bN	0.2650	0.2050
bO	0.2790	0.2170
bP	0.2960	0.1990
bQ	0.3280	0.1870
bR	0.2150	0.0850
bS	0.2270	0.1310
bT	0.2130	0.1000
bU	0.2220	0.0940
bV	0.2550	0.1360
bW	0.2220	0.1350
bX	0.2430	0.1260

Continued on next page...

Continued from previous page...

Chain	Atom inclusion	Q-score
bY	0.3610	0.2460
bZ	0.2950	0.2330
ba	0.2700	0.2490
bb	0.2950	0.2460
bc	0.2360	0.1270
bd	0.2510	0.1370
be	0.1990	0.1110
bf	0.2170	0.1550
bg	0.2550	0.1190
bh	0.2060	0.0880
bi	0.2130	0.0730
bj	0.3340	0.2470
bk	0.3110	0.2140
bl	0.3010	0.2310
bm	0.2860	0.2370
bn	0.2840	0.2350
bo	0.3140	0.2360
bp	0.3190	0.2410
bq	0.2580	0.1090
br	0.2200	0.1130
bs	0.1890	0.0790
bt	0.1770	0.0690
bu	0.2270	0.1470
bv	0.1840	0.1210
bw	0.2270	0.1030
bx	0.3200	0.2410
by	0.2900	0.2150
bz	0.2720	0.2290
cA	0.3520	0.1900
cB	0.3400	0.1910
cC	0.2680	0.1480
cD	0.3130	0.2020
cE	0.2610	0.1700
cF	0.3020	0.1710
cG	0.3260	0.1890
cH	0.2910	0.1120
cI	0.2460	0.1040
cJ	0.2150	0.1090
cK	0.2530	0.0990
cL	0.2320	0.1000
cM	0.1940	0.0860
cN	0.2290	0.1290

Continued on next page...

Continued from previous page...

Chain	Atom inclusion	Q-score
cO	0.3080	0.2140
cP	0.3300	0.1970
cQ	0.2500	0.2040
cR	0.2770	0.2130
cS	0.2550	0.2220
cT	0.2840	0.1990
cU	0.3450	0.2130
cV	0.2390	0.1000
cW	0.1700	0.1100
cX	0.1990	0.0530
cY	0.2100	0.1100
cZ	0.2060	0.1500
ca	0.2830	0.2240
cb	0.3020	0.2320
cc	0.2940	0.2420
cd	0.3100	0.2290
ce	0.3280	0.2340
cf	0.2320	0.1130
cg	0.2390	0.1380
ch	0.1840	0.0880
ci	0.2410	0.1050
cj	0.2620	0.1380
ck	0.2130	0.1150
cl	0.2810	0.0830
cm	0.3780	0.2390
cn	0.3440	0.2130
co	0.2770	0.2360
cp	0.2800	0.2550
cq	0.2850	0.2510
cr	0.3110	0.2320
cs	0.3030	0.2210
ct	0.3050	0.1160
cu	0.2600	0.1320
cv	0.2060	0.1030
cw	0.2460	0.1390
cx	0.3290	0.1490
cy	0.2810	0.1200
cz	0.2720	0.0950
dA	0.2130	0.0820
dB	0.2650	0.1050
dC	0.1940	0.1260
dD	0.2410	0.1040

Continued on next page...

Continued from previous page...

Chain	Atom inclusion	Q-score
dE	0.3380	0.2340
dF	0.3510	0.2070
dG	0.2910	0.2350
dH	0.2830	0.2110
dI	0.2910	0.2280
dJ	0.3060	0.2290
dK	0.3400	0.2040
dL	0.2880	0.1240
dM	0.2740	0.1360
dN	0.2100	0.0860
dO	0.2670	0.1110
dP	0.3550	0.0930
dQ	0.2340	0.1220
dR	0.4090	0.0930
dS	0.4010	0.1590
dT	0.5120	0.1410
dU	0.2830	0.1610
dV	0.3240	0.1780
dW	0.2700	0.1710
dX	0.3350	0.1600
dY	0.3740	0.1470
dZ	0.3550	0.0890
da	0.1730	0.0700
db	0.2290	0.1510
dc	0.3410	0.2450
dd	0.2950	0.2120
de	0.2740	0.2290
df	0.2920	0.2390
dg	0.2800	0.2310
dh	0.2880	0.2400
di	0.3240	0.2300
dj	0.2060	0.1490
dk	0.2080	0.1340
dl	0.2010	0.1050
dm	0.2460	0.1210
dn	0.2620	0.1930
do	0.2390	0.1520
dp	0.2340	0.1310
dq	0.3410	0.2420
dr	0.3160	0.2220
ds	0.2720	0.2260
dt	0.3310	0.2350

Continued on next page...

Continued from previous page...

Chain	Atom inclusion	Q-score
du	0.2790	0.2100
dv	0.2970	0.2250
dw	0.3440	0.2330
dx	0.2840	0.1430
dy	0.2130	0.1620
dz	0.1730	0.1050
eA	0.3360	0.1860
eB	0.2390	0.1030
eC	0.2030	0.1210
eD	0.1660	0.1220
eE	0.2170	0.1030
eF	0.2770	0.1500
eG	0.2340	0.1490
eH	0.2010	0.1370
eI	0.3580	0.2550
eJ	0.2850	0.2270
eK	0.3080	0.2300
eL	0.3180	0.2390
eM	0.3100	0.2390
eN	0.3130	0.2280
eO	0.3290	0.2400
eP	0.1990	0.1100
eQ	0.2290	0.1210
eR	0.1960	0.0740
eS	0.2080	0.1080
eT	0.2580	0.1290
eU	0.2250	0.1100
eV	0.2550	0.0830
eW	0.3590	0.2350
eX	0.3700	0.2160
eY	0.2760	0.2430
eZ	0.2790	0.2480
ea	0.2910	0.1600
eb	0.1960	0.1030
ec	0.2460	0.1320
ed	0.2720	0.1710
ee	0.2650	0.1430
ef	0.2510	0.1150
eg	0.3150	0.1990
eh	0.3220	0.1880
ei	0.2880	0.2190
ej	0.2830	0.1940

Continued on next page...

Continued from previous page...

Chain	Atom inclusion	Q-score
ek	0.2750	0.1780
el	0.2770	0.2100
em	0.3140	0.1950
en	0.2550	0.1140
eo	0.2550	0.1310
ep	0.2100	0.1050
eq	0.2740	0.1370
er	0.2880	0.1260
es	0.2650	0.1160
et	0.2530	0.0940
eu	0.3320	0.1850
ev	0.3160	0.1890
ew	0.2710	0.1510
ex	0.3190	0.2030
ey	0.2690	0.1710
ez	0.2810	0.1680
fA	0.2470	0.1540
fB	0.2920	0.2020
fC	0.2530	0.1670
fD	0.2720	0.1690
fE	0.3030	0.1890
fF	0.2530	0.1060
fG	0.2250	0.1350
fH	0.1800	0.1320
fI	0.2220	0.1160
fJ	0.3030	0.1580
fK	0.2550	0.1670
fL	0.2950	0.1440
fM	0.3500	0.2510
fN	0.2840	0.2190
fO	0.2850	0.2410
fP	0.2860	0.2500
fQ	0.2680	0.2500
fR	0.2960	0.2320
fS	0.3310	0.2470
fT	0.2720	0.1130
fU	0.1990	0.1050
fV	0.2220	0.0670
fW	0.2550	0.1340
fX	0.2810	0.1640
fY	0.1990	0.1120
fZ	0.2670	0.1490

Continued on next page...

Continued from previous page...

Chain	Atom inclusion	Q-score
fa	0.2790	0.2510
fb	0.2960	0.2330
fc	0.3180	0.2230
fd	0.3050	0.1190
fe	0.2060	0.1510
ff	0.1800	0.0990
fg	0.2250	0.1110
fh	0.2250	0.1320
fi	0.2030	0.1360
fj	0.2360	0.1090
fk	0.3670	0.2260
fl	0.3320	0.2100
fm	0.2800	0.2430
fn	0.2760	0.2530
fo	0.2870	0.2430
fp	0.3150	0.2310
fq	0.3000	0.2210
fr	0.2410	0.1200
fs	0.2580	0.1390
ft	0.2060	0.1110
fu	0.2740	0.1620
fv	0.2840	0.1290
fw	0.2600	0.1150
fx	0.2670	0.0830
fy	0.2990	0.1740
fz	0.3120	0.1880
gA	0.1990	0.0860
gB	0.1940	0.1110
gC	0.3050	0.2140
gD	0.3140	0.1870
gE	0.2850	0.2090
gF	0.3020	0.2110
gG	0.2910	0.2240
gH	0.2930	0.1940
gI	0.3150	0.2120
gJ	0.1990	0.0980
gK	0.2810	0.1440
gL	0.2360	0.1100
gM	0.2390	0.1420
gN	0.2550	0.1210
gO	0.2060	0.0920
gP	0.2170	0.0740

Continued on next page...

Continued from previous page...

Chain	Atom inclusion	Q-score
gQ	0.3630	0.2390
gR	0.3320	0.2110
gS	0.3200	0.2420
gT	0.3030	0.2270
gU	0.2910	0.2230
gV	0.3350	0.2190
gW	0.3520	0.2340
gX	0.2790	0.1180
gY	0.2060	0.1510
gZ	0.2150	0.1510
ga	0.3130	0.2330
gb	0.3010	0.2100
gc	0.2790	0.2370
gd	0.2840	0.2460
ge	0.2670	0.2360
gf	0.2870	0.2370
gg	0.3020	0.2300
gh	0.2510	0.1260
gi	0.2010	0.1380
gj	0.2060	0.1070
gk	0.2340	0.1270
gl	0.2430	0.1900
gm	0.2460	0.1630
gn	0.2150	0.1360
go	0.3530	0.2380
gp	0.3010	0.2140
gq	0.2870	0.2250
gr	0.3140	0.2290
gs	0.2780	0.2030
gt	0.2940	0.2120
gu	0.3450	0.2300
gv	0.2880	0.1520
gw	0.2510	0.1300
gx	0.2220	0.0970
gy	0.2060	0.1090
gz	0.2010	0.0900
hA	0.1770	0.1190
hB	0.2390	0.1440
hC	0.2100	0.1100
hD	0.2510	0.1610
hE	0.1770	0.0350
hF	0.4230	0.2180

Continued on next page...

Continued from previous page...

Chain	Atom inclusion	Q-score
hG	0.2700	0.2090
hH	0.2590	0.1970
hI	0.2620	0.2100
hJ	0.3010	0.1940
hK	0.3180	0.1780
hL	0.2220	0.0860
hM	0.2670	0.1400
hN	0.2170	0.1090
hO	0.2010	0.1400
hP	0.2460	0.1080
hQ	0.1990	0.0860
hR	0.2060	0.0730
hS	0.3460	0.2410
hT	0.3040	0.2110
hU	0.2910	0.2390
hV	0.3010	0.2300
hW	0.2980	0.2330
hX	0.3070	0.2210
hY	0.3310	0.2370
hZ	0.2460	0.1110
ha	0.2170	0.1310
hb	0.3430	0.1860
hc	0.2150	0.1500
hd	0.2810	0.1090
he	0.3490	0.2540
hf	0.3190	0.2220
hg	0.2760	0.2320
hh	0.2850	0.2580
hi	0.2540	0.2480
hj	0.2970	0.2410
hk	0.3220	0.2510
hl	0.2770	0.1330
hm	0.2550	0.1810
hn	0.2030	0.1300
ho	0.2170	0.1170
hp	0.1920	0.0870
hq	0.2360	0.1730
hr	0.1610	0.0140
hs	0.4060	0.2080
ht	0.2890	0.2200
hu	0.2530	0.1970
hv	0.2790	0.2070

Continued on next page...

Continued from previous page...

Chain	Atom inclusion	Q-score
hw	0.2990	0.1950
hx	0.3280	0.1690
hy	0.1960	0.0710
hz	0.2480	0.1610
iA	0.3390	0.2140
iB	0.2510	0.1140
iC	0.1840	0.1030
iD	0.1820	0.0410
iE	0.2130	0.1020
iF	0.2320	0.1280
iG	0.1870	0.0660
iH	0.2480	0.1370
iI	0.3020	0.2480
iJ	0.2840	0.2120
iK	0.2650	0.2330
iL	0.2450	0.2370
iM	0.2230	0.2360
iN	0.2580	0.2440
iO	0.2640	0.2300
iP	0.2480	0.1450
iQ	0.2340	0.1430
iR	0.2030	0.1240
iS	0.2480	0.1230
iT	0.2670	0.1830
iU	0.2410	0.1280
iV	0.2340	0.1240
iW	0.3690	0.2360
iX	0.3160	0.2270
iY	0.2860	0.2270
iZ	0.3320	0.2380
ia	0.2080	0.1300
ib	0.1730	0.1240
ic	0.1990	0.1020
id	0.3100	0.1660
ie	0.1750	0.1330
if	0.2860	0.1270
ig	0.3460	0.2460
ih	0.3440	0.2140
ii	0.2780	0.2320
ij	0.3180	0.2480
ik	0.2830	0.2450
il	0.3020	0.2410

Continued on next page...

Continued from previous page...

Chain	Atom inclusion	Q-score
im	0.3430	0.2450
in	0.2670	0.1220
io	0.2250	0.0980
ip	0.2250	0.1180
iq	0.2270	0.1030
ir	0.2720	0.1060
is	0.2270	0.0930
it	0.2410	0.1300
iu	0.3340	0.2190
iv	0.3500	0.1980
iw	0.2620	0.2050
ix	0.3070	0.2240
iy	0.2870	0.2270
iz	0.3220	0.2100
jA	0.2680	0.2380
jB	0.2900	0.2590
jC	0.3020	0.2470
jD	0.2950	0.2350
jE	0.3010	0.2130
jF	0.2320	0.1180
jG	0.2550	0.1420
jH	0.1990	0.1010
jI	0.3050	0.1480
jJ	0.3260	0.1700
jK	0.2980	0.1280
jL	0.2600	0.0720
jM	0.3440	0.1830
jN	0.3390	0.1960
jO	0.2790	0.1500
jP	0.3130	0.1930
jQ	0.2670	0.1620
jR	0.3090	0.1690
jS	0.3470	0.1920
jT	0.2720	0.1170
jU	0.1840	0.1300
jV	0.1700	0.1200
jW	0.1940	0.1070
jX	0.2510	0.1590
jY	0.1750	0.1480
jZ	0.2320	0.1020
ja	0.2900	0.2080
jb	0.3070	0.2220

Continued on next page...

Continued from previous page...

Chain	Atom inclusion	Q-score
jc	0.3650	0.2320
jd	0.2740	0.1370
je	0.2460	0.1450
jf	0.1920	0.0980
jg	0.2270	0.0890
jh	0.2550	0.1290
ji	0.2430	0.1400
jj	0.2550	0.1250
jk	0.3400	0.2400
jl	0.2930	0.2240
jm	0.2990	0.2320
jn	0.3050	0.2320
jo	0.3060	0.2440
jp	0.2970	0.2290
jq	0.3200	0.2350
jr	0.2650	0.1300
js	0.2150	0.1500
jt	0.1820	0.1040
ju	0.1920	0.1200
jv	0.2250	0.1400
jw	0.2320	0.1560
jx	0.2320	0.0940
jy	0.3470	0.2240
jz	0.3260	0.2060
kA	0.2220	0.0830
kB	0.3410	0.2440
kC	0.3350	0.2160
kD	0.2980	0.2420
kE	0.2880	0.2320
kF	0.2760	0.2300
kG	0.3120	0.2310
kH	0.3340	0.2340
kI	0.3030	0.1250
kJ	0.2250	0.1590
kK	0.2270	0.1320
kL	0.2810	0.1380
kM	0.2740	0.1630
kN	0.2670	0.1320
kO	0.2360	0.1180
kP	0.3590	0.2250
kQ	0.3410	0.2250
kR	0.2920	0.2220

Continued on next page...

Continued from previous page...

Chain	Atom inclusion	Q-score
kS	0.3340	0.2350
kT	0.2770	0.2020
kU	0.2960	0.2070
kV	0.3830	0.2280
kW	0.2860	0.1380
kX	0.2810	0.1290
kY	0.2430	0.1260
kZ	0.2670	0.1380
ka	0.3490	0.2530
kb	0.3140	0.2260
kc	0.2780	0.2320
kd	0.2900	0.2470
ke	0.2810	0.2500
kf	0.3160	0.2460
kg	0.3230	0.2510
kh	0.2340	0.1380
ki	0.2480	0.1910
kj	0.2010	0.1410
kk	0.2060	0.1170
kl	0.1800	0.0650
km	0.2430	0.1630
kn	0.1440	0.0070
ko	0.3940	0.2010
kp	0.2910	0.2240
kq	0.2670	0.2060
kr	0.2660	0.2090
ks	0.3020	0.2010
kt	0.3290	0.1800
ku	0.1820	0.0580
0.2580	0.1460	
kw	0.2250	0.1170
kx	0.2670	0.1680
ky	0.2810	0.1420
kz	0.1920	0.1050
lA	0.2130	0.0660
lB	0.2460	0.1460
lC	0.2810	0.1560
lD	0.1960	0.1120
lE	0.2480	0.1390
lF	0.3350	0.2290
lG	0.3120	0.2110
lH	0.2850	0.2340

Continued on next page...

Continued from previous page...

Chain	Atom inclusion	Q-score
II	0.2910	0.2490
IJ	0.2730	0.2400
IK	0.2910	0.2380
IL	0.3090	0.2330
IM	0.2650	0.1250
IN	0.2270	0.1490
IO	0.1960	0.1180
IP	0.2410	0.1340
IQ	0.2790	0.1740
IR	0.2840	0.1490
IS	0.2530	0.1300
IT	0.3490	0.2280
IU	0.3150	0.2230
IV	0.2800	0.2210
IW	0.3040	0.2310
IX	0.2520	0.1970
IY	0.3020	0.2020
IZ	0.3460	0.2250
la	0.2150	0.1150
lb	0.2430	0.1110
lc	0.2200	0.1270
ld	0.2940	0.2260
le	0.2820	0.1930
lf	0.2670	0.2200
lg	0.2900	0.2310
lh	0.2720	0.2370
li	0.2930	0.2150
lj	0.3100	0.2250
lk	0.2290	0.1150
ll	0.2200	0.1110
lm	0.2010	0.0540
ln	0.2170	0.1240
lo	0.2720	0.1570
lp	0.1800	0.0780
lq	0.2390	0.1370
lr	0.3300	0.2380
ls	0.3140	0.2080
lt	0.2720	0.2310
lu	0.2910	0.2370
lv	0.2840	0.2320
lw	0.2760	0.2400
lx	0.3190	0.2320

Continued on next page...

Continued from previous page...

Chain	Atom inclusion	Q-score
ly	0.2530	0.1300
lz	0.1990	0.1200
mA	0.2570	0.2290
mB	0.2420	0.2120
mC	0.2620	0.1140
mD	0.2430	0.1440
mE	0.2170	0.1060
mF	0.2950	0.1580
mG	0.2860	0.1610
mH	0.2700	0.1290
mI	0.2480	0.0810
mJ	0.3160	0.1730
mK	0.2950	0.1950
mL	0.2750	0.1540
mM	0.2850	0.1960
mN	0.2630	0.1640
mO	0.2900	0.1690
mP	0.3360	0.1930
mQ	0.2580	0.1120
mR	0.2290	0.1360
mS	0.1990	0.1260
mT	0.2170	0.1070
mU	0.3190	0.1320
mV	0.2530	0.1610
mW	0.2670	0.1320
mX	0.3730	0.2420
mY	0.3250	0.2180
mZ	0.3200	0.2400
ma	0.2840	0.1400
mb	0.2880	0.1470
mc	0.2460	0.1280
md	0.2390	0.1310
me	0.2030	0.0970
mf	0.2360	0.1090
mg	0.2390	0.1200
mh	0.2950	0.2210
mi	0.3000	0.1840
mj	0.2680	0.2200
mk	0.2920	0.2300
ml	0.2920	0.2370
mm	0.2790	0.2070
mn	0.3120	0.2240

Continued on next page...

Continued from previous page...

Chain	Atom inclusion	Q-score
mo	0.2390	0.1180
mp	0.2010	0.1560
mq	0.2060	0.1210
mr	0.1890	0.1380
ms	0.2410	0.1490
mt	0.2580	0.1610
mu	0.2410	0.1010
mv	0.3040	0.2210
mw	0.3150	0.2030
mx	0.2450	0.2500
my	0.2420	0.2660
mz	0.2480	0.2480
nA	0.3050	0.2110
nB	0.2650	0.2380
nC	0.2650	0.2280
nD	0.2790	0.2360
nE	0.2740	0.2260
nF	0.3050	0.2140
nG	0.2720	0.1270
nH	0.2880	0.1400
nI	0.2200	0.0880
nJ	0.2460	0.0970
nK	0.3500	0.0980
nL	0.2460	0.1320
nM	0.3970	0.1060
nN	0.3990	0.1560
nO	0.5060	0.1410
nP	0.2830	0.1650
nQ	0.3150	0.1750
nR	0.2800	0.1660
nS	0.3250	0.1610
nT	0.3670	0.1420
nU	0.3450	0.0890
nV	0.2840	0.1590
nW	0.2130	0.0890
nX	0.2550	0.0930
nY	0.3640	0.1150
nZ	0.2270	0.1280
na	0.3490	0.2400
nb	0.3150	0.2460
nc	0.3520	0.2350
nd	0.3660	0.2400

Continued on next page...

Continued from previous page...

Chain	Atom inclusion	Q-score
ne	0.2720	0.1240
nf	0.3100	0.1750
ng	0.2100	0.1180
nh	0.2390	0.1340
ni	0.2860	0.1650
nj	0.2700	0.1550
nk	0.2510	0.1150
nl	0.2960	0.1920
nm	0.3130	0.1830
nn	0.3190	0.2200
no	0.2710	0.1940
np	0.2670	0.1800
nq	0.2870	0.2050
nr	0.2950	0.1910
ns	0.2220	0.1120
nt	0.2650	0.1810
nu	0.2250	0.1420
nv	0.2290	0.1130
nw	0.2620	0.1220
nx	0.2410	0.1470
ny	0.2130	0.1010
nz	0.3170	0.2330
oA	0.2530	0.1220
oB	0.2270	0.1530
oC	0.2360	0.1000
oD	0.3020	0.2320
oE	0.3070	0.2070
oF	0.2790	0.2470
oG	0.2790	0.2310
oH	0.2720	0.2370
oI	0.2600	0.2200
oJ	0.3020	0.2090
oK	0.2550	0.1310
oL	0.2670	0.1300
oM	0.2200	0.0910
oN	0.2650	0.1120
oO	0.3430	0.1020
oP	0.2130	0.1080
oQ	0.3730	0.0740
oR	0.4060	0.1560
oS	0.5000	0.1430
oT	0.2740	0.1600

Continued on next page...

Continued from previous page...

Chain	Atom inclusion	Q-score
oU	0.3210	0.1800
oV	0.2720	0.1640
oW	0.3150	0.1540
oX	0.3700	0.1410
oY	0.3570	0.0930
oZ	0.2790	0.1390
oa	0.3880	0.1010
ob	0.4000	0.1560
oc	0.4970	0.1450
od	0.2870	0.1630
oe	0.3020	0.1740
of	0.2610	0.1570
og	0.3120	0.1550
oh	0.3640	0.1400
oi	0.3590	0.0990
oj	0.3030	0.1540
ok	0.2150	0.1310
ol	0.1960	0.1170
om	0.2530	0.1650
on	0.2580	0.1370
oo	0.2080	0.0960
op	0.3020	0.1890
oq	0.2960	0.1840
or	0.2990	0.2060
os	0.2700	0.1900
ot	0.2690	0.1820
ou	0.2760	0.1950
ov	0.2950	0.1840
ow	0.2200	0.1090
ox	0.2620	0.1890
oy	0.2460	0.1420
oz	0.2200	0.1230
pA	0.2980	0.1250
pB	0.2720	0.1270
pC	0.1870	0.1210
pD	0.2130	0.1170
pE	0.2670	0.1580
pF	0.2410	0.1120
pG	0.2670	0.0910
pH	0.3250	0.1960
pI	0.3370	0.1890
pJ	0.2920	0.2020















































































Continued on next page...

Continued from previous page...

Chain	Atom inclusion	Q-score
pK	0.2610	0.1860
pL	0.2720	0.1840
pM	0.2690	0.1930
pN	0.3120	0.1880
pO	0.2580	0.1020
pP	0.2290	0.1750
pQ	0.1890	0.1020
pR	0.2010	0.0930
pS	0.2340	0.1110
pT	0.1770	0.1280
pU	0.2340	0.1070
pV	0.3160	0.2210
pW	0.2930	0.1970
pX	0.2930	0.2390
pY	0.2780	0.2160
pZ	0.2830	0.2280
pa	0.1960	0.1010
pb	0.2290	0.1220
pc	0.2880	0.1610
pd	0.2430	0.1310
pe	0.2360	0.1040
pf	0.3570	0.1990
pg	0.3470	0.1920
ph	0.3220	0.2090
pi	0.2940	0.1870
pj	0.2920	0.1860
pk	0.3180	0.2030
pl	0.3470	0.1950
pm	0.2720	0.1070
pn	0.2130	0.1630
po	0.1890	0.0850
pp	0.1840	0.0710
pq	0.2840	0.0960
pr	0.1680	0.1200
ps	0.2530	0.1070
pt	0.3340	0.2260
pu	0.3140	0.2010
pV	0.2500	0.2410
pW	0.2230	0.2050
pX	0.2410	0.2260
py	0.2850	0.2290
pZ	0.2820	0.1990

Continued on next page...

Continued from previous page...

Chain	Atom inclusion	Q-score
qA	 0.7470	 0.2970
qB	 0.5800	 0.2490
qC	 0.7860	 0.2970
qD	 0.5370	 0.2520
qE	 0.7420	 0.2990
qF	 0.5220	 0.2470
qG	 0.7670	 0.2930
qH	 0.5150	 0.2440
qI	 0.7250	 0.3070
qJ	 0.5400	 0.2310
qK	 0.7170	 0.3000
qL	 0.5570	 0.2180
qM	 0.7730	 0.2730
qa	 0.2730	 0.2220
qb	 0.3080	 0.2030
qc	 0.2200	 0.1240
qd	 0.5580	 0.0800
qe	 0.5180	 0.0860
qf	 0.5750	 0.0970
qg	 0.5390	 0.0930
qh	 0.5470	 0.0970
qi	 0.5460	 0.0700
qj	 0.7220	 0.1740
qk	 0.7270	 0.1710
ql	 0.7320	 0.1650
qm	 0.6940	 0.1840
qn	 0.6960	 0.1790
qo	 0.7470	 0.1800
qp	 0.5310	 0.2310
qq	 0.7500	 0.2940
qr	 0.5210	 0.2260
qs	 0.7890	 0.2850
qt	 0.4910	 0.2310
qu	 0.7400	 0.2880
qv	 0.5080	 0.2400
qw	 0.7700	 0.2870
qx	 0.5410	 0.2340
qy	 0.7240	 0.2610
qz	 0.5500	 0.2410