



Full wwPDB X-ray Structure Validation Report ⓘ

Feb 28, 2024 – 07:34 PM EST

PDB ID : 5S56
Title : Tubulin-Z2856434783-complex
Authors : Muehlethaler, T.; Gioia, D.; Prota, A.E.; Sharpe, M.E.; Cavalli, A.; Steinmetz, M.O.
Deposited on : 2020-11-08
Resolution : 2.25 Å(reported)

This is a Full wwPDB X-ray Structure Validation Report for a publicly released PDB entry.

We welcome your comments at validation@mail.wwpdb.org

A user guide is available at

<https://www.wwpdb.org/validation/2017/XrayValidationReportHelp>

with specific help available everywhere you see the ⓘ symbol.

The types of validation reports are described at

<http://www.wwpdb.org/validation/2017/FAQs#types>.

The following versions of software and data (see [references ⓘ](#)) were used in the production of this report:

MolProbity : 4.02b-467
Mogul : 1.8.5 (274361), CSD as541be (2020)
Xtriage (Phenix) : 1.13
EDS : 2.36
buster-report : 1.1.7 (2018)
Percentile statistics : 20191225.v01 (using entries in the PDB archive December 25th 2019)
Refmac : 5.8.0158
CCP4 : 7.0.044 (Gargrove)
Ideal geometry (proteins) : Engh & Huber (2001)
Ideal geometry (DNA, RNA) : Parkinson et al. (1996)
Validation Pipeline (wwPDB-VP) : 2.36

1 Overall quality at a glance i

The following experimental techniques were used to determine the structure:

X-RAY DIFFRACTION

The reported resolution of this entry is 2.25 Å.

Percentile scores (ranging between 0-100) for global validation metrics of the entry are shown in the following graphic. The table shows the number of entries on which the scores are based.

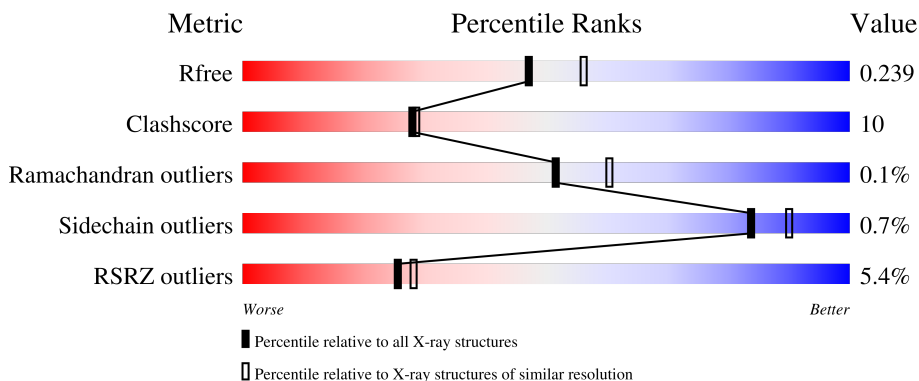

Metric	Whole archive (#Entries)	Similar resolution (#Entries, resolution range(Å))
R_{free}	130704	1377 (2.26-2.26)
Clashscore	141614	1487 (2.26-2.26)
Ramachandran outliers	138981	1449 (2.26-2.26)
Sidechain outliers	138945	1450 (2.26-2.26)
RSRZ outliers	127900	1356 (2.26-2.26)

The table below summarises the geometric issues observed across the polymeric chains and their fit to the electron density. The red, orange, yellow and green segments of the lower bar indicate the fraction of residues that contain outliers for ≥ 3 , 2, 1 and 0 types of geometric quality criteria respectively. A grey segment represents the fraction of residues that are not modelled. The numeric value for each fraction is indicated below the corresponding segment, with a dot representing fractions $\leq 5\%$. The upper red bar (where present) indicates the fraction of residues that have poor fit to the electron density. The numeric value is given above the bar.

Mol	Chain	Length	Quality of chain
1	A	451	<div style="display: flex; align-items: center;"> <div style="width: 2%; height: 10px; background-color: red; margin-right: 2px;"></div> <div style="width: 76%; height: 10px; background-color: green; margin-right: 2px;"></div> <div style="width: 21%; height: 10px; background-color: yellow; margin-right: 2px;"></div> <div style="width: 1%; height: 10px; background-color: grey; margin-right: 2px;"></div> </div> <p style="margin-left: 20px;">2% 76% 21% .</p>
1	C	451	<div style="display: flex; align-items: center;"> <div style="width: 2%; height: 10px; background-color: red; margin-right: 2px;"></div> <div style="width: 80%; height: 10px; background-color: green; margin-right: 2px;"></div> <div style="width: 17%; height: 10px; background-color: yellow; margin-right: 2px;"></div> <div style="width: 1%; height: 10px; background-color: grey; margin-right: 2px;"></div> </div> <p style="margin-left: 20px;">2% 80% 17% .</p>
2	B	445	<div style="display: flex; align-items: center;"> <div style="width: 3%; height: 10px; background-color: red; margin-right: 2px;"></div> <div style="width: 70%; height: 10px; background-color: green; margin-right: 2px;"></div> <div style="width: 24%; height: 10px; background-color: yellow; margin-right: 2px;"></div> <div style="width: 3%; height: 10px; background-color: grey; margin-right: 2px;"></div> </div> <p style="margin-left: 20px;">3% 70% 24% . .</p>
2	D	445	<div style="display: flex; align-items: center;"> <div style="width: 5%; height: 10px; background-color: red; margin-right: 2px;"></div> <div style="width: 72%; height: 10px; background-color: green; margin-right: 2px;"></div> <div style="width: 24%; height: 10px; background-color: yellow; margin-right: 2px;"></div> <div style="width: 1%; height: 10px; background-color: grey; margin-right: 2px;"></div> </div> <p style="margin-left: 20px;">5% 72% 24% .</p>
3	E	143	<div style="display: flex; align-items: center;"> <div style="width: 10%; height: 10px; background-color: red; margin-right: 2px;"></div> <div style="width: 74%; height: 10px; background-color: green; margin-right: 2px;"></div> <div style="width: 12%; height: 10px; background-color: yellow; margin-right: 2px;"></div> <div style="width: 14%; height: 10px; background-color: grey; margin-right: 2px;"></div> </div> <p style="margin-left: 20px;">10% 74% 12% 14%</p>

Continued on next page...

Continued from previous page...

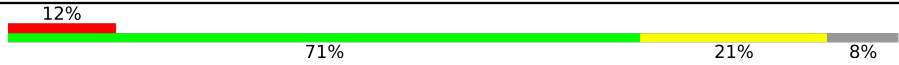
Mol	Chain	Length	Quality of chain
4	F	384	 <p>A horizontal bar chart showing the quality of chain for Mol 4, Chain F, Length 384. The bar is divided into four segments: 12% red, 71% green, 21% yellow, and 8% grey.</p>

2 Entry composition i

There are 11 unique types of molecules in this entry. The entry contains 18018 atoms, of which 28 are hydrogens and 0 are deuteriums.

In the tables below, the ZeroOcc column contains the number of atoms modelled with zero occupancy, the AltConf column contains the number of residues with at least one atom in alternate conformation and the Trace column contains the number of residues modelled with at most 2 atoms.

- Molecule 1 is a protein called Tubulin alpha-1B chain.

Mol	Chain	Residues	Atoms					ZeroOcc	AltConf	Trace
			Total	C	N	O	S			
1	A	438	Total	C	N	O	S	0	0	0
			3424	2167	582	653	22			
1	C	440	Total	C	N	O	S	0	1	0
			3443	2178	585	657	23			

- Molecule 2 is a protein called Tubulin beta-2B chain.

Mol	Chain	Residues	Atoms					ZeroOcc	AltConf	Trace
			Total	C	N	O	S			
2	B	425	Total	C	N	O	S	1	0	0
			3348	2103	573	645	27			
2	D	427	Total	C	N	O	S	5	0	0
			3348	2101	571	649	27			

- Molecule 3 is a protein called Stathmin-4.

Mol	Chain	Residues	Atoms					ZeroOcc	AltConf	Trace
			Total	C	N	O	S			
3	E	123	Total	C	N	O	S	0	0	0
			1014	625	183	201	5			

There are 2 discrepancies between the modelled and reference sequences:

Chain	Residue	Modelled	Actual	Comment	Reference
E	3	MET	-	initiating methionine	UNP P63043
E	4	ALA	-	expression tag	UNP P63043

- Molecule 4 is a protein called Tubulin-Tyrosine Ligase.

Mol	Chain	Residues	Atoms					ZeroOcc	AltConf	Trace
			Total	C	N	O	S			
4	F	352	Total	C	N	O	S	0	0	0
			2877	1843	495	525	14			

There are 6 discrepancies between the modelled and reference sequences:

Chain	Residue	Modelled	Actual	Comment	Reference
F	379	HIS	-	expression tag	UNP E1BQ43
F	380	HIS	-	expression tag	UNP E1BQ43
F	381	HIS	-	expression tag	UNP E1BQ43
F	382	HIS	-	expression tag	UNP E1BQ43
F	383	HIS	-	expression tag	UNP E1BQ43
F	384	HIS	-	expression tag	UNP E1BQ43

- Molecule 5 is GUANOSINE-5'-TRIPHOSPHATE (three-letter code: GTP) (formula: $C_{10}H_{16}N_5O_{14}P_3$).

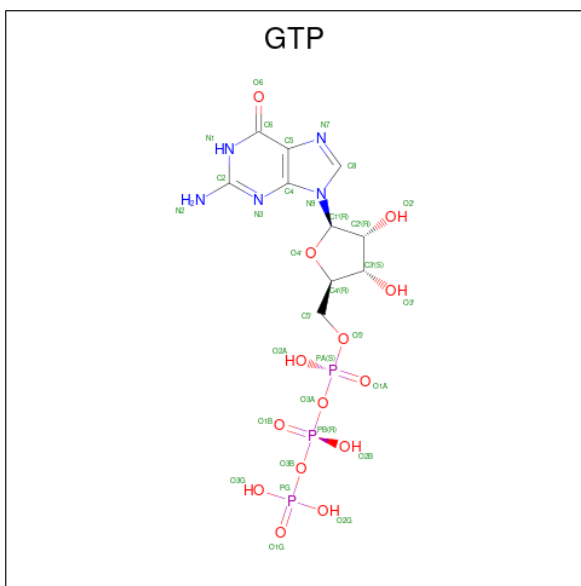

Mol	Chain	Residues	Atoms				ZeroOcc	AltConf	
			Total	C	N	O			P
5	A	1	Total	C	N	O	P	0	0
			32	10	5	14	3		
5	C	1	Total	C	N	O	P	0	0
			32	10	5	14	3		

- Molecule 6 is MAGNESIUM ION (three-letter code: MG) (formula: Mg).

Mol	Chain	Residues	Atoms		ZeroOcc	AltConf
			Total	Mg		
6	A	1	Total	Mg	0	0
			1	1		
6	B	1	Total	Mg	0	0
			1	1		
6	C	1	Total	Mg	0	0
			1	1		
6	D	1	Total	Mg	0	0
			1	1		

Continued on next page...

Continued from previous page...

Mol	Chain	Residues	Atoms		ZeroOcc	AltConf
6	F	1	Total	Mg	0	0
			1	1		

- Molecule 7 is CALCIUM ION (three-letter code: CA) (formula: Ca).

Mol	Chain	Residues	Atoms		ZeroOcc	AltConf
7	A	2	Total	Ca	0	0
			2	2		
7	B	1	Total	Ca	0	0
			1	1		
7	C	1	Total	Ca	0	0
			1	1		

- Molecule 8 is GUANOSINE-5'-DIPHOSPHATE (three-letter code: GDP) (formula: C₁₀H₁₅N₅O₁₁P₂).

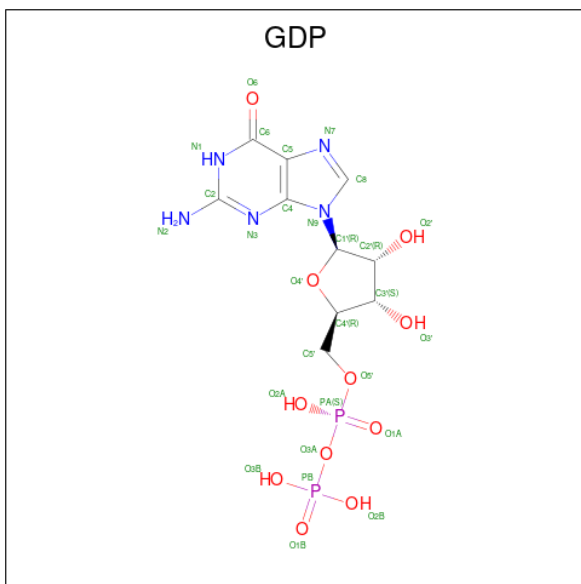

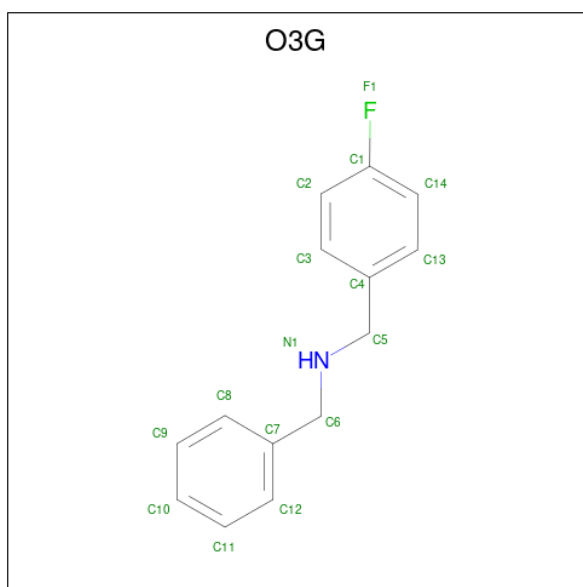

Mol	Chain	Residues	Atoms					ZeroOcc	AltConf
9	B	1	Total	C	F	H	N	0	0
			30	14	1	14	1		
9	B	1	Total	C	F	H	N	0	0
			30	14	1	14	1		

- Molecule 10 is PHOSPHOMETHYLPHOSPHONIC ACID ADENYLATE ESTER (three-letter code: ACP) (formula: $C_{11}H_{18}N_5O_{12}P_3$).

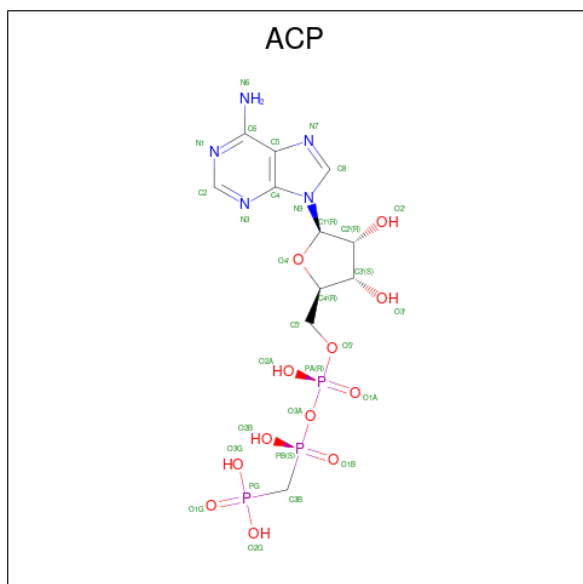

Mol	Chain	Residues	Atoms					ZeroOcc	AltConf
10	F	1	Total	C	N	O	P	0	0
			31	11	5	12	3		

- Molecule 11 is water.

Mol	Chain	Residues	Atoms	ZeroOcc	AltConf
11	A	52	Total O 52 52	0	0
11	B	80	Total O 80 80	0	0
11	C	176	Total O 176 176	0	0
11	D	21	Total O 21 21	0	0
11	E	6	Total O 6 6	0	0
11	F	9	Total O 9 9	0	0

3 Residue-property plots i

These plots are drawn for all protein, RNA, DNA and oligosaccharide chains in the entry. The first graphic for a chain summarises the proportions of the various outlier classes displayed in the second graphic. The second graphic shows the sequence view annotated by issues in geometry and electron density. Residues are color-coded according to the number of geometric quality criteria for which they contain at least one outlier: green = 0, yellow = 1, orange = 2 and red = 3 or more. A red dot above a residue indicates a poor fit to the electron density ($RSRZ > 2$). Stretches of 2 or more consecutive residues without any outlier are shown as a green connector. Residues present in the sample, but not in the model, are shown in grey.

- Molecule 1: Tubulin alpha-1B chain

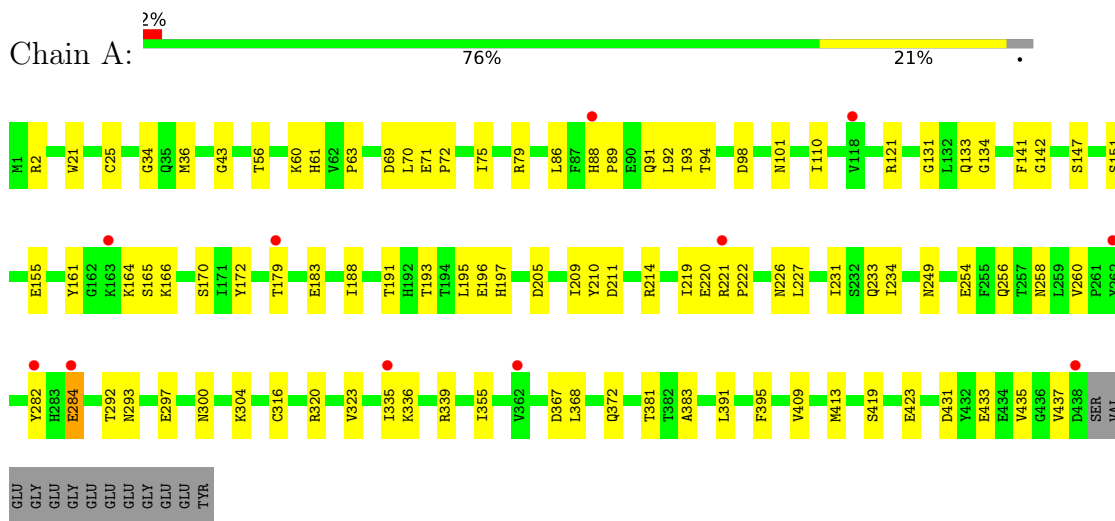

- Molecule 1: Tubulin alpha-1B chain

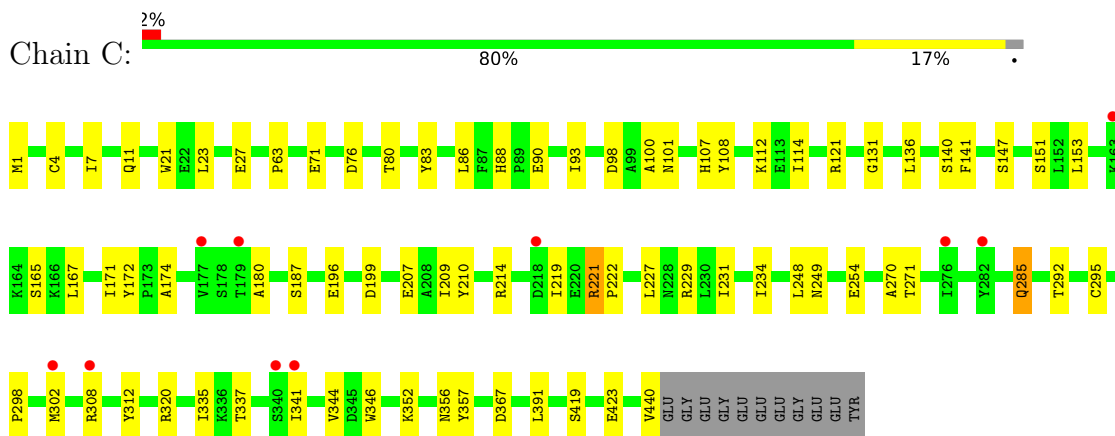

- Molecule 2: Tubulin beta-2B chain

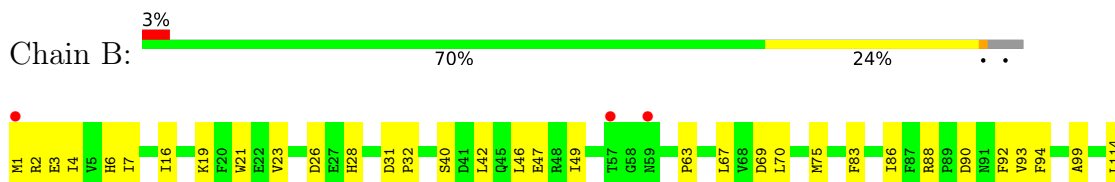

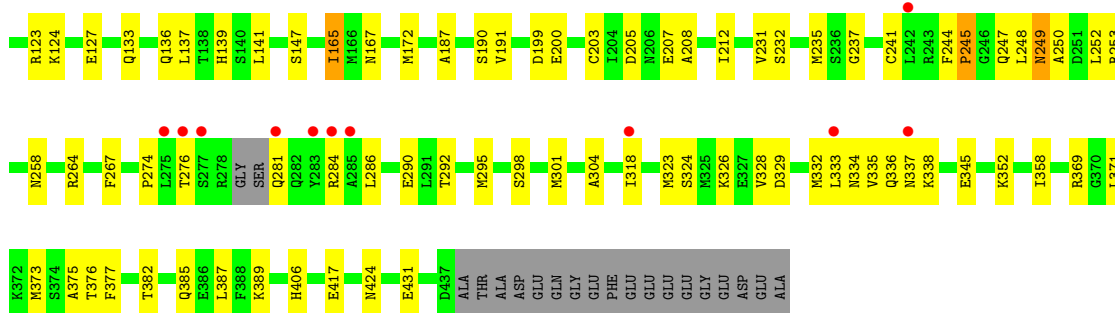

• Molecule 2: Tubulin beta-2B chain

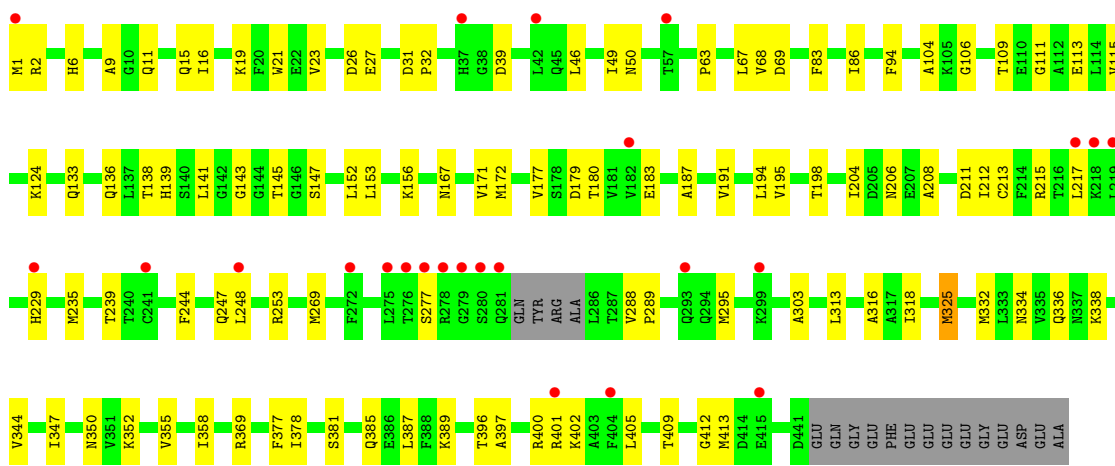

• Molecule 3: Stathmin-4

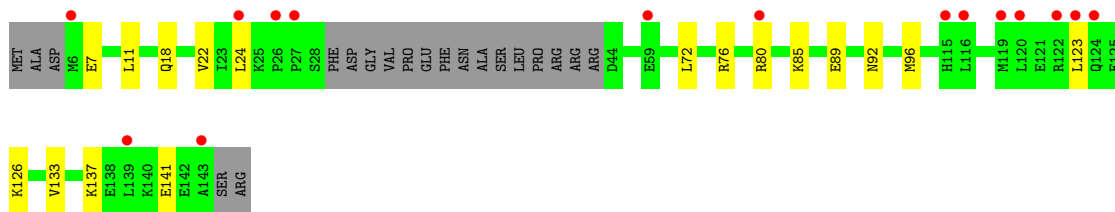
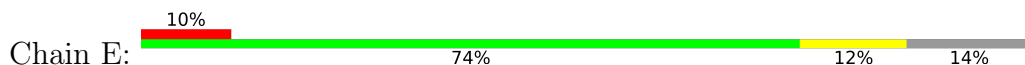

• Molecule 4: Tubulin-Tyrosine Ligase

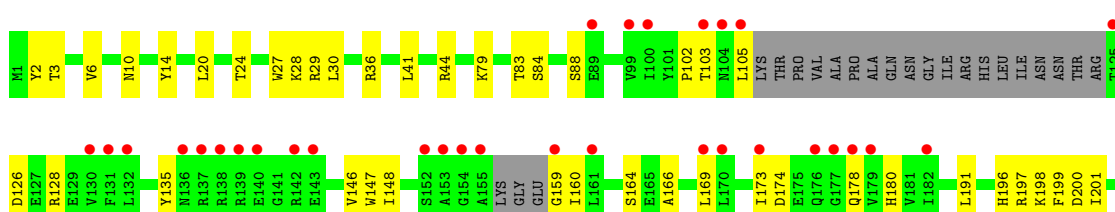

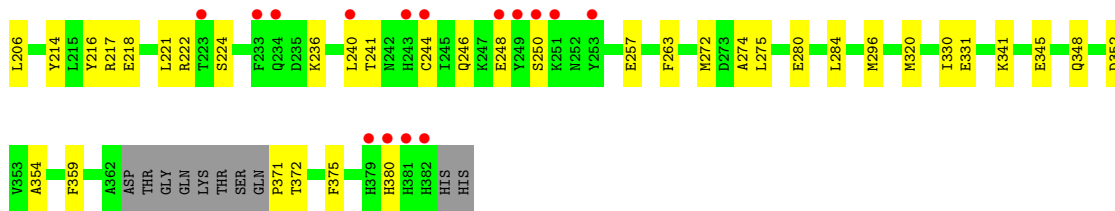

4 Data and refinement statistics

Property	Value	Source
Space group	P 21 21 21	Depositor
Cell constants a, b, c, α , β , γ	104.56Å 158.30Å 180.09Å 90.00° 90.00° 90.00°	Depositor
Resolution (Å)	62.66 – 2.25 118.90 – 2.25	Depositor EDS
% Data completeness (in resolution range)	99.9 (62.66-2.25) 99.9 (118.90-2.25)	Depositor EDS
R_{merge}	0.08	Depositor
R_{sym}	(Not available)	Depositor
$\langle I/\sigma(I) \rangle$ ¹	1.21 (at 2.25Å)	Xtrriage
Refinement program	PHENIX 1.18.2_3874	Depositor
R, R_{free}	0.204 , 0.239 0.205 , 0.239	Depositor DCC
R_{free} test set	7067 reflections (4.98%)	wwPDB-VP
Wilson B-factor (Å ²)	61.4	Xtrriage
Anisotropy	0.149	Xtrriage
Bulk solvent k_{sol} (e/Å ³), B_{sol} (Å ²)	0.31 , 53.3	EDS
L-test for twinning ²	$\langle L \rangle = 0.51$, $\langle L^2 \rangle = 0.34$	Xtrriage
Estimated twinning fraction	No twinning to report.	Xtrriage
F_o, F_c correlation	0.95	EDS
Total number of atoms	18018	wwPDB-VP
Average B, all atoms (Å ²)	81.0	wwPDB-VP

Xtrriage's analysis on translational NCS is as follows: *The largest off-origin peak in the Patterson function is 2.75% of the height of the origin peak. No significant pseudotranslation is detected.*

¹Intensities estimated from amplitudes.

²Theoretical values of $\langle |L| \rangle$, $\langle L^2 \rangle$ for acentric reflections are 0.5, 0.333 respectively for untwinned datasets, and 0.375, 0.2 for perfectly twinned datasets.

5 Model quality [i](#)

5.1 Standard geometry [i](#)

Bond lengths and bond angles in the following residue types are not validated in this section: ACP, MG, GTP, GDP, CA, O3G

The Z score for a bond length (or angle) is the number of standard deviations the observed value is removed from the expected value. A bond length (or angle) with $|Z| > 5$ is considered an outlier worth inspection. RMSZ is the root-mean-square of all Z scores of the bond lengths (or angles).

Mol	Chain	Bond lengths		Bond angles	
		RMSZ	# Z >5	RMSZ	# Z >5
1	A	0.25	0/3502	0.42	0/4754
1	C	0.26	0/3521	0.43	0/4780
2	B	0.26	0/3422	0.42	0/4633
2	D	0.25	0/3421	0.41	0/4633
3	E	0.24	0/1022	0.35	0/1356
4	F	0.24	0/2944	0.40	0/3978
All	All	0.25	0/17832	0.41	0/24134

There are no bond length outliers.

There are no bond angle outliers.

There are no chirality outliers.

There are no planarity outliers.

5.2 Too-close contacts [i](#)

In the following table, the Non-H and H(model) columns list the number of non-hydrogen atoms and hydrogen atoms in the chain respectively. The H(added) column lists the number of hydrogen atoms added and optimized by MolProbity. The Clashes column lists the number of clashes within the asymmetric unit, whereas Symm-Clashes lists symmetry-related clashes.

Mol	Chain	Non-H	H(model)	H(added)	Clashes	Symm-Clashes
1	A	3424	0	3334	66	1
1	C	3443	0	3352	56	1
2	B	3348	0	3223	88	0
2	D	3348	0	3224	74	0
3	E	1014	0	1029	10	1
4	F	2877	0	2839	59	0
5	A	32	0	12	1	0

Continued on next page...

Continued from previous page...

Mol	Chain	Non-H	H(model)	H(added)	Clashes	Symm-Clashes
5	C	32	0	12	1	0
6	A	1	0	0	0	0
6	B	1	0	0	0	0
6	C	1	0	0	0	0
6	D	1	0	0	0	0
6	F	1	0	0	0	0
7	A	2	0	0	0	0
7	B	1	0	0	0	0
7	C	1	0	0	0	0
8	B	28	0	12	0	0
8	D	28	0	12	1	0
9	B	32	28	0	1	0
10	F	31	0	14	3	0
11	A	52	0	0	3	0
11	B	80	0	0	3	0
11	C	176	0	0	4	1
11	D	21	0	0	0	0
11	E	6	0	0	1	0
11	F	9	0	0	0	0
All	All	17990	28	17063	342	2

The all-atom clashscore is defined as the number of clashes found per 1000 atoms (including hydrogen atoms). The all-atom clashscore for this structure is 10.

All (342) close contacts within the same asymmetric unit are listed below, sorted by their clash magnitude.

Atom-1	Atom-2	Interatomic distance (Å)	Clash overlap (Å)
4:F:102:PRO:HG2	4:F:105:LEU:HD13	1.54	0.90
2:D:295:MET:HE2	2:D:377:PHE:HB2	1.57	0.84
2:D:325:MET:HE1	2:D:355:VAL:HG21	1.62	0.81
2:D:397:ALA:O	2:D:401:ARG:NH1	2.13	0.81
2:B:47:GLU:HG2	2:B:245:PRO:HG3	1.62	0.80
1:C:209:ILE:HD11	1:C:302:MET:HE3	1.63	0.80
1:A:381:THR:HG22	1:A:383:ALA:H	1.47	0.80
2:B:2:ARG:HB2	2:B:133:GLN:HG3	1.64	0.79
2:B:2:ARG:HB2	2:B:133:GLN:HE21	1.48	0.79
4:F:331:GLU:OE2	10:F:401:ACP:O3G	2.00	0.78
2:D:83:PHE:O	2:D:86:ILE:HG22	1.84	0.77
4:F:10:ASN:HB2	4:F:44:ARG:HH22	1.49	0.77
2:B:208:ALA:HB2	2:B:304:ALA:HB2	1.66	0.77
2:B:83:PHE:O	2:B:86:ILE:HG22	1.87	0.74

Continued on next page...

Continued from previous page...

Atom-1	Atom-2	Interatomic distance (Å)	Clash overlap (Å)
1:C:76:ASP:O	1:C:80:THR:HG22	1.88	0.74
2:D:136:GLN:HA	2:D:167:ASN:O	1.88	0.73
4:F:371:PRO:HA	4:F:372:THR:HB	1.71	0.72
2:B:274:PRO:HB3	2:B:286:LEU:HD22	1.71	0.71
4:F:147:TRP:HB2	4:F:169:LEU:HD11	1.73	0.71
2:D:334:ASN:HD21	2:D:338:LYS:HE3	1.56	0.71
2:D:217:LEU:HA	2:D:277:SER:HB3	1.72	0.70
2:D:325:MET:HE2	2:D:325:MET:HA	1.74	0.69
4:F:102:PRO:HG2	4:F:105:LEU:CD1	2.22	0.69
1:A:2:ARG:HB2	1:A:133:GLN:HE21	1.57	0.69
1:C:367:ASP:OD1	11:C:601:HOH:O	2.11	0.68
3:E:123:LEU:HD23	3:E:126:LYS:HD3	1.75	0.68
1:A:88:HIS:HB2	1:A:89:PRO:HD2	1.75	0.68
1:A:335:ILE:HG23	1:A:339:ARG:HG3	1.76	0.67
3:E:85:LYS:NZ	11:E:201:HOH:O	2.28	0.66
1:C:209:ILE:HD11	1:C:302:MET:CE	2.26	0.66
2:B:292:THR:HG22	2:B:335:VAL:HG21	1.76	0.66
1:C:312:TYR:CD1	1:C:341:ILE:HG23	2.31	0.66
1:A:211:ASP:OD2	1:A:304:LYS:NZ	2.23	0.66
1:C:93:ILE:HD11	1:C:121:ARG:HG3	1.77	0.65
2:B:337:ASN:OD1	4:F:36:ARG:HD3	1.96	0.65
1:C:221:ARG:HG3	2:D:325:MET:HG2	1.79	0.65
1:C:221:ARG:HG3	2:D:325:MET:CG	2.28	0.64
2:D:2:ARG:HB3	2:D:133:GLN:CG	2.28	0.63
1:C:165:SER:HA	1:C:199:ASP:OD2	1.99	0.63
4:F:236:LYS:HB3	4:F:240:LEU:HD13	1.81	0.63
2:B:244:PHE:CD1	2:B:358:ILE:HD12	2.34	0.62
2:D:347:ILE:HG22	2:D:350:ASN:HB3	1.80	0.62
1:C:254:GLU:HG2	1:C:352:LYS:HE2	1.81	0.62
2:B:69:ASP:O	2:B:94:PHE:HA	2.00	0.62
2:D:46:LEU:HA	2:D:49:ILE:HB	1.82	0.62
2:D:397:ALA:HA	2:D:400:ARG:NH1	2.15	0.62
4:F:128:ARG:NH2	4:F:174:ASP:OD1	2.33	0.62
2:D:2:ARG:HB3	2:D:133:GLN:HG3	1.81	0.62
2:D:325:MET:CE	2:D:355:VAL:HG21	2.30	0.61
2:B:147:SER:OG	2:B:190:SER:OG	2.17	0.61
1:A:36:MET:HB3	1:A:61:HIS:CE1	2.36	0.60
2:D:177:VAL:HG21	2:D:206:ASN:HB3	1.83	0.60
2:B:136:GLN:HA	2:B:167:ASN:O	2.01	0.60
2:D:145:THR:HB	8:D:501:GDP:O2B	2.02	0.60
1:A:88:HIS:CD2	1:A:91:GLN:HG3	2.35	0.60

Continued on next page...

Continued from previous page...

Atom-1	Atom-2	Interatomic distance (Å)	Clash overlap (Å)
1:A:336:LYS:HG3	3:E:24:LEU:HD13	1.83	0.60
2:B:172:MET:HG3	2:B:387:LEU:HD11	1.84	0.59
2:B:248:LEU:O	2:B:250:ALA:N	2.35	0.59
1:A:79:ARG:HG2	1:A:92:LEU:HD12	1.85	0.58
1:C:270:ALA:O	1:C:302:MET:HG2	2.02	0.58
1:C:4[A]:CYS:SG	1:C:136:LEU:HG	2.43	0.58
1:C:320:ARG:HA	1:C:356:ASN:O	2.04	0.58
4:F:197:ARG:NH1	4:F:257:GLU:OE2	2.25	0.58
2:B:295:MET:CG	2:B:377:PHE:HB2	2.34	0.58
1:A:43:GLY:HA2	1:A:56:THR:O	2.04	0.58
2:B:2:ARG:CB	2:B:133:GLN:HE21	2.16	0.58
2:B:284:ARG:NH2	2:B:290:GLU:OE2	2.37	0.58
1:A:93:ILE:HD11	1:A:121:ARG:HG3	1.86	0.58
4:F:246:GLN:O	4:F:250:SER:HB3	2.04	0.57
4:F:371:PRO:CA	4:F:372:THR:HB	2.34	0.57
2:B:253:ARG:HD2	11:B:659:HOH:O	2.04	0.57
1:C:229:ARG:NH1	11:C:607:HOH:O	2.37	0.57
4:F:241:THR:OG1	10:F:401:ACP:O3'	2.05	0.57
1:C:1:MET:HE3	1:C:131:GLY:HA3	1.87	0.57
2:D:334:ASN:ND2	2:D:338:LYS:HE3	2.20	0.57
4:F:371:PRO:HA	4:F:372:THR:O	2.05	0.57
2:D:244:PHE:CE1	2:D:358:ILE:HD12	2.40	0.57
2:B:1:MET:HB3	2:B:3:GLU:OE2	2.04	0.57
2:B:295:MET:HG2	2:B:377:PHE:HB2	1.87	0.57
2:B:2:ARG:HB2	2:B:133:GLN:CG	2.33	0.56
1:C:209:ILE:HG22	1:C:227:LEU:HD22	1.86	0.56
4:F:10:ASN:HB2	4:F:44:ARG:NH2	2.18	0.56
2:D:152:LEU:O	2:D:156:LYS:HG2	2.04	0.56
2:D:187:ALA:O	2:D:191:VAL:HG23	2.06	0.56
2:D:172:MET:HG3	2:D:387:LEU:HD11	1.88	0.56
2:B:141:LEU:HD12	2:B:172:MET:SD	2.46	0.56
2:B:124:LYS:HD3	2:B:124:LYS:C	2.26	0.56
1:A:226:ASN:ND2	1:A:367:ASP:OD2	2.38	0.55
4:F:2:TYR:CE1	4:F:359:PHE:HB3	2.41	0.55
2:B:417:GLU:O	11:B:601:HOH:O	2.17	0.55
1:A:419:SER:O	1:A:423:GLU:HG3	2.07	0.55
2:B:2:ARG:HB2	2:B:133:GLN:NE2	2.21	0.55
1:A:179:THR:HA	2:B:352:LYS:HD2	1.90	0.54
1:C:298:PRO:HG2	1:C:308:ARG:NH2	2.23	0.54
2:D:19:LYS:O	2:D:23:VAL:HG23	2.08	0.54
2:D:124:LYS:C	2:D:124:LYS:HD3	2.29	0.54

Continued on next page...

Continued from previous page...

Atom-1	Atom-2	Interatomic distance (Å)	Clash overlap (Å)
1:A:210:TYR:CE1	1:A:222:PRO:HD2	2.43	0.54
1:A:151:SER:HB2	1:A:193:THR:OG1	2.08	0.53
2:B:16:ILE:HD13	2:B:231:VAL:HG11	1.89	0.53
1:C:100:ALA:HB2	2:D:253:ARG:HD2	1.89	0.53
2:D:248:LEU:HD21	2:D:352:LYS:HB3	1.90	0.53
4:F:147:TRP:HB2	4:F:169:LEU:CD1	2.39	0.53
1:A:166:LYS:HE2	1:A:197:HIS:O	2.08	0.53
2:D:69:ASP:O	2:D:94:PHE:HA	2.08	0.53
2:D:21:TRP:CZ3	2:D:63:PRO:HB3	2.43	0.53
2:D:11:GLN:O	2:D:15:GLN:HG2	2.09	0.53
2:B:23:VAL:HG21	2:B:232:SER:HB3	1.91	0.53
2:D:106:GLY:O	2:D:111:GLY:HA3	2.08	0.53
4:F:371:PRO:HA	4:F:372:THR:C	2.30	0.53
2:B:26:ASP:OD1	2:B:369:ARG:NH2	2.41	0.53
1:A:71:GLU:HG2	1:A:72:PRO:HD2	1.91	0.52
1:A:233:GLN:HG3	1:A:368:LEU:HD12	1.91	0.52
1:A:227:LEU:O	1:A:231:ILE:HG13	2.09	0.52
2:B:324:SER:O	2:B:328:VAL:HG23	2.09	0.52
2:B:334:ASN:ND2	2:B:338:LYS:HD2	2.23	0.52
4:F:198:LYS:HG2	4:F:199:PHE:H	1.74	0.52
1:A:69:ASP:O	1:A:94:THR:HA	2.09	0.52
2:D:171:VAL:HA	2:D:204:ILE:O	2.09	0.52
1:A:372:GLN:OE1	1:A:372:GLN:HA	2.09	0.52
1:A:254:GLU:HG2	1:A:258:ASN:ND2	2.25	0.52
1:A:431:ASP:O	1:A:435:VAL:HG23	2.10	0.52
1:C:271:THR:HG21	1:C:295:CYS:O	2.10	0.52
2:D:26:ASP:OD2	2:D:369:ARG:HD2	2.09	0.52
1:C:292:THR:HG22	1:C:335:ILE:CD1	2.40	0.52
1:A:172:TYR:HB3	1:A:205:ASP:HA	1.92	0.51
1:A:320:ARG:HG3	11:A:640:HOH:O	2.09	0.51
4:F:14:TYR:HB3	4:F:41:LEU:HD13	1.90	0.51
1:A:214:ARG:HG2	1:A:219:ILE:O	2.10	0.51
1:A:297:GLU:HB2	1:A:300:ASN:ND2	2.26	0.51
2:B:406:HIS:ND1	11:B:604:HOH:O	2.34	0.51
1:C:249:ASN:OD1	1:C:356:ASN:ND2	2.42	0.51
2:D:143:GLY:O	2:D:147:SER:OG	2.25	0.51
2:D:211:ASP:O	2:D:215:ARG:HB2	2.10	0.51
2:D:318:ILE:N	2:D:318:ILE:HD12	2.25	0.51
2:B:345:GLU:OE1	2:B:345:GLU:N	2.36	0.51
2:D:141:LEU:HD12	2:D:172:MET:SD	2.50	0.51
4:F:146:VAL:HG22	4:F:164:SER:HB3	1.93	0.51

Continued on next page...

Continued from previous page...

Atom-1	Atom-2	Interatomic distance (Å)	Clash overlap (Å)
1:A:284:GLU:CD	1:A:284:GLU:H	2.14	0.51
2:B:19:LYS:HB3	2:B:232:SER:OG	2.10	0.51
1:C:214:ARG:HG2	1:C:219:ILE:O	2.11	0.51
2:D:1:MET:CE	2:D:50:ASN:HB2	2.40	0.51
4:F:191:LEU:HD12	4:F:196:HIS:CE1	2.46	0.51
10:F:401:ACP:O3G	10:F:401:ACP:O1B	2.29	0.51
1:A:209:ILE:HG22	1:A:227:LEU:HD22	1.93	0.50
2:B:264:ARG:NH2	2:B:424:ASN:OD1	2.44	0.50
1:C:11:GLN:HE22	2:D:247:GLN:NE2	2.09	0.50
1:A:292:THR:HG22	1:A:335:ILE:CD1	2.42	0.50
1:C:210:TYR:CZ	1:C:222:PRO:HD2	2.47	0.50
2:D:269:MET:HG3	2:D:303:ALA:HB3	1.92	0.50
3:E:7:GLU:O	3:E:22:VAL:HA	2.11	0.50
4:F:371:PRO:HA	4:F:372:THR:CB	2.35	0.50
1:C:174:ALA:CB	1:C:207:GLU:HB2	2.41	0.50
1:A:98:ASP:HB2	5:A:501:GTP:O2G	2.12	0.50
2:B:21:TRP:CZ3	2:B:63:PRO:HB3	2.47	0.50
2:D:31:ASP:HB2	2:D:32:PRO:HD2	1.93	0.50
3:E:11:LEU:HD11	3:E:18:GLN:OE1	2.12	0.49
1:A:141:PHE:CE1	1:A:170:SER:HB3	2.48	0.49
2:B:253:ARG:HG3	9:B:504:O3G:F1	2.01	0.49
1:C:419:SER:O	1:C:423:GLU:HG3	2.13	0.49
2:D:191:VAL:O	2:D:195:VAL:HG23	2.13	0.49
2:B:231:VAL:O	2:B:235:MET:HG3	2.13	0.49
1:C:21:TRP:CZ3	1:C:63:PRO:HB3	2.47	0.49
4:F:201:ILE:HG12	4:F:221:LEU:HG	1.94	0.49
1:A:155:GLU:HG2	1:A:197:HIS:NE2	2.28	0.49
2:D:213:CYS:HA	2:D:217:LEU:HB2	1.95	0.49
2:B:28:HIS:HB3	2:B:49:ILE:HD13	1.95	0.49
2:B:70:LEU:HD12	2:B:99:ALA:HB2	1.95	0.49
2:B:382:THR:O	2:B:385:GLN:HG2	2.13	0.48
1:C:312:TYR:CE1	1:C:341:ILE:HG23	2.48	0.48
2:B:46:LEU:HA	2:B:49:ILE:HB	1.95	0.48
2:B:187:ALA:O	2:B:191:VAL:HG23	2.14	0.48
1:C:229:ARG:HG3	11:C:607:HOH:O	2.12	0.48
2:D:31:ASP:HB2	2:D:32:PRO:CD	2.43	0.48
4:F:3:THR:HB	4:F:30:LEU:HD11	1.95	0.48
1:A:335:ILE:HG23	1:A:339:ARG:CG	2.41	0.48
2:D:325:MET:HA	2:D:325:MET:CE	2.41	0.48
4:F:217:ARG:NH1	4:F:345:GLU:OE2	2.46	0.48
4:F:274:ALA:HB3	4:F:275:LEU:HD22	1.95	0.48

Continued on next page...

Continued from previous page...

Atom-1	Atom-2	Interatomic distance (Å)	Clash overlap (Å)
2:B:31:ASP:HB2	2:B:32:PRO:CD	2.44	0.48
3:E:85:LYS:O	3:E:89:GLU:HG3	2.13	0.48
2:B:286:LEU:HD12	2:B:290:GLU:OE1	2.14	0.48
4:F:263:PHE:CZ	4:F:341:LYS:HE2	2.48	0.48
4:F:296:MET:SD	4:F:380:HIS:HB2	2.54	0.48
1:C:107:HIS:HD2	1:C:151:SER:OG	1.96	0.48
4:F:197:ARG:HB2	4:F:224:SER:O	2.13	0.48
2:B:295:MET:SD	2:B:375:ALA:HB1	2.55	0.47
3:E:72:LEU:O	3:E:76:ARG:HG2	2.13	0.47
2:B:318:ILE:N	2:B:318:ILE:HD12	2.29	0.47
4:F:217:ARG:HG3	4:F:218:GLU:HG2	1.96	0.47
1:A:21:TRP:CZ3	1:A:63:PRO:HB3	2.50	0.47
1:C:174:ALA:HB1	1:C:207:GLU:HB2	1.95	0.47
1:C:440:VAL:HG12	1:C:440:VAL:O	2.15	0.47
4:F:280:GLU:HA	4:F:284:LEU:HB2	1.95	0.47
2:D:2:ARG:HB2	2:D:133:GLN:HE21	1.80	0.47
4:F:160:ILE:HD12	4:F:160:ILE:N	2.30	0.47
4:F:348:GLN:NE2	4:F:352:ASP:OD1	2.47	0.47
4:F:216:TYR:CZ	4:F:218:GLU:HB2	2.49	0.47
1:A:256:GLN:HG2	1:A:260:VAL:HB	1.96	0.47
2:B:208:ALA:O	2:B:212:ILE:HG13	2.15	0.47
1:C:187:SER:HB3	1:C:391:LEU:HD21	1.97	0.47
2:D:23:VAL:O	2:D:27:GLU:HG3	2.15	0.46
2:D:402:LYS:HB3	2:D:405:LEU:HD12	1.97	0.46
2:B:2:ARG:CG	2:B:133:GLN:HE21	2.27	0.46
4:F:159:GLY:C	4:F:160:ILE:HD12	2.35	0.46
2:B:67:LEU:HD22	2:B:92:PHE:CE2	2.50	0.46
1:C:98:ASP:HB2	5:C:501:GTP:O2G	2.14	0.46
2:D:109:THR:O	2:D:113:GLU:HG2	2.15	0.46
1:A:101:ASN:HD22	2:B:258:ASN:HD21	1.63	0.46
2:B:203:CYS:SG	2:B:267:PHE:HB3	2.55	0.46
1:A:164:LYS:HE2	11:A:651:HOH:O	2.15	0.46
1:C:93:ILE:HG22	1:C:114:ILE:HD11	1.98	0.46
2:B:276:THR:HG21	2:B:281:GLN:O	2.16	0.46
1:C:136:LEU:HD23	1:C:167:LEU:HB2	1.98	0.46
4:F:320:MET:HG3	4:F:330:ILE:HD11	1.96	0.46
2:D:332:MET:O	2:D:336:GLN:HG3	2.16	0.46
4:F:200:ASP:OD1	4:F:222:ARG:HB2	2.16	0.46
1:C:227:LEU:O	1:C:231:ILE:HG13	2.15	0.45
2:D:104:ALA:HB2	2:D:413:MET:SD	2.57	0.45
1:A:433:GLU:HG3	1:A:437:VAL:HG21	1.98	0.45

Continued on next page...

Continued from previous page...

Atom-1	Atom-2	Interatomic distance (Å)	Clash overlap (Å)
2:B:88:ARG:NH1	2:B:90:ASP:HB2	2.31	0.45
4:F:178:GLN:HE21	4:F:180:HIS:HE1	1.65	0.45
2:B:7:ILE:O	2:B:137:LEU:HA	2.17	0.45
2:B:249:ASN:O	2:B:250:ALA:HB3	2.17	0.45
2:B:208:ALA:HB2	2:B:304:ALA:CB	2.41	0.45
4:F:103:THR:HG23	4:F:128:ARG:NH2	2.31	0.45
2:D:180:THR:O	2:D:183:GLU:HG3	2.17	0.45
1:A:93:ILE:CD1	1:A:121:ARG:HG3	2.48	0.44
2:B:332:MET:O	2:B:336:GLN:HG3	2.17	0.44
2:D:387:LEU:HD23	2:D:387:LEU:C	2.37	0.44
1:A:409:VAL:HA	1:A:413:MET:O	2.18	0.44
2:B:2:ARG:HD3	2:B:133:GLN:NE2	2.33	0.44
2:D:21:TRP:CE3	2:D:63:PRO:HB3	2.52	0.44
2:B:123:ARG:O	2:B:127:GLU:HG3	2.16	0.44
2:B:165:ILE:HD13	2:B:199:ASP:HB2	2.00	0.44
2:B:205:ASP:OD1	2:B:207:GLU:N	2.43	0.44
1:A:233:GLN:HG3	1:A:368:LEU:CD1	2.47	0.44
1:A:293:ASN:OD1	1:A:339:ARG:NH2	2.40	0.44
2:D:9:ALA:HA	2:D:68:VAL:O	2.18	0.44
2:D:288:VAL:HB	2:D:289:PRO:HD3	1.98	0.44
1:A:75:ILE:HB	1:A:94:THR:CG2	2.48	0.44
2:B:4:ILE:CD1	2:B:252:LEU:HD11	2.47	0.44
2:B:6:HIS:CD2	2:B:21:TRP:HE1	2.35	0.44
2:B:63:PRO:HD3	2:B:86:ILE:HG12	1.99	0.44
2:B:75:MET:HE3	2:B:92:PHE:CD2	2.53	0.44
2:D:1:MET:HE2	2:D:50:ASN:HB2	1.98	0.44
1:A:141:PHE:O	1:A:147:SER:HB3	2.18	0.44
2:B:165:ILE:CD1	2:B:199:ASP:HB2	2.48	0.44
1:A:70:LEU:HD13	1:A:110:ILE:HG21	2.00	0.44
1:A:142:GLY:HA3	1:A:183:GLU:HG2	2.00	0.43
2:D:396:THR:O	2:D:400:ARG:HG2	2.17	0.43
1:A:196:GLU:OE1	1:A:196:GLU:HA	2.18	0.43
2:D:115:VAL:HG23	2:D:153:LEU:HD23	1.99	0.43
4:F:173:ILE:HD13	4:F:180:HIS:HB2	2.00	0.43
4:F:263:PHE:CE1	4:F:341:LYS:HE2	2.53	0.43
2:B:385:GLN:OE1	2:B:389:LYS:HE3	2.19	0.43
1:C:196:GLU:HG2	11:C:639:HOH:O	2.17	0.43
1:A:142:GLY:CA	1:A:183:GLU:HG2	2.49	0.43
1:A:234:ILE:HD12	1:A:234:ILE:N	2.33	0.43
2:D:295:MET:CE	2:D:377:PHE:HB2	2.39	0.43
2:B:32:PRO:HA	2:B:83:PHE:CD2	2.54	0.43

Continued on next page...

Continued from previous page...

Atom-1	Atom-2	Interatomic distance (Å)	Clash overlap (Å)
2:B:67:LEU:N	2:B:67:LEU:HD12	2.34	0.43
1:C:7:ILE:HG21	1:C:153:LEU:HD21	1.99	0.43
4:F:244:CYS:O	4:F:248:GLU:HB2	2.18	0.43
4:F:6:VAL:HB	4:F:29:ARG:NH2	2.34	0.43
4:F:341:LYS:HG2	4:F:341:LYS:O	2.19	0.43
2:D:16:ILE:HD11	2:D:138:THR:HB	2.00	0.43
2:B:264:ARG:NH1	2:B:431:GLU:OE1	2.52	0.43
1:C:1:MET:CE	1:C:131:GLY:HA3	2.49	0.42
4:F:3:THR:HA	4:F:28:LYS:O	2.18	0.42
4:F:20:LEU:O	4:F:24:THR:HG23	2.19	0.42
2:B:167:ASN:OD1	2:B:200:GLU:HB2	2.19	0.42
2:D:194:LEU:HD22	2:D:198:THR:HG21	2.01	0.42
2:D:412:GLY:C	3:E:133:VAL:HG13	2.40	0.42
2:B:75:MET:HE3	2:B:92:PHE:HD2	1.85	0.42
4:F:148:ILE:HD11	4:F:160:ILE:HG21	2.01	0.42
4:F:240:LEU:HD12	4:F:240:LEU:N	2.35	0.42
4:F:320:MET:CG	4:F:330:ILE:HD11	2.50	0.42
1:C:100:ALA:CB	2:D:253:ARG:HD2	2.50	0.42
4:F:2:TYR:HB2	4:F:27:TRP:CD2	2.54	0.42
1:A:249:ASN:HA	1:A:254:GLU:HB3	2.02	0.42
1:C:344:VAL:HG21	1:C:346:TRP:CE2	2.54	0.42
2:D:67:LEU:N	2:D:67:LEU:HD12	2.34	0.42
1:A:188:ILE:HD12	1:A:395:PHE:HB2	2.01	0.42
2:B:42:LEU:H	2:B:42:LEU:HD12	1.85	0.42
2:B:47:GLU:CG	2:B:245:PRO:HG3	2.43	0.42
2:B:237:GLY:HA3	2:B:376:THR:OG1	2.19	0.42
1:C:108:TYR:O	1:C:112:LYS:HG2	2.20	0.42
4:F:84:SER:O	4:F:88:SER:N	2.42	0.42
2:B:274:PRO:HD2	2:B:371:LEU:HD13	2.02	0.42
2:B:298:SER:HA	2:B:301:MET:HG3	2.02	0.42
1:C:101:ASN:ND2	1:C:180:ALA:HB2	2.34	0.42
1:A:191:THR:O	1:A:195:LEU:HB2	2.20	0.41
1:A:161:TYR:HB3	1:A:164:LYS:HD3	2.02	0.41
2:B:241:CYS:SG	2:B:318:ILE:HG12	2.60	0.41
2:B:323:MET:HB3	2:B:373:MET:HE2	2.01	0.41
1:C:141:PHE:O	1:C:147:SER:HB3	2.20	0.41
4:F:135:TYR:CZ	4:F:166:ALA:HB2	2.55	0.41
4:F:214:TYR:HB3	4:F:375:PHE:HB3	2.01	0.41
2:B:334:ASN:HD21	2:B:338:LYS:HD2	1.85	0.41
2:D:235:MET:O	2:D:239:THR:HG23	2.19	0.41
2:D:316:ALA:HB3	2:D:378:ILE:HB	2.02	0.41

Continued on next page...

Continued from previous page...

Atom-1	Atom-2	Interatomic distance (Å)	Clash overlap (Å)
1:A:25:CYS:SG	1:A:86:LEU:HD11	2.59	0.41
1:A:71:GLU:HG2	1:A:72:PRO:CD	2.50	0.41
1:A:179:THR:HA	2:B:352:LYS:CD	2.51	0.41
2:D:409:THR:HA	2:D:413:MET:O	2.20	0.41
1:C:172:TYR:CE2	1:C:391:LEU:HD22	2.56	0.41
4:F:206:LEU:HD21	4:F:354:ALA:HB2	2.02	0.41
1:A:220:GLU:OE1	2:B:326:LYS:HD2	2.20	0.41
1:C:83:TYR:CD2	1:C:86:LEU:HD22	2.56	0.41
1:C:234:ILE:HG12	1:C:302:MET:HE2	2.01	0.41
2:D:208:ALA:O	2:D:212:ILE:HG13	2.21	0.41
1:A:134:GLY:HA3	1:A:165:SER:O	2.20	0.41
1:A:292:THR:HG22	1:A:335:ILE:HD12	2.02	0.41
2:D:6:HIS:CD2	2:D:21:TRP:HE1	2.38	0.41
1:A:2:ARG:HB3	1:A:131:GLY:O	2.21	0.41
1:A:323:VAL:HG12	1:A:355:ILE:HD13	2.02	0.41
1:C:23:LEU:O	1:C:27:GLU:HG3	2.21	0.41
1:C:391:LEU:HD12	1:C:391:LEU:HA	1.95	0.41
2:D:313:LEU:HD23	2:D:344:VAL:HG11	2.03	0.41
2:B:93:VAL:HG12	2:B:114:LEU:HD11	2.03	0.41
2:B:235:MET:HE2	2:B:235:MET:HB3	1.93	0.41
1:C:140:SER:HA	1:C:171:ILE:HB	2.03	0.41
1:A:391:LEU:HD12	1:A:391:LEU:HA	1.94	0.40
1:C:341:ILE:HD12	1:C:341:ILE:N	2.36	0.40
2:D:179:ASP:OD1	2:D:179:ASP:N	2.45	0.40
1:C:248:LEU:HD12	1:C:357:TYR:OH	2.22	0.40
1:C:285:GLN:H	1:C:285:GLN:HG2	1.68	0.40
3:E:92:ASN:O	3:E:96:MET:HG2	2.21	0.40
3:E:137:LYS:HE2	3:E:141:GLU:OE2	2.21	0.40
1:A:193:THR:HG23	11:A:629:HOH:O	2.20	0.40
2:B:40:SER:OG	2:B:42:LEU:HD13	2.21	0.40
2:D:269:MET:HE3	2:D:381:SER:HB3	2.03	0.40
2:D:385:GLN:O	2:D:389:LYS:HG3	2.22	0.40
4:F:126:ASP:OD2	4:F:128:ARG:HG3	2.21	0.40
4:F:79:LYS:O	4:F:83:THR:OG1	2.33	0.40
4:F:272:MET:HE3	4:F:272:MET:HB2	1.92	0.40
1:A:34:GLY:HA3	1:A:60:LYS:HG3	2.03	0.40
2:B:114:LEU:HG	2:B:114:LEU:O	2.22	0.40
2:B:329:ASP:O	2:B:333:LEU:HG	2.21	0.40
1:C:88:HIS:HE1	1:C:90:GLU:HG3	1.85	0.40
1:C:292:THR:HG22	1:C:335:ILE:HD12	2.03	0.40
4:F:198:LYS:O	4:F:199:PHE:HB3	2.20	0.40

All (2) symmetry-related close contacts are listed below. The label for Atom-2 includes the symmetry operator and encoded unit-cell translations to be applied.

Atom-1	Atom-2	Interatomic distance (Å)	Clash overlap (Å)
1:A:372:GLN:NE2	1:C:337:THR:O[3_555]	2.11	0.09
3:E:80:ARG:NH2	11:C:601:HOH:O[4_555]	2.19	0.01

5.3 Torsion angles [i](#)

5.3.1 Protein backbone [i](#)

In the following table, the Percentiles column shows the percent Ramachandran outliers of the chain as a percentile score with respect to all X-ray entries followed by that with respect to entries of similar resolution.

The Analysed column shows the number of residues for which the backbone conformation was analysed, and the total number of residues.

Mol	Chain	Analysed	Favoured	Allowed	Outliers	Percentiles	
1	A	436/451 (97%)	428 (98%)	8 (2%)	0	100	100
1	C	439/451 (97%)	429 (98%)	10 (2%)	0	100	100
2	B	421/445 (95%)	403 (96%)	15 (4%)	3 (1%)	22	21
2	D	423/445 (95%)	412 (97%)	11 (3%)	0	100	100
3	E	119/143 (83%)	117 (98%)	2 (2%)	0	100	100
4	F	344/384 (90%)	326 (95%)	18 (5%)	0	100	100
All	All	2182/2319 (94%)	2115 (97%)	64 (3%)	3 (0%)	51	60

All (3) Ramachandran outliers are listed below:

Mol	Chain	Res	Type
2	B	247	GLN
2	B	249	ASN
2	B	245	PRO

5.3.2 Protein sidechains [i](#)

In the following table, the Percentiles column shows the percent sidechain outliers of the chain as a percentile score with respect to all X-ray entries followed by that with respect to entries of similar resolution.

The Analysed column shows the number of residues for which the sidechain conformation was

analysed, and the total number of residues.

Mol	Chain	Analysed	Rotameric	Outliers	Percentiles	
1	A	369/379 (97%)	365 (99%)	4 (1%)	73	82
1	C	372/379 (98%)	369 (99%)	3 (1%)	81	88
2	B	367/383 (96%)	365 (100%)	2 (0%)	88	92
2	D	368/383 (96%)	364 (99%)	4 (1%)	73	82
3	E	110/127 (87%)	110 (100%)	0	100	100
4	F	315/342 (92%)	315 (100%)	0	100	100
All	All	1901/1993 (95%)	1888 (99%)	13 (1%)	84	90

All (13) residues with a non-rotameric sidechain are listed below:

Mol	Chain	Res	Type
1	A	221	ARG
1	A	282	TYR
1	A	284	GLU
1	A	316	CYS
2	B	139	HIS
2	B	165	ILE
1	C	71	GLU
1	C	221	ARG
1	C	285	GLN
2	D	39	ASP
2	D	139	HIS
2	D	229	HIS
2	D	325	MET

Sometimes sidechains can be flipped to improve hydrogen bonding and reduce clashes. All (20) such sidechains are listed below:

Mol	Chain	Res	Type
1	A	11	GLN
1	A	15	GLN
1	A	88	HIS
1	A	300	ASN
2	B	15	GLN
2	B	133	GLN
2	B	258	ASN
2	B	282	GLN
2	B	294	GLN
1	C	11	GLN

Continued on next page...

Continued from previous page...

Mol	Chain	Res	Type
1	C	107	HIS
2	D	96	GLN
2	D	167	ASN
2	D	294	GLN
2	D	349	ASN
4	F	180	HIS
4	F	196	HIS
4	F	229	ASN
4	F	269	GLN
4	F	333	ASN

5.3.3 RNA [i](#)

There are no RNA molecules in this entry.

5.4 Non-standard residues in protein, DNA, RNA chains [i](#)

There are no non-standard protein/DNA/RNA residues in this entry.

5.5 Carbohydrates [i](#)

There are no monosaccharides in this entry.

5.6 Ligand geometry [i](#)

Of 16 ligands modelled in this entry, 9 are monoatomic - leaving 7 for Mogul analysis.

In the following table, the Counts columns list the number of bonds (or angles) for which Mogul statistics could be retrieved, the number of bonds (or angles) that are observed in the model and the number of bonds (or angles) that are defined in the Chemical Component Dictionary. The Link column lists molecule types, if any, to which the group is linked. The Z score for a bond length (or angle) is the number of standard deviations the observed value is removed from the expected value. A bond length (or angle) with $|Z| > 2$ is considered an outlier worth inspection. RMSZ is the root-mean-square of all Z scores of the bond lengths (or angles).

Mol	Type	Chain	Res	Link	Bond lengths			Bond angles		
					Counts	RMSZ	# $ Z > 2$	Counts	RMSZ	# $ Z > 2$
5	GTP	C	501	6	26,34,34	1.11	2 (7%)	32,54,54	1.36	5 (15%)
9	O3G	B	504	-	17,17,17	0.10	0	21,21,21	0.18	0
10	ACP	F	401	6	27,33,33	1.42	5 (18%)	32,52,52	1.47	4 (12%)

Mol	Type	Chain	Res	Link	Bond lengths			Bond angles		
					Counts	RMSZ	# Z > 2	Counts	RMSZ	# Z > 2
5	GTP	A	501	6	26,34,34	1.13	2 (7%)	32,54,54	1.37	5 (15%)
8	GDP	D	501	6	24,30,30	0.95	1 (4%)	30,47,47	1.21	4 (13%)
8	GDP	B	501	6	24,30,30	0.92	1 (4%)	30,47,47	1.12	3 (10%)
9	O3G	B	505	-	17,17,17	0.12	0	21,21,21	0.14	0

In the following table, the Chirals column lists the number of chiral outliers, the number of chiral centers analysed, the number of these observed in the model and the number defined in the Chemical Component Dictionary. Similar counts are reported in the Torsion and Rings columns. '-' means no outliers of that kind were identified.

Mol	Type	Chain	Res	Link	Chirals	Torsions	Rings
5	GTP	C	501	6	-	9/18/38/38	0/3/3/3
9	O3G	B	504	-	-	0/6/6/6	0/2/2/2
10	ACP	F	401	6	-	9/15/38/38	0/3/3/3
5	GTP	A	501	6	-	7/18/38/38	0/3/3/3
8	GDP	D	501	6	-	2/12/32/32	0/3/3/3
8	GDP	B	501	6	-	3/12/32/32	0/3/3/3
9	O3G	B	505	-	-	0/6/6/6	0/2/2/2

All (11) bond length outliers are listed below:

Mol	Chain	Res	Type	Atoms	Z	Observed(Å)	Ideal(Å)
5	A	501	GTP	C5-C6	-4.00	1.39	1.47
5	C	501	GTP	C5-C6	-3.81	1.39	1.47
10	F	401	ACP	PG-O2G	3.04	1.61	1.54
10	F	401	ACP	PB-O3A	2.97	1.61	1.58
10	F	401	ACP	PG-O3G	2.93	1.61	1.54
10	F	401	ACP	C5-C4	2.55	1.47	1.40
8	D	501	GDP	C6-N1	-2.36	1.34	1.37
8	B	501	GDP	C6-N1	-2.27	1.34	1.37
10	F	401	ACP	PB-O2B	2.27	1.61	1.56
5	C	501	GTP	C2-N3	2.22	1.38	1.33
5	A	501	GTP	C2-N3	2.12	1.38	1.33

All (21) bond angle outliers are listed below:

Mol	Chain	Res	Type	Atoms	Z	Observed(°)	Ideal(°)
10	F	401	ACP	PB-O3A-PA	-3.77	120.61	132.56
10	F	401	ACP	C3'-C2'-C1'	3.62	106.43	100.98
8	D	501	GDP	PA-O3A-PB	-3.40	121.17	132.83

Continued on next page...

Continued from previous page...

Mol	Chain	Res	Type	Atoms	Z	Observed(°)	Ideal(°)
5	C	501	GTP	C8-N7-C5	3.15	109.00	102.99
10	F	401	ACP	N3-C2-N1	-3.15	123.76	128.68
5	A	501	GTP	C8-N7-C5	3.03	108.76	102.99
5	A	501	GTP	C5-C6-N1	3.02	119.29	113.95
5	C	501	GTP	C5-C6-N1	2.94	119.15	113.95
5	A	501	GTP	PA-O3A-PB	-2.88	122.96	132.83
5	C	501	GTP	PA-O3A-PB	-2.82	123.15	132.83
5	C	501	GTP	PB-O3B-PG	-2.65	123.73	132.83
10	F	401	ACP	C4-C5-N7	-2.63	106.66	109.40
5	C	501	GTP	C2-N1-C6	-2.62	120.28	125.10
5	A	501	GTP	C2-N1-C6	-2.61	120.28	125.10
8	B	501	GDP	PA-O3A-PB	-2.60	123.91	132.83
8	B	501	GDP	C5-C6-N1	2.56	118.47	113.95
5	A	501	GTP	PB-O3B-PG	-2.48	124.30	132.83
8	D	501	GDP	C8-N7-C5	2.43	107.62	102.99
8	B	501	GDP	C8-N7-C5	2.43	107.61	102.99
8	D	501	GDP	C5-C6-N1	2.27	117.97	113.95
8	D	501	GDP	C3'-C2'-C1'	2.16	104.23	100.98

There are no chirality outliers.

All (30) torsion outliers are listed below:

Mol	Chain	Res	Type	Atoms
5	A	501	GTP	C5'-O5'-PA-O1A
5	A	501	GTP	C5'-O5'-PA-O2A
5	C	501	GTP	C5'-O5'-PA-O1A
5	C	501	GTP	C5'-O5'-PA-O2A
8	B	501	GDP	C5'-O5'-PA-O1A
8	B	501	GDP	C5'-O5'-PA-O2A
8	D	501	GDP	C5'-O5'-PA-O3A
10	F	401	ACP	PB-C3B-PG-O1G
10	F	401	ACP	PB-C3B-PG-O2G
10	F	401	ACP	PB-C3B-PG-O3G
10	F	401	ACP	PG-C3B-PB-O1B
10	F	401	ACP	PG-C3B-PB-O2B
10	F	401	ACP	PG-C3B-PB-O3A
10	F	401	ACP	C5'-O5'-PA-O2A
10	F	401	ACP	C5'-O5'-PA-O3A
5	C	501	GTP	PB-O3B-PG-O1G
5	A	501	GTP	PB-O3B-PG-O2G
8	D	501	GDP	C5'-O5'-PA-O2A
10	F	401	ACP	PB-O3A-PA-O2A

Continued on next page...

Continued from previous page...

Mol	Chain	Res	Type	Atoms
5	A	501	GTP	C4'-C5'-O5'-PA
5	C	501	GTP	C4'-C5'-O5'-PA
5	C	501	GTP	PB-O3B-PG-O2G
5	C	501	GTP	PB-O3B-PG-O3G
5	A	501	GTP	C5'-O5'-PA-O3A
5	C	501	GTP	C5'-O5'-PA-O3A
8	B	501	GDP	C5'-O5'-PA-O3A
5	A	501	GTP	PB-O3A-PA-O1A
5	A	501	GTP	PB-O3A-PA-O2A
5	C	501	GTP	PB-O3A-PA-O1A
5	C	501	GTP	PB-O3A-PA-O2A

There are no ring outliers.

5 monomers are involved in 7 short contacts:

Mol	Chain	Res	Type	Clashes	Symm-Clashes
5	C	501	GTP	1	0
9	B	504	O3G	1	0
10	F	401	ACP	3	0
5	A	501	GTP	1	0
8	D	501	GDP	1	0

The following is a two-dimensional graphical depiction of Mogul quality analysis of bond lengths, bond angles, torsion angles, and ring geometry for all instances of the Ligand of Interest. In addition, ligands with molecular weight > 250 and outliers as shown on the validation Tables will also be included. For torsion angles, if less than 5% of the Mogul distribution of torsion angles is within 10 degrees of the torsion angle in question, then that torsion angle is considered an outlier. Any bond that is central to one or more torsion angles identified as an outlier by Mogul will be highlighted in the graph. For rings, the root-mean-square deviation (RMSD) between the ring in question and similar rings identified by Mogul is calculated over all ring torsion angles. If the average RMSD is greater than 60 degrees and the minimal RMSD between the ring in question and any Mogul-identified rings is also greater than 60 degrees, then that ring is considered an outlier. The outliers are highlighted in purple. The color gray indicates Mogul did not find sufficient equivalents in the CSD to analyse the geometry.

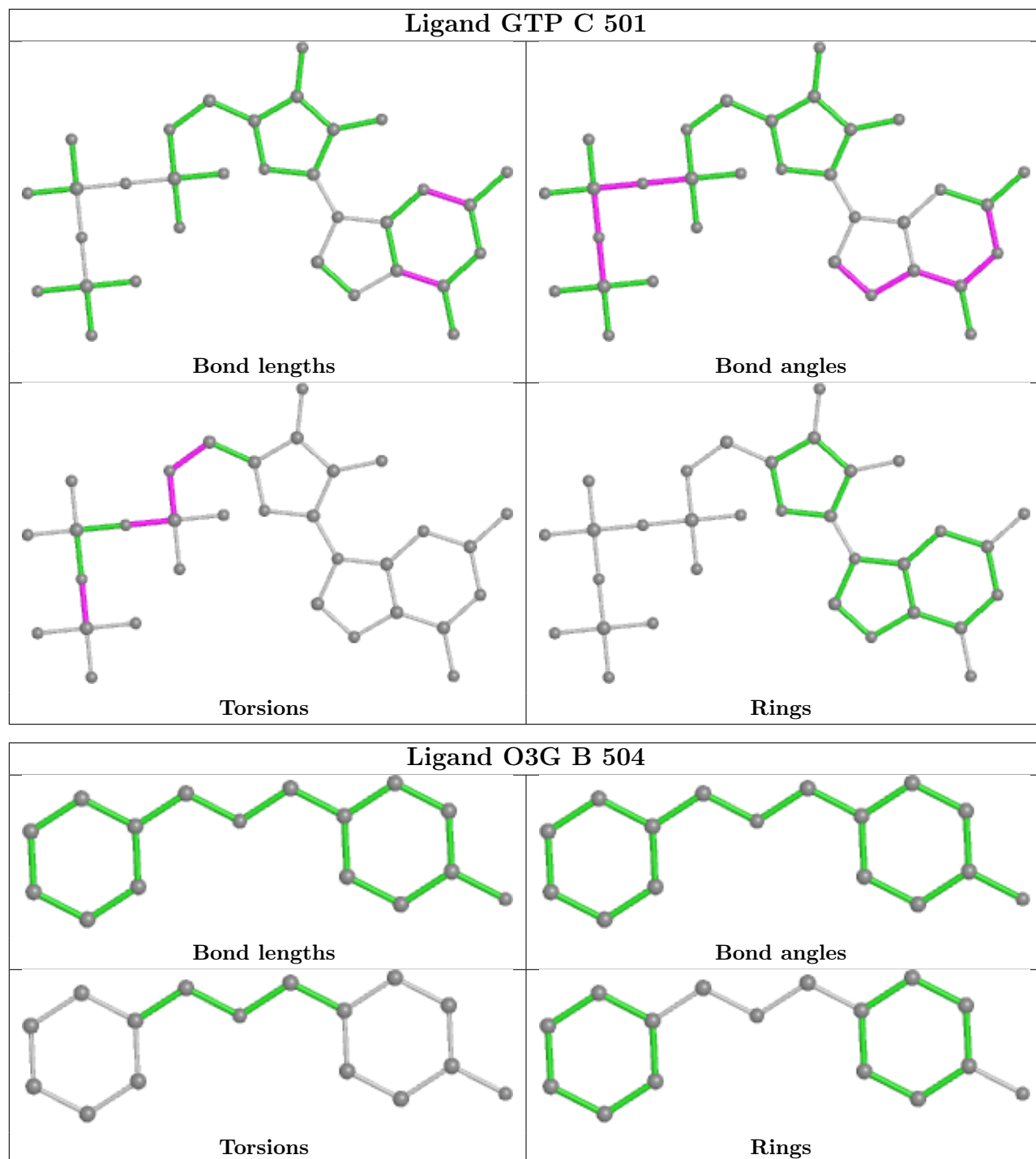

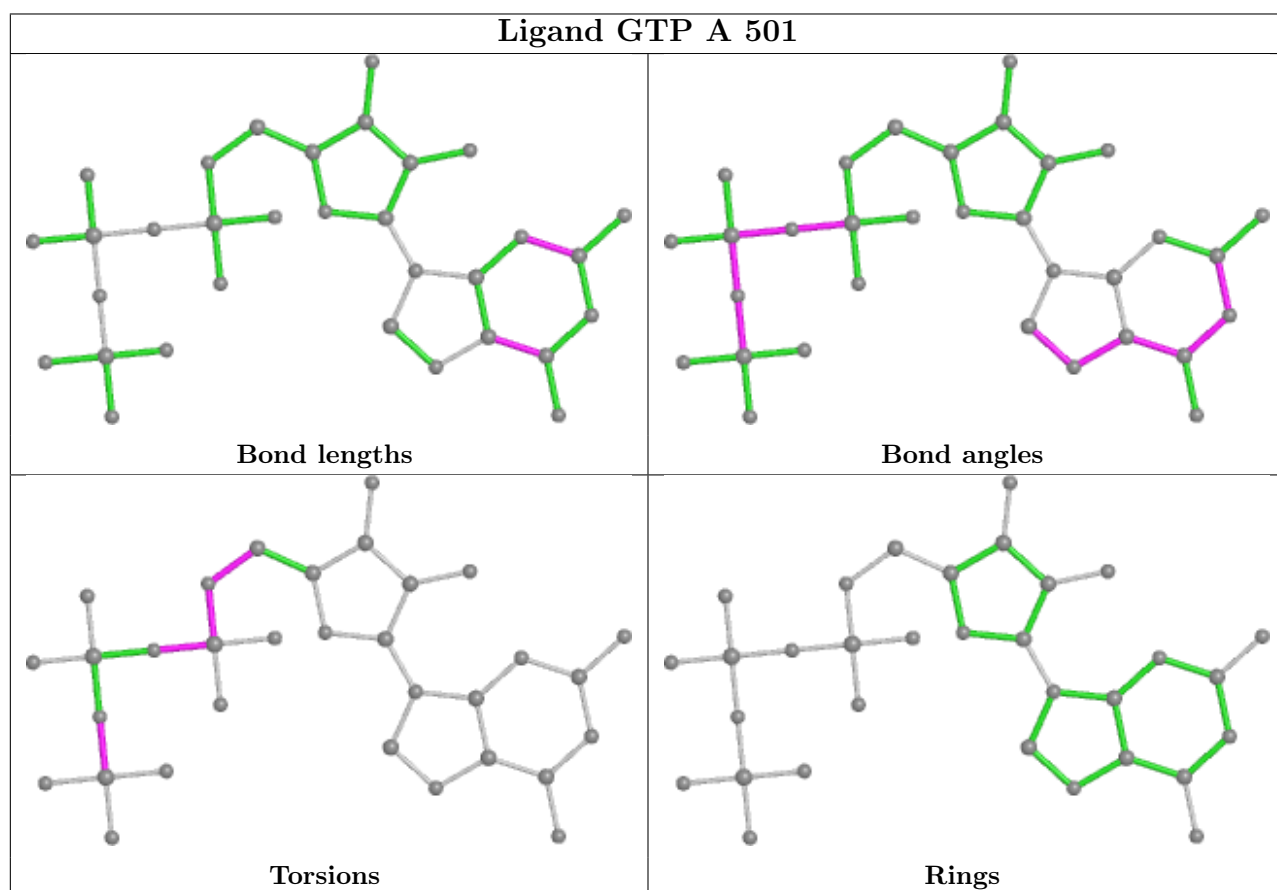
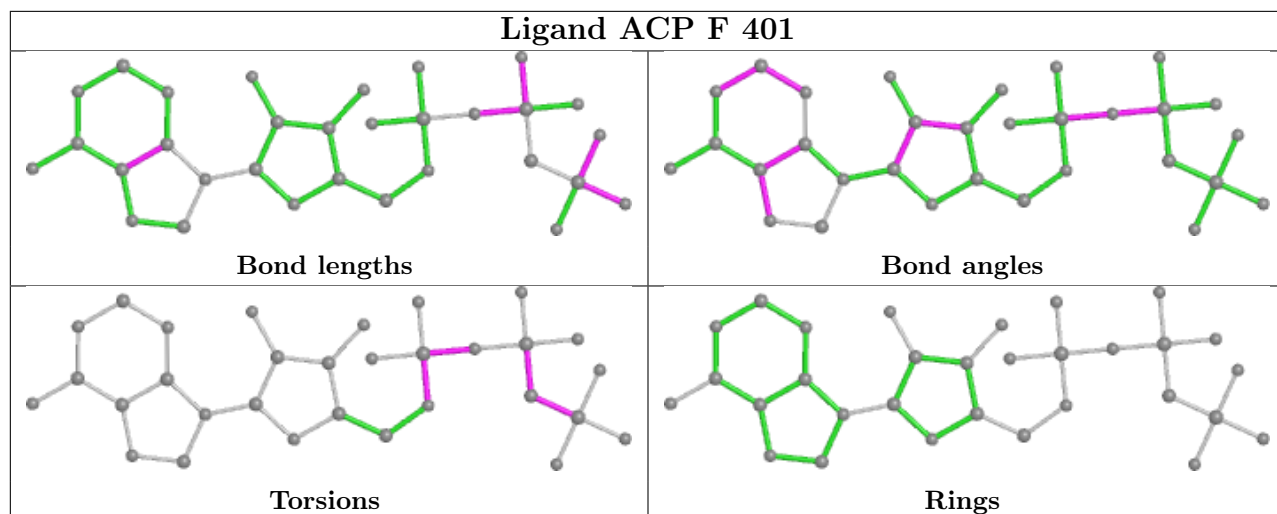

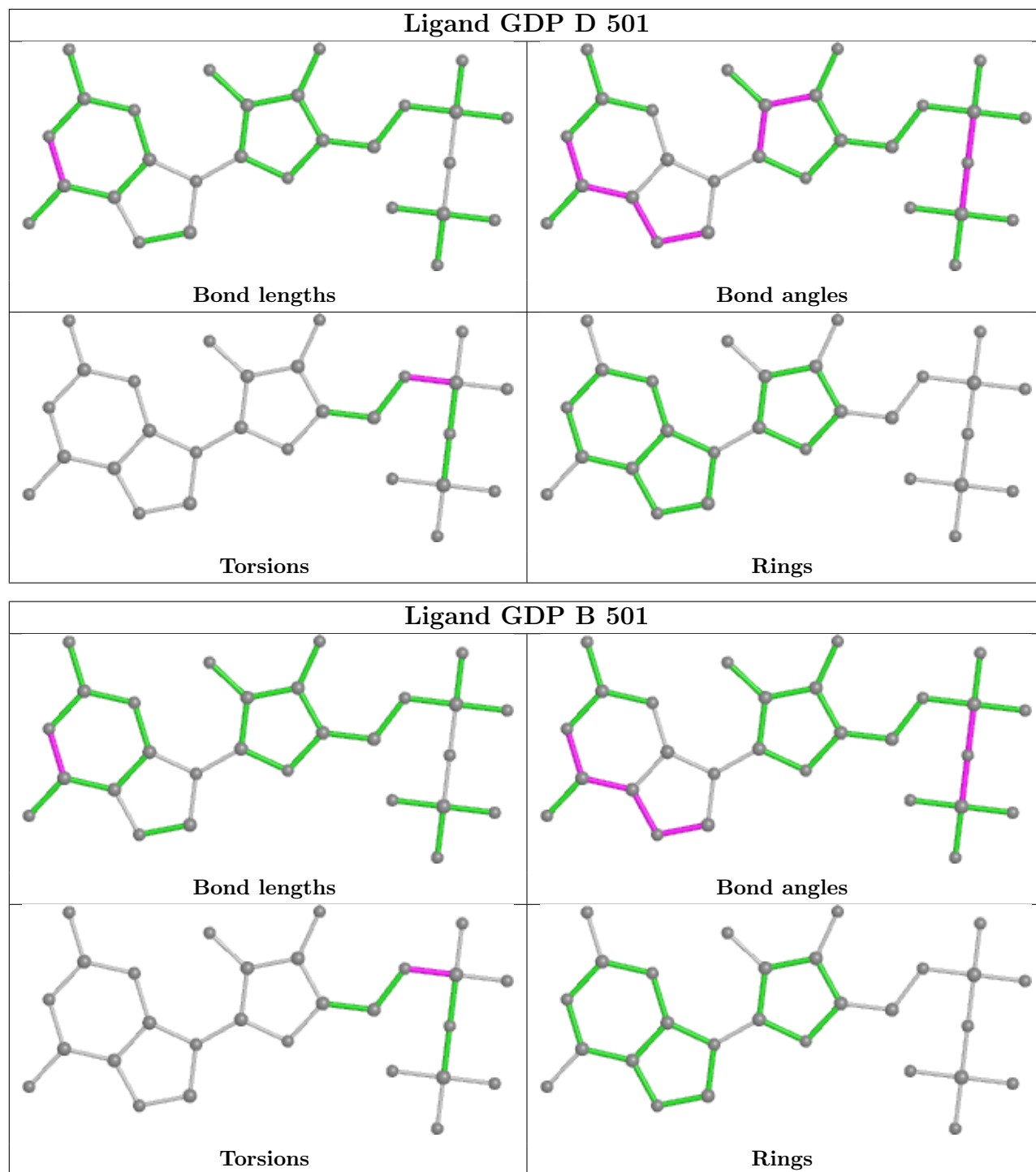

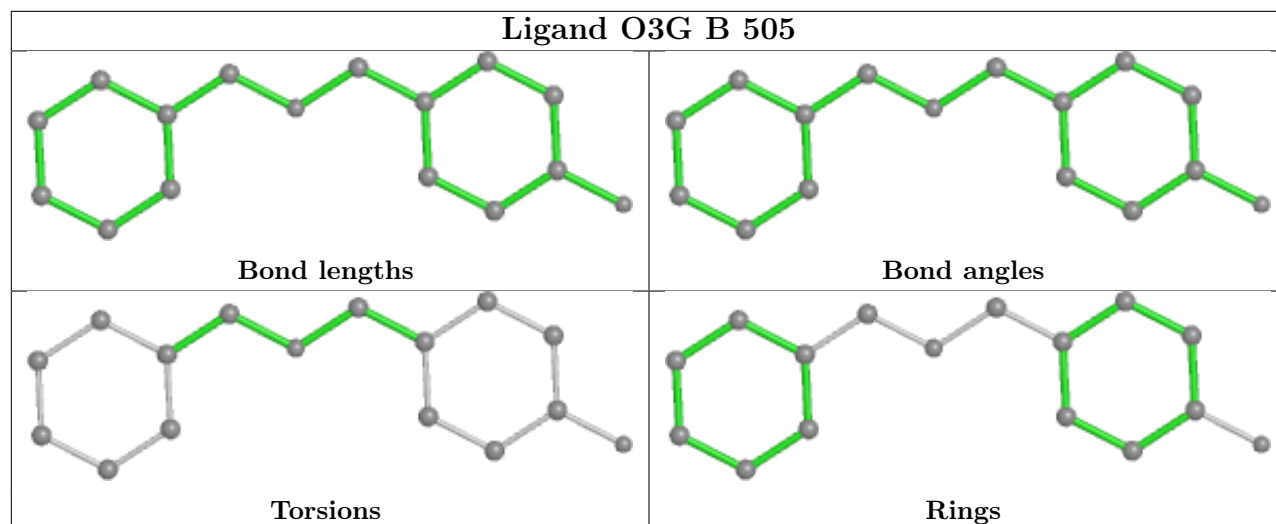

5.7 Other polymers [i](#)

There are no such residues in this entry.

5.8 Polymer linkage issues [i](#)

There are no chain breaks in this entry.

6 Fit of model and data

6.1 Protein, DNA and RNA chains

In the following table, the column labelled ‘#RSRZ > 2’ contains the number (and percentage) of RSRZ outliers, followed by percent RSRZ outliers for the chain as percentile scores relative to all X-ray entries and entries of similar resolution. The OWAB column contains the minimum, median, 95th percentile and maximum values of the occupancy-weighted average B-factor per residue. The column labelled ‘Q < 0.9’ lists the number of (and percentage) of residues with an average occupancy less than 0.9.

Mol	Chain	Analysed	<RSRZ>	#RSRZ>2	OWAB(Å ²)	Q<0.9
1	A	438/451 (97%)	0.36	11 (2%) 57 60	54, 75, 112, 176	0
1	C	440/451 (97%)	0.36	10 (2%) 60 63	47, 60, 86, 124	0
2	B	425/445 (95%)	0.49	14 (3%) 46 48	46, 70, 116, 187	1 (0%)
2	D	427/445 (95%)	0.44	24 (5%) 24 26	56, 84, 122, 166	4 (0%)
3	E	123/143 (86%)	0.82	15 (12%) 4 3	57, 87, 129, 173	0
4	F	352/384 (91%)	0.70	46 (13%) 3 3	64, 99, 168, 220	0
All	All	2205/2319 (95%)	0.48	120 (5%) 25 28	46, 76, 137, 220	5 (0%)

All (120) RSRZ outliers are listed below:

Mol	Chain	Res	Type	RSRZ
3	E	116	LEU	9.1
2	B	281	GLN	8.7
2	B	1	MET	8.1
2	D	276	THR	6.2
2	D	277	SER	6.1
4	F	169	LEU	6.0
4	F	173	ILE	5.7
4	F	381	HIS	5.5
4	F	104	ASN	5.3
2	D	280	SER	4.8
2	B	284	ARG	4.8
2	D	218	LYS	4.8
4	F	140	GLU	4.7
4	F	179	VAL	4.6
4	F	152	SER	4.5
2	B	276	THR	4.5
4	F	105	LEU	4.5
1	C	163	LYS	4.4
4	F	130	VAL	4.4

Continued on next page...

Continued from previous page...

Mol	Chain	Res	Type	RSRZ
4	F	131	PHE	4.3
4	F	137	ARG	4.3
2	D	57	THR	4.3
1	A	88	HIS	4.2
4	F	89	GLU	4.2
4	F	132	LEU	4.1
1	C	341	ILE	4.1
3	E	27	PRO	4.1
2	D	1	MET	4.0
3	E	26	PRO	4.0
4	F	379	HIS	4.0
1	A	282	TYR	3.9
4	F	177	GLY	3.9
4	F	240	LEU	3.9
4	F	136	ASN	3.9
1	A	438	ASP	3.8
2	B	283	TYR	3.8
4	F	249	TYR	3.8
1	C	302	MET	3.7
4	F	142	ARG	3.7
2	D	217	LEU	3.7
4	F	176	GLN	3.6
2	D	404	PHE	3.6
4	F	170	LEU	3.6
4	F	138	ARG	3.5
3	E	123	LEU	3.5
2	B	59	ASN	3.5
4	F	382	HIS	3.5
1	C	179	THR	3.5
2	D	415	GLU	3.4
4	F	251	LYS	3.4
2	B	277	SER	3.4
3	E	6	MET	3.4
4	F	99	VAL	3.3
3	E	119	MET	3.3
2	D	278	ARG	3.3
3	E	120	LEU	3.2
4	F	103	THR	3.2
2	B	333	LEU	3.2
4	F	100	ILE	3.2
3	E	122	ARG	3.1
2	D	42	LEU	3.1

Continued on next page...

Continued from previous page...

Mol	Chain	Res	Type	RSRZ
2	B	275	LEU	3.0
2	D	37	HIS	3.0
4	F	182	ILE	3.0
2	D	401	ARG	3.0
2	B	57	THR	3.0
4	F	380	HIS	3.0
4	F	243	HIS	2.9
1	A	118	VAL	2.9
1	A	262	TYR	2.9
4	F	178	GLN	2.9
4	F	234	GLN	2.9
4	F	155	ALA	2.8
3	E	24	LEU	2.8
2	B	242	LEU	2.7
2	D	281	GLN	2.7
2	D	272	PHE	2.7
4	F	223	THR	2.7
4	F	244	CYS	2.7
2	D	182	VAL	2.7
1	A	221	ARG	2.6
1	A	163	LYS	2.6
2	B	318	ILE	2.6
2	B	337	ASN	2.6
3	E	139	LEU	2.6
4	F	233	PHE	2.6
2	D	241	CYS	2.6
4	F	250	SER	2.6
2	B	285	ALA	2.6
3	E	80	ARG	2.6
2	D	279	GLY	2.5
1	C	282	TYR	2.5
3	E	143	ALA	2.5
2	D	299	LYS	2.5
4	F	159	GLY	2.5
2	D	219	LEU	2.5
2	D	248	LEU	2.5
2	D	275	LEU	2.5
1	A	284	GLU	2.4
1	C	340	SER	2.4
3	E	124	GLN	2.3
4	F	248	GLU	2.3
1	A	179	THR	2.3

Continued on next page...

Continued from previous page...

Mol	Chain	Res	Type	RSRZ
4	F	125	THR	2.3
2	D	293	GLN	2.3
3	E	115	HIS	2.3
4	F	153	ALA	2.3
4	F	253	TYR	2.3
4	F	143	GLU	2.3
1	A	362	VAL	2.3
1	C	308	ARG	2.2
4	F	139	ARG	2.2
2	D	229	HIS	2.2
3	E	59	GLU	2.2
4	F	154	GLY	2.1
1	A	335	ILE	2.1
1	C	276	ILE	2.1
4	F	161	LEU	2.0
1	C	177	VAL	2.0
1	C	218	ASP	2.0

6.2 Non-standard residues in protein, DNA, RNA chains [i](#)

There are no non-standard protein/DNA/RNA residues in this entry.

6.3 Carbohydrates [i](#)

There are no monosaccharides in this entry.

6.4 Ligands [i](#)

In the following table, the Atoms column lists the number of modelled atoms in the group and the number defined in the chemical component dictionary. The B-factors column lists the minimum, median, 95th percentile and maximum values of B factors of atoms in the group. The column labelled 'Q< 0.9' lists the number of atoms with occupancy less than 0.9.

Mol	Type	Chain	Res	Atoms	RSCC	RSR	B-factors(Å ²)	Q<0.9
7	CA	B	503	1/1	0.72	0.17	115,115,115,115	0
10	ACP	F	401	31/31	0.79	0.13	103,112,123,129	0
9	O3G	B	505	16/16	0.90	0.18	56,67,76,82	30
6	MG	C	502	1/1	0.91	0.15	49,49,49,49	0
9	O3G	B	504	16/16	0.92	0.16	57,70,83,84	30
7	CA	A	504	1/1	0.94	0.06	99,99,99,99	0

Continued on next page...

Continued from previous page...

Mol	Type	Chain	Res	Atoms	RSCC	RSR	B-factors(\AA^2)	Q<0.9
6	MG	A	502	1/1	0.94	0.15	61,61,61,61	0
8	GDP	D	501	28/28	0.94	0.17	72,79,88,93	0
6	MG	D	502	1/1	0.96	0.13	83,83,83,83	0
7	CA	A	503	1/1	0.96	0.10	102,102,102,102	0
6	MG	B	502	1/1	0.97	0.17	40,40,40,40	0
6	MG	F	402	1/1	0.97	0.06	109,109,109,109	0
5	GTP	A	501	32/32	0.97	0.14	50,57,61,61	0
5	GTP	C	501	32/32	0.98	0.17	43,49,55,58	0
7	CA	C	503	1/1	0.98	0.12	82,82,82,82	0
8	GDP	B	501	28/28	0.99	0.16	38,51,54,58	0

The following is a graphical depiction of the model fit to experimental electron density of all instances of the Ligand of Interest. In addition, ligands with molecular weight > 250 and outliers as shown on the geometry validation Tables will also be included. Each fit is shown from different orientation to approximate a three-dimensional view.

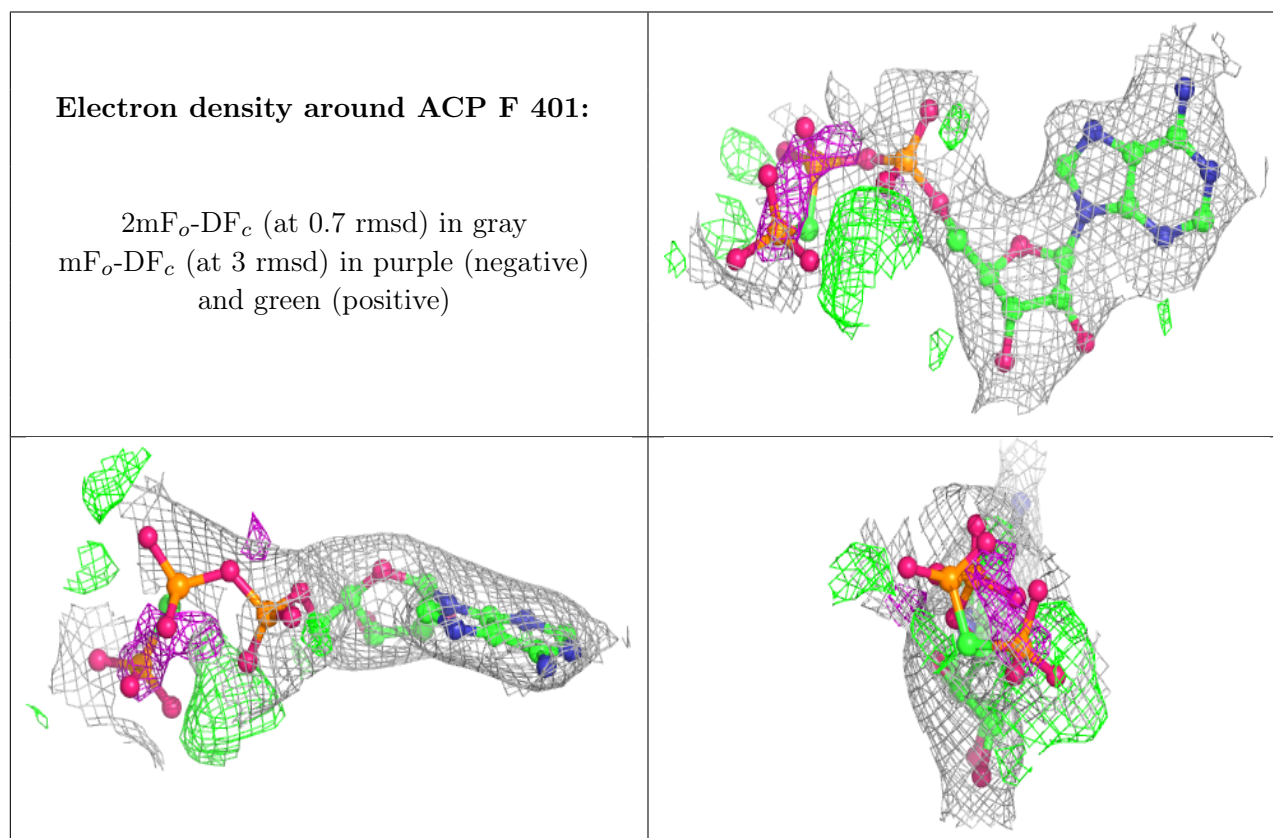

Electron density around O3G B 505:

$2mF_o-DF_c$ (at 0.7 rmsd) in gray
 mF_o-DF_c (at 3 rmsd) in purple (negative)
and green (positive)

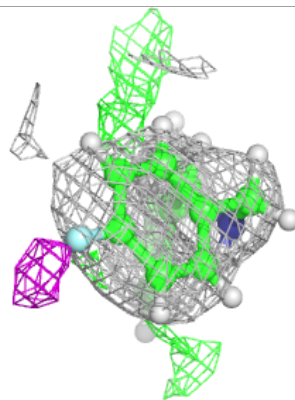
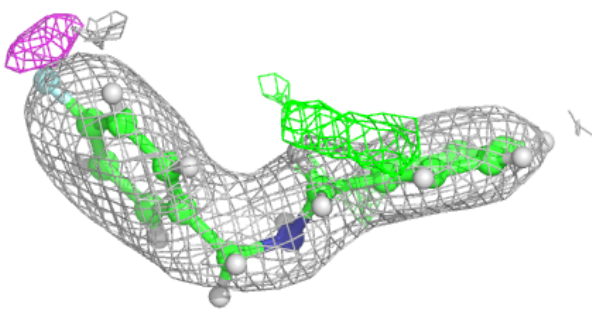
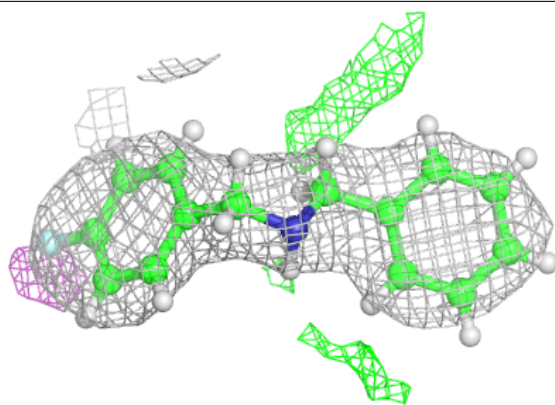
**Electron density around O3G B 504:**

$2mF_o-DF_c$ (at 0.7 rmsd) in gray
 mF_o-DF_c (at 3 rmsd) in purple (negative)
and green (positive)

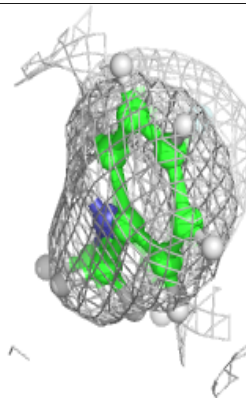
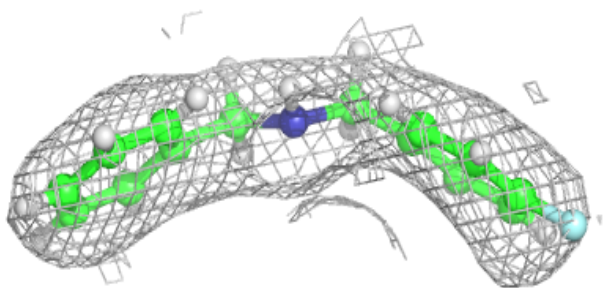
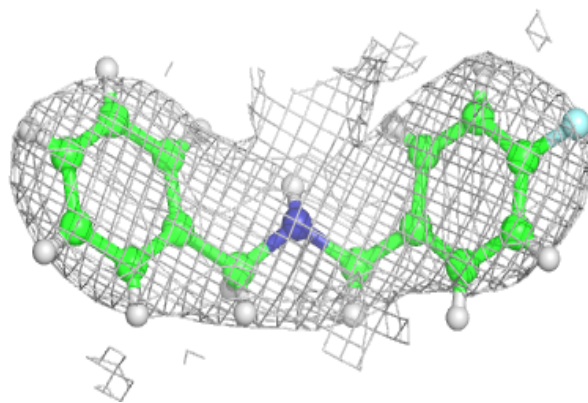

Electron density around GDP D 501:

$2mF_o-DF_c$ (at 0.7 rmsd) in gray
 mF_o-DF_c (at 3 rmsd) in purple (negative)
and green (positive)

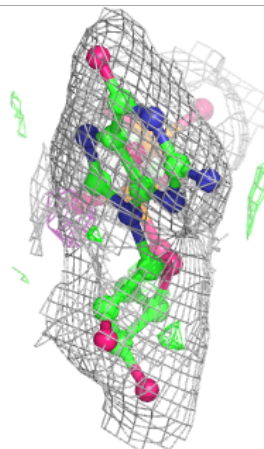
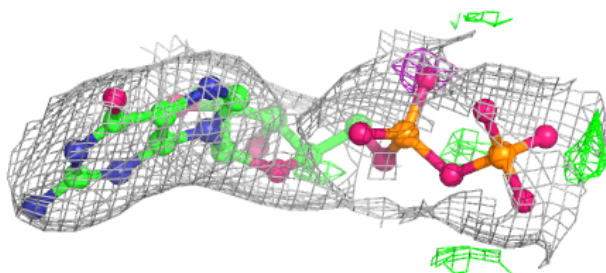
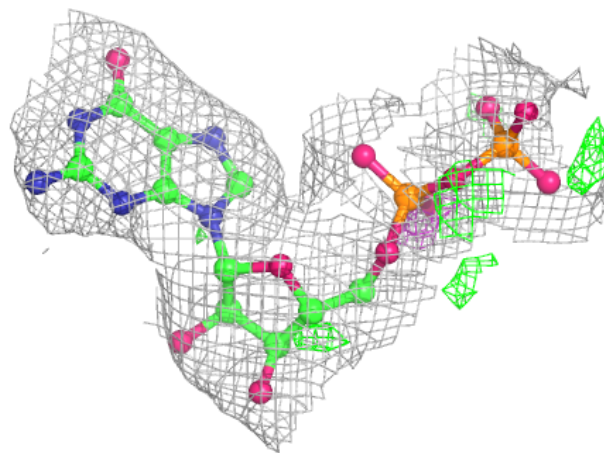

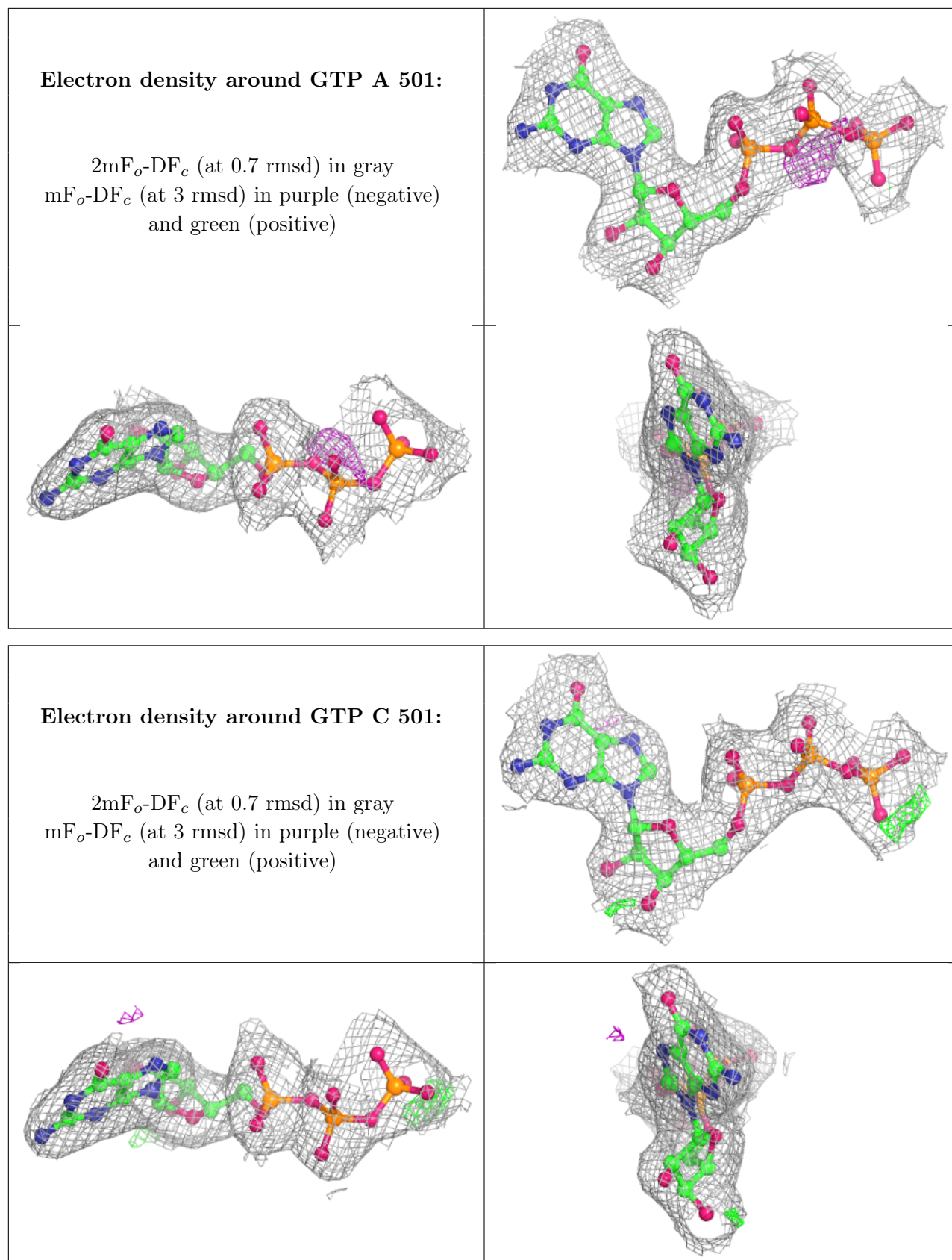

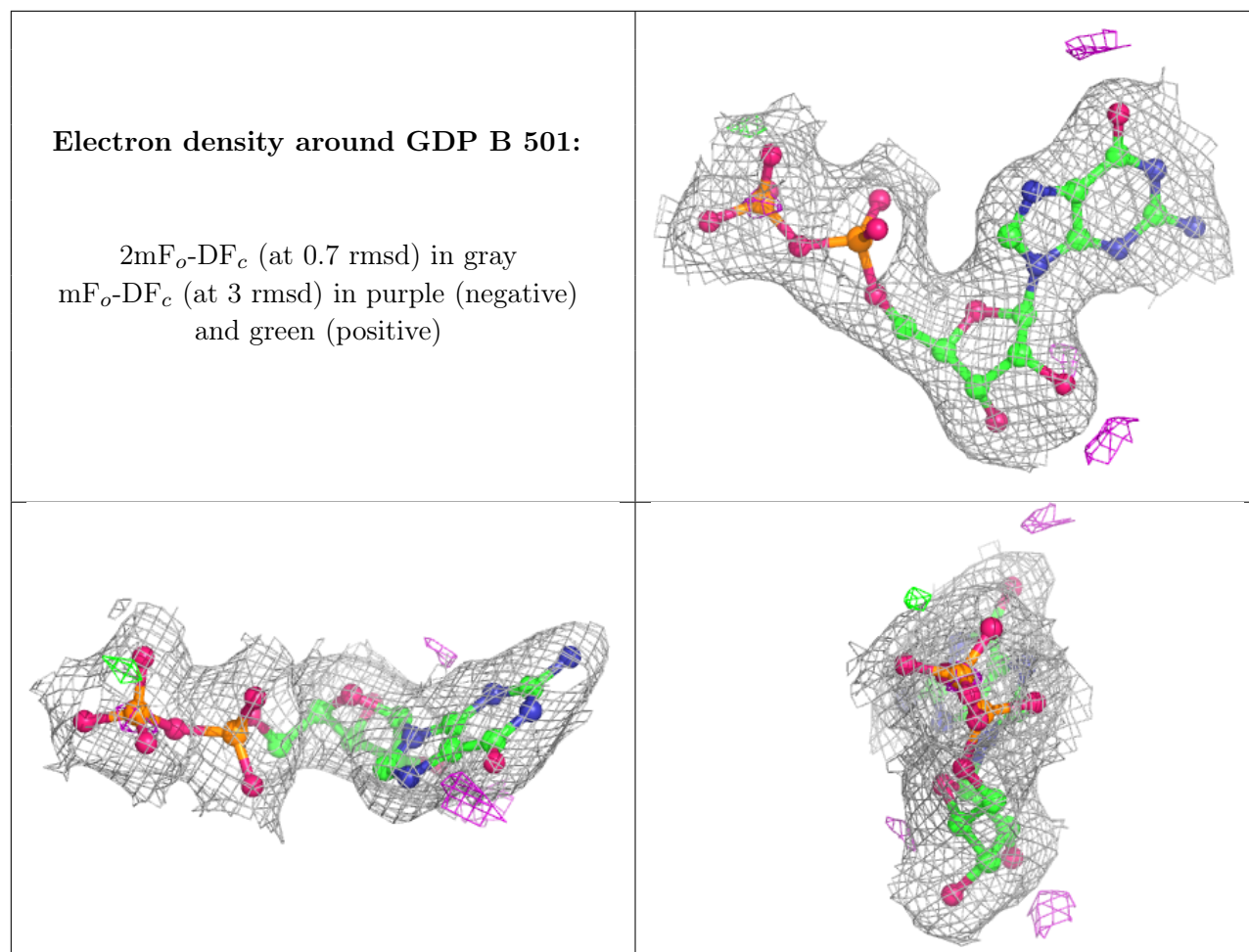

6.5 Other polymers [i](#)

There are no such residues in this entry.