



Full wwPDB EM Validation Report ⓘ

Nov 20, 2022 – 06:52 AM EST

PDB ID : 7S8C
EMDB ID : EMD-24893
Title : Cryo-EM structure of human TRPV6 in complex with inhibitor econazole
Authors : Neuberger, A.; Nadezhdin, K.D.; Sobolevsky, A.I.
Deposited on : 2021-09-17
Resolution : 2.85 Å (reported)
Based on initial model : 7K4B

This is a Full wwPDB EM Validation Report for a publicly released PDB entry.

We welcome your comments at validation@mail.wwpdb.org

A user guide is available at

<https://www.wwpdb.org/validation/2017/EMValidationReportHelp>

with specific help available everywhere you see the ⓘ symbol.

The types of validation reports are described at

<http://www.wwpdb.org/validation/2017/FAQs#types>.

The following versions of software and data (see [references ⓘ](#)) were used in the production of this report:

EMDB validation analysis : 0.0.1.dev43
Mogul : 1.8.5 (274361), CSD as541be (2020)
MolProbity : 4.02b-467
buster-report : 1.1.7 (2018)
Percentile statistics : 20191225.v01 (using entries in the PDB archive December 25th 2019)
MapQ : 1.9.9
Ideal geometry (proteins) : Engh & Huber (2001)
Ideal geometry (DNA, RNA) : Parkinson et al. (1996)
Validation Pipeline (wwPDB-VP) : 2.31.3

1 Overall quality at a glance

The following experimental techniques were used to determine the structure:

ELECTRON MICROSCOPY

The reported resolution of this entry is 2.85 Å.

Percentile scores (ranging between 0-100) for global validation metrics of the entry are shown in the following graphic. The table shows the number of entries on which the scores are based.

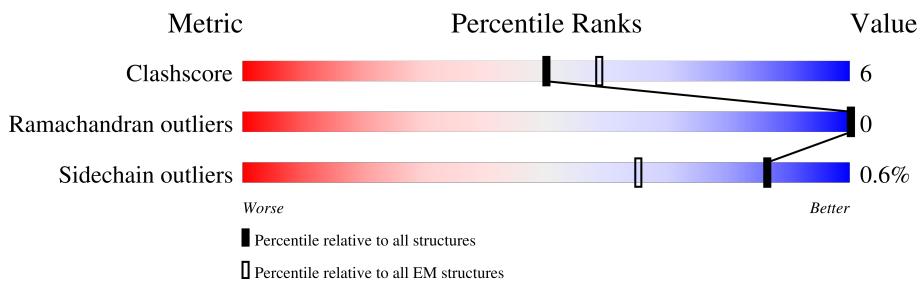

Metric	Whole archive (#Entries)	EM structures (#Entries)
Clashscore	158937	4297
Ramachandran outliers	154571	4023
Sidechain outliers	154315	3826

The table below summarises the geometric issues observed across the polymeric chains and their fit to the map. The red, orange, yellow and green segments of the bar indicate the fraction of residues that contain outliers for ≥ 3 , 2, 1 and 0 types of geometric quality criteria respectively. A grey segment represents the fraction of residues that are not modelled. The numeric value for each fraction is indicated below the corresponding segment, with a dot representing fractions $\leq 5\%$. The upper red bar (where present) indicates the fraction of residues that have poor fit to the EM map (all-atom inclusion $< 40\%$). The numeric value is given above the bar.

Mol	Chain	Length	Quality of chain
1	A	683	 8% 78% 12% 10%
1	B	683	 8% 79% 11% 10%
1	C	683	 8% 79% 11% 10%
1	D	683	 8% 78% 11% 10%

2 Entry composition

There are 6 unique types of molecules in this entry. The entry contains 20562 atoms, of which 0 are hydrogens and 0 are deuteriums.

In the tables below, the AltConf column contains the number of residues with at least one atom in alternate conformation and the Trace column contains the number of residues modelled with at most 2 atoms.

- Molecule 1 is a protein called Transient receptor potential cation channel subfamily V member 6.

Mol	Chain	Residues	Atoms					AltConf	Trace
			Total	C	N	O	S		
1	A	612	4912	3173	831	868	40	0	0
1	B	612	4912	3173	831	868	40	0	0
1	C	612	4912	3173	831	868	40	0	0
1	D	612	4912	3173	831	868	40	0	0

There are 64 discrepancies between the modelled and reference sequences:

Chain	Residue	Modelled	Actual	Comment	Reference
A	668	VAL	-	expression tag	UNP Q9H1D0
A	669	PRO	-	expression tag	UNP Q9H1D0
A	670	ARG	-	expression tag	UNP Q9H1D0
A	671	GLY	-	expression tag	UNP Q9H1D0
A	672	SER	-	expression tag	UNP Q9H1D0
A	673	ALA	-	expression tag	UNP Q9H1D0
A	674	ALA	-	expression tag	UNP Q9H1D0
A	675	ALA	-	expression tag	UNP Q9H1D0
A	676	TRP	-	expression tag	UNP Q9H1D0
A	677	SER	-	expression tag	UNP Q9H1D0
A	678	HIS	-	expression tag	UNP Q9H1D0
A	679	PRO	-	expression tag	UNP Q9H1D0
A	680	GLN	-	expression tag	UNP Q9H1D0
A	681	PHE	-	expression tag	UNP Q9H1D0
A	682	GLU	-	expression tag	UNP Q9H1D0
A	683	LYS	-	expression tag	UNP Q9H1D0
B	668	VAL	-	expression tag	UNP Q9H1D0
B	669	PRO	-	expression tag	UNP Q9H1D0
B	670	ARG	-	expression tag	UNP Q9H1D0
B	671	GLY	-	expression tag	UNP Q9H1D0
B	672	SER	-	expression tag	UNP Q9H1D0

Continued on next page...

Continued from previous page...

Chain	Residue	Modelled	Actual	Comment	Reference
B	673	ALA	-	expression tag	UNP Q9H1D0
B	674	ALA	-	expression tag	UNP Q9H1D0
B	675	ALA	-	expression tag	UNP Q9H1D0
B	676	TRP	-	expression tag	UNP Q9H1D0
B	677	SER	-	expression tag	UNP Q9H1D0
B	678	HIS	-	expression tag	UNP Q9H1D0
B	679	PRO	-	expression tag	UNP Q9H1D0
B	680	GLN	-	expression tag	UNP Q9H1D0
B	681	PHE	-	expression tag	UNP Q9H1D0
B	682	GLU	-	expression tag	UNP Q9H1D0
B	683	LYS	-	expression tag	UNP Q9H1D0
C	668	VAL	-	expression tag	UNP Q9H1D0
C	669	PRO	-	expression tag	UNP Q9H1D0
C	670	ARG	-	expression tag	UNP Q9H1D0
C	671	GLY	-	expression tag	UNP Q9H1D0
C	672	SER	-	expression tag	UNP Q9H1D0
C	673	ALA	-	expression tag	UNP Q9H1D0
C	674	ALA	-	expression tag	UNP Q9H1D0
C	675	ALA	-	expression tag	UNP Q9H1D0
C	676	TRP	-	expression tag	UNP Q9H1D0
C	677	SER	-	expression tag	UNP Q9H1D0
C	678	HIS	-	expression tag	UNP Q9H1D0
C	679	PRO	-	expression tag	UNP Q9H1D0
C	680	GLN	-	expression tag	UNP Q9H1D0
C	681	PHE	-	expression tag	UNP Q9H1D0
C	682	GLU	-	expression tag	UNP Q9H1D0
C	683	LYS	-	expression tag	UNP Q9H1D0
D	668	VAL	-	expression tag	UNP Q9H1D0
D	669	PRO	-	expression tag	UNP Q9H1D0
D	670	ARG	-	expression tag	UNP Q9H1D0
D	671	GLY	-	expression tag	UNP Q9H1D0
D	672	SER	-	expression tag	UNP Q9H1D0
D	673	ALA	-	expression tag	UNP Q9H1D0
D	674	ALA	-	expression tag	UNP Q9H1D0
D	675	ALA	-	expression tag	UNP Q9H1D0
D	676	TRP	-	expression tag	UNP Q9H1D0
D	677	SER	-	expression tag	UNP Q9H1D0
D	678	HIS	-	expression tag	UNP Q9H1D0
D	679	PRO	-	expression tag	UNP Q9H1D0
D	680	GLN	-	expression tag	UNP Q9H1D0
D	681	PHE	-	expression tag	UNP Q9H1D0
D	682	GLU	-	expression tag	UNP Q9H1D0

Continued on next page...

Continued from previous page...

Chain	Residue	Modelled	Actual	Comment	Reference
D	683	LYS	-	expression tag	UNP Q9H1D0

- Molecule 2 is 1-[(2R)-2-[(4-chlorobenzyl)oxy]-2-(2,4-dichlorophenyl)ethyl]-1H-imidazole (three-letter code: ECL) (formula: $C_{18}H_{15}Cl_3N_2O$) (labeled as "Ligand of Interest" by depositor).

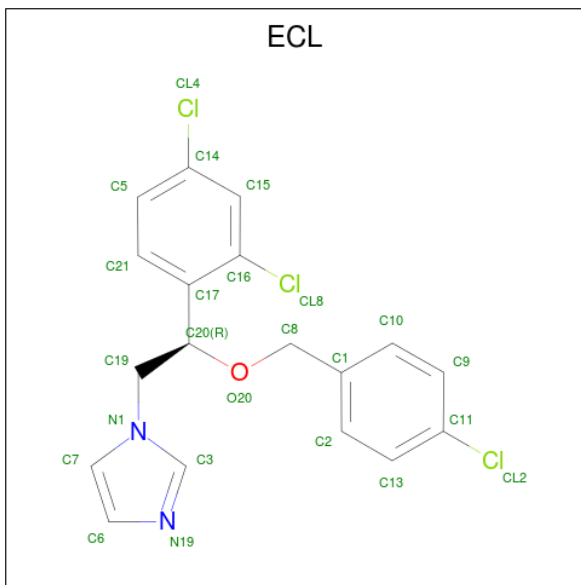

Mol	Chain	Residues	Atoms				AltConf	
			Total	C	Cl	N		O
2	A	1	Total	C	Cl	N	O	0
			24	18	3	2	1	
2	B	1	Total	C	Cl	N	O	0
			24	18	3	2	1	
2	C	1	Total	C	Cl	N	O	0
			24	18	3	2	1	
2	D	1	Total	C	Cl	N	O	0
			24	18	3	2	1	

- Molecule 3 is CHOLESTEROL HEMISUCCINATE (three-letter code: Y01) (formula: $C_{31}H_{50}O_4$).

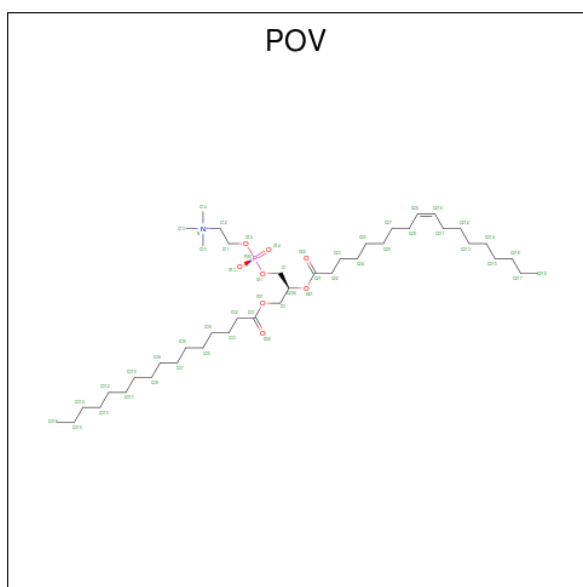

Mol	Chain	Residues	Atoms					AltConf
			Total	C	N	O	P	
4	A	1	99	84	1	13	1	0
4	A	1	99	84	1	13	1	0
4	A	1	99	84	1	13	1	0
4	A	1	99	84	1	13	1	0
4	B	1	99	84	1	13	1	0
4	B	1	99	84	1	13	1	0
4	B	1	99	84	1	13	1	0
4	B	1	99	84	1	13	1	0
4	C	1	99	84	1	13	1	0
4	C	1	99	84	1	13	1	0
4	C	1	99	84	1	13	1	0
4	C	1	99	84	1	13	1	0
4	D	1	99	84	1	13	1	0
4	D	1	99	84	1	13	1	0

Continued on next page...

Continued from previous page...

Mol	Chain	Residues	Atoms					AltConf
4	D	1	Total	C	N	O	P	0
			99	84	1	13	1	
4	D	1	Total	C	N	O	P	0
			99	84	1	13	1	

- Molecule 5 is CALCIUM ION (three-letter code: CA) (formula: Ca).

Mol	Chain	Residues	Atoms		AltConf
5	A	1	Total	Ca	0
			1	1	

- Molecule 6 is CHLORIDE ION (three-letter code: CL) (formula: Cl).

Mol	Chain	Residues	Atoms		AltConf
6	A	1	Total	Cl	0
			1	1	

3 Residue-property plots

These plots are drawn for all protein, RNA, DNA and oligosaccharide chains in the entry. The first graphic for a chain summarises the proportions of the various outlier classes displayed in the second graphic. The second graphic shows the sequence view annotated by issues in geometry and atom inclusion in map density. Residues are color-coded according to the number of geometric quality criteria for which they contain at least one outlier: green = 0, yellow = 1, orange = 2 and red = 3 or more. A red diamond above a residue indicates a poor fit to the EM map for this residue (all-atom inclusion < 40%). Stretches of 2 or more consecutive residues without any outlier are shown as a green connector. Residues present in the sample, but not in the model, are shown in grey.

- Molecule 1: Transient receptor potential cation channel subfamily V member 6

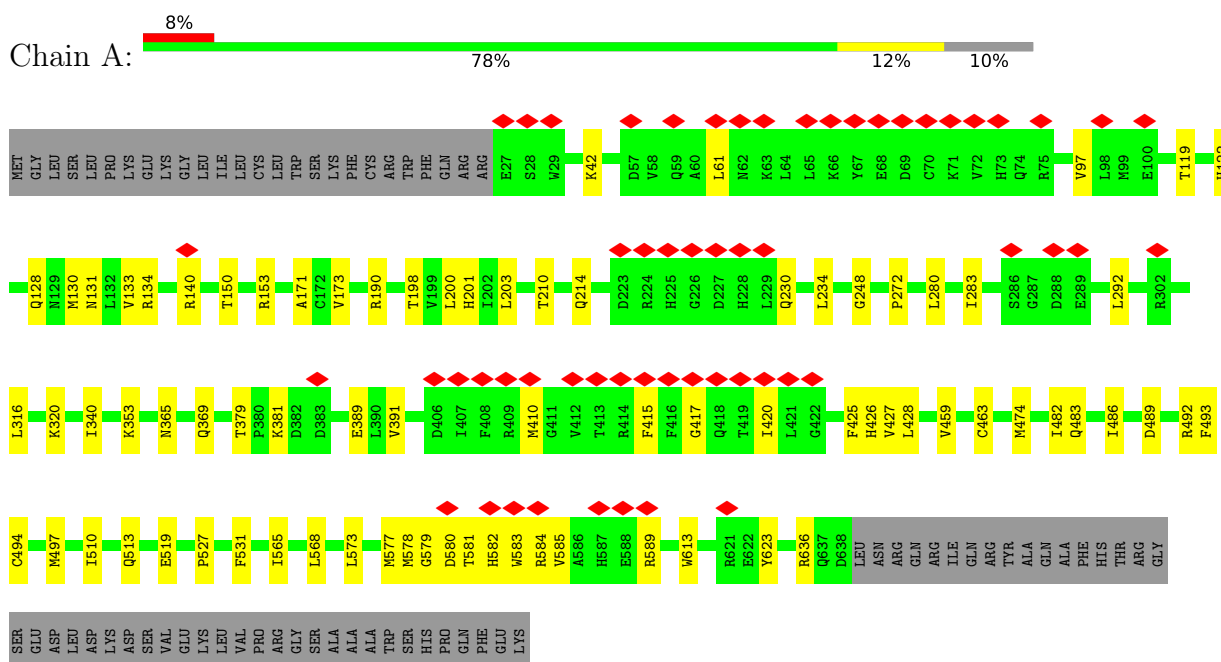

- Molecule 1: Transient receptor potential cation channel subfamily V member 6

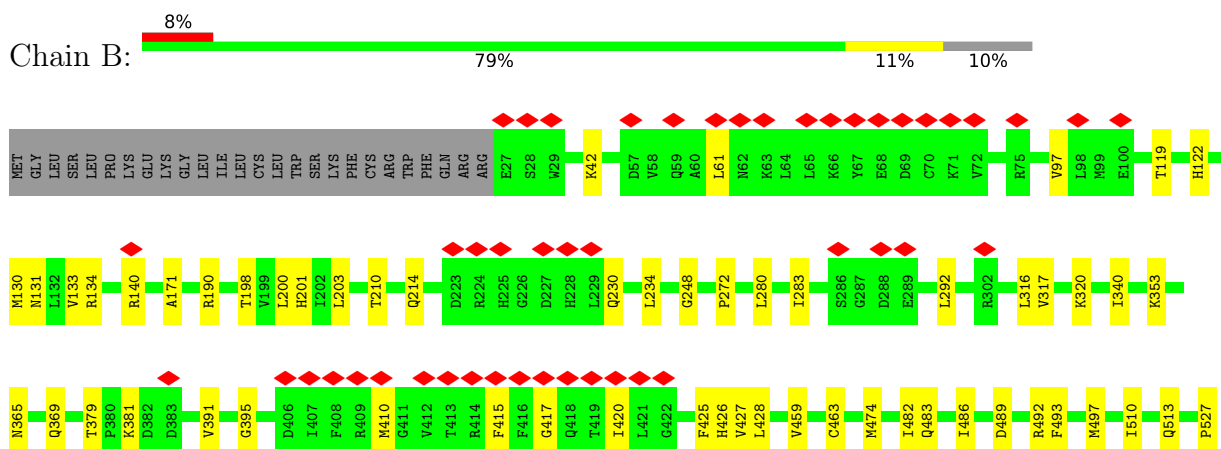

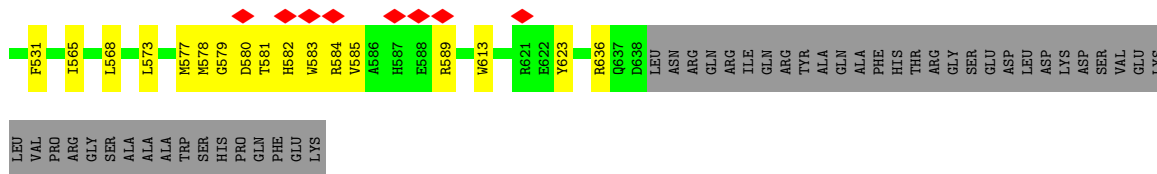

• Molecule 1: Transient receptor potential cation channel subfamily V member 6

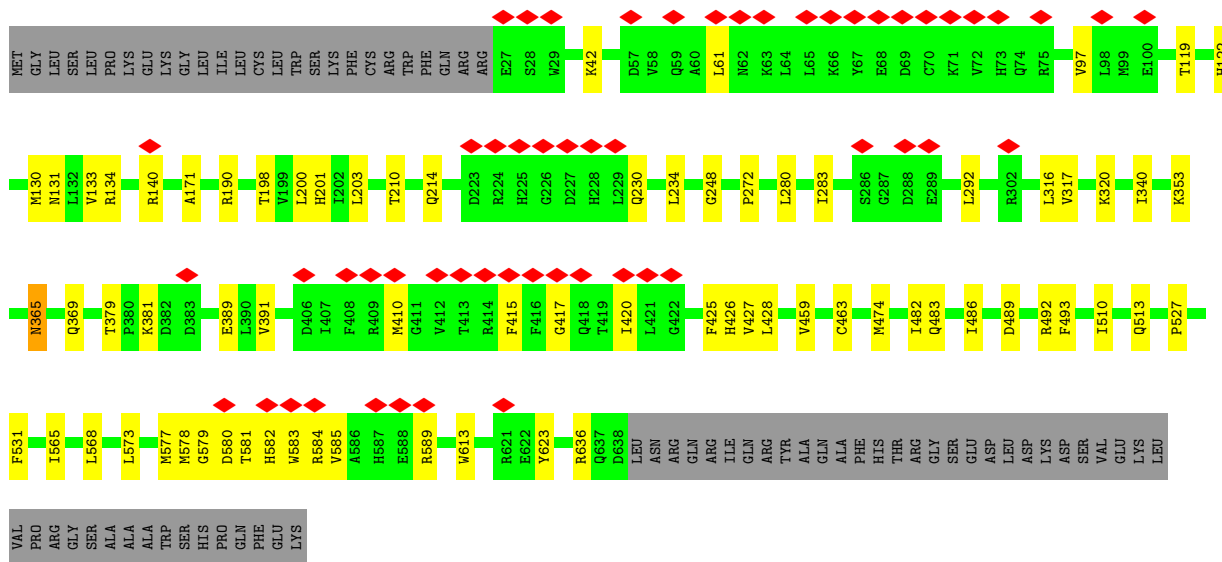
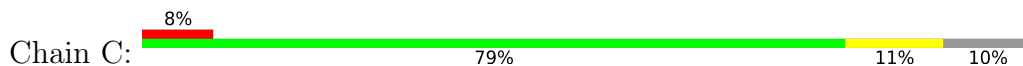

• Molecule 1: Transient receptor potential cation channel subfamily V member 6

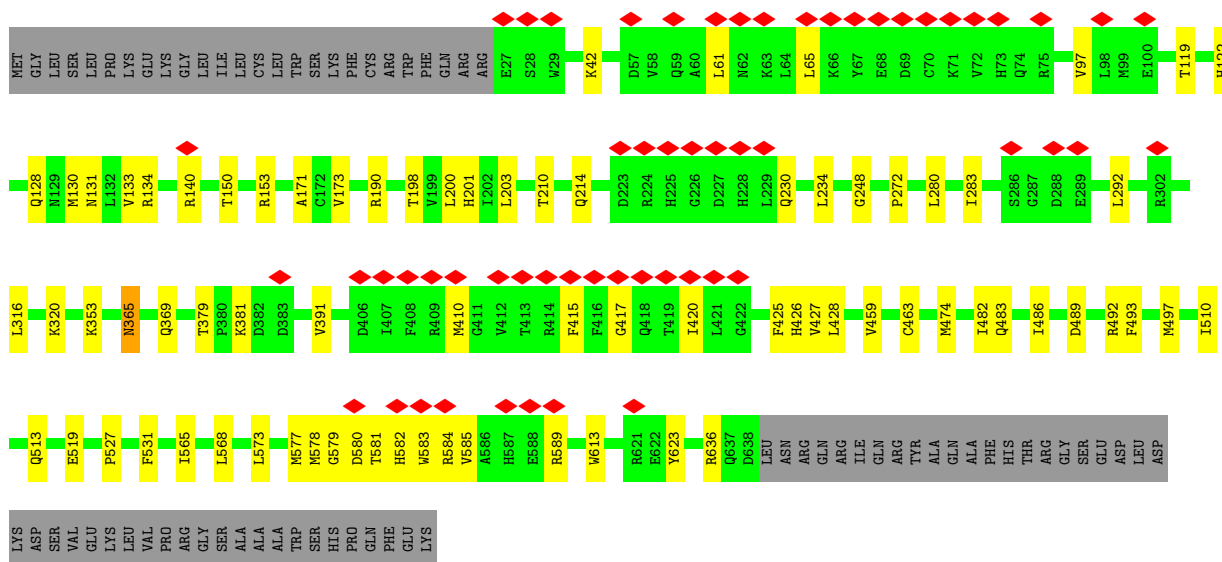
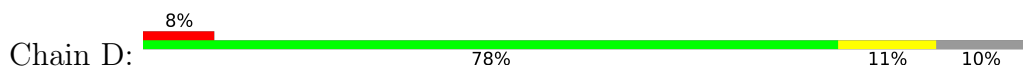

4 Experimental information

Property	Value	Source
EM reconstruction method	SINGLE PARTICLE	Depositor
Imposed symmetry	POINT, Not provided	
Number of particles used	41635	Depositor
Resolution determination method	FSC 0.143 CUT-OFF	Depositor
CTF correction method	NONE	Depositor
Microscope	TFS KRIOS	Depositor
Voltage (kV)	300	Depositor
Electron dose ($e^-/\text{\AA}^2$)	60	Depositor
Minimum defocus (nm)	-800	Depositor
Maximum defocus (nm)	-2000	Depositor
Magnification	Not provided	
Image detector	GATAN K3 (6k x 4k)	Depositor
Maximum map value	0.152	Depositor
Minimum map value	-0.092	Depositor
Average map value	0.000	Depositor
Map value standard deviation	0.005	Depositor
Recommended contour level	0.022	Depositor
Map size (\AA)	212.992, 212.992, 212.992	wwPDB
Map dimensions	256, 256, 256	wwPDB
Map angles ($^\circ$)	90.0, 90.0, 90.0	wwPDB
Pixel spacing (\AA)	0.832, 0.832, 0.832	Depositor

5 Model quality [i](#)

5.1 Standard geometry [i](#)

Bond lengths and bond angles in the following residue types are not validated in this section: CL, ECL, Y01, POV, CA

The Z score for a bond length (or angle) is the number of standard deviations the observed value is removed from the expected value. A bond length (or angle) with $|Z| > 5$ is considered an outlier worth inspection. RMSZ is the root-mean-square of all Z scores of the bond lengths (or angles).

Mol	Chain	Bond lengths		Bond angles	
		RMSZ	# Z >5	RMSZ	# Z >5
1	A	0.42	0/5025	0.58	0/6818
1	B	0.42	0/5025	0.58	0/6818
1	C	0.42	0/5025	0.58	0/6818
1	D	0.42	0/5025	0.58	0/6818
All	All	0.42	0/20100	0.58	0/27272

There are no bond length outliers.

There are no bond angle outliers.

There are no chirality outliers.

There are no planarity outliers.

5.2 Too-close contacts [i](#)

In the following table, the Non-H and H(model) columns list the number of non-hydrogen atoms and hydrogen atoms in the chain respectively. The H(added) column lists the number of hydrogen atoms added and optimized by MolProbity. The Clashes column lists the number of clashes within the asymmetric unit, whereas Symm-Clashes lists symmetry-related clashes.

Mol	Chain	Non-H	H(model)	H(added)	Clashes	Symm-Clashes
1	A	4912	0	4964	64	0
1	B	4912	0	4964	61	0
1	C	4912	0	4964	59	0
1	D	4912	0	4964	61	0
2	A	24	0	15	1	0
2	B	24	0	15	1	0
2	C	24	0	15	1	0
2	D	24	0	15	1	0
3	A	105	0	147	22	0

Continued on next page...

Continued from previous page...

Mol	Chain	Non-H	H(model)	H(added)	Clashes	Symm-Clashes
3	B	105	0	147	24	0
3	C	105	0	147	20	0
3	D	105	0	147	23	0
4	A	99	0	148	4	0
4	B	99	0	148	4	0
4	C	99	0	148	5	0
4	D	99	0	148	5	0
5	A	1	0	0	0	0
6	A	1	0	0	0	0
All	All	20562	0	21096	249	0

The all-atom clashscore is defined as the number of clashes found per 1000 atoms (including hydrogen atoms). The all-atom clashscore for this structure is 6.

All (249) close contacts within the same asymmetric unit are listed below, sorted by their clash magnitude.

Atom-1	Atom-2	Interatomic distance (Å)	Clash overlap (Å)
3:C:703:Y01:HAQ1	1:D:565:ILE:HD11	1.69	0.75
3:B:703:Y01:HAQ1	1:C:565:ILE:HD11	1.68	0.75
1:A:565:ILE:HD11	3:D:704:Y01:HAQ1	1.69	0.74
3:A:703:Y01:HAQ1	1:B:565:ILE:HD11	1.68	0.74
3:A:703:Y01:HAQ1	1:B:565:ILE:CD1	2.27	0.64
1:A:565:ILE:CD1	3:D:704:Y01:HAQ1	2.27	0.64
1:C:486:ILE:HD13	3:C:703:Y01:HAD2	1.81	0.63
3:C:703:Y01:HAQ1	1:D:565:ILE:CD1	2.28	0.62
3:B:703:Y01:HAQ1	1:C:565:ILE:CD1	2.28	0.62
1:A:391:VAL:HG13	3:A:702:Y01:HAA3	1.82	0.61
1:B:391:VAL:HG13	3:B:702:Y01:HAA3	1.83	0.61
1:D:391:VAL:HG13	3:D:703:Y01:HAA3	1.83	0.60
1:C:391:VAL:HG13	3:C:702:Y01:HAA3	1.83	0.60
1:B:486:ILE:HD13	3:B:703:Y01:HAD2	1.83	0.60
1:D:486:ILE:HD13	3:D:704:Y01:HAD2	1.82	0.59
1:A:486:ILE:HD13	3:A:703:Y01:HAD2	1.84	0.59
1:B:582:HIS:NE2	1:C:578:MET:SD	2.76	0.59
1:A:578:MET:SD	1:D:582:HIS:NE2	2.76	0.59
1:D:119:THR:H	1:D:122:HIS:HD2	1.51	0.58
1:A:119:THR:H	1:A:122:HIS:HD2	1.51	0.58
1:B:131:ASN:OD1	1:B:134:ARG:NH2	2.37	0.58
1:C:119:THR:H	1:C:122:HIS:HD2	1.51	0.58
1:C:131:ASN:OD1	1:C:134:ARG:NH2	2.37	0.58
1:C:582:HIS:NE2	1:D:578:MET:SD	2.77	0.58

Continued on next page...

Continued from previous page...

Atom-1	Atom-2	Interatomic distance (Å)	Clash overlap (Å)
1:D:131:ASN:OD1	1:D:134:ARG:NH2	2.37	0.58
1:B:119:THR:H	1:B:122:HIS:HD2	1.51	0.58
1:B:582:HIS:HB3	1:C:583:TRP:HH2	1.68	0.58
1:A:582:HIS:HB3	1:B:583:TRP:HH2	1.69	0.57
1:A:131:ASN:OD1	1:A:134:ARG:NH2	2.37	0.57
1:B:428:LEU:HD21	3:B:703:Y01:HBF	1.87	0.56
1:B:531:PHE:HD1	3:B:704:Y01:HAD3	1.69	0.56
1:C:130:MET:HA	1:C:133:VAL:HG12	1.87	0.56
1:A:582:HIS:NE2	1:B:578:MET:SD	2.78	0.56
1:D:493:PHE:HB2	1:D:573:LEU:HD13	1.88	0.56
1:A:493:PHE:HB2	1:A:573:LEU:HD13	1.88	0.56
1:C:493:PHE:HB2	1:C:573:LEU:HD13	1.88	0.56
1:C:531:PHE:HD1	3:C:704:Y01:HAD3	1.70	0.56
1:C:582:HIS:HB3	1:D:583:TRP:HH2	1.69	0.56
1:D:130:MET:HA	1:D:133:VAL:HG12	1.87	0.56
1:B:210:THR:O	1:B:214:GLN:NE2	2.39	0.56
1:B:198:THR:H	1:B:201:HIS:HD2	1.54	0.55
1:C:198:THR:H	1:C:201:HIS:HD2	1.53	0.55
1:D:210:THR:O	1:D:214:GLN:NE2	2.39	0.55
1:A:583:TRP:HH2	1:D:582:HIS:HB3	1.69	0.55
1:B:130:MET:HA	1:B:133:VAL:HG12	1.87	0.55
1:B:493:PHE:HB2	1:B:573:LEU:HD13	1.88	0.55
1:D:531:PHE:HD1	3:D:705:Y01:HAD3	1.70	0.55
1:C:210:THR:O	1:C:214:GLN:NE2	2.39	0.55
1:A:130:MET:HA	1:A:133:VAL:HG12	1.87	0.55
1:A:210:THR:O	1:A:214:GLN:NE2	2.39	0.55
1:B:482:ILE:HG23	1:C:568:LEU:HD21	1.88	0.55
1:A:198:THR:H	1:A:201:HIS:HD2	1.54	0.55
1:B:577:MET:O	1:B:581:THR:OG1	2.22	0.55
1:D:428:LEU:HD21	3:D:704:Y01:HBF	1.89	0.55
1:A:568:LEU:HD21	1:D:482:ILE:HG23	1.88	0.55
1:A:230:GLN:NE2	1:A:234:LEU:O	2.41	0.54
1:A:428:LEU:HD21	3:A:703:Y01:HBF	1.89	0.54
1:D:198:THR:H	1:D:201:HIS:HD2	1.54	0.54
1:A:531:PHE:HD1	3:A:704:Y01:HAD3	1.71	0.54
1:B:230:GLN:NE2	1:B:234:LEU:O	2.41	0.54
1:C:428:LEU:HD21	3:C:703:Y01:HBF	1.90	0.54
1:A:580:ASP:HA	1:A:584:ARG:HD2	1.91	0.53
1:D:580:ASP:HA	1:D:584:ARG:HD2	1.91	0.53
1:D:230:GLN:NE2	1:D:234:LEU:O	2.41	0.53
1:C:230:GLN:NE2	1:C:234:LEU:O	2.41	0.53

Continued on next page...

Continued from previous page...

Atom-1	Atom-2	Interatomic distance (Å)	Clash overlap (Å)
1:A:623:TYR:HA	1:B:42:LYS:HD2	1.91	0.53
1:A:482:ILE:HG23	1:B:568:LEU:HD21	1.91	0.52
1:C:531:PHE:CD1	3:C:704:Y01:HAD3	2.44	0.52
1:D:531:PHE:CD1	3:D:705:Y01:HAD3	2.44	0.52
1:B:531:PHE:CD1	3:B:704:Y01:HAD3	2.44	0.52
1:C:482:ILE:HG23	1:D:568:LEU:HD21	1.90	0.52
1:C:580:ASP:HA	1:C:584:ARG:HD2	1.90	0.52
1:B:580:ASP:HA	1:B:584:ARG:HD2	1.91	0.52
1:A:577:MET:O	1:A:581:THR:OG1	2.22	0.51
1:C:531:PHE:HB2	3:C:704:Y01:CAV	2.40	0.51
1:A:531:PHE:CD1	3:A:704:Y01:HAD3	2.44	0.51
1:A:353:LYS:HE3	1:A:369:GLN:HE21	1.76	0.51
1:D:577:MET:O	1:D:581:THR:OG1	2.22	0.51
1:D:353:LYS:HE3	1:D:369:GLN:HE21	1.76	0.51
1:A:42:LYS:HD2	1:D:623:TYR:HA	1.93	0.50
1:C:577:MET:O	1:C:581:THR:OG1	2.22	0.50
1:A:483:GLN:OE1	3:A:703:Y01:HAL1	2.12	0.50
1:B:483:GLN:OE1	3:B:703:Y01:HAL1	2.12	0.50
1:B:353:LYS:HE3	1:B:369:GLN:HE21	1.76	0.50
1:C:353:LYS:HE3	1:C:369:GLN:HE21	1.76	0.50
1:D:531:PHE:HB2	3:D:705:Y01:CAV	2.42	0.49
1:A:497:MET:CE	3:A:704:Y01:HAJ1	2.43	0.49
1:A:531:PHE:HB2	3:A:704:Y01:CAV	2.43	0.49
1:B:531:PHE:HB2	3:B:704:Y01:CAV	2.43	0.49
1:B:581:THR:HA	1:B:585:VAL:HG22	1.94	0.49
1:B:623:TYR:HA	1:C:42:LYS:HD2	1.94	0.49
1:A:581:THR:HA	1:A:585:VAL:HG22	1.94	0.49
1:C:483:GLN:OE1	3:C:703:Y01:HAL1	2.13	0.49
1:C:623:TYR:HA	1:D:42:LYS:HD2	1.94	0.48
3:D:705:Y01:HAC2	4:D:707:POV:H214	1.95	0.48
4:A:706:POV:H310	4:A:706:POV:H37	1.69	0.48
1:D:581:THR:HA	1:D:585:VAL:HG22	1.94	0.48
1:B:510:ILE:HA	1:B:513:GLN:HB2	1.95	0.48
1:C:581:THR:HA	1:C:585:VAL:HG22	1.94	0.48
1:B:171:ALA:HB1	1:B:203:LEU:HD21	1.96	0.48
1:B:198:THR:HG22	1:B:201:HIS:CD2	2.49	0.47
1:D:171:ALA:HB1	1:D:203:LEU:HD21	1.96	0.47
1:A:489:ASP:HA	1:A:492:ARG:HD3	1.97	0.47
1:C:510:ILE:HA	1:C:513:GLN:HB2	1.95	0.47
1:D:510:ILE:HA	1:D:513:GLN:HB2	1.95	0.47
1:C:579:GLY:O	1:C:584:ARG:NH2	2.41	0.47

Continued on next page...

Continued from previous page...

Atom-1	Atom-2	Interatomic distance (Å)	Clash overlap (Å)
1:D:489:ASP:HA	1:D:492:ARG:HD3	1.97	0.47
1:A:198:THR:HG22	1:A:201:HIS:CD2	2.49	0.47
1:A:510:ILE:HA	1:A:513:GLN:HB2	1.95	0.47
1:C:171:ALA:HB1	1:C:203:LEU:HD21	1.96	0.47
1:C:489:ASP:HA	1:C:492:ARG:HD3	1.97	0.47
3:B:704:Y01:HAP1	3:B:704:Y01:HAO1	1.37	0.47
1:B:489:ASP:HA	1:B:492:ARG:HD3	1.97	0.47
1:D:198:THR:HG22	1:D:201:HIS:CD2	2.49	0.47
1:C:198:THR:HG22	1:C:201:HIS:CD2	2.49	0.47
1:D:61:LEU:HB3	1:D:97:VAL:HG11	1.97	0.47
1:B:61:LEU:HB3	1:B:97:VAL:HG11	1.97	0.46
1:B:420:ILE:HD12	1:B:427:VAL:HG23	1.98	0.46
1:C:420:ILE:HD12	1:C:427:VAL:HG23	1.98	0.46
1:D:417:GLY:HA2	1:D:420:ILE:HG12	1.98	0.46
1:A:171:ALA:HB1	1:A:203:LEU:HD21	1.96	0.46
1:A:417:GLY:HA2	1:A:420:ILE:HG12	1.98	0.46
3:D:704:Y01:HAO2	3:D:704:Y01:HAP1	1.40	0.46
1:C:417:GLY:HA2	1:C:420:ILE:HG12	1.98	0.46
1:A:579:GLY:O	1:A:584:ARG:NH2	2.41	0.46
1:B:417:GLY:HA2	1:B:420:ILE:HG12	1.98	0.46
1:B:579:GLY:O	1:B:584:ARG:NH2	2.41	0.46
3:C:704:Y01:HAN1	3:C:704:Y01:HBB	1.61	0.46
3:A:704:Y01:HAC2	4:A:706:POV:H214	1.98	0.46
4:D:707:POV:H37	4:D:707:POV:H310	1.68	0.46
1:A:459:VAL:HG12	3:A:703:Y01:HAP2	1.97	0.45
1:B:486:ILE:HD13	3:B:703:Y01:CAD	2.46	0.45
1:A:61:LEU:HB3	1:A:97:VAL:HG11	1.97	0.45
1:A:527:PRO:O	3:A:704:Y01:HAV2	2.17	0.45
1:B:198:THR:HG23	1:B:200:LEU:H	1.82	0.45
1:C:61:LEU:HB3	1:C:97:VAL:HG11	1.97	0.45
3:C:704:Y01:HAC2	4:C:706:POV:H214	1.98	0.45
1:D:420:ILE:HD12	1:D:427:VAL:HG23	1.98	0.45
1:A:420:ILE:HD12	1:A:427:VAL:HG23	1.98	0.45
3:C:703:Y01:HAO2	3:C:703:Y01:HAP1	1.39	0.45
1:C:198:THR:HG23	1:C:200:LEU:H	1.82	0.45
1:D:483:GLN:OE1	3:D:704:Y01:HAL1	2.16	0.45
1:B:527:PRO:O	3:B:704:Y01:HAV2	2.16	0.45
3:B:704:Y01:HAC2	4:B:706:POV:H214	1.97	0.45
1:C:486:ILE:HD13	3:C:703:Y01:CAD	2.47	0.45
1:C:474:MET:HG2	1:D:492:ARG:HG3	1.99	0.45
1:A:198:THR:HG23	1:A:200:LEU:H	1.82	0.44

Continued on next page...

Continued from previous page...

Atom-1	Atom-2	Interatomic distance (Å)	Clash overlap (Å)
1:A:492:ARG:HG3	1:D:474:MET:HG2	1.99	0.44
1:C:527:PRO:O	3:C:704:Y01:HAV2	2.17	0.44
1:C:531:PHE:HB2	3:C:704:Y01:HAV1	1.99	0.44
1:D:486:ILE:HD13	3:D:704:Y01:CAD	2.47	0.44
1:D:527:PRO:O	3:D:705:Y01:HAV2	2.17	0.44
1:B:272:PRO:HB2	1:B:636:ARG:HG3	2.00	0.44
1:D:198:THR:HG23	1:D:200:LEU:H	1.82	0.44
3:D:705:Y01:HAN1	3:D:705:Y01:HBB	1.58	0.44
1:A:486:ILE:HD13	3:A:703:Y01:CAD	2.47	0.44
1:A:425:PHE:HB2	3:A:702:Y01:HAL2	2.00	0.44
1:A:459:VAL:CG1	3:A:703:Y01:HAP2	2.47	0.44
1:B:531:PHE:HB2	3:B:704:Y01:HAV1	2.00	0.44
1:C:248:GLY:HA3	1:C:292:LEU:HD11	2.00	0.44
1:C:272:PRO:HB2	1:C:636:ARG:HG3	2.00	0.44
1:D:272:PRO:HB2	1:D:636:ARG:HG3	2.00	0.44
4:B:706:POV:H37	4:B:706:POV:H310	1.68	0.44
1:A:272:PRO:HB2	1:A:636:ARG:HG3	2.00	0.43
1:B:248:GLY:HA3	1:B:292:LEU:HD11	2.00	0.43
1:C:459:VAL:HG12	3:C:703:Y01:HAP2	1.99	0.43
4:C:706:POV:H37	4:C:706:POV:H310	1.68	0.43
1:D:410:MET:HB3	1:D:415:PHE:HD2	1.83	0.43
1:D:459:VAL:HG12	3:D:704:Y01:HAP2	1.99	0.43
4:D:707:POV:H28A	4:D:707:POV:H211	1.71	0.43
1:B:425:PHE:HB2	3:B:702:Y01:HAL2	1.99	0.43
1:B:474:MET:HG2	1:C:492:ARG:HG3	2.01	0.43
1:C:410:MET:HB3	1:C:415:PHE:HD2	1.83	0.43
1:D:190:ARG:NH2	1:D:230:GLN:O	2.52	0.43
1:A:494:CYS:HB3	3:A:704:Y01:HAJ2	2.00	0.43
1:B:410:MET:HB3	1:B:415:PHE:HD2	1.83	0.43
4:A:706:POV:H31F	2:D:702:ECL:H3	2.00	0.43
1:B:340:ILE:HD12	1:B:340:ILE:HA	1.89	0.43
4:B:706:POV:H211	4:B:706:POV:H28A	1.71	0.43
1:C:190:ARG:NH2	1:C:230:GLN:O	2.52	0.43
1:A:463:CYS:HB3	3:A:703:Y01:HAK2	2.01	0.43
1:C:425:PHE:HB2	3:C:702:Y01:HAL2	2.00	0.43
2:C:701:ECL:H3	4:D:707:POV:H31F	2.01	0.43
3:B:703:Y01:HAB1	3:B:703:Y01:HAJ2	1.71	0.43
1:D:531:PHE:HB2	3:D:705:Y01:HAV1	2.01	0.43
3:D:703:Y01:HAJ2	3:D:703:Y01:HAB1	1.82	0.43
1:A:410:MET:HB3	1:A:415:PHE:HD2	1.83	0.43
2:A:701:ECL:H3	4:B:706:POV:H31F	2.01	0.43

Continued on next page...

Continued from previous page...

Atom-1	Atom-2	Interatomic distance (Å)	Clash overlap (Å)
1:C:459:VAL:CG1	3:C:703:Y01:HAP2	2.49	0.43
1:D:463:CYS:HB3	3:D:704:Y01:HAK2	2.01	0.43
1:C:389:GLU:HB3	4:C:707:POV:H212	2.00	0.43
1:D:248:GLY:HA3	1:D:292:LEU:HD11	2.00	0.43
1:A:248:GLY:HA3	1:A:292:LEU:HD11	2.00	0.42
1:A:474:MET:HG2	1:B:492:ARG:HG3	2.01	0.42
2:B:701:ECL:H3	4:C:706:POV:H31F	2.00	0.42
1:C:426:HIS:CD2	3:C:702:Y01:HAM2	2.54	0.42
1:D:283:ILE:HA	1:D:292:LEU:HB3	2.02	0.42
1:A:190:ARG:NH2	1:A:230:GLN:O	2.52	0.42
1:A:283:ILE:HA	1:A:292:LEU:HB3	2.02	0.42
1:A:519:GLU:OE1	1:D:365:ASN:ND2	2.38	0.42
4:C:706:POV:H28A	4:C:706:POV:H211	1.71	0.42
1:D:459:VAL:CG1	3:D:704:Y01:HAP2	2.49	0.42
1:A:389:GLU:HB3	4:A:707:POV:H212	2.01	0.42
1:C:379:THR:HG23	1:C:381:LYS:H	1.85	0.42
1:A:379:THR:HG23	1:A:381:LYS:H	1.85	0.42
1:B:190:ARG:NH2	1:B:230:GLN:O	2.52	0.42
3:A:704:Y01:HBB	3:A:704:Y01:HAN1	1.55	0.42
1:D:320:LYS:HD3	1:D:613:TRP:HZ2	1.85	0.42
1:D:379:THR:HG23	1:D:381:LYS:H	1.85	0.42
1:B:280:LEU:HD11	1:B:316:LEU:HD13	2.02	0.42
1:B:459:VAL:HG12	3:B:703:Y01:HAP2	2.01	0.42
3:D:705:Y01:HAO1	3:D:705:Y01:HAP1	1.37	0.42
1:A:280:LEU:HD11	1:A:316:LEU:HD13	2.02	0.42
1:B:379:THR:HG23	1:B:381:LYS:H	1.85	0.42
1:B:395:GLY:HA3	3:B:702:Y01:HAN1	2.02	0.42
1:B:426:HIS:CD2	3:B:702:Y01:HAM2	2.55	0.42
1:D:426:HIS:CD2	3:D:703:Y01:HAM2	2.55	0.42
1:A:426:HIS:CD2	3:A:702:Y01:HAM2	2.55	0.41
1:C:320:LYS:HD3	1:C:613:TRP:HZ2	1.85	0.41
1:D:497:MET:CE	3:D:705:Y01:HAJ1	2.50	0.41
1:C:280:LEU:HD11	1:C:316:LEU:HD13	2.02	0.41
1:A:320:LYS:HD3	1:A:613:TRP:HZ2	1.85	0.41
1:B:283:ILE:HA	1:B:292:LEU:HB3	2.02	0.41
1:B:459:VAL:CG1	3:B:703:Y01:HAP2	2.50	0.41
1:B:483:GLN:HB2	3:B:703:Y01:CAL	2.49	0.41
1:C:283:ILE:HA	1:C:292:LEU:HB3	2.02	0.41
1:C:463:CYS:HB3	3:C:703:Y01:HAK2	2.02	0.41
1:B:320:LYS:HD3	1:B:613:TRP:HZ2	1.85	0.41
1:C:317:VAL:HA	1:C:320:LYS:HG2	2.03	0.41

Continued on next page...

Continued from previous page...

Atom-1	Atom-2	Interatomic distance (Å)	Clash overlap (Å)
1:C:340:ILE:HD12	1:C:340:ILE:HA	1.89	0.41
1:A:340:ILE:HD12	1:A:340:ILE:HA	1.90	0.41
3:B:702:Y01:HAJ2	3:B:702:Y01:HAB1	1.82	0.41
1:A:190:ARG:HA	1:A:190:ARG:HD3	1.92	0.41
1:D:280:LEU:HD11	1:D:316:LEU:HD13	2.02	0.41
1:A:531:PHE:HB2	3:A:704:Y01:HAV1	2.03	0.41
1:B:317:VAL:HA	1:B:320:LYS:HG2	2.03	0.41
1:B:497:MET:CE	3:B:704:Y01:HAJ1	2.51	0.41
1:C:365:ASN:ND2	1:D:519:GLU:OE1	2.41	0.41
1:D:579:GLY:O	1:D:584:ARG:NH2	2.41	0.41
1:D:65:LEU:HD13	1:D:65:LEU:HA	1.94	0.40
1:D:150:THR:HA	1:D:153:ARG:HD3	2.03	0.40
1:B:198:THR:HG22	1:B:201:HIS:HD2	1.86	0.40
1:D:128:GLN:NE2	1:D:173:VAL:O	2.54	0.40
4:D:708:POV:H21A	4:D:708:POV:H21D	1.93	0.40
1:A:128:GLN:NE2	1:A:173:VAL:O	2.54	0.40
1:A:150:THR:HA	1:A:153:ARG:HD3	2.03	0.40
1:A:483:GLN:HB2	3:A:703:Y01:HAM2	2.03	0.40
1:D:425:PHE:HB2	3:D:703:Y01:HAL2	2.02	0.40
1:B:463:CYS:HB3	3:B:703:Y01:HAK2	2.03	0.40

There are no symmetry-related clashes.

5.3 Torsion angles [i](#)

5.3.1 Protein backbone [i](#)

In the following table, the Percentiles column shows the percent Ramachandran outliers of the chain as a percentile score with respect to all PDB entries followed by that with respect to all EM entries.

The Analysed column shows the number of residues for which the backbone conformation was analysed, and the total number of residues.

Mol	Chain	Analysed	Favoured	Allowed	Outliers	Percentiles	
1	A	610/683 (89%)	592 (97%)	18 (3%)	0	100	100
1	B	610/683 (89%)	592 (97%)	18 (3%)	0	100	100
1	C	610/683 (89%)	592 (97%)	18 (3%)	0	100	100
1	D	610/683 (89%)	592 (97%)	18 (3%)	0	100	100
All	All	2440/2732 (89%)	2368 (97%)	72 (3%)	0	100	100

There are no Ramachandran outliers to report.

5.3.2 Protein sidechains [i](#)

In the following table, the Percentiles column shows the percent sidechain outliers of the chain as a percentile score with respect to all PDB entries followed by that with respect to all EM entries.

The Analysed column shows the number of residues for which the sidechain conformation was analysed, and the total number of residues.

Mol	Chain	Analysed	Rotameric	Outliers	Percentiles	
1	A	531/593 (90%)	528 (99%)	3 (1%)	86	95
1	B	531/593 (90%)	528 (99%)	3 (1%)	86	95
1	C	531/593 (90%)	528 (99%)	3 (1%)	86	95
1	D	531/593 (90%)	528 (99%)	3 (1%)	86	95
All	All	2124/2372 (90%)	2112 (99%)	12 (1%)	86	95

All (12) residues with a non-rotameric sidechain are listed below:

Mol	Chain	Res	Type
1	A	140	ARG
1	A	365	ASN
1	A	589	ARG
1	B	140	ARG
1	B	365	ASN
1	B	589	ARG
1	C	140	ARG
1	C	365	ASN
1	C	589	ARG
1	D	140	ARG
1	D	365	ASN
1	D	589	ARG

Sometimes sidechains can be flipped to improve hydrogen bonding and reduce clashes. All (20) such sidechains are listed below:

Mol	Chain	Res	Type
1	A	91	ASN
1	A	122	HIS
1	A	201	HIS
1	A	214	GLN
1	A	369	GLN

Continued on next page...

Continued from previous page...

Mol	Chain	Res	Type
1	B	91	ASN
1	B	118	GLN
1	B	122	HIS
1	B	201	HIS
1	B	369	GLN
1	C	91	ASN
1	C	122	HIS
1	C	201	HIS
1	C	369	GLN
1	D	91	ASN
1	D	118	GLN
1	D	122	HIS
1	D	201	HIS
1	D	214	GLN
1	D	369	GLN

5.3.3 RNA [i](#)

There are no RNA molecules in this entry.

5.4 Non-standard residues in protein, DNA, RNA chains [i](#)

There are no non-standard protein/DNA/RNA residues in this entry.

5.5 Carbohydrates [i](#)

There are no monosaccharides in this entry.

5.6 Ligand geometry [i](#)

Of 34 ligands modelled in this entry, 2 are monoatomic - leaving 32 for Mogul analysis.

In the following table, the Counts columns list the number of bonds (or angles) for which Mogul statistics could be retrieved, the number of bonds (or angles) that are observed in the model and the number of bonds (or angles) that are defined in the Chemical Component Dictionary. The Link column lists molecule types, if any, to which the group is linked. The Z score for a bond length (or angle) is the number of standard deviations the observed value is removed from the expected value. A bond length (or angle) with $|Z| > 2$ is considered an outlier worth inspection. RMSZ is the root-mean-square of all Z scores of the bond lengths (or angles).

Mol	Type	Chain	Res	Link	Bond lengths			Bond angles		
					Counts	RMSZ	# Z > 2	Counts	RMSZ	# Z > 2
4	POV	B	708	-	14,14,51	1.07	1 (7%)	14,14,59	0.89	1 (7%)
4	POV	B	705	-	12,12,51	0.68	0	11,11,59	0.37	0
3	Y01	A	703	-	38,38,38	0.44	0	57,57,57	0.48	0
4	POV	C	708	-	14,14,51	1.06	1 (7%)	14,14,59	0.89	1 (7%)
3	Y01	B	702	-	38,38,38	0.45	0	57,57,57	0.46	0
3	Y01	D	705	-	38,38,38	0.46	0	57,57,57	0.65	0
4	POV	C	705	-	12,12,51	0.68	0	11,11,59	0.37	0
2	ECL	A	701	-	24,26,26	1.24	3 (12%)	32,35,35	1.29	3 (9%)
4	POV	D	707	-	51,51,51	1.06	3 (5%)	57,59,59	0.94	3 (5%)
4	POV	A	705	-	12,12,51	0.68	0	11,11,59	0.37	0
4	POV	C	707	-	18,18,51	1.45	2 (11%)	18,18,59	0.86	0
4	POV	D	706	-	12,12,51	0.68	0	11,11,59	0.37	0
4	POV	D	701	-	14,14,51	1.07	1 (7%)	14,14,59	0.90	1 (7%)
3	Y01	B	704	-	38,38,38	0.46	0	57,57,57	0.64	0
4	POV	C	706	-	51,51,51	1.06	3 (5%)	57,59,59	0.94	3 (5%)
3	Y01	D	703	-	38,38,38	0.45	0	57,57,57	0.46	0
3	Y01	B	703	-	38,38,38	0.45	0	57,57,57	0.50	0
4	POV	D	708	-	18,18,51	1.45	2 (11%)	18,18,59	0.86	0
4	POV	B	707	-	18,18,51	1.45	2 (11%)	18,18,59	0.87	0
4	POV	A	706	-	51,51,51	1.06	3 (5%)	57,59,59	0.94	3 (5%)
3	Y01	A	702	-	38,38,38	0.45	0	57,57,57	0.46	0
2	ECL	B	701	-	24,26,26	1.25	4 (16%)	32,35,35	1.29	3 (9%)
4	POV	B	706	-	51,51,51	1.06	3 (5%)	57,59,59	0.94	3 (5%)
4	POV	A	708	-	14,14,51	1.06	1 (7%)	14,14,59	0.90	1 (7%)
3	Y01	A	704	-	38,38,38	0.46	0	57,57,57	0.65	0
3	Y01	D	704	-	38,38,38	0.44	0	57,57,57	0.49	0
4	POV	A	707	-	18,18,51	1.45	2 (11%)	18,18,59	0.86	0
3	Y01	C	704	-	38,38,38	0.45	0	57,57,57	0.65	0
3	Y01	C	703	-	38,38,38	0.45	0	57,57,57	0.49	0
2	ECL	D	702	-	24,26,26	1.25	3 (12%)	32,35,35	1.27	3 (9%)
3	Y01	C	702	-	38,38,38	0.45	0	57,57,57	0.46	0
2	ECL	C	701	-	24,26,26	1.25	4 (16%)	32,35,35	1.28	3 (9%)

In the following table, the Chirals column lists the number of chiral outliers, the number of chiral centers analysed, the number of these observed in the model and the number defined in the Chemical Component Dictionary. Similar counts are reported in the Torsion and Rings columns. '-' means no outliers of that kind were identified.

Mol	Type	Chain	Res	Link	Chirals	Torsions	Rings
4	POV	B	708	-	-	5/13/13/55	-
4	POV	B	705	-	-	8/10/10/55	-
3	Y01	A	703	-	-	14/19/77/77	0/4/4/4
4	POV	C	708	-	-	5/13/13/55	-
3	Y01	B	702	-	-	4/19/77/77	0/4/4/4
3	Y01	D	705	-	-	14/19/77/77	0/4/4/4
4	POV	C	705	-	-	8/10/10/55	-
2	ECL	A	701	-	-	4/13/13/13	0/3/3/3
4	POV	D	707	-	-	28/55/55/55	-
4	POV	A	705	-	-	8/10/10/55	-
4	POV	C	707	-	-	12/17/17/55	-
4	POV	D	706	-	-	8/10/10/55	-
4	POV	D	701	-	-	5/13/13/55	-
3	Y01	B	704	-	-	14/19/77/77	0/4/4/4
4	POV	C	706	-	-	28/55/55/55	-
3	Y01	D	703	-	-	4/19/77/77	0/4/4/4
3	Y01	B	703	-	-	15/19/77/77	0/4/4/4
4	POV	D	708	-	-	11/17/17/55	-
4	POV	B	707	-	-	11/17/17/55	-
4	POV	A	706	-	-	29/55/55/55	-
3	Y01	A	702	-	-	4/19/77/77	0/4/4/4
2	ECL	B	701	-	-	4/13/13/13	0/3/3/3
4	POV	B	706	-	-	28/55/55/55	-
4	POV	A	708	-	-	5/13/13/55	-
3	Y01	A	704	-	-	14/19/77/77	0/4/4/4
3	Y01	D	704	-	-	15/19/77/77	0/4/4/4
4	POV	A	707	-	-	12/17/17/55	-
3	Y01	C	704	-	-	14/19/77/77	0/4/4/4
3	Y01	C	703	-	-	15/19/77/77	0/4/4/4
2	ECL	D	702	-	-	4/13/13/13	0/3/3/3
3	Y01	C	702	-	-	4/19/77/77	0/4/4/4
2	ECL	C	701	-	-	4/13/13/13	0/3/3/3

All (38) bond length outliers are listed below:

Mol	Chain	Res	Type	Atoms	Z	Observed(Å)	Ideal(Å)
4	C	707	POV	C29-C210	4.16	1.55	1.31
4	D	708	POV	C29-C210	4.15	1.55	1.31
4	B	707	POV	C29-C210	4.14	1.55	1.31
4	A	707	POV	C29-C210	4.14	1.55	1.31
2	D	702	ECL	C19-N1	-3.12	1.45	1.48
2	B	701	ECL	C19-N1	-2.99	1.45	1.48
2	C	701	ECL	C19-N1	-2.98	1.45	1.48
2	A	701	ECL	C19-N1	-2.90	1.45	1.48
4	A	706	POV	O31-C31	2.84	1.41	1.33
4	D	707	POV	O31-C31	2.82	1.41	1.33
4	A	707	POV	O21-C21	2.82	1.42	1.33
4	B	706	POV	O31-C31	2.82	1.41	1.33
4	D	708	POV	O21-C21	2.82	1.42	1.33
4	B	707	POV	O21-C21	2.81	1.42	1.33
4	C	707	POV	O21-C21	2.81	1.42	1.33
4	C	706	POV	O31-C31	2.79	1.41	1.33
4	B	708	POV	O31-C31	2.71	1.41	1.33
4	D	701	POV	O31-C31	2.71	1.41	1.33
4	D	707	POV	O21-C21	2.69	1.41	1.34
4	B	706	POV	O21-C21	2.69	1.41	1.34
4	C	708	POV	O31-C31	2.68	1.41	1.33
4	A	708	POV	O31-C31	2.68	1.41	1.33
4	A	706	POV	O21-C21	2.67	1.41	1.34
4	C	706	POV	O21-C2	-2.67	1.39	1.46
4	C	706	POV	O21-C21	2.67	1.41	1.34
2	B	701	ECL	C7-N1	-2.66	1.32	1.37
4	B	706	POV	O21-C2	-2.65	1.40	1.46
2	C	701	ECL	C7-N1	-2.64	1.32	1.37
2	A	701	ECL	C7-N1	-2.63	1.32	1.37
4	A	706	POV	O21-C2	-2.62	1.40	1.46
4	D	707	POV	O21-C2	-2.61	1.40	1.46
2	D	702	ECL	C7-N1	-2.61	1.32	1.37
2	B	701	ECL	C16-CL8	2.41	1.79	1.73
2	C	701	ECL	C16-CL8	2.38	1.79	1.73
2	D	702	ECL	C16-CL8	2.37	1.79	1.73
2	A	701	ECL	C16-CL8	2.37	1.79	1.73
2	C	701	ECL	C14-CL4	2.02	1.78	1.74
2	B	701	ECL	C14-CL4	2.00	1.78	1.74

All (28) bond angle outliers are listed below:

Mol	Chain	Res	Type	Atoms	Z	Observed(°)	Ideal(°)
4	C	706	POV	O21-C21-C22	3.90	119.92	111.50

Continued on next page...

Continued from previous page...

Mol	Chain	Res	Type	Atoms	Z	Observed(°)	Ideal(°)
4	B	706	POV	O21-C21-C22	3.90	119.91	111.50
4	D	707	POV	O21-C21-C22	3.89	119.89	111.50
4	A	706	POV	O21-C21-C22	3.88	119.86	111.50
2	A	701	ECL	O20-C20-C17	-3.73	106.45	112.08
2	B	701	ECL	O20-C20-C17	-3.64	106.57	112.08
2	C	701	ECL	O20-C20-C17	-3.63	106.60	112.08
2	D	702	ECL	C21-C17-C16	3.47	120.26	116.81
2	B	701	ECL	C21-C17-C16	3.45	120.24	116.81
2	A	701	ECL	C21-C17-C16	3.41	120.21	116.81
2	C	701	ECL	C21-C17-C16	3.40	120.19	116.81
2	D	702	ECL	O20-C20-C17	-3.29	107.10	112.08
4	C	706	POV	O31-C31-C32	2.61	120.09	111.91
4	D	707	POV	O31-C31-C32	2.59	120.02	111.91
4	B	706	POV	O31-C31-C32	2.52	119.83	111.91
4	A	706	POV	O31-C31-C32	2.51	119.78	111.91
2	B	701	ECL	C15-C16-C17	-2.49	119.44	122.41
2	A	701	ECL	C15-C16-C17	-2.44	119.49	122.41
2	C	701	ECL	C15-C16-C17	-2.43	119.51	122.41
2	D	702	ECL	C15-C16-C17	-2.43	119.51	122.41
4	A	706	POV	C15-N-C12	2.38	119.65	109.92
4	C	706	POV	C15-N-C12	2.37	119.62	109.92
4	B	706	POV	C15-N-C12	2.36	119.56	109.92
4	D	707	POV	C15-N-C12	2.35	119.54	109.92
4	C	708	POV	C3-C2-C1	-2.27	109.01	113.95
4	B	708	POV	C3-C2-C1	-2.26	109.02	113.95
4	D	701	POV	C3-C2-C1	-2.25	109.05	113.95
4	A	708	POV	C3-C2-C1	-2.21	109.13	113.95

There are no chirality outliers.

All (358) torsion outliers are listed below:

Mol	Chain	Res	Type	Atoms
2	A	701	ECL	C17-C20-O20-C8
2	A	701	ECL	C19-C20-O20-C8
2	B	701	ECL	C17-C20-O20-C8
2	B	701	ECL	C19-C20-O20-C8
2	C	701	ECL	C17-C20-O20-C8
2	C	701	ECL	C19-C20-O20-C8
2	D	702	ECL	C17-C20-O20-C8
2	D	702	ECL	C19-C20-O20-C8
3	A	703	Y01	CAO-CBB-CBE-CAP
3	A	703	Y01	CAO-CBB-CBE-CBI

Continued on next page...

Continued from previous page...

Mol	Chain	Res	Type	Atoms
3	A	703	Y01	CAC-CBB-CBE-CBI
3	A	703	Y01	CAM-CAY-OAW-CBC
3	A	704	Y01	CAO-CBB-CBE-CAP
3	A	704	Y01	CAC-CBB-CBE-CBI
3	A	704	Y01	CAR-CBC-OAW-CAY
3	B	703	Y01	CAO-CBB-CBE-CAP
3	B	703	Y01	CAO-CBB-CBE-CBI
3	B	703	Y01	CAC-CBB-CBE-CBI
3	B	703	Y01	CAM-CAY-OAW-CBC
3	B	704	Y01	CAO-CBB-CBE-CAP
3	B	704	Y01	CAC-CBB-CBE-CBI
3	B	704	Y01	CAR-CBC-OAW-CAY
3	C	703	Y01	CAO-CBB-CBE-CAP
3	C	703	Y01	CAO-CBB-CBE-CBI
3	C	703	Y01	CAC-CBB-CBE-CBI
3	C	703	Y01	CAM-CAY-OAW-CBC
3	C	704	Y01	CAO-CBB-CBE-CAP
3	C	704	Y01	CAC-CBB-CBE-CBI
3	C	704	Y01	CAR-CBC-OAW-CAY
3	D	704	Y01	CAO-CBB-CBE-CAP
3	D	704	Y01	CAO-CBB-CBE-CBI
3	D	704	Y01	CAM-CAY-OAW-CBC
3	D	705	Y01	CAO-CBB-CBE-CAP
3	D	705	Y01	CAC-CBB-CBE-CBI
3	D	705	Y01	CAR-CBC-OAW-CAY
4	A	706	POV	O11-C1-C2-O21
4	A	706	POV	C22-C21-O21-C2
4	B	706	POV	O11-C1-C2-O21
4	B	706	POV	C22-C21-O21-C2
4	C	706	POV	O11-C1-C2-O21
4	C	706	POV	C22-C21-O21-C2
4	D	707	POV	O11-C1-C2-O21
4	D	707	POV	C22-C21-O21-C2
3	A	704	Y01	CAN-CAJ-CAO-CBB
3	B	704	Y01	CAN-CAJ-CAO-CBB
3	C	704	Y01	CAN-CAJ-CAO-CBB
3	D	705	Y01	CAN-CAJ-CAO-CBB
4	A	706	POV	O32-C31-O31-C3
4	B	706	POV	O32-C31-O31-C3
4	C	706	POV	O32-C31-O31-C3
4	D	707	POV	O32-C31-O31-C3

Continued on next page...

Continued from previous page...

Mol	Chain	Res	Type	Atoms
4	A	706	POV	C32-C31-O31-C3
4	B	706	POV	C32-C31-O31-C3
4	C	706	POV	C32-C31-O31-C3
4	D	707	POV	C32-C31-O31-C3
3	A	703	Y01	CAC-CBB-CBE-CAP
3	A	704	Y01	CAC-CBB-CBE-CAP
3	B	703	Y01	CAC-CBB-CBE-CAP
3	B	704	Y01	CAC-CBB-CBE-CAP
3	C	703	Y01	CAC-CBB-CBE-CAP
3	C	704	Y01	CAC-CBB-CBE-CAP
3	D	704	Y01	CAC-CBB-CBE-CAP
3	D	705	Y01	CAC-CBB-CBE-CAP
3	A	704	Y01	CAO-CBB-CBE-CBI
3	B	704	Y01	CAO-CBB-CBE-CBI
3	C	704	Y01	CAO-CBB-CBE-CBI
3	D	705	Y01	CAO-CBB-CBE-CBI
3	A	703	Y01	OAG-CAY-OAW-CBC
3	B	703	Y01	OAG-CAY-OAW-CBC
3	C	703	Y01	OAG-CAY-OAW-CBC
3	D	704	Y01	OAG-CAY-OAW-CBC
4	A	706	POV	O22-C21-O21-C2
4	B	706	POV	O22-C21-O21-C2
4	C	706	POV	O22-C21-O21-C2
4	D	707	POV	O22-C21-O21-C2
3	A	703	Y01	CAJ-CAO-CBB-CAC
3	B	703	Y01	CAJ-CAO-CBB-CAC
3	C	703	Y01	CAJ-CAO-CBB-CAC
3	D	704	Y01	CAJ-CAO-CBB-CAC
4	A	708	POV	C32-C33-C34-C35
4	B	708	POV	C32-C33-C34-C35
4	D	701	POV	C32-C33-C34-C35
4	C	708	POV	C32-C33-C34-C35
4	A	706	POV	C22-C23-C24-C25
4	B	706	POV	C22-C23-C24-C25
4	D	707	POV	C22-C23-C24-C25
4	C	706	POV	C22-C23-C24-C25
3	A	703	Y01	CAJ-CAO-CBB-CBE
3	B	703	Y01	CAJ-CAO-CBB-CBE
3	C	703	Y01	CAJ-CAO-CBB-CBE
3	D	704	Y01	CAJ-CAO-CBB-CBE
3	C	704	Y01	CAM-CAY-OAW-CBC
3	D	705	Y01	CAM-CAY-OAW-CBC

Continued on next page...

Continued from previous page...

Mol	Chain	Res	Type	Atoms
3	A	702	Y01	CAX-CAL-CAM-CAY
3	B	702	Y01	CAX-CAL-CAM-CAY
3	C	702	Y01	CAX-CAL-CAM-CAY
4	B	708	POV	C1-C2-C3-O31
3	A	704	Y01	CAM-CAY-OAW-CBC
3	B	704	Y01	CAM-CAY-OAW-CBC
4	A	707	POV	C21-C22-C23-C24
4	B	707	POV	C21-C22-C23-C24
4	D	708	POV	C21-C22-C23-C24
3	D	703	Y01	CAX-CAL-CAM-CAY
3	C	704	Y01	OAG-CAY-OAW-CBC
3	D	705	Y01	OAG-CAY-OAW-CBC
4	C	707	POV	C21-C22-C23-C24
3	B	703	Y01	CAO-CAJ-CAN-CBA
4	A	708	POV	C1-C2-C3-O31
4	C	708	POV	C1-C2-C3-O31
4	D	701	POV	C1-C2-C3-O31
3	A	704	Y01	OAG-CAY-OAW-CBC
3	B	704	Y01	OAG-CAY-OAW-CBC
3	A	703	Y01	CAO-CAJ-CAN-CBA
3	C	703	Y01	CAN-CAJ-CAO-CBB
3	D	704	Y01	CAO-CAJ-CAN-CBA
3	C	704	Y01	CAJ-CAO-CBB-CBE
3	C	703	Y01	CAO-CAJ-CAN-CBA
3	D	704	Y01	CAN-CAJ-CAO-CBB
4	A	706	POV	C1-O11-P-O12
4	B	706	POV	C1-O11-P-O12
4	C	706	POV	C1-O11-P-O12
4	D	707	POV	C1-O11-P-O12
3	A	703	Y01	CAN-CAJ-CAO-CBB
3	B	703	Y01	CAN-CAJ-CAO-CBB
4	B	705	POV	C39-C310-C311-C312
4	A	705	POV	C39-C310-C311-C312
4	D	706	POV	C39-C310-C311-C312
3	B	704	Y01	CAJ-CAO-CBB-CBE
3	D	705	Y01	CAJ-CAO-CBB-CBE
4	C	705	POV	C39-C310-C311-C312
4	A	705	POV	C37-C38-C39-C310
4	C	705	POV	C37-C38-C39-C310
4	D	706	POV	C37-C38-C39-C310
4	B	705	POV	C37-C38-C39-C310
4	C	706	POV	C33-C34-C35-C36

Continued on next page...

Continued from previous page...

Mol	Chain	Res	Type	Atoms
4	D	707	POV	C33-C34-C35-C36
4	D	708	POV	C212-C213-C214-C215
3	B	702	Y01	CAO-CAJ-CAN-CBA
4	B	706	POV	C33-C34-C35-C36
4	A	706	POV	C33-C34-C35-C36
4	A	707	POV	C212-C213-C214-C215
3	C	704	Y01	CAJ-CAO-CBB-CAC
3	A	702	Y01	CAO-CAJ-CAN-CBA
3	C	702	Y01	CAO-CAJ-CAN-CBA
3	D	703	Y01	CAO-CAJ-CAN-CBA
4	B	707	POV	C212-C213-C214-C215
4	D	708	POV	C211-C210-C29-C28
4	C	707	POV	C212-C213-C214-C215
4	A	706	POV	C211-C212-C213-C214
4	B	706	POV	C211-C212-C213-C214
4	D	707	POV	C211-C212-C213-C214
4	C	706	POV	C211-C212-C213-C214
4	B	707	POV	C211-C210-C29-C28
4	C	707	POV	C22-C23-C24-C25
3	B	704	Y01	CAJ-CAO-CBB-CAC
3	D	705	Y01	CAJ-CAO-CBB-CAC
4	A	706	POV	C35-C36-C37-C38
4	B	707	POV	C22-C21-O21-C2
4	C	707	POV	C22-C21-O21-C2
4	B	706	POV	C35-C36-C37-C38
4	A	707	POV	C22-C23-C24-C25
4	A	706	POV	C34-C35-C36-C37
4	B	707	POV	C22-C23-C24-C25
4	D	708	POV	C24-C25-C26-C27
4	C	706	POV	C313-C314-C315-C316
4	A	706	POV	C313-C314-C315-C316
4	B	707	POV	C24-C25-C26-C27
4	A	707	POV	C24-C25-C26-C27
4	D	707	POV	C313-C314-C315-C316
4	D	708	POV	C22-C21-O21-C2
4	A	705	POV	C310-C311-C312-C313
4	B	706	POV	C313-C314-C315-C316
4	B	705	POV	C310-C311-C312-C313
4	C	705	POV	C310-C311-C312-C313
4	D	706	POV	C310-C311-C312-C313
4	C	707	POV	C24-C25-C26-C27
4	C	706	POV	C35-C36-C37-C38

Continued on next page...

Continued from previous page...

Mol	Chain	Res	Type	Atoms
4	C	707	POV	C25-C26-C27-C28
4	D	707	POV	C35-C36-C37-C38
4	A	707	POV	C25-C26-C27-C28
4	B	706	POV	C34-C35-C36-C37
4	D	707	POV	C37-C38-C39-C310
4	D	708	POV	C22-C23-C24-C25
4	A	705	POV	C35-C36-C37-C38
4	C	706	POV	C37-C38-C39-C310
4	A	707	POV	C211-C210-C29-C28
4	B	707	POV	C25-C26-C27-C28
4	D	706	POV	C35-C36-C37-C38
4	B	706	POV	O11-C1-C2-C3
4	C	706	POV	O11-C1-C2-C3
4	D	707	POV	O11-C1-C2-C3
4	B	705	POV	C35-C36-C37-C38
4	A	707	POV	C22-C21-O21-C2
4	C	705	POV	C35-C36-C37-C38
4	C	707	POV	C211-C210-C29-C28
4	B	706	POV	C37-C38-C39-C310
3	A	703	Y01	CAJ-CAN-CBA-CAB
3	B	703	Y01	CAJ-CAN-CBA-CAB
3	D	704	Y01	CAJ-CAN-CBA-CAB
4	C	706	POV	C34-C35-C36-C37
4	B	706	POV	C24-C25-C26-C27
4	A	708	POV	C32-C31-O31-C3
3	C	703	Y01	CAJ-CAN-CBA-CAB
4	B	706	POV	C212-C213-C214-C215
4	A	706	POV	C212-C213-C214-C215
4	C	706	POV	C212-C213-C214-C215
4	D	707	POV	C212-C213-C214-C215
4	D	707	POV	C34-C35-C36-C37
4	D	708	POV	C25-C26-C27-C28
4	A	706	POV	C24-C25-C26-C27
3	A	703	Y01	CAJ-CAN-CBA-CAA
3	B	703	Y01	CAJ-CAN-CBA-CAA
3	D	704	Y01	CAJ-CAN-CBA-CAA
2	A	701	ECL	N1-C19-C20-O20
2	B	701	ECL	N1-C19-C20-O20
2	C	701	ECL	N1-C19-C20-O20
2	D	702	ECL	N1-C19-C20-O20
4	A	706	POV	O11-C1-C2-C3
4	A	706	POV	C37-C38-C39-C310

Continued on next page...

Continued from previous page...

Mol	Chain	Res	Type	Atoms
3	C	703	Y01	CAJ-CAN-CBA-CAA
3	D	705	Y01	CAO-CAJ-CAN-CBA
4	D	701	POV	C32-C31-O31-C3
4	D	707	POV	C24-C25-C26-C27
3	B	704	Y01	CAO-CAJ-CAN-CBA
4	C	706	POV	C24-C25-C26-C27
4	A	708	POV	O32-C31-O31-C3
4	A	706	POV	C310-C311-C312-C313
3	A	704	Y01	CAJ-CAO-CBB-CBE
4	C	705	POV	C34-C35-C36-C37
4	B	706	POV	C310-C311-C312-C313
4	C	706	POV	C310-C311-C312-C313
4	C	706	POV	C21-C22-C23-C24
3	C	704	Y01	CAO-CAJ-CAN-CBA
4	A	706	POV	C11-O12-P-O11
4	B	706	POV	C11-O12-P-O11
4	D	707	POV	C11-O12-P-O11
4	D	701	POV	O32-C31-O31-C3
4	A	706	POV	C1-O11-P-O13
4	A	706	POV	C1-O11-P-O14
4	A	706	POV	C11-O12-P-O14
4	B	706	POV	C1-O11-P-O13
4	B	706	POV	C1-O11-P-O14
4	B	706	POV	C11-O12-P-O14
4	C	706	POV	C1-O11-P-O13
4	C	706	POV	C1-O11-P-O14
4	C	706	POV	C11-O12-P-O14
4	D	707	POV	C1-O11-P-O13
4	D	707	POV	C1-O11-P-O14
4	D	707	POV	C11-O12-P-O14
4	B	708	POV	C32-C31-O31-C3
4	C	708	POV	C32-C31-O31-C3
4	D	706	POV	C34-C35-C36-C37
4	B	705	POV	C34-C35-C36-C37
4	A	705	POV	C34-C35-C36-C37
4	D	707	POV	C310-C311-C312-C313
4	B	706	POV	C21-C22-C23-C24
4	D	707	POV	C21-C22-C23-C24
4	C	705	POV	C311-C310-C39-C38
4	B	707	POV	O22-C21-O21-C2
4	A	706	POV	C21-C22-C23-C24
4	A	705	POV	C311-C310-C39-C38

Continued on next page...

Continued from previous page...

Mol	Chain	Res	Type	Atoms
4	D	706	POV	C311-C310-C39-C38
4	C	707	POV	O22-C21-O21-C2
4	B	705	POV	C311-C310-C39-C38
3	A	704	Y01	CAO-CAJ-CAN-CBA
4	B	708	POV	O32-C31-O31-C3
4	C	708	POV	O32-C31-O31-C3
4	D	708	POV	O22-C21-O21-C2
4	C	706	POV	C23-C24-C25-C26
4	A	707	POV	O22-C21-O21-C2
4	A	706	POV	C23-C24-C25-C26
4	D	707	POV	C23-C24-C25-C26
4	C	706	POV	C11-O12-P-O11
4	B	706	POV	C23-C24-C25-C26
4	A	708	POV	C36-C37-C38-C39
4	D	701	POV	C36-C37-C38-C39
4	B	708	POV	C36-C37-C38-C39
4	C	708	POV	C36-C37-C38-C39
4	D	706	POV	C32-C33-C34-C35
4	B	705	POV	C32-C33-C34-C35
4	A	705	POV	C32-C33-C34-C35
3	A	702	Y01	CAM-CAL-CAX-OAF
3	D	703	Y01	CAM-CAL-CAX-OAF
3	B	702	Y01	CAM-CAL-CAX-OAF
4	C	705	POV	C32-C33-C34-C35
3	C	702	Y01	CAM-CAL-CAX-OAF
3	B	703	Y01	CAX-CAL-CAM-CAY
3	A	704	Y01	CAJ-CAO-CBB-CAC
4	A	706	POV	C214-C215-C216-C217
3	D	704	Y01	CAX-CAL-CAM-CAY
4	C	705	POV	C33-C34-C35-C36
3	B	704	Y01	CAL-CAM-CAY-OAW
4	C	706	POV	C11-C12-N-C15
3	C	703	Y01	CAM-CAL-CAX-OAH
4	B	706	POV	C214-C215-C216-C217
3	A	704	Y01	CAL-CAM-CAY-OAW
3	C	704	Y01	CAL-CAM-CAY-OAW
3	D	705	Y01	CAL-CAM-CAY-OAW
4	D	708	POV	C29-C210-C211-C212
3	A	703	Y01	CAM-CAL-CAX-OAH
4	C	706	POV	C214-C215-C216-C217
4	D	707	POV	C214-C215-C216-C217
3	B	703	Y01	CAM-CAL-CAX-OAH

Continued on next page...

Continued from previous page...

Mol	Chain	Res	Type	Atoms
3	C	703	Y01	CAX-CAL-CAM-CAY
4	B	705	POV	C33-C34-C35-C36
4	A	705	POV	C33-C34-C35-C36
4	B	706	POV	C11-C12-N-C15
4	D	707	POV	C11-C12-N-C15
4	D	706	POV	C33-C34-C35-C36
4	A	707	POV	C29-C210-C211-C212
3	B	702	Y01	CAM-CAL-CAX-OAH
3	D	704	Y01	CAM-CAL-CAX-OAH
3	C	703	Y01	CAM-CAL-CAX-OAF
4	C	707	POV	C29-C210-C211-C212
3	B	703	Y01	CAM-CAL-CAX-OAF
4	A	706	POV	C11-C12-N-C15
3	C	702	Y01	CAM-CAL-CAX-OAH
3	A	702	Y01	CAM-CAL-CAX-OAH
3	A	703	Y01	CAM-CAL-CAX-OAF
3	D	703	Y01	CAM-CAL-CAX-OAH
2	A	701	ECL	N1-C19-C20-C17
2	B	701	ECL	N1-C19-C20-C17
2	C	701	ECL	N1-C19-C20-C17
2	D	702	ECL	N1-C19-C20-C17
4	B	706	POV	O31-C31-C32-C33
3	D	704	Y01	CAM-CAL-CAX-OAF
4	A	706	POV	O31-C31-C32-C33
4	D	707	POV	O31-C31-C32-C33
4	C	707	POV	C27-C28-C29-C210
4	C	707	POV	O21-C21-C22-C23
3	D	705	Y01	CAM-CAL-CAX-OAH
4	B	707	POV	C29-C210-C211-C212
4	A	707	POV	O21-C21-C22-C23
4	B	707	POV	O21-C21-C22-C23
4	C	706	POV	O31-C31-C32-C33
3	B	704	Y01	CAM-CAL-CAX-OAH
4	D	708	POV	O21-C21-C22-C23
3	C	704	Y01	CAM-CAL-CAX-OAH
4	C	706	POV	O32-C31-C32-C33
3	A	704	Y01	CAM-CAL-CAX-OAH
4	B	706	POV	O32-C31-C32-C33
4	D	707	POV	O32-C31-C32-C33
4	A	706	POV	C11-O12-P-O13
4	A	706	POV	O32-C31-C32-C33
4	A	707	POV	O22-C21-C22-C23

Continued on next page...

Continued from previous page...

Mol	Chain	Res	Type	Atoms
3	D	705	Y01	CAM-CAL-CAX-OAF
4	B	707	POV	O22-C21-C22-C23
4	A	706	POV	C11-C12-N-C13
4	B	706	POV	C11-C12-N-C13
4	C	706	POV	C11-C12-N-C13
4	D	707	POV	C11-C12-N-C13
4	A	707	POV	C27-C28-C29-C210
3	B	704	Y01	CAM-CAL-CAX-OAF
4	C	707	POV	O22-C21-C22-C23
4	D	708	POV	O22-C21-C22-C23
3	A	704	Y01	CAM-CAL-CAX-OAF
3	C	704	Y01	CAM-CAL-CAX-OAF

There are no ring outliers.

23 monomers are involved in 103 short contacts:

Mol	Chain	Res	Type	Clashes	Symm-Clashes
3	A	703	Y01	10	0
3	B	702	Y01	5	0
3	D	705	Y01	9	0
2	A	701	ECL	1	0
4	D	707	POV	4	0
4	C	707	POV	1	0
3	B	704	Y01	8	0
4	C	706	POV	4	0
3	D	703	Y01	4	0
3	B	703	Y01	11	0
4	D	708	POV	1	0
4	A	706	POV	3	0
3	A	702	Y01	3	0
2	B	701	ECL	1	0
4	B	706	POV	4	0
3	A	704	Y01	9	0
3	D	704	Y01	10	0
4	A	707	POV	1	0
3	C	704	Y01	7	0
3	C	703	Y01	10	0
2	D	702	ECL	1	0
3	C	702	Y01	3	0
2	C	701	ECL	1	0

The following is a two-dimensional graphical depiction of Mogul quality analysis of bond lengths,

bond angles, torsion angles, and ring geometry for all instances of the Ligand of Interest. In addition, ligands with molecular weight > 250 and outliers as shown on the validation Tables will also be included. For torsion angles, if less than 5% of the Mogul distribution of torsion angles is within 10 degrees of the torsion angle in question, then that torsion angle is considered an outlier. Any bond that is central to one or more torsion angles identified as an outlier by Mogul will be highlighted in the graph. For rings, the root-mean-square deviation (RMSD) between the ring in question and similar rings identified by Mogul is calculated over all ring torsion angles. If the average RMSD is greater than 60 degrees and the minimal RMSD between the ring in question and any Mogul-identified rings is also greater than 60 degrees, then that ring is considered an outlier. The outliers are highlighted in purple. The color gray indicates Mogul did not find sufficient equivalents in the CSD to analyse the geometry.

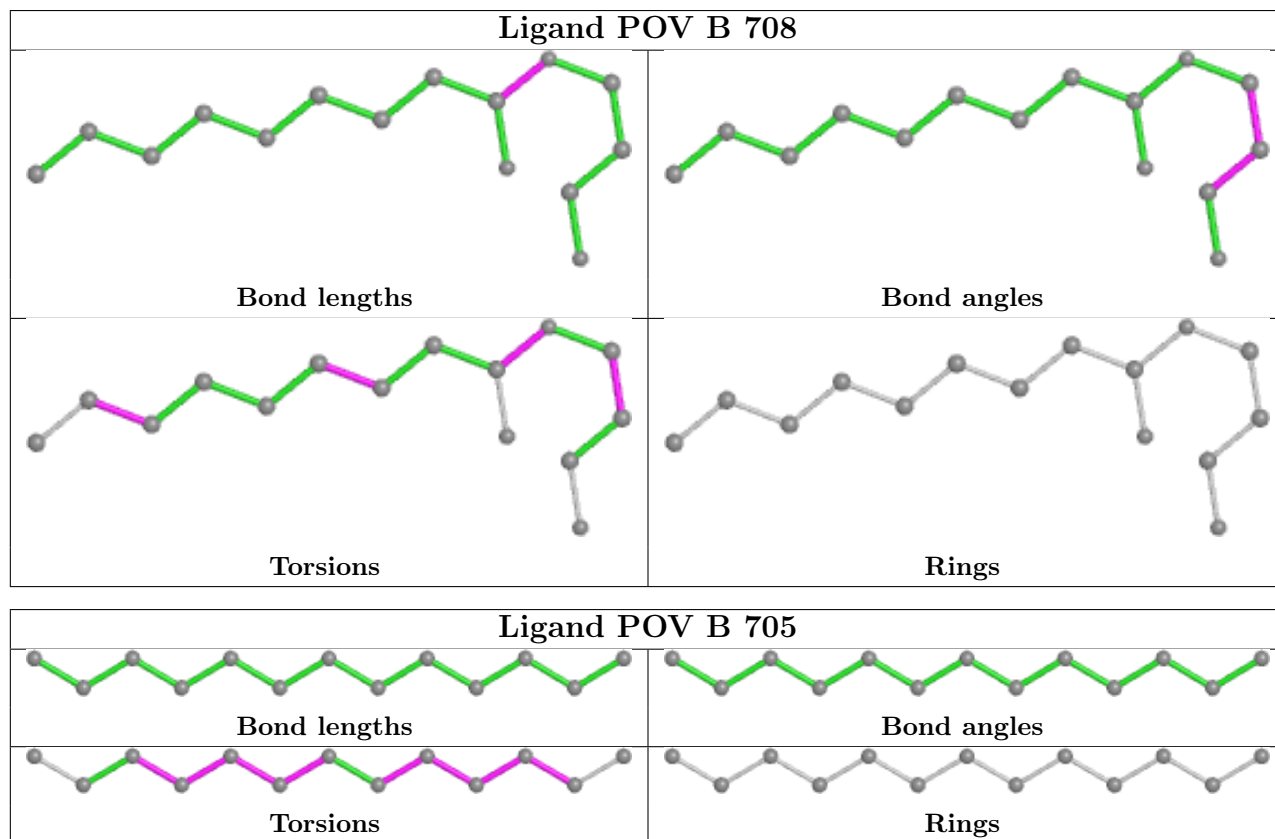

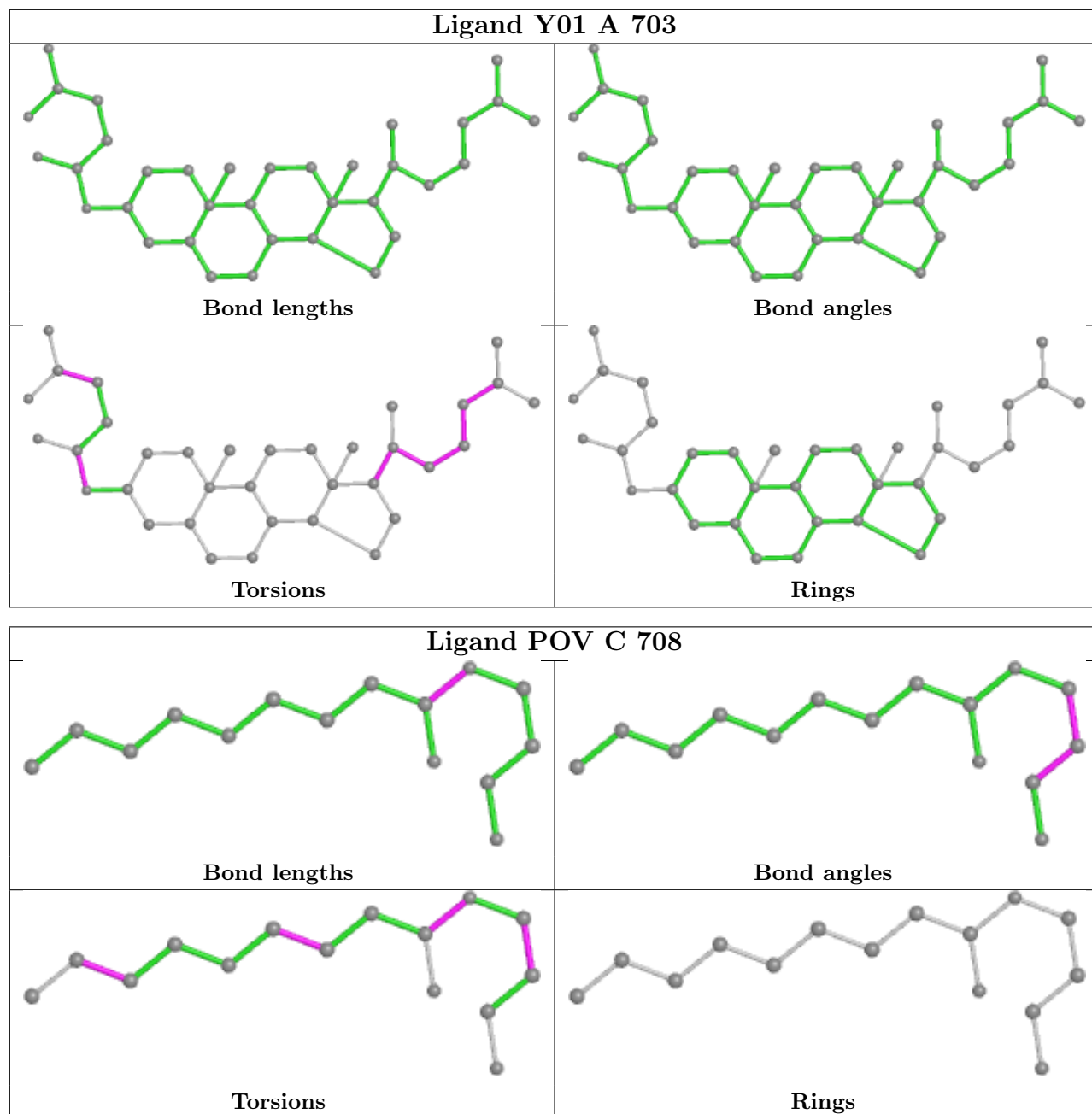

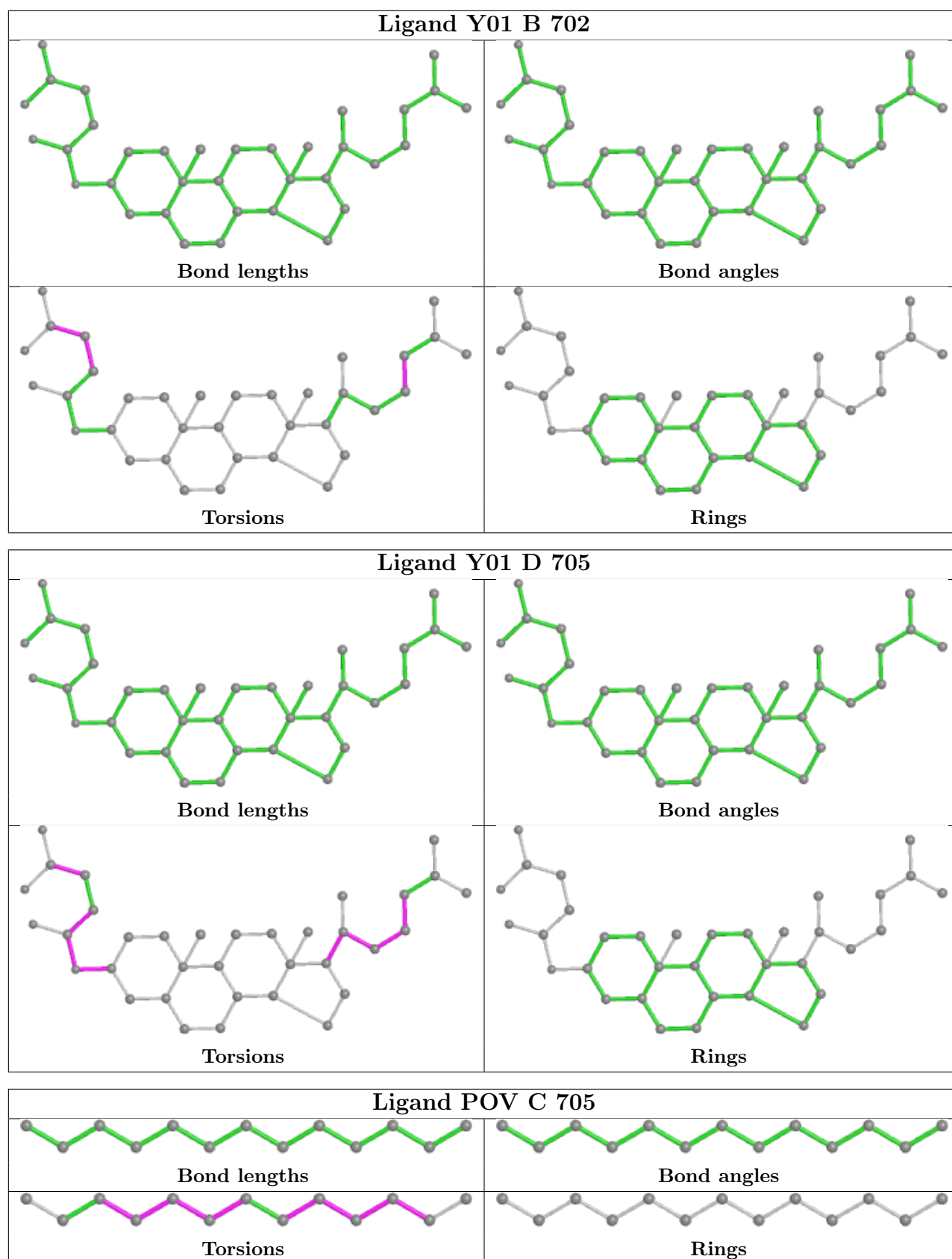

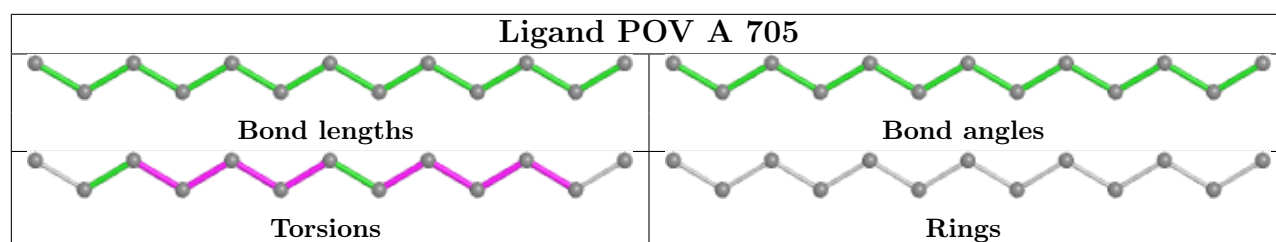
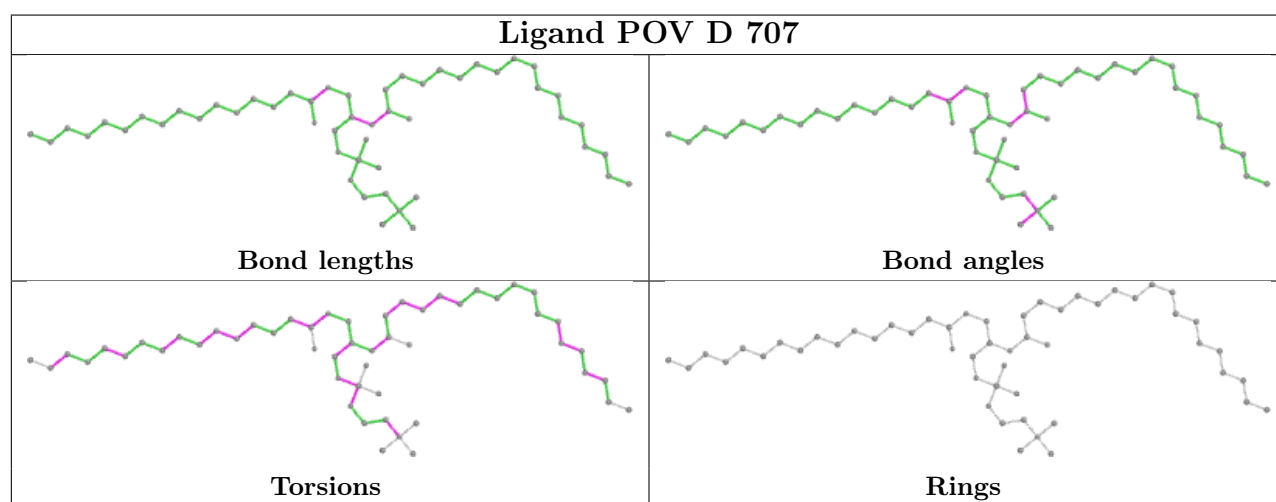
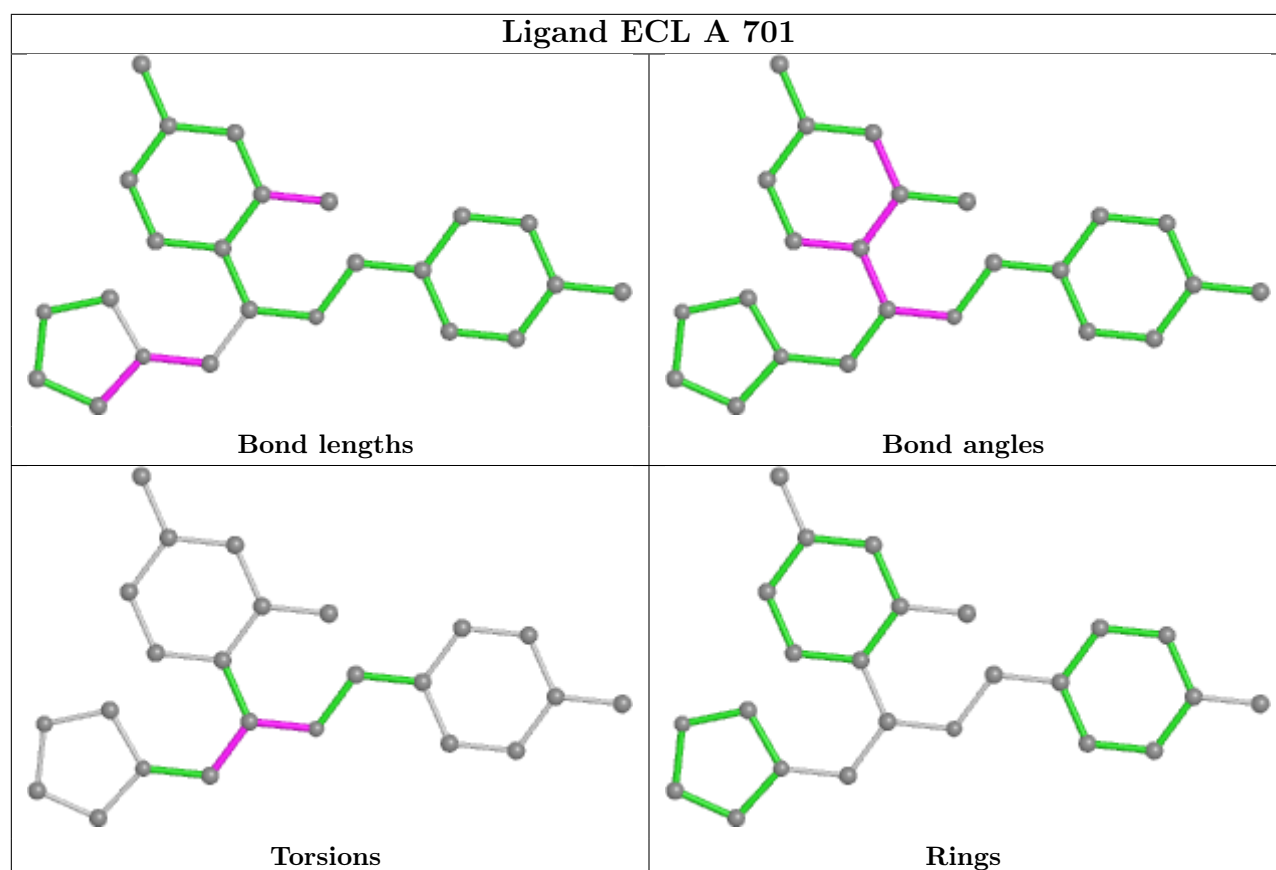

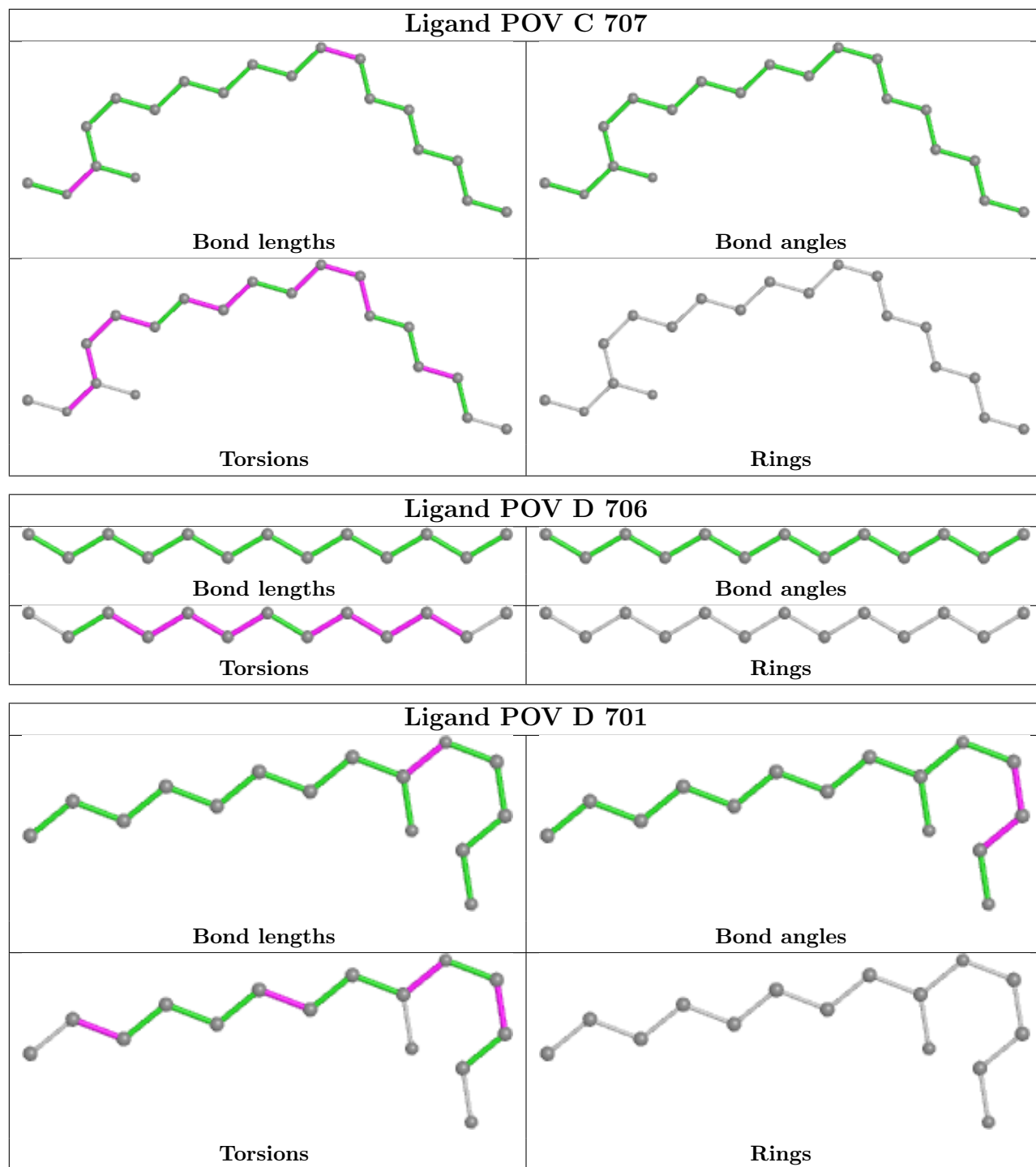

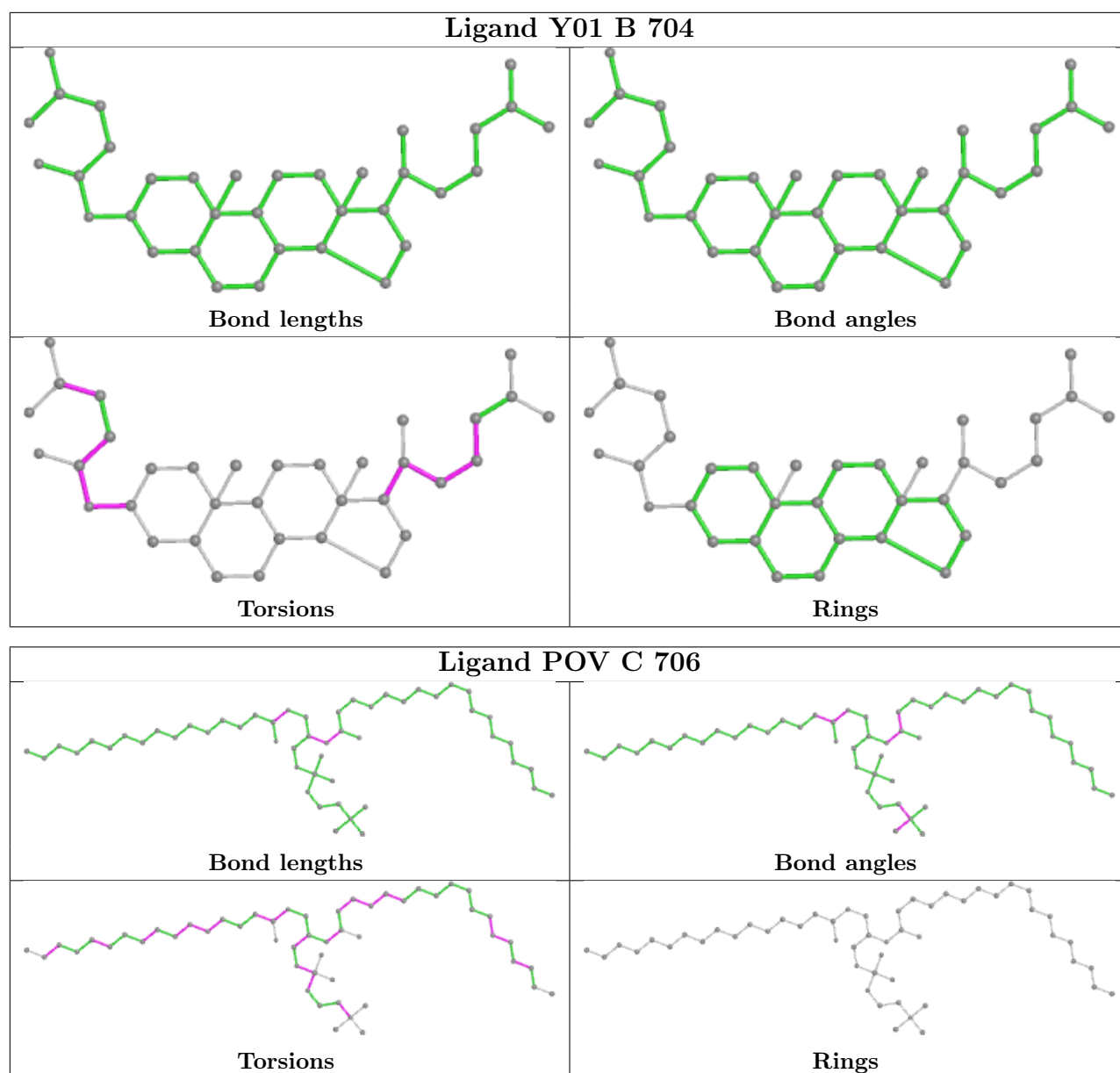

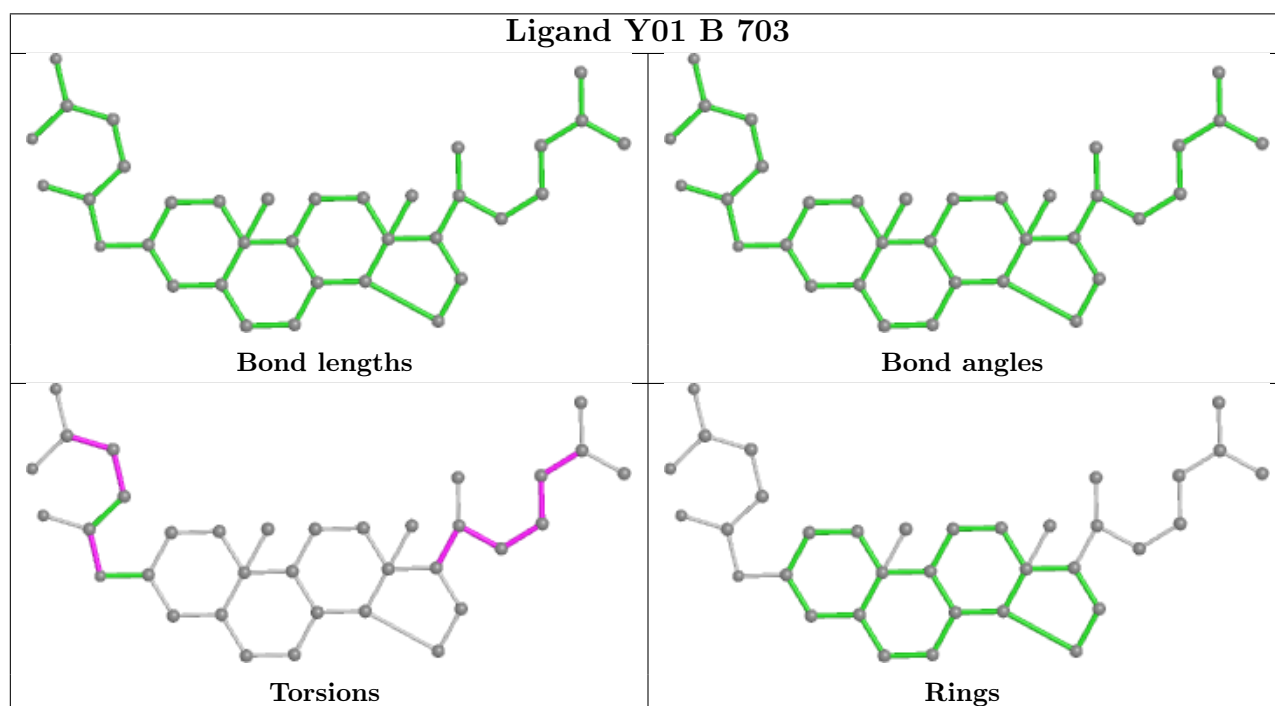
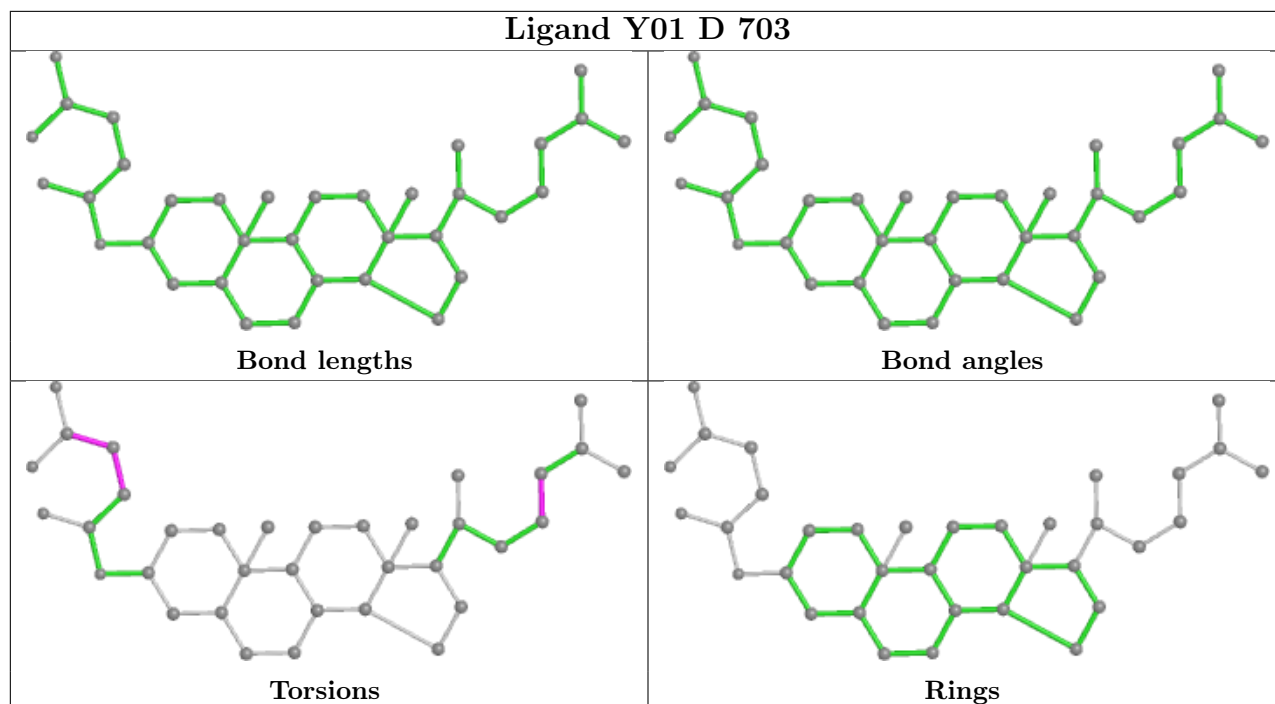

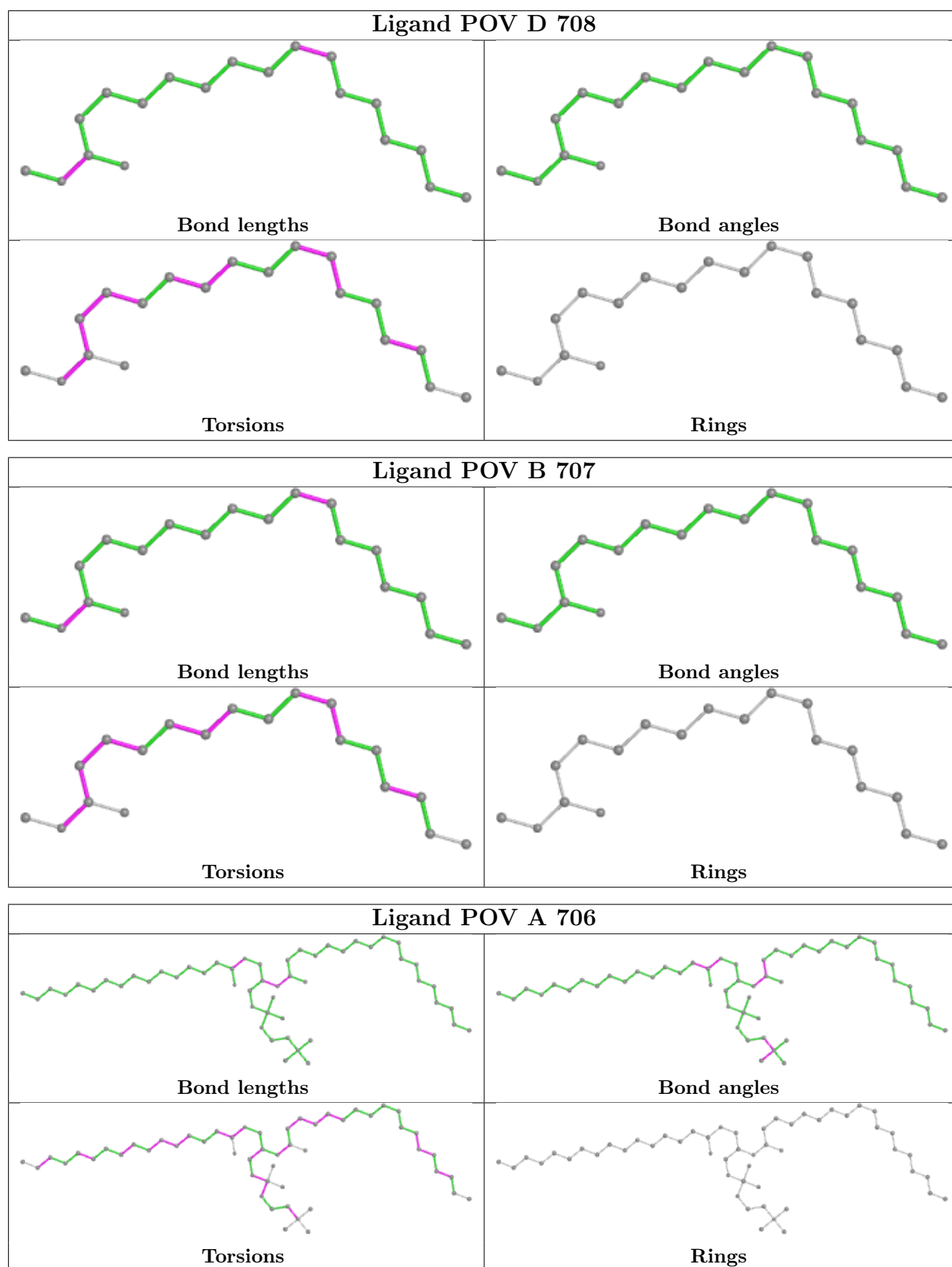

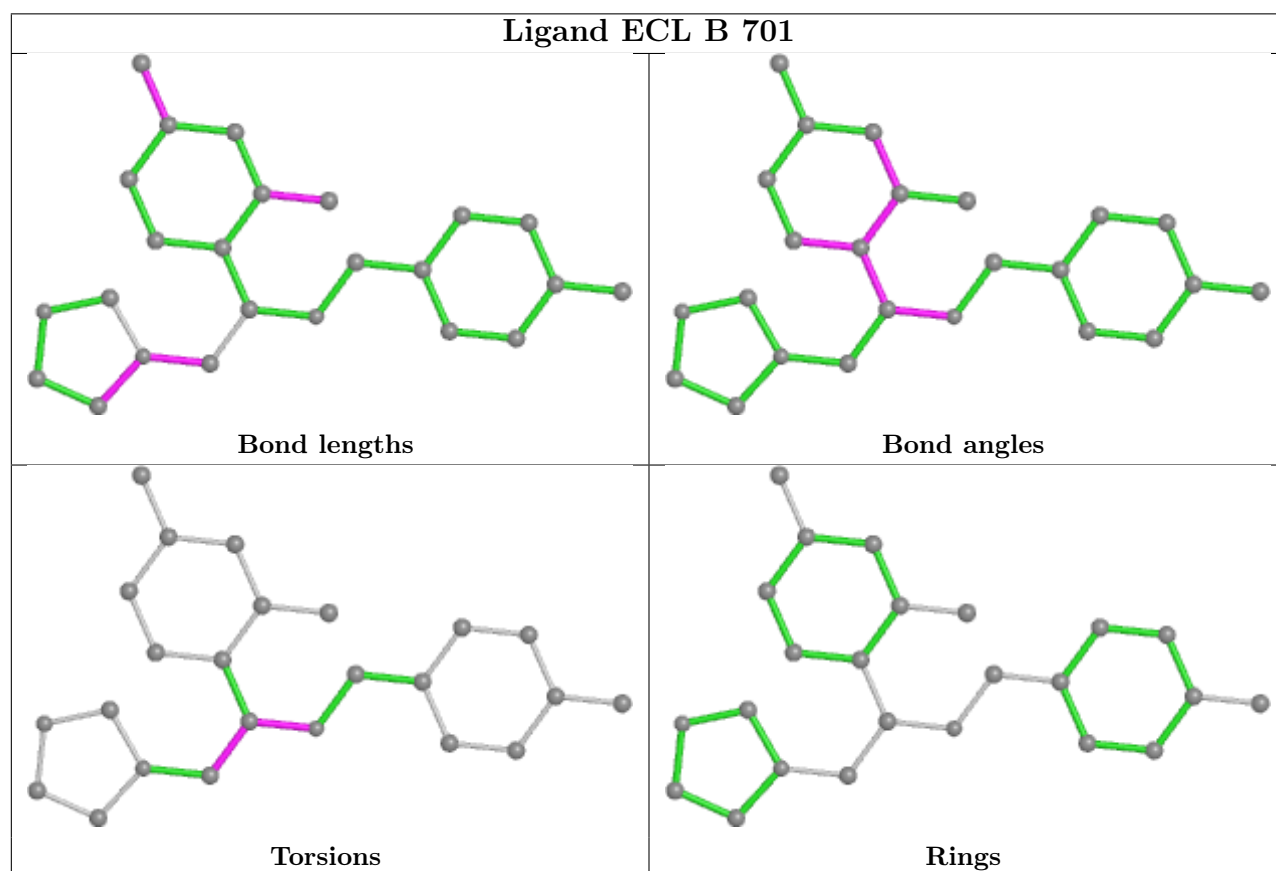
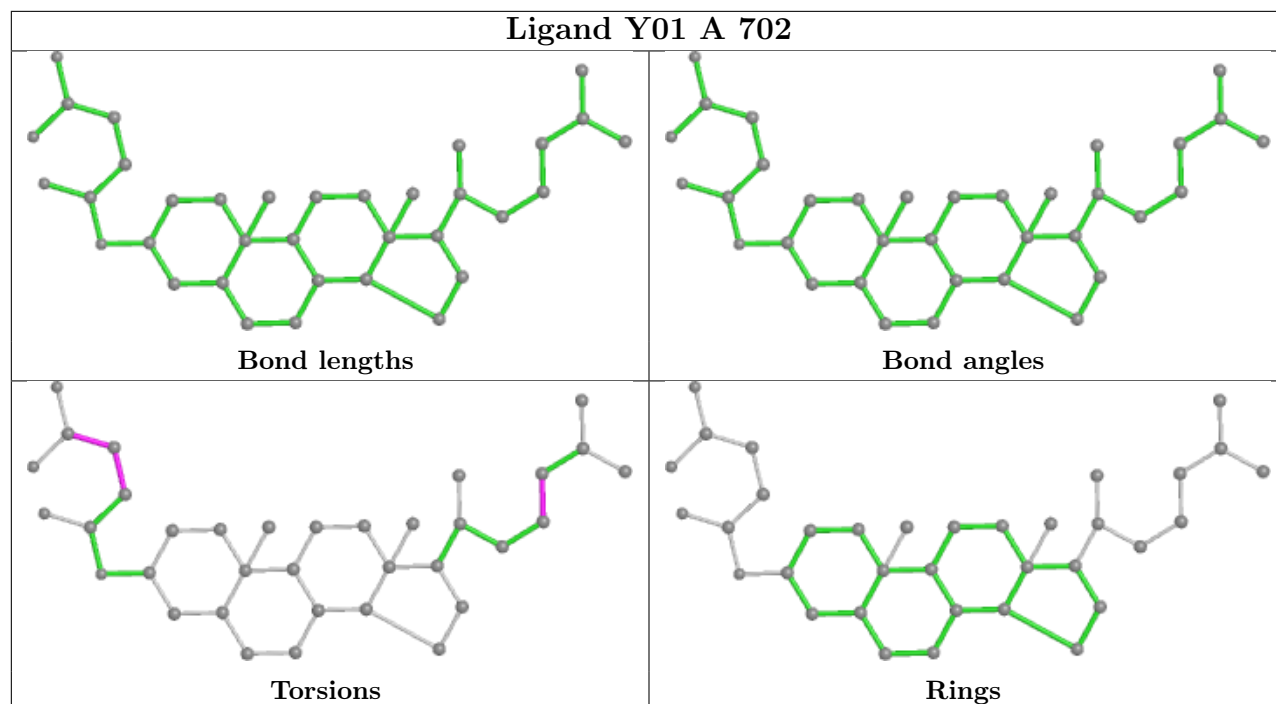

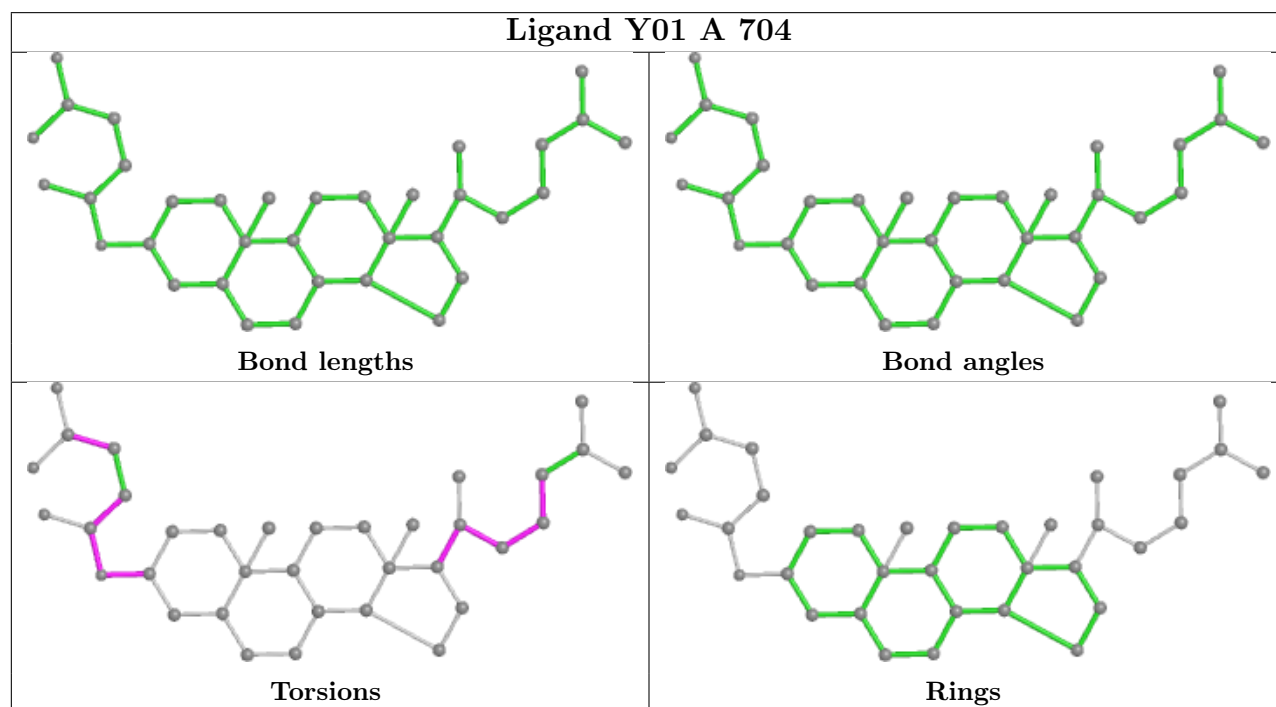
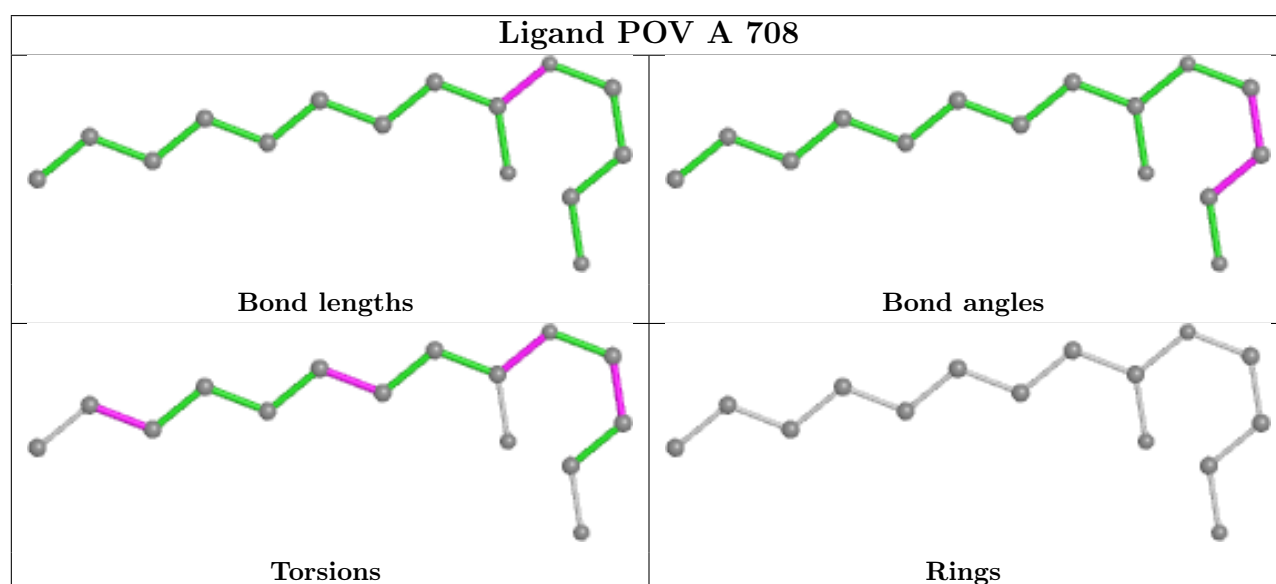
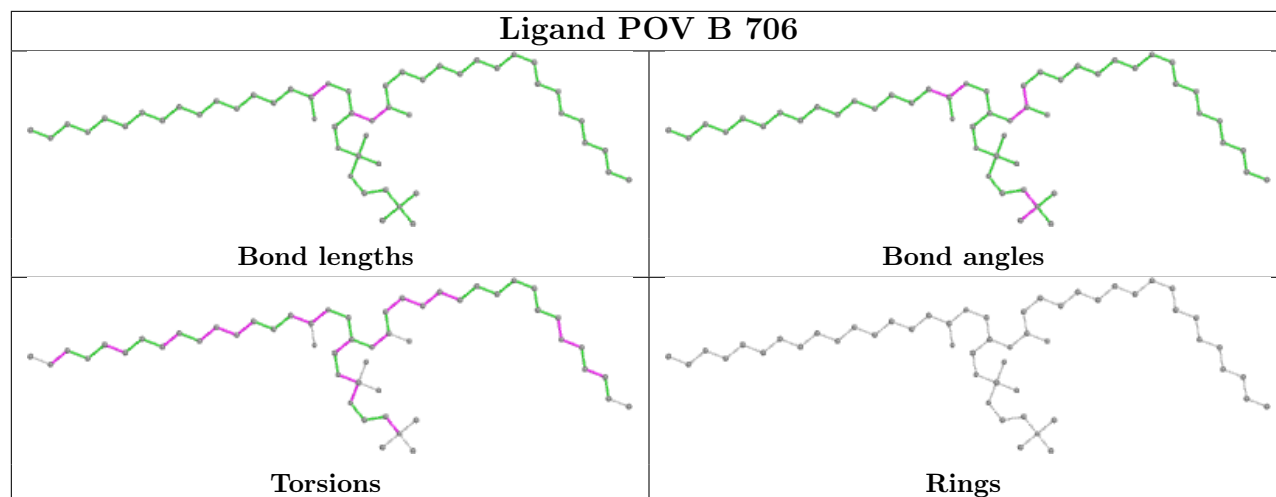

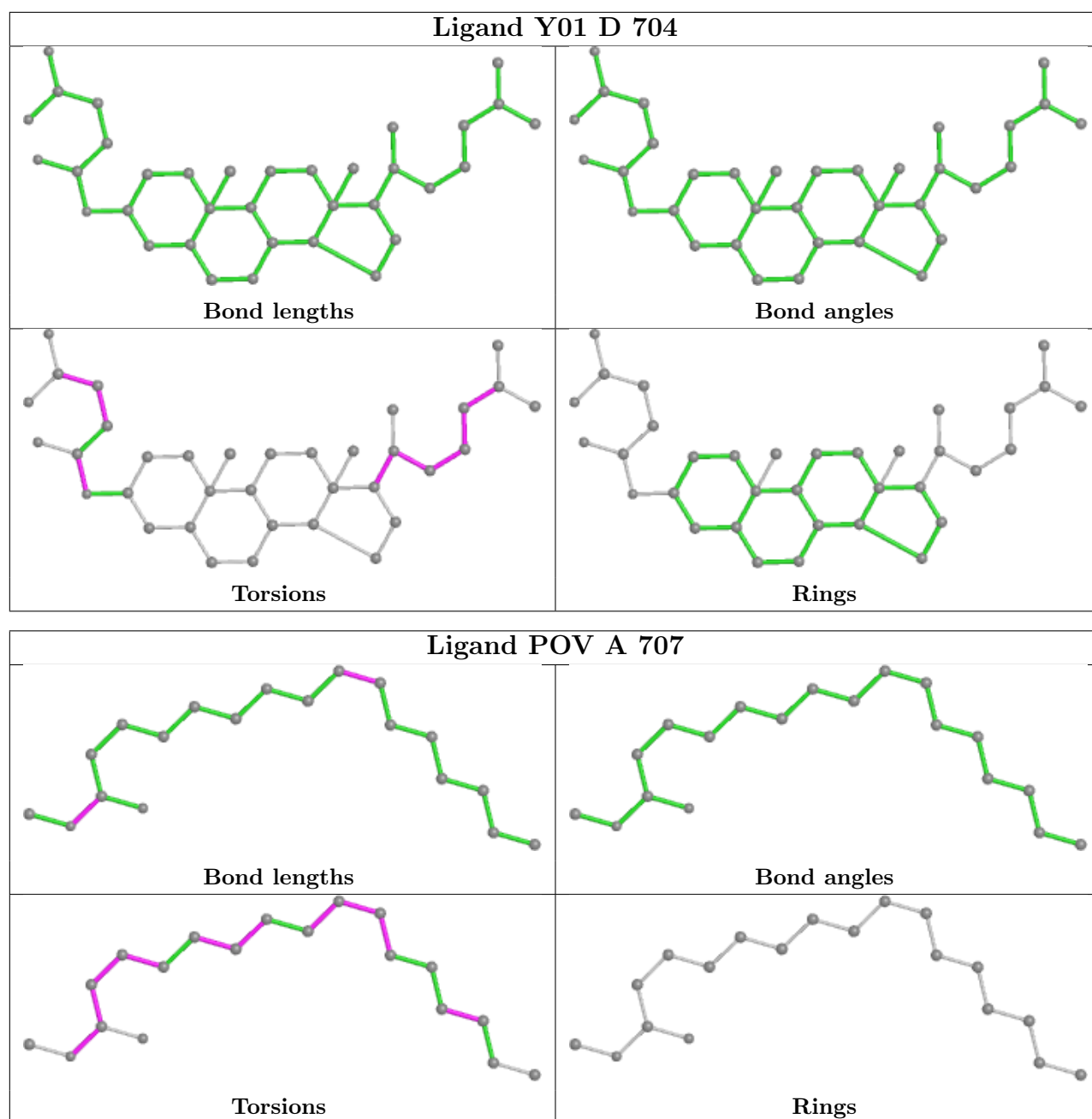

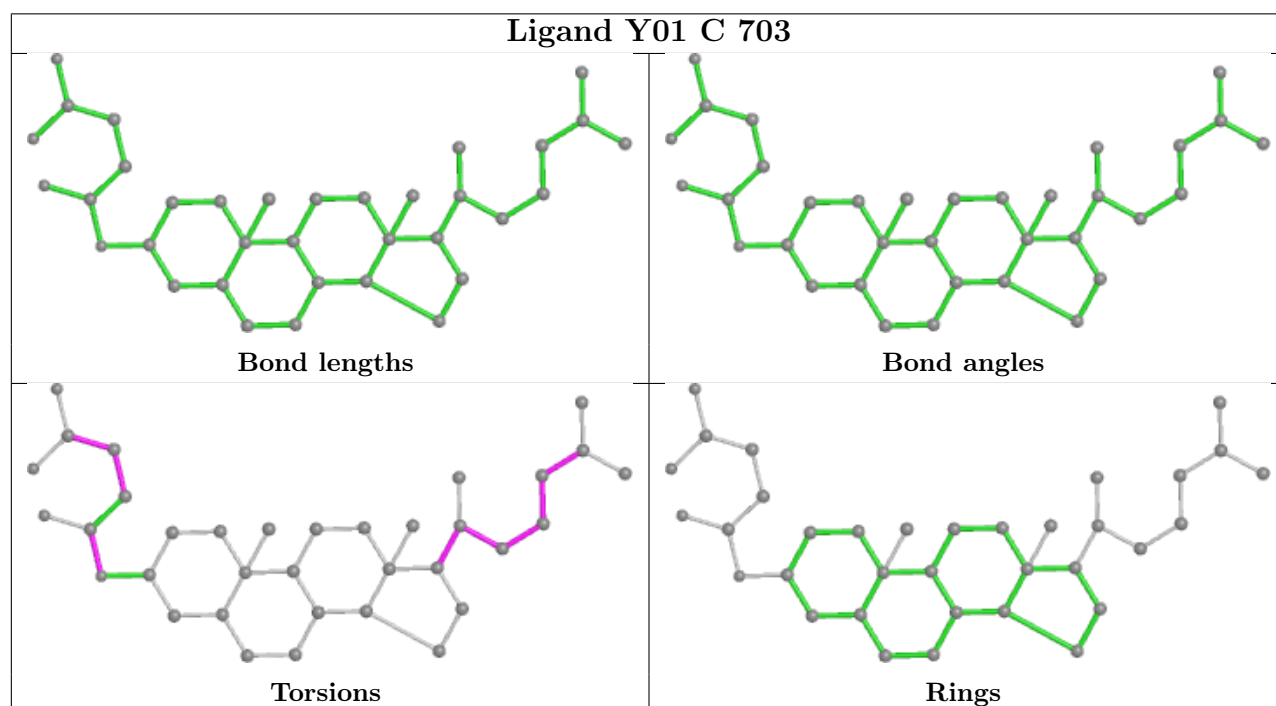
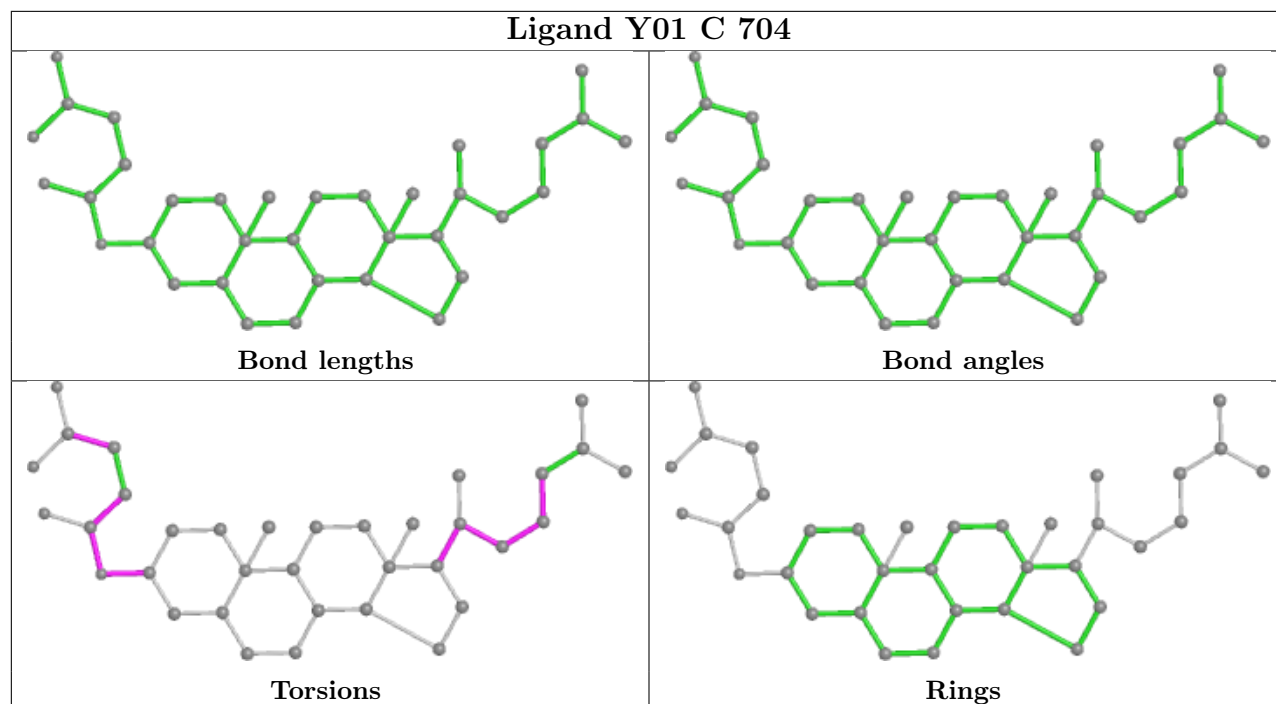

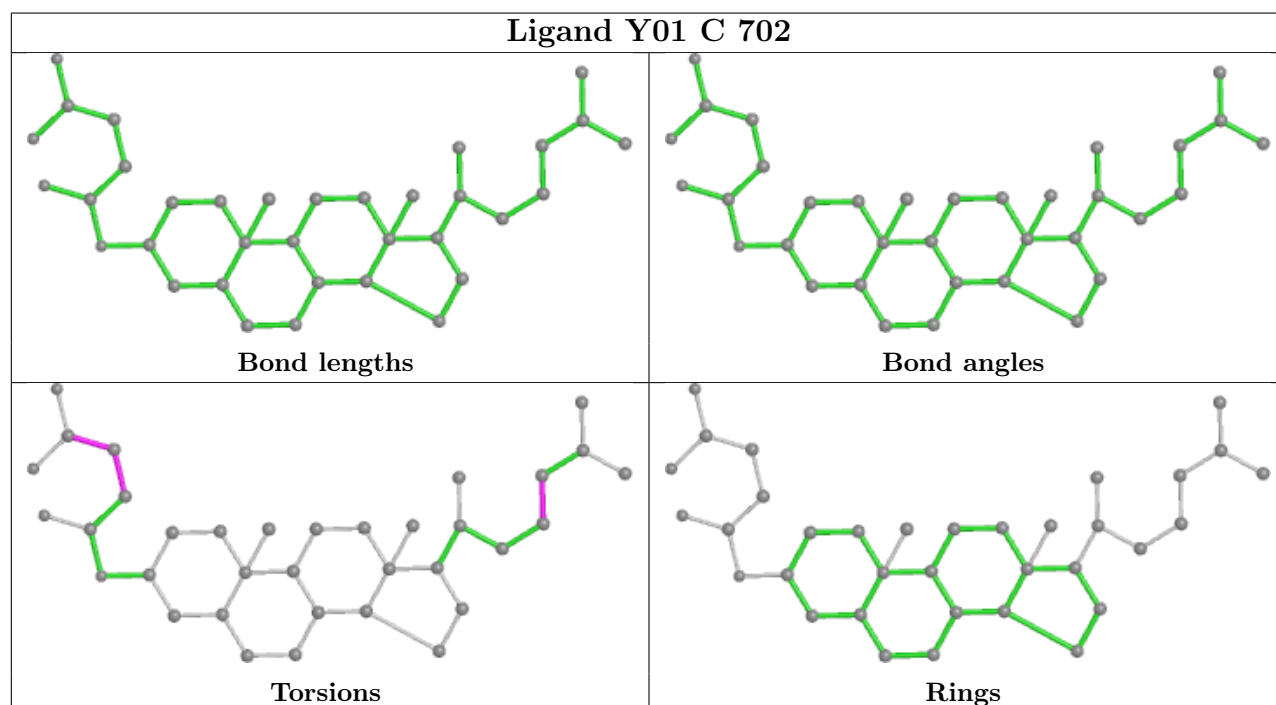
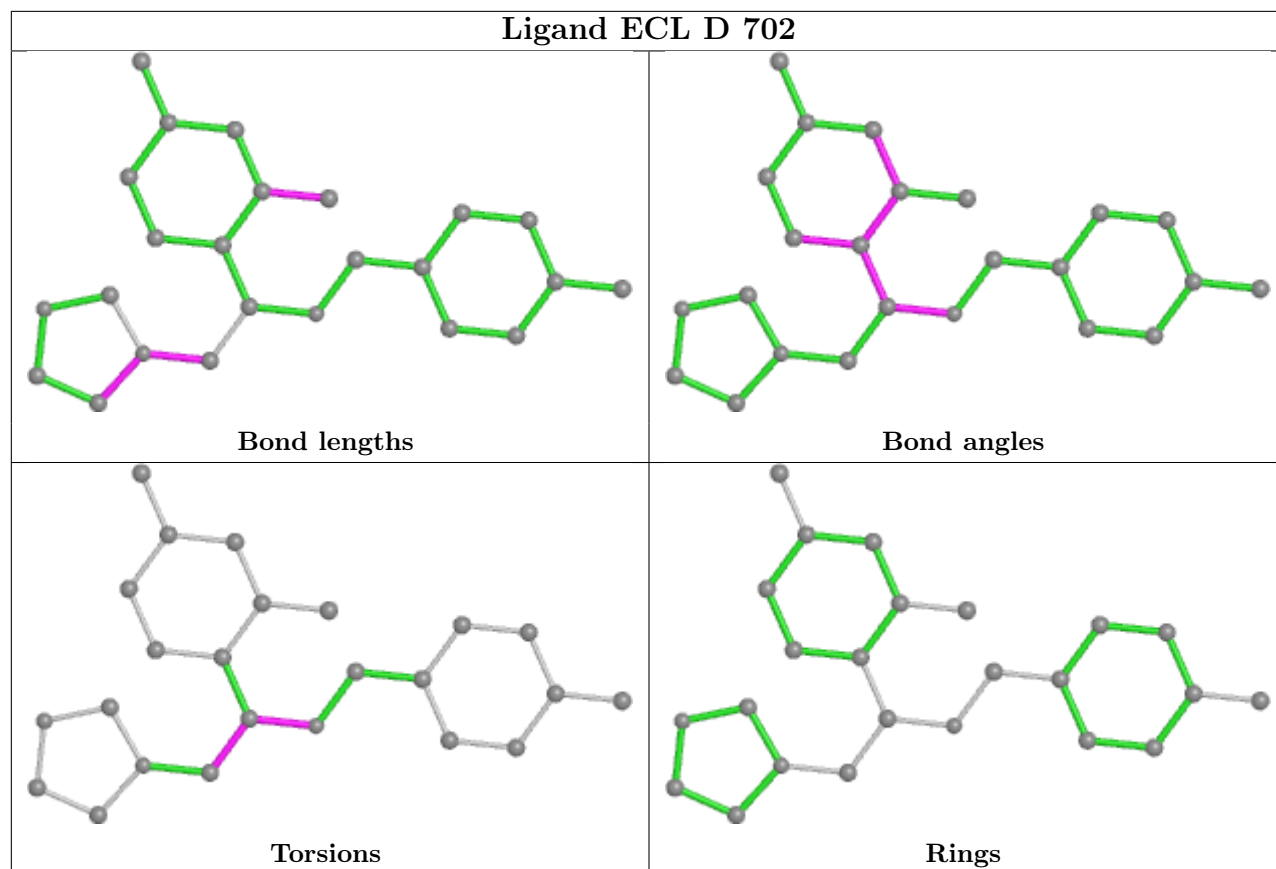

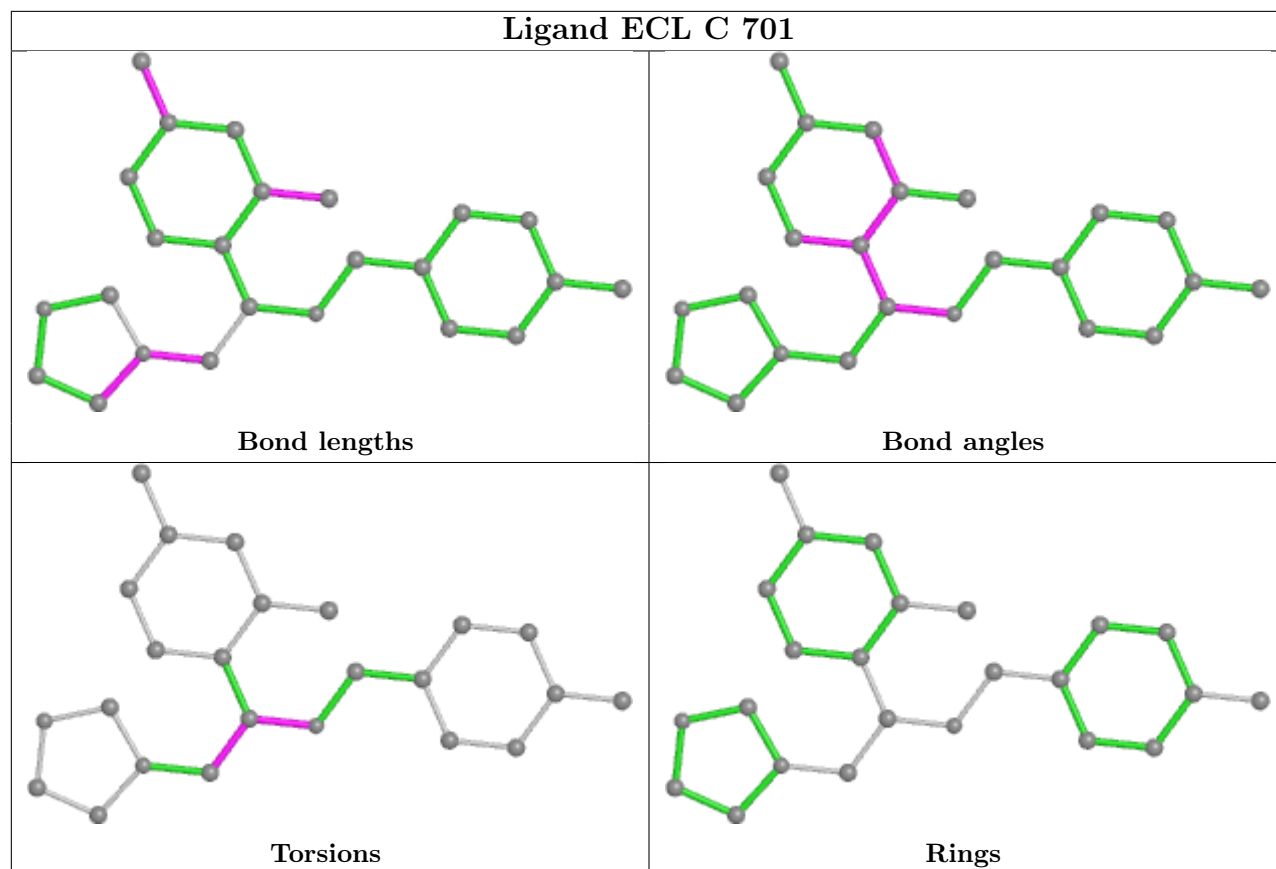

5.7 Other polymers [i](#)

There are no such residues in this entry.

5.8 Polymer linkage issues [i](#)

There are no chain breaks in this entry.

6 Map visualisation [i](#)

This section contains visualisations of the EMDB entry EMD-24893. These allow visual inspection of the internal detail of the map and identification of artifacts.

No raw map or half-maps were deposited for this entry and therefore no images, graphs, etc. pertaining to the raw map can be shown.

6.1 Orthogonal projections [i](#)

6.1.1 Primary map

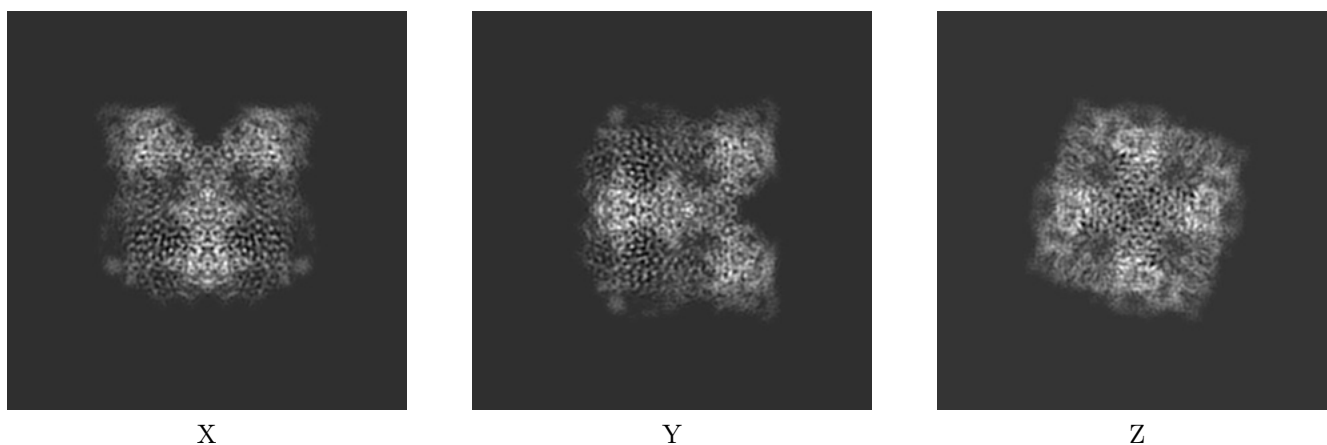

The images above show the map projected in three orthogonal directions.

6.2 Central slices [i](#)

6.2.1 Primary map

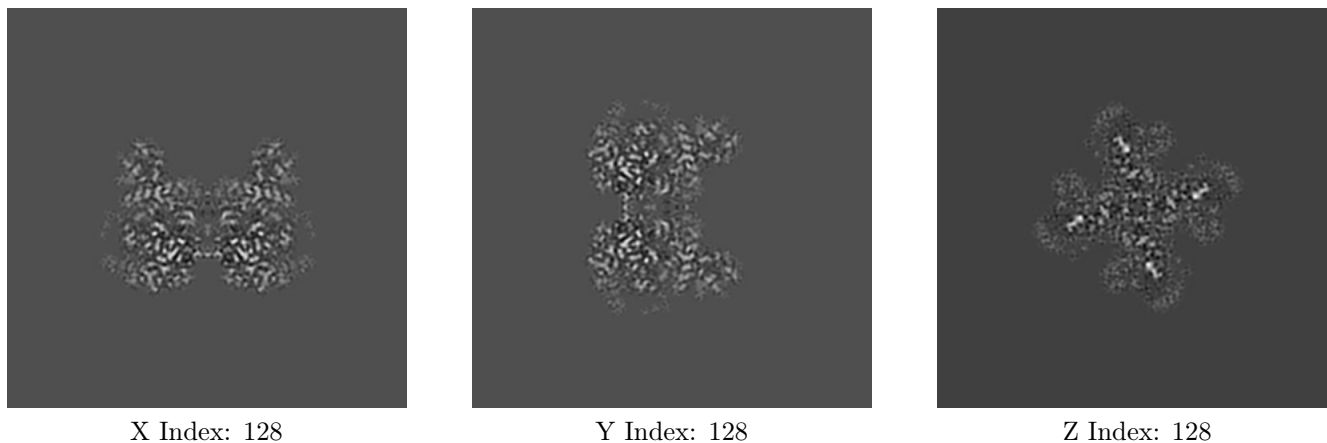

The images above show central slices of the map in three orthogonal directions.

6.3 Largest variance slices [i](#)

6.3.1 Primary map

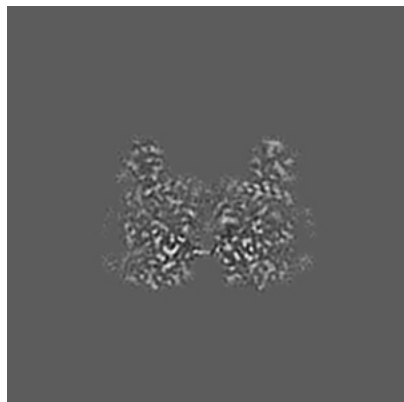

X Index: 127

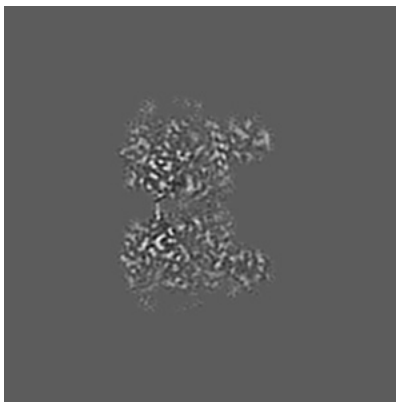

Y Index: 129

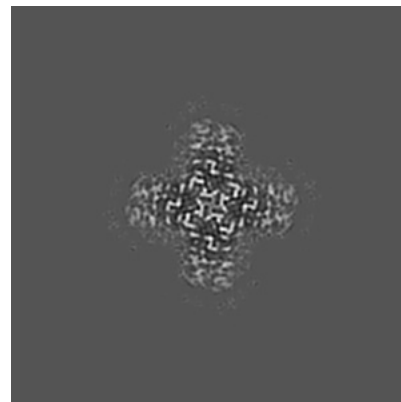

Z Index: 99

The images above show the largest variance slices of the map in three orthogonal directions.

6.4 Orthogonal surface views [i](#)

6.4.1 Primary map

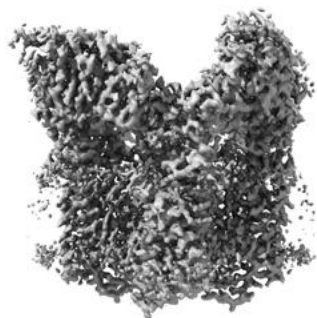

X

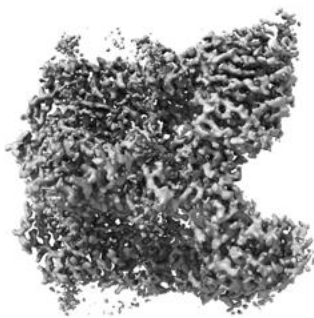

Y

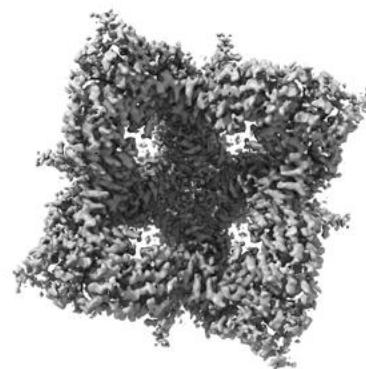

Z

The images above show the 3D surface view of the map at the recommended contour level 0.022. These images, in conjunction with the slice images, may facilitate assessment of whether an appropriate contour level has been provided.

6.5 Mask visualisation

This section was not generated. No masks/segmentation were deposited.

7 Map analysis [i](#)

This section contains the results of statistical analysis of the map.

7.1 Map-value distribution [i](#)

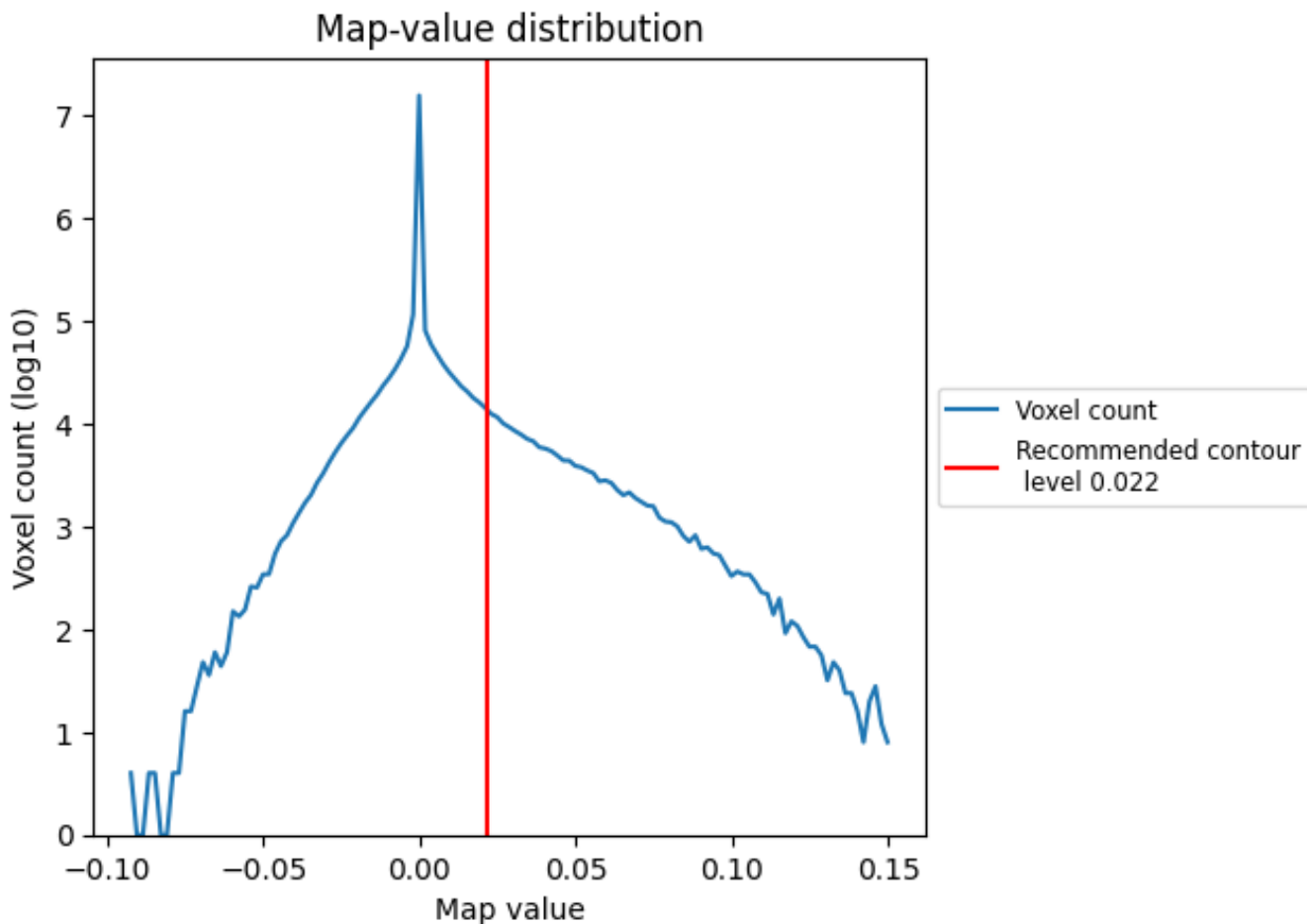

The map-value distribution is plotted in 128 intervals along the x-axis. The y-axis is logarithmic. A spike in this graph at zero usually indicates that the volume has been masked.

7.2 Volume estimate [i](#)

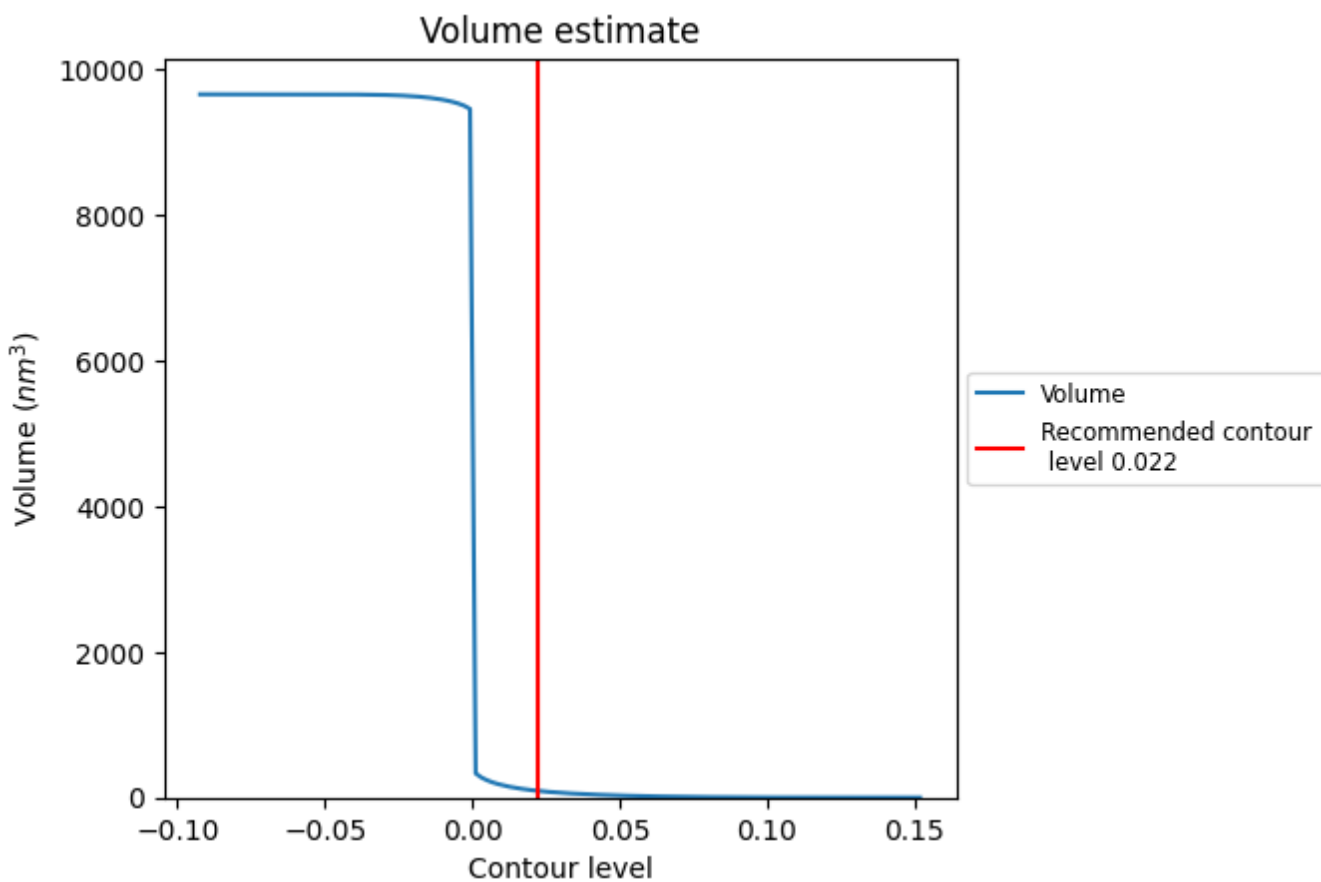

The volume at the recommended contour level is 93 nm³; this corresponds to an approximate mass of 84 kDa.

The volume estimate graph shows how the enclosed volume varies with the contour level. The recommended contour level is shown as a vertical line and the intersection between the line and the curve gives the volume of the enclosed surface at the given level.

7.3 Rotationally averaged power spectrum [i](#)

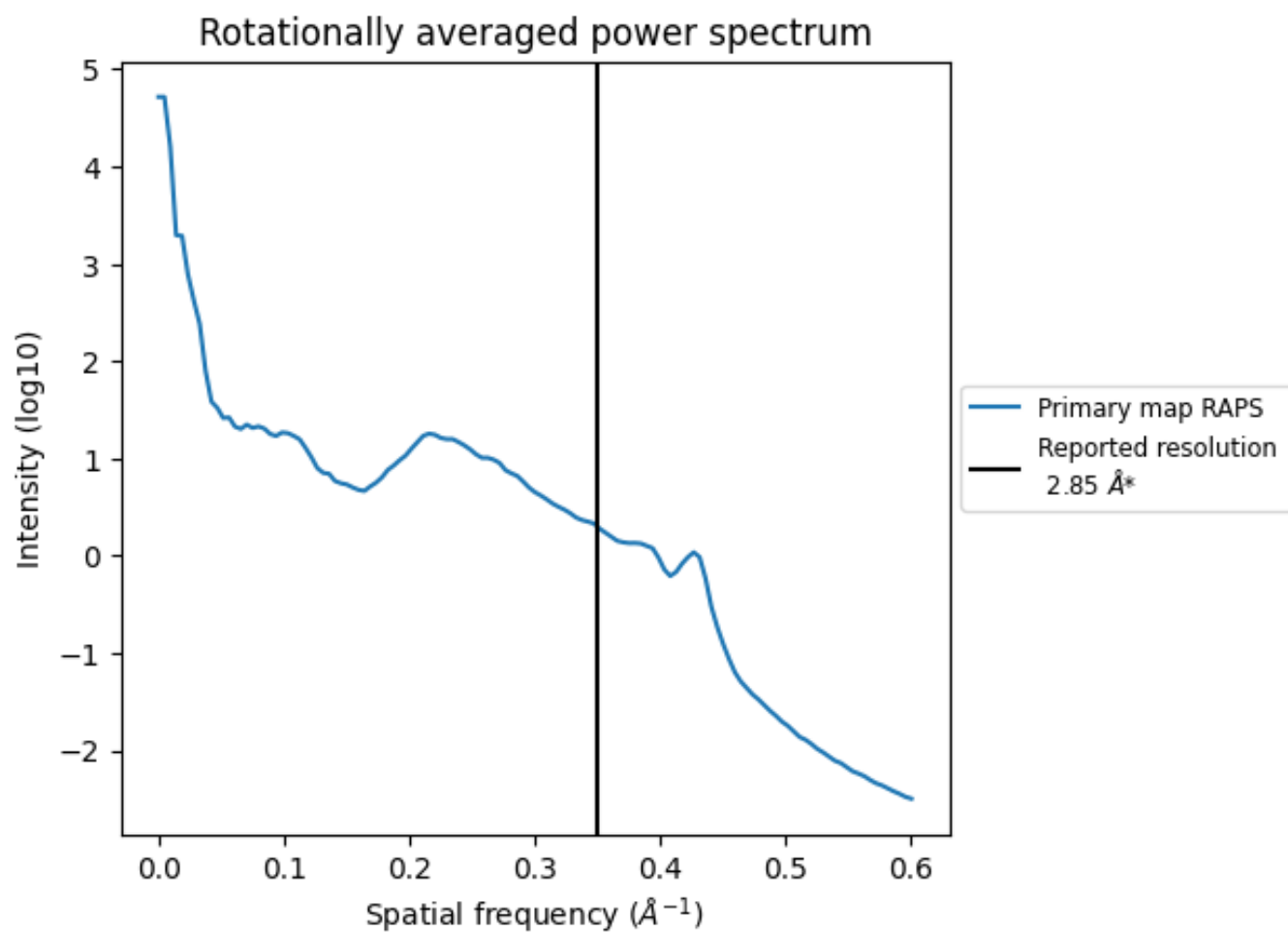

*Reported resolution corresponds to spatial frequency of 0.351 Å⁻¹

8 Fourier-Shell correlation

This section was not generated. No FSC curve or half-maps provided.

9 Map-model fit [i](#)

This section contains information regarding the fit between EMDB map EMD-24893 and PDB model 7S8C. Per-residue inclusion information can be found in section 3 on page 9.

9.1 Map-model overlay [i](#)

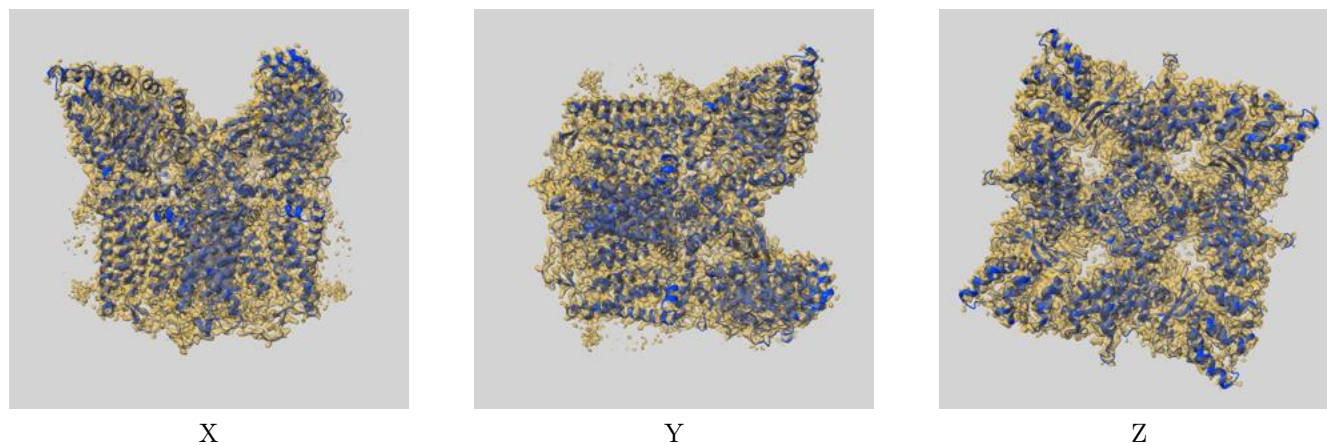

The images above show the 3D surface view of the map at the recommended contour level 0.022 at 50% transparency in yellow overlaid with a ribbon representation of the model coloured in blue. These images allow for the visual assessment of the quality of fit between the atomic model and the map.

9.2 Q-score mapped to coordinate model [\(i\)](#)

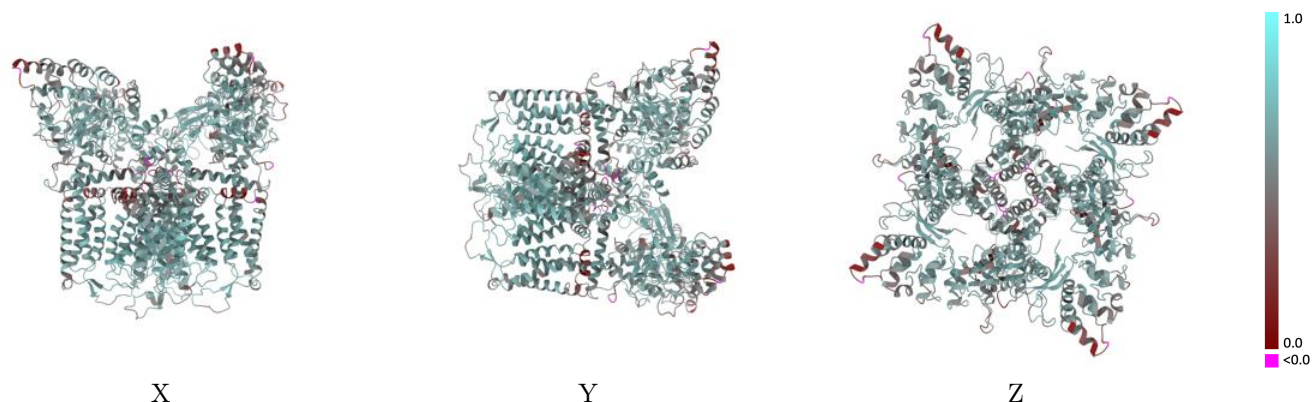

The images above show the model with each residue coloured according to its Q-score. This shows their resolvability in the map with higher Q-score values reflecting better resolvability. Please note: Q-score is calculating the resolvability of atoms, and thus high values are only expected at resolutions at which atoms can be resolved. Low Q-score values may therefore be expected for many entries.

9.3 Atom inclusion mapped to coordinate model [\(i\)](#)

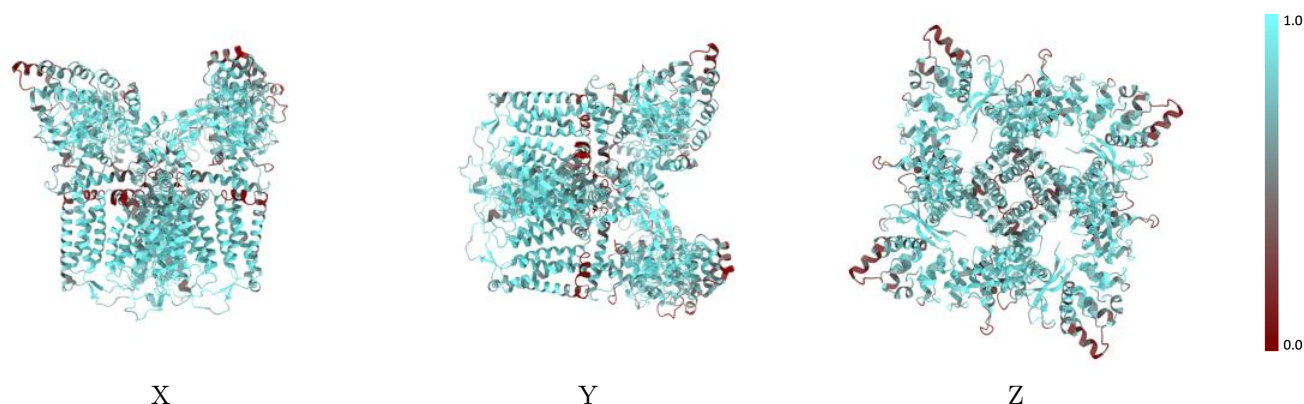

The images above show the model with each residue coloured according to its atom inclusion. This shows to what extent they are inside the map at the recommended contour level (0.022).



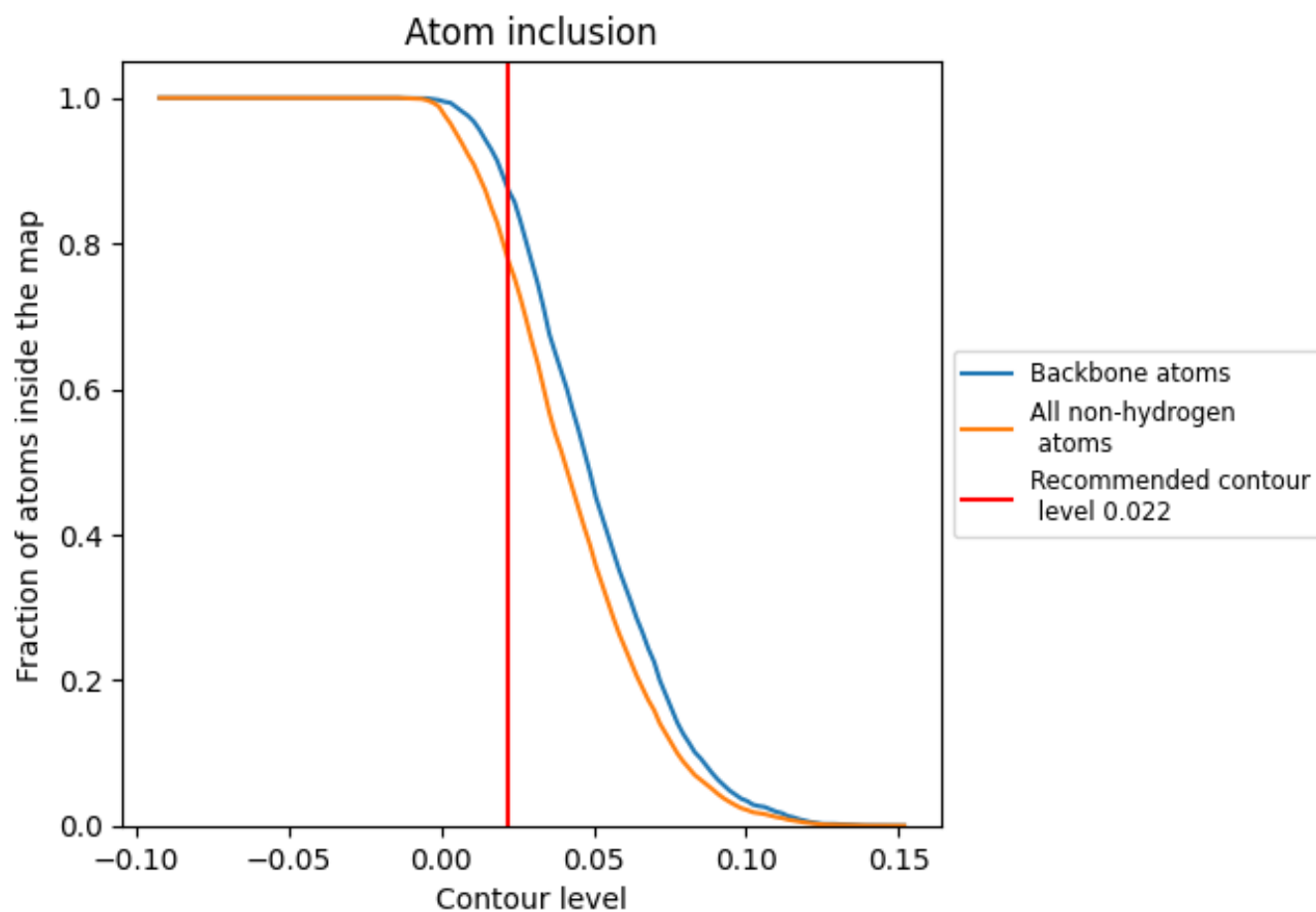







9.4 Atom inclusion [i](#)



At the recommended contour level, 87% of all backbone atoms, 78% of all non-hydrogen atoms, are inside the map.

9.5 Map-model fit summary

The table lists the average atom inclusion at the recommended contour level (0.022) and Q-score for the entire model and for each chain.

Chain	Atom inclusion	Q-score
All	 0.7766	 0.5630
A	 0.7759	 0.5640
B	 0.7778	 0.5640
C	 0.7768	 0.5630
D	 0.7758	 0.5620

