



# Full wwPDB X-ray Structure Validation Report ⓘ

Mar 8, 2018 – 07:16 pm GMT

PDB ID : 3SE8  
Title : Crystal structure of broadly and potently neutralizing antibody VRC03 in complex with HIV-1 gp120  
Authors : Kwong, P.D.; Zhou, T.  
Deposited on : 2011-06-10  
Resolution : 1.90 Å(reported)

This is a Full wwPDB X-ray Structure Validation Report for a publicly released PDB entry.

We welcome your comments at [validation@mail.wwpdb.org](mailto:validation@mail.wwpdb.org)

A user guide is available at

<https://www.wwpdb.org/validation/2017/XrayValidationReportHelp>

with specific help available everywhere you see the ⓘ symbol.

---

The following versions of software and data (see [references ⓘ](#)) were used in the production of this report:

MolProbity : 4.02b-467  
Mogul : 1.7.3 (157068), CSD as539be (2018)  
Xtriage (Phenix) : 1.13  
EDS : trunk30967  
Percentile statistics : 20171227.v01 (using entries in the PDB archive December 27th 2017)  
Refmac : 5.8.0158  
CCP4 : 7.0 (Gargrove)  
Ideal geometry (proteins) : Engh & Huber (2001)  
Ideal geometry (DNA, RNA) : Parkinson et al. (1996)  
Validation Pipeline (wwPDB-VP) : trunk30967

# 1 Overall quality at a glance

The following experimental techniques were used to determine the structure:

*X-RAY DIFFRACTION*

The reported resolution of this entry is 1.90 Å.

Percentile scores (ranging between 0-100) for global validation metrics of the entry are shown in the following graphic. The table shows the number of entries on which the scores are based.

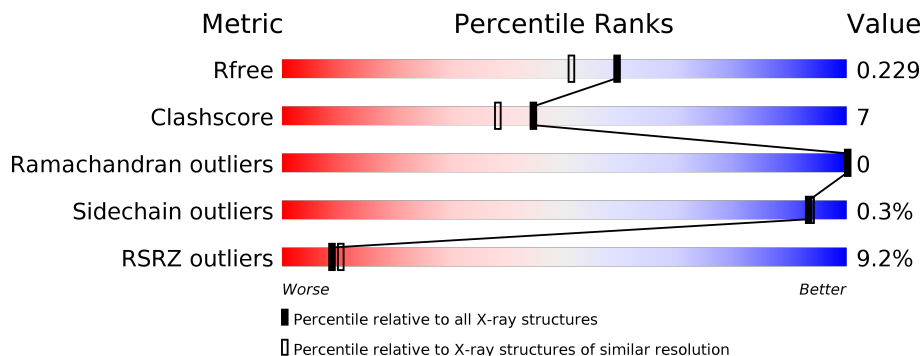

Metric	Whole archive (#Entries)	Similar resolution (#Entries, resolution range(Å))
$R_{free}$	111664	5502 (1.90-1.90)
Clashscore	122126	6115 (1.90-1.90)
Ramachandran outliers	120053	6048 (1.90-1.90)
Sidechain outliers	120020	6048 (1.90-1.90)
RSRZ outliers	108989	5379 (1.90-1.90)

The table below summarises the geometric issues observed across the polymeric chains and their fit to the electron density. The red, orange, yellow and green segments on the lower bar indicate the fraction of residues that contain outliers for  $\geq 3$ , 2, 1 and 0 types of geometric quality criteria. A grey segment represents the fraction of residues that are not modelled. The numeric value for each fraction is indicated below the corresponding segment, with a dot representing fractions  $\leq 5\%$ . The upper red bar (where present) indicates the fraction of residues that have poor fit to the electron density. The numeric value is given above the bar.

Mol	Chain	Length	Quality of chain
1	G	353	
2	H	233	
3	L	209	

The following table lists non-polymeric compounds, carbohydrate monomers and non-standard residues in protein, DNA, RNA chains that are outliers for geometric or electron-density-fit criteria:

Mol	Type	Chain	Res	Chirality	Geometry	Clashes	Electron density
4	NAG	G	588	-	-	-	X
4	NAG	G	741	-	-	-	X
5	SO4	H	1001	-	-	X	-
5	SO4	H	1004	-	-	-	X

## 2 Entry composition [i](#)

There are 8 unique types of molecules in this entry. The entry contains 12961 atoms, of which 6050 are hydrogens and 0 are deuteriums.

In the tables below, the ZeroOcc column contains the number of atoms modelled with zero occupancy, the AltConf column contains the number of residues with at least one atom in alternate conformation and the Trace column contains the number of residues modelled with at most 2 atoms.

- Molecule 1 is a protein called HIV-1 Clade AE strain 93TH057 gp120.

Mol	Chain	Residues	Atoms					ZeroOcc	AltConf	Trace	
			Total	C	H	N	O				S
1	G	344	5310	1689	2617	469	512	23	0	0	0

- Molecule 2 is a protein called Heavy chain of antibody VRC03.

Mol	Chain	Residues	Atoms					ZeroOcc	AltConf	Trace	
			Total	C	H	N	O				S
2	H	227	3423	1109	1686	292	328	8	0	0	0

- Molecule 3 is a protein called Light chain of antibody VRC03.

Mol	Chain	Residues	Atoms					ZeroOcc	AltConf	Trace	
			Total	C	H	N	O				S
3	L	208	3208	1026	1580	276	321	5	0	1	0

- Molecule 4 is N-ACETYL-D-GLUCOSAMINE (three-letter code: NAG) (formula: C<sub>8</sub>H<sub>15</sub>NO<sub>6</sub>).

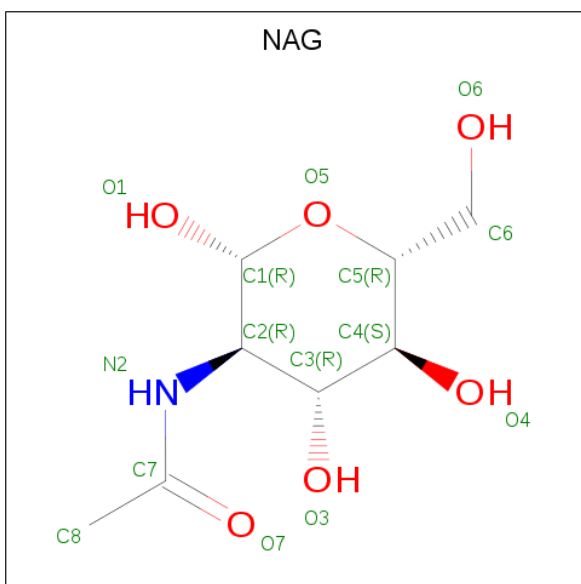

Mol	Chain	Residues	Atoms					ZeroOcc	AltConf
4	G	1	Total	C	H	N	O	0	0
			27	8	13	1	5		
4	G	1	Total	C	H	N	O	0	0
			27	8	13	1	5		
4	G	1	Total	C	H	N	O	0	0
			27	8	13	1	5		
4	G	1	Total	C	H	N	O	0	0
			27	8	13	1	5		
4	G	1	Total	C	H	N	O	0	0
			27	8	13	1	5		
4	G	1	Total	C	H	N	O	0	0
			27	8	13	1	5		
4	G	1	Total	C	H	N	O	0	0
			27	8	13	1	5		
4	G	1	Total	C	H	N	O	0	0
			27	8	13	1	5		
4	G	1	Total	C	H	N	O	0	0
			27	8	13	1	5		

- Molecule 5 is SULFATE ION (three-letter code: SO4) (formula: O<sub>4</sub>S).

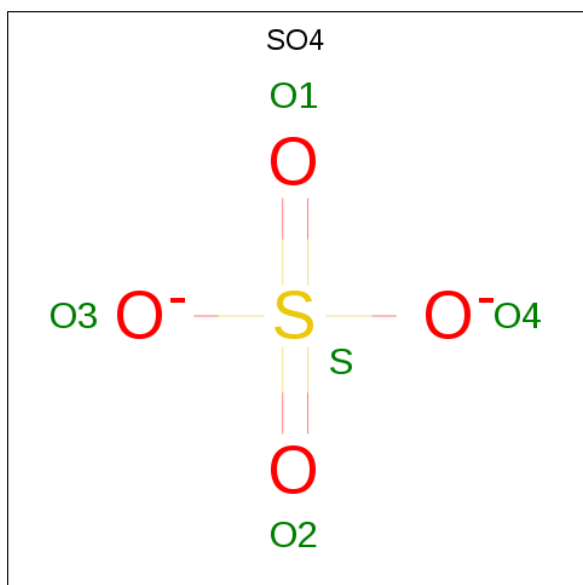

Mol	Chain	Residues	Atoms		ZeroOcc	AltConf
5	G	1	Total	O S	0	0
			5	4 1		

*Continued on next page...*

Continued from previous page...

Mol	Chain	Residues	Atoms			ZeroOcc	AltConf
			Total	O	S		
5	G	1	5	4	1	0	0
5	H	1	5	4	1	0	0
5	H	1	5	4	1	0	0
5	H	1	5	4	1	0	0
5	L	1	5	4	1	0	0
5	L	1	5	4	1	0	0
5	L	1	5	4	1	0	0

- Molecule 6 is 1,2-ETHANEDIOL (three-letter code: EDO) (formula:  $C_2H_6O_2$ ).

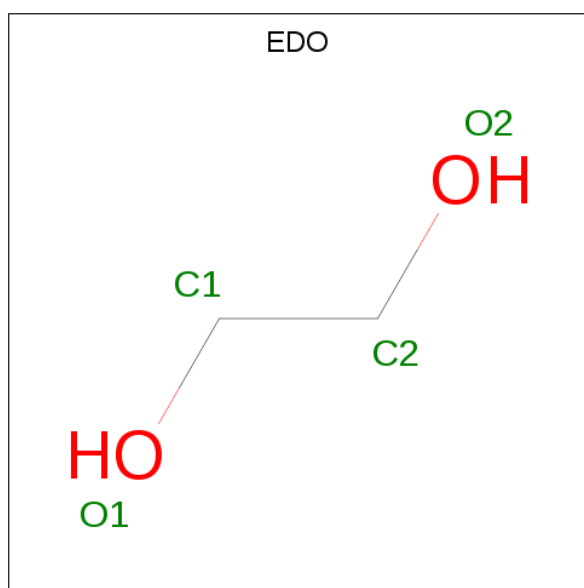

Mol	Chain	Residues	Atoms				ZeroOcc	AltConf
			Total	C	H	O		
6	H	1	10	2	6	2	0	0
6	H	1	10	2	6	2	0	0

- Molecule 7 is 2-AMINO-2-HYDROXYMETHYL-PROPANE-1,3-DIOL (three-letter code: TRS) (formula:  $C_4H_{12}NO_3$ ).

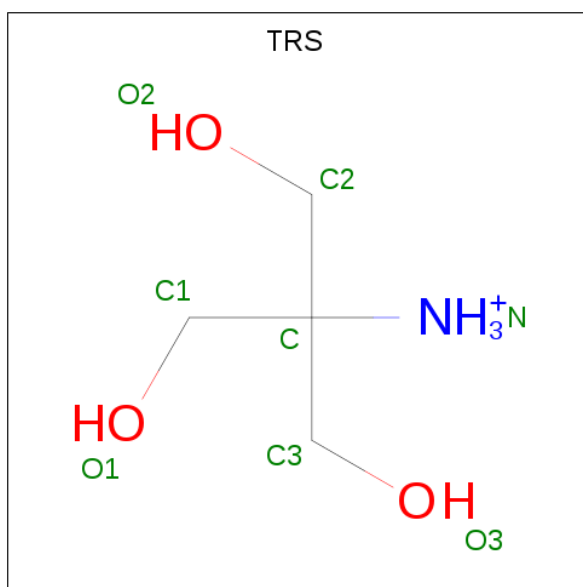

Mol	Chain	Residues	Atoms					ZeroOcc	AltConf
			Total	C	H	N	O		
7	H	1	20	4	12	1	3	0	0

- Molecule 8 is water.

Mol	Chain	Residues	Atoms		ZeroOcc	AltConf
8	G	218	Total	O	0	0
			218	218		
8	H	211	Total	O	0	0
			211	211		
8	L	214	Total	O	0	0
			214	214		

### 3 Residue-property plots

These plots are drawn for all protein, RNA and DNA chains in the entry. The first graphic for a chain summarises the proportions of the various outlier classes displayed in the second graphic. The second graphic shows the sequence view annotated by issues in geometry and electron density. Residues are color-coded according to the number of geometric quality criteria for which they contain at least one outlier: green = 0, yellow = 1, orange = 2 and red = 3 or more. A red dot above a residue indicates a poor fit to the electron density ( $RSRZ > 2$ ). Stretches of 2 or more consecutive residues without any outlier are shown as a green connector. Residues present in the sample, but not in the model, are shown in grey.

- Molecule 1: HIV-1 Clade AE strain 93TH057 gp120

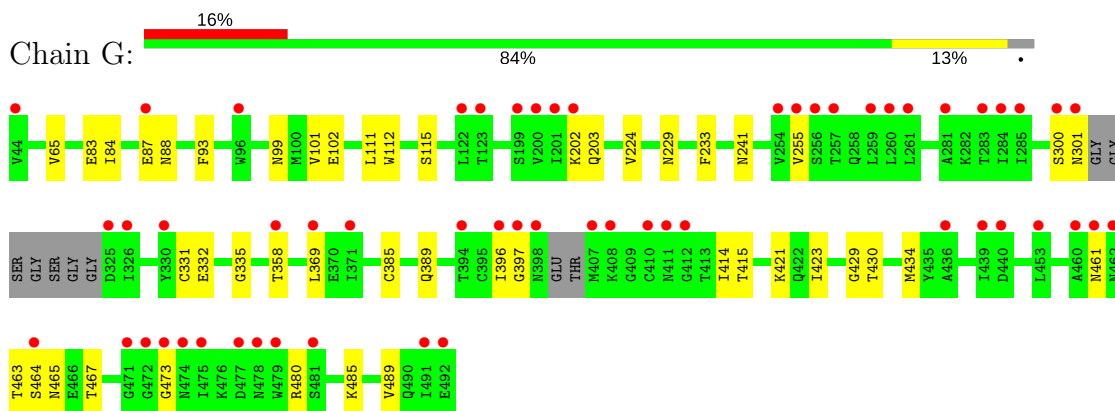

- Molecule 2: Heavy chain of antibody VRC03

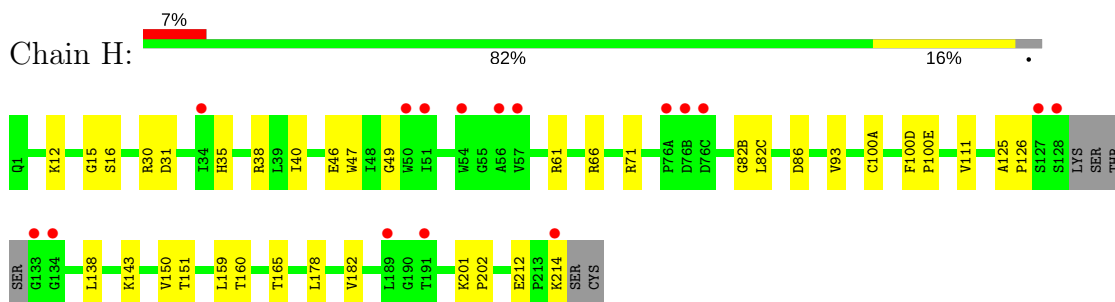

- Molecule 3: Light chain of antibody VRC03

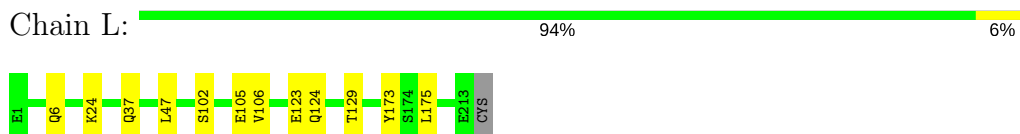



## 4 Data and refinement statistics

Property	Value	Source
Space group	P 21 21 21	Depositor
Cell constants a, b, c, $\alpha$ , $\beta$ , $\gamma$	62.01Å 70.26Å 217.88Å 90.00° 90.00° 90.00°	Depositor
Resolution (Å)	37.03 – 1.90 37.03 – 1.89	Depositor EDS
% Data completeness (in resolution range)	90.2 (37.03-1.90) 90.2 (37.03-1.89)	Depositor EDS
$R_{merge}$	(Not available)	Depositor
$R_{sym}$	(Not available)	Depositor
$\langle I/\sigma(I) \rangle$ <sup>1</sup>	1.22 (at 1.89Å)	Xtriage
Refinement program	PHENIX (phenix.refine: dev_755)	Depositor
R, $R_{free}$	0.187 , 0.233 0.183 , 0.229	Depositor DCC
$R_{free}$ test set	3470 reflections (5.02%)	wwPDB-VP
Wilson B-factor (Å <sup>2</sup> )	37.1	Xtriage
Anisotropy	0.303	Xtriage
Bulk solvent $k_{sol}$ (e/Å <sup>3</sup> ), $B_{sol}$ (Å <sup>2</sup> )	0.39 , 51.1	EDS
L-test for twinning <sup>2</sup>	$\langle  L  \rangle = 0.46$ , $\langle L^2 \rangle = 0.29$	Xtriage
Estimated twinning fraction	No twinning to report.	Xtriage
$F_o, F_c$ correlation	0.97	EDS
Total number of atoms	12961	wwPDB-VP
Average B, all atoms (Å <sup>2</sup> )	55.0	wwPDB-VP

Xtriage's analysis on translational NCS is as follows: *The largest off-origin peak in the Patterson function is 3.87% of the height of the origin peak. No significant pseudotranslation is detected.*

<sup>1</sup>Intensities estimated from amplitudes.

<sup>2</sup>Theoretical values of  $\langle |L| \rangle$ ,  $\langle L^2 \rangle$  for acentric reflections are 0.5, 0.333 respectively for untwinned datasets, and 0.375, 0.2 for perfectly twinned datasets.

## 5 Model quality [i](#)

### 5.1 Standard geometry [i](#)

Bond lengths and bond angles in the following residue types are not validated in this section: SO4, TRS, EDO, NAG

The Z score for a bond length (or angle) is the number of standard deviations the observed value is removed from the expected value. A bond length (or angle) with  $|Z| > 5$  is considered an outlier worth inspection. RMSZ is the root-mean-square of all Z scores of the bond lengths (or angles).

Mol	Chain	Bond lengths		Bond angles	
		RMSZ	# Z  >5	RMSZ	# Z  >5
1	G	0.28	0/2749	0.47	0/3730
2	H	0.32	0/1788	0.52	0/2441
3	L	0.34	0/1669	0.51	0/2260
All	All	0.31	0/6206	0.49	0/8431

There are no bond length outliers.

There are no bond angle outliers.

There are no chirality outliers.

There are no planarity outliers.

### 5.2 Too-close contacts [i](#)

In the following table, the Non-H and H(model) columns list the number of non-hydrogen atoms and hydrogen atoms in the chain respectively. The H(added) column lists the number of hydrogen atoms added and optimized by MolProbity. The Clashes column lists the number of clashes within the asymmetric unit, whereas Symm-Clashes lists symmetry related clashes.

Mol	Chain	Non-H	H(model)	H(added)	Clashes	Symm-Clashes
1	G	2693	2617	2624	40	0
2	H	1737	1686	1682	32	0
3	L	1628	1580	1577	14	0
4	G	154	143	142	4	0
5	G	10	0	0	0	0
5	H	15	0	0	2	0
5	L	15	0	0	1	0
6	H	8	12	12	1	0
7	H	8	12	12	2	0
8	G	218	0	0	8	0

*Continued on next page...*

*Continued from previous page...*

Mol	Chain	Non-H	H(model)	H(added)	Clashes	Symm-Clashes
8	H	211	0	0	9	0
8	L	214	0	0	8	0
All	All	6911	6050	6049	87	0

The all-atom clashscore is defined as the number of clashes found per 1000 atoms (including hydrogen atoms). The all-atom clashscore for this structure is 7.

All (87) close contacts within the same asymmetric unit are listed below, sorted by their clash magnitude.

Atom-1	Atom-2	Interatomic distance (Å)	Clash overlap (Å)
3:L:6:GLN:NE2	8:L:615:HOH:O	1.98	0.96
1:G:389:GLN:HG2	4:G:892:NAG:H81	1.48	0.95
2:H:82(C):LEU:N	8:H:611:HOH:O	2.06	0.89
4:G:834:NAG:O7	8:G:519:HOH:O	1.99	0.78
3:L:123:GLU:OE1	8:L:600:HOH:O	2.04	0.75
2:H:100(E):PRO:HD3	5:H:1001:SO4:O3	1.89	0.72
2:H:31:ASP:OD2	8:H:436:HOH:O	2.08	0.72
3:L:102:SER:N	8:L:615:HOH:O	2.24	0.70
2:H:66:ARG:NH2	8:H:609:HOH:O	2.24	0.69
4:G:948:NAG:H83	8:G:572:HOH:O	1.93	0.69
2:H:100(D):PHE:N	5:H:1001:SO4:O3	2.21	0.68
2:H:15:GLY:N	8:H:611:HOH:O	2.27	0.68
2:H:126:PRO:HG3	2:H:138:LEU:HB3	1.75	0.67
2:H:143:LYS:HE2	8:L:307:HOH:O	1.98	0.63
2:H:82(B):GLY:O	8:H:609:HOH:O	2.15	0.63
1:G:358:THR:HB	1:G:465:ASN:HB3	1.80	0.63
3:L:123:GLU:N	5:L:1006:SO4:O3	2.32	0.62
3:L:102:SER:OG	8:L:615:HOH:O	2.15	0.61
1:G:369:LEU:HD12	1:G:421:LYS:HE3	1.82	0.60
3:L:102:SER:CB	8:L:615:HOH:O	2.50	0.60
2:H:86:ASP:OD2	8:H:609:HOH:O	2.17	0.59
1:G:429:GLY:O	8:G:598:HOH:O	2.17	0.59
2:H:38:ARG:HD3	2:H:46:GLU:OE1	2.03	0.58
2:H:159:LEU:HD23	2:H:159:LEU:C	2.25	0.56
3:L:105:GLU:HG2	3:L:106:VAL:N	2.19	0.56
3:L:105:GLU:HG3	3:L:173:TYR:OH	2.06	0.55
1:G:461:ASN:HD22	2:H:61:ARG:HD2	1.72	0.55
3:L:37:GLN:HB2	3:L:47:LEU:HD11	1.89	0.54
1:G:473:GLY:N	8:G:565:HOH:O	2.42	0.53
1:G:415:THR:HG23	8:G:181:HOH:O	2.07	0.53
3:L:6:GLN:HB3	8:L:615:HOH:O	2.09	0.53

*Continued on next page...*

*Continued from previous page...*

Atom-1	Atom-2	Interatomic distance (Å)	Clash overlap (Å)
1:G:93:PHE:HB2	1:G:233:PHE:HZ	1.74	0.53
2:H:35:HIS:HB2	2:H:93:VAL:HG23	1.91	0.53
1:G:65:VAL:HG11	1:G:115:SER:HB3	1.90	0.53
1:G:332:GLU:HG2	1:G:415:THR:HG22	1.90	0.53
1:G:485:LYS:HG2	8:G:552:HOH:O	2.09	0.53
4:G:789:NAG:H83	8:G:592:HOH:O	2.08	0.52
1:G:229:ASN:HB2	1:G:241:ASN:ND2	2.26	0.51
1:G:423:ILE:HG12	1:G:434:MET:HG2	1.92	0.51
1:G:335:GLY:CA	1:G:414:ILE:CD1	2.88	0.51
2:H:151:THR:HA	7:H:1009:TRS:H32	1.92	0.51
1:G:84:ILE:N	1:G:84:ILE:HD12	2.25	0.51
1:G:202:LYS:C	1:G:203:GLN:HG3	2.32	0.51
1:G:430:THR:HG22	1:G:430:THR:O	2.10	0.50
2:H:30:ARG:NH1	8:H:555:HOH:O	2.45	0.50
1:G:335:GLY:HA2	1:G:414:ILE:HD13	1.93	0.50
1:G:467:THR:OG1	2:H:61:ARG:NH1	2.44	0.50
1:G:335:GLY:HA2	1:G:414:ILE:CD1	2.42	0.49
2:H:47:TRP:CZ2	2:H:49:GLY:HA2	2.48	0.49
1:G:65:VAL:HG11	1:G:115:SER:CB	2.43	0.49
1:G:65:VAL:CG1	1:G:115:SER:HB3	2.44	0.48
2:H:16:SER:N	8:H:611:HOH:O	2.46	0.47
2:H:159:LEU:CD2	2:H:159:LEU:C	2.82	0.47
1:G:300:SER:O	1:G:301:ASN:HB2	2.14	0.47
1:G:255:VAL:HG23	1:G:255:VAL:O	2.14	0.46
3:L:175:LEU:C	3:L:175:LEU:HD23	2.35	0.46
1:G:101:VAL:HG21	1:G:480:ARG:HG2	1.98	0.46
1:G:93:PHE:HB2	1:G:233:PHE:CZ	2.50	0.46
2:H:126:PRO:HA	6:H:1008:EDO:H12	1.97	0.45
1:G:414:ILE:N	1:G:414:ILE:HD12	2.31	0.45
2:H:159:LEU:HD23	2:H:160:THR:N	2.31	0.45
3:L:24:LYS:NZ	8:L:483:HOH:O	2.41	0.45
1:G:331:CYS:SG	1:G:385:CYS:SG	3.15	0.44
1:G:463:THR:OG1	1:G:464:SER:N	2.50	0.44
2:H:201:LYS:N	2:H:202:PRO:CD	2.81	0.44
2:H:125:ALA:HB3	2:H:214:LYS:HD2	1.99	0.44
1:G:461:ASN:C	1:G:461:ASN:OD1	2.56	0.44
3:L:105:GLU:HG2	3:L:106:VAL:H	1.82	0.43
2:H:165:THR:HB	7:H:1009:TRS:H12	2.00	0.43
2:H:100(D):PHE:N	2:H:100(E):PRO:CD	2.82	0.43
1:G:111:LEU:C	1:G:111:LEU:HD23	2.40	0.42
1:G:99:ASN:HA	1:G:102:GLU:HG2	2.00	0.42

*Continued on next page...*

Continued from previous page...

Atom-1	Atom-2	Interatomic distance (Å)	Clash overlap (Å)
2:H:100(A):CYS:HB3	8:H:284:HOH:O	2.19	0.42
1:G:65:VAL:CG1	1:G:115:SER:CB	2.97	0.42
2:H:38:ARG:HG3	2:H:40:ILE:HG13	2.01	0.42
1:G:473:GLY:N	8:G:532:HOH:O	2.50	0.42
2:H:178:LEU:HD12	2:H:178:LEU:C	2.40	0.42
2:H:159:LEU:HD21	2:H:182:VAL:HG21	2.02	0.41
2:H:150:VAL:HG23	2:H:178:LEU:HD21	2.02	0.41
1:G:255:VAL:CG2	1:G:255:VAL:O	2.68	0.41
1:G:87:GLU:O	1:G:88:ASN:HB2	2.20	0.41
1:G:396:ILE:HD12	1:G:397:GLY:N	2.36	0.41
1:G:112:TRP:CZ2	1:G:255:VAL:HG21	2.56	0.40
1:G:83:GLU:C	1:G:84:ILE:HD12	2.41	0.40
2:H:12:LYS:O	2:H:111:VAL:HA	2.21	0.40
3:L:124:GLN:HG2	3:L:129:THR:O	2.21	0.40
1:G:224:VAL:HG12	1:G:489:VAL:HG23	2.04	0.40

There are no symmetry-related clashes.

## 5.3 Torsion angles [i](#)

### 5.3.1 Protein backbone [i](#)

In the following table, the Percentiles column shows the percent Ramachandran outliers of the chain as a percentile score with respect to all X-ray entries followed by that with respect to entries of similar resolution.

The Analysed column shows the number of residues for which the backbone conformation was analysed, and the total number of residues.

Mol	Chain	Analysed	Favoured	Allowed	Outliers	Percentiles	
1	G	338/353 (96%)	323 (96%)	15 (4%)	0	100	100
2	H	223/233 (96%)	219 (98%)	4 (2%)	0	100	100
3	L	207/209 (99%)	202 (98%)	5 (2%)	0	100	100
All	All	768/795 (97%)	744 (97%)	24 (3%)	0	100	100

There are no Ramachandran outliers to report.

### 5.3.2 Protein sidechains [i](#)

In the following table, the Percentiles column shows the percent sidechain outliers of the chain as a percentile score with respect to all X-ray entries followed by that with respect to entries of similar resolution.

The Analysed column shows the number of residues for which the sidechain conformation was analysed, and the total number of residues.

Mol	Chain	Analysed	Rotameric	Outliers	Percentiles	
1	G	307/311 (99%)	307 (100%)	0	100	100
2	H	193/200 (96%)	191 (99%)	2 (1%)	78	78
3	L	182/182 (100%)	182 (100%)	0	100	100
All	All	682/693 (98%)	680 (100%)	2 (0%)	93	94

All (2) residues with a non-rotameric sidechain are listed below:

Mol	Chain	Res	Type
2	H	71	ARG
2	H	212	GLU

Some sidechains can be flipped to improve hydrogen bonding and reduce clashes. All (1) such sidechains are listed below:

Mol	Chain	Res	Type
3	L	90	GLN

### 5.3.3 RNA [i](#)

There are no RNA molecules in this entry.

## 5.4 Non-standard residues in protein, DNA, RNA chains [i](#)

There are no non-standard protein/DNA/RNA residues in this entry.

## 5.5 Carbohydrates [i](#)

There are no carbohydrates in this entry.

## 5.6 Ligand geometry

22 ligands are modelled in this entry.

In the following table, the Counts columns list the number of bonds (or angles) for which Mogul statistics could be retrieved, the number of bonds (or angles) that are observed in the model and the number of bonds (or angles) that are defined in the Chemical Component Dictionary. The Link column lists molecule types, if any, to which the group is linked. The Z score for a bond length (or angle) is the number of standard deviations the observed value is removed from the expected value. A bond length (or angle) with  $|Z| > 2$  is considered an outlier worth inspection. RMSZ is the root-mean-square of all Z scores of the bond lengths (or angles).

Mol	Type	Chain	Res	Link	Bond lengths			Bond angles		
					Counts	RMSZ	# Z  > 2	Counts	RMSZ	# Z  > 2
5	SO4	G	1000	-	4,4,4	0.17	0	6,6,6	0.07	0
5	SO4	G	1002	-	4,4,4	0.16	0	6,6,6	0.08	0
4	NAG	G	588	1	14,14,15	0.50	0	17,19,21	0.73	0
4	NAG	G	734	1	14,14,15	0.56	0	17,19,21	0.72	0
4	NAG	G	741	1	14,14,15	0.53	0	17,19,21	0.59	0
4	NAG	G	762	1	14,14,15	0.44	0	17,19,21	1.50	3 (17%)
4	NAG	G	776	1	14,14,15	0.78	0	17,19,21	0.94	1 (5%)
4	NAG	G	789	1	14,14,15	0.51	0	17,19,21	1.02	0
4	NAG	G	795	1	14,14,15	0.50	0	17,19,21	0.93	0
4	NAG	G	834	1	14,14,15	0.55	0	17,19,21	1.02	1 (5%)
4	NAG	G	886	1	14,14,15	0.52	0	17,19,21	0.67	0
4	NAG	G	892	1	14,14,15	0.49	0	17,19,21	0.83	0
4	NAG	G	948	1	14,14,15	0.49	0	17,19,21	1.09	1 (5%)
5	SO4	H	1001	-	4,4,4	0.23	0	6,6,6	0.10	0
5	SO4	H	1004	-	4,4,4	0.15	0	6,6,6	0.08	0
5	SO4	H	1005	-	4,4,4	0.18	0	6,6,6	0.07	0
6	EDO	H	1008	-	3,3,3	0.51	0	2,2,2	0.29	0
7	TRS	H	1009	-	7,7,7	0.76	0	9,9,9	0.34	0
6	EDO	H	1010	-	3,3,3	0.46	0	2,2,2	0.35	0
5	SO4	L	1003	-	4,4,4	0.16	0	6,6,6	0.12	0
5	SO4	L	1006	-	4,4,4	0.17	0	6,6,6	0.11	0
5	SO4	L	1007	-	4,4,4	0.24	0	6,6,6	0.12	0

In the following table, the Chirals column lists the number of chiral outliers, the number of chiral centers analysed, the number of these observed in the model and the number defined in the Chemical Component Dictionary. Similar counts are reported in the Torsion and Rings columns. '-' means no outliers of that kind were identified.

Mol	Type	Chain	Res	Link	Chirals	Torsions	Rings
5	SO4	G	1000	-	-	0/0/0/0	0/0/0/0
5	SO4	G	1002	-	-	0/0/0/0	0/0/0/0

*Continued on next page...*

*Continued from previous page...*

Mol	Type	Chain	Res	Link	Chirals	Torsions	Rings
4	NAG	G	588	1	-	0/6/23/26	0/1/1/1
4	NAG	G	734	1	-	0/6/23/26	0/1/1/1
4	NAG	G	741	1	-	0/6/23/26	0/1/1/1
4	NAG	G	762	1	-	0/6/23/26	0/1/1/1
4	NAG	G	776	1	-	0/6/23/26	0/1/1/1
4	NAG	G	789	1	-	0/6/23/26	0/1/1/1
4	NAG	G	795	1	-	0/6/23/26	0/1/1/1
4	NAG	G	834	1	-	0/6/23/26	0/1/1/1
4	NAG	G	886	1	-	0/6/23/26	0/1/1/1
4	NAG	G	892	1	-	0/6/23/26	0/1/1/1
4	NAG	G	948	1	-	0/6/23/26	0/1/1/1
5	SO4	H	1001	-	-	0/0/0/0	0/0/0/0
5	SO4	H	1004	-	-	0/0/0/0	0/0/0/0
5	SO4	H	1005	-	-	0/0/0/0	0/0/0/0
6	EDO	H	1008	-	-	0/1/1/1	0/0/0/0
7	TRS	H	1009	-	-	0/9/9/9	0/0/0/0
6	EDO	H	1010	-	-	0/1/1/1	0/0/0/0
5	SO4	L	1003	-	-	0/0/0/0	0/0/0/0
5	SO4	L	1006	-	-	0/0/0/0	0/0/0/0
5	SO4	L	1007	-	-	0/0/0/0	0/0/0/0

There are no bond length outliers.

All (6) bond angle outliers are listed below:

Mol	Chain	Res	Type	Atoms	Z	Observed( $^{\circ}$ )	Ideal( $^{\circ}$ )
4	G	762	NAG	C6-C5-C4	-2.39	107.34	112.99
4	G	762	NAG	O5-C1-C2	-2.28	108.37	111.52
4	G	776	NAG	O5-C1-C2	-2.14	108.57	111.52
4	G	834	NAG	C4-C3-C2	2.09	114.08	111.02
4	G	948	NAG	C8-C7-N2	2.50	120.48	116.10
4	G	762	NAG	C1-O5-C5	3.45	116.94	112.19

There are no chirality outliers.

There are no torsion outliers.

There are no ring outliers.

8 monomers are involved in 10 short contacts:

Mol	Chain	Res	Type	Clashes	Symm-Clashes
4	G	789	NAG	1	0
4	G	834	NAG	1	0

*Continued on next page...*



*Continued from previous page...*

Mol	Chain	Res	Type	Clashes	Symm-Clashes
4	G	892	NAG	1	0
4	G	948	NAG	1	0
5	H	1001	SO4	2	0
6	H	1008	EDO	1	0
7	H	1009	TRS	2	0
5	L	1006	SO4	1	0

## 5.7 Other polymers [i](#)

There are no such residues in this entry.

## 5.8 Polymer linkage issues [i](#)

There are no chain breaks in this entry.

## 6 Fit of model and data

### 6.1 Protein, DNA and RNA chains

In the following table, the column labelled ‘#RSRZ > 2’ contains the number (and percentage) of RSRZ outliers, followed by percent RSRZ outliers for the chain as percentile scores relative to all X-ray entries and entries of similar resolution. The OWAB column contains the minimum, median, 95<sup>th</sup> percentile and maximum values of the occupancy-weighted average B-factor per residue. The column labelled ‘Q < 0.9’ lists the number of (and percentage) of residues with an average occupancy less than 0.9.

Mol	Chain	Analysed	<RSRZ>	#RSRZ>2	OWAB(Å <sup>2</sup> )	Q<0.9
1	G	344/353 (97%)	0.88	56 (16%) <b>1</b> <b>1</b>	34, 51, 87, 142	0
2	H	227/233 (97%)	0.42	16 (7%) <b>16</b> <b>18</b>	29, 40, 75, 140	0
3	L	208/209 (99%)	-0.10	0 <b>100</b> <b>100</b>	29, 39, 62, 87	0
All	All	779/795 (97%)	0.48	72 (9%) <b>9</b> <b>10</b>	29, 45, 81, 142	0

All (72) RSRZ outliers are listed below:

Mol	Chain	Res	Type	RSRZ
2	H	133	GLY	10.2
1	G	472	GLY	8.7
1	G	200	VAL	8.7
1	G	398	ASN	6.3
1	G	407	MET	6.1
2	H	214	LYS	5.5
1	G	326	ILE	5.3
1	G	44	VAL	5.2
1	G	408	LYS	5.1
1	G	461	ASN	4.8
2	H	76(A)	PRO	4.5
1	G	471	GLY	4.5
1	G	397	GLY	4.4
1	G	460	ALA	4.1
1	G	201	ILE	4.1
1	G	396	ILE	3.9
1	G	301	ASN	3.9
1	G	492	GLU	3.8
2	H	54	TRP	3.7
2	H	128	SER	3.7
1	G	325	ASP	3.7
1	G	410	CYS	3.6
1	G	453	LEU	3.6

*Continued on next page...*

*Continued from previous page...*

Mol	Chain	Res	Type	RSRZ
1	G	358	THR	3.6
1	G	462	ASN	3.5
2	H	50	TRP	3.5
1	G	411	ASN	3.4
1	G	473	GLY	3.4
1	G	259	LEU	3.2
2	H	76(B)	ASP	3.2
1	G	491	ILE	3.1
1	G	439	ILE	3.0
1	G	475	ILE	3.0
1	G	257	THR	3.0
1	G	300	SER	2.9
1	G	474	ASN	2.9
2	H	134	GLY	2.9
1	G	371	ILE	2.8
2	H	56	ALA	2.7
1	G	479	TRP	2.6
1	G	369	LEU	2.6
2	H	127	SER	2.6
2	H	57	VAL	2.6
2	H	191	THR	2.5
1	G	464	SER	2.5
1	G	281	ALA	2.5
1	G	412	GLY	2.5
1	G	260	LEU	2.5
1	G	254	VAL	2.4
1	G	436	ALA	2.4
1	G	255	VAL	2.4
2	H	76(C)	ASP	2.4
1	G	256	SER	2.4
1	G	87	GLU	2.4
1	G	261	LEU	2.4
2	H	51	ILE	2.3
1	G	283	THR	2.3
1	G	477	ASP	2.3
1	G	285	ILE	2.3
1	G	199	SER	2.2
1	G	284	ILE	2.2
1	G	96	TRP	2.2
1	G	440	ASP	2.1
1	G	122	LEU	2.1
1	G	481	SER	2.1

*Continued on next page...*

*Continued from previous page...*

Mol	Chain	Res	Type	RSRZ
1	G	202	LYS	2.1
1	G	478	ASN	2.1
2	H	189	LEU	2.1
1	G	394	THR	2.1
2	H	34	ILE	2.0
1	G	330	TYR	2.0
1	G	123	THR	2.0

## 6.2 Non-standard residues in protein, DNA, RNA chains [i](#)

There are no non-standard protein/DNA/RNA residues in this entry.

## 6.3 Carbohydrates [i](#)

There are no carbohydrates in this entry.

## 6.4 Ligands [i](#)

In the following table, the Atoms column lists the number of modelled atoms in the group and the number defined in the chemical component dictionary. The B-factors column lists the minimum, median, 95<sup>th</sup> percentile and maximum values of B factors of atoms in the group. The column labelled 'Q<0.9' lists the number of atoms with occupancy less than 0.9.

Mol	Type	Chain	Res	Atoms	RSCC	RSR	B-factors( $\text{\AA}^2$ )	Q<0.9
4	NAG	G	588	14/15	0.47	0.62	115,138,166,166	0
4	NAG	G	741	14/15	0.62	0.42	102,122,144,152	0
5	SO4	H	1004	5/5	0.65	0.45	171,176,179,184	0
7	TRS	H	1009	8/8	0.83	0.29	51,94,113,113	0
6	EDO	H	1010	4/4	0.84	0.19	63,76,84,84	0
4	NAG	G	948	14/15	0.86	0.16	65,86,114,127	0
4	NAG	G	892	14/15	0.86	0.25	73,102,125,125	0
6	EDO	H	1008	4/4	0.88	0.32	59,71,82,84	0
5	SO4	G	1000	5/5	0.88	0.25	113,118,121,126	0
4	NAG	G	834	14/15	0.90	0.25	56,102,131,131	0
5	SO4	L	1006	5/5	0.92	0.14	86,99,106,108	0
4	NAG	G	886	14/15	0.93	0.09	46,60,71,84	0
4	NAG	G	776	14/15	0.93	0.15	42,66,87,87	0
4	NAG	G	795	14/15	0.93	0.21	50,73,107,114	0
5	SO4	H	1005	5/5	0.94	0.32	86,89,104,105	0
5	SO4	G	1002	5/5	0.94	0.24	115,115,118,119	0

*Continued on next page...*

*Continued from previous page...*

Mol	Type	Chain	Res	Atoms	RSCC	RSR	B-factors( $\text{\AA}^2$ )	Q<0.9
4	NAG	G	789	14/15	0.94	0.20	47,65,88,88	0
4	NAG	G	734	14/15	0.96	0.06	44,59,78,78	0
4	NAG	G	762	14/15	0.96	0.10	31,45,57,64	0
5	SO4	H	1001	5/5	0.97	0.18	44,53,84,85	0
5	SO4	L	1007	5/5	0.98	0.13	40,43,60,65	0
5	SO4	L	1003	5/5	0.98	0.12	56,61,69,69	0

## 6.5 Other polymers [i](#)

There are no such residues in this entry.