



Full wwPDB EM Validation Report ⓘ

Nov 26, 2022 – 07:44 PM EST

PDB ID : 7T00
EMDB ID : EMD-25581
Title : cryoEM reconstruction of the HIV gp140 in complex with the extracellular domains of CD4 and the adnectin domain of Combinectin. The gp140 and CD4 coordinates from entry 6EDU were rigid body fitted to the EM map along with the crystal structure of CD4+adnectin
Authors : Concha, N.O.; William, S.P.; Wenzel, D.L.
Deposited on : 2021-11-30
Resolution : 8.70 Å(reported)

This is a Full wwPDB EM Validation Report for a publicly released PDB entry.

We welcome your comments at validation@mail.wwpdb.org

A user guide is available at

<https://www.wwpdb.org/validation/2017/EMValidationReportHelp>

with specific help available everywhere you see the ⓘ symbol.

The types of validation reports are described at

<http://www.wwpdb.org/validation/2017/FAQs#types>.

The following versions of software and data (see [references ⓘ](#)) were used in the production of this report:

EMDB validation analysis : 0.0.1.dev43
MolProbity : 4.02b-467
Percentile statistics : 20191225.v01 (using entries in the PDB archive December 25th 2019)
MapQ : 1.9.9
Ideal geometry (proteins) : Engh & Huber (2001)
Ideal geometry (DNA, RNA) : Parkinson et al. (1996)
Validation Pipeline (wwPDB-VP) : 2.31.2

1 Overall quality at a glance

The following experimental techniques were used to determine the structure:

ELECTRON MICROSCOPY

The reported resolution of this entry is 8.70 Å.

Percentile scores (ranging between 0-100) for global validation metrics of the entry are shown in the following graphic. The table shows the number of entries on which the scores are based.

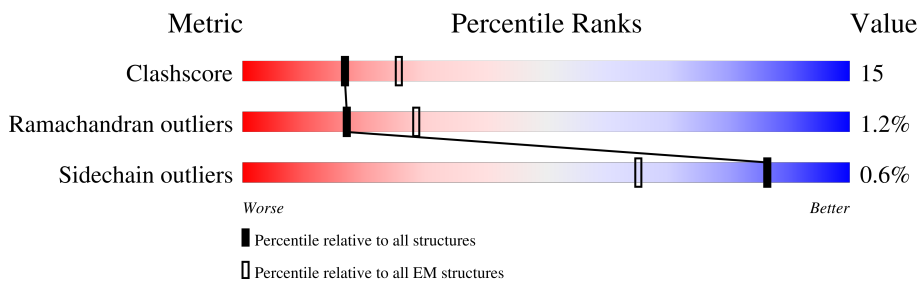

Metric	Whole archive (#Entries)	EM structures (#Entries)
Clashscore	158937	4297
Ramachandran outliers	154571	4023
Sidechain outliers	154315	3826

The table below summarises the geometric issues observed across the polymeric chains and their fit to the map. The red, orange, yellow and green segments of the bar indicate the fraction of residues that contain outliers for ≥ 3 , 2, 1 and 0 types of geometric quality criteria respectively. A grey segment represents the fraction of residues that are not modelled. The numeric value for each fraction is indicated below the corresponding segment, with a dot representing fractions $\leq 5\%$. The upper red bar (where present) indicates the fraction of residues that have poor fit to the EM map (all-atom inclusion $< 40\%$). The numeric value is given above the bar.

Mol	Chain	Length	Quality of chain
1	D	650	
1	G	650	
1	I	650	
2	B	39	
3	F	38	
3	J	38	
4	H	370	
4	L	370	

Continued on next page...

Continued from previous page...

Mol	Chain	Length	Quality of chain
4	M	370	<p>47% 67% 28% 5%</p>
5	O	108	<p>50% 67% 21% 12%</p>
5	P	108	<p>55% 67% 21% 12%</p>
5	Q	108	<p>53% 67% 21% 12%</p>
6	K	35	<p>6% 94% 6%</p>
6	N	35	<p>26% 94% 6%</p>
6	R	35	<p>17% 94% 6%</p>

2 Entry composition

There are 6 unique types of molecules in this entry. The entry contains 19033 atoms, of which 0 are hydrogens and 0 are deuteriums.

In the tables below, the AltConf column contains the number of residues with at least one atom in alternate conformation and the Trace column contains the number of residues modelled with at most 2 atoms.

- Molecule 1 is a protein called BG505 SOSIP.664 gp140.

Mol	Chain	Residues	Atoms					AltConf	Trace
			Total	C	N	O	S		
1	D	360	2772	1734	487	527	24	0	0
1	G	353	2731	1713	478	516	24	0	0
1	I	356	2749	1722	482	521	24	0	0

- Molecule 2 is a protein called BG505 SOSIP.664 gp140.

Mol	Chain	Residues	Atoms				AltConf	Trace
			Total	C	N	O		
2	B	35	175	105	35	35	0	0

- Molecule 3 is a protein called BG505 SOSIP.664 gp140.

Mol	Chain	Residues	Atoms				AltConf	Trace
			Total	C	N	O		
3	F	37	185	111	37	37	0	0
3	J	37	185	111	37	37	0	0

- Molecule 4 is a protein called T-cell surface glycoprotein CD4.

Mol	Chain	Residues	Atoms					AltConf	Trace
			Total	C	N	O	S		
4	H	356	2544	1617	419	498	10	0	0
4	L	357	2553	1613	420	510	10	0	0
4	M	353	2519	1592	413	504	10	0	0

There are 18 discrepancies between the modelled and reference sequences:

Chain	Residue	Modelled	Actual	Comment	Reference
H	365	HIS	-	expression tag	UNP P01730
H	366	HIS	-	expression tag	UNP P01730
H	367	HIS	-	expression tag	UNP P01730
H	368	HIS	-	expression tag	UNP P01730
H	369	HIS	-	expression tag	UNP P01730
H	370	HIS	-	expression tag	UNP P01730
L	365	HIS	-	expression tag	UNP P01730
L	366	HIS	-	expression tag	UNP P01730
L	367	HIS	-	expression tag	UNP P01730
L	368	HIS	-	expression tag	UNP P01730
L	369	HIS	-	expression tag	UNP P01730
L	370	HIS	-	expression tag	UNP P01730
M	365	HIS	-	expression tag	UNP P01730
M	366	HIS	-	expression tag	UNP P01730
M	367	HIS	-	expression tag	UNP P01730
M	368	HIS	-	expression tag	UNP P01730
M	369	HIS	-	expression tag	UNP P01730
M	370	HIS	-	expression tag	UNP P01730

- Molecule 5 is a protein called Adnectin.

Mol	Chain	Residues	Atoms					AltConf	Trace
5	O	95	Total	C	N	O	S	0	0
			711	457	118	135	1		
5	P	95	Total	C	N	O	S	0	0
			707	455	117	134	1		
5	Q	95	Total	C	N	O	S	0	0
			707	455	117	134	1		

- Molecule 6 is a protein called BG505 SOSIP.664 gp140.

Mol	Chain	Residues	Atoms				AltConf	Trace
6	K	33	Total	C	N	O	0	0
			165	99	33	33		
6	N	33	Total	C	N	O	0	0
			165	99	33	33		
6	R	33	Total	C	N	O	0	0
			165	99	33	33		

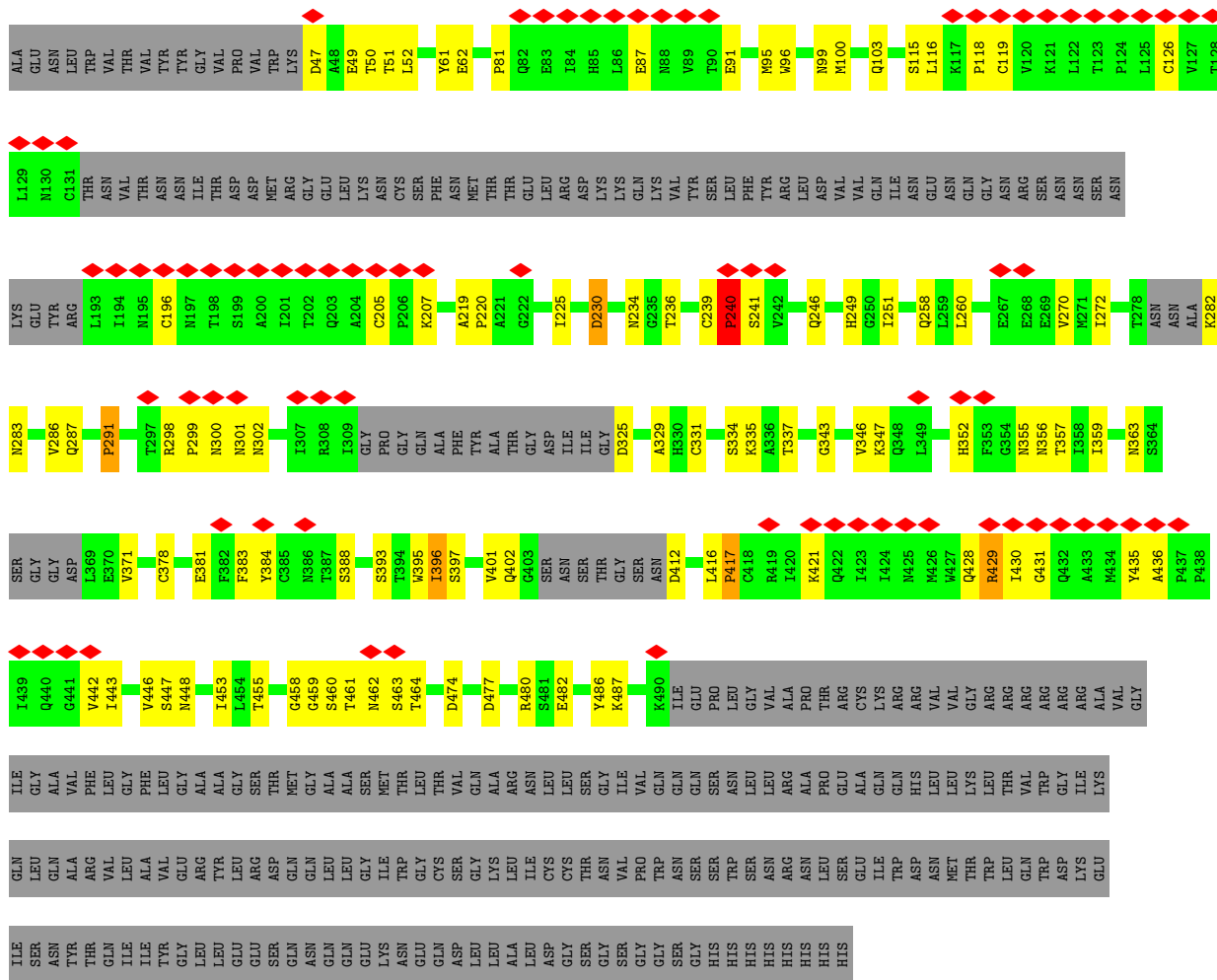

• Molecule 1: BG505 SOSIP.664 gp140

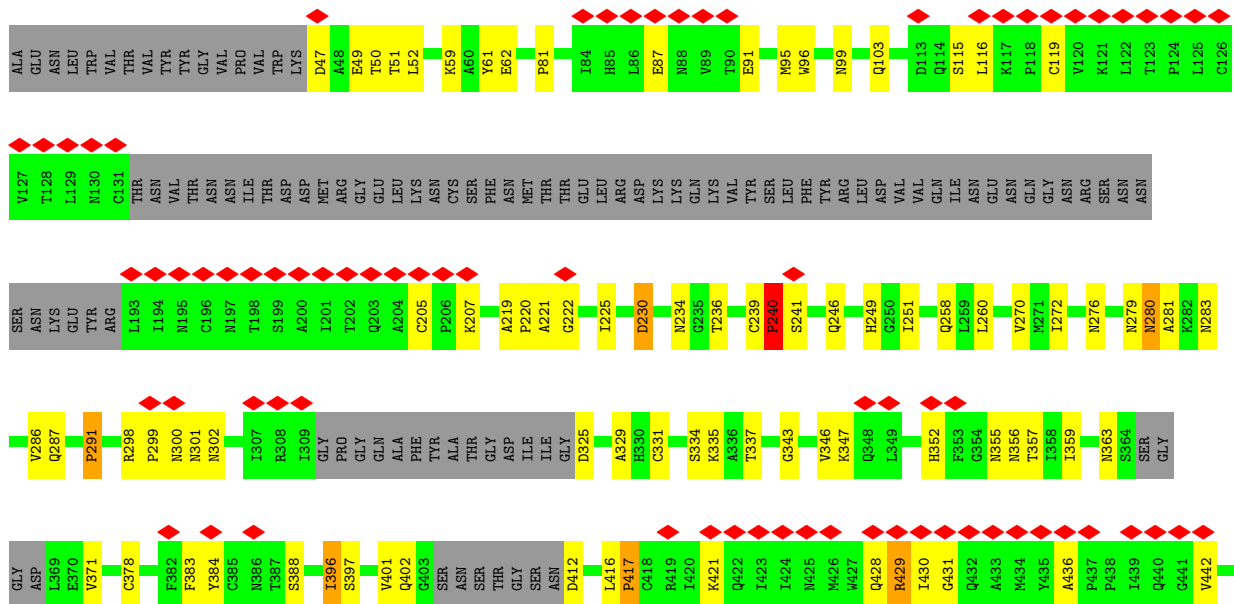
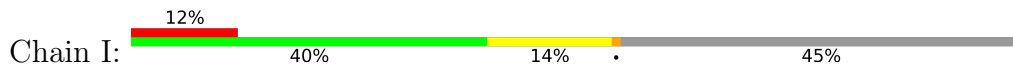

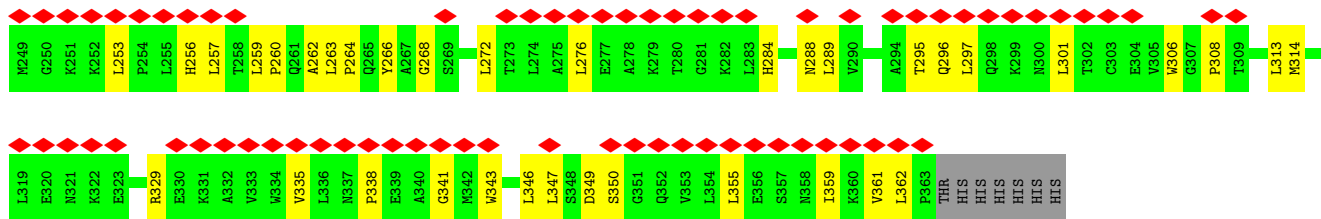

• Molecule 4: T-cell surface glycoprotein CD4

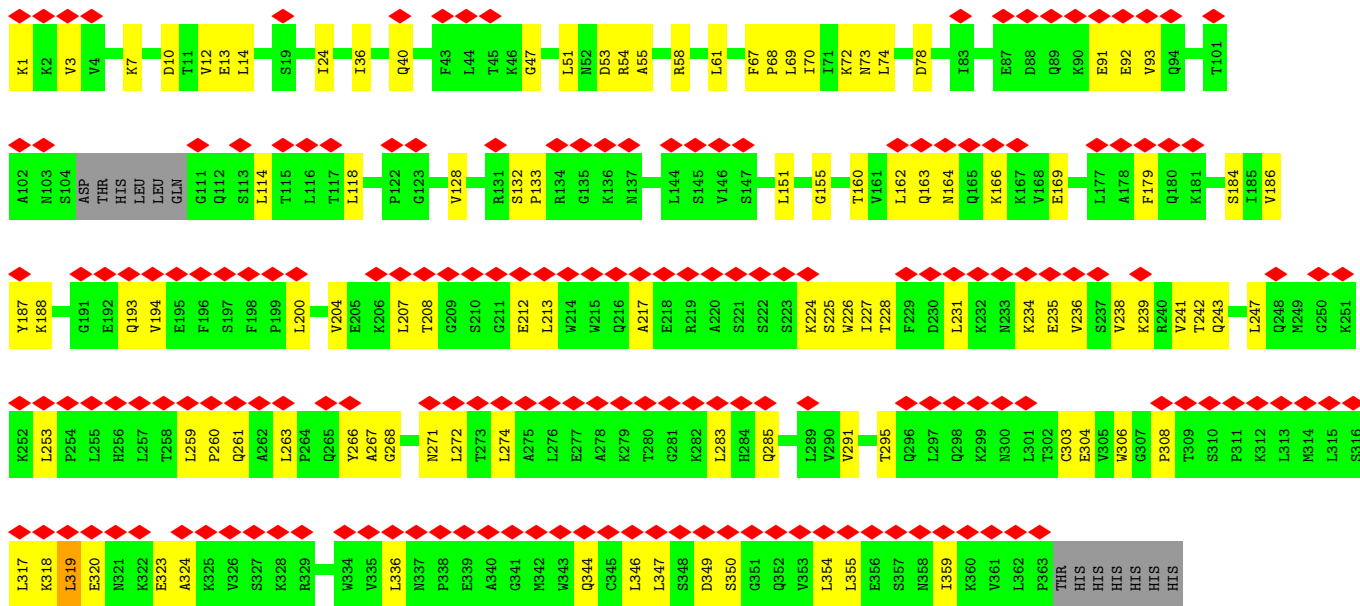

• Molecule 4: T-cell surface glycoprotein CD4

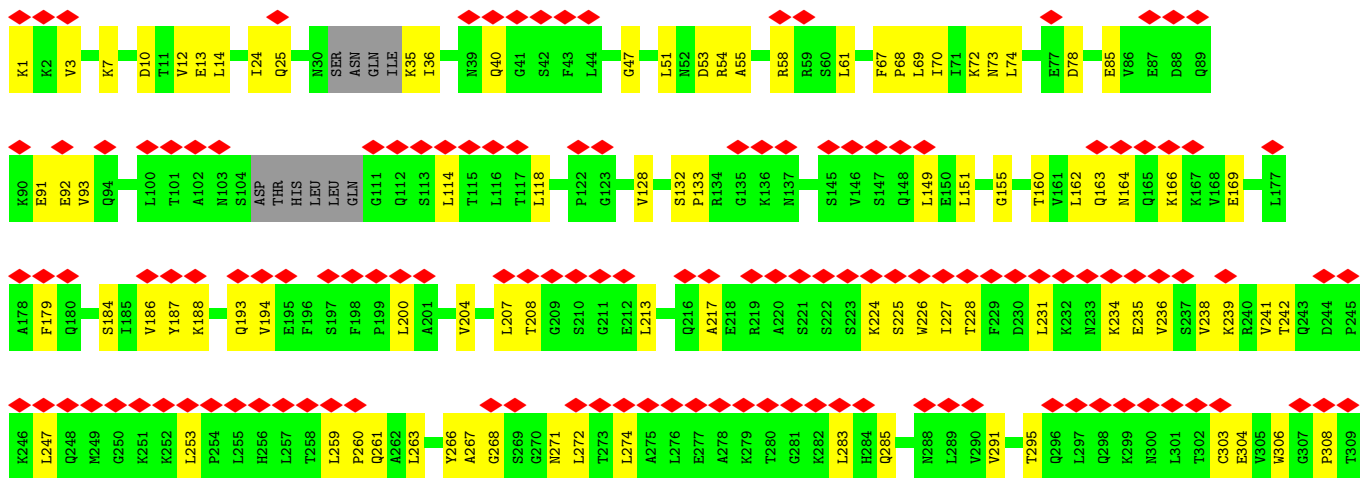

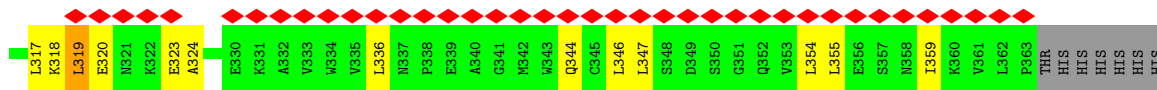

• Molecule 5: Adnectin

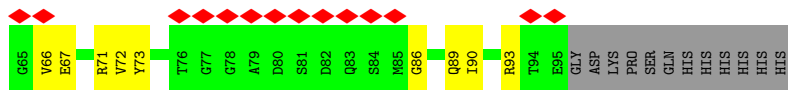

• Molecule 5: Adnectin

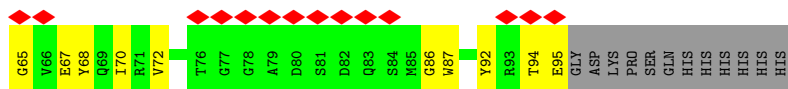
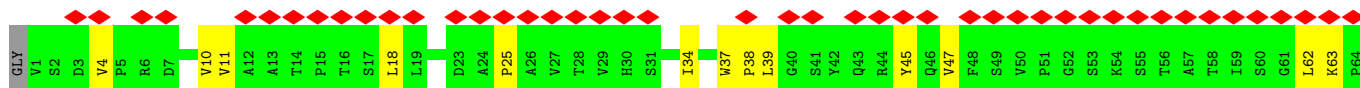

• Molecule 5: Adnectin

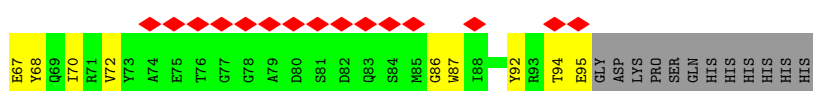
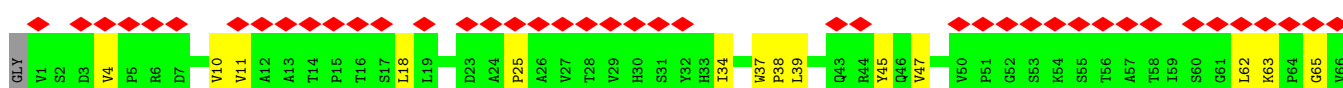

• Molecule 6: BG505 SOSIP.664 gp140

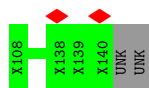
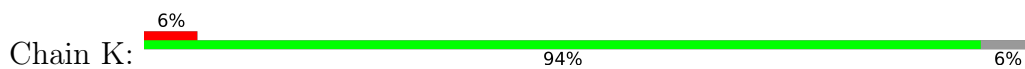

• Molecule 6: BG505 SOSIP.664 gp140



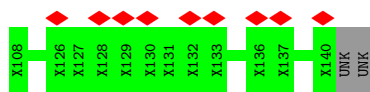

- Molecule 6: BG505 SOSIP.664 gp140

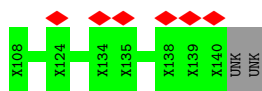

4 Experimental information

Property	Value	Source
EM reconstruction method	SINGLE PARTICLE	Depositor
Imposed symmetry	POINT, C3	Depositor
Number of particles used	208485	Depositor
Resolution determination method	FSC 0.143 CUT-OFF	Depositor
CTF correction method	PHASE FLIPPING AND AMPLITUDE CORRECTION	Depositor
Microscope	FEI TITAN KRIOS	Depositor
Voltage (kV)	300	Depositor
Electron dose ($e^-/\text{\AA}^2$)	1.022	Depositor
Minimum defocus (nm)	1400	Depositor
Maximum defocus (nm)	3400	Depositor
Magnification	Not provided	
Image detector	FEI FALCON III (4k x 4k)	Depositor
Maximum map value	28.005	Depositor
Minimum map value	-5.139	Depositor
Average map value	0.625	Depositor
Map value standard deviation	2.529	Depositor
Recommended contour level	4.42	Depositor
Map size (Å)	243.7776, 229.00319, 123.119995	wwPDB
Map dimensions	50, 93, 99	wwPDB
Map angles (°)	90.0, 90.0, 90.0	wwPDB
Pixel spacing (Å)	2.4624, 2.4624, 2.4624	Depositor

5 Model quality i

5.1 Standard geometry i

The Z score for a bond length (or angle) is the number of standard deviations the observed value is removed from the expected value. A bond length (or angle) with $|Z| > 5$ is considered an outlier worth inspection. RMSZ is the root-mean-square of all Z scores of the bond lengths (or angles).

Mol	Chain	Bond lengths		Bond angles	
		RMSZ	# Z >5	RMSZ	# Z >5
1	D	0.50	0/2828	0.76	8/3845 (0.2%)
1	G	0.50	0/2785	0.76	8/3784 (0.2%)
1	I	0.50	0/2804	0.77	8/3812 (0.2%)
4	H	0.29	0/2589	0.59	0/3544
4	L	0.31	0/2595	0.60	1/3551 (0.0%)
4	M	0.31	0/2559	0.60	1/3500 (0.0%)
5	O	0.30	0/731	0.57	0/1004
5	P	0.30	0/727	0.57	0/999
5	Q	0.30	0/727	0.57	0/999
All	All	0.41	0/18345	0.68	26/25038 (0.1%)

There are no bond length outliers.

All (26) bond angle outliers are listed below:

Mol	Chain	Res	Type	Atoms	Z	Observed($^{\circ}$)	Ideal($^{\circ}$)
1	D	240	PRO	CA-N-CD	-8.94	98.98	111.50
1	G	240	PRO	CA-N-CD	-8.92	99.01	111.50
1	I	240	PRO	CA-N-CD	-8.92	99.02	111.50
1	G	417	PRO	CA-N-CD	-8.64	99.40	111.50
1	D	291	PRO	CA-N-CD	-8.63	99.41	111.50
1	G	291	PRO	CA-N-CD	-8.63	99.42	111.50
1	D	417	PRO	CA-N-CD	-8.62	99.43	111.50
1	I	291	PRO	CA-N-CD	-8.62	99.44	111.50
1	I	417	PRO	CA-N-CD	-8.60	99.47	111.50
1	G	47	ASP	CB-CG-OD2	5.30	123.07	118.30
1	I	47	ASP	CB-CG-OD2	5.30	123.07	118.30
4	M	114	LEU	CA-CB-CG	5.30	127.48	115.30
1	D	47	ASP	CB-CG-OD2	5.27	123.05	118.30
4	L	114	LEU	CA-CB-CG	5.26	127.40	115.30
1	G	325	ASP	CB-CG-OD2	5.25	123.03	118.30
1	G	474	ASP	CB-CG-OD2	5.25	123.02	118.30
1	I	474	ASP	CB-CG-OD2	5.22	123.00	118.30
1	D	325	ASP	CB-CG-OD2	5.22	123.00	118.30

Continued on next page...

Continued from previous page...

Mol	Chain	Res	Type	Atoms	Z	Observed(°)	Ideal(°)
1	I	325	ASP	CB-CG-OD2	5.21	122.99	118.30
1	D	474	ASP	CB-CG-OD2	5.20	122.98	118.30
1	D	230	ASP	CB-CG-OD2	5.18	122.96	118.30
1	G	412	ASP	CB-CG-OD2	5.16	122.94	118.30
1	D	412	ASP	CB-CG-OD2	5.16	122.94	118.30
1	I	230	ASP	CB-CG-OD2	5.16	122.94	118.30
1	I	412	ASP	CB-CG-OD2	5.14	122.93	118.30
1	G	230	ASP	CB-CG-OD2	5.13	122.92	118.30

There are no chirality outliers.

There are no planarity outliers.

5.2 Too-close contacts [i](#)

In the following table, the Non-H and H(model) columns list the number of non-hydrogen atoms and hydrogen atoms in the chain respectively. The H(added) column lists the number of hydrogen atoms added and optimized by MolProbity. The Clashes column lists the number of clashes within the asymmetric unit, whereas Symm-Clashes lists symmetry-related clashes.

Mol	Chain	Non-H	H(model)	H(added)	Clashes	Symm-Clashes
1	D	2772	0	2690	99	0
1	G	2731	0	2658	97	0
1	I	2749	0	2670	120	0
2	B	175	0	37	7	0
3	F	185	0	39	2	0
3	J	185	0	39	30	0
4	H	2544	0	2381	72	0
4	L	2553	0	2386	70	0
4	M	2519	0	2353	73	0
5	O	711	0	674	13	0
5	P	707	0	668	16	0
5	Q	707	0	668	16	0
6	K	165	0	36	0	0
6	N	165	0	36	0	0
6	R	165	0	36	0	0
All	All	19033	0	17371	563	0

The all-atom clashscore is defined as the number of clashes found per 1000 atoms (including hydrogen atoms). The all-atom clashscore for this structure is 15.

All (563) close contacts within the same asymmetric unit are listed below, sorted by their clash magnitude.

Atom-1	Atom-2	Interatomic distance (Å)	Clash overlap (Å)
1:I:61:TYR:CB	3:J:1:UNK:H	1.15	1.57
1:I:61:TYR:HB2	3:J:1:UNK:N	1.34	1.43
1:D:221:ALA:HB1	3:J:33:UNK:CB	1.54	1.34
1:I:61:TYR:CD2	3:J:1:UNK:N	2.05	1.24
1:I:61:TYR:CG	3:J:1:UNK:N	2.07	1.22
1:I:61:TYR:CB	3:J:1:UNK:N	1.96	1.18
1:D:96:TRP:CZ3	1:D:236:THR:HG23	1.82	1.15
1:G:458:GLY:CA	1:G:462:ASN:HD21	1.60	1.15
1:D:396:ILE:HG22	1:D:397:SER:H	1.12	1.14
1:D:458:GLY:HA2	1:D:462:ASN:ND2	1.62	1.13
1:G:96:TRP:CZ3	1:G:236:THR:HG23	1.82	1.13
1:I:96:TRP:CZ3	1:I:236:THR:HG23	1.82	1.13
1:G:230:ASP:OD2	1:G:240:PRO:HD3	1.48	1.12
1:G:458:GLY:HA2	1:G:462:ASN:ND2	1.62	1.12
1:D:458:GLY:CA	1:D:462:ASN:HD21	1.60	1.12
1:G:458:GLY:HA2	1:G:462:ASN:HD21	0.97	1.11
1:D:230:ASP:OD2	1:D:240:PRO:HD3	1.48	1.11
1:I:396:ILE:HG22	1:I:397:SER:H	1.12	1.11
1:D:458:GLY:HA2	1:D:462:ASN:HD21	0.97	1.10
1:I:230:ASP:OD2	1:I:240:PRO:HD3	1.48	1.10
1:G:396:ILE:HG22	1:G:397:SER:H	1.12	1.07
1:I:428:GLN:O	1:I:429:ARG:HG3	1.57	1.04
1:G:428:GLN:O	1:G:429:ARG:HG3	1.58	1.03
1:D:428:GLN:O	1:D:429:ARG:HG3	1.58	1.02
1:D:221:ALA:CB	3:J:33:UNK:CB	2.38	1.01
1:D:96:TRP:HZ3	1:D:236:THR:HG23	1.17	0.98
1:I:61:TYR:CD1	3:J:2:UNK:N	2.31	0.97
1:G:96:TRP:HZ3	1:G:236:THR:HG23	1.17	0.96
1:I:281:ALA:HB2	4:M:85:GLU:CB	1.95	0.95
1:D:240:PRO:HD2	1:D:241:SER:H	1.31	0.95
1:G:396:ILE:HG22	1:G:397:SER:N	1.81	0.95
1:G:240:PRO:HD2	1:G:241:SER:H	1.31	0.93
1:I:240:PRO:HD2	1:I:241:SER:H	1.31	0.93
1:D:396:ILE:HG22	1:D:397:SER:N	1.81	0.93
1:I:96:TRP:HZ3	1:I:236:THR:HG23	1.17	0.92
1:I:396:ILE:HG22	1:I:397:SER:N	1.81	0.91
4:L:163:GLN:HG3	4:L:164:ASN:H	1.34	0.90
4:M:163:GLN:HG3	4:M:164:ASN:H	1.34	0.90
1:I:61:TYR:HB3	3:J:1:UNK:C	2.02	0.89
1:I:230:ASP:OD2	1:I:239:CYS:HB2	1.73	0.88
1:I:428:GLN:O	1:I:429:ARG:CG	2.22	0.88
1:D:230:ASP:OD2	1:D:239:CYS:HB2	1.74	0.88

Continued on next page...

Continued from previous page...

Atom-1	Atom-2	Interatomic distance (Å)	Clash overlap (Å)
1:I:357:THR:HA	1:I:464:THR:O	1.74	0.87
1:D:357:THR:HA	1:D:464:THR:O	1.74	0.87
1:G:396:ILE:CG2	1:G:397:SER:H	1.88	0.87
1:D:428:GLN:O	1:D:429:ARG:CG	2.22	0.87
1:G:357:THR:HA	1:G:464:THR:O	1.74	0.87
1:G:428:GLN:O	1:G:429:ARG:CG	2.22	0.87
1:G:230:ASP:OD2	1:G:239:CYS:HB2	1.73	0.86
1:I:401:VAL:O	1:I:402:GLN:HG3	1.75	0.85
1:I:474:ASP:OD2	4:M:25:GLN:HB2	1.74	0.85
1:D:396:ILE:CG2	1:D:397:SER:H	1.88	0.85
1:I:396:ILE:CG2	1:I:397:SER:H	1.88	0.85
1:I:363:ASN:HD21	1:I:388:SER:HB2	1.41	0.85
1:I:463:SER:O	1:I:464:THR:OG1	1.95	0.84
1:G:401:VAL:O	1:G:402:GLN:HG3	1.75	0.84
1:G:463:SER:O	1:G:464:THR:OG1	1.95	0.84
1:D:463:SER:O	1:D:464:THR:OG1	1.95	0.84
1:I:276:ASN:ND2	1:I:279:ASN:ND2	2.25	0.84
1:D:363:ASN:HD21	1:D:388:SER:HB2	1.41	0.83
1:D:96:TRP:CE3	1:D:236:THR:CG2	2.61	0.83
1:D:276:ASN:ND2	1:D:279:ASN:ND2	2.25	0.83
1:G:363:ASN:HD21	1:G:388:SER:HB2	1.41	0.83
1:G:96:TRP:CE3	1:G:236:THR:CG2	2.61	0.83
1:I:61:TYR:CB	3:J:1:UNK:C	2.56	0.83
1:I:96:TRP:CE3	1:I:236:THR:CG2	2.61	0.83
1:G:272:ILE:HD11	1:G:352:HIS:NE2	1.95	0.81
1:I:272:ILE:HD11	1:I:352:HIS:NE2	1.95	0.81
1:D:272:ILE:HD11	1:D:352:HIS:NE2	1.95	0.80
1:D:96:TRP:CZ3	1:D:236:THR:CG2	2.65	0.79
4:H:242:THR:HG23	4:H:245:PRO:HD2	1.64	0.79
1:G:96:TRP:CZ3	1:G:236:THR:CG2	2.65	0.78
1:I:61:TYR:HB2	3:J:1:UNK:H	0.61	0.78
1:G:240:PRO:HD2	1:G:241:SER:N	1.99	0.78
1:D:240:PRO:HD2	1:D:241:SER:N	1.99	0.77
4:H:151:LEU:HD12	4:H:184:SER:HB2	1.66	0.77
1:I:96:TRP:CZ3	1:I:236:THR:CG2	2.65	0.77
4:H:118:LEU:HD22	4:H:128:VAL:HG21	1.67	0.77
1:I:240:PRO:HD2	1:I:241:SER:N	1.99	0.77
1:I:61:TYR:HD2	3:J:1:UNK:N	1.81	0.77
4:H:263:LEU:HB2	4:H:266:TYR:HD2	1.50	0.77
1:G:96:TRP:CE3	1:G:236:THR:HG23	2.21	0.76
1:D:428:GLN:O	1:D:429:ARG:CB	2.34	0.75

Continued on next page...

Continued from previous page...

Atom-1	Atom-2	Interatomic distance (Å)	Clash overlap (Å)
1:G:428:GLN:O	1:G:429:ARG:CB	2.34	0.75
1:I:52:LEU:H	1:I:103:GLN:HE22	1.34	0.74
1:D:52:LEU:H	1:D:103:GLN:HE22	1.35	0.74
1:G:61:TYR:CE2	1:G:62:GLU:HG3	2.22	0.74
4:H:227:ILE:HG22	4:H:241:VAL:HG23	1.70	0.74
1:D:458:GLY:C	1:D:462:ASN:HD21	1.91	0.74
1:I:61:TYR:CE2	1:I:62:GLU:HG3	2.22	0.74
1:D:96:TRP:CE3	1:D:236:THR:HG23	2.21	0.74
1:D:61:TYR:CE2	1:D:62:GLU:HG3	2.23	0.73
1:I:96:TRP:CE3	1:I:236:THR:HG23	2.21	0.73
1:I:221:ALA:HB2	2:B:30:UNK:CB	2.18	0.73
1:I:428:GLN:O	1:I:429:ARG:CB	2.34	0.73
1:G:458:GLY:CA	1:G:462:ASN:ND2	2.34	0.73
1:G:458:GLY:C	1:G:462:ASN:HD21	1.91	0.73
4:H:185:ILE:HG13	4:H:288:ASN:HB2	1.71	0.72
1:G:461:THR:CB	4:H:33:GLN:O	2.37	0.72
1:G:52:LEU:H	1:G:103:GLN:HE22	1.34	0.72
1:I:59:LYS:O	3:J:2:UNK:CB	2.37	0.72
4:H:301:LEU:HD23	4:H:338:PRO:HG3	1.71	0.72
1:D:222:GLY:HA2	3:J:34:UNK:HA	1.72	0.71
1:D:458:GLY:CA	1:D:462:ASN:ND2	2.34	0.71
4:L:187:TYR:HB3	4:L:355:LEU:HG	1.73	0.71
4:H:151:LEU:HD23	4:H:176:VAL:HG23	1.73	0.70
1:I:61:TYR:CG	3:J:1:UNK:CA	2.73	0.70
4:H:227:ILE:CG2	4:H:241:VAL:HG23	2.21	0.70
1:G:272:ILE:HD11	1:G:352:HIS:CD2	2.27	0.70
4:M:187:TYR:HB3	4:M:355:LEU:HG	1.73	0.69
4:H:151:LEU:HA	4:H:176:VAL:HG21	1.74	0.69
1:D:272:ILE:HD11	1:D:352:HIS:CD2	2.27	0.69
1:I:272:ILE:HD11	1:I:352:HIS:CD2	2.27	0.69
1:I:221:ALA:CB	2:B:30:UNK:CB	2.71	0.68
1:D:222:GLY:CA	3:J:34:UNK:HA	2.23	0.68
4:H:204:VAL:HA	4:H:207:LEU:HD13	1.74	0.68
1:G:96:TRP:HE3	1:G:236:THR:CG2	2.05	0.68
1:I:61:TYR:CG	3:J:2:UNK:N	2.61	0.68
1:I:457:ASP:OD1	4:M:35:LYS:N	2.25	0.68
4:H:83:ILE:HG13	4:H:92:GLU:HG3	1.74	0.68
4:L:151:LEU:HD12	4:L:184:SER:HB2	1.75	0.68
2:B:35:UNK:O	2:B:37:UNK:O	2.12	0.68
3:F:35:UNK:O	3:F:37:UNK:O	2.12	0.68
1:I:96:TRP:HE3	1:I:236:THR:CG2	2.05	0.67

Continued on next page...

Continued from previous page...

Atom-1	Atom-2	Interatomic distance (Å)	Clash overlap (Å)
1:D:96:TRP:HE3	1:D:236:THR:CG2	2.05	0.67
4:M:151:LEU:HD12	4:M:184:SER:HB2	1.75	0.67
3:J:35:UNK:O	3:J:37:UNK:O	2.12	0.67
1:D:459:GLY:N	1:D:462:ASN:ND2	2.43	0.67
4:M:227:ILE:HG22	4:M:241:VAL:HA	1.77	0.67
1:G:282:LYS:N	4:H:87:GLU:CB	2.59	0.66
1:G:458:GLY:C	1:G:462:ASN:ND2	2.49	0.66
4:H:244:ASP:HB3	4:H:245:PRO:HD3	1.77	0.66
1:D:49:GLU:HG2	1:D:99:ASN:HD22	1.61	0.66
4:H:76:ILE:HD13	4:H:97:VAL:HG12	1.77	0.66
1:D:222:GLY:N	3:J:34:UNK:HA	2.11	0.66
5:O:67:GLU:HG2	5:O:93:ARG:NH1	2.11	0.66
4:L:227:ILE:HG22	4:L:241:VAL:HA	1.77	0.66
1:I:61:TYR:CB	3:J:1:UNK:CA	2.74	0.65
1:G:459:GLY:N	1:G:462:ASN:ND2	2.43	0.65
4:H:54:ARG:NH1	4:H:78:ASP:OD2	2.28	0.65
4:L:1:LYS:N	4:L:92:GLU:OE2	2.30	0.65
1:D:363:ASN:OD1	1:D:388:SER:HA	1.97	0.65
1:D:458:GLY:C	1:D:462:ASN:ND2	2.49	0.65
1:I:61:TYR:HD1	3:J:2:UNK:CB	2.10	0.64
4:M:231:LEU:HD13	4:M:236:VAL:HG22	1.79	0.64
1:I:49:GLU:HG2	1:I:99:ASN:HD22	1.61	0.64
4:H:5:LEU:HD22	4:H:96:LEU:HB2	1.79	0.64
1:D:363:ASN:ND2	1:D:388:SER:HB2	2.12	0.64
5:O:63:LYS:HB2	5:O:66:VAL:HG21	1.80	0.64
1:G:363:ASN:OD1	1:G:388:SER:HA	1.97	0.64
4:M:1:LYS:N	4:M:92:GLU:OE2	2.30	0.64
1:G:49:GLU:HG2	1:G:99:ASN:HD22	1.61	0.64
4:L:231:LEU:HD13	4:L:236:VAL:HG22	1.79	0.64
1:G:363:ASN:ND2	1:G:388:SER:HB2	2.12	0.64
1:G:371:VAL:HG21	4:H:41:GLY:HA3	1.80	0.64
1:I:363:ASN:OD1	1:I:388:SER:HA	1.97	0.63
1:G:335:LYS:HE2	1:G:401:VAL:HG11	1.81	0.63
1:D:335:LYS:HE2	1:D:401:VAL:HG11	1.81	0.63
5:P:65:GLY:HA2	5:P:94:THR:O	1.98	0.63
4:H:268:GLY:HA2	4:H:308:PRO:HD3	1.81	0.63
1:G:343:GLY:O	1:G:347:LYS:HG3	1.99	0.62
1:I:442:VAL:HG12	1:I:442:VAL:O	1.99	0.62
1:G:335:LYS:HE2	1:G:401:VAL:CG1	2.29	0.62
1:G:442:VAL:HG12	1:G:442:VAL:O	1.99	0.62
1:I:335:LYS:HE2	1:I:401:VAL:CG1	2.29	0.62

Continued on next page...

Continued from previous page...

Atom-1	Atom-2	Interatomic distance (Å)	Clash overlap (Å)
1:D:335:LYS:HE2	1:D:401:VAL:CG1	2.29	0.62
1:I:61:TYR:CD1	3:J:2:UNK:CB	2.83	0.62
1:D:276:ASN:ND2	1:D:279:ASN:HD22	1.98	0.62
5:Q:65:GLY:HA2	5:Q:94:THR:O	1.99	0.62
1:I:335:LYS:HE2	1:I:401:VAL:HG11	1.81	0.62
4:L:118:LEU:HD22	4:L:128:VAL:HG21	1.81	0.62
5:Q:65:GLY:CA	5:Q:94:THR:O	2.48	0.62
1:D:343:GLY:O	1:D:347:LYS:HG3	1.99	0.62
1:I:363:ASN:ND2	1:I:388:SER:HB2	2.12	0.62
5:O:29:VAL:HG11	5:O:32:TYR:CE1	2.34	0.62
5:P:65:GLY:CA	5:P:94:THR:O	2.48	0.62
4:M:118:LEU:HD22	4:M:128:VAL:HG21	1.81	0.61
4:M:200:LEU:HD22	4:M:204:VAL:HG21	1.83	0.61
1:I:343:GLY:O	1:I:347:LYS:HG3	1.99	0.61
1:D:258:GLN:NE2	1:D:371:VAL:O	2.33	0.61
4:H:259:LEU:HD23	4:H:260:PRO:HD2	1.82	0.61
4:M:188:LYS:HG3	4:M:194:VAL:HG22	1.83	0.61
1:G:258:GLN:NE2	1:G:371:VAL:O	2.33	0.61
1:I:258:GLN:NE2	1:I:371:VAL:O	2.33	0.61
1:D:222:GLY:O	3:J:37:UNK:CB	2.49	0.61
1:D:442:VAL:HG12	1:D:442:VAL:O	1.99	0.61
1:I:222:GLY:HA2	2:B:34:UNK:CB	2.31	0.61
1:I:463:SER:C	1:I:464:THR:HG1	2.00	0.60
4:M:14:LEU:HD22	4:M:93:VAL:HG11	1.83	0.60
4:M:54:ARG:NH2	4:M:78:ASP:OD2	2.34	0.60
4:L:200:LEU:HD22	4:L:204:VAL:HG21	1.83	0.60
1:I:61:TYR:CG	3:J:1:UNK:C	2.85	0.60
4:H:12:VAL:HG22	4:H:74:LEU:HD11	1.84	0.60
4:L:163:GLN:HG3	4:L:164:ASN:N	2.12	0.60
1:I:281:ALA:CB	4:M:85:GLU:CB	2.77	0.60
4:L:188:LYS:HG3	4:L:194:VAL:HG22	1.83	0.60
4:L:54:ARG:NH2	4:L:78:ASP:OD2	2.34	0.60
1:I:222:GLY:CA	2:B:34:UNK:CB	2.80	0.60
1:I:276:ASN:ND2	1:I:279:ASN:HD22	1.98	0.59
1:I:371:VAL:CB	4:M:40:GLN:CA	2.80	0.59
4:L:274:LEU:O	4:L:283:LEU:HB2	2.02	0.59
4:M:274:LEU:O	4:M:283:LEU:HB2	2.02	0.59
4:L:14:LEU:HD22	4:L:93:VAL:HG11	1.83	0.59
1:D:417:PRO:HD2	1:D:417:PRO:O	2.03	0.59
4:M:234:LYS:HA	4:M:253:LEU:HD13	1.85	0.59
1:I:417:PRO:HD2	1:I:417:PRO:O	2.03	0.59

Continued on next page...

Continued from previous page...

Atom-1	Atom-2	Interatomic distance (Å)	Clash overlap (Å)
1:I:396:ILE:CG2	1:I:397:SER:N	2.52	0.59
1:I:283:ASN:OD1	1:I:455:THR:HG22	2.03	0.59
4:H:247:LEU:HD22	4:H:257:LEU:HD21	1.83	0.58
1:I:240:PRO:CD	1:I:241:SER:H	2.11	0.58
4:M:163:GLN:HG3	4:M:164:ASN:N	2.13	0.58
1:G:417:PRO:HD2	1:G:417:PRO:O	2.03	0.58
1:G:240:PRO:CD	1:G:241:SER:N	2.67	0.58
1:D:283:ASN:OD1	1:D:455:THR:HG22	2.03	0.58
1:D:334:SER:HB3	1:D:337:THR:OG1	2.04	0.58
4:H:99:GLY:O	4:H:118:LEU:HD12	2.04	0.58
5:P:65:GLY:N	5:P:94:THR:O	2.38	0.57
1:G:283:ASN:OD1	1:G:455:THR:HG22	2.03	0.57
5:Q:65:GLY:N	5:Q:94:THR:O	2.38	0.57
1:I:331:CYS:HB2	1:I:416:LEU:HB3	1.87	0.57
1:G:334:SER:HB3	1:G:337:THR:OG1	2.04	0.56
4:L:234:LYS:HA	4:L:253:LEU:HD13	1.85	0.56
1:D:331:CYS:HB2	1:D:416:LEU:HB3	1.87	0.56
1:G:428:GLN:O	1:G:429:ARG:HB2	2.05	0.56
1:D:447:SER:OG	1:D:448:ASN:N	2.38	0.56
1:G:207:LYS:HD3	1:G:436:ALA:HB3	1.88	0.56
1:I:240:PRO:CD	1:I:241:SER:N	2.67	0.56
1:I:334:SER:HB3	1:I:337:THR:OG1	2.04	0.56
1:D:207:LYS:HD3	1:D:436:ALA:HB3	1.88	0.56
1:D:240:PRO:CD	1:D:241:SER:N	2.67	0.56
1:I:447:SER:OG	1:I:448:ASN:N	2.38	0.56
1:D:50:THR:OG1	1:D:51:THR:N	2.39	0.56
5:P:63:LYS:O	5:P:94:THR:OG1	2.24	0.56
1:G:447:SER:OG	1:G:448:ASN:N	2.38	0.56
1:I:207:LYS:HD3	1:I:436:ALA:HB3	1.88	0.56
1:G:331:CYS:HB2	1:G:416:LEU:HB3	1.87	0.55
1:G:115:SER:OG	1:G:116:LEU:N	2.39	0.55
1:G:240:PRO:CD	1:G:241:SER:H	2.11	0.55
1:G:230:ASP:OD2	1:G:240:PRO:CD	2.39	0.55
1:D:240:PRO:CD	1:D:241:SER:H	2.11	0.55
1:G:50:THR:OG1	1:G:51:THR:N	2.39	0.55
1:I:50:THR:OG1	1:I:51:THR:N	2.39	0.55
1:D:115:SER:OG	1:D:116:LEU:N	2.39	0.55
1:D:477:ASP:OD1	1:D:480:ARG:NH1	2.40	0.55
4:L:73:ASN:ND2	5:P:11:VAL:O	2.40	0.55
5:Q:63:LYS:O	5:Q:94:THR:OG1	2.24	0.55
4:L:238:VAL:HG11	4:L:241:VAL:HG13	1.89	0.55

Continued on next page...

Continued from previous page...

Atom-1	Atom-2	Interatomic distance (Å)	Clash overlap (Å)
4:M:238:VAL:HG11	4:M:241:VAL:HG13	1.89	0.55
1:G:477:ASP:OD1	1:G:480:ARG:NH1	2.40	0.55
1:I:477:ASP:OD1	1:I:480:ARG:NH1	2.40	0.54
1:D:357:THR:HA	1:D:464:THR:C	2.27	0.54
1:G:357:THR:HA	1:G:464:THR:C	2.27	0.54
4:H:227:ILE:HG22	4:H:241:VAL:HA	1.89	0.54
4:L:58:ARG:HG2	4:L:70:ILE:HD11	1.90	0.54
1:I:428:GLN:O	1:I:429:ARG:HB2	2.05	0.54
1:I:115:SER:OG	1:I:116:LEU:N	2.39	0.54
4:H:74:LEU:HD22	4:H:97:VAL:HG21	1.90	0.54
4:H:101:THR:HG22	5:O:90:ILE:HG22	1.89	0.54
4:H:245:PRO:HB2	4:H:247:LEU:HG	1.90	0.54
4:M:73:ASN:ND2	5:Q:11:VAL:O	2.40	0.54
1:D:222:GLY:H	3:J:34:UNK:HA	1.73	0.53
1:G:363:ASN:ND2	1:G:388:SER:CB	2.71	0.53
5:O:73:TYR:HA	5:O:86:GLY:O	2.08	0.53
1:I:249:HIS:NE2	1:I:482:GLU:OE2	2.36	0.53
1:I:357:THR:HA	1:I:464:THR:C	2.27	0.53
1:D:363:ASN:ND2	1:D:388:SER:CB	2.71	0.53
1:D:428:GLN:O	1:D:429:ARG:HB2	2.05	0.53
4:H:349:ASP:OD1	4:H:350:SER:N	2.38	0.53
5:O:71:ARG:NH2	5:O:89:GLN:OE1	2.41	0.53
4:M:58:ARG:HG2	4:M:70:ILE:HD11	1.89	0.53
4:M:160:THR:HG22	4:M:169:GLU:HG2	1.90	0.53
1:D:230:ASP:CG	1:D:240:PRO:HD3	2.27	0.53
1:G:249:HIS:NE2	1:G:482:GLU:OE2	2.36	0.53
1:I:474:ASP:OD2	4:M:25:GLN:CB	2.51	0.53
1:I:230:ASP:CG	1:I:240:PRO:HD3	2.27	0.53
4:H:73:ASN:ND2	5:O:11:VAL:O	2.42	0.53
1:I:363:ASN:ND2	1:I:388:SER:CB	2.71	0.52
4:H:234:LYS:HG2	4:H:253:LEU:HD22	1.91	0.52
5:P:39:LEU:HD22	5:P:67:GLU:HG2	1.92	0.52
1:I:401:VAL:O	1:I:402:GLN:CG	2.54	0.52
5:Q:4:VAL:HG22	5:Q:86:GLY:HA3	1.91	0.52
4:H:157:TRP:CD1	4:H:174:ILE:HD12	2.45	0.52
4:M:228:THR:O	4:M:239:LYS:N	2.37	0.52
1:G:401:VAL:O	1:G:402:GLN:CG	2.54	0.52
4:H:263:LEU:HB2	4:H:266:TYR:CD2	2.39	0.52
4:L:213:LEU:HB2	4:L:272:LEU:HD13	1.92	0.52
1:I:61:TYR:CD1	3:J:2:UNK:CA	2.93	0.52
1:I:61:TYR:HB3	3:J:2:UNK:N	2.24	0.52

Continued on next page...

Continued from previous page...

Atom-1	Atom-2	Interatomic distance (Å)	Clash overlap (Å)
5:Q:39:LEU:HD22	5:Q:67:GLU:HG2	1.91	0.52
4:M:213:LEU:HB2	4:M:272:LEU:HD13	1.92	0.51
1:G:396:ILE:CG2	1:G:397:SER:N	2.52	0.51
4:H:14:LEU:HD12	4:H:69:LEU:HD23	1.91	0.51
1:D:249:HIS:NE2	1:D:482:GLU:OE2	2.36	0.51
4:L:160:THR:HG22	4:L:169:GLU:HG2	1.91	0.51
4:M:347:LEU:HD23	4:M:354:LEU:HB2	1.93	0.51
4:H:61:LEU:HD13	4:H:68:PRO:HG2	1.93	0.51
4:H:175:VAL:HG21	5:O:42:TYR:CD1	2.46	0.51
5:P:4:VAL:HG22	5:P:86:GLY:HA3	1.92	0.51
4:L:7:LYS:HB2	4:L:10:ASP:OD2	2.11	0.51
4:L:320:GLU:HG3	4:L:344:GLN:OE1	2.10	0.51
4:M:193:GLN:HB3	4:M:260:PRO:O	2.11	0.51
4:M:320:GLU:HG3	4:M:344:GLN:OE1	2.10	0.51
4:H:231:LEU:HD13	4:H:236:VAL:HG22	1.93	0.50
4:L:193:GLN:HB3	4:L:260:PRO:O	2.11	0.50
4:M:207:LEU:O	4:M:208:THR:OG1	2.24	0.50
1:I:356:ASN:O	1:I:464:THR:HB	2.10	0.50
1:G:356:ASN:O	1:G:464:THR:HB	2.11	0.50
4:M:7:LYS:HB2	4:M:10:ASP:OD2	2.12	0.50
4:L:228:THR:O	4:L:239:LYS:N	2.37	0.50
1:I:61:TYR:HD2	3:J:1:UNK:H2	1.47	0.50
1:G:230:ASP:CG	1:G:240:PRO:HD3	2.27	0.50
1:I:230:ASP:OD2	1:I:240:PRO:CD	2.39	0.50
1:D:356:ASN:O	1:D:464:THR:HB	2.11	0.50
4:L:213:LEU:HD12	4:L:271:ASN:O	2.12	0.50
1:D:280:ASN:HD22	1:D:458:GLY:H	1.60	0.50
4:L:318:LYS:O	4:L:344:GLN:HB2	2.12	0.50
1:I:276:ASN:ND2	1:I:279:ASN:HD21	2.05	0.50
1:I:280:ASN:HD22	1:I:458:GLY:H	1.60	0.49
4:L:54:ARG:HG2	4:L:72:LYS:O	2.12	0.49
4:M:54:ARG:HG2	4:M:72:LYS:O	2.12	0.49
4:M:263:LEU:HB2	4:M:266:TYR:HD2	1.78	0.49
4:M:344:GLN:HE21	4:M:346:LEU:HD11	1.77	0.49
4:H:133:PRO:HD3	4:H:157:TRP:CD1	2.48	0.49
1:I:474:ASP:OD2	4:M:25:GLN:N	2.46	0.49
4:L:347:LEU:HD23	4:L:354:LEU:HB2	1.93	0.49
4:M:179:PHE:HD2	4:M:200:LEU:HD21	1.77	0.49
1:D:474:ASP:OD1	4:L:40:GLN:CB	2.61	0.49
1:I:428:GLN:C	1:I:429:ARG:HG3	2.30	0.49
4:M:318:LYS:O	4:M:344:GLN:HB2	2.12	0.49

Continued on next page...

Continued from previous page...

Atom-1	Atom-2	Interatomic distance (Å)	Clash overlap (Å)
1:D:300:ASN:O	1:D:302:ASN:N	2.46	0.49
4:L:12:VAL:HG22	4:L:74:LEU:HD21	1.95	0.49
4:L:263:LEU:HB2	4:L:266:TYR:HD2	1.78	0.49
4:M:213:LEU:HD12	4:M:271:ASN:O	2.12	0.49
1:D:276:ASN:ND2	1:D:279:ASN:HD21	2.05	0.49
1:G:300:ASN:O	1:G:302:ASN:N	2.46	0.49
4:L:207:LEU:O	4:L:208:THR:OG1	2.24	0.49
4:L:179:PHE:HD2	4:L:200:LEU:HD21	1.78	0.48
4:H:245:PRO:HG3	4:H:266:TYR:HE1	1.77	0.48
4:M:12:VAL:HG22	4:M:74:LEU:HD21	1.95	0.48
1:G:260:LEU:HD21	1:G:453:ILE:HD11	1.96	0.48
4:L:304:GLU:OE2	4:L:306:TRP:NE1	2.44	0.48
1:I:300:ASN:O	1:I:302:ASN:N	2.46	0.48
1:I:378:CYS:HB2	1:I:383:PHE:HE2	1.79	0.48
4:L:319:LEU:H	4:L:319:LEU:HD23	1.79	0.48
1:D:52:LEU:HD23	1:D:220:PRO:HD3	1.96	0.48
1:G:428:GLN:C	1:G:429:ARG:HG3	2.30	0.48
1:I:61:TYR:HD1	3:J:2:UNK:CA	2.26	0.48
1:I:221:ALA:HB1	2:B:30:UNK:CB	2.44	0.47
4:L:12:VAL:HG13	4:L:74:LEU:HD11	1.96	0.47
4:H:151:LEU:CD1	4:H:184:SER:HB2	2.40	0.47
1:D:230:ASP:OD2	1:D:240:PRO:CD	2.39	0.47
4:M:132:SER:HB2	4:M:133:PRO:HD2	1.96	0.47
4:H:80:ASP:OD1	4:H:81:THR:N	2.41	0.47
4:H:81:THR:OG1	4:H:94:GLN:HG2	2.14	0.47
4:L:344:GLN:HE21	4:L:346:LEU:HD11	1.78	0.47
4:M:319:LEU:HD23	4:M:319:LEU:H	1.79	0.47
1:D:260:LEU:HD21	1:D:453:ILE:HD11	1.96	0.47
1:D:378:CYS:HB2	1:D:383:PHE:HE2	1.79	0.47
1:I:52:LEU:HD23	1:I:220:PRO:HD3	1.96	0.47
1:I:276:ASN:HD21	1:I:279:ASN:HD21	1.62	0.47
4:H:313:LEU:HD22	4:H:347:LEU:HD21	1.95	0.47
1:D:276:ASN:HD21	1:D:279:ASN:HD21	1.61	0.47
4:H:154:SER:HB2	4:H:176:VAL:HG22	1.97	0.47
4:H:296:GLN:HA	4:H:301:LEU:HA	1.97	0.47
4:M:304:GLU:OE2	4:M:306:TRP:NE1	2.44	0.47
1:I:251:ILE:HG23	1:I:482:GLU:HG2	1.97	0.47
3:J:35:UNK:O	3:J:36:UNK:C	2.63	0.47
4:M:188:LYS:O	4:M:291:VAL:HA	2.15	0.47
1:G:378:CYS:HB2	1:G:383:PHE:HE2	1.79	0.47
4:H:264:PRO:HB3	4:H:306:TRP:CD1	2.50	0.47

Continued on next page...

Continued from previous page...

Atom-1	Atom-2	Interatomic distance (Å)	Clash overlap (Å)
1:D:428:GLN:C	1:D:429:ARG:HG3	2.30	0.47
1:G:251:ILE:HG23	1:G:482:GLU:HG2	1.97	0.47
1:D:251:ILE:HG23	1:D:482:GLU:HG2	1.97	0.46
1:I:95:MET:H	1:I:236:THR:HG22	1.80	0.46
1:I:260:LEU:HD21	1:I:453:ILE:HD11	1.96	0.46
2:B:35:UNK:O	2:B:36:UNK:C	2.63	0.46
4:L:268:GLY:HA2	4:L:308:PRO:HD3	1.97	0.46
4:H:173:ASP:OD2	5:O:40:GLY:N	2.42	0.46
4:L:132:SER:HB2	4:L:133:PRO:HD2	1.96	0.46
1:G:346:VAL:HG12	1:G:359:ILE:HG21	1.98	0.46
4:M:268:GLY:HA2	4:M:308:PRO:HD3	1.97	0.46
1:D:396:ILE:CG2	1:D:397:SER:N	2.52	0.46
4:H:295:THR:HA	4:H:359:ILE:HD11	1.98	0.46
1:G:49:GLU:HG2	1:G:99:ASN:ND2	2.30	0.46
4:H:295:THR:HA	4:H:359:ILE:CD1	2.46	0.46
4:L:336:LEU:HD23	4:L:336:LEU:H	1.81	0.46
5:P:65:GLY:H	5:P:95:GLU:C	2.19	0.46
4:M:162:LEU:HD12	4:M:166:LYS:O	2.16	0.46
1:D:95:MET:H	1:D:236:THR:HG22	1.81	0.46
5:O:3:ASP:OD1	5:O:3:ASP:N	2.48	0.46
4:L:188:LYS:O	4:L:291:VAL:HA	2.15	0.46
4:M:12:VAL:HG13	4:M:74:LEU:HD11	1.96	0.46
5:Q:65:GLY:H	5:Q:95:GLU:C	2.19	0.46
1:D:346:VAL:HG12	1:D:359:ILE:HG21	1.98	0.46
1:I:81:PRO:HA	1:I:246:GLN:HE22	1.81	0.46
4:L:162:LEU:HD12	4:L:166:LYS:O	2.16	0.46
4:M:295:THR:HA	4:M:359:ILE:HD12	1.98	0.46
1:I:430:ILE:HG22	1:I:431:GLY:N	2.31	0.46
1:D:81:PRO:HA	1:D:246:GLN:HE22	1.81	0.45
1:G:52:LEU:HD23	1:G:220:PRO:HD3	1.96	0.45
1:G:91:GLU:OE2	1:G:487:LYS:NZ	2.45	0.45
4:H:313:LEU:O	4:H:329:ARG:HG3	2.16	0.45
4:M:336:LEU:HD23	4:M:336:LEU:H	1.81	0.45
4:H:38:GLY:O	4:H:44:LEU:HD12	2.16	0.45
4:L:224:LYS:O	4:L:225:SER:OG	2.29	0.45
5:P:39:LEU:HB2	5:P:67:GLU:HG2	1.99	0.45
1:D:61:TYR:CD2	1:D:62:GLU:HG3	2.51	0.45
4:H:262:ALA:O	4:H:263:LEU:HD23	2.17	0.45
4:L:3:VAL:O	4:L:166:LYS:HE3	2.16	0.45
1:G:430:ILE:HG22	1:G:431:GLY:N	2.31	0.45
1:D:474:ASP:OD1	4:L:40:GLN:CA	2.65	0.45

Continued on next page...

Continued from previous page...

Atom-1	Atom-2	Interatomic distance (Å)	Clash overlap (Å)
1:G:291:PRO:HD2	1:G:291:PRO:O	2.17	0.45
4:H:28:TRP:CH2	4:H:84:CYS:HB2	2.52	0.45
5:O:8:LEU:HD13	5:O:22:TRP:HB3	1.98	0.45
4:M:303:CYS:HB3	4:M:317:LEU:HD21	1.99	0.45
1:I:291:PRO:HD2	1:I:291:PRO:O	2.17	0.45
5:O:10:VAL:HG22	5:O:20:ILE:HG22	1.99	0.45
4:L:295:THR:HA	4:L:359:ILE:HD12	1.98	0.45
5:Q:18:LEU:HG	5:Q:62:LEU:CD1	2.47	0.45
4:M:318:LYS:CB	4:M:324:ALA:HA	2.47	0.45
1:D:291:PRO:HD2	1:D:291:PRO:O	2.17	0.45
4:L:51:LEU:HG	4:L:55:ALA:HB2	1.99	0.45
4:L:61:LEU:HD12	4:L:68:PRO:HG2	1.99	0.45
4:M:61:LEU:HD12	4:M:68:PRO:HG2	1.99	0.45
1:G:95:MET:H	1:G:236:THR:HG22	1.81	0.45
1:I:346:VAL:HG12	1:I:359:ILE:HG21	1.98	0.45
4:M:13:GLU:HA	4:M:69:LEU:O	2.17	0.45
4:M:231:LEU:HD12	4:M:235:GLU:O	2.17	0.45
1:G:61:TYR:CD2	1:G:62:GLU:HG3	2.51	0.44
1:G:81:PRO:HA	1:G:246:GLN:HE22	1.81	0.44
1:I:49:GLU:HG2	1:I:99:ASN:ND2	2.30	0.44
4:L:318:LYS:CB	4:L:324:ALA:HA	2.47	0.44
5:P:18:LEU:HG	5:P:62:LEU:CD1	2.47	0.44
4:M:3:VAL:O	4:M:166:LYS:HE3	2.16	0.44
4:M:226:TRP:CD1	4:M:247:LEU:HD11	2.52	0.44
4:M:224:LYS:O	4:M:225:SER:OG	2.29	0.44
4:H:297:LEU:HD12	4:H:297:LEU:O	2.17	0.44
5:Q:34:ILE:O	5:Q:47:VAL:HA	2.18	0.44
1:D:91:GLU:OE2	1:D:487:LYS:NZ	2.45	0.44
4:L:231:LEU:HD12	4:L:235:GLU:O	2.17	0.44
4:M:51:LEU:HG	4:M:55:ALA:HB2	1.99	0.44
1:I:61:TYR:CD2	1:I:62:GLU:HG3	2.51	0.44
4:L:226:TRP:CD1	4:L:247:LEU:HD11	2.52	0.44
1:D:363:ASN:HD21	1:D:388:SER:CB	2.19	0.44
1:G:393:SER:OG	1:G:395:TRP:NE1	2.48	0.44
1:I:91:GLU:OE2	1:I:487:LYS:NZ	2.45	0.44
4:H:213:LEU:HD13	4:H:272:LEU:HB2	1.99	0.44
1:I:119:CYS:N	1:I:205:CYS:SG	2.91	0.44
4:H:98:PHE:CD2	4:H:161:VAL:HG11	2.53	0.44
4:L:24:ILE:HD11	4:L:67:PHE:HZ	1.83	0.44
4:M:133:PRO:HG3	4:M:155:GLY:H	1.83	0.44
4:H:5:LEU:HA	4:H:96:LEU:O	2.17	0.44

Continued on next page...

Continued from previous page...

Atom-1	Atom-2	Interatomic distance (Å)	Clash overlap (Å)
4:H:156:THR:OG1	4:H:173:ASP:OD1	2.28	0.44
4:L:193:GLN:HA	4:L:261:GLN:HA	2.00	0.44
1:D:119:CYS:N	1:D:205:CYS:SG	2.91	0.43
5:P:10:VAL:HG21	5:P:92:TYR:CG	2.53	0.43
5:P:34:ILE:O	5:P:47:VAL:HA	2.18	0.43
4:M:194:VAL:HB	4:M:259:LEU:HB2	2.00	0.43
4:L:133:PRO:HG3	4:L:155:GLY:H	1.83	0.43
4:L:303:CYS:HB3	4:L:317:LEU:HD21	1.99	0.43
1:G:272:ILE:HG22	1:G:286:VAL:HG22	2.00	0.43
4:H:346:LEU:HA	4:H:355:LEU:O	2.19	0.43
1:D:417:PRO:O	1:D:417:PRO:CD	2.67	0.43
1:G:119:CYS:N	1:G:205:CYS:SG	2.91	0.43
4:L:13:GLU:HA	4:L:69:LEU:O	2.17	0.43
4:L:323:GLU:OE1	4:L:323:GLU:HA	2.18	0.43
5:Q:39:LEU:HB2	5:Q:67:GLU:HG2	1.98	0.43
1:G:335:LYS:HE2	1:G:401:VAL:HG12	2.01	0.43
3:F:35:UNK:O	3:F:36:UNK:C	2.63	0.43
4:H:335:VAL:HG11	4:H:343:TRP:CZ3	2.53	0.43
4:H:186:VAL:O	4:H:289:LEU:HD12	2.19	0.43
4:L:217:ALA:HA	4:L:267:ALA:O	2.19	0.43
1:D:272:ILE:HG22	1:D:286:VAL:HG22	2.00	0.43
1:G:417:PRO:O	1:G:417:PRO:CD	2.67	0.43
1:I:363:ASN:HD21	1:I:388:SER:CB	2.19	0.43
1:I:417:PRO:O	1:I:417:PRO:CD	2.67	0.43
4:H:118:LEU:HB3	4:H:142:LYS:O	2.18	0.43
4:H:227:ILE:HG21	4:H:241:VAL:HG23	2.00	0.43
4:L:58:ARG:HG2	4:L:70:ILE:CD1	2.48	0.43
4:M:58:ARG:HG2	4:M:70:ILE:CD1	2.48	0.43
4:M:193:GLN:HA	4:M:261:GLN:HA	2.00	0.43
5:Q:10:VAL:HG21	5:Q:92:TYR:CG	2.53	0.43
1:I:272:ILE:HG22	1:I:286:VAL:HG22	2.00	0.43
4:L:349:ASP:OD1	4:L:350:SER:N	2.47	0.43
5:P:38:PRO:HG3	5:P:68:TYR:CE1	2.54	0.43
1:D:300:ASN:OD1	1:D:300:ASN:N	2.52	0.42
1:G:460:SER:OG	4:H:33:GLN:CA	2.67	0.42
1:I:446:VAL:HG12	1:I:446:VAL:O	2.20	0.42
4:H:151:LEU:HA	4:H:176:VAL:CG2	2.46	0.42
4:M:323:GLU:HA	4:M:323:GLU:OE1	2.18	0.42
5:Q:37:TRP:HB3	5:Q:45:TYR:HA	2.01	0.42
4:H:208:THR:HG22	4:H:233:ASN:H	1.84	0.42
4:L:194:VAL:HB	4:L:259:LEU:HB2	2.00	0.42

Continued on next page...

Continued from previous page...

Atom-1	Atom-2	Interatomic distance (Å)	Clash overlap (Å)
5:Q:38:PRO:HG3	5:Q:68:TYR:CE1	2.54	0.42
4:L:186:VAL:HG11	4:L:194:VAL:HG13	2.02	0.42
1:G:463:SER:C	1:G:464:THR:HG1	2.08	0.42
1:I:430:ILE:CG2	1:I:431:GLY:N	2.83	0.42
4:H:132:SER:HB2	4:H:133:PRO:HD2	2.01	0.42
4:H:192:GLU:O	4:H:262:ALA:N	2.50	0.42
4:H:341:GLY:O	4:H:361:VAL:HG22	2.20	0.42
1:G:446:VAL:O	1:G:446:VAL:HG12	2.20	0.42
4:L:243:GLN:OE1	4:L:243:GLN:N	2.44	0.42
5:P:37:TRP:HB3	5:P:45:TYR:HA	2.01	0.42
4:M:24:ILE:HD11	4:M:67:PHE:HZ	1.83	0.42
4:M:36:ILE:O	4:M:47:GLY:HA3	2.19	0.42
1:D:100:MET:HE1	1:D:486:TYR:HB2	2.02	0.42
1:G:430:ILE:CG2	1:G:431:GLY:N	2.83	0.42
4:L:163:GLN:CG	4:L:164:ASN:H	2.17	0.42
1:D:49:GLU:HG2	1:D:99:ASN:ND2	2.30	0.41
1:D:446:VAL:O	1:D:446:VAL:HG12	2.20	0.41
4:H:195:GLU:OE1	4:H:256:HIS:NE2	2.53	0.41
4:L:36:ILE:O	4:L:47:GLY:HA3	2.19	0.41
5:Q:18:LEU:HD13	5:Q:70:ILE:HD11	2.02	0.41
1:D:219:ALA:HB2	1:D:225:ILE:HG13	2.03	0.41
4:L:179:PHE:HA	4:L:285:GLN:OE1	2.20	0.41
4:M:355:LEU:HA	4:M:355:LEU:HD23	1.81	0.41
1:G:300:ASN:N	1:G:300:ASN:OD1	2.52	0.41
4:H:314:MET:HA	4:H:329:ARG:HA	2.01	0.41
4:M:179:PHE:HA	4:M:285:GLN:OE1	2.20	0.41
4:M:217:ALA:HA	4:M:267:ALA:O	2.19	0.41
1:D:393:SER:OG	1:D:395:TRP:NE1	2.48	0.41
1:G:357:THR:HG22	1:G:464:THR:HA	2.03	0.41
5:O:34:ILE:HG13	5:O:72:VAL:HG22	2.02	0.41
1:I:298:ARG:HD2	1:I:329:ALA:HB2	2.03	0.41
1:D:108:ILE:HD13	1:D:108:ILE:HA	1.88	0.41
1:I:335:LYS:HE2	1:I:401:VAL:HG12	2.01	0.41
4:L:179:PHE:CD1	4:L:285:GLN:HB2	2.56	0.41
1:G:298:ARG:HD2	1:G:329:ALA:HB2	2.03	0.41
1:I:401:VAL:C	1:I:402:GLN:HG3	2.39	0.41
4:M:226:TRP:H	4:M:242:THR:HG21	1.85	0.41
1:G:100:MET:HE3	1:G:486:TYR:HB2	2.03	0.41
1:I:300:ASN:OD1	1:I:300:ASN:N	2.52	0.41
4:L:225:SER:HB2	4:L:226:TRP:HE3	1.86	0.41
4:L:226:TRP:H	4:L:242:THR:HG21	1.85	0.41

Continued on next page...

Continued from previous page...

Atom-1	Atom-2	Interatomic distance (Å)	Clash overlap (Å)
4:M:179:PHE:CD1	4:M:285:GLN:HB2	2.56	0.41
1:D:357:THR:HG22	1:D:464:THR:HA	2.03	0.41
1:G:219:ALA:HB2	1:G:225:ILE:HG13	2.03	0.41
1:G:270:VAL:HG13	1:G:287:GLN:O	2.21	0.41
1:I:219:ALA:HB2	1:I:225:ILE:HG13	2.03	0.41
4:L:212:GLU:O	4:L:272:LEU:HD12	2.21	0.41
5:P:72:VAL:O	5:P:87:TRP:HA	2.21	0.41
1:D:381:GLU:HG3	1:D:443:ILE:HG21	2.03	0.41
1:G:118:PRO:HB3	1:G:435:TYR:HE1	1.86	0.41
1:I:270:VAL:HG13	1:I:287:GLN:O	2.21	0.41
4:L:238:VAL:HG11	4:L:241:VAL:CG1	2.50	0.41
1:D:355:ASN:C	1:D:357:THR:H	2.25	0.40
1:I:355:ASN:C	1:I:357:THR:H	2.24	0.40
4:M:186:VAL:HG11	4:M:194:VAL:HG13	2.02	0.40
1:G:381:GLU:HG3	1:G:443:ILE:HG21	2.03	0.40
1:I:357:THR:HG22	1:I:464:THR:HA	2.03	0.40
1:I:384:TYR:CD2	1:I:421:LYS:HG3	2.56	0.40
1:G:355:ASN:C	1:G:357:THR:H	2.24	0.40
1:G:384:TYR:CD2	1:G:421:LYS:HG3	2.57	0.40
4:H:151:LEU:HD23	4:H:176:VAL:CG2	2.48	0.40
5:P:18:LEU:HD13	5:P:70:ILE:HD11	2.02	0.40
5:Q:72:VAL:O	5:Q:87:TRP:HA	2.21	0.40
1:D:126:CYS:HA	1:D:196:CYS:HA	2.03	0.40
1:D:207:LYS:NZ	1:D:437:PRO:O	2.53	0.40
4:M:149:LEU:HD23	4:M:149:LEU:HA	1.94	0.40
4:M:162:LEU:HG	4:M:163:GLN:O	2.21	0.40
4:M:238:VAL:HG11	4:M:241:VAL:CG1	2.50	0.40
1:G:61:TYR:CE2	1:G:62:GLU:CG	3.01	0.40
1:G:126:CYS:HA	1:G:196:CYS:HA	2.03	0.40

There are no symmetry-related clashes.

5.3 Torsion angles [i](#)

5.3.1 Protein backbone [i](#)

In the following table, the Percentiles column shows the percent Ramachandran outliers of the chain as a percentile score with respect to all PDB entries followed by that with respect to all EM entries.

The Analysed column shows the number of residues for which the backbone conformation was analysed, and the total number of residues.

Mol	Chain	Analysed	Favoured	Allowed	Outliers	Percentiles	
1	D	352/650 (54%)	303 (86%)	41 (12%)	8 (2%)	6	34
1	G	341/650 (52%)	295 (86%)	39 (11%)	7 (2%)	7	36
1	I	346/650 (53%)	298 (86%)	40 (12%)	8 (2%)	6	34
4	H	352/370 (95%)	333 (95%)	17 (5%)	2 (1%)	25	66
4	L	353/370 (95%)	335 (95%)	18 (5%)	0	100	100
4	M	347/370 (94%)	329 (95%)	18 (5%)	0	100	100
5	O	93/108 (86%)	87 (94%)	5 (5%)	1 (1%)	14	52
5	P	93/108 (86%)	87 (94%)	5 (5%)	1 (1%)	14	52
5	Q	93/108 (86%)	87 (94%)	5 (5%)	1 (1%)	14	52
All	All	2370/3384 (70%)	2154 (91%)	188 (8%)	28 (1%)	17	50

All (28) Ramachandran outliers are listed below:

Mol	Chain	Res	Type
1	D	240	PRO
1	D	301	ASN
1	D	429	ARG
1	G	240	PRO
1	G	301	ASN
1	G	429	ARG
1	I	240	PRO
1	I	301	ASN
1	I	429	ARG
4	H	362	LEU
1	D	299	PRO
1	G	299	PRO
1	I	299	PRO
1	D	87	GLU
1	D	396	ILE
1	G	87	GLU
1	G	396	ILE
1	I	87	GLU
1	I	396	ILE
4	H	164	ASN
1	D	280	ASN
1	I	280	ASN
5	P	25	PRO
5	Q	25	PRO
1	D	234	ASN
1	G	234	ASN

Continued on next page...

Continued from previous page...

Mol	Chain	Res	Type
1	I	234	ASN
5	O	25	PRO

5.3.2 Protein sidechains [i](#)

In the following table, the Percentiles column shows the percent sidechain outliers of the chain as a percentile score with respect to all PDB entries followed by that with respect to all EM entries.

The Analysed column shows the number of residues for which the sidechain conformation was analysed, and the total number of residues.

Mol	Chain	Analysed	Rotameric	Outliers	Percentiles	
1	D	312/568 (55%)	312 (100%)	0	100	100
1	G	309/568 (54%)	309 (100%)	0	100	100
1	I	310/568 (55%)	310 (100%)	0	100	100
4	H	259/331 (78%)	255 (98%)	4 (2%)	65	80
4	L	263/331 (80%)	260 (99%)	3 (1%)	73	84
4	M	259/331 (78%)	256 (99%)	3 (1%)	71	83
5	O	72/91 (79%)	71 (99%)	1 (1%)	67	80
5	P	71/91 (78%)	71 (100%)	0	100	100
5	Q	71/91 (78%)	71 (100%)	0	100	100
All	All	1926/2970 (65%)	1915 (99%)	11 (1%)	86	92

All (11) residues with a non-rotameric sidechain are listed below:

Mol	Chain	Res	Type
4	H	26	PHE
4	H	202	PHE
4	H	276	LEU
4	H	284	HIS
5	O	45	TYR
4	L	53	ASP
4	L	91	GLU
4	L	319	LEU
4	M	53	ASP
4	M	91	GLU
4	M	319	LEU

Sometimes sidechains can be flipped to improve hydrogen bonding and reduce clashes. All (20) such sidechains are listed below:

Mol	Chain	Res	Type
1	D	103	GLN
1	D	276	ASN
1	D	279	ASN
1	D	280	ASN
1	D	356	ASN
1	D	363	ASN
1	D	422	GLN
1	D	462	ASN
1	G	103	GLN
1	G	356	ASN
1	G	363	ASN
1	G	422	GLN
1	G	462	ASN
1	I	103	GLN
1	I	276	ASN
1	I	279	ASN
1	I	280	ASN
1	I	356	ASN
1	I	363	ASN
1	I	422	GLN

5.3.3 RNA [i](#)

There are no RNA molecules in this entry.

5.4 Non-standard residues in protein, DNA, RNA chains [i](#)

There are no non-standard protein/DNA/RNA residues in this entry.

5.5 Carbohydrates [i](#)

There are no monosaccharides in this entry.

5.6 Ligand geometry [i](#)

There are no ligands in this entry.

5.7 Other polymers [i](#)

There are no such residues in this entry.

5.8 Polymer linkage issues [i](#)

There are no chain breaks in this entry.

6 Map visualisation [i](#)

This section contains visualisations of the EMDB entry EMD-25581. These allow visual inspection of the internal detail of the map and identification of artifacts.

No raw map or half-maps were deposited for this entry and therefore no images, graphs, etc. pertaining to the raw map can be shown.

6.1 Orthogonal projections [i](#)

6.1.1 Primary map

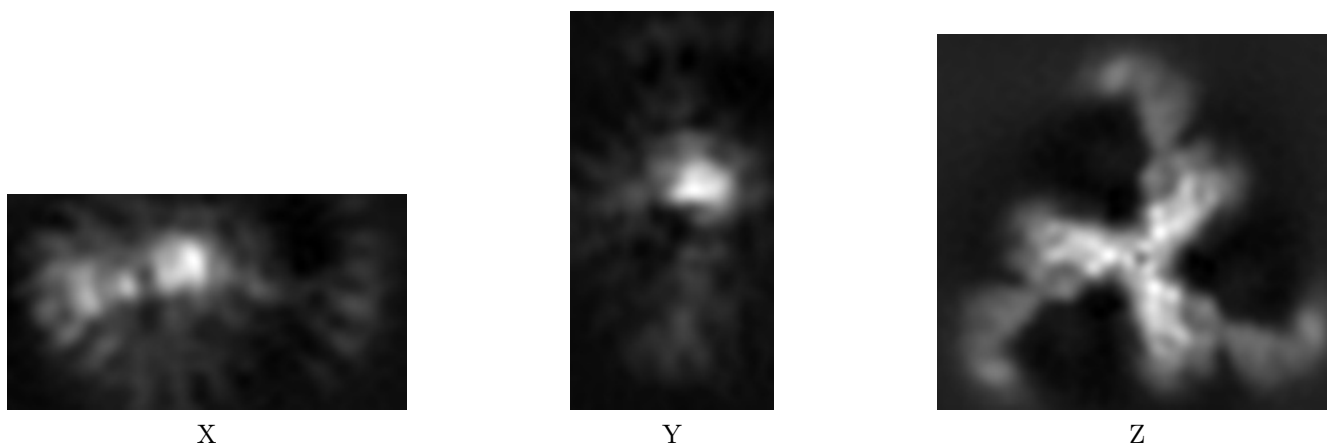

The images above show the map projected in three orthogonal directions.

6.2 Central slices [i](#)

6.2.1 Primary map

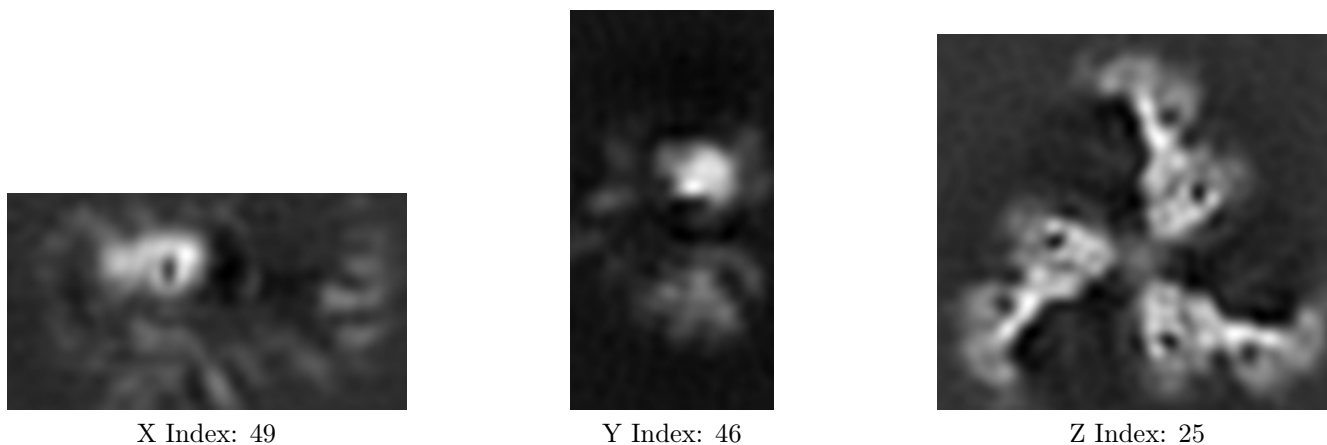

The images above show central slices of the map in three orthogonal directions.

6.3 Largest variance slices [i](#)

6.3.1 Primary map



X Index: 54



Y Index: 38

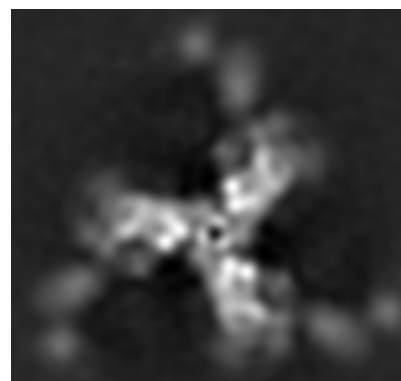

Z Index: 31

The images above show the largest variance slices of the map in three orthogonal directions.

6.4 Orthogonal surface views [i](#)

6.4.1 Primary map

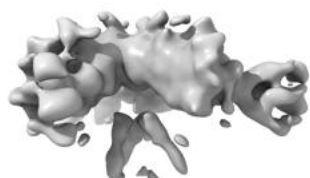

X



Y



Z

The images above show the 3D surface view of the map at the recommended contour level 4.42. These images, in conjunction with the slice images, may facilitate assessment of whether an appropriate contour level has been provided.

6.5 Mask visualisation [i](#)

This section shows the 3D surface view of the primary map at 50% transparency overlaid with the specified mask at 0% transparency

A mask typically either:

- Encompasses the whole structure
- Separates out a domain, a functional unit, a monomer or an area of interest from a larger structure

6.5.1 emd_25581_msk_1.map [i](#)

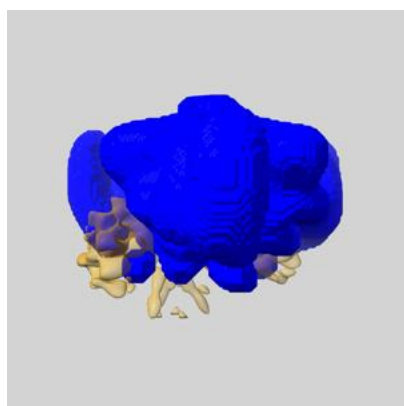

X

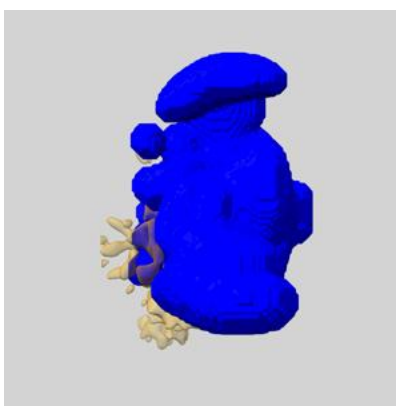

Y

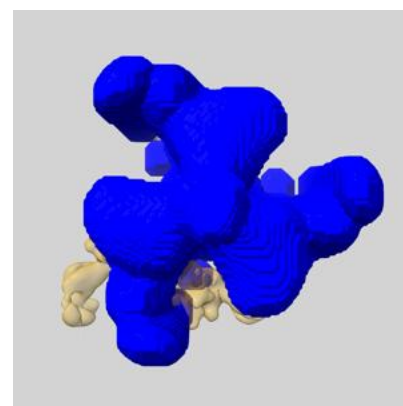

Z

7 Map analysis [i](#)

This section contains the results of statistical analysis of the map.

7.1 Map-value distribution [i](#)

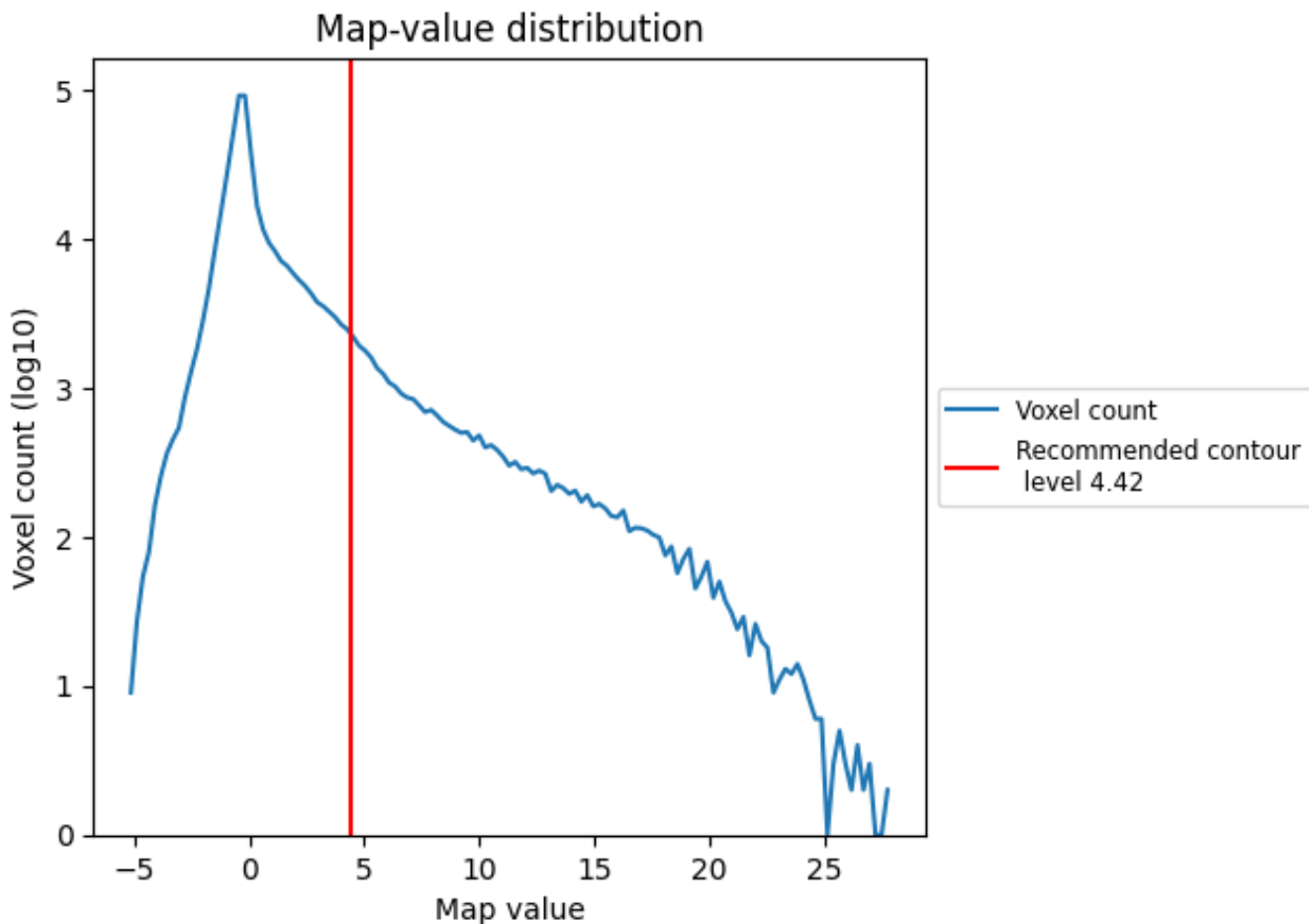

The map-value distribution is plotted in 128 intervals along the x-axis. The y-axis is logarithmic. A spike in this graph at zero usually indicates that the volume has been masked.

7.2 Volume estimate [i](#)

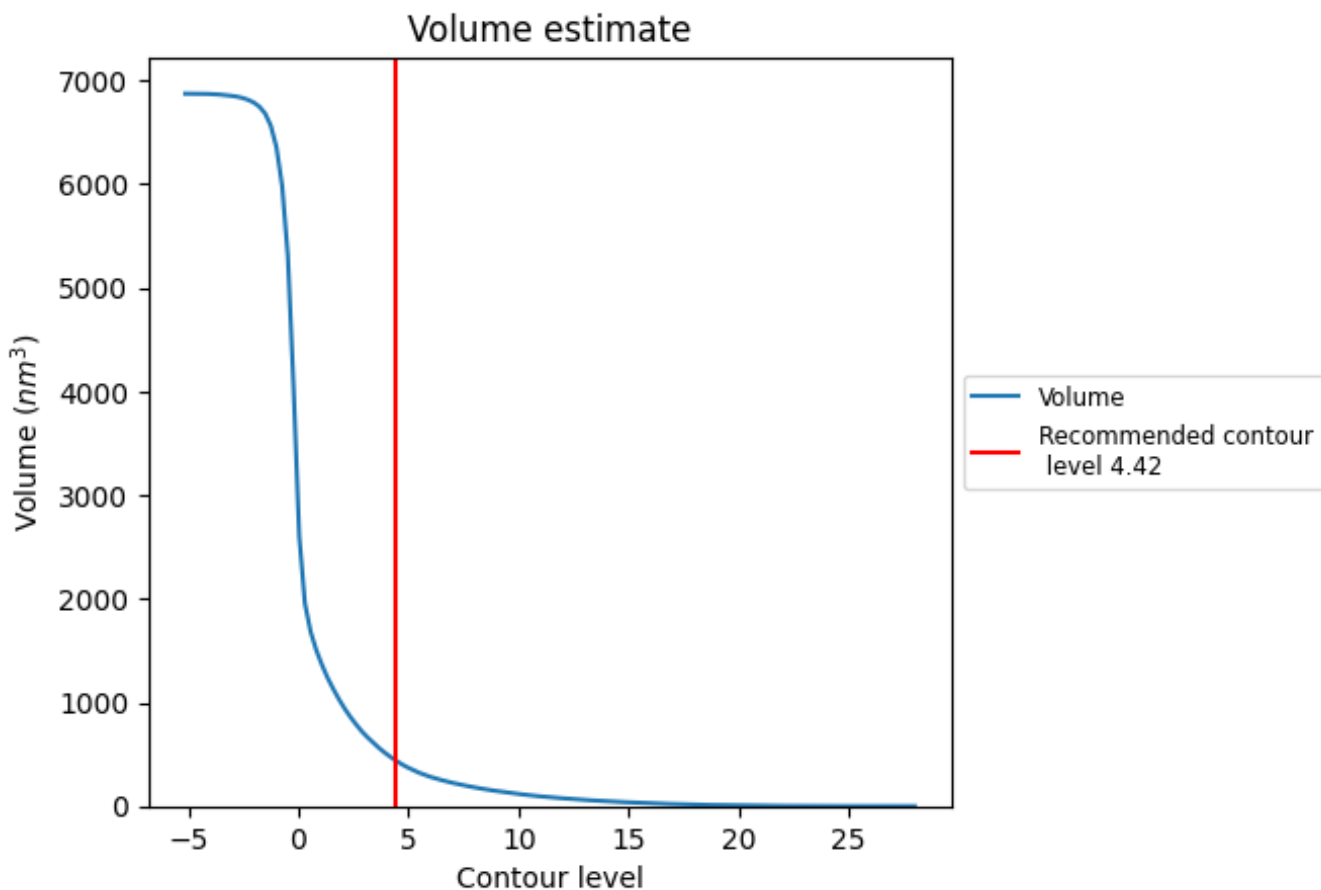

The volume at the recommended contour level is 441 nm^3 ; this corresponds to an approximate mass of 398 kDa.

The volume estimate graph shows how the enclosed volume varies with the contour level. The recommended contour level is shown as a vertical line and the intersection between the line and the curve gives the volume of the enclosed surface at the given level.

7.3 Rotationally averaged power spectrum [i](#)

This section was not generated. The rotationally averaged power spectrum is only generated for cubic maps.

8 Fourier-Shell correlation [i](#)

Fourier-Shell Correlation (FSC) is the most commonly used method to estimate the resolution of single-particle and subtomogram-averaged maps. The shape of the curve depends on the imposed symmetry, mask and whether or not the two 3D reconstructions used were processed from a common reference. The reported resolution is shown as a black line. A curve is displayed for the half-bit criterion in addition to lines showing the 0.143 gold standard cut-off and 0.5 cut-off.

8.1 FSC [i](#)

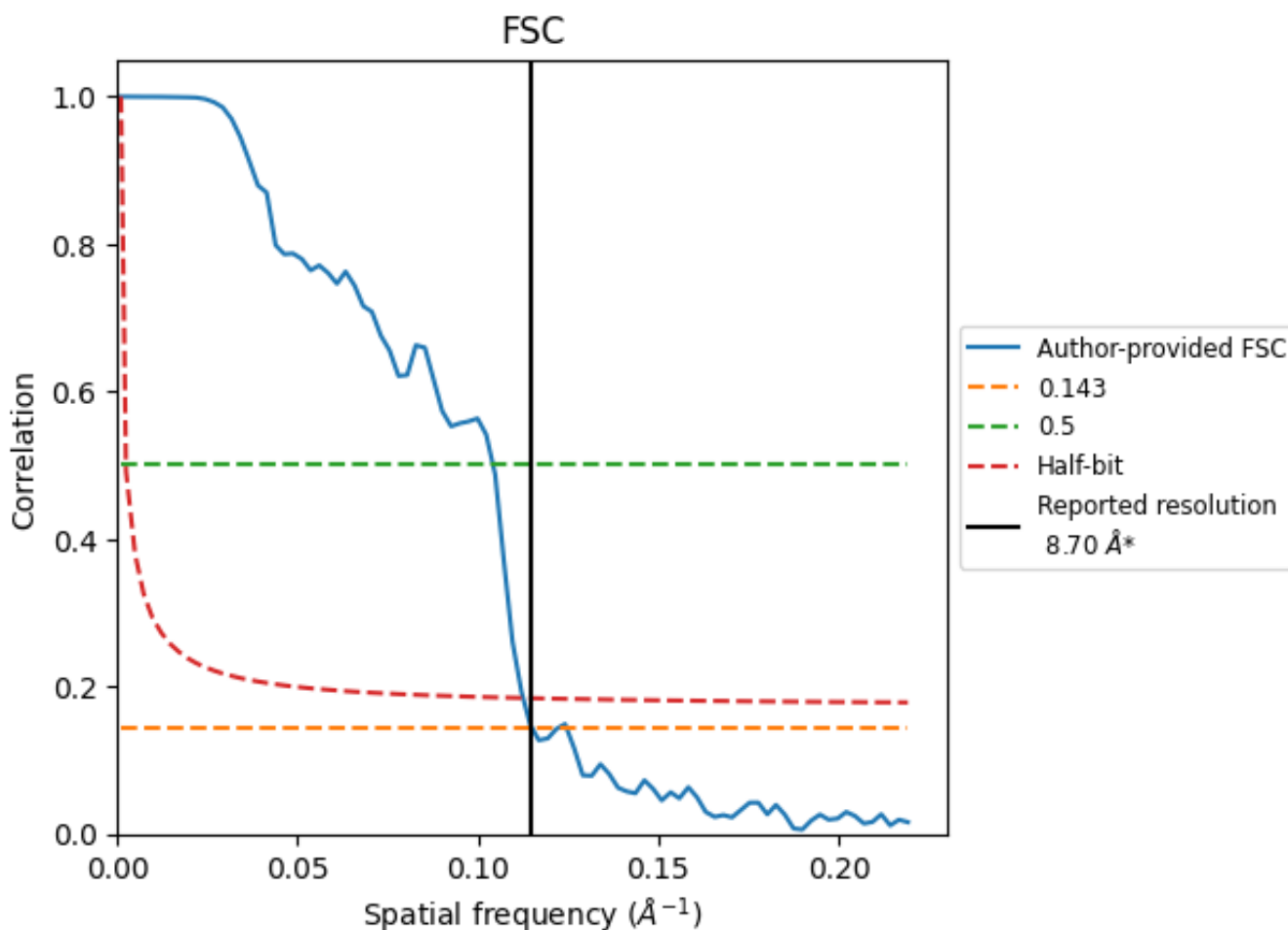

*Reported resolution corresponds to spatial frequency of 0.115 Å⁻¹

8.2 Resolution estimates [i](#)

Resolution estimate (Å)	Estimation criterion (FSC cut-off)		
	0.143	0.5	Half-bit
Reported by author	8.70	-	-
Author-provided FSC curve	8.69	9.60	8.89
Unmasked-calculated*	-	-	-

*Resolution estimate based on FSC curve calculated by comparison of deposited half-maps.

9 Map-model fit [i](#)

This section contains information regarding the fit between EMDB map EMD-25581 and PDB model 7T0O. Per-residue inclusion information can be found in section 3 on page 6.

9.1 Map-model overlay [i](#)

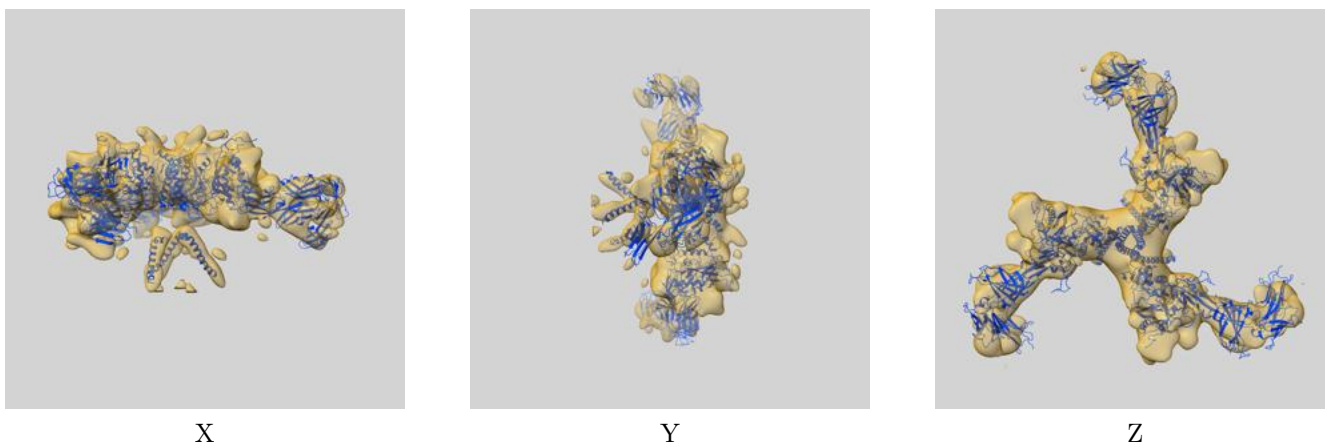

The images above show the 3D surface view of the map at the recommended contour level 4.42 at 50% transparency in yellow overlaid with a ribbon representation of the model coloured in blue. These images allow for the visual assessment of the quality of fit between the atomic model and the map.

9.2 Q-score mapped to coordinate model [\(i\)](#)

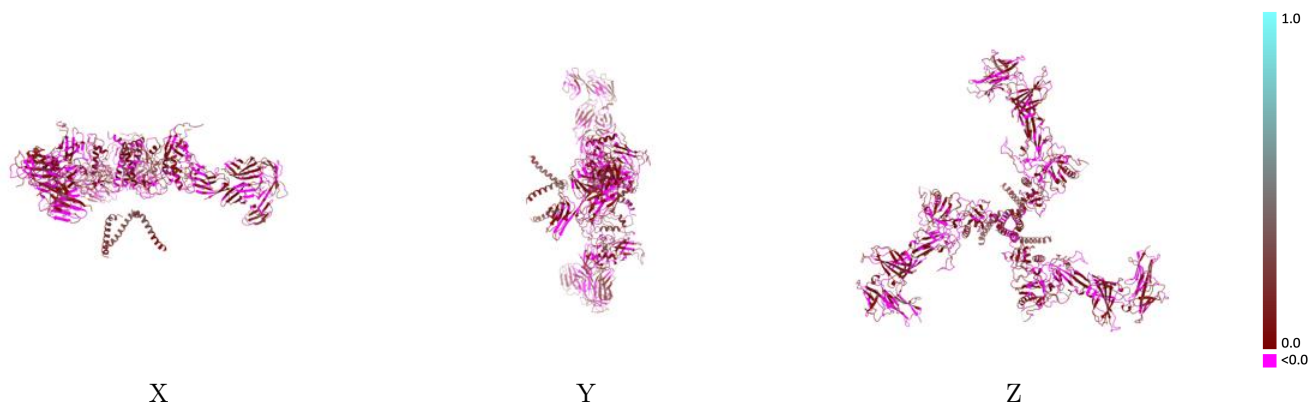

The images above show the model with each residue coloured according to its Q-score. This shows their resolvability in the map with higher Q-score values reflecting better resolvability. Please note: Q-score is calculating the resolvability of atoms, and thus high values are only expected at resolutions at which atoms can be resolved. Low Q-score values may therefore be expected for many entries.

9.3 Atom inclusion mapped to coordinate model [\(i\)](#)

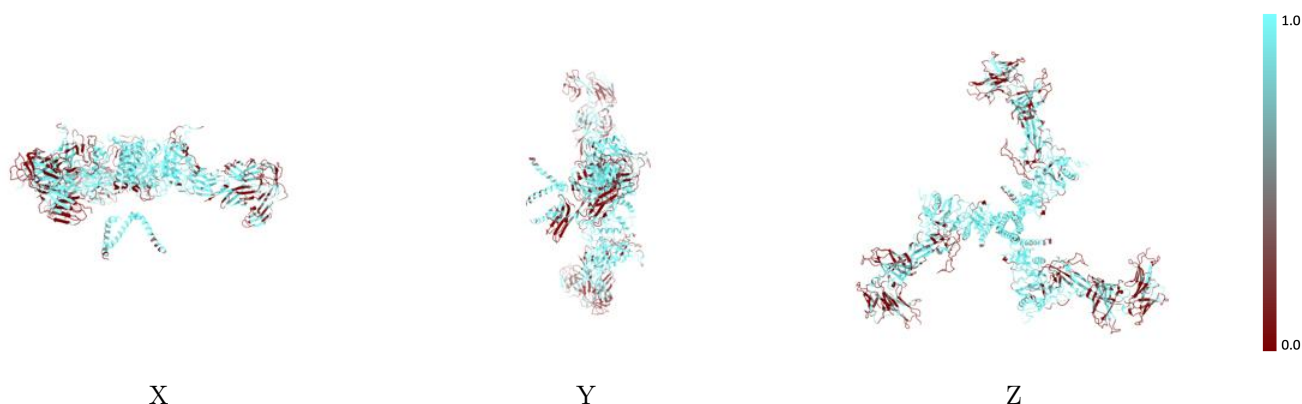

The images above show the model with each residue coloured according to its atom inclusion. This shows to what extent they are inside the map at the recommended contour level (4.42).



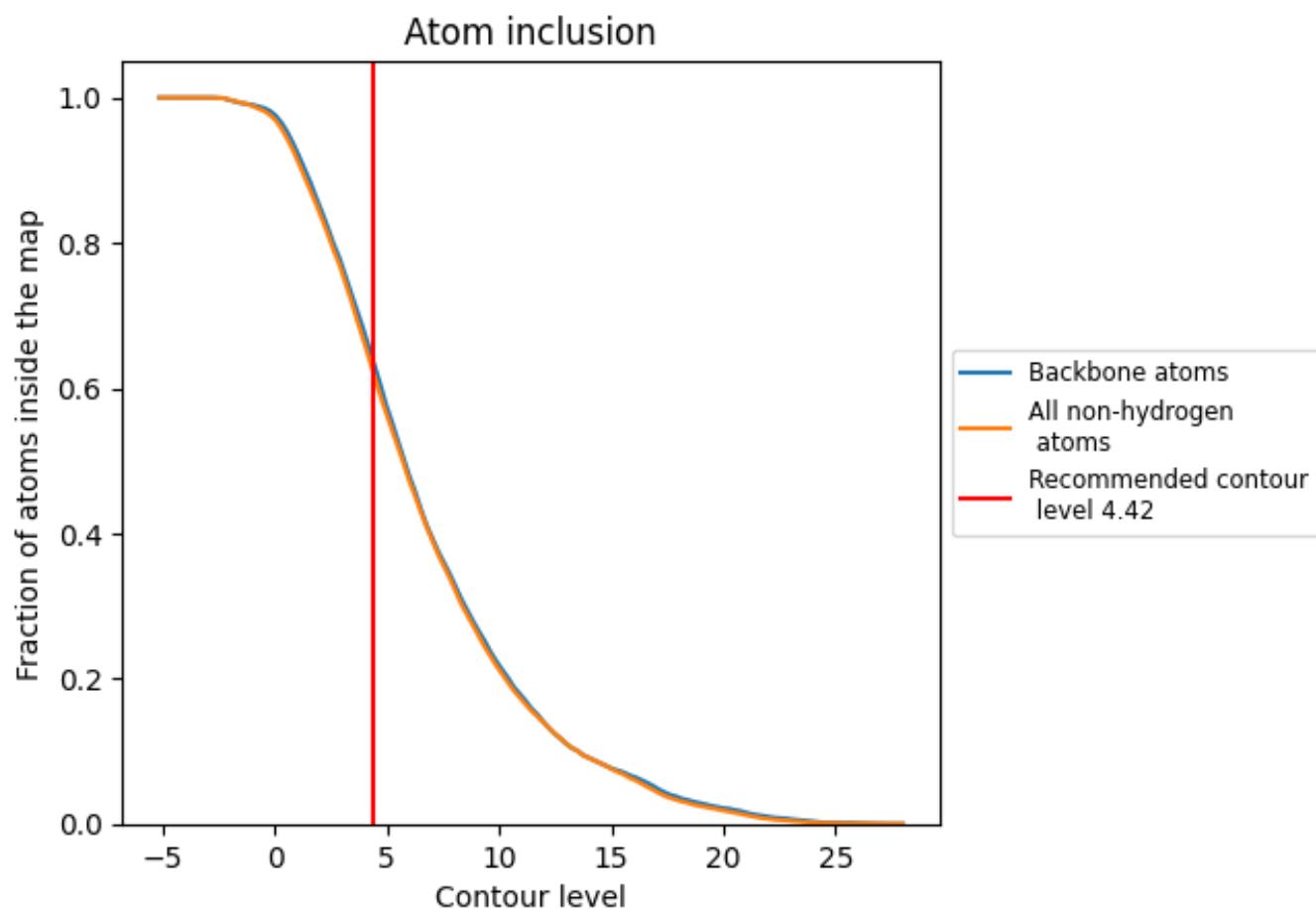





























9.4 Atom inclusion [i](#)



At the recommended contour level, 63% of all backbone atoms, 62% of all non-hydrogen atoms, are inside the map.

9.5 Map-model fit summary

The table lists the average atom inclusion at the recommended contour level (4.42) and Q-score for the entire model and for each chain.

Chain	Atom inclusion	Q-score
All	 0.6186	 0.0370
B	 0.8686	 0.0560
D	 0.7570	 0.0340
F	 0.8865	 0.0490
G	 0.7437	 0.0300
H	 0.5277	 0.0400
I	 0.7498	 0.0330
J	 0.8757	 0.0240
K	 0.9091	 0.2490
L	 0.4781	 0.0290
M	 0.4758	 0.0260
N	 0.7333	 0.1970
O	 0.4820	 0.0340
P	 0.4093	 0.0240
Q	 0.4369	 0.0400
R	 0.8000	 0.2010

