



Full wwPDB X-ray Structure Validation Report ⓘ

Feb 17, 2024 – 04:07 PM EST

PDB ID : 3T5V
Title : Sac3:Thp1:Sem1 complex
Authors : Stewart, M.; Ellisdon, A.M.
Deposited on : 2011-07-28
Resolution : 2.90 Å(reported)

This is a Full wwPDB X-ray Structure Validation Report for a publicly released PDB entry.

We welcome your comments at validation@mail.wwpdb.org

A user guide is available at

<https://www.wwpdb.org/validation/2017/XrayValidationReportHelp>

with specific help available everywhere you see the ⓘ symbol.

The types of validation reports are described at

<http://www.wwpdb.org/validation/2017/FAQs#types>.

The following versions of software and data (see [references ⓘ](#)) were used in the production of this report:

MolProbity : 4.02b-467
Xtriage (Phenix) : 1.13
EDS : 2.36
Percentile statistics : 20191225.v01 (using entries in the PDB archive December 25th 2019)
Refmac : 5.8.0158
CCP4 : 7.0.044 (Gargrove)
Ideal geometry (proteins) : Engh & Huber (2001)
Ideal geometry (DNA, RNA) : Parkinson et al. (1996)
Validation Pipeline (wwPDB-VP) : 2.36

1 Overall quality at a glance

The following experimental techniques were used to determine the structure:

X-RAY DIFFRACTION

The reported resolution of this entry is 2.90 Å.

Percentile scores (ranging between 0-100) for global validation metrics of the entry are shown in the following graphic. The table shows the number of entries on which the scores are based.

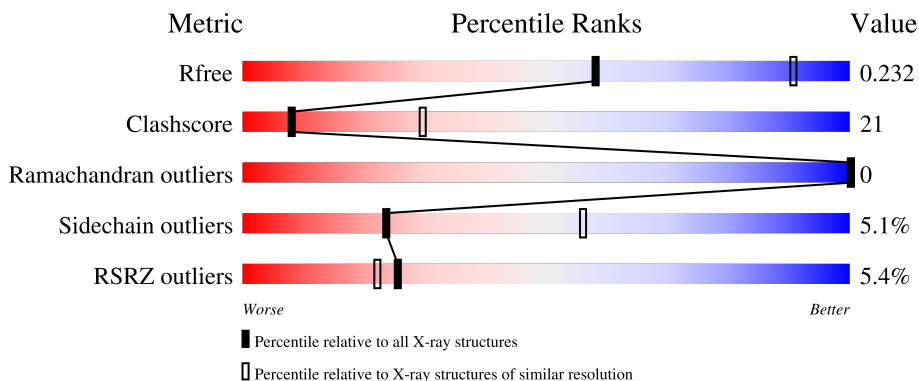

Metric	Whole archive (#Entries)	Similar resolution (#Entries, resolution range(Å))
R_{free}	130704	1957 (2.90-2.90)
Clashscore	141614	2172 (2.90-2.90)
Ramachandran outliers	138981	2115 (2.90-2.90)
Sidechain outliers	138945	2117 (2.90-2.90)
RSRZ outliers	127900	1906 (2.90-2.90)

The table below summarises the geometric issues observed across the polymeric chains and their fit to the electron density. The red, orange, yellow and green segments of the lower bar indicate the fraction of residues that contain outliers for ≥ 3 , 2, 1 and 0 types of geometric quality criteria respectively. A grey segment represents the fraction of residues that are not modelled. The numeric value for each fraction is indicated below the corresponding segment, with a dot representing fractions $\leq 5\%$. The upper red bar (where present) indicates the fraction of residues that have poor fit to the electron density. The numeric value is given above the bar.

Mol	Chain	Length	Quality of chain
1	A	316	
1	D	316	
2	B	455	
2	E	455	
3	C	89	

Continued on next page...

Continued from previous page...

Mol	Chain	Length	Quality of chain
3	F	89	 <p>A horizontal bar chart representing the quality of chain. The bar is divided into four segments: a red segment (15%), a green segment (29%), a yellow segment (19%), and a grey segment (47%). The percentages are labeled below each segment.</p>

2 Entry composition [i](#)

There are 3 unique types of molecules in this entry. The entry contains 26347 atoms, of which 13172 are hydrogens and 0 are deuteriums.

In the tables below, the ZeroOcc column contains the number of atoms modelled with zero occupancy, the AltConf column contains the number of residues with at least one atom in alternate conformation and the Trace column contains the number of residues modelled with at most 2 atoms.

- Molecule 1 is a protein called Nuclear mRNA export protein SAC3.

Mol	Chain	Residues	Atoms						ZeroOcc	AltConf	Trace
			Total	C	H	N	O	S			
1	A	299	4957	1582	2484	426	452	13	731	0	0
1	D	299	4947	1580	2478	425	451	13	728	0	0

There are 4 discrepancies between the modelled and reference sequences:

Chain	Residue	Modelled	Actual	Comment	Reference
A	248	GLY	-	expression tag	UNP P46674
A	249	SER	-	expression tag	UNP P46674
D	248	GLY	-	expression tag	UNP P46674
D	249	SER	-	expression tag	UNP P46674

- Molecule 2 is a protein called Nuclear mRNA export protein THP1.

Mol	Chain	Residues	Atoms						ZeroOcc	AltConf	Trace
			Total	C	H	N	O	S			
2	B	450	7409	2372	3731	636	653	17	1181	0	0
2	E	448	7385	2366	3719	634	649	17	1177	0	0

- Molecule 3 is a protein called 26S proteasome complex subunit SEM1.

Mol	Chain	Residues	Atoms					ZeroOcc	AltConf	Trace
			Total	C	H	N	O			
3	C	56	903	296	422	75	110	101	0	0
3	F	47	746	250	338	63	95	71	0	0

3 Residue-property plots [i](#)

These plots are drawn for all protein, RNA, DNA and oligosaccharide chains in the entry. The first graphic for a chain summarises the proportions of the various outlier classes displayed in the second graphic. The second graphic shows the sequence view annotated by issues in geometry and electron density. Residues are color-coded according to the number of geometric quality criteria for which they contain at least one outlier: green = 0, yellow = 1, orange = 2 and red = 3 or more. A red dot above a residue indicates a poor fit to the electron density ($RSRZ > 2$). Stretches of 2 or more consecutive residues without any outlier are shown as a green connector. Residues present in the sample, but not in the model, are shown in grey.

- Molecule 1: Nuclear mRNA export protein SAC3

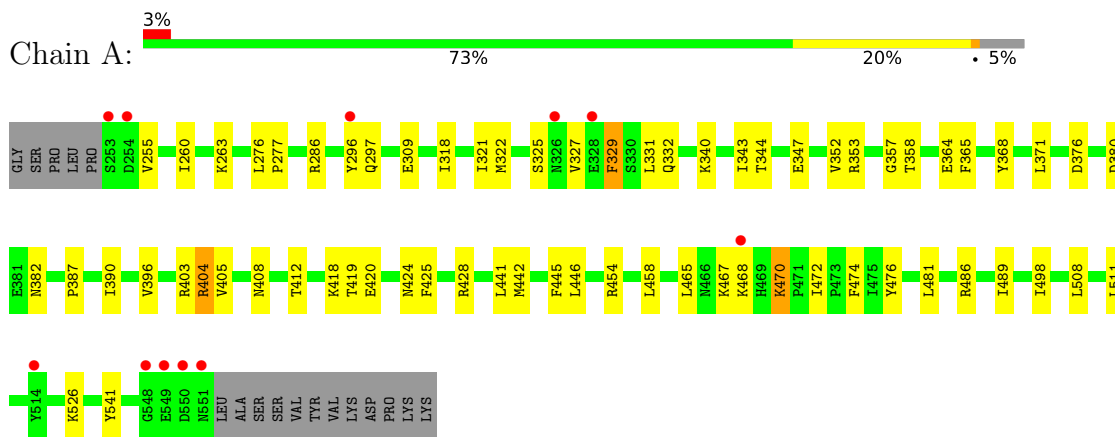

- Molecule 1: Nuclear mRNA export protein SAC3

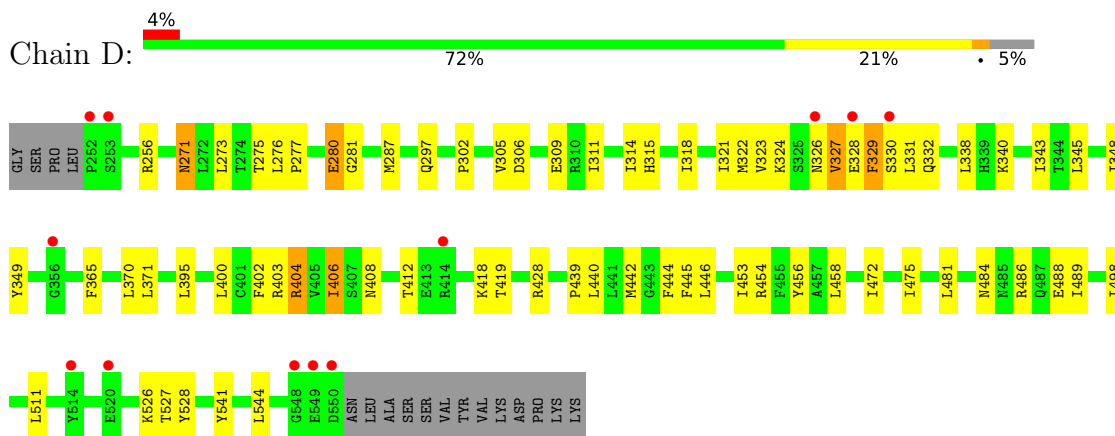

- Molecule 2: Nuclear mRNA export protein THP1

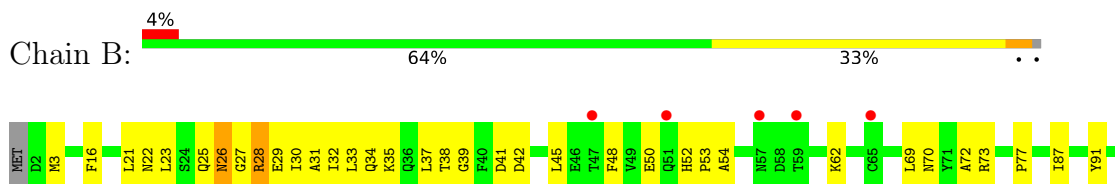

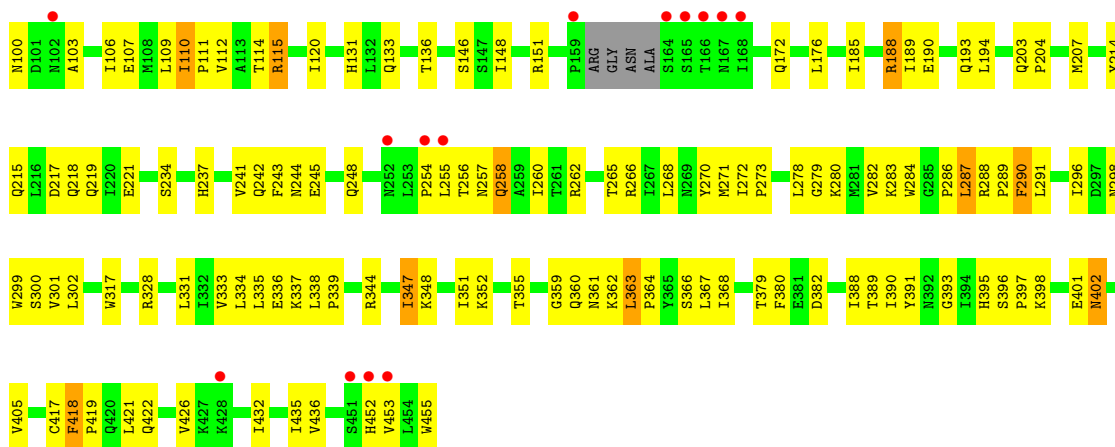

• Molecule 2: Nuclear mRNA export protein THP1

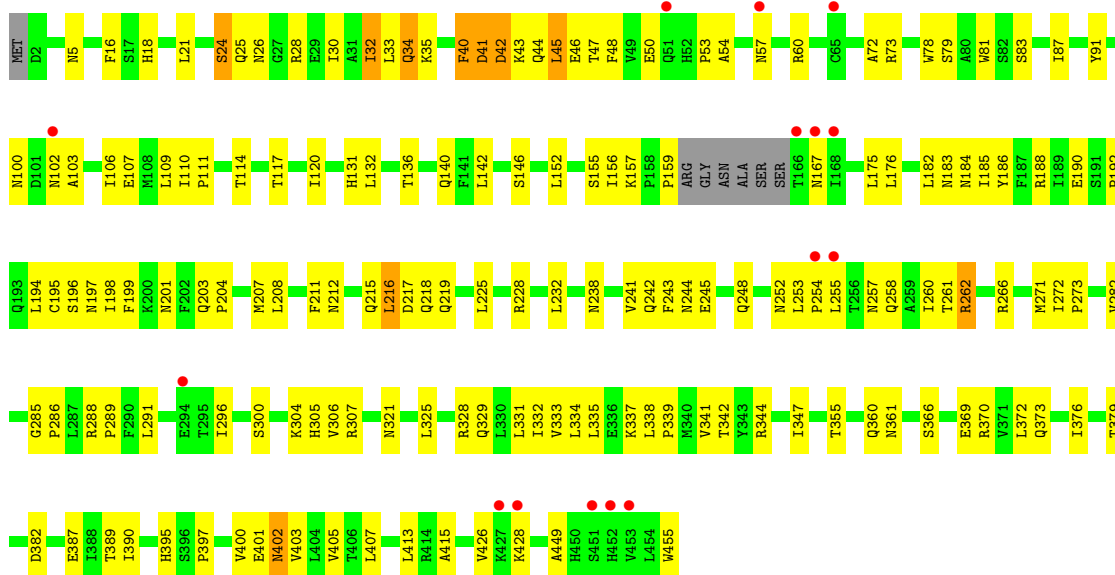

• Molecule 3: 26S proteasome complex subunit SEM1

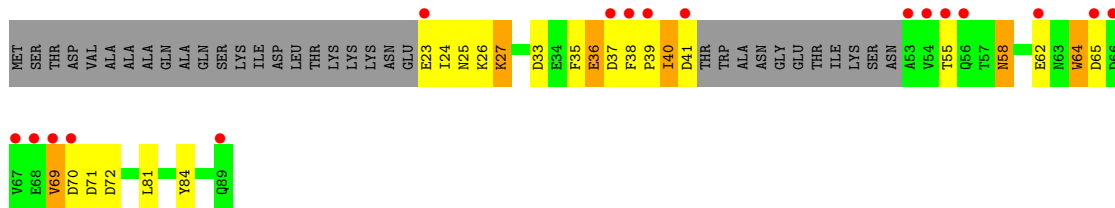

• Molecule 3: 26S proteasome complex subunit SEM1

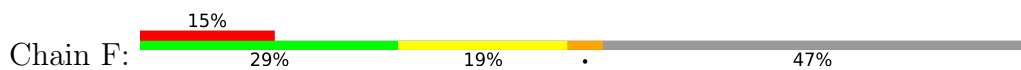

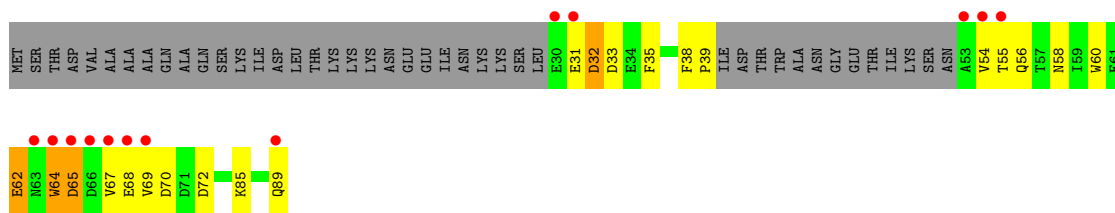

4 Data and refinement statistics

Property	Value	Source
Space group	P 41 2 2	Depositor
Cell constants a, b, c, α , β , γ	164.77Å 164.77Å 276.79Å 90.00° 90.00° 90.00°	Depositor
Resolution (Å)	20.00 – 2.90 20.00 – 2.90	Depositor EDS
% Data completeness (in resolution range)	99.6 (20.00-2.90) 100.0 (20.00-2.90)	Depositor EDS
R_{merge}	0.16	Depositor
R_{sym}	(Not available)	Depositor
$\langle I/\sigma(I) \rangle$ ¹	1.88 (at 2.88Å)	Xtrriage
Refinement program	REFMAC 5.6.0116	Depositor
R, R_{free}	0.208 , 0.231 0.210 , 0.232	Depositor DCC
R_{free} test set	4224 reflections (5.00%)	wwPDB-VP
Wilson B-factor (Å ²)	70.9	Xtrriage
Anisotropy	0.018	Xtrriage
Bulk solvent k_{sol} (e/Å ³), B_{sol} (Å ²)	0.34 , 39.0	EDS
L-test for twinning ²	$\langle L \rangle = 0.48$, $\langle L^2 \rangle = 0.31$	Xtrriage
Estimated twinning fraction	No twinning to report.	Xtrriage
F_o, F_c correlation	0.95	EDS
Total number of atoms	26347	wwPDB-VP
Average B, all atoms (Å ²)	45.0	wwPDB-VP

Xtrriage's analysis on translational NCS is as follows: *The largest off-origin peak in the Patterson function is 2.19% of the height of the origin peak. No significant pseudotranslation is detected.*

¹Intensities estimated from amplitudes.

²Theoretical values of $\langle |L| \rangle$, $\langle L^2 \rangle$ for acentric reflections are 0.5, 0.333 respectively for untwinned datasets, and 0.375, 0.2 for perfectly twinned datasets.

5 Model quality [i](#)

5.1 Standard geometry [i](#)

The Z score for a bond length (or angle) is the number of standard deviations the observed value is removed from the expected value. A bond length (or angle) with $|Z| > 5$ is considered an outlier worth inspection. RMSZ is the root-mean-square of all Z scores of the bond lengths (or angles).

Mol	Chain	Bond lengths		Bond angles	
		RMSZ	# Z >5	RMSZ	# Z >5
1	A	0.63	0/2527	0.55	0/3415
1	D	0.60	0/2523	0.54	0/3409
2	B	0.57	0/3767	0.54	0/5118
2	E	0.58	0/3755	0.55	0/5102
3	C	0.54	0/488	0.56	0/659
3	F	0.52	0/415	0.58	0/562
All	All	0.59	0/13475	0.55	0/18265

There are no bond length outliers.

There are no bond angle outliers.

There are no chirality outliers.

There are no planarity outliers.

5.2 Too-close contacts [i](#)

In the following table, the Non-H and H(model) columns list the number of non-hydrogen atoms and hydrogen atoms in the chain respectively. The H(added) column lists the number of hydrogen atoms added and optimized by MolProbity. The Clashes column lists the number of clashes within the asymmetric unit, whereas Symm-Clashes lists symmetry-related clashes.

Mol	Chain	Non-H	H(model)	H(added)	Clashes	Symm-Clashes
1	A	2473	2484	2473	58	0
1	D	2469	2478	2468	88	0
2	B	3678	3731	3714	218	0
2	E	3666	3719	3704	174	0
3	C	481	422	420	47	0
3	F	408	338	340	32	0
All	All	13175	13172	13119	559	0

The all-atom clashscore is defined as the number of clashes found per 1000 atoms (including hydrogen atoms). The all-atom clashscore for this structure is 21.

All (559) close contacts within the same asymmetric unit are listed below, sorted by their clash magnitude.

Atom-1	Atom-2	Interatomic distance (Å)	Clash overlap (Å)
2:B:282:VAL:CG2	2:B:287:LEU:HD11	1.50	1.42
2:B:379:THR:HG22	2:B:382:ASP:OD2	1.18	1.32
2:E:159:PRO:HG3	2:E:207:MET:CE	1.60	1.32
2:B:29:GLU:O	2:B:33:LEU:HD13	1.12	1.27
2:B:110:ILE:C	2:B:110:ILE:HD12	1.60	1.22
2:B:29:GLU:O	2:B:33:LEU:CD1	1.92	1.17
2:B:45:LEU:HD21	2:B:69:LEU:HD23	1.18	1.16
2:E:159:PRO:CG	2:E:207:MET:CE	2.24	1.16
2:B:110:ILE:HD12	2:B:111:PRO:N	1.60	1.15
2:B:282:VAL:HG21	2:B:287:LEU:CD1	1.77	1.14
1:A:472:ILE:HD13	1:A:508:LEU:HD12	1.29	1.13
2:B:363:LEU:HD23	2:B:363:LEU:N	1.61	1.13
1:D:322:MET:CE	1:D:329:PHE:CD2	2.32	1.11
2:E:217:ASP:HB2	3:F:38:PHE:CD2	1.85	1.11
1:A:472:ILE:HD13	1:A:508:LEU:CD1	1.83	1.09
2:B:45:LEU:HD21	2:B:69:LEU:CD2	1.83	1.08
2:B:282:VAL:HG21	2:B:287:LEU:HD11	1.16	1.08
1:D:322:MET:HE3	1:D:329:PHE:CD2	1.87	1.07
2:B:35:LYS:O	2:B:38:THR:HG22	1.53	1.05
2:B:27:GLY:O	2:B:30:ILE:HG22	1.55	1.05
1:D:322:MET:HE3	1:D:329:PHE:HD2	1.21	1.04
1:D:329:PHE:CZ	1:D:331:LEU:HG	1.94	1.03
2:E:159:PRO:HG3	2:E:207:MET:HE1	1.33	1.02
2:B:282:VAL:CG2	2:B:287:LEU:CD1	2.35	1.01
2:E:188:ARG:HH12	3:F:31:GLU:HB2	1.22	1.01
1:D:329:PHE:CE1	1:D:331:LEU:HD12	1.96	1.01
2:B:28:ARG:HG3	2:B:28:ARG:HH11	1.18	1.00
2:B:25:GLN:HG3	3:F:31:GLU:OE2	1.59	1.00
2:E:45:LEU:HD21	2:E:73:ARG:HE	1.27	0.98
2:B:363:LEU:HD23	2:B:363:LEU:H	1.12	0.97
2:B:379:THR:CG2	2:B:382:ASP:OD2	2.12	0.97
2:E:159:PRO:CD	2:E:207:MET:HE3	1.95	0.97
2:E:40:PHE:HD2	2:E:44:GLN:HB3	1.28	0.96
3:C:37:ASP:O	3:C:39:PRO:HD3	1.65	0.96
2:B:217:ASP:OD2	3:C:38:PHE:HB3	1.66	0.94
2:B:110:ILE:C	2:B:110:ILE:CD1	2.35	0.94
2:B:25:GLN:CG	3:F:31:GLU:OE2	2.15	0.94
2:B:282:VAL:HG22	2:B:287:LEU:HD11	1.47	0.93
2:B:363:LEU:N	2:B:363:LEU:CD2	2.32	0.93
2:E:159:PRO:CG	2:E:207:MET:HE3	1.97	0.91

Continued on next page...

Continued from previous page...

Atom-1	Atom-2	Interatomic distance (Å)	Clash overlap (Å)
2:B:45:LEU:CD2	2:B:69:LEU:HD23	2.01	0.91
2:B:217:ASP:HB2	3:C:38:PHE:HD1	1.36	0.90
2:E:252:ASN:HA	3:F:54:VAL:HG11	1.53	0.90
1:D:329:PHE:CE1	1:D:330:SER:C	2.44	0.90
1:A:472:ILE:CD1	1:A:508:LEU:HD12	2.00	0.90
2:E:41:ASP:CG	2:E:44:GLN:OE1	2.10	0.90
1:D:329:PHE:CD1	1:D:330:SER:N	2.42	0.88
2:E:152:LEU:O	2:E:155:SER:OG	1.90	0.88
1:D:322:MET:HE2	1:D:329:PHE:CD2	2.07	0.88
2:E:40:PHE:CD2	2:E:44:GLN:HB3	2.09	0.87
2:E:211:PHE:CE2	2:E:219:GLN:HG2	2.09	0.87
1:D:329:PHE:HD1	1:D:330:SER:N	1.72	0.86
1:D:322:MET:HE2	1:D:329:PHE:CE2	2.10	0.85
1:D:329:PHE:CE1	1:D:331:LEU:HA	2.12	0.85
2:B:110:ILE:HD12	2:B:111:PRO:CA	2.07	0.85
1:D:329:PHE:CZ	1:D:331:LEU:CG	2.60	0.84
2:B:34:GLN:O	2:B:38:THR:N	2.11	0.83
2:E:159:PRO:HG3	2:E:207:MET:HE3	1.52	0.83
2:E:379:THR:HG22	2:E:382:ASP:CG	1.98	0.83
2:E:379:THR:HG22	2:E:382:ASP:OD2	1.79	0.83
3:C:41:ASP:HB3	3:F:39:PRO:HB3	1.59	0.83
2:B:45:LEU:O	2:B:48:PHE:HB3	1.79	0.83
1:D:329:PHE:CE1	1:D:330:SER:O	2.32	0.83
1:D:322:MET:CE	1:D:329:PHE:CE2	2.62	0.82
2:B:28:ARG:HH11	2:B:28:ARG:CG	1.92	0.81
1:D:329:PHE:HE1	1:D:331:LEU:HA	1.43	0.81
1:D:329:PHE:CZ	1:D:331:LEU:CD1	2.63	0.81
2:B:110:ILE:CD1	2:B:111:PRO:N	2.44	0.80
2:B:50:GLU:HG2	2:B:62:LYS:HD3	1.63	0.80
1:A:408:ASN:OD1	1:A:424:ASN:CB	2.30	0.80
2:B:30:ILE:HD11	2:B:72:ALA:HA	1.62	0.80
2:E:188:ARG:HH12	3:F:31:GLU:CB	1.96	0.79
2:B:3:MET:HG2	2:B:33:LEU:HD11	1.63	0.78
2:B:221:GLU:OE1	3:C:38:PHE:HZ	1.66	0.77
2:B:3:MET:HG2	2:B:33:LEU:CD1	2.13	0.77
2:E:41:ASP:OD1	2:E:44:GLN:N	2.16	0.77
2:B:351:ILE:HG21	2:B:435:ILE:HD13	1.67	0.76
1:D:329:PHE:CD1	1:D:329:PHE:C	2.59	0.76
3:C:23:GLU:O	3:C:24:ILE:CG2	2.33	0.76
2:E:41:ASP:OD1	2:E:44:GLN:OE1	2.03	0.76
1:D:329:PHE:CD1	1:D:330:SER:C	2.60	0.75

Continued on next page...

Continued from previous page...

Atom-1	Atom-2	Interatomic distance (Å)	Clash overlap (Å)
1:D:329:PHE:HE1	1:D:330:SER:O	1.67	0.75
2:E:258:GLN:O	2:E:262:ARG:HD3	1.85	0.74
1:D:329:PHE:CZ	1:D:331:LEU:HD12	2.21	0.74
2:E:5:ASN:OD1	2:E:48:PHE:HZ	1.69	0.74
2:E:188:ARG:NH1	3:F:31:GLU:HB2	2.00	0.74
2:B:221:GLU:OE1	3:C:38:PHE:CZ	2.41	0.74
1:D:322:MET:CE	1:D:329:PHE:HD2	1.88	0.73
1:D:329:PHE:HZ	1:D:331:LEU:HG	1.50	0.73
2:B:217:ASP:HB2	3:C:38:PHE:CD1	2.23	0.73
3:C:55:THR:CG2	3:C:55:THR:O	2.37	0.72
2:B:426:VAL:HG11	2:B:435:ILE:HD11	1.70	0.71
2:B:272:ILE:HB	2:B:273:PRO:HD3	1.72	0.71
2:B:33:LEU:N	2:B:33:LEU:HD12	2.05	0.71
2:B:27:GLY:O	2:B:30:ILE:CG2	2.36	0.71
2:E:190:GLU:OE1	2:E:190:GLU:HA	1.89	0.71
1:A:276:LEU:HD21	1:A:318:ILE:HG12	1.73	0.70
3:C:40:ILE:O	3:C:41:ASP:CB	2.39	0.70
2:B:33:LEU:O	2:B:37:LEU:HG	1.91	0.70
3:C:23:GLU:O	3:C:24:ILE:HG23	1.92	0.70
1:D:329:PHE:CE1	1:D:331:LEU:CA	2.74	0.70
2:E:328:ARG:NH1	3:F:33:ASP:OD1	2.25	0.69
2:E:159:PRO:CG	2:E:207:MET:HE2	2.18	0.69
2:B:106:ILE:O	2:B:110:ILE:HG23	1.93	0.68
2:B:379:THR:HG22	2:B:382:ASP:CG	2.10	0.68
2:E:252:ASN:CA	3:F:54:VAL:HG11	2.22	0.68
3:F:64:TRP:CD1	3:F:64:TRP:C	2.66	0.68
3:C:40:ILE:O	3:C:41:ASP:CG	2.31	0.68
1:D:329:PHE:HE1	1:D:330:SER:C	1.94	0.68
2:E:41:ASP:OD1	2:E:41:ASP:C	2.32	0.68
2:E:5:ASN:OD1	2:E:48:PHE:CZ	2.47	0.67
1:A:408:ASN:OD1	1:A:424:ASN:HB2	1.95	0.67
1:D:527:THR:CG2	1:D:528:TYR:N	2.57	0.67
1:D:329:PHE:CE1	1:D:331:LEU:N	2.63	0.66
2:E:188:ARG:NH1	3:F:31:GLU:CB	2.58	0.66
2:B:25:GLN:O	2:B:26:ASN:HB3	1.95	0.66
1:A:458:LEU:HD13	1:A:481:LEU:HD11	1.78	0.66
2:B:176:LEU:CD2	2:B:218:GLN:HB3	2.27	0.65
1:A:476:TYR:OH	2:B:401:GLU:OE1	2.14	0.65
2:B:298:ASN:O	2:B:301:VAL:HG12	1.96	0.65
3:C:64:TRP:CD1	3:C:64:TRP:C	2.69	0.65
2:B:380:PHE:CD1	2:B:388:ILE:HD12	2.31	0.65

Continued on next page...

Continued from previous page...

Atom-1	Atom-2	Interatomic distance (Å)	Clash overlap (Å)
2:E:258:GLN:HG3	2:E:262:ARG:HD2	1.79	0.65
1:A:276:LEU:HD23	1:A:321:ILE:HD12	1.79	0.65
3:C:71:ASP:OD1	3:C:72:ASP:N	2.29	0.65
2:B:32:ILE:O	2:B:35:LYS:HG2	1.97	0.64
2:B:190:GLU:OE1	2:B:190:GLU:HA	1.98	0.64
2:E:159:PRO:HD3	2:E:207:MET:HE3	1.78	0.64
2:E:217:ASP:OD1	2:E:218:GLN:N	2.30	0.64
2:E:372:LEU:O	2:E:376:ILE:HG12	1.97	0.64
2:B:248:GLN:HG3	3:C:55:THR:HG23	1.78	0.64
2:E:258:GLN:O	2:E:262:ARG:CD	2.46	0.64
2:E:40:PHE:HB3	2:E:44:GLN:HB2	1.79	0.64
1:D:527:THR:HG22	1:D:528:TYR:N	2.12	0.64
1:A:276:LEU:HD23	1:A:321:ILE:CD1	2.28	0.63
3:C:23:GLU:OE1	3:C:23:GLU:N	2.31	0.63
1:D:400:LEU:O	1:D:404:ARG:HD2	1.99	0.63
2:B:288:ARG:N	2:B:289:PRO:HD2	2.14	0.62
3:C:26:LYS:HG3	2:E:32:ILE:HG23	1.81	0.62
3:C:41:ASP:OD1	3:C:41:ASP:C	2.37	0.62
2:B:146:SER:HB3	2:B:185:ILE:HG21	1.80	0.62
2:E:361:ASN:HB3	2:E:428:LYS:HG2	1.81	0.62
2:B:21:LEU:HD13	2:B:87:ILE:HG23	1.81	0.62
2:B:26:ASN:C	2:B:29:GLU:OE1	2.38	0.62
2:B:33:LEU:CD1	2:B:33:LEU:N	2.63	0.62
2:E:45:LEU:CD2	2:E:73:ARG:HE	2.07	0.61
2:E:331:LEU:C	2:E:331:LEU:HD13	2.21	0.61
1:A:255:VAL:HG21	1:A:296:TYR:CD1	2.35	0.61
2:E:16:PHE:CE2	2:E:109:LEU:HD13	2.35	0.61
2:B:418:PHE:N	2:B:418:PHE:CD1	2.68	0.61
2:B:110:ILE:N	2:B:111:PRO:CD	2.64	0.61
2:B:254:PRO:HG2	2:B:255:LEU:HD12	1.83	0.61
2:E:40:PHE:CD2	2:E:44:GLN:CB	2.83	0.61
1:A:353:ARG:NH1	3:C:25:ASN:OD1	2.34	0.61
2:B:110:ILE:O	2:B:114:THR:HG23	2.01	0.61
2:B:217:ASP:CB	3:C:38:PHE:HD1	2.11	0.61
2:E:131:HIS:CE1	2:E:132:LEU:HG	2.35	0.61
3:C:23:GLU:C	3:C:24:ILE:HG23	2.22	0.60
2:E:45:LEU:N	2:E:45:LEU:CD1	2.63	0.60
2:E:402:ASN:C	2:E:402:ASN:HD22	2.03	0.60
1:D:408:ASN:ND2	1:D:456:TYR:HB3	2.15	0.60
2:E:266:ARG:NH1	3:F:32:ASP:O	2.34	0.60
2:E:34:GLN:NE2	2:E:72:ALA:O	2.33	0.60

Continued on next page...

Continued from previous page...

Atom-1	Atom-2	Interatomic distance (Å)	Clash overlap (Å)
2:E:203:GLN:HB2	2:E:204:PRO:HD3	1.83	0.60
1:D:458:LEU:HD13	1:D:481:LEU:HD11	1.83	0.60
1:D:331:LEU:HD12	1:D:331:LEU:N	2.17	0.60
2:E:186:TYR:CD1	2:E:194:LEU:HD12	2.37	0.60
2:B:110:ILE:HD12	2:B:110:ILE:O	1.98	0.59
2:B:131:HIS:HA	2:B:136:THR:HG22	1.84	0.59
2:B:217:ASP:OD2	3:C:38:PHE:CB	2.47	0.59
2:B:282:VAL:HG22	2:B:287:LEU:CD1	2.19	0.59
3:C:55:THR:O	3:C:55:THR:HG22	2.00	0.59
1:A:408:ASN:OD1	1:A:424:ASN:CG	2.40	0.59
2:B:291:LEU:HB2	2:B:296:ILE:HD11	1.83	0.59
2:E:288:ARG:N	2:E:289:PRO:HD2	2.17	0.59
3:C:58:ASN:ND2	3:C:62:GLU:OE1	2.34	0.59
2:B:3:MET:CG	2:B:33:LEU:HD11	2.31	0.59
2:B:361:ASN:ND2	2:B:426:VAL:O	2.35	0.59
2:E:41:ASP:OD1	2:E:43:LYS:N	2.36	0.59
2:B:217:ASP:OD2	3:C:38:PHE:CD1	2.56	0.59
2:B:266:ARG:NH2	3:C:36:GLU:OE2	2.35	0.59
1:D:329:PHE:HE1	1:D:331:LEU:CA	2.10	0.59
2:E:114:THR:O	2:E:117:THR:HG22	2.02	0.59
2:E:253:LEU:HD12	2:E:254:PRO:HD2	1.84	0.59
1:A:465:LEU:HD11	1:A:472:ILE:HD11	1.83	0.59
1:A:380:ASP:OD1	1:A:404:ARG:NH2	2.35	0.59
2:E:361:ASN:ND2	2:E:428:LYS:HE3	2.18	0.58
1:D:329:PHE:CD1	1:D:330:SER:O	2.55	0.58
2:B:426:VAL:CG1	2:B:435:ILE:HD11	2.33	0.58
2:B:29:GLU:CD	2:B:29:GLU:H	2.06	0.58
2:B:273:PRO:HG3	2:B:299:TRP:CH2	2.38	0.58
1:D:329:PHE:CD1	1:D:331:LEU:HD12	2.38	0.58
2:E:216:LEU:HD23	2:E:219:GLN:OE1	2.03	0.58
2:B:34:GLN:HG3	2:B:73:ARG:O	2.04	0.58
2:E:335:LEU:HD21	2:E:390:ILE:HB	1.85	0.58
2:E:146:SER:HB3	2:E:185:ILE:HG21	1.84	0.57
1:A:467:LYS:O	1:A:468:LYS:HG2	2.04	0.57
2:E:5:ASN:CG	2:E:48:PHE:HZ	2.07	0.57
2:E:291:LEU:HB2	2:E:296:ILE:HD11	1.87	0.57
2:B:34:GLN:CG	2:B:73:ARG:O	2.52	0.57
2:B:355:THR:HG22	2:B:360:GLN:O	2.04	0.57
2:B:42:ASP:OD1	2:B:70:ASN:OD1	2.23	0.57
2:E:156:ILE:HD13	2:E:175:LEU:CD1	2.35	0.57
1:A:428:ARG:HD3	2:B:393:GLY:O	2.05	0.57

Continued on next page...

Continued from previous page...

Atom-1	Atom-2	Interatomic distance (Å)	Clash overlap (Å)
1:D:321:ILE:HD11	1:D:541:TYR:CZ	2.40	0.57
2:E:159:PRO:CD	2:E:207:MET:CE	2.70	0.57
2:E:176:LEU:HD23	2:E:218:GLN:HB3	1.87	0.57
2:B:28:ARG:CG	2:B:28:ARG:NH1	2.57	0.57
2:B:364:PRO:O	2:B:368:ILE:HD12	2.05	0.57
2:E:30:ILE:O	2:E:34:GLN:HB3	2.05	0.57
2:B:26:ASN:C	2:B:26:ASN:OD1	2.44	0.56
2:B:28:ARG:HG3	2:B:28:ARG:NH1	2.00	0.56
2:B:106:ILE:HD12	2:B:107:GLU:N	2.20	0.56
2:B:110:ILE:HD12	2:B:111:PRO:HA	1.84	0.56
1:D:276:LEU:HD11	1:D:318:ILE:HG12	1.86	0.56
2:E:258:GLN:C	2:E:262:ARG:HD3	2.25	0.56
1:D:498:ILE:HD11	1:D:511:LEU:HD13	1.86	0.56
2:E:184:ASN:O	2:E:188:ARG:HG2	2.05	0.56
1:D:454:ARG:HG2	1:D:481:LEU:HB3	1.88	0.56
2:E:208:LEU:HD12	2:E:208:LEU:C	2.25	0.56
2:E:307:ARG:NH2	3:F:67:VAL:O	2.39	0.56
2:E:355:THR:HG22	2:E:360:GLN:O	2.05	0.56
1:D:271:ASN:OD1	1:D:271:ASN:N	2.39	0.56
1:D:305:VAL:HG12	1:D:348:ILE:HG21	1.88	0.56
2:B:203:GLN:HB3	2:B:204:PRO:HD3	1.88	0.55
3:C:23:GLU:O	3:C:24:ILE:HG22	2.06	0.55
2:B:402:ASN:C	2:B:402:ASN:HD22	2.10	0.55
1:D:276:LEU:C	1:D:276:LEU:HD13	2.26	0.55
2:B:396:SER:OG	2:B:397:PRO:HD2	2.06	0.55
2:E:387:GLU:HG3	2:E:389:THR:CG2	2.36	0.55
2:B:23:LEU:HD22	2:B:30:ILE:HG21	1.87	0.55
1:D:419:THR:OG1	2:E:337:LYS:NZ	2.40	0.55
2:E:156:ILE:HD13	2:E:175:LEU:HD13	1.89	0.55
1:A:322:MET:HE2	1:A:329:PHE:HB3	1.89	0.54
2:E:216:LEU:CD2	2:E:219:GLN:OE1	2.54	0.54
2:B:176:LEU:HD23	2:B:218:GLN:CB	2.37	0.54
2:E:45:LEU:HD21	2:E:73:ARG:NE	2.10	0.54
2:B:244:ASN:HA	2:B:271:MET:HE1	1.89	0.54
2:E:100:ASN:OD1	2:E:103:ALA:N	2.41	0.54
2:B:335:LEU:HD21	2:B:390:ILE:HB	1.89	0.54
2:E:32:ILE:O	2:E:35:LYS:HB3	2.08	0.54
1:A:390:ILE:O	1:A:396:VAL:HG21	2.07	0.54
2:E:43:LYS:O	2:E:47:THR:N	2.21	0.54
2:B:112:VAL:HG22	2:B:115:ARG:NH2	2.22	0.54
2:B:338:LEU:N	2:B:339:PRO:CD	2.71	0.54

Continued on next page...

Continued from previous page...

Atom-1	Atom-2	Interatomic distance (Å)	Clash overlap (Å)
1:D:404:ARG:HH21	2:E:332:ILE:CG2	2.22	0.53
2:E:183:ASN:CG	2:E:198:ILE:HD11	2.29	0.53
2:B:194:LEU:N	2:B:194:LEU:HD12	2.23	0.53
3:F:54:VAL:HG22	3:F:55:THR:N	2.23	0.53
1:A:404:ARG:NH1	2:B:336:GLU:OE2	2.33	0.53
2:B:26:ASN:O	2:B:29:GLU:OE1	2.26	0.53
3:C:40:ILE:O	3:C:41:ASP:HB3	2.08	0.53
1:D:287:MET:HE1	1:D:314:ILE:HB	1.91	0.53
2:E:21:LEU:HD13	2:E:87:ILE:HG23	1.91	0.53
1:D:329:PHE:CE1	1:D:331:LEU:CD1	2.79	0.53
2:E:257:ASN:OD1	2:E:258:GLN:N	2.40	0.53
2:E:106:ILE:HD12	2:E:107:GLU:N	2.24	0.53
2:B:42:ASP:HB2	2:B:73:ARG:HH22	1.72	0.53
2:B:258:GLN:HB3	2:B:262:ARG:NH1	2.24	0.53
2:B:328:ARG:NH1	3:C:33:ASP:OD1	2.42	0.53
1:D:322:MET:HE3	1:D:329:PHE:CE2	2.34	0.53
2:E:338:LEU:N	2:E:339:PRO:CD	2.71	0.53
2:B:367:LEU:HD13	3:C:84:TYR:CD2	2.44	0.52
2:E:43:LYS:HA	2:E:46:GLU:HB3	1.91	0.52
1:A:476:TYR:CZ	2:B:419:PRO:HB3	2.44	0.52
2:B:194:LEU:CD1	2:B:194:LEU:H	2.22	0.52
2:E:339:PRO:HA	2:E:342:THR:CG2	2.39	0.52
2:E:156:ILE:HG21	2:E:175:LEU:HD13	1.91	0.52
1:A:420:GLU:O	2:B:337:LYS:HD2	2.09	0.52
1:D:276:LEU:N	1:D:277:PRO:CD	2.72	0.52
2:B:33:LEU:CD1	2:B:33:LEU:H	2.22	0.52
2:E:45:LEU:HD13	2:E:45:LEU:H	1.75	0.52
2:E:183:ASN:ND2	2:E:198:ILE:HD11	2.25	0.52
2:E:34:GLN:NE2	2:E:73:ARG:O	2.42	0.52
2:E:159:PRO:HG2	2:E:207:MET:HE2	1.91	0.52
2:B:34:GLN:HG3	2:B:72:ALA:O	2.09	0.52
2:B:355:THR:O	2:B:359:GLY:N	2.42	0.52
1:D:331:LEU:CD1	1:D:331:LEU:N	2.73	0.52
2:B:110:ILE:N	2:B:111:PRO:HD3	2.25	0.52
2:E:40:PHE:CD1	2:E:40:PHE:N	2.78	0.51
2:B:25:GLN:HG2	3:F:31:GLU:OE2	2.04	0.51
2:B:29:GLU:OE1	2:B:29:GLU:N	2.30	0.51
2:E:40:PHE:N	2:E:40:PHE:HD1	2.08	0.51
2:B:401:GLU:O	2:B:405:VAL:HG23	2.11	0.51
2:B:27:GLY:C	2:B:30:ILE:HG22	2.27	0.51
2:B:302:LEU:HB2	2:B:317:TRP:CE2	2.46	0.51

Continued on next page...

Continued from previous page...

Atom-1	Atom-2	Interatomic distance (Å)	Clash overlap (Å)
2:B:257:ASN:OD1	2:B:258:GLN:N	2.44	0.51
2:E:53:PRO:O	2:E:54:ALA:HB3	2.10	0.51
2:E:131:HIS:HA	2:E:136:THR:HG22	1.93	0.51
2:B:41:ASP:OD1	2:B:42:ASP:N	2.44	0.50
2:B:176:LEU:CD2	2:B:218:GLN:CB	2.89	0.50
2:B:258:GLN:HG3	2:E:111:PRO:HB3	1.92	0.50
2:B:29:GLU:C	2:B:33:LEU:HD13	2.13	0.50
1:D:395:LEU:CD2	1:D:439:PRO:HG2	2.41	0.50
2:B:289:PRO:HG2	2:B:290:PHE:CE1	2.46	0.50
1:D:404:ARG:N	1:D:404:ARG:HH11	2.09	0.50
2:E:335:LEU:CD2	2:E:390:ILE:HD12	2.42	0.50
2:E:372:LEU:O	2:E:376:ILE:CG1	2.60	0.50
1:D:323:VAL:HG12	1:D:324:LYS:N	2.26	0.50
2:B:26:ASN:HA	2:B:29:GLU:OE1	2.12	0.50
1:D:371:LEU:HD22	1:D:446:LEU:HD21	1.94	0.50
2:E:43:LYS:O	2:E:44:GLN:C	2.49	0.50
2:E:42:ASP:OD1	2:E:73:ARG:NH2	2.44	0.49
2:B:189:ILE:HG22	2:B:190:GLU:N	2.27	0.49
3:F:69:VAL:HG13	3:F:70:ASP:N	2.26	0.49
2:B:215:GLN:OE1	3:C:40:ILE:HG22	2.12	0.49
2:E:203:GLN:HA	2:E:455:TRP:HZ2	1.77	0.49
2:B:37:LEU:HD22	2:B:45:LEU:CD1	2.42	0.49
2:B:388:ILE:N	2:B:388:ILE:HD13	2.27	0.49
2:E:45:LEU:N	2:E:45:LEU:HD13	2.26	0.49
2:E:325:LEU:O	2:E:328:ARG:O	2.29	0.49
1:D:302:PRO:O	1:D:305:VAL:HG22	2.12	0.49
2:E:25:GLN:O	2:E:26:ASN:HB3	2.12	0.49
3:F:62:GLU:CD	3:F:62:GLU:H	2.16	0.49
1:A:371:LEU:HD22	1:A:446:LEU:HD21	1.93	0.49
2:B:190:GLU:HG3	3:C:27:LYS:HE3	1.94	0.49
1:A:408:ASN:OD1	1:A:424:ASN:HA	2.12	0.49
1:A:467:LYS:O	1:A:468:LYS:CG	2.60	0.49
2:B:77:PRO:HB2	2:E:81:TRP:CH2	2.48	0.49
2:B:279:GLY:O	3:C:64:TRP:HZ3	1.96	0.49
2:E:186:TYR:CE1	2:E:194:LEU:HD12	2.48	0.49
2:E:243:PHE:C	2:E:271:MET:HE2	2.33	0.49
2:E:212:ASN:HA	2:E:219:GLN:HE22	1.76	0.49
1:A:454:ARG:HG2	1:A:481:LEU:HB3	1.94	0.49
2:B:33:LEU:O	2:B:37:LEU:CG	2.60	0.49
3:C:41:ASP:HB3	3:F:39:PRO:CB	2.35	0.49
2:B:133:GLN:NE2	2:E:78:TRP:CZ3	2.80	0.49

Continued on next page...

Continued from previous page...

Atom-1	Atom-2	Interatomic distance (Å)	Clash overlap (Å)
2:B:16:PHE:CE2	2:B:109:LEU:HD13	2.47	0.48
2:B:26:ASN:O	2:B:26:ASN:CG	2.50	0.48
2:B:30:ILE:HG23	2:B:31:ALA:N	2.28	0.48
2:B:110:ILE:HG13	2:B:111:PRO:HD3	1.93	0.48
2:B:188:ARG:NH2	2:E:24:SER:O	2.36	0.48
2:E:211:PHE:N	2:E:455:TRP:HE3	2.11	0.48
2:E:255:LEU:N	2:E:255:LEU:HD12	2.28	0.48
1:D:287:MET:HE2	1:D:311:ILE:HG12	1.95	0.48
2:B:26:ASN:OD1	2:B:26:ASN:O	2.31	0.48
2:E:50:GLU:OE1	2:E:50:GLU:O	2.31	0.48
1:A:472:ILE:HD13	1:A:508:LEU:HD11	1.85	0.48
2:B:351:ILE:HG22	2:B:432:ILE:HD11	1.94	0.48
2:B:256:THR:O	2:B:256:THR:HG22	2.14	0.48
1:A:408:ASN:OD1	1:A:424:ASN:CA	2.61	0.48
2:B:26:ASN:HA	2:B:29:GLU:CD	2.34	0.48
2:E:100:ASN:OD1	2:E:102:ASN:N	2.46	0.48
2:E:248:GLN:OE1	3:F:56:GLN:O	2.31	0.48
2:B:243:PHE:CE2	2:B:270:TYR:HB3	2.48	0.48
2:E:91:TYR:HB2	2:E:120:ILE:HD12	1.96	0.48
1:D:412:THR:HG22	1:D:418:LYS:CE	2.44	0.47
2:E:228:ARG:O	2:E:232:LEU:HD13	2.13	0.47
2:E:347:ILE:CD1	2:E:413:LEU:HD22	2.43	0.47
1:A:309:GLU:HB3	1:A:365:PHE:CZ	2.49	0.47
2:E:252:ASN:CB	3:F:54:VAL:HG11	2.44	0.47
2:E:347:ILE:CD1	2:E:407:LEU:HD13	2.44	0.47
1:D:395:LEU:HD22	1:D:439:PRO:HG2	1.95	0.47
3:C:41:ASP:OD1	3:C:41:ASP:O	2.32	0.47
1:D:486:ARG:O	1:D:489:ILE:HG22	2.15	0.47
2:E:146:SER:HB3	2:E:185:ILE:CG2	2.43	0.47
1:A:260:ILE:HA	1:A:263:LYS:HB3	1.97	0.47
2:B:389:THR:HG23	2:B:391:TYR:H	1.78	0.47
1:D:327:VAL:O	1:D:327:VAL:HG12	2.14	0.47
2:E:347:ILE:HD13	2:E:407:LEU:HD13	1.96	0.47
2:B:347:ILE:HG22	2:B:348:LYS:N	2.29	0.47
1:D:404:ARG:HD2	1:D:404:ARG:N	2.30	0.47
1:D:406:ILE:HD13	1:D:453:ILE:HD11	1.95	0.47
2:E:241:VAL:HG23	2:E:242:GLN:N	2.30	0.47
1:A:276:LEU:CD2	1:A:321:ILE:HD12	2.44	0.47
2:B:30:ILE:HD11	2:B:72:ALA:CA	2.40	0.47
2:B:188:ARG:HH11	2:B:188:ARG:CG	2.28	0.47
2:E:183:ASN:OD1	2:E:195:CYS:SG	2.71	0.47

Continued on next page...

Continued from previous page...

Atom-1	Atom-2	Interatomic distance (Å)	Clash overlap (Å)
2:E:182:LEU:HG	2:E:186:TYR:CE2	2.50	0.47
2:E:241:VAL:CG2	2:E:242:GLN:N	2.78	0.47
2:E:288:ARG:N	2:E:289:PRO:CD	2.78	0.47
2:E:306:VAL:HG13	2:E:341:VAL:HG23	1.97	0.47
2:B:38:THR:HG23	2:B:39:GLY:N	2.30	0.47
2:E:369:GLU:HG3	2:E:370:ARG:N	2.30	0.47
2:B:339:PRO:HB3	2:B:395:HIS:CE1	2.51	0.46
1:D:472:ILE:HD12	1:D:472:ILE:N	2.30	0.46
1:D:323:VAL:CG2	1:D:526:LYS:HB3	2.45	0.46
2:E:197:ASN:O	2:E:201:ASN:ND2	2.47	0.46
1:A:498:ILE:HD11	1:A:511:LEU:HD13	1.97	0.46
1:A:276:LEU:O	1:A:277:PRO:C	2.54	0.46
1:A:353:ARG:NH1	1:A:387:PRO:HG2	2.31	0.46
3:C:26:LYS:HG3	2:E:32:ILE:CG2	2.46	0.46
1:D:402:PHE:O	1:D:406:ILE:HG13	2.15	0.46
2:E:110:ILE:HB	2:E:111:PRO:HD3	1.97	0.46
1:A:364:GLU:HG2	1:A:368:TYR:CE2	2.51	0.46
2:E:304:LYS:HD3	2:E:305:HIS:N	2.30	0.46
2:B:25:GLN:O	2:B:26:ASN:CB	2.58	0.46
2:B:452:HIS:CE1	2:B:453:VAL:HG22	2.49	0.46
1:D:315:HIS:HB2	1:D:338:LEU:HD23	1.98	0.46
2:B:3:MET:HG2	2:B:33:LEU:HD12	1.95	0.46
2:E:254:PRO:HG2	2:E:255:LEU:HD12	1.97	0.46
2:B:37:LEU:HD22	2:B:45:LEU:HD11	1.96	0.46
1:A:404:ARG:HA	1:A:404:ARG:HD3	1.78	0.46
2:B:258:GLN:OE1	2:B:258:GLN:HA	2.16	0.46
2:B:265:THR:HG23	2:B:291:LEU:HD23	1.98	0.46
3:C:23:GLU:C	3:C:24:ILE:CG2	2.81	0.46
2:E:339:PRO:HB3	2:E:395:HIS:CE1	2.51	0.46
1:A:325:SER:HB2	1:A:327:VAL:HG12	1.97	0.45
2:B:241:VAL:HG23	2:B:242:GLN:N	2.31	0.45
2:B:421:LEU:O	2:B:422:GLN:HB2	2.16	0.45
2:E:401:GLU:O	2:E:405:VAL:HG23	2.15	0.45
2:B:106:ILE:O	2:B:110:ILE:CG2	2.64	0.45
1:D:371:LEU:HD11	1:D:442:MET:CE	2.46	0.45
1:D:527:THR:CG2	1:D:528:TYR:H	2.29	0.45
2:E:176:LEU:CD2	2:E:218:GLN:HB3	2.47	0.45
1:A:340:LYS:O	1:A:343:ILE:HG12	2.16	0.45
2:E:183:ASN:CB	2:E:225:LEU:HD23	2.47	0.45
2:E:258:GLN:C	2:E:262:ARG:CD	2.84	0.45
2:B:53:PRO:O	2:B:54:ALA:HB3	2.17	0.45

Continued on next page...

Continued from previous page...

Atom-1	Atom-2	Interatomic distance (Å)	Clash overlap (Å)
2:B:284:TRP:O	2:B:288:ARG:HG2	2.16	0.45
2:B:352:LYS:HA	2:B:432:ILE:HD13	1.98	0.45
1:D:408:ASN:HD22	1:D:456:TYR:HB3	1.79	0.45
3:F:32:ASP:OD1	3:F:32:ASP:C	2.54	0.45
2:B:34:GLN:HG3	2:B:73:ARG:C	2.37	0.45
2:E:296:ILE:O	2:E:300:SER:OG	2.35	0.45
2:B:91:TYR:CG	2:B:120:ILE:HD13	2.52	0.45
2:B:331:LEU:HD13	2:B:331:LEU:C	2.37	0.45
3:C:69:VAL:CG2	3:C:70:ASP:N	2.80	0.45
1:A:474:PHE:CD1	1:A:489:ILE:HD13	2.52	0.45
2:B:28:ARG:O	2:B:32:ILE:HG13	2.16	0.45
2:B:194:LEU:N	2:B:194:LEU:CD1	2.79	0.45
2:E:217:ASP:HB2	3:F:38:PHE:CE2	2.47	0.45
2:E:241:VAL:HG11	2:E:449:ALA:CB	2.46	0.45
2:B:176:LEU:HD23	2:B:218:GLN:HB3	1.95	0.45
2:B:268:LEU:O	2:B:272:ILE:HG12	2.17	0.45
3:C:64:TRP:CG	3:C:65:ASP:N	2.82	0.45
1:D:345:LEU:HD22	1:D:349:TYR:CZ	2.51	0.45
2:E:183:ASN:OD1	2:E:198:ILE:HD11	2.16	0.45
2:E:338:LEU:O	2:E:342:THR:HG22	2.17	0.45
2:B:22:ASN:OD1	2:B:25:GLN:OE1	2.35	0.44
2:B:426:VAL:HB	2:B:435:ILE:HD12	1.99	0.44
2:E:32:ILE:H	2:E:32:ILE:HG12	1.45	0.44
2:E:321:ASN:O	2:E:325:LEU:HB2	2.17	0.44
1:A:321:ILE:HD11	1:A:541:TYR:CZ	2.51	0.44
2:B:355:THR:O	2:B:359:GLY:HA2	2.17	0.44
2:B:367:LEU:HD13	3:C:84:TYR:CG	2.51	0.44
1:A:376:ASP:O	1:A:403:ARG:NH2	2.51	0.44
2:B:214:TYR:O	2:B:219:GLN:NE2	2.49	0.44
2:E:415:ALA:HB2	2:E:426:VAL:HG12	1.98	0.44
1:A:371:LEU:HD11	1:A:442:MET:HE3	2.00	0.44
2:E:136:THR:OG1	2:E:140:GLN:OE1	2.35	0.44
1:A:404:ARG:HD2	2:B:336:GLU:HB2	2.00	0.44
2:B:176:LEU:HD23	2:B:218:GLN:HB2	2.00	0.44
2:E:192:PRO:O	2:E:195:CYS:HB2	2.18	0.44
2:E:212:ASN:HA	2:E:219:GLN:NE2	2.32	0.44
2:B:367:LEU:HD11	3:C:81:LEU:HD23	1.99	0.44
1:D:318:ILE:HG23	1:D:322:MET:HG2	1.99	0.44
2:E:272:ILE:N	2:E:273:PRO:HD2	2.33	0.44
1:A:441:LEU:HD22	1:A:441:LEU:H	1.83	0.44
2:E:183:ASN:HB3	2:E:225:LEU:HD23	2.00	0.44

Continued on next page...

Continued from previous page...

Atom-1	Atom-2	Interatomic distance (Å)	Clash overlap (Å)
3:C:40:ILE:HD12	3:C:40:ILE:HA	1.68	0.44
2:E:203:GLN:HA	2:E:455:TRP:CZ2	2.53	0.44
2:B:172:GLN:CD	2:B:207:MET:HG3	2.39	0.44
2:B:348:LYS:HB2	2:B:436:VAL:HG11	1.98	0.43
1:D:273:LEU:O	1:D:276:LEU:HB2	2.17	0.43
2:B:131:HIS:HB2	2:B:136:THR:HG23	2.01	0.43
2:B:333:VAL:HG13	2:B:334:LEU:N	2.33	0.43
1:D:475:ILE:N	1:D:475:ILE:HD12	2.33	0.43
2:E:103:ALA:HB3	2:E:106:ILE:CG2	2.47	0.43
2:E:197:ASN:OD1	2:E:197:ASN:C	2.57	0.43
3:F:54:VAL:CG2	3:F:55:THR:N	2.82	0.43
1:A:405:VAL:HG13	1:A:425:PHE:O	2.17	0.43
3:C:55:THR:O	3:C:55:THR:HG23	2.15	0.43
2:E:18:HIS:O	2:E:26:ASN:ND2	2.51	0.43
2:B:296:ILE:O	2:B:300:SER:OG	2.29	0.43
3:F:38:PHE:HA	3:F:39:PRO:HD3	1.81	0.43
2:B:288:ARG:N	2:B:289:PRO:CD	2.81	0.43
1:D:404:ARG:HH21	2:E:332:ILE:HG21	1.82	0.43
2:E:282:VAL:HG12	3:F:60:TRP:CZ3	2.54	0.43
3:F:85:LYS:O	3:F:89:GLN:N	2.51	0.43
2:B:100:ASN:HB3	2:B:103:ALA:HB2	1.99	0.43
2:B:217:ASP:CB	3:C:38:PHE:CD1	2.95	0.43
1:D:276:LEU:HD21	1:D:318:ILE:HG12	2.00	0.43
2:E:244:ASN:HA	2:E:271:MET:HE1	2.01	0.43
2:B:42:ASP:CB	2:B:73:ARG:HH22	2.32	0.43
2:B:194:LEU:HD12	2:B:194:LEU:H	1.81	0.43
2:B:217:ASP:OD2	3:C:38:PHE:CG	2.71	0.43
2:B:257:ASN:HB3	2:B:260:ILE:HD13	2.00	0.43
1:D:329:PHE:CE2	1:D:331:LEU:CD1	3.01	0.43
3:F:69:VAL:CG1	3:F:70:ASP:N	2.82	0.43
1:A:318:ILE:O	1:A:322:MET:HG2	2.19	0.42
1:A:340:LYS:O	1:A:344:THR:HG23	2.19	0.42
1:D:287:MET:HE3	1:D:314:ILE:HD12	2.00	0.42
2:B:255:LEU:HD12	2:B:255:LEU:N	2.33	0.42
2:B:333:VAL:O	2:B:337:LYS:HG2	2.19	0.42
2:B:34:GLN:HG3	2:B:73:ARG:HA	1.99	0.42
2:B:245:GLU:OE1	2:B:245:GLU:HA	2.19	0.42
2:E:41:ASP:OD1	2:E:41:ASP:O	2.38	0.42
1:D:440:LEU:HG	1:D:444:PHE:CZ	2.54	0.42
2:E:142:LEU:HD12	2:E:142:LEU:HA	1.85	0.42
2:E:260:ILE:HG22	2:E:261:THR:N	2.34	0.42

Continued on next page...

Continued from previous page...

Atom-1	Atom-2	Interatomic distance (Å)	Clash overlap (Å)
2:E:333:VAL:HG13	2:E:334:LEU:N	2.34	0.42
1:A:344:THR:O	1:A:347:GLU:HG2	2.19	0.42
2:B:148:ILE:HA	2:B:151:ARG:NH1	2.35	0.42
2:B:258:GLN:OE1	2:B:258:GLN:CA	2.66	0.42
2:B:344:ARG:NH1	2:B:436:VAL:HG12	2.34	0.42
2:E:373:GLN:HA	2:E:397:PRO:HB3	2.01	0.42
3:F:64:TRP:CD1	3:F:65:ASP:N	2.87	0.42
1:A:470:LYS:HE3	1:A:470:LYS:HB3	1.77	0.42
2:B:3:MET:CE	2:B:29:GLU:HB3	2.50	0.42
2:B:188:ARG:HH11	2:B:188:ARG:HG2	1.85	0.42
2:B:203:GLN:HA	2:B:455:TRP:HZ2	1.85	0.42
1:D:305:VAL:CG2	1:D:306:ASP:N	2.83	0.42
2:B:26:ASN:CA	2:B:29:GLU:OE1	2.68	0.42
2:B:3:MET:CG	2:B:33:LEU:CD1	2.92	0.42
1:D:309:GLU:HB3	1:D:365:PHE:CZ	2.54	0.42
2:E:40:PHE:CD2	2:E:44:GLN:HG2	2.54	0.42
2:E:195:CYS:O	2:E:198:ILE:HG12	2.20	0.42
1:A:255:VAL:HG11	1:A:297:GLN:HG3	2.01	0.41
2:B:45:LEU:HD21	2:B:69:LEU:CB	2.50	0.41
1:D:256:ARG:O	1:D:297:GLN:NE2	2.50	0.41
1:D:329:PHE:CD1	1:D:330:SER:CA	3.03	0.41
1:A:322:MET:CE	1:A:327:VAL:HG13	2.50	0.41
1:A:419:THR:HG21	2:B:234:SER:HB2	2.01	0.41
2:B:418:PHE:HB2	2:B:421:LEU:HB2	2.02	0.41
2:E:198:ILE:CG1	2:E:199:PHE:N	2.83	0.41
2:B:30:ILE:CG2	2:B:31:ALA:N	2.83	0.41
2:E:238:ASN:O	2:E:241:VAL:HG22	2.20	0.41
2:E:335:LEU:HD22	2:E:390:ILE:HD12	2.02	0.41
1:D:527:THR:HG23	1:D:528:TYR:H	1.86	0.41
2:E:400:VAL:O	2:E:403:VAL:HG12	2.21	0.41
2:B:172:GLN:HG3	2:B:207:MET:SD	2.61	0.41
2:B:203:GLN:HA	2:B:455:TRP:CZ2	2.55	0.41
2:B:418:PHE:N	2:B:418:PHE:HD1	2.15	0.41
2:B:432:ILE:O	2:B:435:ILE:HG22	2.19	0.41
1:D:370:LEU:HD22	1:D:403:ARG:HD2	2.02	0.41
2:E:217:ASP:HB2	3:F:38:PHE:CG	2.48	0.41
2:E:333:VAL:O	2:E:337:LYS:HG2	2.21	0.41
2:B:188:ARG:CG	2:B:188:ARG:NH1	2.83	0.41
1:D:428:ARG:HD2	1:D:428:ARG:HA	1.87	0.41
1:A:486:ARG:O	1:A:489:ILE:HG22	2.20	0.41
2:B:348:LYS:NZ	3:C:65:ASP:OD1	2.47	0.41

Continued on next page...

Continued from previous page...

Atom-1	Atom-2	Interatomic distance (Å)	Clash overlap (Å)
2:E:40:PHE:HB3	2:E:44:GLN:CB	2.48	0.41
1:A:331:LEU:HD21	1:A:526:LYS:HE3	2.01	0.41
2:B:255:LEU:HD12	2:B:255:LEU:H	1.85	0.41
2:B:355:THR:O	2:B:359:GLY:CA	2.69	0.41
1:D:280:GLU:HG3	1:D:281:GLY:N	2.36	0.41
2:E:28:ARG:O	2:E:32:ILE:HG12	2.21	0.41
2:E:285:GLY:N	2:E:286:PRO:CD	2.84	0.41
3:F:64:TRP:CG	3:F:65:ASP:N	2.89	0.41
1:A:476:TYR:CE2	2:B:419:PRO:HB3	2.56	0.41
2:B:34:GLN:HG3	2:B:73:ARG:CA	2.51	0.41
1:D:318:ILE:O	1:D:322:MET:HG2	2.21	0.40
2:E:30:ILE:O	2:E:34:GLN:CB	2.68	0.40
3:F:32:ASP:OD1	3:F:33:ASP:N	2.53	0.40
1:A:352:VAL:HG12	1:A:357:GLY:C	2.41	0.40
2:B:237:HIS:HA	2:B:278:LEU:HD11	2.03	0.40
2:B:283:LYS:O	2:B:286:PRO:HD2	2.21	0.40
2:B:244:ASN:HA	2:B:271:MET:CE	2.51	0.40
2:B:272:ILE:HD12	2:B:282:VAL:HG11	2.04	0.40
2:B:282:VAL:HG21	2:B:287:LEU:HD13	1.85	0.40
2:B:302:LEU:HD22	2:B:317:TRP:CZ3	2.56	0.40
1:D:340:LYS:O	1:D:343:ILE:HG12	2.21	0.40
1:D:484:ASN:HB2	1:D:488:GLU:OE1	2.21	0.40
2:B:52:HIS:CG	2:B:53:PRO:HD2	2.56	0.40
1:A:352:VAL:HG12	1:A:357:GLY:O	2.22	0.40
1:A:412:THR:HG22	1:A:418:LYS:CE	2.52	0.40
3:C:40:ILE:CG2	3:C:41:ASP:N	2.82	0.40
1:D:287:MET:HE3	1:D:314:ILE:CD1	2.51	0.40

There are no symmetry-related clashes.

5.3 Torsion angles [i](#)

5.3.1 Protein backbone [i](#)

In the following table, the Percentiles column shows the percent Ramachandran outliers of the chain as a percentile score with respect to all X-ray entries followed by that with respect to entries of similar resolution.

The Analysed column shows the number of residues for which the backbone conformation was analysed, and the total number of residues.

Mol	Chain	Analysed	Favoured	Allowed	Outliers	Percentiles	
1	A	297/316 (94%)	290 (98%)	7 (2%)	0	100	100
1	D	297/316 (94%)	291 (98%)	6 (2%)	0	100	100
2	B	446/455 (98%)	429 (96%)	17 (4%)	0	100	100
2	E	444/455 (98%)	435 (98%)	9 (2%)	0	100	100
3	C	52/89 (58%)	48 (92%)	4 (8%)	0	100	100
3	F	43/89 (48%)	42 (98%)	1 (2%)	0	100	100
All	All	1579/1720 (92%)	1535 (97%)	44 (3%)	0	100	100

There are no Ramachandran outliers to report.

5.3.2 Protein sidechains [i](#)

In the following table, the Percentiles column shows the percent sidechain outliers of the chain as a percentile score with respect to all X-ray entries followed by that with respect to entries of similar resolution.

The Analysed column shows the number of residues for which the sidechain conformation was analysed, and the total number of residues.

Mol	Chain	Analysed	Rotameric	Outliers	Percentiles	
1	A	278/293 (95%)	270 (97%)	8 (3%)	42	76
1	D	277/293 (94%)	265 (96%)	12 (4%)	29	62
2	B	416/419 (99%)	398 (96%)	18 (4%)	29	62
2	E	414/419 (99%)	391 (94%)	23 (6%)	21	52
3	C	54/81 (67%)	47 (87%)	7 (13%)	4	12
3	F	45/81 (56%)	37 (82%)	8 (18%)	2	5
All	All	1484/1586 (94%)	1408 (95%)	76 (5%)	24	56

All (76) residues with a non-rotameric sidechain are listed below:

Mol	Chain	Res	Type
1	A	286	ARG
1	A	329	PHE
1	A	332	GLN
1	A	358	THR
1	A	382	ASN
1	A	404	ARG
1	A	445	PHE

Continued on next page...

Continued from previous page...

Mol	Chain	Res	Type
1	A	470	LYS
2	B	26	ASN
2	B	28	ARG
2	B	110	ILE
2	B	115	ARG
2	B	188	ARG
2	B	193	GLN
2	B	258	GLN
2	B	280	LYS
2	B	287	LEU
2	B	290	PHE
2	B	347	ILE
2	B	362	LYS
2	B	363	LEU
2	B	366	SER
2	B	398	LYS
2	B	402	ASN
2	B	417	CYS
2	B	418	PHE
3	C	27	LYS
3	C	35	PHE
3	C	36	GLU
3	C	40	ILE
3	C	58	ASN
3	C	64	TRP
3	C	69	VAL
1	D	271	ASN
1	D	275	THR
1	D	280	GLU
1	D	326	ASN
1	D	327	VAL
1	D	328	GLU
1	D	329	PHE
1	D	332	GLN
1	D	404	ARG
1	D	406	ILE
1	D	445	PHE
1	D	544	LEU
2	E	24	SER
2	E	32	ILE
2	E	33	LEU
2	E	34	GLN

Continued on next page...

Continued from previous page...

Mol	Chain	Res	Type
2	E	40	PHE
2	E	41	ASP
2	E	42	ASP
2	E	45	LEU
2	E	57	ASN
2	E	60	ARG
2	E	79	SER
2	E	83	SER
2	E	157	LYS
2	E	167	ASN
2	E	196	SER
2	E	215	GLN
2	E	216	LEU
2	E	245	GLU
2	E	262	ARG
2	E	329	GLN
2	E	344	ARG
2	E	366	SER
2	E	402	ASN
3	F	32	ASP
3	F	35	PHE
3	F	58	ASN
3	F	62	GLU
3	F	64	TRP
3	F	65	ASP
3	F	68	GLU
3	F	72	ASP

Sometimes sidechains can be flipped to improve hydrogen bonding and reduce clashes. All (1) such sidechains are listed below:

Mol	Chain	Res	Type
2	B	70	ASN

5.3.3 RNA [i](#)

There are no RNA molecules in this entry.

5.4 Non-standard residues in protein, DNA, RNA chains [i](#)

There are no non-standard protein/DNA/RNA residues in this entry.

5.5 Carbohydrates [i](#)

There are no monosaccharides in this entry.

5.6 Ligand geometry [i](#)

There are no ligands in this entry.

5.7 Other polymers [i](#)

There are no such residues in this entry.

5.8 Polymer linkage issues [i](#)

There are no chain breaks in this entry.

6 Fit of model and data

6.1 Protein, DNA and RNA chains

In the following table, the column labelled ‘#RSRZ > 2’ contains the number (and percentage) of RSRZ outliers, followed by percent RSRZ outliers for the chain as percentile scores relative to all X-ray entries and entries of similar resolution. The OWAB column contains the minimum, median, 95th percentile and maximum values of the occupancy-weighted average B-factor per residue. The column labelled ‘Q < 0.9’ lists the number of (and percentage) of residues with an average occupancy less than 0.9.

Mol	Chain	Analysed	<RSRZ>	#RSRZ>2	OWAB(Å ²)	Q<0.9
1	A	299/316 (94%)	-0.22	11 (3%) 41 37	18, 28, 54, 83	0
1	D	299/316 (94%)	-0.09	12 (4%) 38 33	22, 36, 73, 170	0
2	B	450/455 (98%)	-0.05	19 (4%) 36 32	24, 45, 85, 128	0
2	E	448/455 (98%)	-0.13	15 (3%) 46 41	25, 47, 77, 115	0
3	C	56/89 (62%)	1.33	17 (30%) 0 0	37, 64, 125, 143	0
3	F	47/89 (52%)	1.14	13 (27%) 0 0	38, 64, 124, 140	0
All	All	1599/1720 (92%)	-0.03	87 (5%) 25 22	18, 42, 84, 170	0

All (87) RSRZ outliers are listed below:

Mol	Chain	Res	Type	RSRZ
3	C	66	ASP	6.6
1	D	252	PRO	6.3
3	F	66	ASP	5.6
2	B	164	SER	5.5
2	B	452	HIS	5.3
3	C	38	PHE	5.2
3	C	67	VAL	5.2
2	B	166	THR	5.0
1	D	549	GLU	4.9
1	D	550	ASP	4.4
1	D	328	GLU	4.4
2	B	159	PRO	4.4
3	F	54	VAL	4.3
2	B	165	SER	4.3
3	C	68	GLU	4.3
3	C	39	PRO	4.2
3	C	89	GLN	4.2
2	B	65	CYS	4.2
3	F	53	ALA	4.2

Continued on next page...

Continued from previous page...

Mol	Chain	Res	Type	RSRZ
2	E	254	PRO	4.2
1	A	550	ASP	4.1
1	D	514	TYR	4.0
1	D	548	GLY	3.8
2	E	167	ASN	3.8
3	C	56	GLN	3.8
1	A	549	GLU	3.8
3	C	70	ASP	3.8
3	C	55	THR	3.8
3	C	69	VAL	3.7
1	D	326	ASN	3.6
3	F	69	VAL	3.5
3	C	53	ALA	3.5
3	F	67	VAL	3.5
2	B	453	VAL	3.4
3	F	55	THR	3.4
1	A	548	GLY	3.3
1	A	253	SER	3.3
3	F	89	GLN	3.3
1	A	326	ASN	3.3
3	C	37	ASP	3.3
3	F	31	GLU	3.2
3	F	63	ASN	3.1
2	E	452	HIS	3.1
2	E	65	CYS	3.1
1	D	330	SER	3.0
2	B	254	PRO	3.0
2	E	453	VAL	3.0
2	E	255	LEU	2.9
3	F	68	GLU	2.8
3	C	54	VAL	2.8
1	A	328	GLU	2.8
2	B	57	ASN	2.8
2	E	166	THR	2.8
2	B	167	ASN	2.8
3	F	30	GLU	2.7
3	C	65	ASP	2.7
2	B	51	GLN	2.6
1	D	356	GLY	2.6
3	C	41	ASP	2.6
1	A	296	TYR	2.6
2	B	255	LEU	2.5

Continued on next page...

Continued from previous page...

Mol	Chain	Res	Type	RSRZ
3	F	64	TRP	2.5
2	B	252	ASN	2.5
2	E	168	ILE	2.5
1	D	253	SER	2.4
1	A	254	ASP	2.4
2	B	59	THR	2.4
1	A	551	ASN	2.4
2	E	102	ASN	2.4
1	D	414	ARG	2.4
1	A	468	LYS	2.3
1	D	520	GLU	2.3
2	B	451	SER	2.3
2	E	294	GLU	2.3
3	C	23	GLU	2.3
3	C	62	GLU	2.3
2	E	51	GLN	2.3
2	E	451	SER	2.2
2	B	102	ASN	2.2
2	E	427	LYS	2.2
2	B	47	THR	2.2
2	B	168	ILE	2.2
3	F	65	ASP	2.1
2	E	428	LYS	2.1
2	E	57	ASN	2.0
1	A	514	TYR	2.0
2	B	428	LYS	2.0

6.2 Non-standard residues in protein, DNA, RNA chains [\(i\)](#)

There are no non-standard protein/DNA/RNA residues in this entry.

6.3 Carbohydrates [\(i\)](#)

There are no monosaccharides in this entry.

6.4 Ligands [\(i\)](#)

There are no ligands in this entry.

6.5 Other polymers [i](#)

There are no such residues in this entry.