



Full wwPDB X-ray Structure Validation Report ⓘ

Mar 13, 2018 – 01:19 pm GMT

PDB ID : 4TLV
Title : CARDS TOXIN, NICKED
Authors : Taylor, A.B.; Pakhomova, O.N.; Hart, P.J.
Deposited on : 2014-05-30
Resolution : 1.90 Å(reported)

This is a Full wwPDB X-ray Structure Validation Report for a publicly released PDB entry.

We welcome your comments at validation@mail.wwpdb.org

A user guide is available at

<https://www.wwpdb.org/validation/2017/XrayValidationReportHelp>

with specific help available everywhere you see the ⓘ symbol.

The following versions of software and data (see [references ⓘ](#)) were used in the production of this report:

MolProbity : 4.02b-467
Mogul : 1.7.3 (157068), CSD as539be (2018)
Xtriage (Phenix) : 1.13
EDS : trunk31020
Percentile statistics : 20171227.v01 (using entries in the PDB archive December 27th 2017)
Refmac : 5.8.0158
CCP4 : 7.0 (Gargrove)
Ideal geometry (proteins) : Engh & Huber (2001)
Ideal geometry (DNA, RNA) : Parkinson et al. (1996)
Validation Pipeline (wwPDB-VP) : trunk31020

1 Overall quality at a glance

The following experimental techniques were used to determine the structure:

X-RAY DIFFRACTION

The reported resolution of this entry is 1.90 Å.

Percentile scores (ranging between 0-100) for global validation metrics of the entry are shown in the following graphic. The table shows the number of entries on which the scores are based.

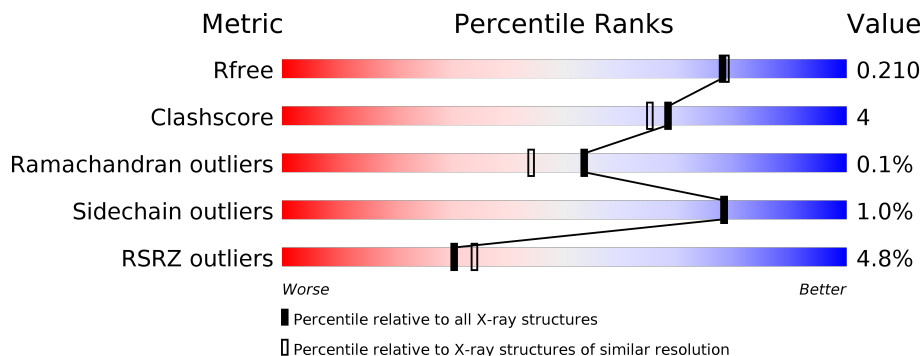

Metric	Whole archive (#Entries)	Similar resolution (#Entries, resolution range(Å))
R_{free}	111664	5502 (1.90-1.90)
Clashscore	122126	6115 (1.90-1.90)
Ramachandran outliers	120053	6048 (1.90-1.90)
Sidechain outliers	120020	6048 (1.90-1.90)
RSRZ outliers	108989	5379 (1.90-1.90)

The table below summarises the geometric issues observed across the polymeric chains and their fit to the electron density. The red, orange, yellow and green segments on the lower bar indicate the fraction of residues that contain outliers for ≥ 3 , 2, 1 and 0 types of geometric quality criteria. A grey segment represents the fraction of residues that are not modelled. The numeric value for each fraction is indicated below the corresponding segment, with a dot representing fractions $\leq 5\%$. The upper red bar (where present) indicates the fraction of residues that have poor fit to the electron density. The numeric value is given above the bar.

Mol	Chain	Length	Quality of chain
1	A	591	 3% 92% 6%
1	B	591	 5% 89% 9%
1	C	591	 2% 91% 6%
1	D	591	 5% 87% 10%
1	E	591	 5% 90% 9%
1	F	591	 8% 84% 12%

The following table lists non-polymeric compounds, carbohydrate monomers and non-standard residues in protein, DNA, RNA chains that are outliers for geometric or electron-density-fit criteria:

Mol	Type	Chain	Res	Chirality	Geometry	Clashes	Electron density
3	GOL	A	606	-	-	X	-
3	GOL	D	603	-	-	X	-
3	GOL	E	603	-	-	X	-
3	GOL	E	604	-	-	X	-
3	GOL	F	603	-	-	X	-
4	ACT	D	608	-	-	X	-

2 Entry composition [i](#)

There are 5 unique types of molecules in this entry. The entry contains 30404 atoms, of which 0 are hydrogens and 0 are deuteriums.

In the tables below, the ZeroOcc column contains the number of atoms modelled with zero occupancy, the AltConf column contains the number of residues with at least one atom in alternate conformation and the Trace column contains the number of residues modelled with at most 2 atoms.

- Molecule 1 is a protein called ADP-ribosylating toxin CARDS.

Mol	Chain	Residues	Atoms					ZeroOcc	AltConf	Trace
			Total	C	N	O	S			
1	A	582	4752	3037	810	889	16	0	1	0
1	B	580	4737	3027	808	887	15	0	1	0
1	C	577	4718	3015	805	882	16	0	0	0
1	D	577	4721	3018	805	883	15	0	2	0
1	E	582	4769	3049	814	890	16	0	4	0
1	F	573	4696	3000	803	878	15	0	1	0

There are 24 discrepancies between the modelled and reference sequences:

Chain	Residue	Modelled	Actual	Comment	Reference
A	-1	GLY	-	expression tag	UNP P75409
A	0	HIS	-	expression tag	UNP P75409
A	?	-	GLN	deletion	UNP P75409
A	?	-	LYS	deletion	UNP P75409
B	-1	GLY	-	expression tag	UNP P75409
B	0	HIS	-	expression tag	UNP P75409
B	?	-	GLN	deletion	UNP P75409
B	?	-	LYS	deletion	UNP P75409
C	-1	GLY	-	expression tag	UNP P75409
C	0	HIS	-	expression tag	UNP P75409
C	?	-	GLN	deletion	UNP P75409
C	?	-	LYS	deletion	UNP P75409
D	-1	GLY	-	expression tag	UNP P75409
D	0	HIS	-	expression tag	UNP P75409
D	?	-	GLN	deletion	UNP P75409
D	?	-	LYS	deletion	UNP P75409
E	-1	GLY	-	expression tag	UNP P75409

Continued on next page...

Continued from previous page...

Chain	Residue	Modelled	Actual	Comment	Reference
E	0	HIS	-	expression tag	UNP P75409
E	?	-	GLN	deletion	UNP P75409
E	?	-	LYS	deletion	UNP P75409
F	-1	GLY	-	expression tag	UNP P75409
F	0	HIS	-	expression tag	UNP P75409
F	?	-	GLN	deletion	UNP P75409
F	?	-	LYS	deletion	UNP P75409

- Molecule 2 is SULFATE ION (three-letter code: SO4) (formula: O₄S).

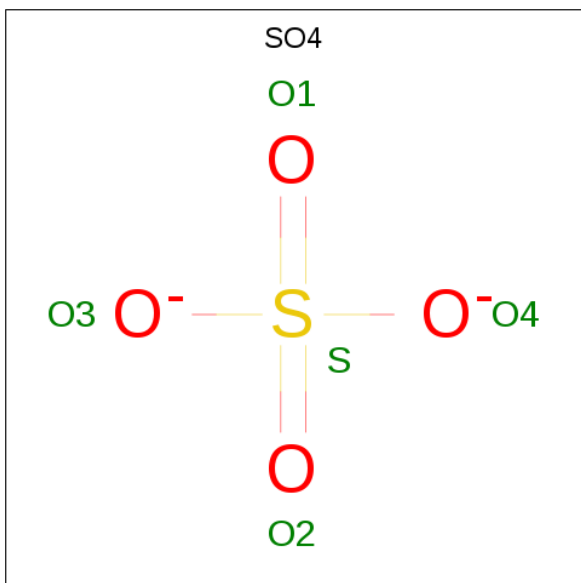

Mol	Chain	Residues	Atoms	ZeroOcc	AltConf
2	A	1	Total O S 5 4 1	0	0
2	A	1	Total O S 5 4 1	0	0
2	B	1	Total O S 5 4 1	0	0
2	D	1	Total O S 5 4 1	0	0
2	E	1	Total O S 5 4 1	0	0

- Molecule 3 is GLYCEROL (three-letter code: GOL) (formula: C₃H₈O₃).



Mol	Chain	Residues	Atoms	ZeroOcc	AltConf
3	A	1	Total C O 6 3 3	0	0
3	A	1	Total C O 6 3 3	0	0
3	A	1	Total C O 6 3 3	0	0
3	A	1	Total C O 6 3 3	0	0
3	B	1	Total C O 6 3 3	0	0
3	B	1	Total C O 6 3 3	0	0
3	B	1	Total C O 6 3 3	0	0
3	C	1	Total C O 6 3 3	0	0
3	C	1	Total C O 6 3 3	0	0
3	C	1	Total C O 6 3 3	0	0
3	C	1	Total C O 6 3 3	0	0
3	C	1	Total C O 6 3 3	0	0
3	C	1	Total C O 6 3 3	0	0
3	C	1	Total C O 6 3 3	0	0

Continued on next page...

Continued from previous page...

Mol	Chain	Residues	Atoms			ZeroOcc	AltConf
3	D	1	Total 6	C 3	O 3	0	0
3	D	1	Total 6	C 3	O 3	0	0
3	D	1	Total 6	C 3	O 3	0	0
3	D	1	Total 6	C 3	O 3	0	0
3	D	1	Total 6	C 3	O 3	0	0
3	D	1	Total 6	C 3	O 3	0	0
3	E	1	Total 6	C 3	O 3	0	0
3	E	1	Total 6	C 3	O 3	0	0
3	E	1	Total 6	C 3	O 3	0	0
3	E	1	Total 6	C 3	O 3	0	0
3	F	1	Total 6	C 3	O 3	0	0
3	F	1	Total 6	C 3	O 3	0	0
3	F	1	Total 6	C 3	O 3	0	0

- Molecule 4 is ACETATE ION (three-letter code: ACT) (formula: C₂H₃O₂).

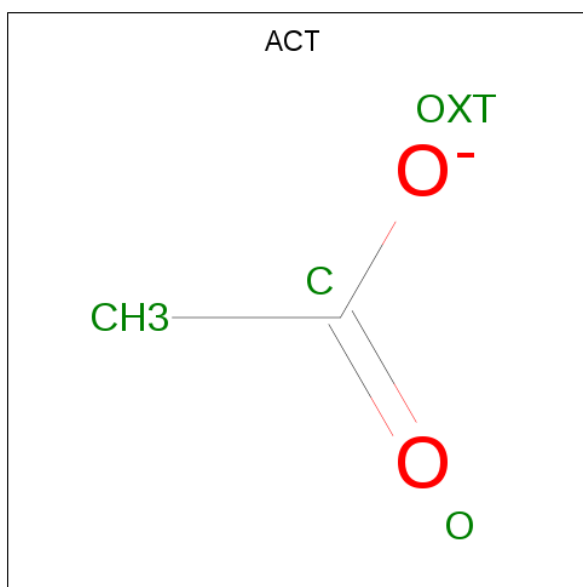

Mol	Chain	Residues	Atoms	ZeroOcc	AltConf
4	A	1	Total C O 4 2 2	0	0
4	A	1	Total C O 4 2 2	0	0
4	D	1	Total C O 4 2 2	0	0
4	E	1	Total C O 4 2 2	0	0

- Molecule 5 is water.

Mol	Chain	Residues	Atoms	ZeroOcc	AltConf
5	A	380	Total O 380 380	0	0
5	B	296	Total O 296 296	0	0
5	C	350	Total O 350 350	0	0
5	D	305	Total O 305 305	0	0
5	E	295	Total O 295 295	0	0
5	F	182	Total O 182 182	0	0

3 Residue-property plots [i](#)

These plots are drawn for all protein, RNA and DNA chains in the entry. The first graphic for a chain summarises the proportions of the various outlier classes displayed in the second graphic. The second graphic shows the sequence view annotated by issues in geometry and electron density. Residues are color-coded according to the number of geometric quality criteria for which they contain at least one outlier: green = 0, yellow = 1, orange = 2 and red = 3 or more. A red dot above a residue indicates a poor fit to the electron density ($RSRZ > 2$). Stretches of 2 or more consecutive residues without any outlier are shown as a green connector. Residues present in the sample, but not in the model, are shown in grey.

- Molecule 1: ADP-ribosylating toxin CARDS

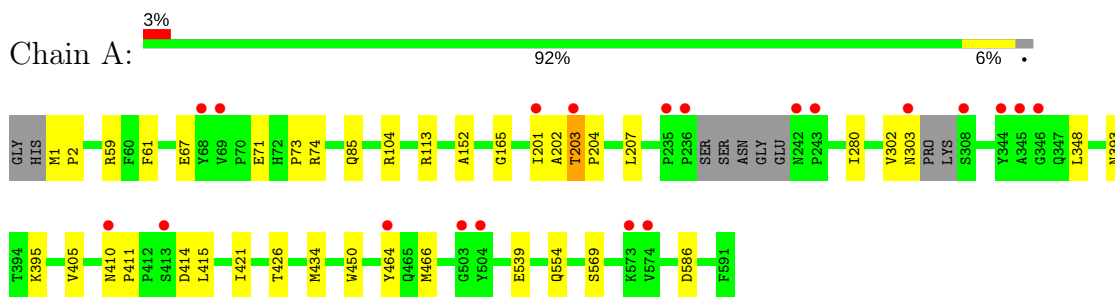

- Molecule 1: ADP-ribosylating toxin CARDS

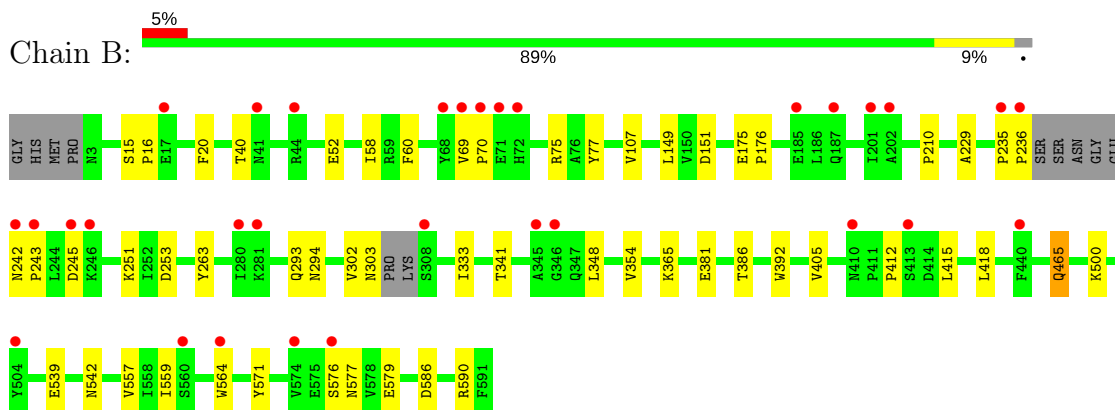

- Molecule 1: ADP-ribosylating toxin CARDS

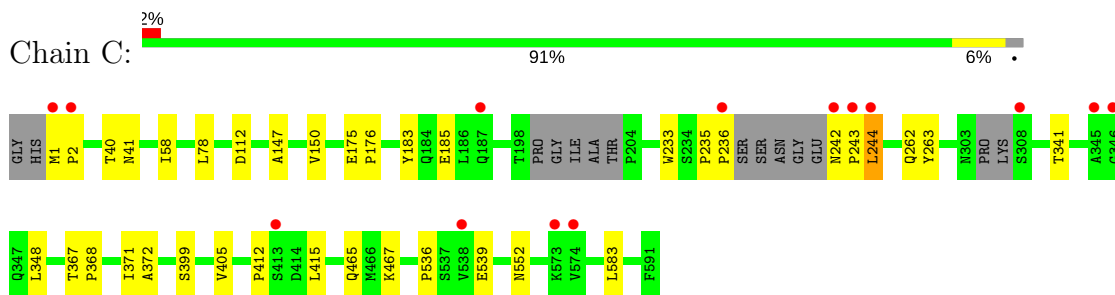

- Molecule 1: ADP-ribosylating toxin CARDS

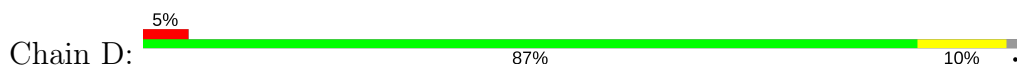

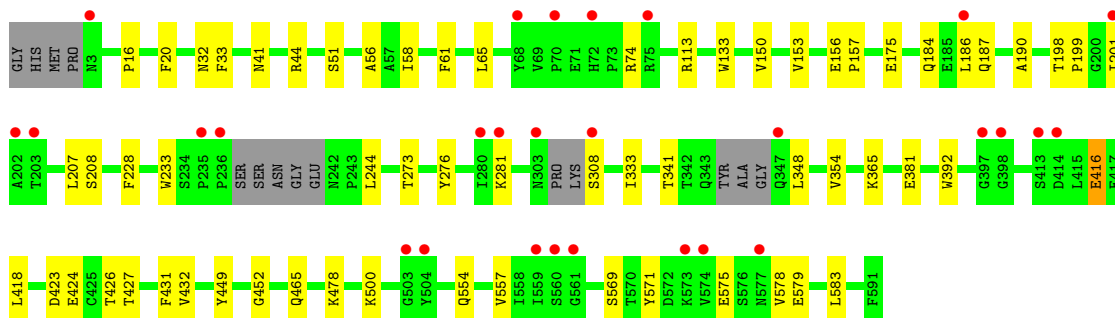

• Molecule 1: ADP-ribosylating toxin CARDS

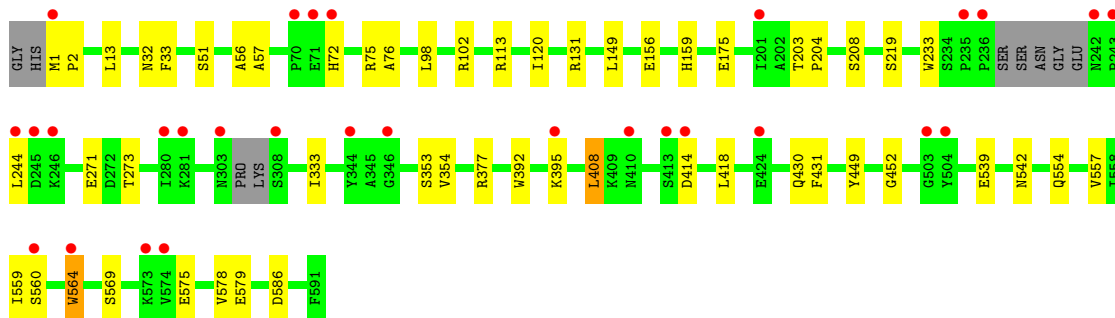
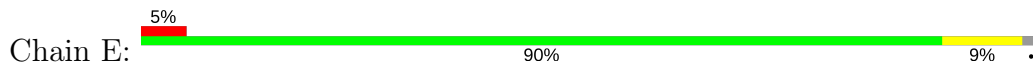

• Molecule 1: ADP-ribosylating toxin CARDS

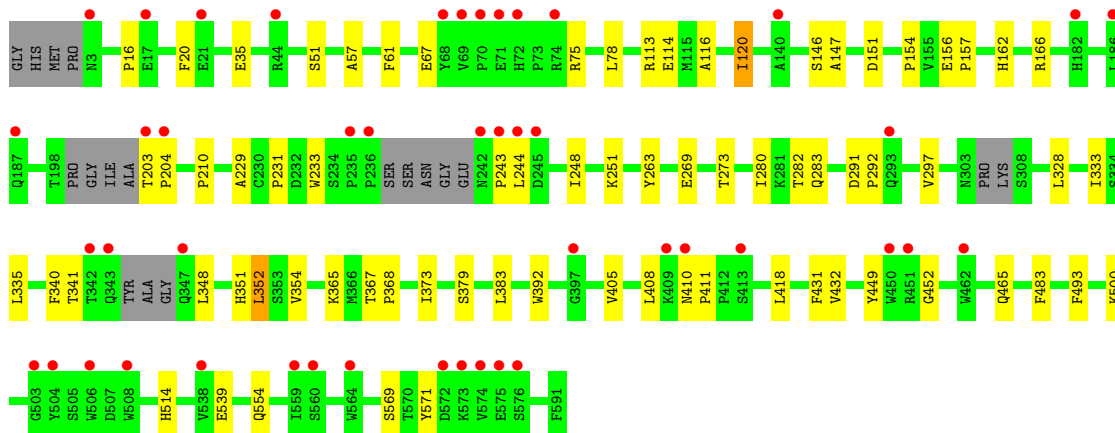
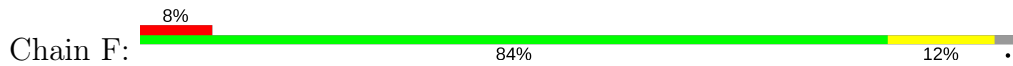

4 Data and refinement statistics i

Property	Value	Source
Space group	C 1 2 1	Depositor
Cell constants a, b, c, α , β , γ	191.70Å 107.41Å 222.26Å 90.00° 90.64° 90.00°	Depositor
Resolution (Å)	38.87 – 1.90 38.87 – 1.90	Depositor EDS
% Data completeness (in resolution range)	99.4 (38.87-1.90) 99.4 (38.87-1.90)	Depositor EDS
R_{merge}	(Not available)	Depositor
R_{sym}	0.07	Depositor
$\langle I/\sigma(I) \rangle$ ¹	2.49 (at 1.91Å)	Xtriage
Refinement program	PHENIX (PHENIX.REFINE: 1.7.3_928)	Depositor
R, R_{free}	0.186 , 0.215 0.182 , 0.210	Depositor DCC
R_{free} test set	17675 reflections (5.05%)	wwPDB-VP
Wilson B-factor (Å ²)	22.0	Xtriage
Anisotropy	0.423	Xtriage
Bulk solvent k_{sol} (e/Å ³), B_{sol} (Å ²)	0.36 , 48.6	EDS
L-test for twinning ²	$\langle L \rangle = 0.50$, $\langle L^2 \rangle = 0.33$	Xtriage
Estimated twinning fraction	0.005 for -1/2*h-3/2*k,-1/2*h+1/2*k,-l 0.005 for -1/2*h+3/2*k,1/2*h+1/2*k,-l 0.029 for 1/2*h-3/2*k,-1/2*h-1/2*k,-l 0.019 for 1/2*h+3/2*k,1/2*h-1/2*k,-l 0.010 for -h,-k,l	Xtriage
F_o, F_c correlation	0.96	EDS
Total number of atoms	30404	wwPDB-VP
Average B, all atoms (Å ²)	27.0	wwPDB-VP

Xtriage's analysis on translational NCS is as follows: *The largest off-origin peak in the Patterson function is 2.58% of the height of the origin peak. No significant pseudotranslation is detected.*

¹Intensities estimated from amplitudes.

²Theoretical values of $\langle |L| \rangle$, $\langle L^2 \rangle$ for acentric reflections are 0.5, 0.333 respectively for untwinned datasets, and 0.375, 0.2 for perfectly twinned datasets.

5 Model quality [i](#)

5.1 Standard geometry [i](#)

Bond lengths and bond angles in the following residue types are not validated in this section: GOL, SO4, ACT

The Z score for a bond length (or angle) is the number of standard deviations the observed value is removed from the expected value. A bond length (or angle) with $|Z| > 5$ is considered an outlier worth inspection. RMSZ is the root-mean-square of all Z scores of the bond lengths (or angles).

Mol	Chain	Bond lengths		Bond angles	
		RMSZ	# Z >5	RMSZ	# Z >5
1	A	0.50	0/4894	0.58	0/6661
1	B	0.48	0/4878	0.54	0/6639
1	C	0.48	0/4855	0.56	0/6604
1	D	0.49	0/4863	0.54	0/6617
1	E	0.45	0/4922	0.53	0/6699
1	F	0.43	0/4834	0.51	0/6575
All	All	0.47	0/29246	0.55	0/39795

There are no bond length outliers.

There are no bond angle outliers.

There are no chirality outliers.

There are no planarity outliers.

5.2 Too-close contacts [i](#)

In the following table, the Non-H and H(model) columns list the number of non-hydrogen atoms and hydrogen atoms in the chain respectively. The H(added) column lists the number of hydrogen atoms added and optimized by MolProbity. The Clashes column lists the number of clashes within the asymmetric unit, whereas Symm-Clashes lists symmetry related clashes.

Mol	Chain	Non-H	H(model)	H(added)	Clashes	Symm-Clashes
1	A	4752	0	4532	29	0
1	B	4737	0	4513	34	0
1	C	4718	0	4494	28	0
1	D	4721	0	4506	56	0
1	E	4769	0	4551	40	0
1	F	4696	0	4470	45	0
2	A	10	0	0	0	0

Continued on next page...

Continued from previous page...

Mol	Chain	Non-H	H(model)	H(added)	Clashes	Symm-Clashes
2	B	5	0	0	0	0
2	D	5	0	0	0	0
2	E	5	0	0	0	0
3	A	24	0	32	5	0
3	B	18	0	24	2	0
3	C	42	0	56	7	0
3	D	36	0	48	15	0
3	E	24	0	32	13	0
3	F	18	0	24	5	0
4	A	8	0	6	0	0
4	D	4	0	3	3	0
4	E	4	0	3	1	0
5	A	380	0	0	3	0
5	B	296	0	0	3	0
5	C	350	0	0	3	0
5	D	305	0	0	3	0
5	E	295	0	0	1	0
5	F	182	0	0	1	0
All	All	30404	0	27294	229	0

The all-atom clashscore is defined as the number of clashes found per 1000 atoms (including hydrogen atoms). The all-atom clashscore for this structure is 4.

All (229) close contacts within the same asymmetric unit are listed below, sorted by their clash magnitude.

Atom-1	Atom-2	Interatomic distance (Å)	Clash overlap (Å)
1:C:112:ASP:HB2	3:C:607:GOL:H32	1.41	1.01
1:D:32:ASN:HA	3:D:603:GOL:H11	1.45	0.99
1:D:58[A]:ILE:HD11	1:D:150:VAL:HG11	1.52	0.91
1:D:208:SER:H	3:D:603:GOL:H32	1.46	0.81
1:E:560:SER:HA	1:E:564:TRP:HB2	1.62	0.81
1:A:113:ARG:HH21	3:A:604:GOL:H12	1.50	0.77
1:D:33:PHE:H	3:D:603:GOL:H11	1.49	0.77
1:F:113:ARG:HB3	3:F:603:GOL:H12	1.66	0.75
1:D:208:SER:H	3:D:603:GOL:C3	2.01	0.74
1:D:423:ASP:HB3	1:D:426:THR:HG22	1.69	0.74
1:D:58[A]:ILE:HD11	1:D:150:VAL:CG1	2.18	0.72
1:D:583:LEU:HD22	3:D:605:GOL:H12	1.72	0.72
1:D:157:PRO:HG3	5:D:999:HOH:O	1.90	0.71
1:D:44:ARG:HG2	5:D:836:HOH:O	1.89	0.71
1:A:59:ARG:HD2	3:A:606:GOL:H12	1.72	0.71

Continued on next page...

Continued from previous page...

Atom-1	Atom-2	Interatomic distance (Å)	Clash overlap (Å)
1:B:251:LYS:HE3	1:B:253:ASP:OD2	1.91	0.70
1:E:32:ASN:HA	3:E:604:GOL:H32	1.73	0.69
1:D:58[A]:ILE:CD1	1:D:150:VAL:HG11	2.23	0.69
1:D:156:GLU:OE1	4:D:608:ACT:H2	1.93	0.69
1:E:208:SER:H	3:E:604:GOL:C1	2.06	0.68
1:D:33:PHE:N	3:D:603:GOL:H11	2.09	0.68
1:A:203:THR:HB	1:A:204:PRO:HD3	1.76	0.67
1:B:577:ASN:HB3	5:B:861:HOH:O	1.93	0.67
1:B:75:ARG:HG2	1:B:151:ASP:OD1	1.93	0.67
1:D:32:ASN:CA	3:D:603:GOL:H11	2.22	0.67
1:E:75:ARG:HG3	1:E:149:LEU:HD21	1.78	0.66
1:A:104:ARG:HH11	1:A:104:ARG:HG2	1.62	0.65
1:D:557:VAL:HG13	1:D:579:GLU:HB3	1.77	0.65
1:D:61:PHE:CZ	1:D:74:ARG:HG2	2.32	0.65
1:A:434:MET:CE	3:A:606:GOL:H2	2.26	0.65
1:E:333:ILE:HD13	1:E:354:VAL:HG22	1.79	0.65
1:C:183:TYR:HE2	1:C:185:GLU:HG2	1.62	0.64
1:D:392:TRP:HB3	1:D:418:LEU:HD11	1.79	0.64
1:C:112:ASP:HB2	3:C:607:GOL:C3	2.24	0.64
1:D:32:ASN:HA	3:D:603:GOL:C1	2.26	0.64
1:C:583:LEU:HD22	3:C:603:GOL:H32	1.81	0.62
1:A:434:MET:HE3	3:A:606:GOL:H2	1.80	0.62
1:A:61:PHE:CZ	1:A:74:ARG:HG2	2.35	0.62
1:C:348:LEU:HB2	1:C:405:VAL:HB	1.82	0.62
1:C:552:ASN:O	3:C:606:GOL:H2	2.00	0.62
1:D:381:GLU:OE2	3:D:606:GOL:H11	2.00	0.62
1:D:33:PHE:H	3:D:603:GOL:C1	2.11	0.62
1:E:559:ILE:O	1:E:564:TRP:HD1	1.84	0.61
1:C:58:ILE:HD11	1:C:150:VAL:HG13	1.82	0.61
1:E:392:TRP:HB3	1:E:418:LEU:HD11	1.84	0.60
1:D:208:SER:N	3:D:603:GOL:H32	2.16	0.60
1:F:348:LEU:HB2	1:F:405:VAL:HB	1.84	0.59
1:A:464:TYR:CD1	1:A:466:MET:HG2	2.37	0.59
1:B:294:ASN:HA	3:B:604:GOL:H11	1.85	0.59
1:E:113:ARG:HE	3:E:603:GOL:H32	1.66	0.59
1:B:175:GLU:HB3	1:B:176:PRO:HA	1.84	0.59
1:B:341:THR:HA	1:B:348:LEU:HD23	1.85	0.59
1:B:559:ILE:O	1:B:564:TRP:HD1	1.85	0.58
1:E:102:ARG:HH12	3:E:603:GOL:H12	1.69	0.58
1:C:233:TRP:HZ3	1:C:244:LEU:HD12	1.69	0.58
1:C:412:PRO:HB2	1:C:415:LEU:HG	1.84	0.58

Continued on next page...

Continued from previous page...

Atom-1	Atom-2	Interatomic distance (Å)	Clash overlap (Å)
1:D:365:LYS:HD3	3:D:606:GOL:H2	1.86	0.58
1:F:67:GLU:HG3	1:F:162:HIS:ND1	2.18	0.58
1:E:542:ASN:HB2	1:E:586:ASP:OD1	2.05	0.57
1:F:113:ARG:CB	3:F:603:GOL:H12	2.34	0.57
1:E:156:GLU:HG2	1:E:159:HIS:HB2	1.86	0.57
1:F:233:TRP:HZ3	1:F:244:LEU:HD23	1.70	0.56
1:B:333:ILE:HD13	1:B:354:VAL:HG22	1.86	0.56
1:D:575:GLU:HG3	1:D:578:VAL:HG21	1.88	0.56
1:D:65:LEU:HD21	1:D:74:ARG:NH1	2.21	0.56
1:A:74:ARG:HD2	1:A:152:ALA:HB3	1.88	0.55
1:B:500:LYS:HE3	1:B:571:TYR:CZ	2.42	0.55
1:E:449:TYR:OH	1:E:452:GLY:HA2	2.07	0.55
1:F:280:ILE:HD11	5:F:805:HOH:O	2.07	0.55
1:D:276:TYR:HB2	1:D:426:THR:OG1	2.06	0.55
1:D:276:TYR:CB	1:D:426:THR:HG1	2.19	0.55
1:E:377:ARG:CZ	1:E:408:LEU:HD21	2.37	0.55
1:C:1:MET:N	1:C:2:PRO:CD	2.69	0.55
1:A:1:MET:N	1:A:2:PRO:CD	2.70	0.55
1:B:75:ARG:NH2	5:B:701:HOH:O	2.40	0.55
1:A:104:ARG:HG2	1:A:104:ARG:NH1	2.21	0.54
1:D:113:ARG:HH21	3:D:604:GOL:H2	1.72	0.54
1:B:52:GLU:OE1	1:B:590:ARG:NH1	2.40	0.54
1:F:166:ARG:HG3	1:F:269:GLU:OE2	2.08	0.54
1:E:395:LYS:HD3	1:E:414:ASP:CG	2.28	0.54
1:E:208:SER:H	3:E:604:GOL:H11	1.73	0.54
1:D:41:ASN:O	1:D:44:ARG:NH1	2.41	0.54
1:E:33:PHE:H	3:E:604:GOL:H32	1.73	0.54
1:B:69:VAL:HG13	1:B:70:PRO:HD2	1.89	0.53
1:B:40:THR:HG21	1:B:210:PRO:HB3	1.89	0.53
1:C:371:ILE:HD12	1:C:372:ALA:N	2.23	0.53
1:F:539:GLU:OE1	1:F:539:GLU:N	2.34	0.53
1:A:202:ALA:HB1	5:A:713:HOH:O	2.08	0.53
1:D:58[A]:ILE:HG23	5:D:920:HOH:O	2.09	0.52
1:A:421:ILE:CD1	1:A:426:THR:HG21	2.39	0.52
1:E:75:ARG:CG	1:E:149:LEU:HD21	2.40	0.52
1:F:392:TRP:HB3	1:F:418:LEU:HD11	1.92	0.52
1:F:51:SER:HB3	1:F:57:ALA:HB2	1.91	0.51
1:E:51[A]:SER:HB2	1:E:57:ALA:HB2	1.91	0.51
1:F:203:THR:HB	1:F:204:PRO:HD3	1.93	0.50
1:B:392:TRP:HB3	1:B:418:LEU:HD11	1.93	0.50
1:A:395:LYS:HD2	1:A:414:ASP:CG	2.31	0.50

Continued on next page...

Continued from previous page...

Atom-1	Atom-2	Interatomic distance (Å)	Clash overlap (Å)
1:B:557:VAL:HG13	1:B:579:GLU:HB3	1.93	0.50
1:B:15:SER:HA	1:B:77:TYR:CE2	2.47	0.50
1:F:335:LEU:HB3	1:F:352:LEU:HG	1.93	0.50
1:F:263:TYR:CZ	3:F:602:GOL:H32	2.47	0.50
1:B:263:TYR:CZ	3:B:602:GOL:H32	2.47	0.49
1:E:13:LEU:HD23	1:E:76:ALA:HB2	1.94	0.49
1:A:302:VAL:O	1:A:303:ASN:HB2	2.12	0.49
1:B:564:TRP:CZ2	1:E:2:PRO:HA	2.47	0.49
1:F:500:LYS:HE3	1:F:571:TYR:CZ	2.48	0.49
1:A:410:ASN:N	1:A:411:PRO:HD3	2.28	0.49
1:C:58:ILE:HD11	1:C:150:VAL:CG1	2.41	0.49
1:C:467:LYS:NZ	3:C:603:GOL:H11	2.28	0.49
1:F:156:GLU:N	1:F:157:PRO:HD3	2.28	0.49
1:D:449:TYR:OH	1:D:452:GLY:HA2	2.13	0.48
1:E:98:LEU:HB2	1:E:120:ILE:HD13	1.95	0.48
1:E:32:ASN:CA	3:E:604:GOL:H32	2.43	0.48
1:A:450:TRP:HD1	5:A:724:HOH:O	1.95	0.48
1:C:233:TRP:CZ3	1:C:244:LEU:HD12	2.46	0.48
1:F:340:PHE:CE2	1:F:351:HIS:HB3	2.48	0.48
1:C:263:TYR:CZ	3:C:601:GOL:H11	2.48	0.48
1:D:51[B]:SER:OG	1:D:228:PHE:HE2	1.97	0.48
1:C:183:TYR:CE2	1:C:185:GLU:HG2	2.45	0.48
1:D:184:GLN:HB3	1:D:186:LEU:HD13	1.95	0.48
1:F:114:GLU:H	3:F:603:GOL:C3	2.27	0.47
1:A:85:GLN:HG2	5:A:727:HOH:O	2.14	0.47
1:E:575:GLU:HB2	1:E:578:VAL:HG21	1.95	0.47
1:F:61:PHE:CE1	1:F:248:ILE:HD13	2.49	0.47
1:D:583:LEU:HB3	3:D:605:GOL:H32	1.95	0.47
1:B:60:PHE:CD2	1:B:229:ALA:HA	2.50	0.47
1:D:426:THR:HG23	1:D:427:THR:N	2.30	0.47
1:F:61:PHE:CD1	1:F:248:ILE:HD13	2.48	0.47
1:E:131:ARG:HA	5:E:866:HOH:O	2.14	0.47
1:F:67:GLU:CG	1:F:162:HIS:ND1	2.78	0.47
1:E:208:SER:O	3:E:604:GOL:H11	2.14	0.47
1:D:426:THR:HG23	1:D:427:THR:H	1.80	0.47
1:E:33:PHE:H	3:E:604:GOL:C3	2.28	0.47
1:D:554:GLN:O	1:D:569:SER:HA	2.15	0.47
1:A:67:GLU:HG3	1:A:165:GLY:O	2.15	0.46
1:F:493:PHE:CD1	1:F:514:HIS:HB3	2.49	0.46
1:B:465:GLN:HG2	5:B:995:HOH:O	2.15	0.46
1:D:113:ARG:NH2	3:D:604:GOL:H2	2.29	0.46

Continued on next page...

Continued from previous page...

Atom-1	Atom-2	Interatomic distance (Å)	Clash overlap (Å)
1:E:271:GLU:HG2	1:E:430:GLN:NE2	2.30	0.46
1:B:242:ASN:HB3	1:B:245:ASP:OD2	2.15	0.46
1:F:35:GLU:HG2	1:F:210:PRO:HG3	1.96	0.46
1:E:33:PHE:N	3:E:604:GOL:H32	2.30	0.46
1:A:434:MET:HE2	3:A:606:GOL:H2	1.96	0.46
1:B:348:LEU:HB2	1:B:405:VAL:HB	1.98	0.46
1:A:348:LEU:HB2	1:A:405:VAL:HB	1.98	0.46
1:E:554:GLN:O	1:E:569:SER:HA	2.16	0.46
1:E:273:THR:HG21	1:E:431:PHE:HB2	1.98	0.46
1:C:1:MET:H3	1:C:2:PRO:HD3	1.81	0.45
1:A:393:ASN:HA	1:A:415:LEU:HD23	1.98	0.45
1:B:58:ILE:O	1:B:58:ILE:HG22	2.15	0.45
1:D:500:LYS:HE3	1:D:571:TYR:CZ	2.52	0.45
1:E:557:VAL:HG13	1:E:579:GLU:HB3	1.99	0.45
1:A:280:ILE:HD13	1:A:280:ILE:HA	1.79	0.45
1:B:576:SER:O	1:B:577:ASN:HB2	2.18	0.44
1:F:229:ALA:C	1:F:231:PRO:HD3	2.37	0.44
1:F:554:GLN:O	1:F:569:SER:HA	2.18	0.44
1:F:341:THR:HA	1:F:348:LEU:HD23	1.98	0.44
1:F:449:TYR:OH	1:F:452:GLY:HA2	2.17	0.44
1:A:71:GLU:HA	1:A:71:GLU:OE1	2.17	0.44
1:B:107:VAL:HG11	1:D:153:VAL:HG12	1.99	0.44
1:B:365:LYS:HD2	1:B:381:GLU:OE2	2.18	0.44
1:A:554:GLN:O	1:A:569:SER:HA	2.18	0.44
1:D:424:GLU:HG2	4:D:608:ACT:H3	1.99	0.44
1:E:233:TRP:CH2	1:E:244:LEU:HD12	2.53	0.44
1:E:51[B]:SER:OG	1:E:56:ALA:HB3	2.18	0.44
1:A:421:ILE:HD11	1:A:426:THR:HG21	1.99	0.43
1:B:564:TRP:CZ3	1:E:1:MET:N	2.80	0.43
1:D:16:PRO:O	1:D:20:PHE:HB2	2.17	0.43
1:F:365:LYS:HE3	1:F:379:SER:OG	2.18	0.43
1:B:542:ASN:HB2	1:B:586:ASP:OD1	2.17	0.43
1:F:367:THR:HA	1:F:368:PRO:HD3	1.87	0.43
1:B:16:PRO:O	1:B:20:PHE:HB2	2.17	0.43
1:B:412:PRO:HB2	1:B:415:LEU:HG	1.99	0.43
1:F:233:TRP:CZ3	1:F:243:PRO:HB2	2.52	0.43
1:D:51[A]:SER:OG	1:D:56:ALA:HB3	2.17	0.43
1:D:424:GLU:HG2	4:D:608:ACT:CH3	2.49	0.43
1:B:341:THR:HA	1:B:348:LEU:CD2	2.48	0.43
1:C:78:LEU:O	1:C:147:ALA:HA	2.18	0.43
1:D:276:TYR:CB	1:D:426:THR:OG1	2.67	0.43

Continued on next page...

Continued from previous page...

Atom-1	Atom-2	Interatomic distance (Å)	Clash overlap (Å)
1:E:113:ARG:NE	3:E:603:GOL:H32	2.31	0.43
1:F:16:PRO:O	1:F:20:PHE:HB2	2.19	0.43
1:D:333:ILE:HD13	1:D:354:VAL:HG22	2.00	0.43
1:D:281:LYS:HB2	1:D:416:GLU:OE1	2.18	0.43
1:D:198:THR:HB	1:D:199:PRO:HD2	2.00	0.43
1:D:341:THR:HA	1:D:348:LEU:HD23	2.00	0.43
1:F:114:GLU:H	3:F:603:GOL:H32	1.84	0.43
1:F:282:THR:O	1:F:283:GLN:HB2	2.19	0.43
1:E:149:LEU:C	1:E:149:LEU:HD13	2.40	0.42
1:F:297:VAL:HG22	1:F:352:LEU:HD13	2.01	0.42
1:A:201:ILE:H	1:A:201:ILE:HD12	1.82	0.42
1:D:273:THR:HG21	1:D:431:PHE:HB2	2.02	0.42
1:E:156:GLU:OE1	4:E:606:ACT:H3	2.19	0.42
1:A:73:PRO:HG3	5:C:833:HOH:O	2.19	0.42
1:D:187:GLN:OE1	1:D:187:GLN:HA	2.19	0.42
1:F:333:ILE:HD13	1:F:354:VAL:HG22	2.02	0.42
1:F:373:ILE:HG22	1:F:373:ILE:O	2.20	0.42
1:E:203:THR:HB	1:E:204:PRO:HA	2.02	0.42
1:F:410:ASN:N	1:F:411:PRO:HD3	2.35	0.42
1:D:133:TRP:CZ3	1:D:190:ALA:HB1	2.55	0.42
1:F:116:ALA:O	1:F:120:ILE:HG23	2.20	0.42
1:C:235:PRO:HA	1:C:236:PRO:HD3	1.95	0.42
1:F:365:LYS:HB2	1:F:365:LYS:HE3	1.82	0.42
1:C:40:THR:O	1:C:41:ASN:C	2.58	0.42
1:E:353:SER:OG	3:E:605:GOL:H11	2.19	0.42
1:A:74:ARG:HD2	1:A:152:ALA:CB	2.50	0.41
1:C:242:ASN:HA	1:C:243:PRO:HD3	1.90	0.41
1:F:154:PRO:HG2	1:F:157:PRO:HG3	2.02	0.41
1:F:273:THR:HG21	1:F:431:PHE:HB2	2.02	0.41
1:F:291:ASP:HA	1:F:292:PRO:HD3	1.90	0.41
1:F:78:LEU:O	1:F:147:ALA:HA	2.20	0.41
1:B:235:PRO:HA	1:B:236:PRO:HD3	1.94	0.41
1:F:75:ARG:HD3	1:F:151:ASP:OD1	2.20	0.41
1:C:367:THR:HG23	5:C:815:HOH:O	2.21	0.41
1:B:242:ASN:HA	1:B:243:PRO:HD3	1.93	0.41
1:D:51[B]:SER:OG	1:D:228:PHE:CE2	2.74	0.41
1:D:61:PHE:CE1	1:D:74:ARG:HG2	2.55	0.41
1:F:408:LEU:O	1:F:411:PRO:HD3	2.21	0.41
1:D:65:LEU:CD2	1:D:74:ARG:NH1	2.83	0.41
1:C:175:GLU:HB3	1:C:176:PRO:HA	2.02	0.41
1:C:2:PRO:HD3	1:C:536:PRO:HG3	2.03	0.41

Continued on next page...

Continued from previous page...

Atom-1	Atom-2	Interatomic distance (Å)	Clash overlap (Å)
1:C:467:LYS:HZ1	3:C:603:GOL:H11	1.86	0.41
1:C:367:THR:HA	1:C:368:PRO:HD3	1.91	0.41
1:E:113:ARG:HH21	3:E:603:GOL:H32	1.86	0.40
1:C:341:THR:HA	1:C:348:LEU:HD23	2.04	0.40
1:D:233:TRP:HZ3	1:D:244:LEU:HD23	1.85	0.40
1:C:371:ILE:HG13	5:C:845:HOH:O	2.22	0.40
1:F:483:PHE:HB3	1:F:493:PHE:CD2	2.56	0.40
1:B:302:VAL:O	1:B:303:ASN:HB2	2.21	0.40
1:D:175:GLU:OE1	1:D:175:GLU:HA	2.22	0.40

There are no symmetry-related clashes.

5.3 Torsion angles [i](#)

5.3.1 Protein backbone [i](#)

In the following table, the Percentiles column shows the percent Ramachandran outliers of the chain as a percentile score with respect to all X-ray entries followed by that with respect to entries of similar resolution.

The Analysed column shows the number of residues for which the backbone conformation was analysed, and the total number of residues.

Mol	Chain	Analysed	Favoured	Allowed	Outliers	Percentiles	
1	A	577/591 (98%)	558 (97%)	18 (3%)	1 (0%)	49	40
1	B	575/591 (97%)	556 (97%)	19 (3%)	0	100	100
1	C	569/591 (96%)	555 (98%)	14 (2%)	0	100	100
1	D	571/591 (97%)	554 (97%)	16 (3%)	1 (0%)	49	40
1	E	580/591 (98%)	565 (97%)	14 (2%)	1 (0%)	49	40
1	F	564/591 (95%)	540 (96%)	23 (4%)	1 (0%)	49	40
All	All	3436/3546 (97%)	3328 (97%)	104 (3%)	4 (0%)	53	44

All (4) Ramachandran outliers are listed below:

Mol	Chain	Res	Type
1	A	203	THR
1	E	219	SER
1	F	432	VAL
1	D	432	VAL

5.3.2 Protein sidechains [i](#)

In the following table, the Percentiles column shows the percent sidechain outliers of the chain as a percentile score with respect to all X-ray entries followed by that with respect to entries of similar resolution.

The Analysed column shows the number of residues for which the sidechain conformation was analysed, and the total number of residues.

Mol	Chain	Analysed	Rotameric	Outliers	Percentiles	
1	A	518/524 (99%)	515 (99%)	3 (1%)	87	88
1	B	516/524 (98%)	511 (99%)	5 (1%)	78	78
1	C	514/524 (98%)	509 (99%)	5 (1%)	78	78
1	D	516/524 (98%)	510 (99%)	6 (1%)	74	73
1	E	521/524 (99%)	516 (99%)	5 (1%)	78	78
1	F	513/524 (98%)	506 (99%)	7 (1%)	69	67
All	All	3098/3144 (98%)	3067 (99%)	31 (1%)	78	78

All (31) residues with a non-rotameric sidechain are listed below:

Mol	Chain	Res	Type
1	A	207	LEU
1	A	539	GLU
1	A	586	ASP
1	B	149	LEU
1	B	293	GLN
1	B	386	THR
1	B	465	GLN
1	B	539	GLU
1	C	244	LEU
1	C	262	GLN
1	C	399	SER
1	C	465	GLN
1	C	539	GLU
1	D	201	ILE
1	D	207	LEU
1	D	308	SER
1	D	416	GLU
1	D	465	GLN
1	D	478	LYS
1	E	72	HIS
1	E	175	GLU
1	E	408	LEU

Continued on next page...

Continued from previous page...

Mol	Chain	Res	Type
1	E	539	GLU
1	E	564	TRP
1	F	120	ILE
1	F	146	SER
1	F	251	LYS
1	F	328	LEU
1	F	352	LEU
1	F	383	LEU
1	F	465	GLN

Some sidechains can be flipped to improve hydrogen bonding and reduce clashes. There are no such sidechains identified.

5.3.3 RNA [i](#)

There are no RNA molecules in this entry.

5.4 Non-standard residues in protein, DNA, RNA chains [i](#)

There are no non-standard protein/DNA/RNA residues in this entry.

5.5 Carbohydrates [i](#)

There are no carbohydrates in this entry.

5.6 Ligand geometry [i](#)

36 ligands are modelled in this entry.

In the following table, the Counts columns list the number of bonds (or angles) for which Mogul statistics could be retrieved, the number of bonds (or angles) that are observed in the model and the number of bonds (or angles) that are defined in the Chemical Component Dictionary. The Link column lists molecule types, if any, to which the group is linked. The Z score for a bond length (or angle) is the number of standard deviations the observed value is removed from the expected value. A bond length (or angle) with $|Z| > 2$ is considered an outlier worth inspection. RMSZ is the root-mean-square of all Z scores of the bond lengths (or angles).

Mol	Type	Chain	Res	Link	Bond lengths			Bond angles		
					Counts	RMSZ	$\# Z > 2$	Counts	RMSZ	$\# Z > 2$
2	SO4	A	601	-	4,4,4	0.26	0	6,6,6	0.21	0
2	SO4	A	602	-	4,4,4	0.15	0	6,6,6	0.16	0

Mol	Type	Chain	Res	Link	Bond lengths			Bond angles		
					Counts	RMSZ	# Z > 2	Counts	RMSZ	# Z > 2
3	GOL	A	603	-	5,5,5	0.42	0	5,5,5	0.29	0
3	GOL	A	604	-	5,5,5	0.34	0	5,5,5	0.31	0
3	GOL	A	605	-	5,5,5	0.33	0	5,5,5	0.30	0
3	GOL	A	606	-	5,5,5	0.30	0	5,5,5	0.73	0
4	ACT	A	607	-	1,3,3	1.25	0	0,3,3	0.00	-
4	ACT	A	608	-	1,3,3	1.22	0	0,3,3	0.00	-
2	SO4	B	601	-	4,4,4	0.22	0	6,6,6	0.14	0
3	GOL	B	602	-	5,5,5	0.47	0	5,5,5	0.19	0
3	GOL	B	603	-	5,5,5	0.41	0	5,5,5	0.29	0
3	GOL	B	604	-	5,5,5	0.40	0	5,5,5	0.38	0
3	GOL	C	601	-	5,5,5	0.39	0	5,5,5	0.39	0
3	GOL	C	602	-	5,5,5	0.35	0	5,5,5	0.45	0
3	GOL	C	603	-	5,5,5	0.40	0	5,5,5	0.37	0
3	GOL	C	604	-	5,5,5	0.35	0	5,5,5	0.27	0
3	GOL	C	605	-	5,5,5	0.32	0	5,5,5	0.33	0
3	GOL	C	606	-	5,5,5	0.33	0	5,5,5	0.48	0
3	GOL	C	607	-	5,5,5	0.35	0	5,5,5	0.91	0
2	SO4	D	601	-	4,4,4	0.84	0	6,6,6	1.34	1 (16%)
3	GOL	D	602	-	5,5,5	0.34	0	5,5,5	0.56	0
3	GOL	D	603	-	5,5,5	0.36	0	5,5,5	0.63	0
3	GOL	D	604	-	5,5,5	0.33	0	5,5,5	0.26	0
3	GOL	D	605	-	5,5,5	0.34	0	5,5,5	0.23	0
3	GOL	D	606	-	5,5,5	0.37	0	5,5,5	0.23	0
3	GOL	D	607	-	5,5,5	0.33	0	5,5,5	0.32	0
4	ACT	D	608	-	1,3,3	1.11	0	0,3,3	0.00	-
2	SO4	E	601	-	4,4,4	0.17	0	6,6,6	0.26	0
3	GOL	E	602	-	5,5,5	0.41	0	5,5,5	0.27	0
3	GOL	E	603	-	5,5,5	0.35	0	5,5,5	0.28	0
3	GOL	E	604	-	5,5,5	0.56	0	5,5,5	0.80	0
3	GOL	E	605	-	5,5,5	0.31	0	5,5,5	0.37	0
4	ACT	E	606	-	1,3,3	1.07	0	0,3,3	0.00	-
3	GOL	F	601	-	5,5,5	0.39	0	5,5,5	0.28	0
3	GOL	F	602	-	5,5,5	0.41	0	5,5,5	0.31	0
3	GOL	F	603	-	5,5,5	0.31	0	5,5,5	0.27	0

In the following table, the Chirals column lists the number of chiral outliers, the number of chiral centers analysed, the number of these observed in the model and the number defined in the Chemical Component Dictionary. Similar counts are reported in the Torsion and Rings columns. '-' means no outliers of that kind were identified.

Mol	Type	Chain	Res	Link	Chirals	Torsions	Rings
2	SO4	A	601	-	-	0/0/0/0	0/0/0/0

Continued on next page...

Continued from previous page...

Mol	Type	Chain	Res	Link	Chirals	Torsions	Rings
2	SO4	A	602	-	-	0/0/0/0	0/0/0/0
3	GOL	A	603	-	-	0/4/4/4	0/0/0/0
3	GOL	A	604	-	-	0/4/4/4	0/0/0/0
3	GOL	A	605	-	-	0/4/4/4	0/0/0/0
3	GOL	A	606	-	-	0/4/4/4	0/0/0/0
4	ACT	A	607	-	-	0/0/0/0	0/0/0/0
4	ACT	A	608	-	-	0/0/0/0	0/0/0/0
2	SO4	B	601	-	-	0/0/0/0	0/0/0/0
3	GOL	B	602	-	-	0/4/4/4	0/0/0/0
3	GOL	B	603	-	-	0/4/4/4	0/0/0/0
3	GOL	B	604	-	-	0/4/4/4	0/0/0/0
3	GOL	C	601	-	-	0/4/4/4	0/0/0/0
3	GOL	C	602	-	-	0/4/4/4	0/0/0/0
3	GOL	C	603	-	-	0/4/4/4	0/0/0/0
3	GOL	C	604	-	-	0/4/4/4	0/0/0/0
3	GOL	C	605	-	-	0/4/4/4	0/0/0/0
3	GOL	C	606	-	-	0/4/4/4	0/0/0/0
3	GOL	C	607	-	-	0/4/4/4	0/0/0/0
2	SO4	D	601	-	-	0/0/0/0	0/0/0/0
3	GOL	D	602	-	-	0/4/4/4	0/0/0/0
3	GOL	D	603	-	-	0/4/4/4	0/0/0/0
3	GOL	D	604	-	-	0/4/4/4	0/0/0/0
3	GOL	D	605	-	-	0/4/4/4	0/0/0/0
3	GOL	D	606	-	-	0/4/4/4	0/0/0/0
3	GOL	D	607	-	-	0/4/4/4	0/0/0/0
4	ACT	D	608	-	-	0/0/0/0	0/0/0/0
2	SO4	E	601	-	-	0/0/0/0	0/0/0/0
3	GOL	E	602	-	-	0/4/4/4	0/0/0/0
3	GOL	E	603	-	-	0/4/4/4	0/0/0/0
3	GOL	E	604	-	-	0/4/4/4	0/0/0/0
3	GOL	E	605	-	-	0/4/4/4	0/0/0/0
4	ACT	E	606	-	-	0/0/0/0	0/0/0/0
3	GOL	F	601	-	-	0/4/4/4	0/0/0/0
3	GOL	F	602	-	-	0/4/4/4	0/0/0/0
3	GOL	F	603	-	-	0/4/4/4	0/0/0/0

There are no bond length outliers.

All (1) bond angle outliers are listed below:

Mol	Chain	Res	Type	Atoms	Z	Observed(°)	Ideal(°)
2	D	601	SO4	O4-S-O2	2.99	125.42	109.24

There are no chirality outliers.

There are no torsion outliers.

There are no ring outliers.

19 monomers are involved in 51 short contacts:

Mol	Chain	Res	Type	Clashes	Symm-Clashes
3	A	604	GOL	1	0
3	A	606	GOL	4	0
3	B	602	GOL	1	0
3	B	604	GOL	1	0
3	C	601	GOL	1	0
3	C	603	GOL	3	0
3	C	606	GOL	1	0
3	C	607	GOL	2	0
3	D	603	GOL	9	0
3	D	604	GOL	2	0
3	D	605	GOL	2	0
3	D	606	GOL	2	0
4	D	608	ACT	3	0
3	E	603	GOL	4	0
3	E	604	GOL	8	0
3	E	605	GOL	1	0
4	E	606	ACT	1	0
3	F	602	GOL	1	0
3	F	603	GOL	4	0

5.7 Other polymers [i](#)

There are no such residues in this entry.

5.8 Polymer linkage issues [i](#)

There are no chain breaks in this entry.

6 Fit of model and data

6.1 Protein, DNA and RNA chains

In the following table, the column labelled ‘#RSRZ > 2’ contains the number (and percentage) of RSRZ outliers, followed by percent RSRZ outliers for the chain as percentile scores relative to all X-ray entries and entries of similar resolution. The OWAB column contains the minimum, median, 95th percentile and maximum values of the occupancy-weighted average B-factor per residue. The column labelled ‘Q < 0.9’ lists the number of (and percentage) of residues with an average occupancy less than 0.9.

Mol	Chain	Analysed	<RSRZ>	#RSRZ>2	OWAB(Å ²)	Q<0.9
1	A	582/591 (98%)	0.04	20 (3%) 45 49	10, 19, 43, 65	0
1	B	580/591 (98%)	0.16	31 (5%) 26 30	12, 24, 51, 75	0
1	C	577/591 (97%)	-0.09	14 (2%) 59 62	12, 21, 44, 65	0
1	D	577/591 (97%)	0.10	28 (4%) 29 33	13, 23, 48, 74	0
1	E	582/591 (98%)	0.08	29 (4%) 29 32	14, 26, 52, 78	0
1	F	573/591 (96%)	0.34	46 (8%) 12 14	18, 32, 56, 84	0
All	All	3471/3546 (97%)	0.10	168 (4%) 30 34	10, 24, 50, 84	0

All (168) RSRZ outliers are listed below:

Mol	Chain	Res	Type	RSRZ
1	B	70	PRO	7.6
1	A	203	THR	6.4
1	F	347	GLN	6.0
1	A	345	ALA	6.0
1	F	72	HIS	5.8
1	C	345	ALA	5.6
1	F	70	PRO	5.5
1	C	236	PRO	5.4
1	E	236	PRO	5.3
1	F	71	GLU	5.2
1	B	69	VAL	5.2
1	F	573	LYS	5.1
1	D	413	SER	5.1
1	B	72	HIS	5.1
1	B	201	ILE	4.7
1	D	236	PRO	4.7
1	B	202	ALA	4.7
1	F	574	VAL	4.6
1	F	203	THR	4.6

Continued on next page...

Continued from previous page...

Mol	Chain	Res	Type	RSRZ
1	E	413	SER	4.6
1	D	70	PRO	4.6
1	D	574	VAL	4.5
1	B	68	TYR	4.5
1	A	573	LYS	4.5
1	C	413	SER	4.4
1	A	236	PRO	4.4
1	C	242	ASN	4.3
1	F	504	TYR	4.2
1	F	187	GLN	4.1
1	F	559	ILE	4.1
1	E	344	TYR	4.0
1	D	504	TYR	4.0
1	F	68	TYR	3.9
1	A	574	VAL	3.7
1	D	577	ASN	3.7
1	F	503	GLY	3.7
1	F	413	SER	3.7
1	D	68	TYR	3.6
1	B	346	GLY	3.6
1	B	236	PRO	3.6
1	F	235	PRO	3.6
1	B	187	GLN	3.5
1	E	560	SER	3.5
1	B	308	SER	3.5
1	D	201	ILE	3.5
1	A	413	SER	3.5
1	F	343	GLN	3.5
1	C	1	MET	3.4
1	E	201	ILE	3.4
1	F	242	ASN	3.4
1	F	538	VAL	3.4
1	A	308	SER	3.3
1	B	413	SER	3.3
1	F	243	PRO	3.3
1	F	564	TRP	3.3
1	E	308	SER	3.2
1	B	41	ASN	3.2
1	F	69	VAL	3.2
1	C	573	LYS	3.2
1	E	573	LYS	3.2
1	B	242	ASN	3.2

Continued on next page...

Continued from previous page...

Mol	Chain	Res	Type	RSRZ
1	B	345	ALA	3.1
1	E	574	VAL	3.1
1	E	346	GLY	3.1
1	A	464	TYR	3.1
1	B	235	PRO	3.1
1	C	187	GLN	3.1
1	E	72	HIS	3.1
1	E	70	PRO	3.1
1	F	236	PRO	3.0
1	D	202	ALA	3.0
1	B	280	ILE	3.0
1	C	2	PRO	3.0
1	D	235	PRO	3.0
1	C	538	VAL	3.0
1	F	44	ARG	2.9
1	C	308	SER	2.9
1	D	560	SER	2.9
1	E	280	ILE	2.9
1	A	69	VAL	2.9
1	E	244	LEU	2.9
1	E	242	ASN	2.9
1	D	186	LEU	2.9
1	A	346	GLY	2.9
1	D	573	LYS	2.9
1	F	342	THR	2.8
1	F	576	SER	2.8
1	F	293	GLN	2.8
1	C	243	PRO	2.8
1	E	243	PRO	2.8
1	E	424	GLU	2.8
1	E	395	LYS	2.7
1	D	72	HIS	2.7
1	E	504	TYR	2.7
1	E	71	GLU	2.7
1	F	462	TRP	2.7
1	B	246	LYS	2.7
1	A	344	TYR	2.6
1	A	68	TYR	2.6
1	D	203	THR	2.6
1	B	504	TYR	2.6
1	E	1	MET	2.5
1	A	303	ASN	2.5

Continued on next page...

Continued from previous page...

Mol	Chain	Res	Type	RSRZ
1	E	410	ASN	2.5
1	F	409	LYS	2.5
1	B	574	VAL	2.5
1	F	560	SER	2.5
1	E	303	ASN	2.5
1	E	414	ASP	2.5
1	D	347	GLN	2.5
1	F	186	LEU	2.5
1	F	397	GLY	2.4
1	B	185	GLU	2.4
1	A	243	PRO	2.4
1	D	561	GLY	2.4
1	B	44	ARG	2.4
1	B	576	SER	2.4
1	B	560	SER	2.4
1	D	397	GLY	2.4
1	A	242	ASN	2.4
1	F	17	GLU	2.4
1	F	451	ARG	2.4
1	F	74	ARG	2.3
1	E	235	PRO	2.3
1	B	245	ASP	2.3
1	F	21	GLU	2.3
1	D	414	ASP	2.3
1	F	575	GLU	2.3
1	F	508	TRP	2.3
1	E	503	GLY	2.3
1	A	504	TYR	2.3
1	E	245	ASP	2.3
1	B	564	TRP	2.3
1	B	410	ASN	2.3
1	A	503	GLY	2.2
1	B	71	GLU	2.2
1	D	280	ILE	2.2
1	D	559	ILE	2.2
1	B	281	LYS	2.2
1	F	245	ASP	2.2
1	D	398	GLY	2.2
1	A	201	ILE	2.2
1	D	75	ARG	2.2
1	B	243	PRO	2.2
1	D	308	SER	2.2

Continued on next page...

Continued from previous page...

Mol	Chain	Res	Type	RSRZ
1	D	281	LYS	2.2
1	D	503	GLY	2.2
1	B	17	GLU	2.2
1	A	235	PRO	2.2
1	E	281	LYS	2.2
1	F	204	PRO	2.2
1	F	244	LEU	2.2
1	F	450	TRP	2.2
1	F	506	TRP	2.2
1	F	140	ALA	2.2
1	F	3	ASN	2.2
1	C	574	VAL	2.2
1	C	346	GLY	2.1
1	F	572	ASP	2.1
1	E	246	LYS	2.1
1	A	410	ASN	2.1
1	D	303	ASN	2.1
1	C	244	LEU	2.1
1	D	3	ASN	2.1
1	E	564	TRP	2.1
1	F	410	ASN	2.1
1	B	440	PHE	2.0
1	F	182	HIS	2.0

6.2 Non-standard residues in protein, DNA, RNA chains [i](#)

There are no non-standard protein/DNA/RNA residues in this entry.

6.3 Carbohydrates [i](#)

There are no carbohydrates in this entry.

6.4 Ligands [i](#)

In the following table, the Atoms column lists the number of modelled atoms in the group and the number defined in the chemical component dictionary. The B-factors column lists the minimum, median, 95th percentile and maximum values of B factors of atoms in the group. The column labelled 'Q< 0.9' lists the number of atoms with occupancy less than 0.9.

Continued on next page...

Continued from previous page...

Mol	Type	Chain	Res	Atoms	RSCC	RSR	B-factors(Å ²)	Q<0.9
3	GOL	E	603	6/6	0.72	0.15	36,39,43,47	0
3	GOL	F	603	6/6	0.73	0.21	29,33,35,41	6
2	SO4	D	601	5/5	0.80	0.21	32,34,40,43	5
3	GOL	C	602	6/6	0.82	0.39	19,23,26,28	6
3	GOL	D	607	6/6	0.83	0.24	30,35,37,43	6
3	GOL	C	603	6/6	0.83	0.20	18,26,27,30	6
3	GOL	C	607	6/6	0.85	0.21	22,26,39,40	6
3	GOL	D	606	6/6	0.87	0.16	28,36,37,38	6
3	GOL	D	603	6/6	0.87	0.19	20,22,30,34	6
3	GOL	E	605	6/6	0.87	0.21	25,29,30,39	6
3	GOL	C	606	6/6	0.88	0.19	27,29,32,32	6
3	GOL	A	606	6/6	0.89	0.22	9,18,19,19	6
3	GOL	B	603	6/6	0.89	0.37	21,22,24,24	6
3	GOL	D	604	6/6	0.89	0.11	30,34,41,43	0
3	GOL	E	604	6/6	0.89	0.18	19,27,32,32	6
3	GOL	A	605	6/6	0.90	0.14	16,28,31,32	6
3	GOL	B	604	6/6	0.90	0.17	26,31,37,39	6
3	GOL	C	604	6/6	0.91	0.21	31,38,44,50	0
3	GOL	F	601	6/6	0.92	0.39	29,30,31,32	6
2	SO4	B	601	5/5	0.92	0.12	32,35,37,41	5
3	GOL	C	605	6/6	0.92	0.16	23,29,32,37	6
3	GOL	A	603	6/6	0.93	0.23	16,20,26,30	6
3	GOL	D	605	6/6	0.93	0.11	23,30,34,35	6
4	ACT	E	606	4/4	0.94	0.15	27,33,34,34	4
2	SO4	A	602	5/5	0.94	0.13	30,30,35,37	5
3	GOL	A	604	6/6	0.94	0.11	29,35,36,37	6
3	GOL	D	602	6/6	0.94	0.22	21,24,30,31	6
3	GOL	C	601	6/6	0.94	0.30	17,21,21,23	6
3	GOL	E	602	6/6	0.95	0.20	20,23,28,29	6
3	GOL	F	602	6/6	0.95	0.27	25,29,32,32	6
3	GOL	B	602	6/6	0.96	0.26	17,23,23,26	6
4	ACT	D	608	4/4	0.96	0.09	23,28,31,33	4
4	ACT	A	608	4/4	0.96	0.19	15,19,20,22	4
4	ACT	A	607	4/4	0.98	0.07	20,25,26,26	0
2	SO4	A	601	5/5	0.99	0.07	15,15,19,20	0
2	SO4	E	601	5/5	0.99	0.07	17,18,22,23	0

6.5 Other polymers [i](#)

There are no such residues in this entry.