



Full wwPDB X-ray Structure Validation Report ⓘ

Aug 24, 2023 – 12:12 PM EDT

PDB ID : 8TTK
Title : Tryptophan-6-halogenase BorH apo structure
Authors : Lingkon, K.; Bellizzi, J.J.
Deposited on : 2023-08-14
Resolution : 1.98 Å(reported)

This is a Full wwPDB X-ray Structure Validation Report for a publicly released PDB entry.

We welcome your comments at validation@mail.wwpdb.org

A user guide is available at

<https://www.wwpdb.org/validation/2017/XrayValidationReportHelp>

with specific help available everywhere you see the ⓘ symbol.

The types of validation reports are described at

<http://www.wwpdb.org/validation/2017/FAQs#types>.

The following versions of software and data (see [references ⓘ](#)) were used in the production of this report:

MolProbity : 4.02b-467
Mogul : 1.8.5 (274361), CSD as541be (2020)
Xtrriage (Phenix) : 1.13
EDS : 2.35
Percentile statistics : 20191225.v01 (using entries in the PDB archive December 25th 2019)
Refmac : 5.8.0158
CCP4 : 7.0.044 (Gargrove)
Ideal geometry (proteins) : Engh & Huber (2001)
Ideal geometry (DNA, RNA) : Parkinson et al. (1996)
Validation Pipeline (wwPDB-VP) : 2.35

1 Overall quality at a glance

The following experimental techniques were used to determine the structure:

X-RAY DIFFRACTION

The reported resolution of this entry is 1.98 Å.

Percentile scores (ranging between 0-100) for global validation metrics of the entry are shown in the following graphic. The table shows the number of entries on which the scores are based.

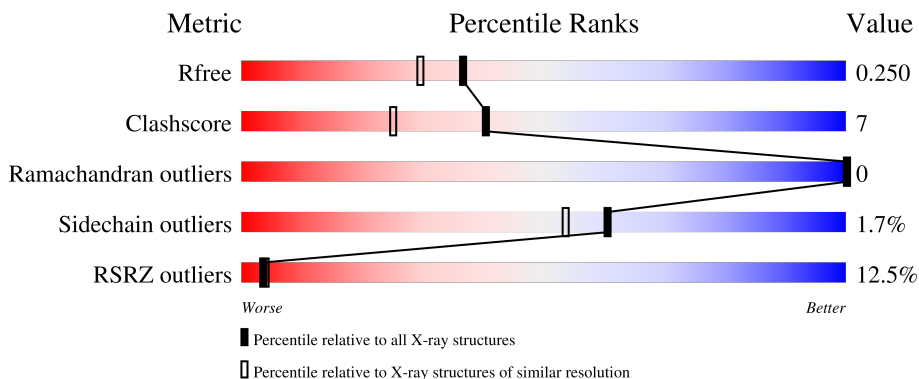

Metric	Whole archive (#Entries)	Similar resolution (#Entries, resolution range(Å))
R_{free}	130704	11647 (2.00-1.96)
Clashscore	141614	1014 (1.98-1.98)
Ramachandran outliers	138981	1006 (1.98-1.98)
Sidechain outliers	138945	1006 (1.98-1.98)
RSRZ outliers	127900	11410 (2.00-1.96)

The table below summarises the geometric issues observed across the polymeric chains and their fit to the electron density. The red, orange, yellow and green segments of the lower bar indicate the fraction of residues that contain outliers for ≥ 3 , 2, 1 and 0 types of geometric quality criteria respectively. A grey segment represents the fraction of residues that are not modelled. The numeric value for each fraction is indicated below the corresponding segment, with a dot representing fractions $\leq 5\%$. The upper red bar (where present) indicates the fraction of residues that have poor fit to the electron density. The numeric value is given above the bar.

Mol	Chain	Length	Quality of chain
1	A	529	 6% 87% 11% .
1	B	529	 11% 81% 16% ..
1	C	529	 13% 82% 16% ..
1	D	529	 19% 81% 16% ..

The following table lists non-polymeric compounds, carbohydrate monomers and non-standard

residues in protein, DNA, RNA chains that are outliers for geometric or electron-density-fit criteria:

Mol	Type	Chain	Res	Chirality	Geometry	Clashes	Electron density
2	SO4	A	605	-	-	X	-

2 Entry composition [i](#)

There are 3 unique types of molecules in this entry. The entry contains 17756 atoms, of which 0 are hydrogens and 0 are deuteriums.

In the tables below, the ZeroOcc column contains the number of atoms modelled with zero occupancy, the AltConf column contains the number of residues with at least one atom in alternate conformation and the Trace column contains the number of residues modelled with at most 2 atoms.

- Molecule 1 is a protein called Tryptophan 6-halogenase.

Mol	Chain	Residues	Atoms					ZeroOcc	AltConf	Trace
			Total	C	N	O	S			
1	A	521	Total 4188	C 2671	N 736	O 760	S 21	0	0	0
1	B	519	Total 4159	C 2656	N 728	O 754	S 21	0	0	0
1	C	519	Total 4156	C 2655	N 724	O 755	S 22	0	1	0
1	D	517	Total 4145	C 2648	N 727	O 748	S 22	0	1	0

- Molecule 2 is SULFATE ION (three-letter code: SO4) (formula: O₄S).



Mol	Chain	Residues	Atoms			ZeroOcc	AltConf
			Total	O	S		
2	A	1	Total 5	O 4	S 1	0	0
2	A	1	Total 5	O 4	S 1	0	0

Continued on next page...

Continued from previous page...

Mol	Chain	Residues	Atoms			ZeroOcc	AltConf
2	A	1	Total	O	S	0	0
			5	4	1		
2	A	1	Total	O	S	0	0
			5	4	1		
2	A	1	Total	O	S	0	0
			5	4	1		
2	A	1	Total	O	S	0	0
			5	4	1		
2	B	1	Total	O	S	0	0
			5	4	1		
2	B	1	Total	O	S	0	0
			5	4	1		
2	B	1	Total	O	S	0	0
			5	4	1		
2	B	1	Total	O	S	0	0
			5	4	1		
2	B	1	Total	O	S	0	0
			5	4	1		
2	C	1	Total	O	S	0	0
			5	4	1		
2	C	1	Total	O	S	0	0
			5	4	1		
2	D	1	Total	O	S	0	0
			5	4	1		
2	D	1	Total	O	S	0	0
			5	4	1		
2	D	1	Total	O	S	0	0
			5	4	1		

- Molecule 3 is water.

Mol	Chain	Residues	Atoms		ZeroOcc	AltConf
3	A	344	Total	O	0	0
			344	344		
3	B	306	Total	O	0	0
			306	306		
3	C	216	Total	O	0	0
			216	216		
3	D	162	Total	O	0	0
			162	162		

3 Residue-property plots i

These plots are drawn for all protein, RNA, DNA and oligosaccharide chains in the entry. The first graphic for a chain summarises the proportions of the various outlier classes displayed in the second graphic. The second graphic shows the sequence view annotated by issues in geometry and electron density. Residues are color-coded according to the number of geometric quality criteria for which they contain at least one outlier: green = 0, yellow = 1, orange = 2 and red = 3 or more. A red dot above a residue indicates a poor fit to the electron density ($RSRZ > 2$). Stretches of 2 or more consecutive residues without any outlier are shown as a green connector. Residues present in the sample, but not in the model, are shown in grey.

- Molecule 1: Tryptophan 6-halogenase

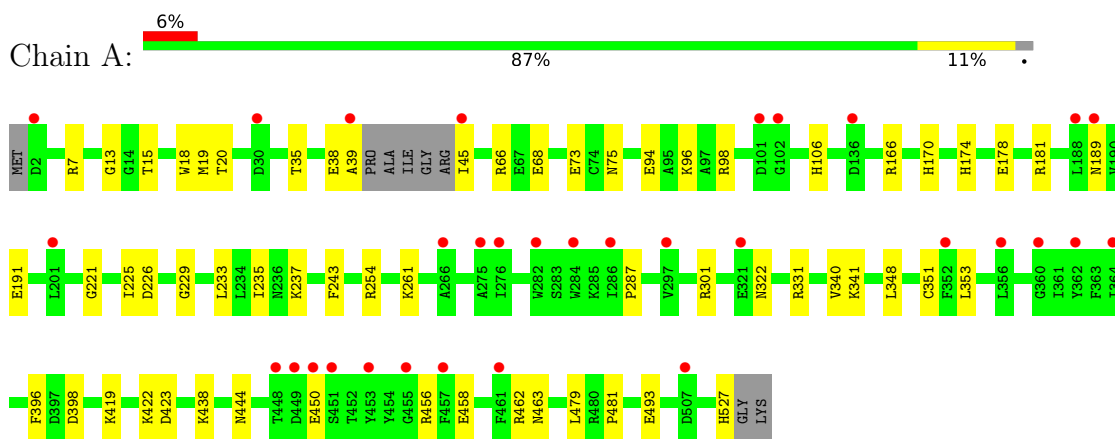

- Molecule 1: Tryptophan 6-halogenase

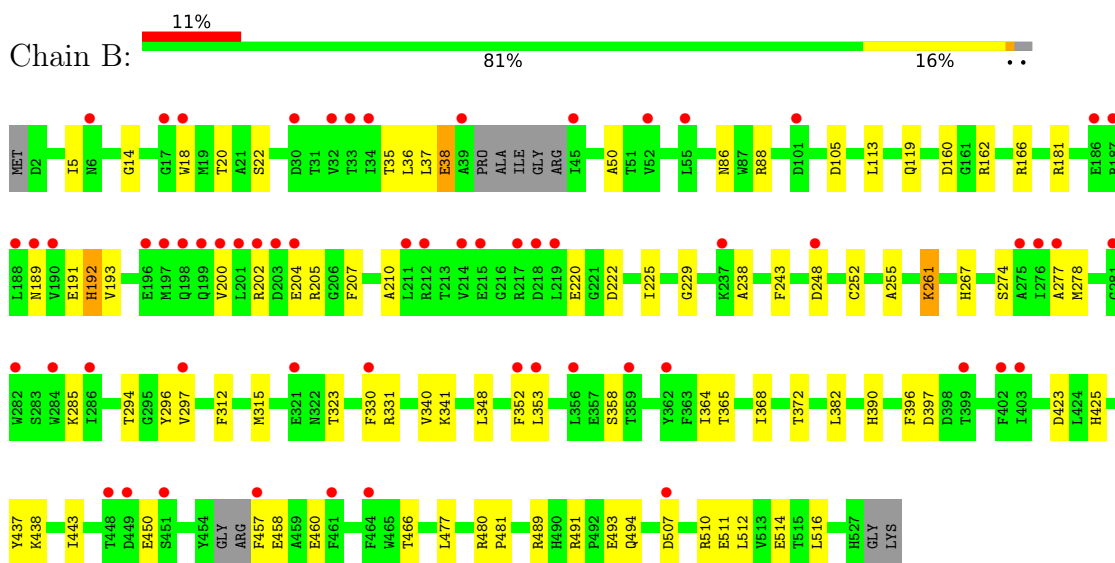

- Molecule 1: Tryptophan 6-halogenase

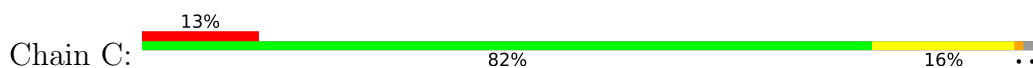

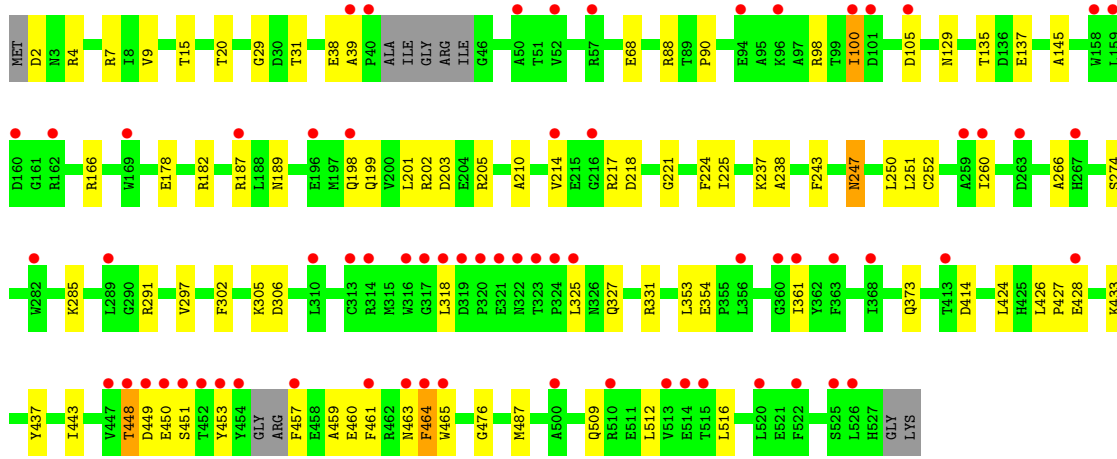

• Molecule 1: Tryptophan 6-halogenase

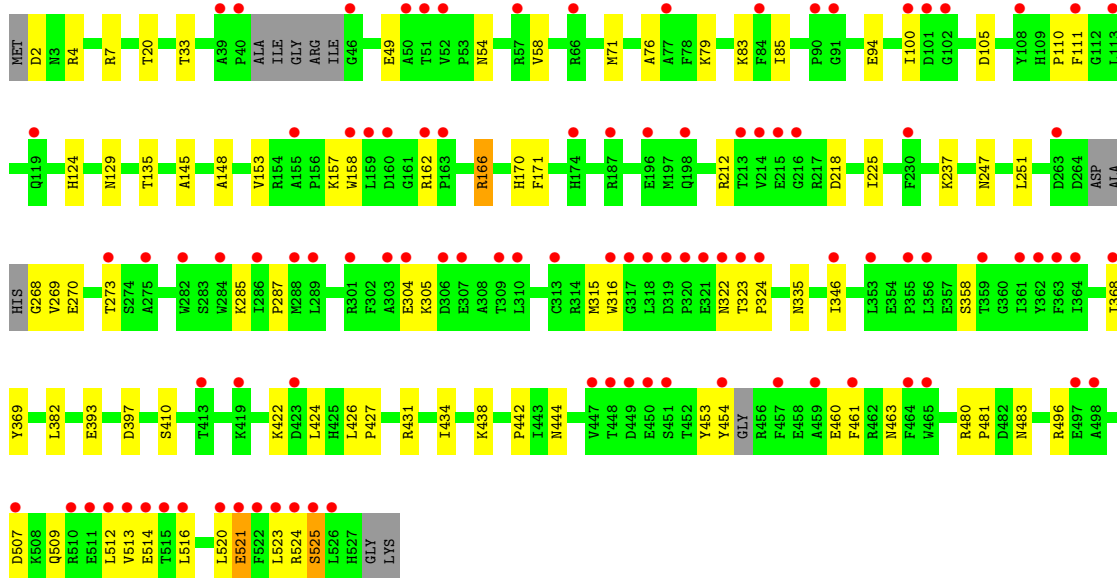
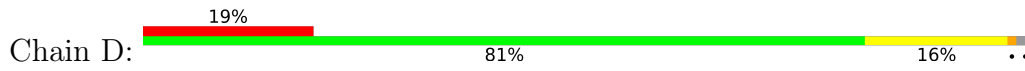

4 Data and refinement statistics

Property	Value	Source
Space group	P 1 21 1	Depositor
Cell constants a, b, c, α , β , γ	73.74Å 157.58Å 112.97Å 90.00° 104.25° 90.00°	Depositor
Resolution (Å)	37.92 – 1.98 37.92 – 1.98	Depositor EDS
% Data completeness (in resolution range)	95.0 (37.92-1.98) 95.0 (37.92-1.98)	Depositor EDS
R_{merge}	0.10	Depositor
R_{sym}	(Not available)	Depositor
$\langle I/\sigma(I) \rangle$ ¹	1.29 (at 1.98Å)	Xtrriage
Refinement program	PHENIX 1.19.2_4158	Depositor
R, R_{free}	0.221 , 0.249 0.221 , 0.250	Depositor DCC
R_{free} test set	1997 reflections (1.21%)	wwPDB-VP
Wilson B-factor (Å ²)	26.2	Xtrriage
Anisotropy	0.699	Xtrriage
Bulk solvent k_{sol} (e/Å ³), B_{sol} (Å ²)	0.34 , 46.5	EDS
L-test for twinning ²	$\langle L \rangle = 0.45$, $\langle L^2 \rangle = 0.28$	Xtrriage
Estimated twinning fraction	No twinning to report.	Xtrriage
F_o, F_c correlation	0.94	EDS
Total number of atoms	17756	wwPDB-VP
Average B, all atoms (Å ²)	39.0	wwPDB-VP

Xtrriage's analysis on translational NCS is as follows: *The largest off-origin peak in the Patterson function is 19.48% of the height of the origin peak. No significant pseudotranslation is detected.*

¹Intensities estimated from amplitudes.

²Theoretical values of $\langle |L| \rangle$, $\langle L^2 \rangle$ for acentric reflections are 0.5, 0.333 respectively for untwinned datasets, and 0.375, 0.2 for perfectly twinned datasets.

5 Model quality [i](#)

5.1 Standard geometry [i](#)

Bond lengths and bond angles in the following residue types are not validated in this section: SO4

The Z score for a bond length (or angle) is the number of standard deviations the observed value is removed from the expected value. A bond length (or angle) with $|Z| > 5$ is considered an outlier worth inspection. RMSZ is the root-mean-square of all Z scores of the bond lengths (or angles).

Mol	Chain	Bond lengths		Bond angles	
		RMSZ	# Z >5	RMSZ	# Z >5
1	A	0.28	0/4305	0.53	0/5844
1	B	0.27	0/4275	0.53	0/5805
1	C	0.28	0/4276	0.52	0/5808
1	D	0.26	0/4263	0.52	0/5787
All	All	0.27	0/17119	0.52	0/23244

There are no bond length outliers.

There are no bond angle outliers.

There are no chirality outliers.

There are no planarity outliers.

5.2 Too-close contacts [i](#)

In the following table, the Non-H and H(model) columns list the number of non-hydrogen atoms and hydrogen atoms in the chain respectively. The H(added) column lists the number of hydrogen atoms added and optimized by MolProbity. The Clashes column lists the number of clashes within the asymmetric unit, whereas Symm-Clashes lists symmetry-related clashes.

Mol	Chain	Non-H	H(model)	H(added)	Clashes	Symm-Clashes
1	A	4188	0	4029	41	0
1	B	4159	0	3993	60	0
1	C	4156	0	3983	67	0
1	D	4145	0	3986	63	0
2	A	30	0	0	3	0
2	B	25	0	0	2	0
2	C	10	0	0	1	0
2	D	15	0	0	0	0
3	A	344	0	0	13	0

Continued on next page...

Continued from previous page...

Mol	Chain	Non-H	H(model)	H(added)	Clashes	Symm-Clashes
3	B	306	0	0	21	0
3	C	216	0	0	36	0
3	D	162	0	0	21	1
All	All	17756	0	15991	234	1

The all-atom clashscore is defined as the number of clashes found per 1000 atoms (including hydrogen atoms). The all-atom clashscore for this structure is 7.

All (234) close contacts within the same asymmetric unit are listed below, sorted by their clash magnitude.

Atom-1	Atom-2	Interatomic distance (Å)	Clash overlap (Å)
1:D:4:ARG:NH1	3:D:702:HOH:O	2.05	0.90
2:C:601:SO4:O2	3:C:701:HOH:O	1.89	0.89
1:D:315:MET:O	3:D:701:HOH:O	1.89	0.89
1:C:2:ASP:N	3:C:711:HOH:O	2.07	0.85
1:C:218:ASP:O	3:C:702:HOH:O	1.94	0.85
1:D:480:ARG:NH2	3:D:706:HOH:O	2.09	0.84
1:C:354:GLU:OE2	3:C:705:HOH:O	1.97	0.82
1:C:453:TYR:OH	3:C:703:HOH:O	1.96	0.82
1:C:305:LYS:NZ	3:C:713:HOH:O	2.11	0.82
1:C:199:GLN:OE1	3:C:704:HOH:O	1.96	0.81
1:B:372:THR:O	3:B:701:HOH:O	1.99	0.80
1:B:466:THR:OG1	3:B:702:HOH:O	2.00	0.79
1:C:203:ASP:OD2	1:C:205:ARG:NH1	2.16	0.79
1:B:323:THR:O	3:B:703:HOH:O	2.00	0.78
1:C:460:GLU:O	3:C:706:HOH:O	2.00	0.78
1:B:119:GLN:NE2	3:B:705:HOH:O	2.08	0.78
1:C:459:ALA:O	3:C:708:HOH:O	2.04	0.75
1:C:464:PHE:O	3:C:707:HOH:O	2.02	0.75
1:C:238:ALA:O	3:C:709:HOH:O	2.05	0.75
2:B:602:SO4:O1	3:B:704:HOH:O	2.04	0.75
1:C:217:ARG:NH1	3:C:702:HOH:O	2.20	0.74
1:D:304:GLU:OE1	3:D:703:HOH:O	2.05	0.74
2:A:604:SO4:O1	3:A:701:HOH:O	2.05	0.73
1:C:463:ASN:O	3:C:703:HOH:O	2.05	0.73
1:C:68:GLU:OE2	3:C:710:HOH:O	2.05	0.73
1:A:73:GLU:OE1	3:A:704:HOH:O	2.07	0.73
1:B:491:ARG:NH1	3:B:706:HOH:O	2.10	0.73
1:A:398:ASP:OD1	3:A:702:HOH:O	2.05	0.73
1:A:94:GLU:OE1	3:A:703:HOH:O	2.06	0.73
1:D:393:GLU:OE1	3:D:704:HOH:O	2.08	0.71

Continued on next page...

Continued from previous page...

Atom-1	Atom-2	Interatomic distance (Å)	Clash overlap (Å)
1:A:322:ASN:ND2	3:A:707:HOH:O	2.25	0.70
1:C:448:THR:O	3:C:712:HOH:O	2.10	0.70
1:D:480:ARG:NH2	3:D:714:HOH:O	2.24	0.69
1:D:397:ASP:OD2	3:D:705:HOH:O	2.09	0.68
1:B:397:ASP:OD2	3:B:707:HOH:O	2.11	0.68
1:C:437:TYR:HB2	1:C:443:ILE:HD11	1.76	0.67
1:D:2:ASP:N	3:D:715:HOH:O	2.26	0.67
1:B:480:ARG:NH2	3:B:713:HOH:O	2.28	0.67
1:A:398:ASP:OD1	3:A:705:HOH:O	2.13	0.67
1:D:71:MET:SD	3:D:752:HOH:O	2.52	0.66
1:B:248:ASP:OD2	3:B:708:HOH:O	2.14	0.65
1:C:461:PHE:O	3:C:715:HOH:O	2.13	0.65
1:B:181:ARG:NH2	3:B:717:HOH:O	2.30	0.65
1:A:189:ASN:ND2	3:A:709:HOH:O	2.30	0.65
1:B:50:ALA:O	3:B:709:HOH:O	2.14	0.65
1:C:145:ALA:HA	1:C:509:GLN:HG3	1.79	0.65
1:D:444:ASN:ND2	1:D:463:ASN:OD1	2.30	0.65
1:C:137:GLU:OE1	3:C:716:HOH:O	2.15	0.64
1:D:100:ILE:HD11	1:D:105:ASP:HA	1.78	0.64
1:C:373:GLN:NE2	3:C:724:HOH:O	2.27	0.64
1:C:39:ALA:O	3:C:717:HOH:O	2.15	0.64
1:B:341:LYS:NZ	3:B:719:HOH:O	2.32	0.63
1:C:426:LEU:HD12	1:C:427:PRO:HD2	1.81	0.62
1:B:494:GLN:HG3	3:B:715:HOH:O	1.99	0.62
1:D:157:LYS:NZ	3:D:717:HOH:O	2.32	0.61
1:A:166:ARG:HH21	1:A:450:GLU:HG2	1.64	0.61
1:D:71:MET:HG2	1:D:76:ALA:HB3	1.83	0.60
1:A:254:ARG:NH2	3:A:711:HOH:O	2.31	0.60
1:C:189:ASN:ND2	3:C:725:HOH:O	2.29	0.60
1:B:20:THR:HG21	1:B:225:ILE:HG21	1.83	0.59
1:D:166:ARG:HD3	1:D:454:TYR:CE2	2.37	0.59
1:C:457:PHE:N	3:C:730:HOH:O	2.35	0.58
1:B:460:GLU:OE2	3:B:710:HOH:O	2.17	0.58
1:C:7:ARG:HB2	1:C:221:GLY:HA2	1.86	0.57
1:D:461:PHE:O	3:D:709:HOH:O	2.17	0.57
1:B:297:VAL:HG13	1:B:330:PHE:HE2	1.68	0.57
1:B:189:ASN:ND2	3:B:712:HOH:O	2.27	0.57
1:C:68:GLU:H	1:C:68:GLU:CD	2.08	0.56
1:D:507:ASP:OD1	3:D:708:HOH:O	2.17	0.56
1:A:181:ARG:NH2	3:A:715:HOH:O	2.34	0.56
1:C:464:PHE:HB2	3:C:706:HOH:O	2.05	0.55

Continued on next page...

Continued from previous page...

Atom-1	Atom-2	Interatomic distance (Å)	Clash overlap (Å)
1:C:464:PHE:N	3:C:706:HOH:O	2.30	0.55
1:C:305:LYS:HD3	1:C:327:GLN:HG2	1.89	0.55
1:D:496:ARG:NH2	3:D:720:HOH:O	2.40	0.54
1:A:39:ALA:HB3	3:A:969:HOH:O	2.08	0.54
1:A:166:ARG:NH2	1:A:450:GLU:HG2	2.23	0.53
1:B:210:ALA:HB2	1:B:220:GLU:HG2	1.91	0.53
1:B:160:ASP:OD1	1:B:162:ARG:HG3	2.09	0.53
1:B:489:ARG:NE	3:B:723:HOH:O	2.39	0.53
1:D:166:ARG:HD3	1:D:454:TYR:CD2	2.44	0.53
1:B:113:LEU:HG	1:B:450:GLU:HG3	1.91	0.53
1:A:20:THR:HG21	1:A:225:ILE:HG21	1.91	0.52
1:A:340:VAL:HG12	1:A:341:LYS:HG3	1.90	0.52
1:D:212:ARG:NH1	1:D:218:ASP:OD1	2.42	0.52
1:A:66:ARG:NE	2:A:605:SO4:O4	2.42	0.52
1:B:507:ASP:O	1:B:511:GLU:HG3	2.09	0.52
1:C:251:LEU:HD13	1:C:302:PHE:HE2	1.74	0.52
1:D:145:ALA:HA	1:D:509:GLN:HG3	1.92	0.52
1:A:7:ARG:HB2	1:A:221:GLY:HA2	1.91	0.52
1:A:229:GLY:HA2	1:A:348:LEU:HB2	1.91	0.52
1:D:20:THR:HG21	1:D:225:ILE:HG21	1.91	0.52
1:D:346:ILE:HD13	1:D:368:ILE:HG13	1.93	0.51
1:B:243:PHE:CZ	1:B:331:ARG:HG2	2.45	0.51
1:B:255:ALA:HB2	1:B:330:PHE:CZ	2.46	0.51
1:C:4:ARG:NE	3:C:719:HOH:O	2.41	0.51
1:B:437:TYR:HB2	1:B:443:ILE:HD11	1.92	0.51
1:C:198:GLN:HG2	1:C:199:GLN:HG3	1.92	0.51
1:C:433:LYS:NZ	3:C:740:HOH:O	2.44	0.51
1:D:513:VAL:HG13	1:D:514:GLU:HG3	1.93	0.51
1:B:425:HIS:ND1	2:B:605:SO4:O1	2.44	0.50
1:B:423:ASP:HB2	3:B:751:HOH:O	2.12	0.50
1:C:428:GLU:OE1	3:C:718:HOH:O	2.19	0.50
1:D:54:ASN:O	1:D:58:VAL:HG12	2.10	0.50
1:D:148:ALA:HB2	1:D:509:GLN:HG2	1.94	0.50
1:C:202:ARG:NH2	3:C:741:HOH:O	2.44	0.49
1:A:301:ARG:NH2	3:A:726:HOH:O	2.41	0.49
1:C:237:LYS:HE2	1:C:237:LYS:HA	1.93	0.49
1:D:158:TRP:HE3	1:D:162:ARG:HB3	1.77	0.49
1:A:174:HIS:O	1:A:178:GLU:HG2	2.13	0.49
1:B:5:ILE:HG23	1:B:222:ASP:HB2	1.94	0.49
1:B:18:TRP:CZ2	1:B:181:ARG:HG3	2.47	0.49
1:C:31:THR:O	3:C:719:HOH:O	2.20	0.49

Continued on next page...

Continued from previous page...

Atom-1	Atom-2	Interatomic distance (Å)	Clash overlap (Å)
1:B:274:SER:HB2	1:B:285:LYS:HB3	1.95	0.49
1:C:318:LEU:HA	3:C:738:HOH:O	2.13	0.49
1:D:110:PRO:O	3:D:711:HOH:O	2.20	0.49
1:D:512:LEU:HD22	1:D:516:LEU:HD11	1.95	0.49
1:D:323:THR:O	3:D:710:HOH:O	2.20	0.48
1:D:285:LYS:HD2	1:D:316:TRP:HH2	1.76	0.48
1:A:94:GLU:OE2	1:A:98:ARG:NH1	2.43	0.48
1:C:20:THR:HG21	1:C:225:ILE:HG21	1.96	0.48
1:C:449:ASP:O	1:C:453:TYR:N	2.47	0.48
1:B:200:VAL:HG12	1:B:202:ARG:HG3	1.95	0.48
1:A:419:LYS:HE3	1:A:419:LYS:HB2	1.67	0.48
1:D:268:GLY:N	3:D:726:HOH:O	2.47	0.47
1:D:49:GLU:N	1:D:171:PHE:O	2.44	0.47
1:C:15:THR:HG21	1:C:361:ILE:HD11	1.96	0.47
1:B:18:TRP:O	1:B:22:SER:OG	2.25	0.47
1:C:457:PHE:HA	3:C:854:HOH:O	2.14	0.47
1:B:166:ARG:HD3	3:B:930:HOH:O	2.14	0.47
1:A:261:LYS:HB3	1:A:261:LYS:HE2	1.65	0.47
1:B:20:THR:OG1	1:B:368:ILE:HD11	2.15	0.47
1:C:98:ARG:O	1:C:105:ASP:N	2.42	0.46
1:C:38:GLU:OE1	3:C:717:HOH:O	2.20	0.46
1:D:335:ASN:HB2	3:D:758:HOH:O	2.14	0.46
1:C:247:ASN:ND2	1:C:250:LEU:O	2.45	0.46
1:D:83:LYS:HD3	1:D:85:ILE:HD11	1.97	0.46
1:B:277:ALA:O	1:B:278:MET:HE2	2.15	0.46
1:C:465:TRP:HA	1:C:465:TRP:CE3	2.50	0.46
1:A:15:THR:O	1:A:19:MET:HG3	2.15	0.46
1:A:106:HIS:CE1	3:A:917:HOH:O	2.69	0.46
1:C:260:ILE:HD11	1:C:318:LEU:HD11	1.97	0.46
1:C:100:ILE:HD11	1:C:105:ASP:HA	1.98	0.46
1:A:462:ARG:HD3	1:A:462:ARG:HA	1.73	0.45
1:D:7:ARG:HG2	1:D:33:THR:OG1	2.15	0.45
1:C:325:LEU:HD23	1:C:327:GLN:HE22	1.81	0.45
1:A:243:PHE:CE2	1:A:331:ARG:HG2	2.51	0.45
1:B:510:ARG:O	1:B:514:GLU:HG2	2.16	0.45
1:C:199:GLN:NE2	3:C:704:HOH:O	2.49	0.45
1:C:424:LEU:HD12	3:C:823:HOH:O	2.16	0.45
1:D:79:LYS:NZ	1:D:358:SER:OG	2.50	0.45
1:D:369:TYR:OH	3:D:712:HOH:O	2.20	0.45
1:D:520:LEU:O	1:D:524:ARG:HG2	2.16	0.45
1:A:456:ARG:NE	1:A:458:GLU:OE1	2.41	0.45

Continued on next page...

Continued from previous page...

Atom-1	Atom-2	Interatomic distance (Å)	Clash overlap (Å)
1:B:425:HIS:HB3	3:B:923:HOH:O	2.17	0.45
1:D:129:ASN:HB3	1:D:135:THR:HG22	1.99	0.44
1:C:457:PHE:HE1	1:C:461:PHE:CD1	2.36	0.44
1:C:166:ARG:NH2	1:C:450:GLU:HG2	2.32	0.44
1:B:438:LYS:HA	1:B:481:PRO:HA	1.98	0.44
1:B:457:PHE:CD2	1:B:458:GLU:N	2.86	0.44
1:A:35:THR:HG23	1:A:191:GLU:HG2	1.99	0.44
1:B:340:VAL:HG12	1:B:341:LYS:HG2	2.00	0.44
1:B:200:VAL:HG21	1:B:238:ALA:HB2	1.98	0.44
1:C:512:LEU:HD22	1:C:516:LEU:HD11	2.00	0.44
1:D:453:TYR:CE1	1:D:460:GLU:HA	2.52	0.44
1:B:35:THR:HG22	1:B:191:GLU:HB3	1.98	0.43
1:D:170:HIS:NE2	1:D:273:THR:OG1	2.44	0.43
1:B:512:LEU:HD22	1:B:516:LEU:HD11	2.00	0.43
1:B:38:GLU:HG3	1:B:192:HIS:CE1	2.52	0.43
1:B:229:GLY:HA2	1:B:348:LEU:HB2	2.01	0.43
1:D:251:LEU:HD21	1:D:424:LEU:HD21	2.01	0.43
1:A:170:HIS:CE1	1:A:287:PRO:HD2	2.54	0.43
1:B:14:GLY:N	3:B:729:HOH:O	2.43	0.43
1:C:90:PRO:HB3	1:C:414:ASP:HB3	1.99	0.43
1:C:252:CYS:HB3	1:C:297:VAL:HG12	2.01	0.43
1:C:129:ASN:HB3	1:C:135:THR:HG22	2.01	0.43
1:D:438:LYS:HA	1:D:481:PRO:HA	2.01	0.43
1:B:86:ASN:HA	1:B:105:ASP:OD2	2.19	0.43
1:D:153:VAL:HG12	1:D:270:GLU:HA	2.01	0.43
1:D:431:ARG:NH1	3:D:721:HOH:O	2.40	0.43
1:B:204:GLU:H	1:B:204:GLU:CD	2.22	0.43
1:C:274:SER:HB2	1:C:285:LYS:HB3	2.01	0.43
1:D:521:GLU:O	1:D:525:SER:OG	2.36	0.43
1:B:493:GLU:OE1	1:B:493:GLU:N	2.47	0.43
1:C:29:GLY:O	3:C:722:HOH:O	2.22	0.43
1:D:285:LYS:HD2	1:D:316:TRP:CH2	2.53	0.43
1:A:444:ASN:HB3	1:A:463:ASN:OD1	2.19	0.43
1:C:9:VAL:HB	1:C:224:PHE:CD2	2.54	0.43
1:C:266:ALA:O	3:C:720:HOH:O	2.21	0.42
1:D:410:SER:O	1:D:422:LYS:NZ	2.46	0.42
1:B:88:ARG:HD3	1:B:477:LEU:C	2.39	0.42
1:B:181:ARG:HD2	1:B:192:HIS:CD2	2.55	0.42
1:D:237:LYS:HA	1:D:237:LYS:HD3	1.78	0.42
1:D:269:VAL:HG21	1:D:523:LEU:HD12	2.02	0.42
1:D:316:TRP:HA	3:D:701:HOH:O	2.18	0.42

Continued on next page...

Continued from previous page...

Atom-1	Atom-2	Interatomic distance (Å)	Clash overlap (Å)
1:A:226:ASP:OD2	1:A:235:ILE:HG22	2.20	0.42
1:B:205:ARG:HG3	1:B:207:PHE:CD1	2.55	0.42
1:B:353:LEU:HG	1:B:396:PHE:CE1	2.53	0.42
1:C:243:PHE:CE2	1:C:331:ARG:HG2	2.55	0.41
1:D:158:TRP:CD1	1:D:516:LEU:HD23	2.55	0.41
1:B:364:ILE:O	1:B:368:ILE:HG12	2.20	0.41
1:A:351:CYS:HB2	1:A:396:PHE:CE2	2.55	0.41
1:B:252:CYS:HB3	1:B:297:VAL:HG12	2.01	0.41
1:D:158:TRP:CE3	1:D:162:ARG:HB3	2.55	0.41
1:D:305:LYS:HB2	1:D:305:LYS:HE2	1.77	0.41
1:D:324:PRO:HA	3:D:784:HOH:O	2.20	0.41
1:B:36:LEU:HD23	1:B:37:LEU:N	2.35	0.41
1:B:294:THR:HG23	1:B:312:PHE:HZ	1.86	0.41
1:D:434:ILE:HG22	1:D:438:LYS:HE3	2.01	0.41
1:A:13:GLY:HA3	1:A:38:GLU:CD	2.41	0.41
1:A:233:LEU:O	1:A:237:LYS:HB2	2.20	0.41
1:A:423:ASP:CG	3:A:712:HOH:O	2.58	0.41
1:A:438:LYS:HE2	1:A:479:LEU:HD11	2.01	0.41
1:B:331:ARG:O	1:B:352:PHE:HB3	2.21	0.41
1:D:426:LEU:HD12	1:D:427:PRO:HD2	2.03	0.41
1:C:4:ARG:HD3	3:C:773:HOH:O	2.21	0.41
1:C:178:GLU:O	1:C:182:ARG:HG3	2.20	0.41
1:A:353:LEU:HG	1:A:396:PHE:CE2	2.56	0.41
1:B:191:GLU:HG2	1:B:193:VAL:HG23	2.02	0.41
1:B:261:LYS:HA	1:B:261:LYS:HD2	1.89	0.41
1:C:88:ARG:HD2	1:C:476:GLY:O	2.21	0.41
1:C:201:LEU:HD12	1:C:210:ALA:HB3	2.01	0.41
1:A:68:GLU:N	2:A:605:SO4:O1	2.52	0.41
1:B:390:HIS:CD2	3:B:734:HOH:O	2.73	0.41
1:D:94:GLU:HA	1:D:315:MET:HG3	2.03	0.41
1:D:124:HIS:HE2	1:D:442:PRO:N	2.19	0.41
1:A:438:LYS:HA	1:A:481:PRO:HA	2.02	0.40
1:C:250:LEU:HD23	1:C:250:LEU:HA	1.91	0.40
1:D:148:ALA:CB	1:D:509:GLN:HG2	2.51	0.40
1:D:270:GLU:O	1:D:287:PRO:HG2	2.21	0.40
1:A:75:ASN:HA	1:A:527:HIS:CE1	2.56	0.40
1:A:493:GLU:OE1	1:A:493:GLU:N	2.47	0.40
1:A:18:TRP:CZ2	1:A:181:ARG:HG3	2.57	0.40
1:D:111:PHE:HB3	1:D:166:ARG:HG2	2.02	0.40
1:D:382:LEU:HD23	1:D:382:LEU:HA	1.93	0.40

All (1) symmetry-related close contacts are listed below. The label for Atom-2 includes the sym-

metry operator and encoded unit-cell translations to be applied.

Atom-1	Atom-2	Interatomic distance (Å)	Clash overlap (Å)
3:D:782:HOH:O	3:D:834:HOH:O[1_655]	2.06	0.14

5.3 Torsion angles [i](#)

5.3.1 Protein backbone [i](#)

In the following table, the Percentiles column shows the percent Ramachandran outliers of the chain as a percentile score with respect to all X-ray entries followed by that with respect to entries of similar resolution.

The Analysed column shows the number of residues for which the backbone conformation was analysed, and the total number of residues.

Mol	Chain	Analysed	Favoured	Allowed	Outliers	Percentiles	
1	A	517/529 (98%)	504 (98%)	13 (2%)	0	100	100
1	B	513/529 (97%)	496 (97%)	17 (3%)	0	100	100
1	C	514/529 (97%)	499 (97%)	15 (3%)	0	100	100
1	D	510/529 (96%)	492 (96%)	18 (4%)	0	100	100
All	All	2054/2116 (97%)	1991 (97%)	63 (3%)	0	100	100

There are no Ramachandran outliers to report.

5.3.2 Protein sidechains [i](#)

In the following table, the Percentiles column shows the percent sidechain outliers of the chain as a percentile score with respect to all X-ray entries followed by that with respect to entries of similar resolution.

The Analysed column shows the number of residues for which the sidechain conformation was analysed, and the total number of residues.

Mol	Chain	Analysed	Rotameric	Outliers	Percentiles	
1	A	431/436 (99%)	428 (99%)	3 (1%)	84	83
1	B	427/436 (98%)	418 (98%)	9 (2%)	53	47
1	C	427/436 (98%)	416 (97%)	11 (3%)	46	37
1	D	426/436 (98%)	420 (99%)	6 (1%)	67	62
All	All	1711/1744 (98%)	1682 (98%)	29 (2%)	60	53

All (29) residues with a non-rotameric sidechain are listed below:

Mol	Chain	Res	Type
1	A	45	ILE
1	A	96	LYS
1	A	422	LYS
1	B	38	GLU
1	B	192	HIS
1	B	261	LYS
1	B	267	HIS
1	B	296	TYR
1	B	315	MET
1	B	358	SER
1	B	365	THR
1	B	382	LEU
1	C	100	ILE
1	C	187	ARG
1	C	214	VAL
1	C	247	ASN
1	C	291	ARG
1	C	306	ASP
1	C	353	LEU
1	C	448	THR
1	C	451	SER
1	C	464	PHE
1	C	487	MET
1	D	166	ARG
1	D	247	ASN
1	D	322	ASN
1	D	483	ASN
1	D	521	GLU
1	D	525	SER

Sometimes sidechains can be flipped to improve hydrogen bonding and reduce clashes. All (2) such sidechains are listed below:

Mol	Chain	Res	Type
1	B	183	HIS
1	D	444	ASN

5.3.3 RNA [i](#)

There are no RNA molecules in this entry.

5.4 Non-standard residues in protein, DNA, RNA chains [i](#)

There are no non-standard protein/DNA/RNA residues in this entry.

5.5 Carbohydrates [i](#)

There are no monosaccharides in this entry.

5.6 Ligand geometry [i](#)

16 ligands are modelled in this entry.

In the following table, the Counts columns list the number of bonds (or angles) for which Mogul statistics could be retrieved, the number of bonds (or angles) that are observed in the model and the number of bonds (or angles) that are defined in the Chemical Component Dictionary. The Link column lists molecule types, if any, to which the group is linked. The Z score for a bond length (or angle) is the number of standard deviations the observed value is removed from the expected value. A bond length (or angle) with $|Z| > 2$ is considered an outlier worth inspection. RMSZ is the root-mean-square of all Z scores of the bond lengths (or angles).

Mol	Type	Chain	Res	Link	Bond lengths			Bond angles		
					Counts	RMSZ	$\# Z > 2$	Counts	RMSZ	$\# Z > 2$
2	SO4	A	603	-	4,4,4	0.14	0	6,6,6	0.06	0
2	SO4	B	603	-	4,4,4	0.14	0	6,6,6	0.05	0
2	SO4	A	606	-	4,4,4	0.14	0	6,6,6	0.09	0
2	SO4	C	602	-	4,4,4	0.16	0	6,6,6	0.13	0
2	SO4	B	605	-	4,4,4	0.34	0	6,6,6	0.29	0
2	SO4	B	601	-	4,4,4	0.14	0	6,6,6	0.10	0
2	SO4	A	602	-	4,4,4	0.16	0	6,6,6	0.04	0
2	SO4	D	601	-	4,4,4	0.16	0	6,6,6	0.07	0
2	SO4	B	604	-	4,4,4	0.15	0	6,6,6	0.09	0
2	SO4	A	605	-	4,4,4	0.13	0	6,6,6	0.18	0
2	SO4	B	602	-	4,4,4	0.12	0	6,6,6	0.12	0
2	SO4	D	602	-	4,4,4	0.14	0	6,6,6	0.05	0
2	SO4	D	603	-	4,4,4	0.17	0	6,6,6	0.12	0
2	SO4	A	601	-	4,4,4	0.14	0	6,6,6	0.23	0
2	SO4	A	604	-	4,4,4	0.14	0	6,6,6	0.10	0
2	SO4	C	601	-	4,4,4	0.15	0	6,6,6	0.07	0

There are no bond length outliers.

There are no bond angle outliers.

There are no chirality outliers.

There are no torsion outliers.

There are no ring outliers.

5 monomers are involved in 6 short contacts:

Mol	Chain	Res	Type	Clashes	Symm-Clashes
2	B	605	SO4	1	0
2	A	605	SO4	2	0
2	B	602	SO4	1	0
2	A	604	SO4	1	0
2	C	601	SO4	1	0

5.7 Other polymers [i](#)

There are no such residues in this entry.

5.8 Polymer linkage issues [i](#)

There are no chain breaks in this entry.

6 Fit of model and data

6.1 Protein, DNA and RNA chains

In the following table, the column labelled ‘#RSRZ > 2’ contains the number (and percentage) of RSRZ outliers, followed by percent RSRZ outliers for the chain as percentile scores relative to all X-ray entries and entries of similar resolution. The OWAB column contains the minimum, median, 95th percentile and maximum values of the occupancy-weighted average B-factor per residue. The column labelled ‘Q < 0.9’ lists the number of (and percentage) of residues with an average occupancy less than 0.9.

Mol	Chain	Analysed	<RSRZ>	#RSRZ>2	OWAB(Å ²)	Q<0.9
1	A	521/529 (98%)	0.59	32 (6%) 21 23	14, 29, 51, 64	0
1	B	519/529 (98%)	0.79	60 (11%) 4 5	16, 35, 68, 91	0
1	C	519/529 (98%)	0.80	68 (13%) 3 3	18, 40, 65, 87	0
1	D	517/529 (97%)	1.10	100 (19%) 1 1	22, 45, 72, 93	0
All	All	2076/2116 (98%)	0.82	260 (12%) 3 4	14, 37, 67, 93	0

All (260) RSRZ outliers are listed below:

Mol	Chain	Res	Type	RSRZ
1	D	159	LEU	9.2
1	D	100	ILE	8.4
1	D	101	ASP	6.8
1	C	159	LEU	6.7
1	A	45	ILE	5.9
1	D	160	ASP	5.3
1	A	448	THR	5.3
1	C	322	ASN	5.3
1	D	356	LEU	5.3
1	D	454	TYR	5.3
1	D	522	PHE	5.2
1	A	39	ALA	5.2
1	B	204	GLU	5.2
1	C	324	PRO	5.2
1	D	216	GLY	5.1
1	D	40	PRO	5.0
1	B	201	LEU	4.9
1	D	322	ASN	4.9
1	D	158	TRP	4.8
1	D	313	CYS	4.8
1	C	451	SER	4.8

Continued on next page...

Continued from previous page...

Mol	Chain	Res	Type	RSRZ
1	D	162	ARG	4.8
1	C	448	THR	4.7
1	D	310	LEU	4.6
1	D	510	ARG	4.6
1	C	100	ILE	4.5
1	B	451	SER	4.5
1	B	448	THR	4.5
1	C	214	VAL	4.4
1	D	457	PHE	4.3
1	C	101	ASP	4.3
1	D	323	THR	4.3
1	C	463	ASN	4.2
1	B	457	PHE	4.2
1	D	50	ALA	4.2
1	A	451	SER	4.2
1	D	512	LEU	4.2
1	B	211	LEU	4.2
1	B	198	GLN	4.2
1	D	320	PRO	4.2
1	C	454	TYR	4.1
1	D	309	THR	4.1
1	D	289	LEU	4.0
1	D	516	LEU	3.9
1	D	196	GLU	3.9
1	C	323	THR	3.9
1	C	160	ASP	3.9
1	D	464	PHE	3.8
1	D	361	ILE	3.8
1	D	448	THR	3.8
1	C	40	PRO	3.8
1	D	523	LEU	3.7
1	C	457	PHE	3.7
1	D	450	GLU	3.7
1	C	325	LEU	3.7
1	D	447	VAL	3.7
1	D	46	GLY	3.7
1	D	66	ARG	3.7
1	B	33	THR	3.6
1	D	319	ASP	3.6
1	D	39	ALA	3.6
1	D	318	LEU	3.6
1	D	215	GLU	3.6

Continued on next page...

Continued from previous page...

Mol	Chain	Res	Type	RSRZ
1	B	199	GLN	3.5
1	A	455	GLY	3.5
1	C	361	ILE	3.4
1	D	514	GLU	3.4
1	D	525	SER	3.4
1	C	522	PHE	3.4
1	B	219	LEU	3.4
1	A	101	ASP	3.4
1	B	202	ARG	3.4
1	D	520	LEU	3.4
1	C	514	GLU	3.4
1	B	189	ASN	3.3
1	D	306	ASP	3.3
1	A	461	PHE	3.3
1	B	356	LEU	3.3
1	B	190	VAL	3.3
1	D	174	HIS	3.3
1	B	212	ARG	3.3
1	D	419	LYS	3.2
1	B	282	TRP	3.2
1	A	356	LEU	3.2
1	B	297	VAL	3.2
1	B	30	ASP	3.2
1	D	515	THR	3.2
1	A	297	VAL	3.2
1	D	275	ALA	3.2
1	D	524	ARG	3.2
1	B	6	ASN	3.2
1	C	464	PHE	3.2
1	D	413	THR	3.2
1	D	324	PRO	3.2
1	C	162	ARG	3.2
1	C	461	PHE	3.2
1	C	413	THR	3.2
1	A	189	ASN	3.1
1	C	513	VAL	3.1
1	C	525	SER	3.1
1	D	301	ARG	3.1
1	C	52	VAL	3.0
1	C	510	ARG	3.0
1	C	158	TRP	3.0
1	D	461	PHE	3.0

Continued on next page...

Continued from previous page...

Mol	Chain	Res	Type	RSRZ
1	B	34	ILE	3.0
1	C	452	THR	3.0
1	B	275	ALA	3.0
1	D	187	ARG	2.9
1	C	465	TRP	2.9
1	C	453	TYR	2.9
1	A	457	PHE	2.9
1	A	364	ILE	2.9
1	B	45	ILE	2.9
1	B	276	ILE	2.9
1	C	319	ASP	2.8
1	D	214	VAL	2.8
1	A	102	GLY	2.8
1	B	39	ALA	2.8
1	C	526	LEU	2.8
1	D	286	ILE	2.8
1	D	465	TRP	2.7
1	A	360	GLY	2.7
1	C	320	PRO	2.7
1	D	52	VAL	2.7
1	C	289	LEU	2.7
1	D	362	TYR	2.7
1	C	321	GLU	2.7
1	B	359	THR	2.7
1	D	273	THR	2.7
1	A	136	ASP	2.7
1	D	230	PHE	2.7
1	D	363	PHE	2.6
1	D	317	GLY	2.6
1	B	188	LEU	2.6
1	D	364	ILE	2.6
1	A	286	ILE	2.6
1	C	263	ASP	2.6
1	B	197	MET	2.6
1	D	282	TRP	2.6
1	D	498	ALA	2.6
1	B	461	PHE	2.6
1	A	188	LEU	2.6
1	B	55	LEU	2.6
1	D	511	GLU	2.6
1	B	286	ILE	2.6
1	A	449	ASP	2.6

Continued on next page...

Continued from previous page...

Mol	Chain	Res	Type	RSRZ
1	B	362	TYR	2.5
1	C	316	TRP	2.5
1	D	119	GLN	2.5
1	D	304	GLU	2.5
1	A	276	ILE	2.5
1	B	399	THR	2.5
1	D	57	ARG	2.5
1	D	353	LEU	2.5
1	B	196	GLU	2.5
1	B	187	ARG	2.5
1	D	526	LEU	2.5
1	C	449	ASP	2.5
1	B	403	ILE	2.5
1	D	51	THR	2.5
1	D	102	GLY	2.4
1	C	105	ASP	2.4
1	D	111	PHE	2.4
1	B	237	LYS	2.4
1	D	163	PRO	2.4
1	D	355	PRO	2.4
1	C	187	ARG	2.4
1	D	316	TRP	2.4
1	A	266	ALA	2.4
1	C	500	ALA	2.4
1	C	515	THR	2.4
1	C	267	HIS	2.4
1	C	169	TRP	2.4
1	B	321	GLU	2.4
1	D	198	GLN	2.4
1	B	449	ASP	2.4
1	B	507	ASP	2.4
1	C	314	ARG	2.4
1	B	214	VAL	2.4
1	C	39	ALA	2.4
1	B	52	VAL	2.4
1	D	113	LEU	2.3
1	D	84	PHE	2.3
1	B	18	TRP	2.3
1	D	263	ASP	2.3
1	C	368	ILE	2.3
1	B	277	ALA	2.3
1	C	318	LEU	2.3

Continued on next page...

Continued from previous page...

Mol	Chain	Res	Type	RSRZ
1	B	218	ASP	2.3
1	B	248	ASP	2.3
1	D	507	ASP	2.3
1	A	450	GLU	2.3
1	C	450	GLU	2.3
1	C	96	LYS	2.3
1	A	282	TRP	2.3
1	A	284	TRP	2.3
1	D	346	ILE	2.3
1	D	451	SER	2.3
1	D	521	GLU	2.3
1	D	155	ALA	2.3
1	D	368	ILE	2.3
1	A	201	LEU	2.3
1	D	108	TYR	2.2
1	D	91	GLY	2.2
1	B	186	GLU	2.2
1	C	428	GLU	2.2
1	D	359	THR	2.2
1	D	459	ALA	2.2
1	B	203	ASP	2.2
1	D	90	PRO	2.2
1	C	50	ALA	2.2
1	B	101	ASP	2.2
1	D	513	VAL	2.2
1	C	360	GLY	2.2
1	D	423	ASP	2.2
1	B	200	VAL	2.2
1	A	2	ASP	2.2
1	A	507	ASP	2.2
1	D	288	MET	2.2
1	A	275	ALA	2.2
1	D	77	ALA	2.2
1	C	447	VAL	2.2
1	D	307	GLU	2.2
1	D	303	ALA	2.2
1	C	363	PHE	2.2
1	C	310	LEU	2.1
1	C	356	LEU	2.1
1	C	520	LEU	2.1
1	B	281	GLY	2.1
1	C	198	GLN	2.1

Continued on next page...

Continued from previous page...

Mol	Chain	Res	Type	RSRZ
1	D	213	THR	2.1
1	C	282	TRP	2.1
1	C	313	CYS	2.1
1	C	94	GLU	2.1
1	C	260	ILE	2.1
1	C	259	ALA	2.1
1	A	362	TYR	2.1
1	A	453	TYR	2.1
1	B	17	GLY	2.1
1	D	284	TRP	2.1
1	A	321	GLU	2.1
1	C	196	GLU	2.1
1	B	353	LEU	2.1
1	C	317	GLY	2.1
1	B	402	PHE	2.1
1	C	216	GLY	2.1
1	B	330	PHE	2.0
1	B	352	PHE	2.0
1	B	284	TRP	2.0
1	C	57	ARG	2.0
1	A	30	ASP	2.0
1	D	449	ASP	2.0
1	B	32	VAL	2.0
1	B	217	ARG	2.0
1	A	352	PHE	2.0
1	B	215	GLU	2.0
1	B	464	PHE	2.0
1	D	497	GLU	2.0
1	D	321	GLU	2.0

6.2 Non-standard residues in protein, DNA, RNA chains [i](#)

There are no non-standard protein/DNA/RNA residues in this entry.

6.3 Carbohydrates [i](#)

There are no monosaccharides in this entry.

6.4 Ligands [i](#)

In the following table, the Atoms column lists the number of modelled atoms in the group and the number defined in the chemical component dictionary. The B-factors column lists the minimum, median, 95th percentile and maximum values of B factors of atoms in the group. The column labelled 'Q< 0.9' lists the number of atoms with occupancy less than 0.9.

Mol	Type	Chain	Res	Atoms	RSCC	RSR	B-factors(Å ²)	Q<0.9
2	SO4	A	606	5/5	0.72	0.33	41,53,60,81	0
2	SO4	B	602	5/5	0.83	0.21	43,48,57,62	0
2	SO4	B	603	5/5	0.86	0.35	57,58,71,73	0
2	SO4	B	605	5/5	0.86	0.31	67,75,79,82	0
2	SO4	C	602	5/5	0.88	0.31	42,43,60,66	0
2	SO4	D	603	5/5	0.88	0.33	47,48,59,69	0
2	SO4	A	605	5/5	0.90	0.37	41,41,58,58	0
2	SO4	B	604	5/5	0.93	0.25	54,55,63,70	0
2	SO4	A	604	5/5	0.93	0.15	32,40,54,55	0
2	SO4	B	601	5/5	0.94	0.23	46,49,55,61	0
2	SO4	D	602	5/5	0.95	0.13	43,47,49,54	5
2	SO4	A	603	5/5	0.96	0.20	50,52,56,60	0
2	SO4	C	601	5/5	0.97	0.21	39,46,52,57	0
2	SO4	D	601	5/5	0.97	0.19	39,47,51,51	0
2	SO4	A	601	5/5	0.98	0.10	22,23,28,28	0
2	SO4	A	602	5/5	0.98	0.22	40,45,50,52	0

6.5 Other polymers [i](#)

There are no such residues in this entry.