



Full wwPDB X-ray Structure Validation Report ⓘ

Mar 13, 2018 – 09:06 pm GMT

PDB ID : 5U6S
Title : Crystal structure of UDP-glucosyltransferase, UGT74F2, with UDP and 2-bromobenzoic acid
Authors : George Thompson, A.M.; Iancu, C.V.; Dean, J.V.; Choe, J.
Deposited on : 2016-12-08
Resolution : 2.00 Å(reported)

This is a Full wwPDB X-ray Structure Validation Report for a publicly released PDB entry.

We welcome your comments at validation@mail.wwpdb.org

A user guide is available at

<https://www.wwpdb.org/validation/2017/XrayValidationReportHelp>

with specific help available everywhere you see the ⓘ symbol.

The following versions of software and data (see [references ⓘ](#)) were used in the production of this report:

MolProbity : 4.02b-467
Mogul : 1.7.3 (157068), CSD as539be (2018)
Xtrriage (Phenix) : 1.13
EDS : trunk31020
Percentile statistics : 20171227.v01 (using entries in the PDB archive December 27th 2017)
Refmac : 5.8.0158
CCP4 : 7.0 (Gargrove)
Ideal geometry (proteins) : Engh & Huber (2001)
Ideal geometry (DNA, RNA) : Parkinson et al. (1996)
Validation Pipeline (wwPDB-VP) : trunk31020

1 Overall quality at a glance

The following experimental techniques were used to determine the structure:

X-RAY DIFFRACTION

The reported resolution of this entry is 2.00 Å.

Percentile scores (ranging between 0-100) for global validation metrics of the entry are shown in the following graphic. The table shows the number of entries on which the scores are based.

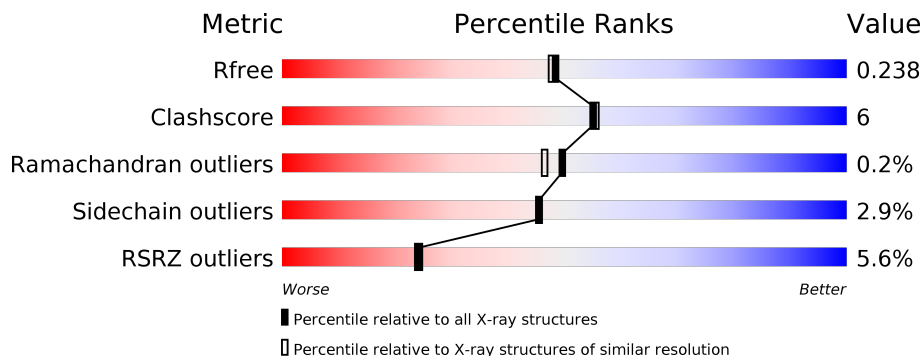

Metric	Whole archive (#Entries)	Similar resolution (#Entries, resolution range(Å))
R_{free}	111664	7193 (2.00-2.00)
Clashscore	122126	8267 (2.00-2.00)
Ramachandran outliers	120053	8166 (2.00-2.00)
Sidechain outliers	120020	8165 (2.00-2.00)
RSRZ outliers	108989	7011 (2.00-2.00)

The table below summarises the geometric issues observed across the polymeric chains and their fit to the electron density. The red, orange, yellow and green segments on the lower bar indicate the fraction of residues that contain outliers for ≥ 3 , 2, 1 and 0 types of geometric quality criteria. A grey segment represents the fraction of residues that are not modelled. The numeric value for each fraction is indicated below the corresponding segment, with a dot representing fractions $\leq 5\%$. The upper red bar (where present) indicates the fraction of residues that have poor fit to the electron density. The numeric value is given above the bar.

Mol	Chain	Length	Quality of chain
1	A	449	 6% (poor fit), 86% (0-1 outliers), 12% (2-3 outliers), .. (not modelled)
1	B	449	 5% (poor fit), 85% (0-1 outliers), 12% (2-3 outliers), .. (not modelled)

2 Entry composition [i](#)

There are 6 unique types of molecules in this entry. The entry contains 7361 atoms, of which 0 are hydrogens and 0 are deuteriums.

In the tables below, the ZeroOcc column contains the number of atoms modelled with zero occupancy, the AltConf column contains the number of residues with at least one atom in alternate conformation and the Trace column contains the number of residues modelled with at most 2 atoms.

- Molecule 1 is a protein called UDP-glycosyltransferase 74F2.

Mol	Chain	Residues	Atoms					ZeroOcc	AltConf	Trace
			Total	C	N	O	S			
1	A	444	Total	C	N	O	S	0	0	0
			3537	2277	572	672	16			
1	B	444	Total	C	N	O	S	0	0	0
			3537	2277	572	672	16			

- Molecule 2 is BETA-D-GLUCOSE (three-letter code: BGC) (formula: C₆H₁₂O₆).

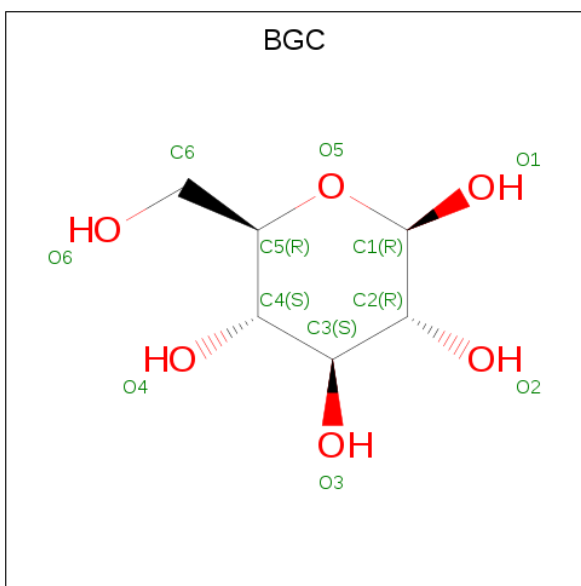

Mol	Chain	Residues	Atoms			ZeroOcc	AltConf
			Total	C	O		
2	A	1	Total	C	O	0	0
			11	6	5		
2	B	1	Total	C	O	0	0
			11	6	5		

- Molecule 3 is 3-O-beta-D-glucopyranosyl-beta-D-glucopyranose (three-letter code: LB2) (formula: C₁₂H₂₂O₁₁).

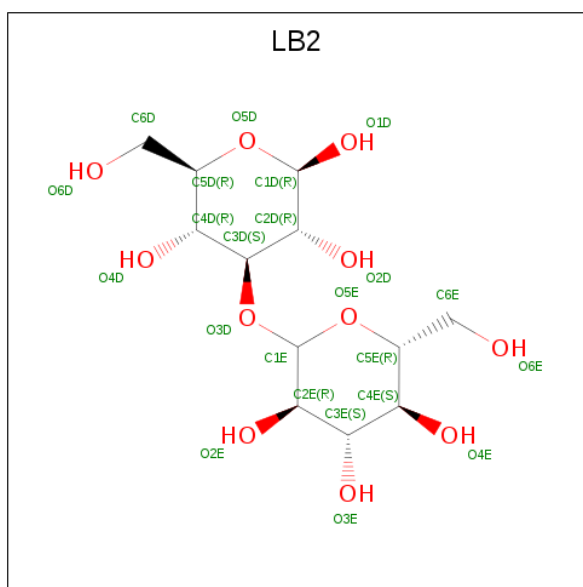

Mol	Chain	Residues	Atoms			ZeroOcc	AltConf
3	A	1	Total	C	O	0	0
			22	12	10		
3	B	1	Total	C	O	0	0
			22	12	10		

- Molecule 4 is URIDINE-5'-DIPHOSPHATE (three-letter code: UDP) (formula: $C_9H_{14}N_2O_{12}P_2$).

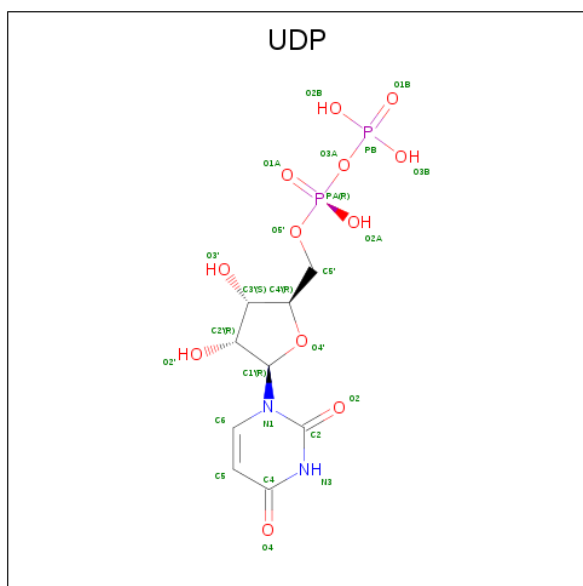

Mol	Chain	Residues	Atoms					ZeroOcc	AltConf
4	A	1	Total	C	N	O	P	0	0
			25	9	2	12	2		
4	B	1	Total	C	N	O	P	0	0
			25	9	2	12	2		

- Molecule 5 is 2-bromobenzoic acid (three-letter code: 7WV) (formula: C₇H₅BrO₂).

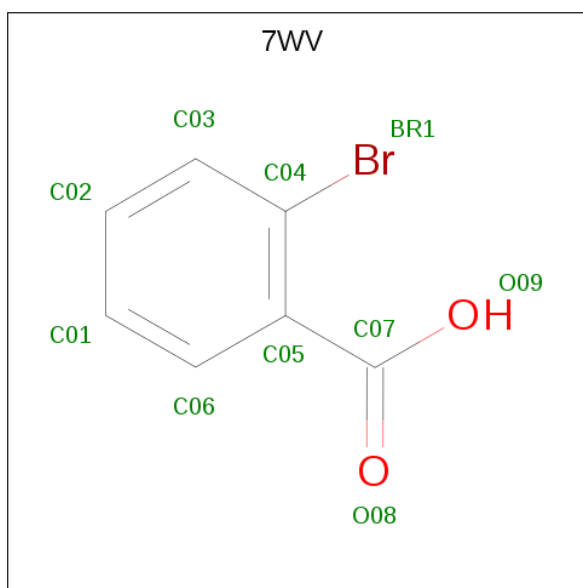

Mol	Chain	Residues	Atoms				ZeroOcc	AltConf
			Total	Br	C	O		
5	A	1	10	1	7	2	0	0
5	B	1	10	1	7	2	0	0

- Molecule 6 is water.

Mol	Chain	Residues	Atoms		ZeroOcc	AltConf
			Total	O		
6	A	93	93	93	0	0
6	B	58	58	58	0	0

3 Residue-property plots [i](#)

These plots are drawn for all protein, RNA and DNA chains in the entry. The first graphic for a chain summarises the proportions of the various outlier classes displayed in the second graphic. The second graphic shows the sequence view annotated by issues in geometry and electron density. Residues are color-coded according to the number of geometric quality criteria for which they contain at least one outlier: green = 0, yellow = 1, orange = 2 and red = 3 or more. A red dot above a residue indicates a poor fit to the electron density ($RSRZ > 2$). Stretches of 2 or more consecutive residues without any outlier are shown as a green connector. Residues present in the sample, but not in the model, are shown in grey.

- Molecule 1: UDP-glycosyltransferase 74F2

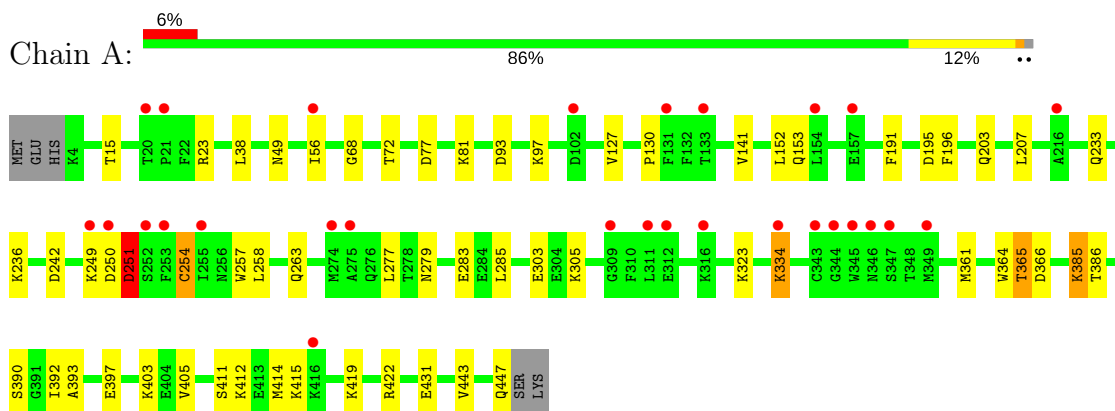

- Molecule 1: UDP-glycosyltransferase 74F2

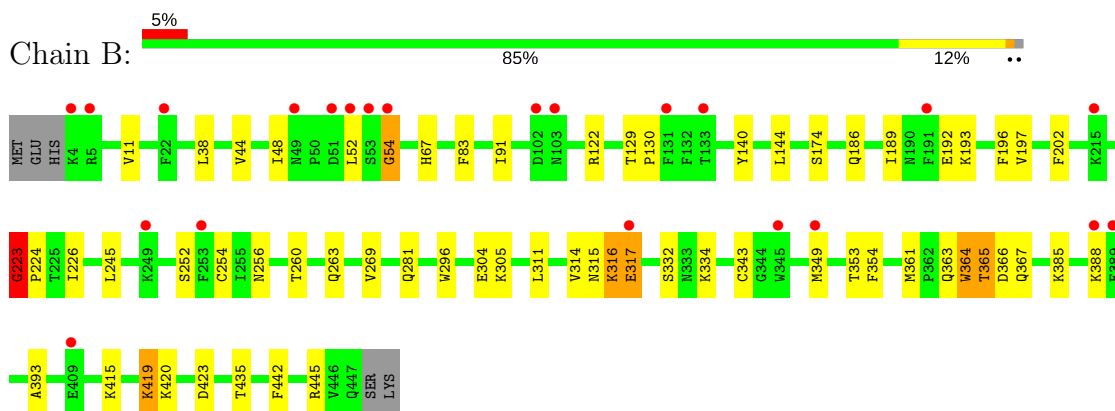

4 Data and refinement statistics

Property	Value	Source
Space group	P 21 21 21	Depositor
Cell constants a, b, c, α , β , γ	65.15Å 87.25Å 162.12Å 90.00° 90.00° 90.00°	Depositor
Resolution (Å)	37.54 – 2.00 37.54 – 2.00	Depositor EDS
% Data completeness (in resolution range)	99.7 (37.54-2.00) 98.3 (37.54-2.00)	Depositor EDS
R_{merge}	(Not available)	Depositor
R_{sym}	0.09	Depositor
$\langle I/\sigma(I) \rangle$ ¹	1.68 (at 2.00Å)	Xtrriage
Refinement program	PHENIX (dev_2481: ???)	Depositor
R, R_{free}	0.184 , 0.238 0.185 , 0.238	Depositor DCC
R_{free} test set	3216 reflections (5.07%)	wwPDB-VP
Wilson B-factor (Å ²)	33.7	Xtrriage
Anisotropy	0.297	Xtrriage
Bulk solvent k_{sol} (e/Å ³), B_{sol} (Å ²)	0.32 , 40.4	EDS
L-test for twinning ²	$\langle L \rangle = 0.47$, $\langle L^2 \rangle = 0.30$	Xtrriage
Estimated twinning fraction	No twinning to report.	Xtrriage
F_o, F_c correlation	0.96	EDS
Total number of atoms	7361	wwPDB-VP
Average B, all atoms (Å ²)	48.0	wwPDB-VP

Xtrriage's analysis on translational NCS is as follows: *The largest off-origin peak in the Patterson function is 3.96% of the height of the origin peak. No significant pseudotranslation is detected.*

¹Intensities estimated from amplitudes.

²Theoretical values of $\langle |L| \rangle$, $\langle L^2 \rangle$ for acentric reflections are 0.5, 0.333 respectively for untwinned datasets, and 0.375, 0.2 for perfectly twinned datasets.

5 Model quality [i](#)

5.1 Standard geometry [i](#)

Bond lengths and bond angles in the following residue types are not validated in this section: BGC, LB2, 7WV, UDP

The Z score for a bond length (or angle) is the number of standard deviations the observed value is removed from the expected value. A bond length (or angle) with $|Z| > 5$ is considered an outlier worth inspection. RMSZ is the root-mean-square of all Z scores of the bond lengths (or angles).

Mol	Chain	Bond lengths		Bond angles	
		RMSZ	# $ Z > 5$	RMSZ	# $ Z > 5$
1	A	0.46	0/3626	0.59	0/4923
1	B	0.45	1/3626 (0.0%)	0.60	2/4923 (0.0%)
All	All	0.45	1/7252 (0.0%)	0.59	2/9846 (0.0%)

Chiral center outliers are detected by calculating the chiral volume of a chiral center and verifying if the center is modelled as a planar moiety or with the opposite hand. A planarity outlier is detected by checking planarity of atoms in a peptide group, atoms in a mainchain group or atoms of a sidechain that are expected to be planar.

Mol	Chain	#Chirality outliers	#Planarity outliers
1	A	0	2
1	B	0	4
All	All	0	6

All (1) bond length outliers are listed below:

Mol	Chain	Res	Type	Atoms	Z	Observed(Å)	Ideal(Å)
1	B	343	CYS	CB-SG	-5.44	1.73	1.81

All (2) bond angle outliers are listed below:

Mol	Chain	Res	Type	Atoms	Z	Observed(°)	Ideal(°)
1	B	223	GLY	C-N-CD	-6.69	105.89	120.60
1	B	38	LEU	CB-CG-CD2	-5.09	102.35	111.00

There are no chirality outliers.

All (6) planarity outliers are listed below:

Mol	Chain	Res	Type	Group
1	A	251	ASP	Peptide
1	A	364	TRP	Peptide
1	B	223	GLY	Peptide
1	B	316	LYS	Peptide
1	B	364	TRP	Peptide
1	B	54	GLY	Peptide

5.2 Too-close contacts [i](#)

In the following table, the Non-H and H(model) columns list the number of non-hydrogen atoms and hydrogen atoms in the chain respectively. The H(added) column lists the number of hydrogen atoms added and optimized by MolProbity. The Clashes column lists the number of clashes within the asymmetric unit, whereas Symm-Clashes lists symmetry related clashes.

Mol	Chain	Non-H	H(model)	H(added)	Clashes	Symm-Clashes
1	A	3537	0	3472	40	0
1	B	3537	0	3472	39	0
2	A	11	0	9	1	0
2	B	11	0	10	0	0
3	A	22	0	20	1	0
3	B	22	0	20	0	0
4	A	25	0	11	0	0
4	B	25	0	11	0	0
5	A	10	0	0	0	0
5	B	10	0	0	0	0
6	A	93	0	0	3	0
6	B	58	0	0	0	0
All	All	7361	0	7025	80	0

The all-atom clashscore is defined as the number of clashes found per 1000 atoms (including hydrogen atoms). The all-atom clashscore for this structure is 6.

All (80) close contacts within the same asymmetric unit are listed below, sorted by their clash magnitude.

Atom-1	Atom-2	Interatomic distance (Å)	Clash overlap (Å)
1:A:390:SER:HB2	1:A:392:ILE:HD12	1.57	0.87
1:B:281:GLN:HE22	1:B:393:ALA:H	1.23	0.82
1:A:23:ARG:HE	1:A:56:ILE:HG21	1.51	0.75
1:A:385:LYS:H	1:A:385:LYS:HD2	1.56	0.70
1:A:23:ARG:NH1	1:A:242:ASP:OD1	2.25	0.69
1:A:263:GLN:HB2	1:A:334:LYS:HE2	1.74	0.68

Continued on next page...

Continued from previous page...

Atom-1	Atom-2	Interatomic distance (Å)	Clash overlap (Å)
1:B:415:LYS:O	1:B:419:LYS:HE2	1.95	0.66
1:B:363:GLN:H	1:B:367:GLN:HE21	1.45	0.64
1:A:279:ASN:O	1:A:283:GLU:HG2	1.98	0.64
1:A:93:ASP:OD1	1:A:97:LYS:NZ	2.31	0.63
1:B:314:VAL:HG13	1:B:316:LYS:HD3	1.80	0.63
1:B:365:THR:HG23	1:B:366:ASP:H	1.64	0.62
1:B:364:TRP:H	1:B:367:GLN:NE2	1.99	0.61
1:A:303:GLU:OE2	1:A:323:LYS:NZ	2.34	0.60
1:A:365:THR:HG23	1:A:366:ASP:H	1.67	0.59
1:A:23:ARG:NE	1:A:56:ILE:HG21	2.18	0.59
1:B:186:GLN:HG2	1:B:189:ILE:HD13	1.85	0.59
1:B:202:PHE:CD1	1:B:224:PRO:HD3	2.38	0.58
1:B:269:VAL:HG13	1:B:296:TRP:HA	1.85	0.58
1:A:233:GLN:O	1:A:236:LYS:NZ	2.28	0.57
1:A:431:GLU:OE1	1:A:431:GLU:N	2.33	0.55
1:B:304:GLU:OE1	1:B:305:LYS:HG2	2.06	0.55
1:A:15:THR:HG22	3:A:502:LB2:H3E	1.87	0.55
1:A:38:LEU:HB2	1:A:56:ILE:HD11	1.89	0.54
1:A:81:LYS:N	1:A:81:LYS:HD3	2.24	0.52
1:A:386:THR:HG22	1:A:393:ALA:HB2	1.90	0.52
1:B:11:VAL:HG11	1:B:91:ILE:HD11	1.92	0.52
1:A:251:ASP:HB3	1:A:254:CYS:HB3	1.92	0.51
1:A:385:LYS:HB2	1:A:397:GLU:HG2	1.93	0.50
1:B:67:HIS:C	1:B:67:HIS:CD2	2.84	0.50
1:B:224:PRO:HB2	1:B:226:ILE:HG12	1.92	0.50
1:B:363:GLN:H	1:B:367:GLN:NE2	2.10	0.50
1:A:411:SER:O	1:A:415:LYS:HG3	2.13	0.49
1:A:443:VAL:O	1:A:447:GLN:HG2	2.13	0.48
2:A:501:BGC:H6C2	6:A:633:HOH:O	2.14	0.48
1:A:412:LYS:HD2	1:A:412:LYS:N	2.29	0.47
1:B:332:SER:HB3	1:B:354:PHE:CE1	2.49	0.47
1:A:77:ASP:HB2	6:A:669:HOH:O	2.15	0.46
1:B:223:GLY:O	1:B:435:THR:HG21	2.15	0.46
1:A:263:GLN:CB	1:A:334:LYS:HE2	2.45	0.45
1:B:130:PRO:HD2	1:B:196:PHE:O	2.17	0.45
1:B:122:ARG:NH2	1:B:193:LYS:HB3	2.32	0.45
1:A:68:GLY:HA3	1:A:72:THR:HG21	1.98	0.45
1:B:316:LYS:HD2	1:B:316:LYS:HA	1.56	0.45
1:B:415:LYS:CE	1:B:419:LYS:HZ2	2.30	0.45
1:B:52:LEU:HD13	1:B:54:GLY:N	2.32	0.45
1:B:263:GLN:HB2	1:B:334:LYS:HZ3	1.81	0.44

Continued on next page...

Continued from previous page...

Atom-1	Atom-2	Interatomic distance (Å)	Clash overlap (Å)
1:A:361:MET:HE3	1:A:361:MET:HB2	1.61	0.44
1:A:385:LYS:HD3	1:A:397:GLU:OE2	2.18	0.44
1:B:140:TYR:CE2	1:B:144:LEU:HD11	2.52	0.44
1:B:311:LEU:O	1:B:314:VAL:HG12	2.17	0.44
1:A:249:LYS:HE2	1:A:249:LYS:HB3	1.44	0.44
1:A:385:LYS:HD2	1:A:385:LYS:N	2.28	0.43
1:B:44:VAL:O	1:B:48:ILE:HG12	2.18	0.43
1:A:152:LEU:HD12	1:A:152:LEU:HA	1.80	0.43
1:B:314:VAL:HG11	1:B:316:LYS:HZ3	1.82	0.43
1:B:361:MET:HE3	1:B:361:MET:HB2	1.91	0.43
1:B:315:ASN:O	1:B:317:GLU:N	2.50	0.43
1:B:129:THR:HG21	1:B:442:PHE:HE1	1.83	0.43
1:A:49:ASN:ND2	6:A:604:HOH:O	2.51	0.43
1:A:23:ARG:HD2	1:A:56:ILE:HD13	2.00	0.42
1:A:257:TRP:CE3	1:A:258:LEU:HD23	2.55	0.42
1:A:141:VAL:HG13	1:A:152:LEU:HD21	2.02	0.42
1:A:130:PRO:HD2	1:A:196:PHE:O	2.19	0.42
1:B:349:MET:O	1:B:353:THR:HG23	2.20	0.42
1:A:207:LEU:HA	1:A:207:LEU:HD23	1.91	0.42
1:B:314:VAL:CG1	1:B:316:LYS:HD3	2.49	0.42
1:B:314:VAL:HG22	1:B:316:LYS:HD3	2.02	0.41
1:A:277:LEU:O	1:A:305:LYS:HD2	2.20	0.41
1:A:415:LYS:O	1:A:419:LYS:HG2	2.21	0.41
1:B:130:PRO:HG2	1:B:197:VAL:HG22	2.03	0.41
1:B:365:THR:HG23	1:B:366:ASP:N	2.34	0.41
1:B:415:LYS:NZ	1:B:419:LYS:HZ2	2.19	0.41
1:B:48:ILE:HD13	1:B:245:LEU:HD23	2.03	0.40
1:B:256:ASN:O	1:B:260:THR:HG23	2.21	0.40
1:A:249:LYS:HB3	1:A:251:ASP:OD2	2.21	0.40
1:B:419:LYS:HD3	1:B:419:LYS:HA	1.89	0.40
1:A:405:VAL:HG22	1:A:414:MET:CE	2.52	0.40
1:A:127:VAL:HG13	1:A:195:ASP:CG	2.42	0.40
1:B:52:LEU:C	1:B:52:LEU:HD13	2.41	0.40

There are no symmetry-related clashes.

5.3 Torsion angles [i](#)

5.3.1 Protein backbone [i](#)

In the following table, the Percentiles column shows the percent Ramachandran outliers of the chain as a percentile score with respect to all X-ray entries followed by that with respect to entries of similar resolution.

The Analysed column shows the number of residues for which the backbone conformation was analysed, and the total number of residues.

Mol	Chain	Analysed	Favoured	Allowed	Outliers	Percentiles	
1	A	442/449 (98%)	428 (97%)	13 (3%)	1 (0%)	49	46
1	B	442/449 (98%)	423 (96%)	18 (4%)	1 (0%)	49	46
All	All	884/898 (98%)	851 (96%)	31 (4%)	2 (0%)	49	46

All (2) Ramachandran outliers are listed below:

Mol	Chain	Res	Type
1	A	365	THR
1	B	365	THR

5.3.2 Protein sidechains [i](#)

In the following table, the Percentiles column shows the percent sidechain outliers of the chain as a percentile score with respect to all X-ray entries followed by that with respect to entries of similar resolution.

The Analysed column shows the number of residues for which the sidechain conformation was analysed, and the total number of residues.

Mol	Chain	Analysed	Rotameric	Outliers	Percentiles	
1	A	396/401 (99%)	385 (97%)	11 (3%)	47	47
1	B	396/401 (99%)	384 (97%)	12 (3%)	44	44
All	All	792/802 (99%)	769 (97%)	23 (3%)	45	45

All (23) residues with a non-rotameric sidechain are listed below:

Mol	Chain	Res	Type
1	A	153	GLN
1	A	191	PHE
1	A	203	GLN
1	A	250	ASP

Continued on next page...

Continued from previous page...

Mol	Chain	Res	Type
1	A	251	ASP
1	A	254	CYS
1	A	285	LEU
1	A	334	LYS
1	A	385	LYS
1	A	403	LYS
1	A	422	ARG
1	B	83	PHE
1	B	174	SER
1	B	192	GLU
1	B	252	SER
1	B	254	CYS
1	B	317	GLU
1	B	385	LYS
1	B	388	LYS
1	B	419	LYS
1	B	420	LYS
1	B	423	ASP
1	B	445	ARG

Some sidechains can be flipped to improve hydrogen bonding and reduce clashes. All (5) such sidechains are listed below:

Mol	Chain	Res	Type
1	B	67	HIS
1	B	256	ASN
1	B	279	ASN
1	B	281	GLN
1	B	367	GLN

5.3.3 RNA [i](#)

There are no RNA molecules in this entry.

5.4 Non-standard residues in protein, DNA, RNA chains [i](#)

There are no non-standard protein/DNA/RNA residues in this entry.

5.5 Carbohydrates [i](#)

There are no carbohydrates in this entry.

5.6 Ligand geometry

8 ligands are modelled in this entry.

In the following table, the Counts columns list the number of bonds (or angles) for which Mogul statistics could be retrieved, the number of bonds (or angles) that are observed in the model and the number of bonds (or angles) that are defined in the Chemical Component Dictionary. The Link column lists molecule types, if any, to which the group is linked. The Z score for a bond length (or angle) is the number of standard deviations the observed value is removed from the expected value. A bond length (or angle) with $|Z| > 2$ is considered an outlier worth inspection. RMSZ is the root-mean-square of all Z scores of the bond lengths (or angles).

Mol	Type	Chain	Res	Link	Bond lengths			Bond angles		
					Counts	RMSZ	# Z > 2	Counts	RMSZ	# Z > 2
2	BGC	A	501	1	11,11,12	1.19	0	15,15,17	1.82	3 (20%)
3	LB2	A	502	1	23,23,24	0.69	0	31,33,35	1.08	2 (6%)
4	UDP	A	503	-	20,26,26	3.60	9 (45%)	23,40,40	2.42	3 (13%)
5	7WV	A	504	-	7,10,10	1.52	1 (14%)	9,13,13	0.81	0
2	BGC	B	501	1	11,11,12	1.20	1 (9%)	15,15,17	1.33	2 (13%)
3	LB2	B	502	1	23,23,24	0.69	0	31,33,35	1.36	5 (16%)
4	UDP	B	503	-	20,26,26	3.48	9 (45%)	23,40,40	2.49	4 (17%)
5	7WV	B	504	-	7,10,10	2.07	2 (28%)	9,13,13	1.43	2 (22%)

In the following table, the Chirals column lists the number of chiral outliers, the number of chiral centers analysed, the number of these observed in the model and the number defined in the Chemical Component Dictionary. Similar counts are reported in the Torsion and Rings columns. '-' means no outliers of that kind were identified.

Mol	Type	Chain	Res	Link	Chirals	Torsions	Rings
2	BGC	A	501	1	-	0/2/19/22	0/1/1/1
3	LB2	A	502	1	-	0/8/45/48	0/2/2/2
4	UDP	A	503	-	-	0/12/32/32	0/2/2/2
5	7WV	A	504	-	-	0/0/4/4	0/1/1/1
2	BGC	B	501	1	-	0/2/19/22	0/1/1/1
3	LB2	B	502	1	-	0/8/45/48	0/2/2/2
4	UDP	B	503	-	-	0/12/32/32	0/2/2/2
5	7WV	B	504	-	-	0/0/4/4	0/1/1/1

All (22) bond length outliers are listed below:

Mol	Chain	Res	Type	Atoms	Z	Observed(Å)	Ideal(Å)
4	A	503	UDP	O4'-C1'	-5.95	1.32	1.41
4	A	503	UDP	C3'-C4'	-5.62	1.38	1.53

Continued on next page...

Continued from previous page...

Mol	Chain	Res	Type	Atoms	Z	Observed(Å)	Ideal(Å)
4	B	503	UDP	C3'-C4'	-5.49	1.38	1.53
4	B	503	UDP	O4'-C1'	-5.31	1.33	1.41
2	B	501	BGC	C6-C5	2.11	1.59	1.51
5	B	504	7WV	C05-C04	2.12	1.41	1.39
4	B	503	UDP	PB-O3A	2.22	1.63	1.60
4	B	503	UDP	O3'-C3'	2.67	1.49	1.43
4	A	503	UDP	O3'-C3'	2.93	1.50	1.43
4	A	503	UDP	PB-O3A	2.97	1.64	1.60
4	B	503	UDP	C2-N3	3.61	1.45	1.38
5	A	504	7WV	BR1-C04	3.81	1.98	1.89
4	A	503	UDP	C2-N3	3.89	1.45	1.38
4	B	503	UDP	C6-C5	4.74	1.48	1.38
5	B	504	7WV	BR1-C04	4.89	2.01	1.89
4	A	503	UDP	C6-C5	4.97	1.49	1.38
4	A	503	UDP	O4'-C4'	5.35	1.57	1.45
4	B	503	UDP	O4'-C4'	5.39	1.57	1.45
4	A	503	UDP	C4-N3	6.80	1.45	1.33
4	B	503	UDP	C6-N1	6.89	1.45	1.35
4	A	503	UDP	C6-N1	6.91	1.45	1.35
4	B	503	UDP	C4-N3	7.05	1.45	1.33

All (21) bond angle outliers are listed below:

Mol	Chain	Res	Type	Atoms	Z	Observed(°)	Ideal(°)
5	B	504	7WV	C06-C05-C07	-2.83	115.88	120.23
3	A	502	LB2	O5D-C1D-C2D	-2.82	106.38	110.78
2	A	501	BGC	O5-C5-C6	-2.64	102.97	107.15
4	A	503	UDP	O4'-C1'-N1	-2.62	102.84	108.05
4	B	503	UDP	C4'-O4'-C1'	-2.51	107.21	109.83
4	B	503	UDP	O4'-C1'-N1	-2.36	103.36	108.05
3	B	502	LB2	C1E-O5E-C5E	-2.15	109.48	113.71
2	B	501	BGC	O2-C2-C3	-2.02	106.25	110.19
5	B	504	7WV	BR1-C04-C05	2.18	123.14	120.50
3	A	502	LB2	C3D-C4D-C5D	2.55	115.14	109.67
3	B	502	LB2	C3E-C4E-C5E	2.61	114.90	110.24
3	B	502	LB2	C1D-C2D-C3D	2.69	112.42	109.17
2	A	501	BGC	C1-C2-C3	2.76	113.14	109.66
4	A	503	UDP	C2'-C3'-C4'	2.84	108.08	102.62
3	B	502	LB2	C4E-C3E-C2E	2.98	116.06	110.83
3	B	502	LB2	O5D-C5D-C6D	3.15	112.13	107.15
4	B	503	UDP	C2'-C3'-C4'	3.29	108.93	102.62
2	B	501	BGC	C1-C2-C3	4.08	114.82	109.66

Continued on next page...

Continued from previous page...

Mol	Chain	Res	Type	Atoms	Z	Observed(°)	Ideal(°)
2	A	501	BGC	C1-O5-C5	4.41	118.25	112.19
4	A	503	UDP	C4-N3-C2	9.64	122.44	114.14
4	B	503	UDP	C4-N3-C2	10.17	122.89	114.14

There are no chirality outliers.

There are no torsion outliers.

There are no ring outliers.

2 monomers are involved in 2 short contacts:

Mol	Chain	Res	Type	Clashes	Symm-Clashes
2	A	501	BGC	1	0
3	A	502	LB2	1	0

5.7 Other polymers [i](#)

There are no such residues in this entry.

5.8 Polymer linkage issues [i](#)

There are no chain breaks in this entry.

6 Fit of model and data

6.1 Protein, DNA and RNA chains

In the following table, the column labelled ‘#RSRZ > 2’ contains the number (and percentage) of RSRZ outliers, followed by percent RSRZ outliers for the chain as percentile scores relative to all X-ray entries and entries of similar resolution. The OWAB column contains the minimum, median, 95th percentile and maximum values of the occupancy-weighted average B-factor per residue. The column labelled ‘Q < 0.9’ lists the number of (and percentage) of residues with an average occupancy less than 0.9.

Mol	Chain	Analysed	<RSRZ>	#RSRZ>2	OWAB(Å ²)	Q<0.9
1	A	444/449 (98%)	0.32	28 (6%) 20 19	22, 42, 78, 122	0
1	B	444/449 (98%)	0.39	22 (4%) 29 28	27, 45, 90, 130	0
All	All	888/898 (98%)	0.35	50 (5%) 24 24	22, 44, 84, 130	0

All (50) RSRZ outliers are listed below:

Mol	Chain	Res	Type	RSRZ
1	A	253	PHE	5.0
1	A	316	LYS	4.7
1	B	54	GLY	4.6
1	A	311	LEU	4.5
1	B	102	ASP	4.2
1	B	4	LYS	4.1
1	B	53	SER	4.0
1	B	52	LEU	3.8
1	A	250	ASP	3.6
1	B	191	PHE	3.5
1	B	253	PHE	3.4
1	A	154	LEU	3.3
1	B	5	ARG	3.2
1	A	133	THR	3.2
1	A	343	CYS	3.1
1	B	51	ASP	3.1
1	A	345	TRP	3.0
1	A	346	ASN	2.8
1	B	409	GLU	2.8
1	A	349	MET	2.7
1	A	249	LYS	2.7
1	B	103	ASN	2.7
1	B	388	LYS	2.6
1	B	131	PHE	2.6

Continued on next page...

Continued from previous page...

Mol	Chain	Res	Type	RSRZ
1	B	389	GLU	2.6
1	A	275	ALA	2.6
1	A	157	GLU	2.6
1	A	131	PHE	2.6
1	B	249	LYS	2.6
1	A	309	GLY	2.5
1	A	21	PRO	2.4
1	A	344	GLY	2.4
1	B	317	GLU	2.4
1	A	274	MET	2.4
1	A	252	SER	2.3
1	B	22	PHE	2.3
1	B	49	ASN	2.3
1	B	345	TRP	2.3
1	A	334	LYS	2.2
1	A	20	THR	2.2
1	A	312	GLU	2.2
1	A	216	ALA	2.2
1	A	347	SER	2.1
1	A	416	LYS	2.1
1	B	215	LYS	2.1
1	B	133	THR	2.1
1	A	102	ASP	2.1
1	B	349	MET	2.0
1	A	56	ILE	2.0
1	A	255	ILE	2.0

6.2 Non-standard residues in protein, DNA, RNA chains [\(i\)](#)

There are no non-standard protein/DNA/RNA residues in this entry.

6.3 Carbohydrates [\(i\)](#)

There are no carbohydrates in this entry.

6.4 Ligands [\(i\)](#)

In the following table, the Atoms column lists the number of modelled atoms in the group and the number defined in the chemical component dictionary. The B-factors column lists the minimum, median, 95th percentile and maximum values of B factors of atoms in the group. The column labelled 'Q< 0.9' lists the number of atoms with occupancy less than 0.9.

Mol	Type	Chain	Res	Atoms	RSCC	RSR	B-factors(\AA^2)	Q<0.9
5	7WV	B	504	10/10	0.87	0.18	49,74,83,109	0
5	7WV	A	504	10/10	0.88	0.21	61,99,108,149	0
3	LB2	B	502	22/23	0.90	0.15	38,59,85,86	0
2	BGC	A	501	11/12	0.94	0.13	37,44,47,70	0
2	BGC	B	501	11/12	0.96	0.08	49,57,62,63	0
3	LB2	A	502	22/23	0.96	0.09	34,56,70,75	0
4	UDP	A	503	25/25	0.98	0.21	30,37,42,47	0
4	UDP	B	503	25/25	0.98	0.20	28,35,43,45	0

6.5 Other polymers [i](#)

There are no such residues in this entry.