



Full wwPDB X-ray Structure Validation Report ⓘ

Jun 17, 2024 – 12:35 PM EDT

PDB ID : 3UTT
Title : 1E6-A*0201-ALWGPDPA AAA Complex, Triclinic
Authors : Rizkallah, P.J.; Cole, D.K.; Sewell, A.K.; Bulek, A.M.; Rossjohn, J.; Gras, S.
Deposited on : 2011-11-26
Resolution : 2.60 Å(reported)

This is a Full wwPDB X-ray Structure Validation Report for a publicly released PDB entry.

We welcome your comments at validation@mail.wwpdb.org

A user guide is available at

<https://www.wwpdb.org/validation/2017/XrayValidationReportHelp>

with specific help available everywhere you see the ⓘ symbol.

The types of validation reports are described at

<http://www.wwpdb.org/validation/2017/FAQs#types>.

The following versions of software and data (see [references ⓘ](#)) were used in the production of this report:

MolProbity : 4.02b-467
Xtriage (Phenix) : 1.20.1
EDS : 2.37.1
Percentile statistics : 20191225.v01 (using entries in the PDB archive December 25th 2019)
Refmac : 5.8.0158
CCP4 : 7.0.044 (Gargrove)
Ideal geometry (proteins) : Engh & Huber (2001)
Ideal geometry (DNA, RNA) : Parkinson et al. (1996)
Validation Pipeline (wwPDB-VP) : 2.37.1

1 Overall quality at a glance

The following experimental techniques were used to determine the structure:

X-RAY DIFFRACTION

The reported resolution of this entry is 2.60 Å.

Percentile scores (ranging between 0-100) for global validation metrics of the entry are shown in the following graphic. The table shows the number of entries on which the scores are based.

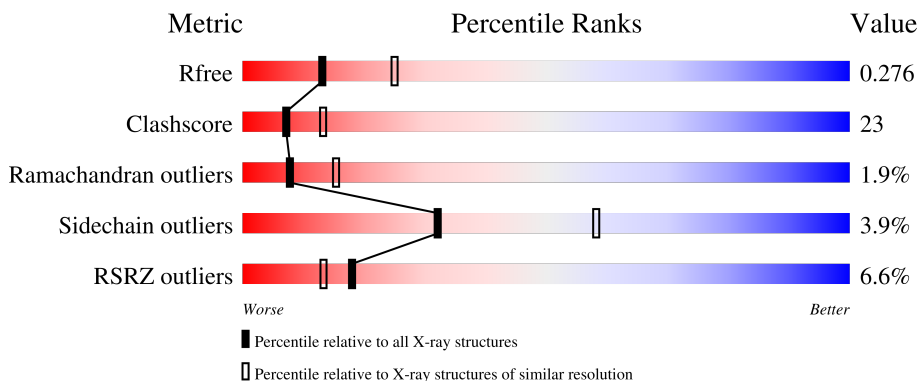

Metric	Whole archive (#Entries)	Similar resolution (#Entries, resolution range(Å))
R_{free}	130704	3163 (2.60-2.60)
Clashscore	141614	3518 (2.60-2.60)
Ramachandran outliers	138981	3455 (2.60-2.60)
Sidechain outliers	138945	3455 (2.60-2.60)
RSRZ outliers	127900	3104 (2.60-2.60)

The table below summarises the geometric issues observed across the polymeric chains and their fit to the electron density. The red, orange, yellow and green segments of the lower bar indicate the fraction of residues that contain outliers for ≥ 3 , 2, 1 and 0 types of geometric quality criteria respectively. A grey segment represents the fraction of residues that are not modelled. The numeric value for each fraction is indicated below the corresponding segment, with a dot representing fractions $\leq 5\%$. The upper red bar (where present) indicates the fraction of residues that have poor fit to the electron density. The numeric value is given above the bar.

Mol	Chain	Length	Quality of chain
1	A	275	
1	F	275	
2	B	100	
2	G	100	
3	C	10	

Continued on next page...

Continued from previous page...

Mol	Chain	Length	Quality of chain
3	H	10	
4	D	199	
4	I	199	
5	E	245	
5	J	245	

2 Entry composition [i](#)

There are 6 unique types of molecules in this entry. The entry contains 13562 atoms, of which 0 are hydrogens and 0 are deuteriums.

In the tables below, the ZeroOcc column contains the number of atoms modelled with zero occupancy, the AltConf column contains the number of residues with at least one atom in alternate conformation and the Trace column contains the number of residues modelled with at most 2 atoms.

- Molecule 1 is a protein called HLA class I histocompatibility antigen, A-2 alpha chain.

Mol	Chain	Residues	Atoms					ZeroOcc	AltConf	Trace
			Total	C	N	O	S			
1	A	275	Total	C	N	O	S	0	1	0
			2257	1409	413	426	9			
1	F	275	Total	C	N	O	S	0	3	0
			2277	1420	418	430	9			

- Molecule 2 is a protein called Beta-2-microglobulin.

Mol	Chain	Residues	Atoms					ZeroOcc	AltConf	Trace
			Total	C	N	O	S			
2	B	100	Total	C	N	O	S	0	0	0
			837	533	141	159	4			
2	G	100	Total	C	N	O	S	0	0	0
			837	533	141	159	4			

There are 2 discrepancies between the modelled and reference sequences:

Chain	Residue	Modelled	Actual	Comment	Reference
B	0	MET	-	INITIATING METHIONINE	UNP P61769
G	0	MET	-	INITIATING METHIONINE	UNP P61769

- Molecule 3 is a protein called Insulin.

Mol	Chain	Residues	Atoms				ZeroOcc	AltConf	Trace
			Total	C	N	O			
3	C	10	Total	C	N	O	0	0	0
			69	45	11	13			
3	H	10	Total	C	N	O	0	0	0
			69	45	11	13			

- Molecule 4 is a protein called 1E6 TCR Alpha Chain.

Mol	Chain	Residues	Atoms					ZeroOcc	AltConf	Trace
			Total	C	N	O	S			
4	D	199	Total	C	N	O	S	0	0	0
			1570	983	258	319	10			

Continued on next page...

Continued from previous page...

Mol	Chain	Residues	Atoms					ZeroOcc	AltConf	Trace
4	I	199	Total	C	N	O	S	0	0	0
			1570	983	258	319	10			

- Molecule 5 is a protein called 1E6 TCR Beta Chain.

Mol	Chain	Residues	Atoms					ZeroOcc	AltConf	Trace
5	E	244	Total	C	N	O	S	0	0	0
			1960	1242	339	369	10			
5	J	245	Total	C	N	O	S	0	0	0
			1965	1245	340	370	10			

- Molecule 6 is water.

Mol	Chain	Residues	Atoms		ZeroOcc	AltConf
6	A	23	Total	O	0	0
			23	23		
6	B	11	Total	O	0	0
			11	11		
6	D	10	Total	O	0	0
			10	10		
6	E	26	Total	O	0	0
			26	26		
6	F	28	Total	O	0	0
			28	28		
6	G	19	Total	O	0	0
			19	19		
6	H	1	Total	O	0	0
			1	1		
6	I	15	Total	O	0	0
			15	15		
6	J	18	Total	O	0	0
			18	18		

3 Residue-property plots

These plots are drawn for all protein, RNA, DNA and oligosaccharide chains in the entry. The first graphic for a chain summarises the proportions of the various outlier classes displayed in the second graphic. The second graphic shows the sequence view annotated by issues in geometry and electron density. Residues are color-coded according to the number of geometric quality criteria for which they contain at least one outlier: green = 0, yellow = 1, orange = 2 and red = 3 or more. A red dot above a residue indicates a poor fit to the electron density ($RSRZ > 2$). Stretches of 2 or more consecutive residues without any outlier are shown as a green connector. Residues present in the sample, but not in the model, are shown in grey.

- Molecule 1: HLA class I histocompatibility antigen, A-2 alpha chain

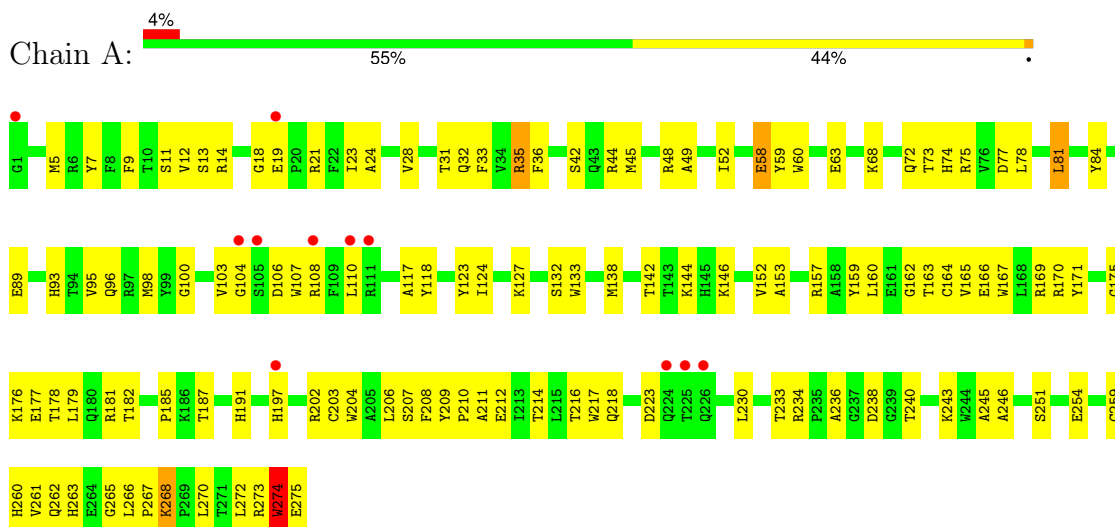

- Molecule 1: HLA class I histocompatibility antigen, A-2 alpha chain

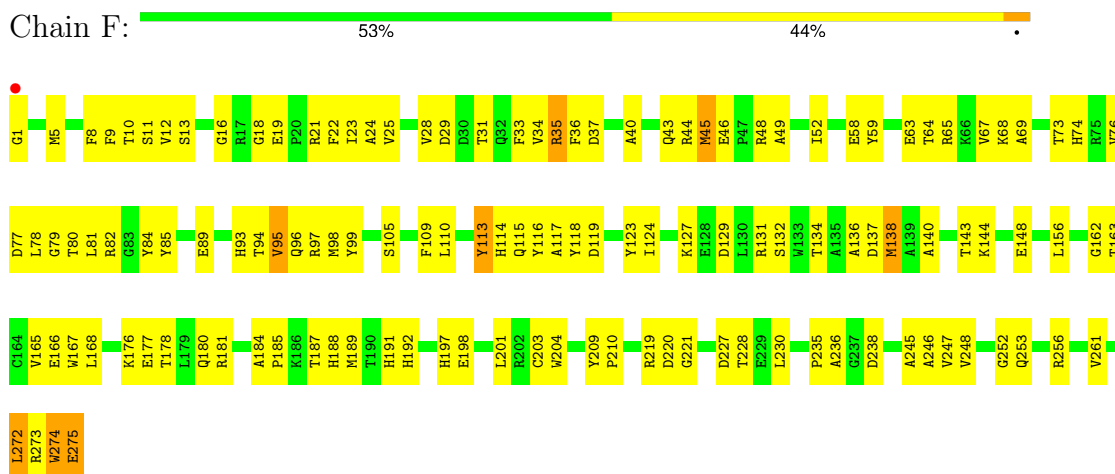

- Molecule 2: Beta-2-microglobulin



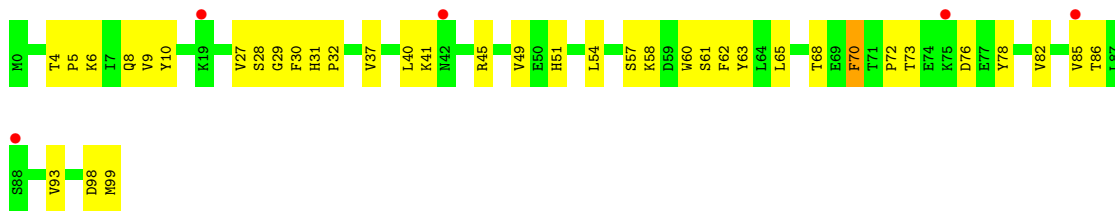

• Molecule 2: Beta-2-microglobulin

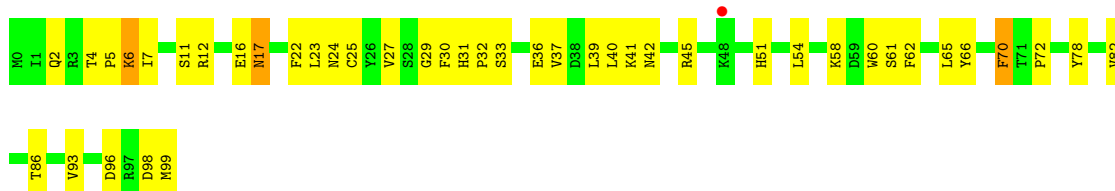

• Molecule 3: Insulin



• Molecule 3: Insulin



• Molecule 4: 1E6 TCR Alpha Chain

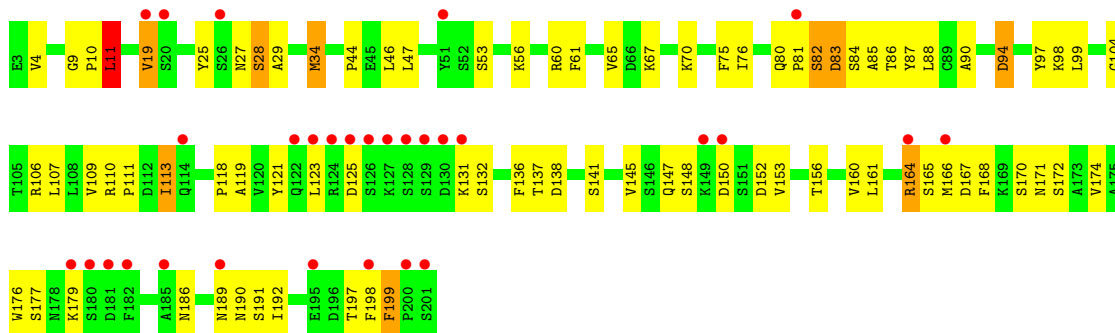

• Molecule 4: 1E6 TCR Alpha Chain



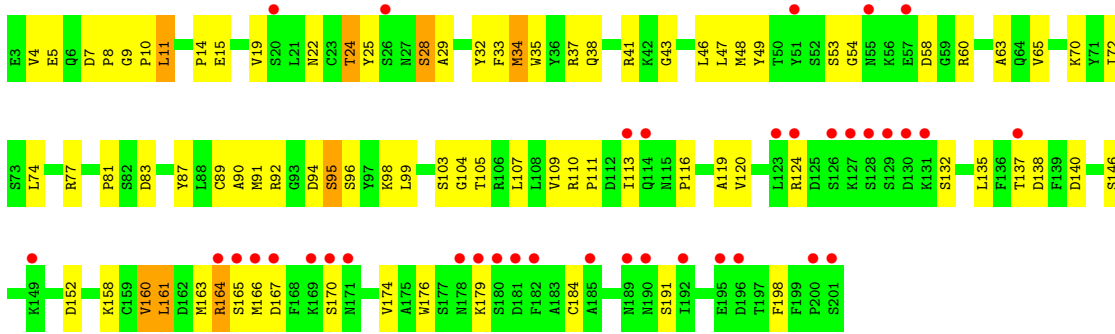

• Molecule 5: 1E6 TCR Beta Chain

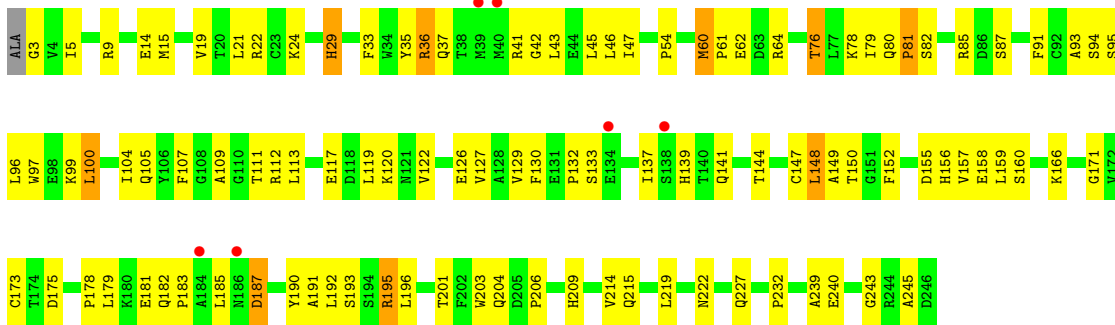

• Molecule 5: 1E6 TCR Beta Chain

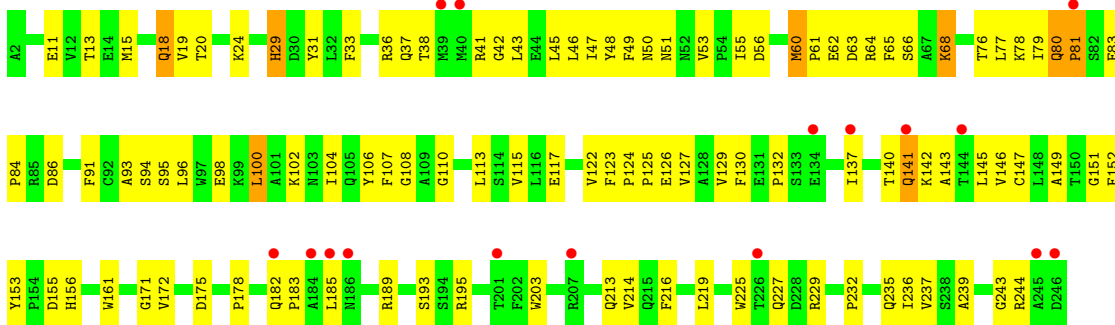

4 Data and refinement statistics

Property	Value	Source
Space group	P 1	Depositor
Cell constants a, b, c, α , β , γ	41.48Å 98.44Å 121.30Å 97.27° 98.16° 93.38°	Depositor
Resolution (Å)	29.34 – 2.60 29.34 – 2.60	Depositor EDS
% Data completeness (in resolution range)	89.9 (29.34-2.60) 97.0 (29.34-2.60)	Depositor EDS
R_{merge}	(Not available)	Depositor
R_{sym}	0.11	Depositor
$\langle I/\sigma(I) \rangle$ ¹	1.79 (at 2.61Å)	Xtrriage
Refinement program	PHENIX 1.6.1_357, REFMAC	Depositor
R, R_{free}	0.195 , 0.274 0.200 , 0.276	Depositor DCC
R_{free} test set	2840 reflections (5.08%)	wwPDB-VP
Wilson B-factor (Å ²)	43.5	Xtrriage
Anisotropy	0.604	Xtrriage
Bulk solvent k_{sol} (e/Å ³), B_{sol} (Å ²)	0.33 , 53.3	EDS
L-test for twinning ²	$\langle L \rangle = 0.49$, $\langle L^2 \rangle = 0.33$	Xtrriage
Estimated twinning fraction	No twinning to report.	Xtrriage
F_o, F_c correlation	0.94	EDS
Total number of atoms	13562	wwPDB-VP
Average B, all atoms (Å ²)	61.0	wwPDB-VP

Xtrriage's analysis on translational NCS is as follows: *The largest off-origin peak in the Patterson function is 4.90% of the height of the origin peak. No significant pseudotranslation is detected.*

¹Intensities estimated from amplitudes.

²Theoretical values of $\langle |L| \rangle$, $\langle L^2 \rangle$ for acentric reflections are 0.5, 0.333 respectively for untwinned datasets, and 0.375, 0.2 for perfectly twinned datasets.

5 Model quality [i](#)

5.1 Standard geometry [i](#)

The Z score for a bond length (or angle) is the number of standard deviations the observed value is removed from the expected value. A bond length (or angle) with $|Z| > 5$ is considered an outlier worth inspection. RMSZ is the root-mean-square of all Z scores of the bond lengths (or angles).

Mol	Chain	Bond lengths		Bond angles	
		RMSZ	# Z >5	RMSZ	# Z >5
1	A	0.24	0/2322	0.40	0/3151
1	F	0.23	0/2342	0.40	0/3177
2	B	0.26	0/860	0.40	0/1162
2	G	0.27	0/860	0.42	0/1162
3	C	0.20	0/72	0.58	0/99
3	H	0.18	0/72	0.68	0/99
4	D	0.24	0/1606	0.41	0/2174
4	I	0.25	0/1606	0.43	0/2174
5	E	0.25	0/2015	0.41	0/2741
5	J	0.25	0/2020	0.41	0/2748
All	All	0.24	0/13775	0.41	0/18687

There are no bond length outliers.

There are no bond angle outliers.

There are no chirality outliers.

There are no planarity outliers.

5.2 Too-close contacts [i](#)

In the following table, the Non-H and H(model) columns list the number of non-hydrogen atoms and hydrogen atoms in the chain respectively. The H(added) column lists the number of hydrogen atoms added and optimized by MolProbity. The Clashes column lists the number of clashes within the asymmetric unit, whereas Symm-Clashes lists symmetry-related clashes.

Mol	Chain	Non-H	H(model)	H(added)	Clashes	Symm-Clashes
1	A	2257	0	2108	102	0
1	F	2277	0	2125	123	0
2	B	837	0	803	26	0
2	G	837	0	803	39	0
3	C	69	0	64	15	0
3	H	69	0	64	13	0

Continued on next page...

Continued from previous page...

Mol	Chain	Non-H	H(model)	H(added)	Clashes	Symm-Clashes
4	D	1570	0	1481	74	0
4	I	1570	0	1481	70	0
5	E	1960	0	1875	93	0
5	J	1965	0	1880	103	0
6	A	23	0	0	1	0
6	B	11	0	0	0	0
6	D	10	0	0	2	0
6	E	26	0	0	0	0
6	F	28	0	0	1	0
6	G	19	0	0	0	0
6	H	1	0	0	0	0
6	I	15	0	0	1	0
6	J	18	0	0	2	0
All	All	13562	0	12684	591	0

The all-atom clashscore is defined as the number of clashes found per 1000 atoms (including hydrogen atoms). The all-atom clashscore for this structure is 23.

All (591) close contacts within the same asymmetric unit are listed below, sorted by their clash magnitude.

Atom-1	Atom-2	Interatomic distance (Å)	Clash overlap (Å)
5:E:80:GLN:HB3	5:E:81:PRO:HD2	1.45	0.98
3:C:7:PRO:HA	3:C:8:ALA:HB3	1.45	0.97
1:A:274:TRP:HE3	1:A:275:GLU:H	1.08	0.96
1:A:191:HIS:HB2	1:A:275:GLU:HB3	1.51	0.92
4:D:34:MET:HB2	4:D:46:LEU:HD11	1.51	0.91
1:A:274:TRP:HE3	1:A:275:GLU:N	1.71	0.88
4:I:94:ASP:H	4:I:95:SER:HB3	1.40	0.86
1:F:69:ALA:HB1	3:H:6:ASP:HB3	1.59	0.85
1:F:11:SER:HB3	1:F:95:VAL:HG13	1.59	0.84
1:A:266:LEU:HD22	1:A:270:LEU:HD13	1.59	0.83
4:D:111:PRO:HG2	4:D:160:VAL:HG11	1.60	0.83
1:A:12:VAL:HG13	1:A:21:ARG:HB3	1.61	0.81
5:J:155:ASP:HB2	5:J:178:PRO:HG2	1.62	0.81
1:F:274:TRP:O	1:F:275:GLU:HB2	1.80	0.80
5:J:43:LEU:HD23	5:J:43:LEU:H	1.46	0.79
5:E:120:LYS:HB2	5:E:227:GLN:HE21	1.49	0.78
4:D:121:TYR:HB3	5:E:133:SER:HB3	1.67	0.77
3:H:7:PRO:HA	3:H:8:ALA:HB3	1.67	0.76
1:A:127:LYS:HD2	1:A:132:SER:HB2	1.66	0.76
5:J:46:LEU:O	5:J:60:MET:HG2	1.86	0.76

Continued on next page...

Continued from previous page...

Atom-1	Atom-2	Interatomic distance (Å)	Clash overlap (Å)
4:I:46:LEU:HD23	5:J:104:ILE:HD13	1.68	0.76
1:A:187:THR:HG21	1:A:261:VAL:HG21	1.66	0.75
4:I:94:ASP:N	4:I:95:SER:HB3	2.02	0.75
1:A:133:TRP:HB2	1:A:144:LYS:HE2	1.68	0.74
5:E:33:PHE:HB2	5:E:93:ALA:HB3	1.68	0.74
5:J:46:LEU:HB3	5:J:60:MET:HE3	1.70	0.74
1:F:189:MET:HB2	1:F:272:LEU:HD23	1.68	0.73
5:J:213:GLN:HG3	5:J:236:ILE:HG23	1.71	0.72
1:A:73:THR:HG21	3:C:7:PRO:HB2	1.71	0.72
4:D:19:VAL:HG13	4:D:76:ILE:HB	1.72	0.71
1:F:117:ALA:HB2	2:G:60:TRP:CE2	2.26	0.71
4:D:82:SER:O	4:D:84:SER:N	2.22	0.71
5:E:80:GLN:HB3	5:E:81:PRO:CD	2.20	0.71
1:A:204:TRP:CZ2	2:B:99:MET:HA	2.25	0.71
3:H:7:PRO:CA	3:H:8:ALA:HB3	2.21	0.71
1:F:12:VAL:HG12	1:F:21:ARG:HB3	1.72	0.70
4:D:10:PRO:HB3	4:D:106:ARG:NH1	2.07	0.70
5:J:41:ARG:HG2	5:J:42:GLY:N	2.07	0.69
4:D:152:ASP:HB3	4:D:179:LYS:HD2	1.73	0.69
4:I:53:SER:HA	4:I:65:VAL:HG13	1.73	0.69
1:F:187:THR:HG21	1:F:261:VAL:HG21	1.73	0.69
3:C:7:PRO:CA	3:C:8:ALA:HB3	2.22	0.69
3:C:7:PRO:HA	3:C:8:ALA:CB	2.22	0.69
4:D:44:PRO:HG2	5:E:43:LEU:HD11	1.75	0.69
5:J:225:TRP:CE2	5:J:227:GLN:HB2	2.29	0.68
2:B:41:LYS:HG3	2:B:78:TYR:CE1	2.29	0.68
4:I:8:PRO:CB	4:I:9:GLY:HA2	2.24	0.68
1:F:44:ARG:HA	1:F:64:THR:HG23	1.76	0.66
1:F:65[A]:ARG:NE	4:I:96:SER:HB2	2.11	0.66
1:F:235:PRO:HG2	2:G:65:LEU:HD22	1.77	0.66
1:A:273:ARG:HG2	1:A:274:TRP:H	1.60	0.66
1:A:211:ALA:HB1	1:A:233:THR:HG21	1.77	0.66
5:J:19:VAL:HG22	5:J:79:ILE:HB	1.77	0.66
2:B:5:PRO:HA	2:B:30:PHE:HB3	1.76	0.66
5:J:80:GLN:HG3	5:J:81:PRO:HD2	1.77	0.66
1:F:12:VAL:CG1	1:F:21:ARG:HB3	2.26	0.65
4:I:8:PRO:HB2	4:I:9:GLY:HA2	1.78	0.65
3:H:7:PRO:HA	3:H:8:ALA:CB	2.26	0.65
1:F:191:HIS:CB	1:F:275:GLU:HG2	2.26	0.64
1:F:35:ARG:NH1	1:F:48:ARG:HH12	1.94	0.64
1:A:152:VAL:HG22	5:E:97:TRP:CH2	2.32	0.64

Continued on next page...

Continued from previous page...

Atom-1	Atom-2	Interatomic distance (Å)	Clash overlap (Å)
4:I:92:ARG:HB3	4:I:99:LEU:HD12	1.79	0.64
4:I:34:MET:HG2	4:I:90:ALA:HB3	1.80	0.64
1:A:32:GLN:NE2	1:A:48:ARG:HG3	2.13	0.64
5:E:99:LYS:HB3	5:E:104:ILE:HB	1.80	0.64
1:F:82[A]:ARG:HD2	1:F:89:GLU:HA	1.78	0.64
4:I:161:LEU:HB2	4:I:170:SER:O	1.98	0.64
5:E:122:VAL:HG12	5:E:232:PRO:HB2	1.81	0.63
5:J:132:PRO:HD2	5:J:203:TRP:CZ2	2.34	0.63
5:E:120:LYS:HB2	5:E:227:GLN:NE2	2.13	0.63
5:E:129:VAL:HG23	5:E:239:ALA:HB3	1.81	0.63
4:I:103:SER:HA	5:J:42:GLY:H	1.63	0.63
1:F:64:THR:HG22	1:F:68:LYS:HE3	1.81	0.63
5:E:76:THR:HG23	5:E:78:LYS:HG3	1.80	0.62
1:F:177:GLU:HG2	1:F:178:THR:HG23	1.80	0.62
4:I:138:ASP:HA	4:I:170:SER:HB2	1.81	0.62
4:I:5:GLU:HB3	4:I:24:THR:HG23	1.81	0.62
4:D:113:ILE:HD13	4:D:113:ILE:N	2.15	0.62
1:A:89:GLU:HB3	5:J:24:LYS:NZ	2.15	0.61
4:D:186:ASN:HB2	4:D:189:ASN:HD21	1.65	0.61
1:A:204:TRP:HZ2	2:B:99:MET:HA	1.65	0.61
4:D:123:LEU:HG	5:E:132:PRO:HA	1.80	0.61
1:A:214:THR:HB	1:A:262:GLN:HB2	1.83	0.61
5:J:124:PRO:HD3	5:J:232:PRO:HB3	1.83	0.61
5:E:204:GLN:HB3	5:E:245:ALA:HA	1.82	0.61
1:F:273:ARG:HG2	1:F:274:TRP:H	1.65	0.61
1:A:267:PRO:HG2	1:A:268:LYS:HG3	1.83	0.61
1:F:69:ALA:CB	3:H:6:ASP:HB3	2.28	0.61
4:I:43:GLY:HA2	5:J:91:PHE:CE1	2.34	0.61
5:E:219:LEU:HD13	5:E:232:PRO:HG2	1.80	0.61
4:I:48:MET:SD	4:I:58:ASP:HB3	2.41	0.61
1:F:123:TYR:CZ	1:F:140:ALA:HA	2.36	0.60
4:D:161:LEU:HD21	5:E:171:GLY:O	2.02	0.60
1:F:82[A]:ARG:HE	1:F:89:GLU:HG2	1.67	0.60
1:F:178:THR:O	1:F:181:ARG:HG2	2.01	0.60
4:I:11:LEU:HD12	4:I:11:LEU:O	2.01	0.60
5:J:61:PRO:O	5:J:62:GLU:HB2	2.00	0.60
4:D:98:LYS:HA	5:E:45:LEU:HD22	1.84	0.60
1:A:133:TRP:HE1	1:A:153:ALA:HB2	1.67	0.60
4:I:113:ILE:HD13	4:I:116:PRO:HD3	1.84	0.60
2:G:7:ILE:HB	2:G:93:VAL:HG21	1.82	0.60
5:J:127:VAL:HG13	5:J:147:CYS:SG	2.41	0.60

Continued on next page...

Continued from previous page...

Atom-1	Atom-2	Interatomic distance (Å)	Clash overlap (Å)
1:A:12:VAL:CG1	1:A:21:ARG:HB3	2.31	0.59
1:A:9:PHE:HZ	3:C:2:LEU:HD11	1.67	0.59
1:F:23:ILE:HG12	1:F:37:ASP:OD1	2.03	0.59
1:F:238:ASP:HB3	2:G:12:ARG:HD3	1.84	0.59
5:J:227:GLN:HG2	6:J:248:HOH:O	2.01	0.59
1:A:95:VAL:HG12	1:A:118:TYR:HD1	1.68	0.59
4:D:110:ARG:HB3	4:D:141:SER:HB3	1.85	0.59
4:D:136:PHE:O	4:D:172:SER:HA	2.02	0.59
2:G:24:ASN:HB3	2:G:65:LEU:HD11	1.85	0.58
4:D:25:TYR:CE1	4:D:70:LYS:HG3	2.37	0.58
1:A:81:LEU:HD23	1:A:118:TYR:CD1	2.38	0.58
4:I:33:PHE:CE2	4:I:65:VAL:HG21	2.38	0.58
5:J:80:GLN:CB	5:J:81:PRO:HD2	2.33	0.58
1:A:63:GLU:OE1	3:C:2:LEU:HB2	2.04	0.58
5:J:219:LEU:HD13	5:J:232:PRO:HG2	1.85	0.58
1:A:58:GLU:CD	1:A:58:GLU:H	2.06	0.58
4:D:80:GLN:HB3	4:D:81:PRO:HD2	1.85	0.58
5:J:41:ARG:HG2	5:J:42:GLY:H	1.68	0.58
4:D:125:ASP:HA	5:E:130:PHE:HD2	1.69	0.57
2:B:98:ASP:O	2:B:99:MET:HB3	2.04	0.57
4:I:33:PHE:CD1	4:I:72:ILE:HD11	2.40	0.57
1:A:274:TRP:CE3	1:A:275:GLU:N	2.56	0.57
4:I:25:TYR:O	4:I:70:LYS:HB3	2.04	0.57
5:E:173:CYS:HB3	5:E:195:ARG:HD2	1.87	0.57
4:I:35:TRP:CE2	4:I:74:LEU:HB2	2.40	0.57
1:A:203:CYS:HB2	1:A:217:TRP:CZ2	2.40	0.57
4:D:28:SER:O	4:D:29:ALA:HB3	2.05	0.56
1:F:189:MET:HB2	1:F:272:LEU:CD2	2.34	0.56
4:I:81:PRO:HA	4:I:109:VAL:HG13	1.87	0.56
1:A:11:SER:HB3	1:A:95:VAL:CG2	2.35	0.56
4:I:8:PRO:HB2	4:I:10:PRO:HD2	1.87	0.56
1:A:103:VAL:HB	1:A:107:TRP:HA	1.86	0.56
1:A:12:VAL:HA	1:A:93:HIS:O	2.06	0.56
1:A:68:LYS:O	1:A:72:GLN:HG2	2.06	0.56
1:F:176:LYS:HA	1:F:180:GLN:HG3	1.88	0.56
4:I:7:ASP:HB2	4:I:105:THR:OG1	2.05	0.56
3:C:5:PRO:HA	4:D:94:ASP:O	2.05	0.56
5:J:93:ALA:HA	5:J:106:TYR:O	2.06	0.56
1:A:23:ILE:HA	1:A:36:PHE:O	2.06	0.56
5:E:24:LYS:CE	1:F:89:GLU:HB3	2.36	0.56
5:E:149:ALA:HB2	5:E:214:VAL:HG21	1.88	0.56

Continued on next page...

Continued from previous page...

Atom-1	Atom-2	Interatomic distance (Å)	Clash overlap (Å)
4:D:118:PRO:HB2	4:D:197:THR:HA	1.88	0.55
5:E:60:MET:HE3	5:E:60:MET:HA	1.88	0.55
5:E:19:VAL:HG22	5:E:79:ILE:HB	1.88	0.55
1:F:73:THR:HG21	3:H:7:PRO:HB2	1.88	0.55
1:F:144:LYS:O	1:F:148:GLU:HG2	2.06	0.55
4:D:81:PRO:O	4:D:82:SER:O	2.25	0.55
5:E:24:LYS:HE2	1:F:89:GLU:HB3	1.88	0.55
5:E:46:LEU:HB3	5:E:60:MET:HE3	1.89	0.55
4:I:87:TYR:O	4:I:104:GLY:HA2	2.07	0.55
4:D:53:SER:HA	4:D:65:VAL:HG13	1.89	0.55
5:E:64:ARG:HH21	5:E:85:ARG:NH2	2.05	0.55
1:F:8:PHE:HB2	1:F:25:VAL:HG22	1.88	0.55
5:J:84:PRO:HA	5:J:115:VAL:O	2.06	0.55
2:B:73:THR:OG1	2:B:76:ASP:HB2	2.06	0.55
1:A:187:THR:HB	1:A:272:LEU:HD21	1.88	0.55
1:F:35:ARG:HD3	1:F:35:ARG:C	2.27	0.55
1:A:7:TYR:O	1:A:98:MET:HA	2.07	0.55
5:E:21:LEU:HD22	5:E:111:THR:HG21	1.89	0.55
5:E:47:ILE:HD11	5:E:54:PRO:HB3	1.89	0.55
1:F:93:HIS:HE1	6:F:303:HOH:O	1.88	0.55
5:J:80:GLN:CG	5:J:81:PRO:HD2	2.36	0.55
4:D:176:TRP:CE3	5:E:148:LEU:HD11	2.42	0.54
5:J:129:VAL:HG23	5:J:239:ALA:HB3	1.89	0.54
4:D:150:ASP:OD1	4:D:153:VAL:HG23	2.08	0.54
4:I:164:ARG:HA	4:I:164:ARG:NE	2.22	0.54
4:I:37:ARG:HB2	4:I:47:LEU:HD11	1.87	0.54
5:E:41:ARG:HG2	5:E:42:GLY:N	2.21	0.54
1:F:49:ALA:O	1:F:52:ILE:HG22	2.08	0.54
3:H:7:PRO:CA	3:H:8:ALA:CB	2.85	0.54
4:I:94:ASP:H	4:I:95:SER:CB	2.15	0.54
4:I:98:LYS:HA	5:J:45:LEU:HD22	1.87	0.54
5:J:19:VAL:CG2	5:J:79:ILE:HB	2.37	0.54
5:J:29:HIS:HD2	5:J:94:SER:OG	1.91	0.54
4:D:131:LYS:HD3	4:D:176:TRP:CD1	2.43	0.54
4:I:28:SER:O	4:I:29:ALA:HB3	2.08	0.54
2:B:31:HIS:ND1	2:B:32:PRO:HA	2.23	0.54
4:D:125:ASP:HA	5:E:130:PHE:CD2	2.43	0.54
2:B:49:VAL:HG22	2:B:68:THR:HB	1.90	0.53
1:F:124:ILE:HA	1:F:134:THR:O	2.08	0.53
1:F:65[B]:ARG:NH1	5:J:56:ASP:HA	2.24	0.53
1:A:160:LEU:O	1:A:165:VAL:HG23	2.08	0.53

Continued on next page...

Continued from previous page...

Atom-1	Atom-2	Interatomic distance (Å)	Clash overlap (Å)
4:D:113:ILE:HD12	4:D:141:SER:H	1.72	0.53
5:E:46:LEU:HB3	5:E:60:MET:CE	2.39	0.53
1:A:73:THR:HG21	3:C:7:PRO:CB	2.39	0.53
4:D:148:SER:HA	4:D:190:ASN:ND2	2.24	0.53
4:D:121:TYR:HB3	5:E:133:SER:CB	2.36	0.53
1:A:268:LYS:HD2	1:A:268:LYS:O	2.08	0.53
2:G:2:GLN:HB3	2:G:86:THR:HG22	1.90	0.53
2:G:25:CYS:HB2	2:G:39:LEU:HD21	1.91	0.53
4:I:113:ILE:HD11	4:I:140:ASP:OD1	2.09	0.53
5:E:132:PRO:HD2	5:E:203:TRP:CZ2	2.44	0.52
4:D:148:SER:HA	4:D:190:ASN:HD22	1.75	0.52
5:E:37:GLN:OE1	5:E:91:PHE:HE2	1.92	0.52
1:F:203:CYS:SG	1:F:272:LEU:HD22	2.48	0.52
1:F:138:MET:HA	1:F:138:MET:CE	2.40	0.52
1:F:230:LEU:HD13	1:F:245:ALA:HB2	1.92	0.52
1:A:162:GLY:O	1:A:166:GLU:HG3	2.08	0.52
5:E:80:GLN:O	5:E:81:PRO:C	2.48	0.52
1:F:82[B]:ARG:HD2	1:F:89:GLU:HG2	1.91	0.52
3:H:7:PRO:HB3	3:H:8:ALA:HB3	1.90	0.52
1:A:230:LEU:HD11	1:A:243:LYS:HE3	1.90	0.52
1:A:117:ALA:HB2	2:B:60:TRP:CE2	2.45	0.52
5:E:9:ARG:NH1	5:E:109:ALA:HB3	2.25	0.52
2:G:5:PRO:HA	2:G:30:PHE:HB3	1.92	0.52
2:G:98:ASP:O	2:G:99:MET:HG2	2.10	0.52
1:F:93:HIS:HD2	1:F:119:ASP:OD2	1.92	0.51
1:A:182:THR:HB	1:A:265:GLY:HA2	1.91	0.51
1:A:204:TRP:CH2	2:B:99:MET:HA	2.44	0.51
4:D:176:TRP:CG	5:E:148:LEU:HD21	2.46	0.51
5:J:80:GLN:O	5:J:81:PRO:C	2.48	0.51
5:J:46:LEU:HB3	5:J:60:MET:CE	2.39	0.51
4:I:111:PRO:HG2	4:I:160:VAL:HG22	1.92	0.51
1:F:253:GLN:O	1:F:256:ARG:HB2	2.10	0.51
5:J:125:PRO:HD3	5:J:216:PHE:CD1	2.45	0.51
1:A:152:VAL:HG22	5:E:97:TRP:CZ3	2.46	0.51
1:A:204:TRP:CE3	1:A:206:LEU:HD21	2.46	0.51
5:E:155:ASP:HB2	5:E:178:PRO:HG2	1.93	0.51
4:D:166:MET:O	4:D:168:PHE:N	2.40	0.51
5:E:175:ASP:OD2	5:E:193:SER:HB3	2.11	0.51
1:F:94:THR:O	1:F:118:TYR:HA	2.11	0.51
1:A:45:MET:HG3	1:A:60:TRP:HZ3	1.76	0.51
5:J:137:ILE:O	5:J:141:GLN:HA	2.11	0.51

Continued on next page...

Continued from previous page...

Atom-1	Atom-2	Interatomic distance (Å)	Clash overlap (Å)
5:E:61:PRO:O	5:E:62:GLU:HB2	2.11	0.51
1:F:11:SER:HA	1:F:21:ARG:O	2.11	0.51
1:F:37:ASP:HB3	1:F:40:ALA:HB2	1.93	0.50
4:I:9:GLY:HA3	4:I:105:THR:HG23	1.92	0.50
5:E:76:THR:CG2	5:E:78:LYS:HG3	2.40	0.50
1:A:9:PHE:O	1:A:96:GLN:HA	2.11	0.50
1:A:266:LEU:HD12	1:A:266:LEU:O	2.11	0.50
4:I:60:ARG:HA	4:I:77:ARG:NH1	2.25	0.50
1:A:9:PHE:CZ	3:C:2:LEU:HD11	2.46	0.50
1:F:8:PHE:O	1:F:24:ALA:HA	2.12	0.50
1:F:188:HIS:C	1:F:272:LEU:HD21	2.32	0.50
1:F:95:VAL:HA	1:F:117:ALA:O	2.11	0.50
5:J:132:PRO:HD2	5:J:203:TRP:CH2	2.47	0.50
1:F:35:ARG:HG2	1:F:48:ARG:CZ	2.41	0.50
2:B:9:VAL:HG21	2:B:93:VAL:O	2.12	0.50
4:D:34:MET:HG2	4:D:90:ALA:HB3	1.93	0.50
4:D:125:ASP:OD2	4:D:132:SER:HA	2.11	0.50
1:F:69:ALA:HB1	3:H:6:ASP:CB	2.35	0.50
1:F:78:LEU:HD21	1:F:95:VAL:HG12	1.93	0.50
4:I:8:PRO:HB2	4:I:10:PRO:CD	2.42	0.50
5:J:122:VAL:HA	5:J:153:TYR:O	2.11	0.50
5:J:130:PHE:HD1	5:J:146:VAL:O	1.95	0.50
1:F:80:THR:HG22	1:F:84:TYR:CZ	2.47	0.50
1:F:192:HIS:CE1	2:G:98:ASP:HB3	2.47	0.50
3:H:7:PRO:CB	3:H:8:ALA:HB3	2.41	0.50
5:J:13:THR:HG21	5:J:19:VAL:CG1	2.42	0.50
1:F:44:ARG:HA	1:F:64:THR:CG2	2.40	0.49
1:F:228:THR:HG22	1:F:247:VAL:HG23	1.94	0.49
5:J:203:TRP:O	5:J:243:GLY:HA2	2.12	0.49
2:B:58:LYS:HD3	2:B:58:LYS:C	2.31	0.49
4:D:119:ALA:HA	4:D:198:PHE:HB3	1.95	0.49
4:D:164:ARG:O	4:D:166:MET:N	2.45	0.49
1:F:191:HIS:HB2	1:F:275:GLU:HG2	1.94	0.49
1:F:274:TRP:O	1:F:275:GLU:CB	2.58	0.49
2:G:31:HIS:ND1	2:G:32:PRO:HA	2.27	0.49
5:J:18:GLN:OE1	5:J:78:LYS:HD3	2.11	0.49
4:D:113:ILE:HD13	4:D:113:ILE:H	1.77	0.49
4:D:168:PHE:CE2	4:D:170:SER:HB3	2.47	0.49
3:C:5:PRO:O	3:C:6:ASP:HB3	2.13	0.49
4:D:67:LYS:O	4:D:70:LYS:HD2	2.13	0.49
4:D:84:SER:HA	4:D:107:LEU:O	2.13	0.49

Continued on next page...

Continued from previous page...

Atom-1	Atom-2	Interatomic distance (Å)	Clash overlap (Å)
1:F:143:THR:HG23	3:H:10:ALA:HA	1.95	0.49
1:F:219:ARG:C	1:F:219:ARG:HD2	2.32	0.49
2:G:11:SER:HA	2:G:22:PHE:O	2.12	0.49
4:I:113:ILE:O	4:I:113:ILE:HD12	2.13	0.49
5:J:225:TRP:CZ2	5:J:227:GLN:HB2	2.47	0.49
5:J:123:PHE:HD1	5:J:229:ARG:NH2	2.10	0.49
5:J:142:LYS:HZ2	5:J:142:LYS:HB3	1.77	0.49
1:F:76:VAL:HG22	5:J:51:ASN:HD21	1.78	0.49
1:F:209:TYR:CD1	1:F:210:PRO:HA	2.48	0.49
1:A:123:TYR:HD2	1:A:124:ILE:HG22	1.78	0.49
1:F:5:MET:HB2	1:F:168:LEU:HD13	1.93	0.49
1:F:129:ASP:O	1:F:131:ARG:HG2	2.13	0.49
1:A:11:SER:HB3	1:A:95:VAL:HG22	1.94	0.49
2:B:29:GLY:HA2	2:B:61:SER:OG	2.13	0.49
2:G:5:PRO:CA	2:G:30:PHE:HB3	2.42	0.49
5:J:13:THR:HG21	5:J:19:VAL:HG12	1.95	0.48
4:D:10:PRO:O	4:D:11:LEU:O	2.31	0.48
1:F:45:MET:HG2	1:F:63:GLU:HB3	1.95	0.48
5:J:47:ILE:HG12	5:J:48:TYR:N	2.29	0.48
1:A:230:LEU:HD13	1:A:245:ALA:HB2	1.95	0.48
4:D:90:ALA:HB1	4:D:99:LEU:HG	1.95	0.48
1:F:127:LYS:HD2	1:F:132:SER:HB2	1.95	0.48
2:G:25:CYS:CB	2:G:39:LEU:HD21	2.44	0.48
1:A:187:THR:CG2	1:A:261:VAL:HG21	2.37	0.48
4:D:80:GLN:O	4:D:109:VAL:HG11	2.14	0.48
4:D:138:ASP:H	4:D:170:SER:HB2	1.78	0.48
1:F:9:PHE:HB2	1:F:97:ARG:HB3	1.95	0.48
1:A:7:TYR:CE2	3:C:2:LEU:HD13	2.48	0.48
4:I:146:SER:H	4:I:191:SER:HB2	1.79	0.48
5:J:132:PRO:CG	5:J:143:ALA:HB1	2.44	0.48
5:J:149:ALA:HB2	5:J:214:VAL:HG21	1.95	0.48
1:A:274:TRP:HE3	1:A:275:GLU:CA	2.26	0.48
1:F:79:GLY:HA2	1:F:82[A]:ARG:NH1	2.28	0.48
1:F:10:THR:O	1:F:22:PHE:HA	2.14	0.48
5:J:145:LEU:HD12	5:J:145:LEU:N	2.29	0.47
1:F:82[A]:ARG:NE	1:F:89:GLU:HG2	2.28	0.47
1:A:127:LYS:HD2	1:A:132:SER:CB	2.40	0.47
1:A:251:SER:HA	1:A:254:GLU:OE2	2.14	0.47
1:A:165:VAL:O	1:A:169:ARG:HG3	2.15	0.47
5:E:192:LEU:HG	5:E:193:SER:H	1.80	0.47
1:A:133:TRP:NE1	1:A:153:ALA:HB2	2.28	0.47

Continued on next page...

Continued from previous page...

Atom-1	Atom-2	Interatomic distance (Å)	Clash overlap (Å)
1:A:207:SER:HA	1:A:240:THR:HB	1.96	0.47
1:A:236:ALA:HB3	1:A:238:ASP:OD1	2.14	0.47
5:E:64:ARG:HH21	5:E:85:ARG:HH21	1.62	0.47
1:A:187:THR:HA	1:A:204:TRP:O	2.14	0.47
4:D:60:ARG:HD2	6:D:211:HOH:O	2.14	0.47
1:F:33:PHE:O	1:F:48:ARG:N	2.44	0.47
4:I:135:LEU:HG	4:I:137:THR:HB	1.97	0.47
5:J:33:PHE:HZ	5:J:100:LEU:HD21	1.80	0.47
5:J:132:PRO:HB2	5:J:137:ILE:HD11	1.97	0.47
1:F:114:HIS:CD2	1:F:156:LEU:HD11	2.50	0.47
4:I:132:SER:O	4:I:176:TRP:HA	2.15	0.47
5:J:31:TYR:HB2	5:J:95:SER:O	2.15	0.47
1:A:5:MET:O	1:A:100:GLY:HA3	2.14	0.47
1:A:28:VAL:HG23	1:A:33:PHE:CE1	2.50	0.47
5:E:76:THR:O	5:E:76:THR:HG22	2.14	0.47
5:E:129:VAL:HG23	5:E:239:ALA:CB	2.45	0.47
2:G:37:VAL:HB	2:G:66:TYR:CZ	2.49	0.47
4:I:25:TYR:CE1	4:I:70:LYS:HG3	2.50	0.47
4:D:176:TRP:O	4:D:177:SER:HB2	2.15	0.47
4:D:11:LEU:HD11	4:D:107:LEU:HD13	1.96	0.46
4:D:60:ARG:NH2	4:D:83:ASP:OD2	2.48	0.46
1:F:74:HIS:CE1	1:F:97:ARG:HE	2.32	0.46
5:J:175:ASP:OD2	5:J:193:SER:HB3	2.15	0.46
5:E:127:VAL:HG13	5:E:147:CYS:SG	2.55	0.46
1:F:227:ASP:HB3	1:F:248:VAL:HB	1.96	0.46
5:J:20:THR:HG23	5:J:76:THR:CG2	2.46	0.46
5:J:83:GLU:O	5:J:86:ASP:HB2	2.15	0.46
1:F:85:TYR:HE1	1:F:137:ASP:OD2	1.98	0.46
1:A:89:GLU:HB3	5:J:24:LYS:HZ1	1.79	0.46
1:F:96:GLN:O	1:F:116:TYR:HA	2.15	0.46
2:G:16:GLU:O	2:G:17:ASN:C	2.54	0.46
2:G:27:VAL:HG11	2:G:37:VAL:HG22	1.96	0.46
5:J:123:PHE:CD1	5:J:229:ARG:NH2	2.83	0.46
5:E:29:HIS:HA	5:E:96:LEU:CD2	2.46	0.46
4:I:19:VAL:HG21	4:I:107:LEU:HD13	1.96	0.46
5:J:63:ASP:O	5:J:64:ARG:HB2	2.16	0.46
2:B:37:VAL:HG22	2:B:82:VAL:HG22	1.97	0.46
4:D:156:THR:HG21	5:E:193:SER:HB3	1.98	0.46
1:F:273:ARG:HG2	1:F:274:TRP:N	2.30	0.46
4:I:111:PRO:CG	4:I:160:VAL:HG22	2.46	0.46
5:E:35:TYR:HE1	5:E:105:GLN:HE22	1.64	0.46

Continued on next page...

Continued from previous page...

Atom-1	Atom-2	Interatomic distance (Å)	Clash overlap (Å)
5:E:37:GLN:HB2	5:E:43:LEU:HD23	1.98	0.46
5:E:158:GLU:HB2	5:E:215:GLN:HB3	1.96	0.46
4:I:15:GLU:HB2	4:I:110:ARG:O	2.16	0.46
1:A:104:GLY:N	1:A:110:LEU:HG	2.31	0.46
5:J:43:LEU:H	5:J:43:LEU:CD2	2.23	0.46
1:F:28:VAL:HG23	1:F:33:PHE:CD1	2.51	0.45
1:A:14:ARG:HD3	1:A:21:ARG:HB2	1.98	0.45
1:A:202:ARG:HA	1:A:246:ALA:HA	1.98	0.45
5:E:185:LEU:HB3	5:E:187:ASP:OD1	2.16	0.45
1:F:219:ARG:C	1:F:221:GLY:H	2.19	0.45
1:A:212:GLU:O	1:A:263:HIS:HD2	1.99	0.45
3:C:2:LEU:HD12	3:C:2:LEU:HA	1.73	0.45
4:D:83:ASP:HA	6:D:205:HOH:O	2.15	0.45
5:E:14:GLU:HB2	5:E:119:LEU:HG	1.98	0.45
1:F:167:TRP:CD1	3:H:1:ALA:HB3	2.51	0.45
5:J:100:LEU:HD12	5:J:100:LEU:HA	1.81	0.45
1:F:33:PHE:CD2	1:F:34:VAL:HG13	2.52	0.45
1:F:235:PRO:CG	2:G:65:LEU:HD22	2.45	0.45
5:J:29:HIS:CD2	5:J:94:SER:OG	2.70	0.45
1:A:13:SER:HB3	1:A:78:LEU:HD13	1.99	0.45
4:D:131:LYS:HE2	5:E:150:THR:HG21	1.98	0.45
5:E:95:SER:OG	5:E:100:LEU:HD13	2.16	0.45
5:E:181:GLU:C	5:E:183:PRO:HD3	2.37	0.45
1:A:171:TYR:O	1:A:175:GLY:N	2.50	0.45
2:G:4:THR:OG1	2:G:5:PRO:HD2	2.16	0.45
5:J:80:GLN:HB3	5:J:81:PRO:HD2	1.98	0.45
1:A:209:TYR:CD1	1:A:210:PRO:HA	2.52	0.45
5:E:119:LEU:HD13	5:E:219:LEU:HG	1.99	0.45
1:F:1:GLY:O	1:F:105:SER:HA	2.17	0.45
5:J:60:MET:HE2	5:J:65:PHE:HB3	1.98	0.45
1:A:234:ARG:HD3	2:B:8:GLN:OE1	2.17	0.45
5:E:129:VAL:HG12	5:E:130:PHE:N	2.32	0.45
2:G:29:GLY:HA2	2:G:61:SER:HB2	2.00	0.45
1:A:254:GLU:HG2	1:A:275:GLU:O	2.16	0.44
1:F:116:TYR:HB3	1:F:124:ILE:O	2.17	0.44
1:A:24:ALA:O	1:A:35:ARG:HA	2.17	0.44
1:A:74:HIS:HA	1:A:77:ASP:HB2	1.99	0.44
4:I:113:ILE:HG12	4:I:140:ASP:HA	1.98	0.44
5:J:50:ASN:HB3	5:J:55:ILE:HD11	1.98	0.44
5:E:147:CYS:SG	5:E:148:LEU:N	2.91	0.44
1:F:35:ARG:CZ	1:F:48:ARG:HH12	2.30	0.44

Continued on next page...

Continued from previous page...

Atom-1	Atom-2	Interatomic distance (Å)	Clash overlap (Å)
4:I:32:TYR:O	4:I:91:MET:HA	2.18	0.44
1:A:234:ARG:HD2	2:B:10:TYR:CE1	2.53	0.44
1:A:259:CYS:HB3	1:A:272:LEU:HB2	1.98	0.44
2:G:40:LEU:HD23	2:G:45:ARG:HA	1.98	0.44
5:J:219:LEU:N	5:J:219:LEU:HD12	2.32	0.44
1:A:59:TYR:O	1:A:63:GLU:HG2	2.18	0.44
3:C:5:PRO:HG2	4:D:97:TYR:CE1	2.53	0.44
1:F:35:ARG:HD3	1:F:35:ARG:O	2.17	0.44
1:A:133:TRP:HB2	1:A:144:LYS:HG3	1.99	0.44
4:I:60:ARG:NH2	4:I:83:ASP:OD2	2.50	0.44
5:E:87:SER:HA	5:E:113:LEU:O	2.18	0.44
2:B:54:LEU:HD11	2:B:62:PHE:HB3	1.99	0.44
4:I:8:PRO:CG	4:I:9:GLY:HA2	2.48	0.44
5:J:140:THR:O	5:J:142:LYS:HG3	2.18	0.44
1:A:5:MET:SD	1:A:171:TYR:HE2	2.41	0.44
4:I:110:ARG:HA	4:I:111:PRO:HD3	1.82	0.44
5:J:31:TYR:HA	5:J:49:PHE:O	2.18	0.44
4:D:199:PHE:HD1	4:D:199:PHE:HA	1.70	0.43
4:I:10:PRO:O	4:I:11:LEU:C	2.55	0.43
4:I:124:ARG:HH22	5:J:244:ARG:CZ	2.29	0.43
1:A:81:LEU:HD12	1:A:84:TYR:HD2	1.83	0.43
5:E:15:MET:HE2	5:E:117:GLU:HA	2.00	0.43
2:G:51:HIS:HA	2:G:65:LEU:O	2.18	0.43
4:I:174:VAL:HG23	5:J:195:ARG:HH21	1.83	0.43
5:J:95:SER:HB3	5:J:100:LEU:HD13	2.00	0.43
5:J:127:VAL:HG21	5:J:237:VAL:O	2.18	0.43
1:A:89:GLU:HB3	5:J:24:LYS:HZ3	1.82	0.43
1:A:138:MET:HA	1:A:138:MET:CE	2.48	0.43
2:B:6:LYS:O	2:B:27:VAL:HA	2.19	0.43
3:C:7:PRO:CA	3:C:8:ALA:CB	2.91	0.43
4:D:145:VAL:HA	4:D:191:SER:OG	2.19	0.43
5:J:11:GLU:HG2	5:J:113:LEU:HD13	2.00	0.43
2:B:5:PRO:CA	2:B:30:PHE:HB3	2.44	0.43
1:F:191:HIS:CG	1:F:275:GLU:HG2	2.53	0.43
1:F:204:TRP:HZ2	2:G:98:ASP:O	2.02	0.43
2:G:29:GLY:HA2	2:G:61:SER:CB	2.48	0.43
4:I:63:ALA:HB1	6:I:208:HOH:O	2.18	0.43
4:D:53:SER:OG	4:D:67:LYS:HB2	2.18	0.43
1:F:227:ASP:O	1:F:247:VAL:HA	2.19	0.43
2:B:70:PHE:CZ	2:B:72:PRO:HG3	2.54	0.43
5:E:152:PHE:CE2	5:E:190:TYR:HB2	2.54	0.43

Continued on next page...

Continued from previous page...

Atom-1	Atom-2	Interatomic distance (Å)	Clash overlap (Å)
5:E:206:PRO:HA	5:E:243:GLY:C	2.38	0.43
1:F:228:THR:HA	1:F:246:ALA:O	2.18	0.43
5:J:151:GLY:HA3	5:J:189:ARG:NH1	2.33	0.43
1:A:106:ASP:OD1	1:A:108:ARG:HB2	2.19	0.43
4:D:19:VAL:CG1	4:D:76:ILE:HB	2.45	0.43
4:D:174:VAL:HG23	5:E:195:ARG:NH2	2.34	0.43
4:D:176:TRP:CZ3	5:E:148:LEU:HD11	2.54	0.43
5:J:102:LYS:HB2	5:J:104:ILE:HG12	1.99	0.43
5:J:140:THR:O	5:J:141:GLN:HG2	2.18	0.43
1:A:42:SER:OG	1:A:44:ARG:HB2	2.18	0.43
4:I:110:ARG:HD3	4:I:158:LYS:NZ	2.34	0.43
5:J:61:PRO:HG2	5:J:65:PHE:CG	2.54	0.43
1:A:142:THR:O	1:A:146:LYS:HB2	2.19	0.43
1:A:176:LYS:HG3	1:A:177:GLU:N	2.34	0.43
1:F:13:SER:HB3	1:F:78:LEU:HD22	2.01	0.43
4:I:54:GLY:H	4:I:65:VAL:HG13	1.84	0.43
4:I:119:ALA:CB	4:I:198:PHE:HB3	2.49	0.43
5:E:3:GLY:O	5:E:5:ILE:HD12	2.19	0.43
5:E:9:ARG:HH12	5:E:109:ALA:HB3	1.84	0.43
1:F:201:LEU:HB2	1:F:247:VAL:HG12	2.01	0.43
1:F:273:ARG:O	1:F:274:TRP:CB	2.67	0.43
2:G:36:GLU:O	2:G:82:VAL:HA	2.19	0.43
1:A:49:ALA:O	1:A:52:ILE:HG22	2.20	0.42
4:D:47:LEU:HD11	4:D:87:TYR:HE1	1.83	0.42
5:E:29:HIS:HD2	5:E:94:SER:C	2.22	0.42
1:F:64:THR:O	1:F:67:VAL:HG12	2.18	0.42
1:A:19:GLU:HG2	1:A:75:ARG:CZ	2.49	0.42
1:A:209:TYR:HA	1:A:210:PRO:C	2.39	0.42
5:E:22:ARG:HB3	1:F:16:GLY:O	2.19	0.42
1:F:184:ALA:HA	1:F:185:PRO:HD3	1.90	0.42
2:G:70:PHE:HD2	2:G:78:TYR:CZ	2.38	0.42
5:J:225:TRP:NE1	5:J:227:GLN:HB2	2.33	0.42
4:D:86:THR:OG1	4:D:106:ARG:HG2	2.19	0.42
1:F:201:LEU:O	1:F:246:ALA:HA	2.18	0.42
2:G:33:SER:HB3	2:G:62:PHE:CZ	2.54	0.42
4:I:35:TRP:CH2	4:I:89:CYS:HB3	2.54	0.42
1:F:109:PHE:HB2	1:F:165:VAL:HG21	2.02	0.42
2:G:70:PHE:CZ	2:G:72:PRO:HG3	2.54	0.42
5:E:157:VAL:HA	5:E:215:GLN:O	2.19	0.42
1:F:28:VAL:HG23	1:F:33:PHE:CE1	2.53	0.42
1:F:58[A]:GLU:CD	1:F:58[A]:GLU:H	2.22	0.42

Continued on next page...

Continued from previous page...

Atom-1	Atom-2	Interatomic distance (Å)	Clash overlap (Å)
1:F:78:LEU:CD2	1:F:95:VAL:HG12	2.49	0.42
2:G:41:LYS:HG2	2:G:42:ASN:ND2	2.35	0.42
4:I:164:ARG:O	4:I:166:MET:N	2.53	0.42
5:J:15:MET:CE	5:J:117:GLU:HA	2.50	0.42
5:J:108:GLY:C	5:J:110:GLY:H	2.23	0.42
4:D:98:LYS:HG3	5:E:45:LEU:HD23	2.00	0.42
5:E:96:LEU:O	5:E:100:LEU:HB2	2.20	0.42
5:E:112:ARG:HB3	5:E:156:HIS:CE1	2.55	0.42
4:I:35:TRP:CZ3	4:I:89:CYS:HB3	2.55	0.42
1:A:159:TYR:CD1	1:A:163:THR:HB	2.55	0.42
4:D:10:PRO:HB3	4:D:106:ARG:HH12	1.82	0.42
4:I:46:LEU:CD2	5:J:104:ILE:HD13	2.43	0.42
4:I:49:TYR:O	4:I:49:TYR:CG	2.73	0.42
1:A:167:TRP:O	1:A:170:ARG:HB3	2.20	0.42
2:B:4:THR:HA	2:B:86:THR:OG1	2.20	0.42
5:E:182:GLN:HB3	5:E:185:LEU:HD12	2.01	0.42
1:F:77:ASP:O	1:F:81:LEU:HD13	2.20	0.42
1:F:219:ARG:O	1:F:220:ASP:HB2	2.20	0.42
5:J:48:TYR:CE1	5:J:55:ILE:HB	2.55	0.42
5:E:178:PRO:HB2	5:E:190:TYR:HB3	2.02	0.42
1:F:34:VAL:HA	1:F:46:GLU:O	2.20	0.42
1:F:99:TYR:HA	1:F:113:TYR:O	2.20	0.42
4:I:33:PHE:CD1	4:I:72:ILE:CD1	3.02	0.42
5:J:61:PRO:HG2	5:J:65:PHE:CD1	2.54	0.42
5:J:235:GLN:HE21	5:J:237:VAL:HG22	1.84	0.42
1:A:52:ILE:HD12	1:A:52:ILE:HA	1.92	0.42
5:J:91:PHE:HB3	5:J:107:PHE:HD1	1.85	0.42
5:E:24:LYS:HE3	1:F:89:GLU:HB3	2.02	0.41
1:F:59:TYR:O	1:F:63:GLU:HG2	2.20	0.41
1:F:156:LEU:HD23	1:F:156:LEU:HA	1.89	0.41
3:H:4:GLY:C	4:I:94:ASP:O	2.58	0.41
5:J:146:VAL:HG22	5:J:195:ARG:HG2	2.01	0.41
5:J:183:PRO:C	5:J:185:LEU:H	2.22	0.41
4:D:10:PRO:HA	4:D:106:ARG:HB2	2.01	0.41
4:D:84:SER:O	4:D:85:ALA:HB2	2.21	0.41
5:E:144:THR:HA	5:E:196:LEU:O	2.20	0.41
2:B:51:HIS:HA	2:B:65:LEU:O	2.20	0.41
4:D:61:PHE:HA	4:D:75:PHE:O	2.19	0.41
1:F:97:ARG:HA	1:F:115:GLN:O	2.20	0.41
2:G:23:LEU:HD22	2:G:78:TYR:CD1	2.56	0.41
5:E:29:HIS:HA	5:E:96:LEU:HD21	2.02	0.41

Continued on next page...

Continued from previous page...

Atom-1	Atom-2	Interatomic distance (Å)	Clash overlap (Å)
1:F:138:MET:HA	1:F:138:MET:HE3	2.01	0.41
1:F:163:THR:O	1:F:167:TRP:HD1	2.03	0.41
4:I:35:TRP:CD2	4:I:74:LEU:HB2	2.55	0.41
5:J:68:LYS:HB2	5:J:68:LYS:HE2	1.79	0.41
5:J:132:PRO:HG2	5:J:143:ALA:HB1	2.02	0.41
1:A:153:ALA:O	1:A:157:ARG:HB2	2.21	0.41
2:B:40:LEU:HD23	2:B:45:ARG:HA	2.01	0.41
5:E:36:ARG:HG2	5:E:46:LEU:HD21	2.02	0.41
5:E:159:LEU:C	5:E:159:LEU:HD23	2.41	0.41
2:G:6:LYS:O	2:G:27:VAL:HA	2.20	0.41
5:J:161:TRP:CD1	5:J:172:VAL:HG13	2.55	0.41
1:A:236:ALA:HB2	6:A:279:HOH:O	2.20	0.41
5:E:179:LEU:HD23	5:E:191:ALA:O	2.21	0.41
5:E:209:HIS:HE1	5:E:240:GLU:HB2	1.85	0.41
1:F:43:GLN:O	1:F:68:LYS:HE2	2.20	0.41
2:G:54:LEU:HD11	2:G:62:PHE:CD1	2.56	0.41
4:I:38:GLN:NE2	5:J:37:GLN:OE1	2.53	0.41
5:J:61:PRO:O	5:J:62:GLU:CB	2.67	0.41
5:J:66:SER:O	5:J:77:LEU:HD12	2.20	0.41
5:J:96:LEU:HD13	5:J:98:GLU:OE1	2.20	0.41
1:A:178:THR:O	1:A:181:ARG:HG2	2.21	0.41
1:A:209:TYR:CG	1:A:210:PRO:HA	2.55	0.41
2:B:32:PRO:HD2	2:B:85:VAL:HG11	2.03	0.41
3:C:7:PRO:HB3	3:C:8:ALA:O	2.19	0.41
4:D:28:SER:O	4:D:29:ALA:CB	2.69	0.41
1:F:44:ARG:HD2	1:F:64:THR:HG21	2.01	0.41
1:F:98:MET:O	1:F:114:HIS:HA	2.21	0.41
4:I:120:VAL:HG12	4:I:184:CYS:HB3	2.03	0.41
4:D:25:TYR:CZ	4:D:70:LYS:HG3	2.56	0.41
5:E:137:ILE:HD13	5:E:203:TRP:CD1	2.56	0.41
1:F:191:HIS:ND1	1:F:275:GLU:HG2	2.36	0.41
1:F:197:HIS:ND1	1:F:198:GLU:HG3	2.35	0.41
1:A:81:LEU:HD12	1:A:84:TYR:CD2	2.56	0.41
2:B:28:SER:HA	2:B:63:TYR:HA	2.03	0.41
2:B:54:LEU:HD11	2:B:62:PHE:CD1	2.56	0.41
4:D:85:ALA:O	4:D:107:LEU:N	2.54	0.41
4:D:88:LEU:HD23	4:D:104:GLY:CA	2.51	0.41
4:D:137:THR:HA	4:D:171:ASN:O	2.21	0.41
1:F:28:VAL:O	1:F:29:ASP:HB2	2.21	0.41
1:F:31:THR:HG22	1:F:209:TYR:OH	2.21	0.41
1:F:65[B]:ARG:HH11	5:J:56:ASP:HA	1.85	0.41

Continued on next page...

Continued from previous page...

Atom-1	Atom-2	Interatomic distance (Å)	Clash overlap (Å)
1:F:177:GLU:CD	1:F:177:GLU:H	2.25	0.41
2:G:25:CYS:HB2	2:G:39:LEU:CD2	2.51	0.41
2:G:96:ASP:HB3	2:G:99:MET:HA	2.03	0.41
4:I:14:PRO:HG3	4:I:110:ARG:HH12	1.85	0.41
4:I:163:MET:HG2	5:J:171:GLY:HA2	2.02	0.41
5:J:60:MET:HE3	5:J:60:MET:HA	2.03	0.41
5:J:182:GLN:HA	5:J:183:PRO:HD2	1.94	0.41
5:E:137:ILE:O	5:E:141:GLN:HA	2.20	0.41
4:D:113:ILE:N	4:D:113:ILE:CD1	2.84	0.40
5:E:19:VAL:HG13	5:E:82:SER:HB3	2.03	0.40
1:F:36:PHE:HB3	1:F:67:VAL:HG21	2.03	0.40
1:F:117:ALA:HB2	2:G:60:TRP:CD2	2.55	0.40
4:I:4:VAL:HG21	4:I:89:CYS:SG	2.61	0.40
5:J:60:MET:HA	5:J:61:PRO:HD3	1.87	0.40
1:F:82[B]:ARG:CD	1:F:89:GLU:HG2	2.52	0.40
2:G:2:GLN:HB3	2:G:86:THR:CG2	2.50	0.40
5:J:125:PRO:HA	5:J:152:PHE:HB3	2.03	0.40
5:J:125:PRO:CD	5:J:216:PHE:HB2	2.51	0.40
1:A:216:THR:HB	1:A:260:HIS:HB2	2.03	0.40
4:D:44:PRO:HD2	5:E:107:PHE:CG	2.56	0.40
5:E:148:LEU:O	5:E:150:THR:HG23	2.22	0.40
5:E:159:LEU:HD23	5:E:160:SER:N	2.35	0.40
5:E:166:LYS:HB3	5:E:166:LYS:HE3	1.88	0.40
2:G:5:PRO:HB3	2:G:30:PHE:HB3	2.04	0.40
1:A:185:PRO:HA	1:A:208:PHE:HB3	2.01	0.40
1:F:162:GLY:O	1:F:166:GLU:HG3	2.22	0.40
1:F:236:ALA:HB1	2:G:12:ARG:HG3	2.02	0.40
2:G:17:ASN:HA	2:G:72:PRO:O	2.21	0.40
4:I:60:ARG:HA	4:I:77:ARG:HH12	1.86	0.40
5:J:155:ASP:HB2	5:J:178:PRO:CG	2.43	0.40
1:A:28:VAL:HG11	1:A:179:LEU:HD13	2.04	0.40
1:A:218:GLN:HG2	1:A:223:ASP:HA	2.03	0.40
4:D:198:PHE:CG	4:D:199:PHE:N	2.90	0.40
5:E:100:LEU:HD12	5:E:100:LEU:HA	1.84	0.40
5:E:219:LEU:N	5:E:219:LEU:HD12	2.36	0.40
4:I:152:ASP:HB3	4:I:179:LYS:HD2	2.03	0.40
5:J:38:THR:HG22	6:J:257:HOH:O	2.22	0.40
5:J:68:LYS:HD3	5:J:68:LYS:N	2.37	0.40

There are no symmetry-related clashes.

5.3 Torsion angles [i](#)

5.3.1 Protein backbone [i](#)

In the following table, the Percentiles column shows the percent Ramachandran outliers of the chain as a percentile score with respect to all X-ray entries followed by that with respect to entries of similar resolution.

The Analysed column shows the number of residues for which the backbone conformation was analysed, and the total number of residues.

Mol	Chain	Analysed	Favoured	Allowed	Outliers	Percentiles	
1	A	274/275 (100%)	251 (92%)	21 (8%)	2 (1%)	22	43
1	F	276/275 (100%)	259 (94%)	13 (5%)	4 (1%)	11	22
2	B	98/100 (98%)	90 (92%)	8 (8%)	0	100	100
2	G	98/100 (98%)	91 (93%)	6 (6%)	1 (1%)	15	32
3	C	8/10 (80%)	6 (75%)	1 (12%)	1 (12%)	0	0
3	H	8/10 (80%)	6 (75%)	1 (12%)	1 (12%)	0	0
4	D	197/199 (99%)	160 (81%)	26 (13%)	11 (6%)	2	2
4	I	197/199 (99%)	165 (84%)	27 (14%)	5 (2%)	5	9
5	E	242/245 (99%)	217 (90%)	22 (9%)	3 (1%)	13	27
5	J	243/245 (99%)	220 (90%)	20 (8%)	3 (1%)	13	27
All	All	1641/1658 (99%)	1465 (89%)	145 (9%)	31 (2%)	8	15

All (31) Ramachandran outliers are listed below:

Mol	Chain	Res	Type
4	D	11	LEU
4	D	82	SER
5	E	81	PRO
5	J	81	PRO
1	A	18	GLY
1	A	274	TRP
4	D	27	ASN
4	D	28	SER
4	D	165	SER
4	D	167	ASP
5	E	222	ASN
1	F	274	TRP
3	H	8	ALA
4	I	11	LEU

Continued on next page...

Continued from previous page...

Mol	Chain	Res	Type
4	I	28	SER
4	I	167	ASP
4	D	9	GLY
4	D	147	GLN
4	I	165	SER
4	D	94	ASP
5	E	148	LEU
1	F	18	GLY
4	I	95	SER
5	J	18	GLN
5	J	141	GLN
4	D	83	ASP
1	F	136	ALA
2	G	17	ASN
3	C	6	ASP
1	F	252	GLY
4	D	192	ILE

5.3.2 Protein sidechains [i](#)

In the following table, the Percentiles column shows the percent sidechain outliers of the chain as a percentile score with respect to all X-ray entries followed by that with respect to entries of similar resolution.

The Analysed column shows the number of residues for which the sidechain conformation was analysed, and the total number of residues.

Mol	Chain	Analysed	Rotameric	Outliers	Percentiles	
1	A	232/231 (100%)	224 (97%)	8 (3%)	37	63
1	F	234/231 (101%)	225 (96%)	9 (4%)	33	59
2	B	95/95 (100%)	93 (98%)	2 (2%)	53	77
2	G	95/95 (100%)	92 (97%)	3 (3%)	39	65
3	C	5/5 (100%)	4 (80%)	1 (20%)	1	2
3	H	5/5 (100%)	5 (100%)	0	100	100
4	D	180/180 (100%)	172 (96%)	8 (4%)	28	53
4	I	180/180 (100%)	173 (96%)	7 (4%)	32	58
5	E	215/215 (100%)	205 (95%)	10 (5%)	26	50
5	J	215/215 (100%)	206 (96%)	9 (4%)	30	55
All	All	1456/1452 (100%)	1399 (96%)	57 (4%)	32	58

All (57) residues with a non-rotameric sidechain are listed below:

Mol	Chain	Res	Type
1	A	31	THR
1	A	35	ARG
1	A	58	GLU
1	A	81	LEU
1	A	164	CYS
1	A	197	HIS
1	A	268	LYS
1	A	274	TRP
2	B	57	SER
2	B	70	PHE
3	C	2	LEU
4	D	4	VAL
4	D	11	LEU
4	D	19	VAL
4	D	34	MET
4	D	56	LYS
4	D	113	ILE
4	D	164	ARG
4	D	199	PHE
5	E	29	HIS
5	E	36	ARG
5	E	60	MET
5	E	76	THR
5	E	100	LEU
5	E	126	GLU
5	E	139	HIS
5	E	187	ASP
5	E	195	ARG
5	E	201	THR
1	F	19	GLU
1	F	35	ARG
1	F	45	MET
1	F	95	VAL
1	F	110	LEU
1	F	113	TYR
1	F	138	MET
1	F	272	LEU
1	F	275	GLU
2	G	6	LYS
2	G	58	LYS
2	G	70	PHE
4	I	22	ASN

Continued on next page...

Continued from previous page...

Mol	Chain	Res	Type
4	I	24	THR
4	I	34	MET
4	I	41	ARG
4	I	160	VAL
4	I	161	LEU
4	I	164	ARG
5	J	29	HIS
5	J	36	ARG
5	J	53	VAL
5	J	60	MET
5	J	68	LYS
5	J	80	GLN
5	J	100	LEU
5	J	126	GLU
5	J	156	HIS

Sometimes sidechains can be flipped to improve hydrogen bonding and reduce clashes. All (23) such sidechains are listed below:

Mol	Chain	Res	Type
1	A	32	GLN
1	A	145	HIS
1	A	155	GLN
1	A	260	HIS
4	D	122	GLN
4	D	190	ASN
5	E	10	HIS
5	E	29	HIS
5	E	105	GLN
5	E	156	HIS
5	E	209	HIS
5	E	215	GLN
5	E	227	GLN
1	F	93	HIS
1	F	155	GLN
1	F	260	HIS
4	I	122	GLN
4	I	142	GLN
5	J	29	HIS
5	J	156	HIS
5	J	209	HIS
5	J	222	ASN
5	J	235	GLN

5.3.3 RNA [i](#)

There are no RNA molecules in this entry.

5.4 Non-standard residues in protein, DNA, RNA chains [i](#)

There are no non-standard protein/DNA/RNA residues in this entry.

5.5 Carbohydrates [i](#)

There are no monosaccharides in this entry.

5.6 Ligand geometry [i](#)

There are no ligands in this entry.

5.7 Other polymers [i](#)

There are no such residues in this entry.

5.8 Polymer linkage issues [i](#)

There are no chain breaks in this entry.

6 Fit of model and data [i](#)

6.1 Protein, DNA and RNA chains [i](#)

In the following table, the column labelled ‘#RSRZ> 2’ contains the number (and percentage) of RSRZ outliers, followed by percent RSRZ outliers for the chain as percentile scores relative to all X-ray entries and entries of similar resolution. The OWAB column contains the minimum, median, 95th percentile and maximum values of the occupancy-weighted average B-factor per residue. The column labelled ‘Q< 0.9’ lists the number of (and percentage) of residues with an average occupancy less than 0.9.

Mol	Chain	Analysed	<RSRZ>	#RSRZ>2	OWAB(Å ²)	Q<0.9
1	A	275/275 (100%)	0.17	11 (4%) 38 31	18, 52, 97, 132	0
1	F	275/275 (100%)	-0.18	1 (0%) 92 91	18, 46, 82, 98	0
2	B	100/100 (100%)	0.07	5 (5%) 28 23	24, 51, 86, 102	0
2	G	100/100 (100%)	-0.21	1 (1%) 82 80	19, 41, 76, 87	0
3	C	10/10 (100%)	1.22	3 (30%) 0 0	26, 42, 59, 60	0
3	H	10/10 (100%)	0.25	0 100 100	25, 38, 40, 43	0
4	D	199/199 (100%)	0.70	30 (15%) 2 1	26, 75, 140, 184	0
4	I	199/199 (100%)	0.86	37 (18%) 1 0	25, 77, 144, 183	0
5	E	244/245 (99%)	-0.01	6 (2%) 57 51	21, 56, 111, 146	0
5	J	245/245 (100%)	0.22	16 (6%) 18 14	24, 58, 112, 148	0
All	All	1657/1658 (99%)	0.22	110 (6%) 18 13	18, 55, 120, 184	0

All (110) RSRZ outliers are listed below:

Mol	Chain	Res	Type	RSRZ
4	D	130	ASP	8.7
1	A	1	GLY	8.4
4	I	166	MET	6.5
4	I	130	ASP	6.0
4	D	51	TYR	6.0
4	D	26	SER	5.3
4	I	128	SER	5.2
4	I	201	SER	5.1
5	E	184	ALA	5.1
4	D	131	LYS	5.0
5	E	138	SER	4.9
4	D	201	SER	4.7
4	I	180	SER	4.6

Continued on next page...

Continued from previous page...

Mol	Chain	Res	Type	RSRZ
4	I	169	LYS	4.6
4	I	129	SER	4.4
5	J	246	ASP	4.3
5	J	185	LEU	4.0
4	I	127	LYS	4.0
4	D	125	ASP	3.9
5	J	245	ALA	3.9
4	D	126	SER	3.7
4	I	123	LEU	3.7
4	D	166	MET	3.7
4	D	129	SER	3.7
5	J	40	MET	3.6
4	I	51	TYR	3.6
5	E	186	ASN	3.5
4	D	149	LYS	3.5
4	I	181	ASP	3.5
1	A	104	GLY	3.5
4	I	195	GLU	3.4
5	J	182	GLN	3.3
4	D	81	PRO	3.2
4	I	200	PRO	3.2
4	I	171	ASN	3.2
4	D	20	SER	3.2
1	A	197	HIS	3.2
5	J	39	MET	3.2
5	J	134	GLU	3.1
1	F	1	GLY	3.1
4	D	127	LYS	3.1
5	J	186	ASN	3.1
2	B	75	LYS	3.0
4	I	165	SER	3.0
1	A	105	SER	3.0
4	I	182	PHE	2.9
4	D	185	ALA	2.9
5	E	39	MET	2.9
1	A	226	GLN	2.9
4	I	114	GLN	2.9
4	I	149	LYS	2.9
4	I	55	ASN	2.9
5	J	201	THR	2.9
5	J	207	ARG	2.9
2	B	85	VAL	2.8

Continued on next page...

Continued from previous page...

Mol	Chain	Res	Type	RSRZ
4	D	180	SER	2.8
4	I	192	ILE	2.8
4	I	190	ASN	2.8
5	E	40	MET	2.8
5	E	134	GLU	2.8
4	I	179	LYS	2.8
3	C	4	GLY	2.8
3	C	7	PRO	2.7
4	I	126	SER	2.7
4	I	131	LYS	2.7
4	I	26	SER	2.7
4	D	200	PRO	2.7
1	A	110	LEU	2.7
1	A	224	GLN	2.6
5	J	137	ILE	2.6
4	I	189	ASN	2.6
4	D	164	ARG	2.6
4	D	189	ASN	2.5
4	D	114	GLN	2.5
2	B	88	SER	2.5
5	J	184	ALA	2.5
4	D	195	GLU	2.5
2	B	19	LYS	2.5
3	C	8	ALA	2.4
4	D	150	ASP	2.4
4	D	179	LYS	2.4
4	D	19	VAL	2.4
1	A	111	ARG	2.4
4	D	128	SER	2.4
4	I	196	ASP	2.4
4	I	57	GLU	2.4
5	J	144	THR	2.4
5	J	226	THR	2.4
5	J	141	GLN	2.4
2	B	42	ASN	2.3
4	I	113	ILE	2.3
4	I	178	ASN	2.3
4	D	122	GLN	2.3
4	I	137	THR	2.3
4	D	123	LEU	2.3
4	D	124	ARG	2.3
4	I	164	ARG	2.2

Continued on next page...

Continued from previous page...

Mol	Chain	Res	Type	RSRZ
4	D	181	ASP	2.2
5	J	81	PRO	2.2
2	G	48	LYS	2.2
4	I	170	SER	2.2
4	I	124	ARG	2.2
1	A	19	GLU	2.1
4	I	20	SER	2.1
4	D	182	PHE	2.1
4	I	185	ALA	2.1
1	A	225	THR	2.1
4	I	167	ASP	2.1
1	A	108	ARG	2.0
4	D	198	PHE	2.0

6.2 Non-standard residues in protein, DNA, RNA chains [i](#)

There are no non-standard protein/DNA/RNA residues in this entry.

6.3 Carbohydrates [i](#)

There are no monosaccharides in this entry.

6.4 Ligands [i](#)

There are no ligands in this entry.

6.5 Other polymers [i](#)

There are no such residues in this entry.