



Full wwPDB X-ray Structure Validation Report ⓘ

May 13, 2020 – 02:09 am BST

PDB ID : 5VAE
Title : Crystal structure of accessory secretion protein 1 and 3
Authors : Chen, Y.; Rapoport, T.A.; Jeffrey, P.D.
Deposited on : 2017-03-25
Resolution : 3.11 Å(reported)

This is a Full wwPDB X-ray Structure Validation Report for a publicly released PDB entry.

We welcome your comments at validation@mail.wwpdb.org

A user guide is available at

<https://www.wwpdb.org/validation/2017/XrayValidationReportHelp>

with specific help available everywhere you see the ⓘ symbol.

The following versions of software and data (see [references ⓘ](#)) were used in the production of this report:

MolProbity : 4.02b-467
Mogul : 1.8.5 (274361), CSD as541be (2020)
Xtriage (Phenix) : 1.13
EDS : 2.11
Percentile statistics : 20191225.v01 (using entries in the PDB archive December 25th 2019)
Refmac : 5.8.0158
CCP4 : 7.0.044 (Gargrove)
Ideal geometry (proteins) : Engh & Huber (2001)
Ideal geometry (DNA, RNA) : Parkinson et al. (1996)
Validation Pipeline (wwPDB-VP) : 2.11

1 Overall quality at a glance

The following experimental techniques were used to determine the structure:

X-RAY DIFFRACTION

The reported resolution of this entry is 3.11 Å.

Percentile scores (ranging between 0-100) for global validation metrics of the entry are shown in the following graphic. The table shows the number of entries on which the scores are based.

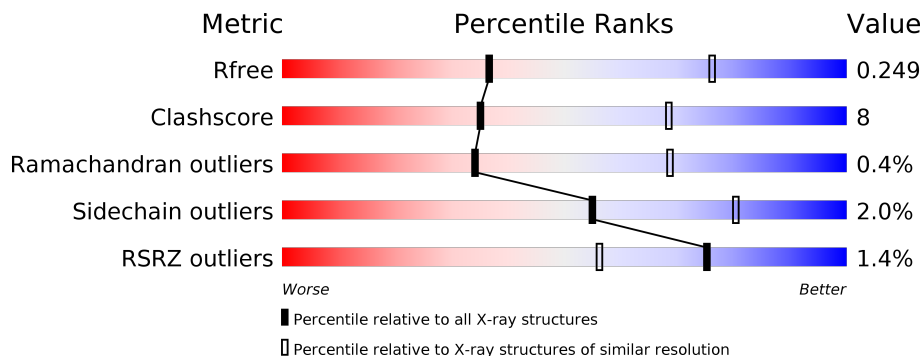



Metric	Whole archive (#Entries)	Similar resolution (#Entries, resolution range(Å))
R_{free}	130704	1094 (3.10-3.10)
Clashscore	141614	1184 (3.10-3.10)
Ramachandran outliers	138981	1141 (3.10-3.10)
Sidechain outliers	138945	1141 (3.10-3.10)
RSRZ outliers	127900	1067 (3.10-3.10)

The table below summarises the geometric issues observed across the polymeric chains and their fit to the electron density. The red, orange, yellow and green segments on the lower bar indicate the fraction of residues that contain outliers for ≥ 3 , 2, 1 and 0 types of geometric quality criteria respectively. A grey segment represents the fraction of residues that are not modelled. The numeric value for each fraction is indicated below the corresponding segment, with a dot representing fractions $\leq 5\%$. The upper red bar (where present) indicates the fraction of residues that have poor fit to the electron density. The numeric value is given above the bar.

Mol	Chain	Length	Quality of chain
1	A	533	 77% 19%
1	C	533	 76% 19%
1	E	533	 75% 20%
1	G	533	 72% 23%
2	B	159	 65% 18% 16%
2	D	159	 65% 19% 16%

Continued on next page...

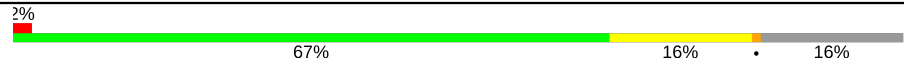
Continued from previous page...

Mol	Chain	Length	Quality of chain
2	F	159	
2	H	159	

2 Entry composition i

There are 3 unique types of molecules in this entry. The entry contains 21840 atoms, of which 0 are hydrogens and 0 are deuteriums.

In the tables below, the ZeroOcc column contains the number of atoms modelled with zero occupancy, the AltConf column contains the number of residues with at least one atom in alternate conformation and the Trace column contains the number of residues modelled with at most 2 atoms.

- Molecule 1 is a protein called Accessory Sec system protein Asp1.

Mol	Chain	Residues	Atoms						ZeroOcc	AltConf	Trace
			Total	C	N	O	S	Se			
1	A	517	4350	2813	716	812	3	6	0	0	0
1	C	513	4317	2792	710	806	3	6	0	0	0
1	E	510	4294	2780	707	798	3	6	0	0	0
1	G	510	4291	2778	706	798	3	6	0	0	0

There are 28 discrepancies between the modelled and reference sequences:

Chain	Residue	Modelled	Actual	Comment	Reference
A	527	VAL	-	expression tag	UNP Q9AET9
A	528	ASP	-	expression tag	UNP Q9AET9
A	529	LYS	-	expression tag	UNP Q9AET9
A	530	LEU	-	expression tag	UNP Q9AET9
A	531	VAL	-	expression tag	UNP Q9AET9
A	532	PRO	-	expression tag	UNP Q9AET9
A	533	ARG	-	expression tag	UNP Q9AET9
C	527	VAL	-	expression tag	UNP Q9AET9
C	528	ASP	-	expression tag	UNP Q9AET9
C	529	LYS	-	expression tag	UNP Q9AET9
C	530	LEU	-	expression tag	UNP Q9AET9
C	531	VAL	-	expression tag	UNP Q9AET9
C	532	PRO	-	expression tag	UNP Q9AET9
C	533	ARG	-	expression tag	UNP Q9AET9
E	527	VAL	-	expression tag	UNP Q9AET9
E	528	ASP	-	expression tag	UNP Q9AET9
E	529	LYS	-	expression tag	UNP Q9AET9
E	530	LEU	-	expression tag	UNP Q9AET9
E	531	VAL	-	expression tag	UNP Q9AET9
E	532	PRO	-	expression tag	UNP Q9AET9
E	533	ARG	-	expression tag	UNP Q9AET9

Continued on next page...

Continued from previous page...

Chain	Residue	Modelled	Actual	Comment	Reference
G	527	VAL	-	expression tag	UNP Q9AET9
G	528	ASP	-	expression tag	UNP Q9AET9
G	529	LYS	-	expression tag	UNP Q9AET9
G	530	LEU	-	expression tag	UNP Q9AET9
G	531	VAL	-	expression tag	UNP Q9AET9
G	532	PRO	-	expression tag	UNP Q9AET9
G	533	ARG	-	expression tag	UNP Q9AET9

- Molecule 2 is a protein called Accessory Sec system protein Asp3.

Mol	Chain	Residues	Atoms						ZeroOcc	AltConf	Trace
			Total	C	N	O	S	Se			
2	B	134	1126	724	188	210	1	3	0	0	0
2	D	134	1126	724	188	210	1	3	0	0	0
2	F	134	1126	724	188	210	1	3	0	0	0
2	H	134	1126	724	188	210	1	3	0	0	0

- Molecule 3 is water.

Mol	Chain	Residues	Atoms		ZeroOcc	AltConf
3	A	26	Total 26	O 26	0	0
3	B	2	Total 2	O 2	0	0
3	C	19	Total 19	O 19	0	0
3	D	3	Total 3	O 3	0	0
3	E	17	Total 17	O 17	0	0
3	F	1	Total 1	O 1	0	0
3	G	14	Total 14	O 14	0	0
3	H	2	Total 2	O 2	0	0

3 Residue-property plots [i](#)

These plots are drawn for all protein, RNA and DNA chains in the entry. The first graphic for a chain summarises the proportions of the various outlier classes displayed in the second graphic. The second graphic shows the sequence view annotated by issues in geometry and electron density. Residues are color-coded according to the number of geometric quality criteria for which they contain at least one outlier: green = 0, yellow = 1, orange = 2 and red = 3 or more. A red dot above a residue indicates a poor fit to the electron density ($RSRZ > 2$). Stretches of 2 or more consecutive residues without any outlier are shown as a green connector. Residues present in the sample, but not in the model, are shown in grey.

- Molecule 1: Accessory Sec system protein Asp1

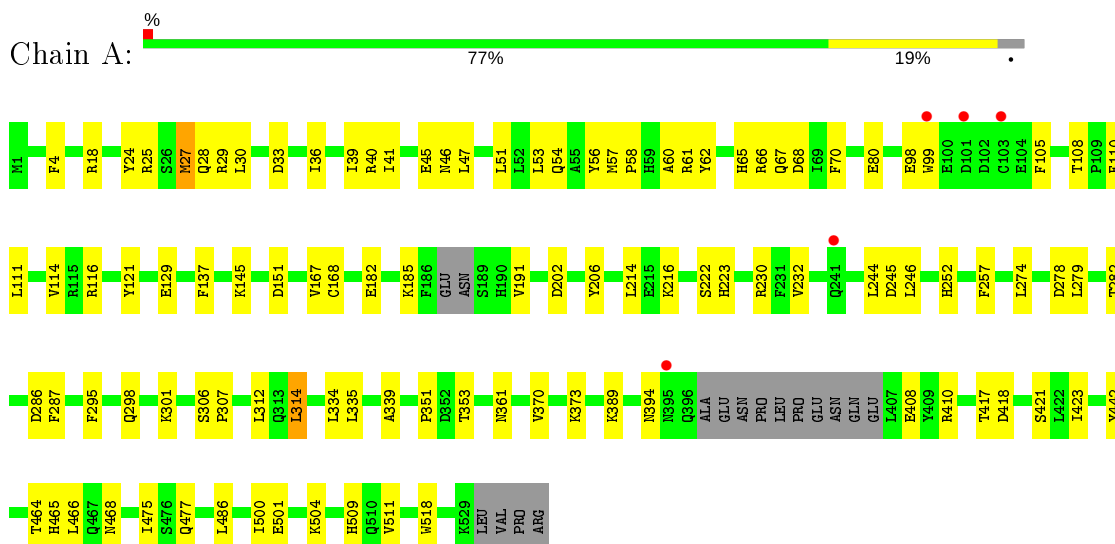

- Molecule 1: Accessory Sec system protein Asp1

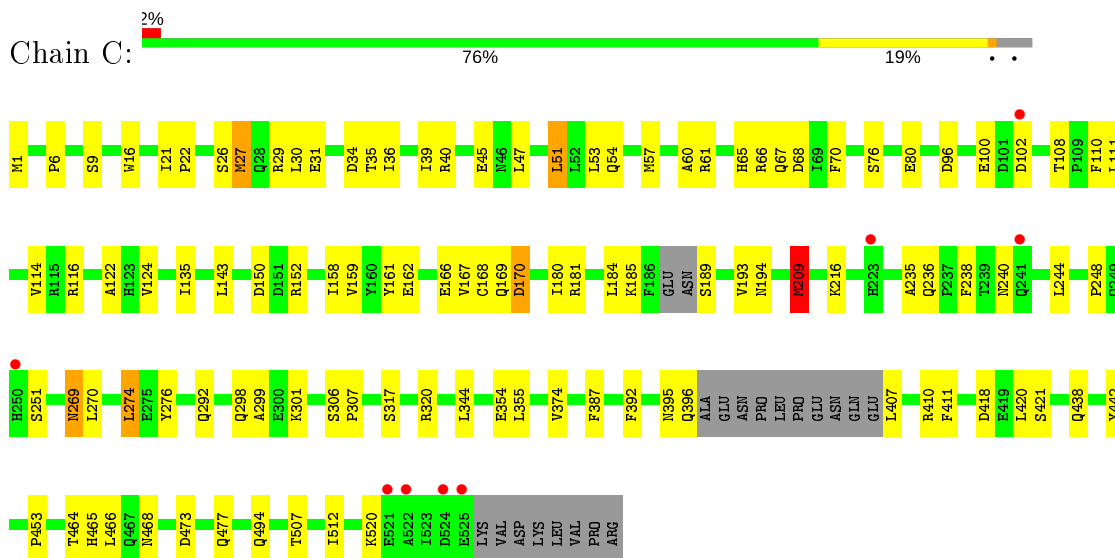

- Molecule 1: Accessory Sec system protein Asp1

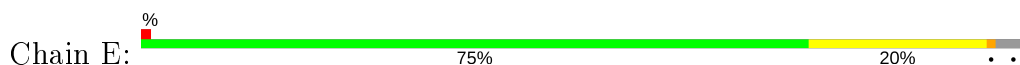

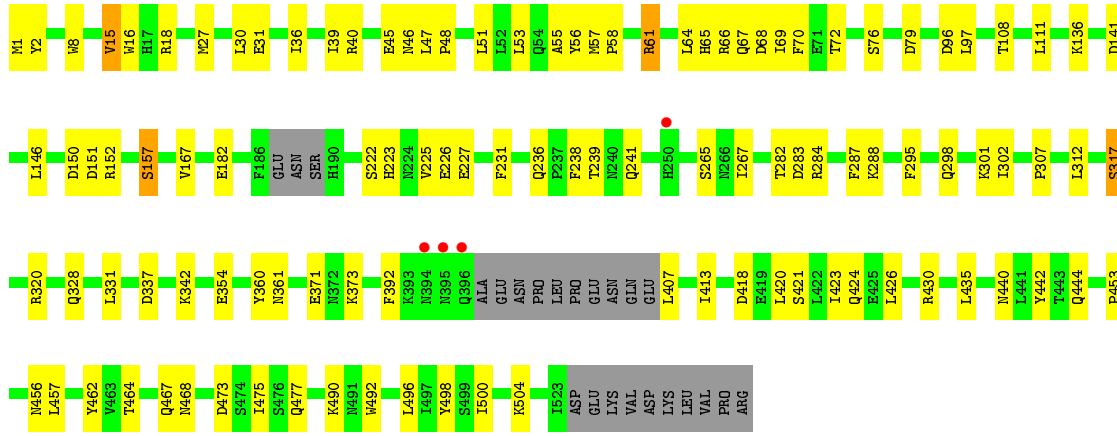

• Molecule 1: Accessory Sec system protein Asp1

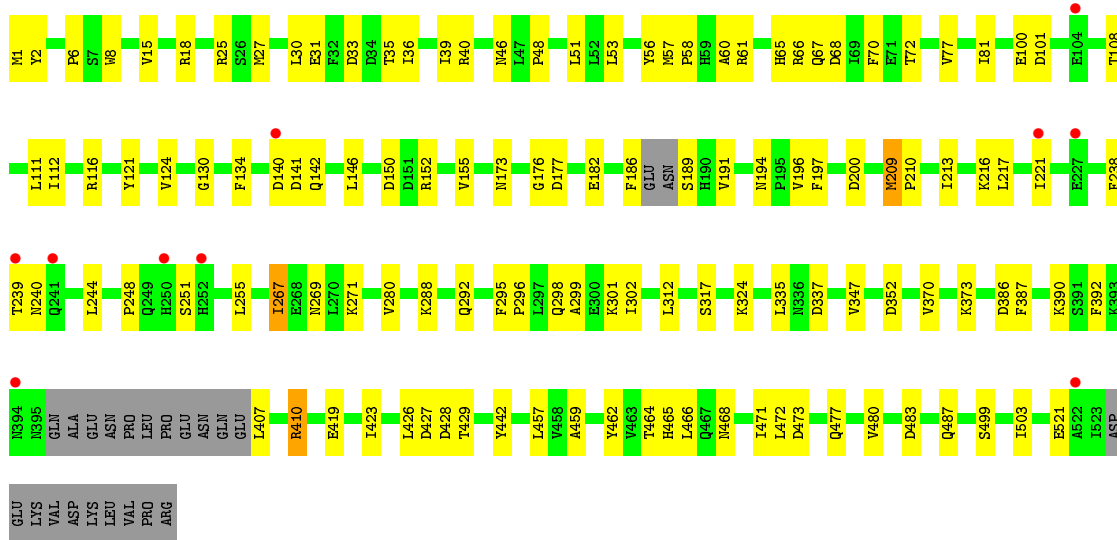
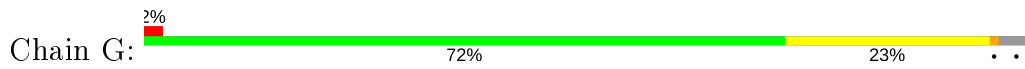

• Molecule 2: Accessory Sec system protein Asp3

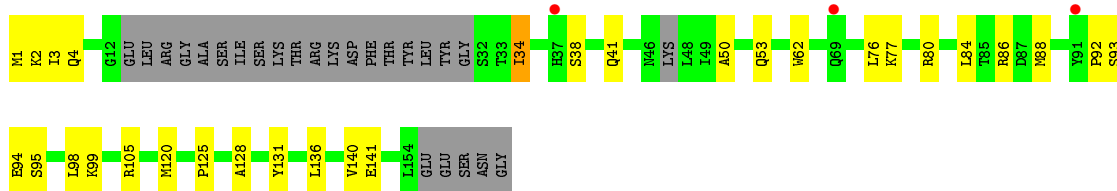

• Molecule 2: Accessory Sec system protein Asp3



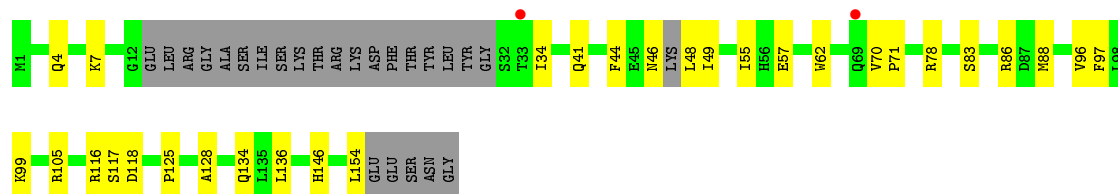

- Molecule 2: Accessory Sec system protein Asp3

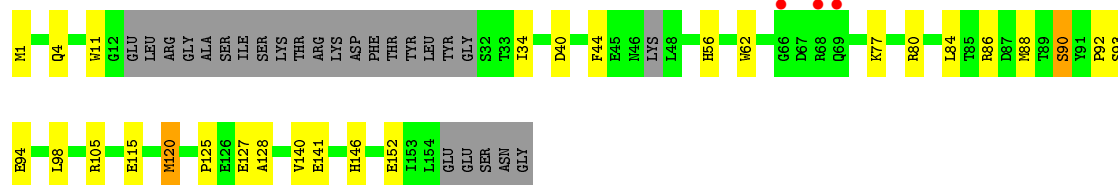

- Molecule 2: Accessory Sec system protein Asp3

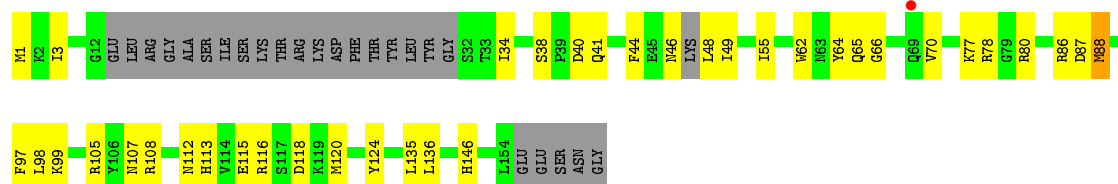

4 Data and refinement statistics i

Property	Value	Source
Space group	C 2 2 21	Depositor
Cell constants a, b, c, α , β , γ	152.60Å 257.29Å 217.72Å 90.00° 90.00° 90.00°	Depositor
Resolution (Å)	49.90 – 3.11 49.90 – 3.11	Depositor EDS
% Data completeness (in resolution range)	99.5 (49.90-3.11) 99.5 (49.90-3.11)	Depositor EDS
R_{merge}	0.14	Depositor
R_{sym}	(Not available)	Depositor
$\langle I/\sigma(I) \rangle$ ¹	3.81 (at 3.12Å)	Xtriage
Refinement program	PHENIX 1.8.2_1309	Depositor
R, R_{free}	0.207 , 0.248 0.208 , 0.249	Depositor DCC
R_{free} test set	3863 reflections (5.02%)	wwPDB-VP
Wilson B-factor (Å ²)	31.0	Xtriage
Anisotropy	0.000	Xtriage
Bulk solvent k_{sol} (e/Å ³), B_{sol} (Å ²)	0.29 , 27.1	EDS
L-test for twinning ²	$\langle L \rangle = 0.49$, $\langle L^2 \rangle = 0.32$	Xtriage
Estimated twinning fraction	0.013 for 1/2*h-1/2*k,-3/2*h-1/2*k,-l 0.018 for 1/2*h+1/2*k,3/2*h-1/2*k,-l	Xtriage
F_o, F_c correlation	0.88	EDS
Total number of atoms	21840	wwPDB-VP
Average B, all atoms (Å ²)	29.0	wwPDB-VP

Xtriage's analysis on translational NCS is as follows: *The largest off-origin peak in the Patterson function is 2.23% of the height of the origin peak. No significant pseudotranslation is detected.*

¹Intensities estimated from amplitudes.

²Theoretical values of $\langle |L| \rangle$, $\langle L^2 \rangle$ for acentric reflections are 0.5, 0.333 respectively for untwinned datasets, and 0.375, 0.2 for perfectly twinned datasets.

5 Model quality [i](#)

5.1 Standard geometry [i](#)

The Z score for a bond length (or angle) is the number of standard deviations the observed value is removed from the expected value. A bond length (or angle) with $|Z| > 5$ is considered an outlier worth inspection. RMSZ is the root-mean-square of all Z scores of the bond lengths (or angles).

Mol	Chain	Bond lengths		Bond angles	
		RMSZ	# Z >5	RMSZ	# Z >5
1	A	0.50	0/4453	0.62	0/6022
1	C	0.54	0/4420	0.66	2/5979 (0.0%)
1	E	0.53	0/4397	0.64	0/5948
1	G	0.47	0/4394	0.60	0/5944
2	B	0.47	0/1154	0.60	0/1553
2	D	0.53	0/1154	0.62	0/1553
2	F	0.49	0/1154	0.59	0/1553
2	H	0.49	0/1154	0.61	0/1553
All	All	0.51	0/22280	0.63	2/30105 (0.0%)

There are no bond length outliers.

All (2) bond angle outliers are listed below:

Mol	Chain	Res	Type	Atoms	Z	Observed(°)	Ideal(°)
1	C	51	LEU	CA-CB-CG	6.52	130.31	115.30
1	C	209	MSE	CG-SE-CE	-5.69	86.39	98.90

There are no chirality outliers.

There are no planarity outliers.

5.2 Too-close contacts [i](#)

In the following table, the Non-H and H(model) columns list the number of non-hydrogen atoms and hydrogen atoms in the chain respectively. The H(added) column lists the number of hydrogen atoms added and optimized by MolProbity. The Clashes column lists the number of clashes within the asymmetric unit, whereas Symm-Clashes lists symmetry related clashes.

Mol	Chain	Non-H	H(model)	H(added)	Clashes	Symm-Clashes
1	A	4350	0	4224	62	0
1	C	4317	0	4185	64	0
1	E	4294	0	4170	71	0

Continued on next page...

Continued from previous page...

Mol	Chain	Non-H	H(model)	H(added)	Clashes	Symm-Clashes
1	G	4291	0	4167	80	0
2	B	1126	0	1084	22	0
2	D	1126	0	1084	17	2
2	F	1126	0	1084	19	0
2	H	1126	0	1084	26	2
3	A	26	0	0	0	0
3	B	2	0	0	0	0
3	C	19	0	0	1	0
3	D	3	0	0	1	0
3	E	17	0	0	0	0
3	F	1	0	0	0	0
3	G	14	0	0	2	0
3	H	2	0	0	0	0
All	All	21840	0	21082	349	2

The all-atom clashscore is defined as the number of clashes found per 1000 atoms (including hydrogen atoms). The all-atom clashscore for this structure is 8.

All (349) close contacts within the same asymmetric unit are listed below, sorted by their clash magnitude.

Atom-1	Atom-2	Interatomic distance (Å)	Clash overlap (Å)
1:A:40:ARG:NH1	1:A:67:GLN:O	2.09	0.85
1:G:298:GLN:HB3	1:G:301:LYS:HE2	1.58	0.84
1:E:1:MSE:HE2	1:E:48:PRO:HB2	1.63	0.79
1:E:97:LEU:HB3	2:F:1:MSE:HE3	1.64	0.78
1:G:155:VAL:HG23	2:H:3:ILE:HD11	1.65	0.77
2:D:48:LEU:HD23	2:D:49:ILE:HG13	1.65	0.77
1:C:465:HIS:CD2	1:C:466:LEU:HG	2.19	0.77
1:G:31:GLU:OE2	1:G:66:ARG:NH1	2.19	0.76
1:G:30:LEU:HD13	1:G:442:TYR:HB2	1.68	0.76
1:A:41:ILE:HD13	1:A:511:VAL:HG11	1.68	0.75
1:G:347:VAL:O	1:G:410:ARG:NH2	2.19	0.75
1:C:235:ALA:HA	1:C:240:ASN:HD21	1.49	0.75
2:H:99:LYS:HE3	2:H:112:ASN:HD22	1.51	0.75
1:G:483:ASP:HB2	1:G:487:GLN:HG3	1.70	0.74
1:A:167:VAL:HG23	1:A:185:LYS:HD2	1.69	0.73
2:F:125:PRO:HG2	2:F:128:ALA:HB2	1.71	0.73
1:E:30:LEU:HD13	1:E:442:TYR:HB2	1.69	0.73
1:A:312:LEU:HD13	1:A:423:ILE:HG23	1.71	0.72
1:E:298:GLN:HG3	1:E:301:LYS:HE2	1.71	0.72
1:E:27:MSE:HE1	1:E:361:ASN:HA	1.72	0.72

Continued on next page...

Continued from previous page...

Atom-1	Atom-2	Interatomic distance (Å)	Clash overlap (Å)
1:A:51:LEU:HG	1:A:53:LEU:HD21	1.70	0.72
1:G:386:ASP:O	1:G:410:ARG:NH1	2.22	0.72
1:C:185:LYS:O	1:C:189:SER:HB2	1.91	0.70
1:E:18:ARG:HG3	1:E:57:MSE:HB3	1.74	0.70
1:C:31:GLU:OE2	1:C:66:ARG:NH1	2.27	0.68
2:H:115:GLU:HB2	2:H:120:MSE:HE2	1.76	0.68
1:C:270:LEU:HB3	1:C:274:LEU:HD12	1.75	0.68
1:E:96:ASP:HB2	2:F:4:GLN:HB2	1.75	0.67
2:F:115:GLU:HG3	2:F:120:MSE:HB2	1.77	0.67
1:C:68:ASP:OD1	2:D:105:ARG:NH2	2.28	0.66
1:E:282:THR:HG21	1:E:287:PHE:HB3	1.77	0.66
2:B:77:LYS:HB2	2:B:80:ARG:HD2	1.78	0.66
2:D:125:PRO:HG2	2:D:128:ALA:HB2	1.78	0.66
1:E:45:GLU:O	1:E:47:LEU:N	2.25	0.66
2:B:125:PRO:HG2	2:B:128:ALA:HB2	1.76	0.66
1:A:30:LEU:HD13	1:A:442:TYR:HB2	1.77	0.66
1:E:317:SER:HB2	1:E:430:ARG:HH11	1.61	0.65
1:C:96:ASP:HB2	2:D:4:GLN:HB2	1.78	0.65
1:E:108:THR:HB	1:E:111:LEU:H	1.62	0.64
2:H:86:ARG:NE	2:H:88:MSE:HE3	2.12	0.64
1:E:225:VAL:HG11	1:E:231:PHE:HZ	1.63	0.63
1:E:31:GLU:OE2	1:E:66:ARG:NH2	2.23	0.63
2:H:77:LYS:HB2	2:H:80:ARG:HD2	1.81	0.63
1:G:36:ILE:O	1:G:40:ARG:HG3	1.97	0.63
1:A:314:LEU:HD21	1:A:500:ILE:HD11	1.80	0.63
2:D:86:ARG:NH2	2:D:96:VAL:O	2.27	0.62
1:C:30:LEU:HD13	1:C:442:TYR:HB2	1.81	0.62
1:A:36:ILE:O	1:A:40:ARG:HG3	2.00	0.62
1:A:65:HIS:HA	1:A:70:PHE:HB2	1.80	0.62
1:C:108:THR:HG22	1:C:110:PHE:H	1.63	0.62
1:C:36:ILE:O	1:C:40:ARG:HG3	2.00	0.62
1:G:200:ASP:O	1:G:216:LYS:NZ	2.31	0.62
1:C:159:VAL:HG22	1:C:169:GLN:HB2	1.82	0.62
1:E:150:ASP:OD1	1:E:152:ARG:HD2	1.99	0.61
2:D:86:ARG:HE	2:D:88:MSE:HE3	1.65	0.61
1:A:33:ASP:HB3	1:A:36:ILE:HG13	1.83	0.61
1:A:116:ARG:HG2	1:A:121:TYR:HB2	1.83	0.61
1:C:6:PRO:HB3	1:C:35:THR:HG21	1.83	0.61
1:G:57:MSE:HB2	1:G:60:ALA:HB2	1.82	0.60
1:G:457:LEU:HD23	1:G:472:LEU:HB2	1.84	0.60
1:A:108:THR:HG22	1:A:110:PHE:H	1.65	0.60

Continued on next page...

Continued from previous page...

Atom-1	Atom-2	Interatomic distance (Å)	Clash overlap (Å)
1:A:57:MSE:HB2	1:A:60:ALA:HB2	1.83	0.60
1:E:457:LEU:HD11	1:E:475:ILE:HD11	1.84	0.59
1:C:464:THR:H	1:C:468:ASN:HB2	1.68	0.59
1:E:225:VAL:HG11	1:E:231:PHE:CZ	2.36	0.59
1:E:435:LEU:HD13	1:E:475:ILE:HD12	1.85	0.59
1:E:61:ARG:N	1:E:151:ASP:OD2	2.31	0.59
1:A:464:THR:H	1:A:468:ASN:HB2	1.68	0.59
2:B:86:ARG:HH11	2:B:98:LEU:HB2	1.67	0.58
1:C:114:VAL:HB	1:C:122:ALA:HB3	1.86	0.58
2:F:86:ARG:NE	2:F:88:MSE:HE2	2.18	0.58
1:G:427:ASP:OD2	2:H:108:ARG:NH2	2.36	0.58
1:G:194:ASN:OD1	1:G:196:VAL:HG13	2.04	0.58
1:G:40:ARG:NH1	1:G:67:GLN:O	2.35	0.58
1:A:56:TYR:CZ	1:A:58:PRO:HG3	2.39	0.57
2:B:84:LEU:HD23	2:B:120:MSE:HE3	1.86	0.57
1:C:51:LEU:HG	1:C:53:LEU:HD21	1.86	0.57
1:A:418:ASP:HB2	1:A:421:SER:H	1.68	0.57
1:E:464:THR:H	1:E:468:ASN:HB2	1.69	0.57
1:C:39:ILE:HD11	1:C:51:LEU:HD13	1.87	0.57
1:E:51:LEU:HG	1:E:53:LEU:HD21	1.88	0.56
1:C:473:ASP:HB2	1:C:477:GLN:OE1	2.05	0.56
1:A:39:ILE:HD11	1:A:51:LEU:HD13	1.87	0.56
1:C:65:HIS:HA	1:C:70:PHE:HB2	1.86	0.56
1:G:182:GLU:HG3	1:G:191:VAL:HG22	1.88	0.56
1:C:57:MSE:HB2	1:C:60:ALA:HB2	1.86	0.56
1:E:392:PHE:CE2	1:E:407:LEU:HA	2.41	0.56
1:E:317:SER:HB2	1:E:430:ARG:NH1	2.21	0.56
1:G:6:PRO:HB3	1:G:35:THR:HG21	1.87	0.56
2:B:38:SER:HB2	2:B:41:GLN:HG2	1.86	0.55
2:D:86:ARG:NE	2:D:88:MSE:HE3	2.21	0.55
2:B:86:ARG:NE	2:B:88:MSE:HE2	2.21	0.55
1:E:1:MSE:HG2	1:E:2:TYR:N	2.22	0.55
1:A:222:SER:HB2	1:A:223:HIS:CD2	2.42	0.55
2:B:92:PRO:HG3	2:B:141:GLU:H	1.72	0.55
1:E:15:VAL:HG11	1:E:238:PHE:HZ	1.72	0.55
1:E:418:ASP:HB2	1:E:421:SER:H	1.72	0.55
1:G:464:THR:H	1:G:468:ASN:HB2	1.71	0.55
1:E:473:ASP:HB2	1:E:477:GLN:HE22	1.70	0.55
1:E:40:ARG:NH1	1:E:67:GLN:O	2.38	0.55
1:G:521:GLU:OE2	1:G:521:GLU:N	2.40	0.55
1:E:61:ARG:HH21	1:E:151:ASP:HB2	1.71	0.55

Continued on next page...

Continued from previous page...

Atom-1	Atom-2	Interatomic distance (Å)	Clash overlap (Å)
2:D:86:ARG:HD3	2:D:118:ASP:HA	1.88	0.54
1:E:500:ILE:O	1:E:504:LYS:HG2	2.07	0.54
1:E:236:GLN:HG3	1:E:238:PHE:CD2	2.41	0.54
1:E:56:TYR:OH	1:E:157:SER:HB2	2.07	0.54
1:G:312:LEU:HD13	1:G:423:ILE:HG23	1.90	0.54
1:A:298:GLN:HB3	1:A:301:LYS:HE3	1.90	0.54
1:G:217:LEU:O	1:G:221:ILE:HG13	2.08	0.54
1:G:335:LEU:HD21	1:G:370:VAL:HG22	1.90	0.54
1:E:65:HIS:HA	1:E:70:PHE:HB2	1.89	0.53
1:G:51:LEU:HG	1:G:53:LEU:CD1	2.39	0.53
1:A:66:ARG:NH1	1:A:129:GLU:OE2	2.42	0.53
1:A:353:THR:O	1:A:410:ARG:HD2	2.09	0.53
1:C:270:LEU:O	1:C:274:LEU:HB2	2.09	0.53
1:G:33:ASP:HB3	1:G:36:ILE:H	1.73	0.53
1:G:51:LEU:HG	1:G:53:LEU:HD11	1.89	0.53
1:A:501:GLU:HA	1:A:504:LYS:HE2	1.91	0.53
2:H:40:ASP:HB2	2:H:146:HIS:CE1	2.43	0.53
2:H:99:LYS:HD2	2:H:136:LEU:HD11	1.91	0.53
1:C:395:ASN:O	1:C:396:GLN:HG3	2.10	0.53
1:C:344:LEU:HD21	1:C:374:VAL:HG13	1.90	0.52
1:C:45:GLU:HB2	1:C:47:LEU:HG	1.91	0.52
1:G:292:GLN:HG2	1:G:299:ALA:HB1	1.91	0.52
2:F:77:LYS:HB2	2:F:80:ARG:HD2	1.92	0.52
2:D:78:ARG:NH1	3:D:201:HOH:O	2.34	0.52
1:A:68:ASP:OD1	2:B:105:ARG:NH2	2.44	0.51
2:B:86:ARG:HD2	2:B:98:LEU:HB2	1.92	0.51
1:C:124:VAL:HG13	1:C:135:ILE:HG12	1.92	0.51
1:C:161:TYR:CE1	1:C:166:GLU:HG2	2.45	0.51
1:C:180:ILE:HD11	1:C:209:MSE:HE1	1.93	0.51
1:A:108:THR:HB	1:A:111:LEU:H	1.74	0.51
1:E:288:LYS:HG3	1:E:302:ILE:HG22	1.93	0.51
1:G:288:LYS:HG3	1:G:302:ILE:HG22	1.92	0.51
1:C:100:GLU:HG2	1:C:116:ARG:NH2	2.26	0.51
1:E:236:GLN:HG3	1:E:238:PHE:HD2	1.75	0.51
1:G:387:PHE:O	1:G:410:ARG:HG2	2.10	0.51
2:B:93:SER:OG	2:B:94:GLU:N	2.44	0.51
2:H:105:ARG:C	2:H:107:ASN:H	2.14	0.51
1:G:269:ASN:OD1	1:G:269:ASN:N	2.43	0.50
1:A:182:GLU:HG3	1:A:191:VAL:HG22	1.94	0.50
1:A:339:ALA:HA	1:A:475:ILE:HD12	1.93	0.50
1:C:392:PHE:CE2	1:C:407:LEU:HA	2.46	0.50

Continued on next page...

Continued from previous page...

Atom-1	Atom-2	Interatomic distance (Å)	Clash overlap (Å)
1:E:222:SER:HB2	1:E:223:HIS:ND1	2.26	0.50
1:E:267:ILE:HG22	1:E:295:PHE:HE2	1.77	0.50
1:E:236:GLN:C	1:E:238:PHE:H	2.15	0.50
1:E:282:THR:HG22	1:E:284:ARG:H	1.77	0.50
2:H:1:MSE:HA	2:H:1:MSE:HE2	1.92	0.50
1:C:162:GLU:HG3	1:C:167:VAL:HG11	1.93	0.50
2:D:49:ILE:HD13	2:D:55:ILE:HA	1.94	0.50
1:E:320:ARG:NH2	1:E:354:GLU:OE1	2.43	0.50
1:G:108:THR:HB	1:G:111:LEU:H	1.75	0.50
1:C:418:ASP:HB2	1:C:421:SER:H	1.75	0.50
1:G:1:MSE:HG2	1:G:2:TYR:H	1.76	0.50
1:G:100:GLU:HG3	1:G:101:ASP:H	1.77	0.49
1:G:65:HIS:HA	1:G:70:PHE:HB2	1.93	0.49
1:C:108:THR:HB	1:C:111:LEU:H	1.77	0.49
1:C:418:ASP:HB3	1:C:420:LEU:H	1.77	0.49
1:C:40:ARG:NH1	1:C:67:GLN:O	2.42	0.49
1:G:352:ASP:OD1	1:G:390:LYS:NZ	2.27	0.49
2:B:76:LEU:HD22	2:B:131:TYR:CE1	2.48	0.49
1:G:150:ASP:OD1	1:G:152:ARG:NH1	2.46	0.49
1:E:79:ASP:OD2	1:E:152:ARG:NH2	2.45	0.49
2:H:98:LEU:HD23	2:H:120:MSE:HE3	1.94	0.49
2:F:80:ARG:HH11	2:F:80:ARG:HG3	1.77	0.48
1:G:1:MSE:CE	1:G:48:PRO:HB2	2.43	0.48
1:C:29:ARG:HG2	1:C:30:LEU:H	1.77	0.48
1:G:248:PRO:O	1:G:251:SER:OG	2.31	0.48
1:C:47:LEU:HD12	1:C:512:ILE:HD12	1.94	0.48
2:H:86:ARG:HD3	2:H:118:ASP:HA	1.95	0.48
1:E:27:MSE:CE	1:E:361:ASN:HA	2.41	0.48
1:C:244:LEU:HD22	1:C:276:TYR:HD2	1.77	0.48
1:A:167:VAL:HG13	1:A:168:CYS:HB3	1.94	0.48
2:F:40:ASP:O	2:F:146:HIS:HA	2.13	0.48
1:G:191:VAL:HG21	1:G:209:MSE:HG2	1.96	0.48
1:G:39:ILE:HD11	1:G:51:LEU:HD13	1.96	0.48
1:G:473:ASP:HB2	1:G:477:GLN:HE22	1.78	0.48
2:F:93:SER:OG	2:F:94:GLU:N	2.46	0.47
1:G:186:PHE:HB2	1:G:189:SER:HB3	1.94	0.47
1:A:105:PHE:HD1	1:A:114:VAL:HG22	1.79	0.47
1:G:51:LEU:HD22	1:G:72:THR:HG21	1.96	0.47
1:G:459:ALA:HA	1:G:471:ILE:HD13	1.94	0.47
1:A:286:ASP:OD1	1:A:286:ASP:N	2.42	0.47
1:G:56:TYR:CZ	1:G:58:PRO:HG3	2.50	0.47

Continued on next page...

Continued from previous page...

Atom-1	Atom-2	Interatomic distance (Å)	Clash overlap (Å)
1:G:271:LYS:HG3	1:G:295:PHE:HE1	1.80	0.47
1:G:465:HIS:CE1	1:G:466:LEU:HG	2.50	0.47
1:G:68:ASP:CG	2:H:105:ARG:HH22	2.17	0.47
2:H:87:ASP:OD2	2:H:146:HIS:HD2	1.98	0.47
1:G:428:ASP:N	1:G:428:ASP:OD1	2.48	0.47
1:E:337:ASP:OD1	1:E:373:LYS:HE3	2.15	0.47
1:G:116:ARG:HG2	1:G:121:TYR:HB2	1.97	0.47
2:H:34:ILE:HG13	2:H:44:PHE:HD1	1.79	0.47
1:C:244:LEU:HD22	1:C:276:TYR:CD2	2.50	0.47
1:G:238:PHE:CD2	1:G:239:THR:HG22	2.50	0.47
1:E:16:TRP:HH2	1:E:182:GLU:OE1	1.97	0.46
2:F:86:ARG:HD2	2:F:98:LEU:HB2	1.97	0.46
1:A:394:ASN:HB3	1:C:143:LEU:HB3	1.97	0.46
2:H:86:ARG:CZ	2:H:88:MSE:HE3	2.45	0.46
1:C:248:PRO:HB2	1:C:251:SER:HB3	1.96	0.46
1:C:298:GLN:HB3	1:C:301:LYS:HE2	1.96	0.46
1:E:36:ILE:O	1:E:40:ARG:HG3	2.16	0.46
2:F:84:LEU:HD23	2:F:120:MSE:HE3	1.96	0.46
1:C:269:ASN:OD1	1:C:269:ASN:N	2.48	0.46
1:A:477:GLN:HG3	1:C:438:GLN:OE1	2.16	0.46
1:G:210:PRO:HA	1:G:213:ILE:HB	1.98	0.46
1:C:453:PRO:HA	1:C:468:ASN:O	2.16	0.46
2:F:80:ARG:HD3	2:F:152:GLU:OE2	2.16	0.46
2:B:80:ARG:HG3	2:B:80:ARG:HH11	1.81	0.46
1:E:283:ASP:HB2	1:E:307:PRO:HD3	1.98	0.46
1:A:335:LEU:HD21	1:A:370:VAL:HG22	1.98	0.45
1:C:158:ILE:O	1:C:169:GLN:HA	2.16	0.45
1:E:312:LEU:HD13	1:E:423:ILE:HG23	1.97	0.45
1:E:8:TRP:HE3	1:E:57:MSE:HE1	1.80	0.45
1:A:24:TYR:CE1	1:A:25:ARG:HG3	2.51	0.45
1:C:168:CYS:SG	1:C:181:ARG:HD3	2.57	0.45
1:G:473:ASP:HB2	1:G:477:GLN:NE2	2.31	0.45
2:H:64:TYR:O	2:H:66:GLY:N	2.49	0.45
1:A:24:TYR:CD1	1:A:25:ARG:HG3	2.52	0.45
1:A:27:MSE:HE1	1:A:361:ASN:HA	1.98	0.45
1:A:18:ARG:HG3	1:A:57:MSE:HG2	1.99	0.45
1:C:320:ARG:NH2	1:C:354:GLU:OE1	2.43	0.45
1:G:267:ILE:HG22	1:G:295:PHE:HE2	1.81	0.45
2:F:34:ILE:HG13	2:F:44:PHE:HD1	1.82	0.45
1:G:130:GLY:O	2:H:70:VAL:HG13	2.16	0.45
2:B:84:LEU:HD23	2:B:120:MSE:CE	2.47	0.45

Continued on next page...

Continued from previous page...

Atom-1	Atom-2	Interatomic distance (Å)	Clash overlap (Å)
1:C:520:LYS:HA	1:C:520:LYS:HD2	1.75	0.45
1:E:307:PRO:HD2	1:E:462:TYR:OH	2.17	0.45
1:G:392:PHE:CZ	1:G:407:LEU:HA	2.52	0.45
1:G:419:GLU:OE1	3:G:601:HOH:O	2.21	0.45
1:G:464:THR:H	1:G:468:ASN:CB	2.29	0.44
1:A:274:LEU:HD23	1:A:295:PHE:CD2	2.52	0.44
1:A:486:LEU:HD23	1:A:486:LEU:HA	1.73	0.44
1:C:387:PHE:O	1:C:410:ARG:HG2	2.17	0.44
1:E:467:GLN:HB3	1:E:498:TYR:CD2	2.52	0.44
1:C:16:TRP:CH2	1:C:209:MSE:HG3	2.53	0.44
1:E:473:ASP:HB2	1:E:477:GLN:NE2	2.31	0.44
2:B:34:ILE:H	2:B:34:ILE:HG13	1.49	0.44
1:G:173:ASN:OD1	1:G:176:GLY:N	2.49	0.44
2:H:77:LYS:CB	2:H:80:ARG:HD2	2.48	0.44
1:A:202:ASP:O	1:A:206:TYR:OH	2.34	0.44
1:C:80:GLU:CD	1:C:216:LYS:HD2	2.38	0.44
1:E:453:PRO:HA	1:E:468:ASN:O	2.18	0.44
1:G:31:GLU:CD	1:G:66:ARG:HH11	2.22	0.43
1:G:426:LEU:HD23	1:G:426:LEU:HA	1.79	0.43
1:A:214:LEU:HD21	1:A:246:LEU:HD11	2.00	0.43
1:E:226:GLU:HB3	1:E:227:GLU:HB3	2.00	0.43
1:E:239:THR:HG22	1:E:241:GLN:H	1.82	0.43
1:G:390:LYS:C	1:G:392:PHE:H	2.21	0.43
1:C:54:GLN:HG3	3:C:605:HOH:O	2.17	0.43
1:G:337:ASP:CG	1:G:373:LYS:HE2	2.38	0.43
1:A:465:HIS:CE1	1:A:466:LEU:HD13	2.53	0.43
1:C:170:ASP:N	1:C:170:ASP:OD1	2.52	0.43
1:C:236:GLN:C	1:C:238:PHE:H	2.22	0.43
1:G:1:MSE:HE2	1:G:48:PRO:HB2	2.01	0.43
1:A:137:PHE:HB2	1:A:145:LYS:HB2	2.00	0.43
1:A:279:LEU:HD11	1:A:518:TRP:HB3	2.00	0.43
1:G:373:LYS:HA	1:G:373:LYS:HD2	1.71	0.43
1:E:371:GLU:HG2	1:E:413:ILE:HD12	2.01	0.43
2:B:95:SER:HB2	2:B:140:VAL:HG22	1.99	0.43
2:D:7:LYS:HB3	2:D:7:LYS:HE2	1.91	0.43
1:C:193:VAL:HG12	1:C:194:ASN:O	2.18	0.43
1:A:80:GLU:OE1	1:A:216:LYS:HD2	2.19	0.43
1:C:102:ASP:OD2	1:C:116:ARG:HB2	2.19	0.43
1:A:351:PRO:HA	1:A:410:ARG:NH1	2.34	0.42
2:B:2:LYS:NZ	2:B:4:GLN:OE1	2.51	0.42
1:E:61:ARG:HB2	1:E:151:ASP:OD2	2.19	0.42

Continued on next page...

Continued from previous page...

Atom-1	Atom-2	Interatomic distance (Å)	Clash overlap (Å)
1:G:462:TYR:O	1:G:468:ASN:ND2	2.51	0.42
1:A:33:ASP:CB	1:A:36:ILE:HG13	2.47	0.42
1:A:314:LEU:CD2	1:A:500:ILE:HD11	2.49	0.42
2:B:99:LYS:HD2	2:B:136:LEU:HD11	2.01	0.42
1:E:331:LEU:HA	1:E:331:LEU:HD12	1.87	0.42
1:G:324:LYS:HE2	1:G:429:THR:OG1	2.20	0.42
1:A:252:HIS:HA	1:A:278:ASP:OD2	2.19	0.42
1:A:282:THR:HG21	1:A:287:PHE:HD2	1.85	0.42
1:A:62:TYR:CE2	1:A:151:ASP:HB2	2.55	0.42
2:B:50:ALA:HB3	2:B:53:GLN:HG2	2.01	0.42
2:D:99:LYS:HD2	2:D:136:LEU:HD11	2.00	0.42
1:E:15:VAL:HG11	1:E:238:PHE:CZ	2.54	0.42
1:E:51:LEU:HD22	1:E:72:THR:HG21	2.01	0.42
2:F:86:ARG:CD	2:F:98:LEU:HD22	2.50	0.42
2:H:78:ARG:HA	2:H:124:TYR:HD2	1.84	0.42
1:A:28:GLN:HB2	1:A:417:THR:O	2.20	0.42
1:E:430:ARG:HG3	1:E:492:TRP:NE1	2.35	0.42
1:G:77:VAL:O	1:G:81:ILE:HG13	2.19	0.42
1:A:223:HIS:CD2	1:A:223:HIS:N	2.88	0.42
1:A:306:SER:HA	1:A:307:PRO:HD3	1.93	0.42
1:A:389:LYS:HD2	1:A:408:GLU:HB3	2.02	0.42
2:B:86:ARG:HD2	2:B:98:LEU:HD13	2.02	0.42
1:C:21:ILE:HA	1:C:22:PRO:HD3	1.93	0.42
1:A:230:ARG:HG2	1:A:252:HIS:HB2	2.01	0.42
2:D:97:PHE:CE1	2:D:116:ARG:HG2	2.55	0.42
1:G:196:VAL:HG22	1:G:197:PHE:CD2	2.53	0.42
2:H:88:MSE:HE1	2:H:135:LEU:HD22	2.02	0.42
2:D:70:VAL:HG13	2:D:71:PRO:HD2	2.02	0.42
1:E:68:ASP:OD2	2:F:105:ARG:NH2	2.52	0.42
1:G:173:ASN:ND2	1:G:177:ASP:HB2	2.35	0.42
1:A:27:MSE:HE3	1:A:27:MSE:HB3	1.79	0.42
2:F:92:PRO:HG2	2:F:140:VAL:HA	2.01	0.42
1:A:244:LEU:HA	1:A:244:LEU:HD23	1.81	0.41
2:F:90:SER:HB2	2:F:93:SER:O	2.20	0.41
1:G:112:ILE:HB	1:G:124:VAL:HB	2.01	0.41
1:G:238:PHE:CE2	1:G:239:THR:HG22	2.55	0.41
1:E:496:LEU:O	1:E:500:ILE:HG13	2.20	0.41
1:G:240:ASN:O	1:G:244:LEU:HD23	2.20	0.41
1:G:8:TRP:NE1	1:G:33:ASP:OD2	2.45	0.41
1:A:4:PHE:CD2	1:A:232:VAL:HB	2.55	0.41
2:H:49:ILE:HD13	2:H:55:ILE:HA	2.02	0.41

Continued on next page...

Continued from previous page...

Atom-1	Atom-2	Interatomic distance (Å)	Clash overlap (Å)
2:B:98:LEU:HD23	2:B:120:MSE:HE2	2.02	0.41
2:B:77:LYS:CB	2:B:80:ARG:HD2	2.48	0.41
1:G:18:ARG:HG3	1:G:57:MSE:HG2	2.02	0.41
1:A:45:GLU:OE1	1:A:509:HIS:HB2	2.20	0.41
1:A:98:GLU:HG2	1:A:99:TRP:H	1.86	0.41
2:D:34:ILE:HG13	2:D:44:PHE:HD1	1.86	0.41
1:G:280:VAL:HB	1:G:302:ILE:HG12	2.02	0.41
1:E:426:LEU:HA	1:E:426:LEU:HD23	1.72	0.41
1:E:39:ILE:HD11	1:E:51:LEU:HD13	2.02	0.41
1:C:26:SER:O	1:C:27:MSE:HE3	2.21	0.41
1:C:292:GLN:HG2	1:C:299:ALA:HB1	2.01	0.41
2:D:41:GLN:HE21	2:D:146:HIS:CE1	2.39	0.41
1:G:140:ASP:O	1:G:142:GLN:N	2.54	0.41
1:G:134:PHE:CD1	1:G:146:LEU:HD11	2.56	0.41
2:H:112:ASN:O	2:H:113:HIS:ND1	2.41	0.41
1:A:257:PHE:HB2	1:A:282:THR:HG22	2.02	0.41
1:E:360:TYR:CZ	1:E:440:ASN:HB2	2.55	0.41
1:E:64:LEU:HD22	1:E:69:ILE:HG13	2.03	0.41
2:F:11:TRP:CZ2	2:F:56:HIS:ND1	2.89	0.41
1:G:140:ASP:C	1:G:142:GLN:H	2.24	0.41
2:H:97:PHE:CE1	2:H:116:ARG:HG2	2.55	0.41
2:B:1:MSE:HA	2:B:1:MSE:HE2	2.03	0.41
1:C:34:ASP:OD1	1:C:34:ASP:N	2.54	0.41
1:E:136:LYS:HG3	1:E:146:LEU:HD13	2.02	0.41
1:E:490:LYS:HD3	1:E:490:LYS:HA	1.88	0.41
1:E:56:TYR:CZ	1:E:58:PRO:HG3	2.56	0.41
1:C:306:SER:HA	1:C:307:PRO:HD3	1.94	0.40
1:C:355:LEU:O	1:C:411:PHE:HA	2.22	0.40
2:D:57:GLU:HG3	2:D:134:GLN:HG2	2.02	0.40
2:F:92:PRO:HG3	2:F:141:GLU:H	1.86	0.40
1:G:255:LEU:HA	1:G:255:LEU:HD12	1.83	0.40
1:G:410:ARG:HD3	3:G:613:HOH:O	2.20	0.40
1:A:45:GLU:O	1:A:47:LEU:HG	2.21	0.40
1:C:168:CYS:HA	1:C:184:LEU:HG	2.02	0.40
1:E:420:LEU:O	1:E:424:GLN:HG3	2.21	0.40
2:H:112:ASN:C	2:H:113:HIS:HD1	2.23	0.40
2:H:38:SER:HB3	2:H:41:GLN:HG2	2.04	0.40
1:C:150:ASP:OD1	1:C:152:ARG:HG3	2.22	0.40
1:G:499:SER:O	1:G:503:ILE:HG13	2.21	0.40
1:C:216:LYS:HD3	1:C:216:LYS:HA	1.76	0.40
1:E:444:GLN:HE21	1:E:456:ASN:ND2	2.19	0.40

Continued on next page...

Continued from previous page...

Atom-1	Atom-2	Interatomic distance (Å)	Clash overlap (Å)
1:E:55:ALA:HB3	1:E:57:MSE:HE2	2.04	0.40

All (2) symmetry-related close contacts are listed below. The label for Atom-2 includes the symmetry operator and encoded unit-cell translations to be applied.

Atom-1	Atom-2	Interatomic distance (Å)	Clash overlap (Å)
2:D:48:LEU:N	2:H:46:ASN:O[4_566]	2.05	0.15
2:D:46:ASN:O	2:H:48:LEU:N[4_566]	2.19	0.01

5.3 Torsion angles [i](#)

5.3.1 Protein backbone [i](#)

In the following table, the Percentiles column shows the percent Ramachandran outliers of the chain as a percentile score with respect to all X-ray entries followed by that with respect to entries of similar resolution.

The Analysed column shows the number of residues for which the backbone conformation was analysed, and the total number of residues.

Mol	Chain	Analysed	Favoured	Allowed	Outliers	Percentiles
1	A	511/533 (96%)	472 (92%)	37 (7%)	2 (0%)	34 69
1	C	507/533 (95%)	485 (96%)	22 (4%)	0	100 100
1	E	504/533 (95%)	474 (94%)	28 (6%)	2 (0%)	34 69
1	G	504/533 (95%)	463 (92%)	38 (8%)	3 (1%)	25 59
2	B	128/159 (80%)	111 (87%)	15 (12%)	2 (2%)	9 37
2	D	128/159 (80%)	119 (93%)	8 (6%)	1 (1%)	19 54
2	F	128/159 (80%)	118 (92%)	10 (8%)	0	100 100
2	H	128/159 (80%)	115 (90%)	12 (9%)	1 (1%)	19 54
All	All	2538/2768 (92%)	2357 (93%)	170 (7%)	11 (0%)	34 69

All (11) Ramachandran outliers are listed below:

Mol	Chain	Res	Type
2	B	3	ILE
1	E	46	ASN
2	H	65	GLN

Continued on next page...

Continued from previous page...

Mol	Chain	Res	Type
1	A	46	ASN
2	D	117	SER
1	G	46	ASN
1	G	141	ASP
1	G	296	PRO
1	A	334	LEU
1	E	141	ASP
2	B	34	ILE

5.3.2 Protein sidechains [i](#)

In the following table, the Percentiles column shows the percent sidechain outliers of the chain as a percentile score with respect to all X-ray entries followed by that with respect to entries of similar resolution.

The Analysed column shows the number of residues for which the sidechain conformation was analysed, and the total number of residues.

Mol	Chain	Analysed	Rotameric	Outliers	Percentiles
1	A	478/487 (98%)	471 (98%)	7 (2%)	65 85
1	C	474/487 (97%)	462 (98%)	12 (2%)	47 75
1	E	471/487 (97%)	462 (98%)	9 (2%)	57 81
1	G	471/487 (97%)	462 (98%)	9 (2%)	57 81
2	B	126/144 (88%)	125 (99%)	1 (1%)	81 92
2	D	126/144 (88%)	123 (98%)	3 (2%)	49 76
2	F	126/144 (88%)	122 (97%)	4 (3%)	39 69
2	H	126/144 (88%)	124 (98%)	2 (2%)	62 84
All	All	2398/2524 (95%)	2351 (98%)	47 (2%)	55 80

All (47) residues with a non-rotameric sidechain are listed below:

Mol	Chain	Res	Type
1	A	27	MSE
1	A	29	ARG
1	A	54	GLN
1	A	61	ARG
1	A	245	ASP
1	A	314	LEU
1	A	373	LYS

Continued on next page...

Continued from previous page...

Mol	Chain	Res	Type
2	B	62	TRP
1	C	1	MSE
1	C	9	SER
1	C	27	MSE
1	C	61	ARG
1	C	76	SER
1	C	170	ASP
1	C	209	MSE
1	C	269	ASN
1	C	274	LEU
1	C	317	SER
1	C	494	GLN
1	C	507	THR
2	D	62	TRP
2	D	83	SER
2	D	154	LEU
1	E	15	VAL
1	E	61	ARG
1	E	76	SER
1	E	157	SER
1	E	167	VAL
1	E	265	SER
1	E	317	SER
1	E	328	GLN
1	E	342	LYS
2	F	62	TRP
2	F	90	SER
2	F	120	MSE
2	F	127	GLU
1	G	15	VAL
1	G	25	ARG
1	G	27	MSE
1	G	61	ARG
1	G	209	MSE
1	G	267	ILE
1	G	317	SER
1	G	410	ARG
1	G	480	VAL
2	H	62	TRP
2	H	88	MSE

Some sidechains can be flipped to improve hydrogen bonding and reduce clashes. All (13) such sidechains are listed below:

Mol	Chain	Res	Type
1	A	28	GLN
1	A	293	ASN
1	A	364	GLN
1	A	444	GLN
1	C	456	ASN
2	D	146	HIS
1	E	28	GLN
1	E	292	GLN
1	E	456	ASN
1	G	444	GLN
1	G	456	ASN
1	G	491	ASN
2	H	56	HIS

5.3.3 RNA [i](#)

There are no RNA molecules in this entry.

5.4 Non-standard residues in protein, DNA, RNA chains [i](#)

There are no non-standard protein/DNA/RNA residues in this entry.

5.5 Carbohydrates [i](#)

There are no carbohydrates in this entry.

5.6 Ligand geometry [i](#)

There are no ligands in this entry.

5.7 Other polymers [i](#)

There are no such residues in this entry.

5.8 Polymer linkage issues [i](#)

There are no chain breaks in this entry.

6 Fit of model and data i

6.1 Protein, DNA and RNA chains i

In the following table, the column labelled ‘#RSRZ> 2’ contains the number (and percentage) of RSRZ outliers, followed by percent RSRZ outliers for the chain as percentile scores relative to all X-ray entries and entries of similar resolution. The OWAB column contains the minimum, median, 95th percentile and maximum values of the occupancy-weighted average B-factor per residue. The column labelled ‘Q< 0.9’ lists the number of (and percentage) of residues with an average occupancy less than 0.9.

Mol	Chain	Analysed	<RSRZ>	#RSRZ>2	OWAB(Å ²)	Q<0.9
1	A	511/533 (95%)	-0.34	5 (0%) 82 67	1, 24, 70, 88	0
1	C	507/533 (95%)	-0.36	8 (1%) 72 51	1, 15, 63, 103	0
1	E	504/533 (94%)	-0.41	4 (0%) 86 72	1, 16, 62, 100	0
1	G	504/533 (94%)	-0.25	10 (1%) 65 44	2, 26, 78, 98	0
2	B	131/159 (82%)	0.08	3 (2%) 60 39	11, 42, 81, 96	0
2	D	131/159 (82%)	-0.23	2 (1%) 73 54	3, 23, 55, 67	0
2	F	131/159 (82%)	0.01	3 (2%) 60 39	5, 32, 76, 85	0
2	H	131/159 (82%)	0.05	1 (0%) 86 72	9, 37, 74, 89	0
All	All	2550/2768 (92%)	-0.27	36 (1%) 75 56	1, 23, 71, 103	0

All (36) RSRZ outliers are listed below:

Mol	Chain	Res	Type	RSRZ
2	F	66	GLY	4.0
1	E	394	ASN	3.6
1	C	525	GLU	3.5
2	B	91	TYR	3.2
2	H	69	GLN	2.9
1	G	241	GLN	2.8
1	C	250	HIS	2.8
1	E	396	GLN	2.8
1	G	250	HIS	2.8
1	G	522	ALA	2.8
1	A	103	CYS	2.7
1	C	522	ALA	2.7
2	B	37	HIS	2.6
1	G	140	ASP	2.6
1	G	394	ASN	2.6
1	C	223	HIS	2.5

Continued on next page...

Continued from previous page...

Mol	Chain	Res	Type	RSRZ
2	B	69	GLN	2.4
1	C	102	ASP	2.4
1	A	101	ASP	2.3
1	C	241	GLN	2.3
1	E	395	ASN	2.3
2	D	69	GLN	2.3
2	D	33	THR	2.2
1	G	239	THR	2.2
1	A	241	GLN	2.1
2	F	68	ARG	2.1
1	G	221	ILE	2.1
1	E	250	HIS	2.1
1	G	227	GLU	2.1
2	F	69	GLN	2.1
1	G	252	HIS	2.1
1	A	395	ASN	2.1
1	G	104	GLU	2.0
1	A	99	TRP	2.0
1	C	521	GLU	2.0
1	C	524	ASP	2.0

6.2 Non-standard residues in protein, DNA, RNA chains [i](#)

There are no non-standard protein/DNA/RNA residues in this entry.

6.3 Carbohydrates [i](#)

There are no carbohydrates in this entry.

6.4 Ligands [i](#)

There are no ligands in this entry.

6.5 Other polymers [i](#)

There are no such residues in this entry.