



# Full wwPDB X-ray Structure Validation Report ⓘ

Nov 11, 2023 – 08:12 am GMT

PDB ID : 2VD6  
Title : Human adenylosuccinate lyase in complex with its substrate N6-(1,2-Dicarboxyethyl)-AMP, and its products AMP and fumarate.  
Authors : Stenmark, P.; Moche, M.; Arrowsmith, C.; Berglund, H.; Busam, R.; Collins, R.; Dahlgren, L.G.; Edwards, A.; Flodin, S.; Flores, A.; Graslund, S.; Hammarstrom, M.; Hallberg, B.M.; Holmberg-schiavone, L.; Johansson, I.; Kallas, A.; Karlberg, T.; Kotenyova, T.; Lehtio, L.; Nilsson, M.; Nyman, T.; Ogg, D.; Persson, C.; Sagemark, J.; Sundstrom, M.; Thorsell, A.G.; Tresaugues, L.; van den Berg, S.; Weigelt, J.; Welin, M.; Nordlund, P.; Structural Genomics Consortium (SGC)  
Deposited on : 2007-09-30  
Resolution : 2.00 Å(reported)

This is a Full wwPDB X-ray Structure Validation Report for a publicly released PDB entry.

We welcome your comments at [validation@mail.wwpdb.org](mailto:validation@mail.wwpdb.org)

A user guide is available at

<https://www.wwpdb.org/validation/2017/XrayValidationReportHelp>

with specific help available everywhere you see the ⓘ symbol.

The types of validation reports are described at

<http://www.wwpdb.org/validation/2017/FAQs#types>.

---

The following versions of software and data (see [references ⓘ](#)) were used in the production of this report:

MolProbity : 4.02b-467  
Mogul : 1.8.4, CSD as541be (2020)  
Xtriage (Phenix) : 1.13  
EDS : 2.36  
buster-report : 1.1.7 (2018)  
Percentile statistics : 20191225.v01 (using entries in the PDB archive December 25th 2019)

# 1 Overall quality at a glance

The following experimental techniques were used to determine the structure:

*X-RAY DIFFRACTION*

The reported resolution of this entry is 2.00 Å.

Percentile scores (ranging between 0-100) for global validation metrics of the entry are shown in the following graphic. The table shows the number of entries on which the scores are based.

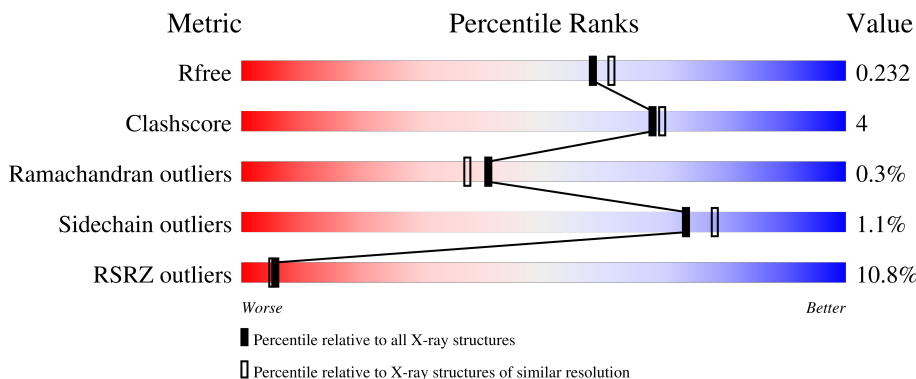

Metric	Whole archive (#Entries)	Similar resolution (#Entries, resolution range(Å))
$R_{free}$	130704	8085 (2.00-2.00)
Clashscore	141614	9178 (2.00-2.00)
Ramachandran outliers	138981	9054 (2.00-2.00)
Sidechain outliers	138945	9053 (2.00-2.00)
RSRZ outliers	127900	7900 (2.00-2.00)



The table below summarises the geometric issues observed across the polymeric chains and their fit to the electron density. The red, orange, yellow and green segments of the lower bar indicate the fraction of residues that contain outliers for  $\geq 3$ , 2, 1 and 0 types of geometric quality criteria respectively. A grey segment represents the fraction of residues that are not modelled. The numeric value for each fraction is indicated below the corresponding segment, with a dot representing fractions  $\leq 5\%$ . The upper red bar (where present) indicates the fraction of residues that have poor fit to the electron density. The numeric value is given above the bar.

Mol	Chain	Length	Quality of chain
1	A	503	
1	B	503	

*Continued on next page...*

Refmac : 5.8.0158  
 CCP4 : 7.0.044 (Gargrove)  
 Ideal geometry (proteins) : Engh & Huber (2001)  
 Ideal geometry (DNA, RNA) : Parkinson et al. (1996)  
 Validation Pipeline (wwPDB-VP) : 2.36

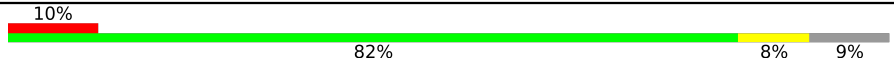
*Continued from previous page...*

Mol	Chain	Length	Quality of chain
1	C	503	 <p>10% 82% 8% 9%</p>
1	D	503	 <p>11% 84% 7% 8%</p>

## 2 Entry composition i

There are 7 unique types of molecules in this entry. The entry contains 15817 atoms, of which 0 are hydrogens and 0 are deuteriums.

In the tables below, the ZeroOcc column contains the number of atoms modelled with zero occupancy, the AltConf column contains the number of residues with at least one atom in alternate conformation and the Trace column contains the number of residues modelled with at most 2 atoms.

- Molecule 1 is a protein called ADENYLOSUCCINATE LYASE.

Mol	Chain	Residues	Atoms					ZeroOcc	AltConf	Trace
			Total	C	N	O	S			
1	A	461	Total 3706	C 2333	N 657	O 690	S 26	0	4	0
1	B	461	Total 3685	C 2322	N 654	O 683	S 26	0	1	0
1	C	457	Total 3681	C 2318	N 656	O 682	S 25	0	4	0
1	D	462	Total 3704	C 2334	N 657	O 687	S 26	0	3	0

There are 88 discrepancies between the modelled and reference sequences:

Chain	Residue	Modelled	Actual	Comment	Reference
A	-21	MET	-	expression tag	UNP P30566
A	-20	HIS	-	expression tag	UNP P30566
A	-19	HIS	-	expression tag	UNP P30566
A	-18	HIS	-	expression tag	UNP P30566
A	-17	HIS	-	expression tag	UNP P30566
A	-16	HIS	-	expression tag	UNP P30566
A	-15	HIS	-	expression tag	UNP P30566
A	-14	SER	-	expression tag	UNP P30566
A	-13	SER	-	expression tag	UNP P30566
A	-12	GLY	-	expression tag	UNP P30566
A	-11	VAL	-	expression tag	UNP P30566
A	-10	ASP	-	expression tag	UNP P30566
A	-9	LEU	-	expression tag	UNP P30566
A	-8	GLY	-	expression tag	UNP P30566
A	-7	THR	-	expression tag	UNP P30566
A	-6	GLU	-	expression tag	UNP P30566
A	-5	ASN	-	expression tag	UNP P30566
A	-4	LEU	-	expression tag	UNP P30566
A	-3	TYR	-	expression tag	UNP P30566
A	-2	PHE	-	expression tag	UNP P30566
A	-1	GLN	-	expression tag	UNP P30566

*Continued on next page...*

*Continued from previous page...*

Chain	Residue	Modelled	Actual	Comment	Reference
A	0	SER	-	expression tag	UNP P30566
B	-21	MET	-	expression tag	UNP P30566
B	-20	HIS	-	expression tag	UNP P30566
B	-19	HIS	-	expression tag	UNP P30566
B	-18	HIS	-	expression tag	UNP P30566
B	-17	HIS	-	expression tag	UNP P30566
B	-16	HIS	-	expression tag	UNP P30566
B	-15	HIS	-	expression tag	UNP P30566
B	-14	SER	-	expression tag	UNP P30566
B	-13	SER	-	expression tag	UNP P30566
B	-12	GLY	-	expression tag	UNP P30566
B	-11	VAL	-	expression tag	UNP P30566
B	-10	ASP	-	expression tag	UNP P30566
B	-9	LEU	-	expression tag	UNP P30566
B	-8	GLY	-	expression tag	UNP P30566
B	-7	THR	-	expression tag	UNP P30566
B	-6	GLU	-	expression tag	UNP P30566
B	-5	ASN	-	expression tag	UNP P30566
B	-4	LEU	-	expression tag	UNP P30566
B	-3	TYR	-	expression tag	UNP P30566
B	-2	PHE	-	expression tag	UNP P30566
B	-1	GLN	-	expression tag	UNP P30566
B	0	SER	-	expression tag	UNP P30566
C	-21	MET	-	expression tag	UNP P30566
C	-20	HIS	-	expression tag	UNP P30566
C	-19	HIS	-	expression tag	UNP P30566
C	-18	HIS	-	expression tag	UNP P30566
C	-17	HIS	-	expression tag	UNP P30566
C	-16	HIS	-	expression tag	UNP P30566
C	-15	HIS	-	expression tag	UNP P30566
C	-14	SER	-	expression tag	UNP P30566
C	-13	SER	-	expression tag	UNP P30566
C	-12	GLY	-	expression tag	UNP P30566
C	-11	VAL	-	expression tag	UNP P30566
C	-10	ASP	-	expression tag	UNP P30566
C	-9	LEU	-	expression tag	UNP P30566
C	-8	GLY	-	expression tag	UNP P30566
C	-7	THR	-	expression tag	UNP P30566
C	-6	GLU	-	expression tag	UNP P30566
C	-5	ASN	-	expression tag	UNP P30566
C	-4	LEU	-	expression tag	UNP P30566
C	-3	TYR	-	expression tag	UNP P30566

*Continued on next page...*

Continued from previous page...

Chain	Residue	Modelled	Actual	Comment	Reference
C	-2	PHE	-	expression tag	UNP P30566
C	-1	GLN	-	expression tag	UNP P30566
C	0	SER	-	expression tag	UNP P30566
D	-21	MET	-	expression tag	UNP P30566
D	-20	HIS	-	expression tag	UNP P30566
D	-19	HIS	-	expression tag	UNP P30566
D	-18	HIS	-	expression tag	UNP P30566
D	-17	HIS	-	expression tag	UNP P30566
D	-16	HIS	-	expression tag	UNP P30566
D	-15	HIS	-	expression tag	UNP P30566
D	-14	SER	-	expression tag	UNP P30566
D	-13	SER	-	expression tag	UNP P30566
D	-12	GLY	-	expression tag	UNP P30566
D	-11	VAL	-	expression tag	UNP P30566
D	-10	ASP	-	expression tag	UNP P30566
D	-9	LEU	-	expression tag	UNP P30566
D	-8	GLY	-	expression tag	UNP P30566
D	-7	THR	-	expression tag	UNP P30566
D	-6	GLU	-	expression tag	UNP P30566
D	-5	ASN	-	expression tag	UNP P30566
D	-4	LEU	-	expression tag	UNP P30566
D	-3	TYR	-	expression tag	UNP P30566
D	-2	PHE	-	expression tag	UNP P30566
D	-1	GLN	-	expression tag	UNP P30566
D	0	SER	-	expression tag	UNP P30566

- Molecule 2 is ADENOSINE MONOPHOSPHATE (three-letter code: AMP) (formula: C<sub>10</sub>H<sub>14</sub>N<sub>5</sub>O<sub>7</sub>P).

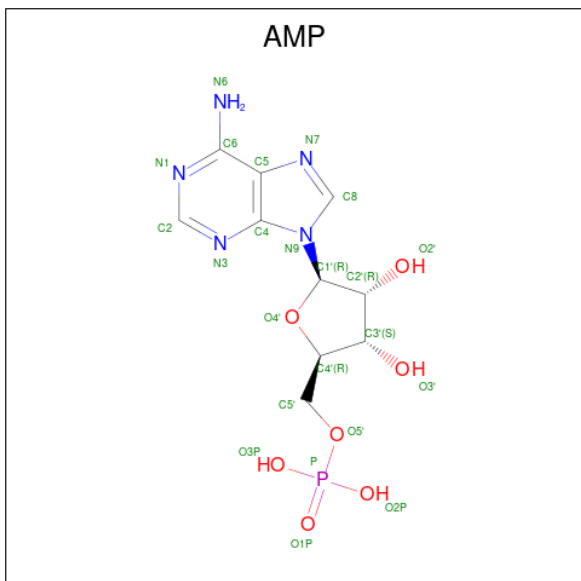

Mol	Chain	Residues	Atoms					ZeroOcc	AltConf
2	A	1	Total	C	N	O	P	0	0
			23	10	5	7	1		
2	C	1	Total	C	N	O	P	0	0
			23	10	5	7	1		

- Molecule 3 is FUMARIC ACID (three-letter code: FUM) (formula: C<sub>4</sub>H<sub>4</sub>O<sub>4</sub>).

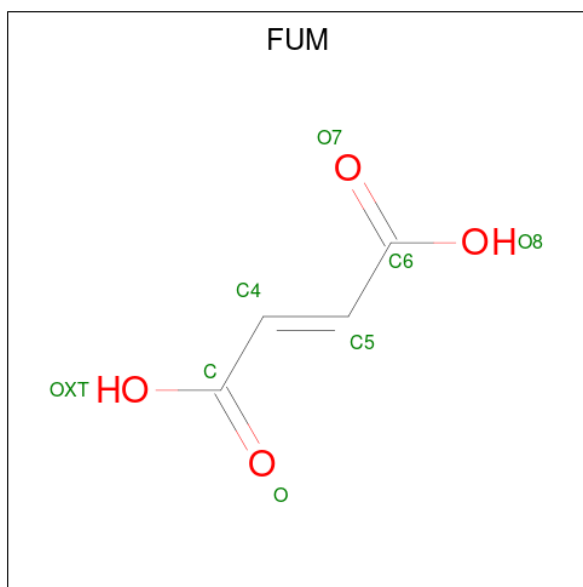

Mol	Chain	Residues	Atoms			ZeroOcc	AltConf
3	A	1	Total	C	O	0	0
			8	4	4		
3	C	1	Total	C	O	0	0
			8	4	4		

- Molecule 4 is GLYCEROL (three-letter code: GOL) (formula: C<sub>3</sub>H<sub>8</sub>O<sub>3</sub>).



Mol	Chain	Residues	Atoms	ZeroOcc	AltConf
4	A	1	Total C O 6 3 3	0	0
4	B	1	Total C O 6 3 3	0	0
4	B	1	Total C O 6 3 3	0	0
4	C	1	Total C O 6 3 3	0	0
4	D	1	Total C O 6 3 3	0	0

- Molecule 5 is CHLORIDE ION (three-letter code: CL) (formula: Cl).

Mol	Chain	Residues	Atoms	ZeroOcc	AltConf
5	A	2	Total Cl 2 2	0	0
5	B	2	Total Cl 2 2	0	0
5	C	1	Total Cl 1 1	0	0
5	D	2	Total Cl 2 2	0	0

- Molecule 6 is 2-[9-(3,4-DIHYDROXY-5-PHOSPHONOXYMETHYL-TETRAHYDRO-FURAN-2-YL)-9H-PURIN-6-YLAMINO]-SUCCINIC ACID (three-letter code: 2SA) (formula: C<sub>14</sub>H<sub>18</sub>N<sub>5</sub>O<sub>11</sub>P).



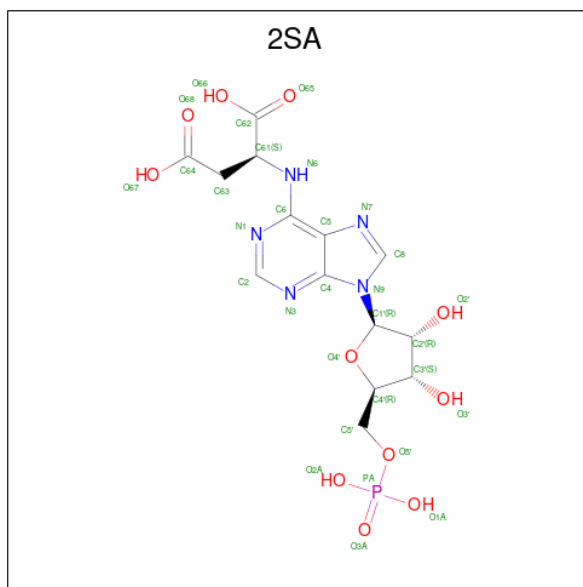

Mol	Chain	Residues	Atoms					ZeroOcc	AltConf
6	B	1	Total	C	N	O	P	0	0
			31	14	5	11	1		
6	D	1	Total	C	N	O	P	0	0
			31	14	5	11	1		

- Molecule 7 is water.

Mol	Chain	Residues	Atoms		ZeroOcc	AltConf
7	A	247	Total	O	0	0
			247	247		
7	B	158	Total	O	0	0
			158	158		
7	C	235	Total	O	0	0
			235	235		
7	D	240	Total	O	0	0
			240	240		

### 3 Residue-property plots [i](#)

These plots are drawn for all protein, RNA, DNA and oligosaccharide chains in the entry. The first graphic for a chain summarises the proportions of the various outlier classes displayed in the second graphic. The second graphic shows the sequence view annotated by issues in geometry and electron density. Residues are color-coded according to the number of geometric quality criteria for which they contain at least one outlier: green = 0, yellow = 1, orange = 2 and red = 3 or more. A red dot above a residue indicates a poor fit to the electron density ( $RSRZ > 2$ ). Stretches of 2 or more consecutive residues without any outlier are shown as a green connector. Residues present in the sample, but not in the model, are shown in grey.

#### • Molecule 1: ADENYLOSUCCINATE LYASE

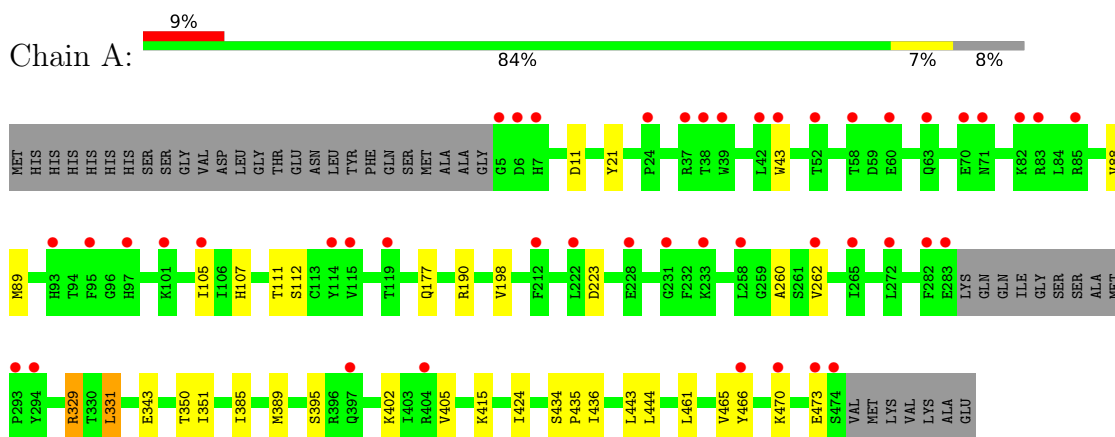

#### • Molecule 1: ADENYLOSUCCINATE LYASE

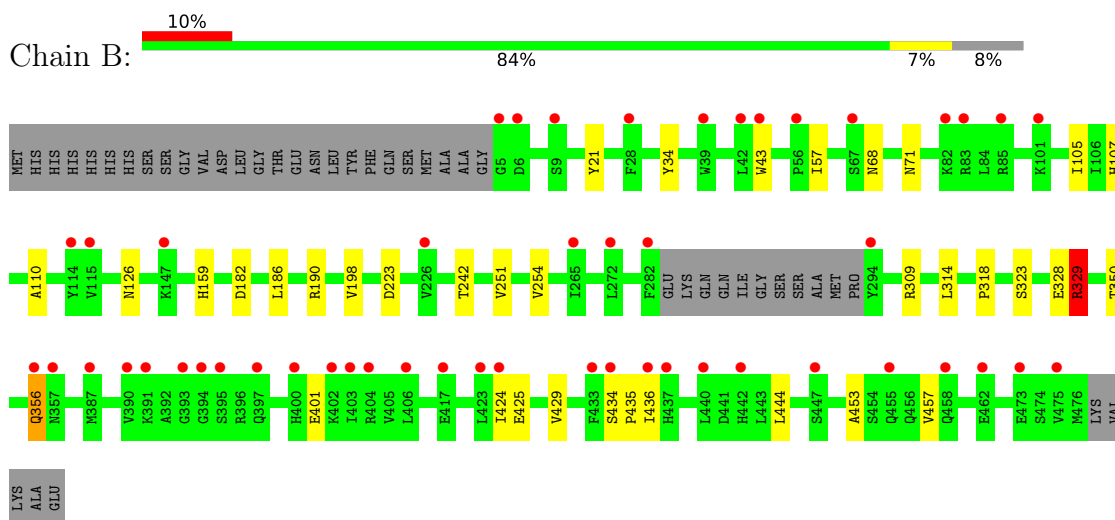

#### • Molecule 1: ADENYLOSUCCINATE LYASE

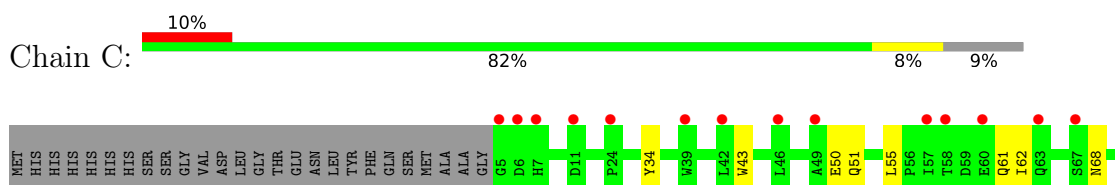

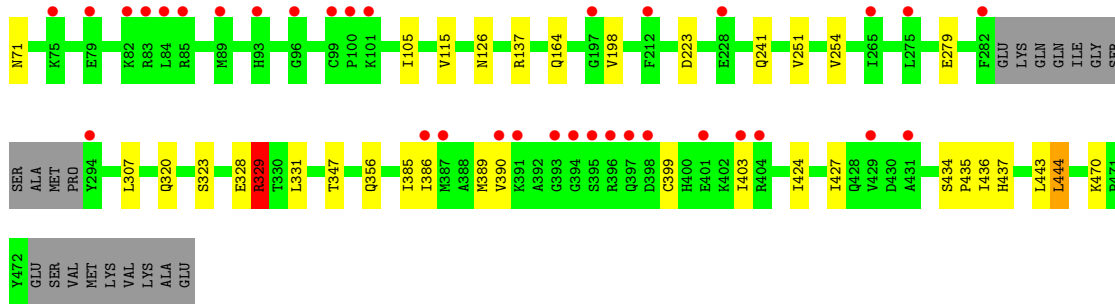

● Molecule 1: ADENYLOSUCCINATE LYASE

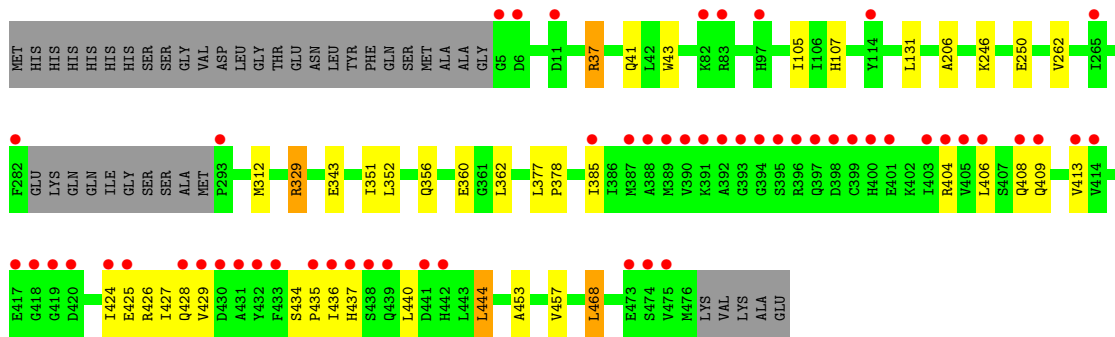
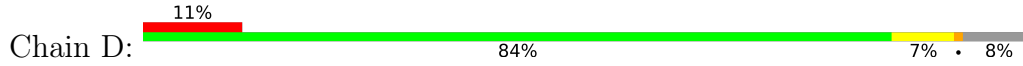

## 4 Data and refinement statistics

Property	Value	Source
Space group	P 21 21 21	Depositor
Cell constants a, b, c, $\alpha$ , $\beta$ , $\gamma$	87.30Å 128.10Å 190.50Å 90.00° 90.00° 90.00°	Depositor
Resolution (Å)	50.00 – 2.00 24.83 – 2.00	Depositor EDS
% Data completeness (in resolution range)	99.8 (50.00-2.00) 99.8 (24.83-2.00)	Depositor EDS
$R_{merge}$	0.06	Depositor
$R_{sym}$	(Not available)	Depositor
$\langle I/\sigma(I) \rangle$ <sup>1</sup>	3.95 (at 1.99Å)	Xtrriage
Refinement program	REFMAC 5.3.0040	Depositor
R, $R_{free}$	0.192 , 0.229 0.197 , 0.232	Depositor DCC
$R_{free}$ test set	7207 reflections (5.00%)	wwPDB-VP
Wilson B-factor (Å <sup>2</sup> )	26.0	Xtrriage
Anisotropy	0.174	Xtrriage
Bulk solvent $k_{sol}$ (e/Å <sup>3</sup> ), $B_{sol}$ (Å <sup>2</sup> )	0.36 , 59.2	EDS
L-test for twinning <sup>2</sup>	$\langle  L  \rangle = 0.49$ , $\langle L^2 \rangle = 0.32$	Xtrriage
Estimated twinning fraction	No twinning to report.	Xtrriage
$F_o, F_c$ correlation	0.94	EDS
Total number of atoms	15817	wwPDB-VP
Average B, all atoms (Å <sup>2</sup> )	35.0	wwPDB-VP

Xtrriage's analysis on translational NCS is as follows: *The largest off-origin peak in the Patterson function is 2.43% of the height of the origin peak. No significant pseudotranslation is detected.*

<sup>1</sup>Intensities estimated from amplitudes.

<sup>2</sup>Theoretical values of  $\langle |L| \rangle$ ,  $\langle L^2 \rangle$  for acentric reflections are 0.5, 0.333 respectively for untwinned datasets, and 0.375, 0.2 for perfectly twinned datasets.

## 5 Model quality i

### 5.1 Standard geometry i

Bond lengths and bond angles in the following residue types are not validated in this section: CL, AMP, 2SA, GOL, FUM

The Z score for a bond length (or angle) is the number of standard deviations the observed value is removed from the expected value. A bond length (or angle) with  $|Z| > 5$  is considered an outlier worth inspection. RMSZ is the root-mean-square of all Z scores of the bond lengths (or angles).

Mol	Chain	Bond lengths		Bond angles	
		RMSZ	# $ Z  > 5$	RMSZ	# $ Z  > 5$
1	A	0.45	0/3778	0.58	0/5101
1	B	0.38	0/3756	0.53	0/5071
1	C	0.45	2/3752 (0.1%)	0.58	0/5066
1	D	0.40	0/3779	0.57	0/5102
All	All	0.42	2/15065 (0.0%)	0.56	0/20340

All (2) bond length outliers are listed below:

Mol	Chain	Res	Type	Atoms	Z	Observed(Å)	Ideal(Å)
1	C	61	GLN	CD-OE1	6.87	1.39	1.24
1	C	61	GLN	CD-NE2	5.36	1.46	1.32

There are no bond angle outliers.

There are no chirality outliers.

There are no planarity outliers.

### 5.2 Too-close contacts i

In the following table, the Non-H and H(model) columns list the number of non-hydrogen atoms and hydrogen atoms in the chain respectively. The H(added) column lists the number of hydrogen atoms added and optimized by MolProbity. The Clashes column lists the number of clashes within the asymmetric unit, whereas Symm-Clashes lists symmetry-related clashes.

Mol	Chain	Non-H	H(model)	H(added)	Clashes	Symm-Clashes
1	A	3706	0	3711	31	0
1	B	3685	0	3698	28	0
1	C	3681	0	3689	30	0
1	D	3704	0	3718	27	0
2	A	23	0	12	3	0

*Continued on next page...*

*Continued from previous page...*

Mol	Chain	Non-H	H(model)	H(added)	Clashes	Symm-Clashes
2	C	23	0	12	3	0
3	A	8	0	1	2	0
3	C	8	0	1	2	0
4	A	6	0	8	0	0
4	B	12	0	16	0	0
4	C	6	0	8	0	0
4	D	6	0	8	0	0
5	A	2	0	0	0	0
5	B	2	0	0	0	0
5	C	1	0	0	0	0
5	D	2	0	0	0	0
6	B	31	0	14	1	0
6	D	31	0	14	1	0
7	A	247	0	0	3	0
7	B	158	0	0	0	0
7	C	235	0	0	0	0
7	D	240	0	0	1	0
All	All	15817	0	14910	114	0

The all-atom clashscore is defined as the number of clashes found per 1000 atoms (including hydrogen atoms). The all-atom clashscore for this structure is 4.

All (114) close contacts within the same asymmetric unit are listed below, sorted by their clash magnitude.

Atom-1	Atom-2	Interatomic distance (Å)	Clash overlap (Å)
1:B:328:GLU:O	1:B:329:ARG:HB2	1.64	0.98
1:B:424:ILE:CD1	1:B:444:LEU:HD11	2.04	0.88
1:D:424:ILE:HD12	1:D:444:LEU:HD21	1.58	0.86
1:A:424:ILE:HD12	1:A:444:LEU:HD11	1.60	0.84
1:A:331:LEU:HD13	1:B:159:HIS:CE1	2.16	0.81
1:B:424:ILE:HD12	1:B:444:LEU:HD11	1.61	0.80
1:A:424:ILE:CD1	1:A:444:LEU:HD11	2.16	0.76
1:B:57:ILE:HG23	1:B:105:ILE:HD13	1.68	0.75
1:C:164[B]:GLN:NE2	1:D:206:ALA:HB3	2.04	0.72
1:A:385:ILE:HG23	1:A:436:ILE:CD1	2.20	0.72
1:C:385:ILE:HG23	1:C:436:ILE:CD1	2.26	0.65
1:A:343:GLU:OE2	1:D:343:GLU:OE2	2.15	0.64
1:D:43:TRP:HE1	1:D:107:HIS:CD2	2.17	0.62
1:B:424:ILE:HD11	1:B:444:LEU:HD11	1.80	0.61
1:D:43:TRP:HE1	1:D:107:HIS:HD2	1.49	0.61
1:B:424:ILE:CD1	1:B:444:LEU:CD1	2.78	0.60

*Continued on next page...*

*Continued from previous page...*

Atom-1	Atom-2	Interatomic distance (Å)	Clash overlap (Å)
1:D:425:GLU:O	1:D:429:VAL:HG22	2.04	0.58
1:D:385:ILE:HD13	1:D:427:ILE:HD13	1.85	0.58
1:C:34:TYR:OH	1:C:126:ASN:ND2	2.37	0.57
1:C:403:ILE:HD11	1:C:427:ILE:HD11	1.86	0.56
1:D:37:ARG:HH12	1:D:41:GLN:HE21	1.54	0.56
1:D:406:LEU:HD22	1:D:426:ARG:HB3	1.88	0.55
1:B:424:ILE:HD12	1:B:444:LEU:CD1	2.33	0.55
1:A:111:THR:HG22	7:A:2054:HOH:O	2.05	0.55
1:B:68:ASN:ND2	1:B:71:ASN:HD22	2.05	0.54
1:A:415:LYS:NZ	1:C:279:GLU:OE2	2.32	0.54
1:A:105:ILE:C	1:A:105:ILE:HD12	2.29	0.53
1:C:403:ILE:HD11	1:C:427:ILE:CD1	2.39	0.52
1:B:43:TRP:HE1	1:B:107:HIS:CD2	2.27	0.52
1:B:242:THR:HG23	1:B:329:ARG:HG3	1.91	0.51
1:A:385:ILE:HG23	1:A:436:ILE:HD11	1.92	0.51
2:C:1000:AMP:N6	3:C:1001:FUM:C4	2.73	0.51
1:C:328:GLU:O	1:C:329:ARG:HB3	2.10	0.51
1:A:88:VAL:HG21	1:A:112:SER:HB3	1.94	0.49
1:A:88:VAL:HG12	1:A:89[B]:MET:HE2	1.94	0.49
1:A:331:LEU:HD13	1:B:159:HIS:NE2	2.27	0.49
1:D:429:VAL:O	1:D:429:VAL:HG23	2.11	0.49
1:D:424:ILE:CD1	1:D:444:LEU:HD21	2.37	0.49
1:A:385:ILE:HG23	1:A:436:ILE:HD12	1.92	0.48
1:A:389:MET:HG2	1:A:436:ILE:HD13	1.95	0.48
1:A:402:LYS:O	1:A:405:VAL:HG22	2.14	0.48
1:C:389:MET:HG2	1:C:436:ILE:HD13	1.96	0.48
1:D:105:ILE:C	1:D:105:ILE:HD12	2.35	0.47
1:C:385:ILE:HG23	1:C:436:ILE:HD12	1.93	0.47
1:B:198:VAL:HG22	1:B:223:ASP:HA	1.96	0.47
1:C:424:ILE:HD12	1:C:444:LEU:CD1	2.43	0.47
1:C:68:ASN:ND2	1:C:71:ASN:HD22	2.13	0.47
1:A:466:TYR:HE1	7:A:2247:HOH:O	1.97	0.47
1:C:251:VAL:O	1:C:254:VAL:HG22	2.15	0.47
1:B:107:HIS:CD2	1:B:110:ALA:HB3	2.50	0.47
6:B:1002:2SA:N7	6:B:1002:2SA:H61	2.30	0.47
2:C:1000:AMP:N6	3:C:1001:FUM:C5	2.78	0.46
1:D:409:GLN:O	1:D:413:VAL:HG23	2.15	0.46
1:C:137:ARG:HD2	1:C:356[A]:GLN:NE2	2.30	0.46
1:C:434:SER:N	1:C:435:PRO:CD	2.78	0.46
1:D:468:LEU:HD13	7:D:2236:HOH:O	2.14	0.46
1:D:404:ARG:O	1:D:408:GLN:HG2	2.16	0.46

*Continued on next page...*

*Continued from previous page...*

Atom-1	Atom-2	Interatomic distance (Å)	Clash overlap (Å)
1:D:428:GLN:HG3	1:D:440:LEU:HD13	1.98	0.46
2:A:1000:AMP:N6	3:A:1001:FUM:C4	2.79	0.45
1:D:434:SER:N	1:D:435:PRO:CD	2.79	0.45
1:D:246:LYS:O	1:D:250:GLU:HG2	2.16	0.45
1:A:385:ILE:HD12	1:A:443:LEU:HD13	1.98	0.45
1:A:260:ALA:HA	1:B:323[B]:SER:OG	2.17	0.45
1:B:436:ILE:O	1:B:436:ILE:HG23	2.16	0.45
1:D:262:VAL:HG11	1:D:351:ILE:CG2	2.48	0.44
1:C:385:ILE:HD13	1:C:443:LEU:HD13	2.00	0.44
1:B:34:TYR:OH	1:B:126:ASN:ND2	2.46	0.43
6:D:1002:2SA:H61	6:D:1002:2SA:N7	2.33	0.43
1:C:434:SER:HA	1:C:437:HIS:ND1	2.34	0.43
1:C:424:ILE:HD12	1:C:444:LEU:HD13	2.01	0.43
1:D:434:SER:HA	1:D:437:HIS:ND1	2.34	0.43
1:B:434:SER:N	1:B:435:PRO:CD	2.82	0.43
1:D:436:ILE:C	1:D:436:ILE:HD12	2.39	0.43
1:C:43:TRP:CE2	1:C:115:VAL:HG11	2.54	0.43
1:C:105:ILE:C	1:C:105:ILE:HD12	2.39	0.43
1:A:21:TYR:HB3	1:A:350:THR:HG21	2.00	0.42
1:C:198:VAL:HG22	1:C:223:ASP:HA	2.00	0.42
1:C:389:MET:HG3	1:C:399:CYS:SG	2.59	0.42
1:B:309:ARG:HD3	1:C:320:GLN:HB2	2.01	0.42
1:C:386:ILE:O	1:C:390:VAL:HG23	2.20	0.42
1:A:111:THR:HG22	1:A:112:SER:N	2.34	0.42
1:B:436:ILE:O	1:B:436:ILE:CG2	2.66	0.42
1:A:177:GLN:NE2	7:A:2096:HOH:O	2.53	0.42
2:A:1000:AMP:N6	3:A:1001:FUM:C5	2.83	0.42
1:B:425:GLU:O	1:B:429:VAL:HG22	2.19	0.42
1:D:377:LEU:N	1:D:378:PRO:CD	2.83	0.42
1:A:111:THR:HG22	1:A:112:SER:H	1.85	0.42
1:D:356[A]:GLN:NE2	1:D:360:GLU:OE2	2.52	0.42
1:A:461:LEU:HD23	1:A:465:VAL:HG21	2.01	0.42
1:D:131:LEU:HD22	1:D:352:LEU:HD12	2.02	0.42
1:A:424:ILE:CD1	1:A:444:LEU:CD1	2.95	0.41
1:B:182:ASP:O	1:B:186:LEU:HD13	2.19	0.41
1:A:43:TRP:HE1	1:A:107:HIS:CD2	2.37	0.41
1:A:331:LEU:HD21	2:A:1000:AMP:C4	2.54	0.41
1:B:314:LEU:O	1:B:318:PRO:HD2	2.21	0.41
1:D:453:ALA:O	1:D:457:VAL:HG23	2.20	0.41
1:A:43:TRP:HE1	1:A:107:HIS:HD2	1.68	0.41
1:C:50:GLU:HB3	1:C:55:LEU:HD12	2.02	0.41

*Continued on next page...*



Continued from previous page...

Atom-1	Atom-2	Interatomic distance (Å)	Clash overlap (Å)
1:A:262:VAL:HG11	1:A:351:ILE:CG2	2.50	0.41
1:B:453:ALA:O	1:B:457:VAL:HG23	2.20	0.41
1:C:307:LEU:HB3	1:C:347:THR:HG23	2.03	0.41
1:D:37:ARG:HH12	1:D:41:GLN:NE2	2.19	0.41
1:A:198:VAL:HG22	1:A:223:ASP:HA	2.02	0.41
1:B:251:VAL:O	1:B:254:VAL:HG22	2.20	0.41
1:A:88:VAL:HG12	1:A:89[B]:MET:CE	2.51	0.41
1:A:434[B]:SER:N	1:A:435:PRO:CD	2.83	0.41
1:C:331:LEU:HD21	2:C:1000:AMP:C6	2.56	0.40
1:C:51:GLN:OE1	1:C:62:ILE:HD12	2.20	0.40
1:B:21:TYR:HB3	1:B:350:THR:HG21	2.04	0.40
1:B:242:THR:HG23	1:B:329:ARG:CG	2.52	0.40
1:B:356:GLN:HE21	1:B:356:GLN:HA	1.87	0.40
1:C:323[B]:SER:OG	1:D:312:MET:SD	2.79	0.40
1:C:328:GLU:O	1:C:329:ARG:CB	2.69	0.40
1:C:241:GLN:HB3	1:C:329:ARG:HG2	2.04	0.40

There are no symmetry-related clashes.

## 5.3 Torsion angles [i](#)

### 5.3.1 Protein backbone [i](#)

In the following table, the Percentiles column shows the percent Ramachandran outliers of the chain as a percentile score with respect to all X-ray entries followed by that with respect to entries of similar resolution.

The Analysed column shows the number of residues for which the backbone conformation was analysed, and the total number of residues.

Mol	Chain	Analysed	Favoured	Allowed	Outliers	Percentiles	
1	A	461/503 (92%)	450 (98%)	9 (2%)	2 (0%)	34	30
1	B	458/503 (91%)	449 (98%)	8 (2%)	1 (0%)	47	44
1	C	457/503 (91%)	451 (99%)	5 (1%)	1 (0%)	47	44
1	D	461/503 (92%)	450 (98%)	10 (2%)	1 (0%)	47	44
All	All	1837/2012 (91%)	1800 (98%)	32 (2%)	5 (0%)	41	37

All (5) Ramachandran outliers are listed below:

Mol	Chain	Res	Type
1	A	329	ARG
1	B	329	ARG
1	C	329	ARG
1	D	329	ARG
1	A	473	GLU

### 5.3.2 Protein sidechains [i](#)

In the following table, the Percentiles column shows the percent sidechain outliers of the chain as a percentile score with respect to all X-ray entries followed by that with respect to entries of similar resolution.

The Analysed column shows the number of residues for which the sidechain conformation was analysed, and the total number of residues.

Mol	Chain	Analysed	Rotameric	Outliers	Percentiles	
1	A	408/438 (93%)	402 (98%)	6 (2%)	65	69
1	B	405/438 (92%)	401 (99%)	4 (1%)	76	81
1	C	404/438 (92%)	401 (99%)	3 (1%)	84	88
1	D	408/438 (93%)	403 (99%)	5 (1%)	71	76
All	All	1625/1752 (93%)	1607 (99%)	18 (1%)	73	78

All (18) residues with a non-rotameric sidechain are listed below:

Mol	Chain	Res	Type
1	A	11	ASP
1	A	190	ARG
1	A	329	ARG
1	A	331	LEU
1	A	395	SER
1	A	470	LYS
1	B	190	ARG
1	B	329	ARG
1	B	356	GLN
1	B	401	GLU
1	C	329	ARG
1	C	444	LEU
1	C	470	LYS
1	D	37	ARG
1	D	329	ARG
1	D	362	LEU
1	D	444	LEU

*Continued on next page...*

*Continued from previous page...*

Mol	Chain	Res	Type
1	D	468	LEU

Sometimes sidechains can be flipped to improve hydrogen bonding and reduce clashes. All (19) such sidechains are listed below:

Mol	Chain	Res	Type
1	A	68	ASN
1	A	107	HIS
1	A	164	GLN
1	A	177	GLN
1	A	408	GLN
1	B	68	ASN
1	B	107	HIS
1	B	177	GLN
1	B	356	GLN
1	B	455	GLN
1	C	68	ASN
1	C	97	HIS
1	C	126	ASN
1	D	41	GLN
1	D	107	HIS
1	D	126	ASN
1	D	210	GLN
1	D	375	GLN
1	D	408	GLN

### 5.3.3 RNA [i](#)

There are no RNA molecules in this entry.

### 5.4 Non-standard residues in protein, DNA, RNA chains [i](#)

There are no non-standard protein/DNA/RNA residues in this entry.

### 5.5 Carbohydrates [i](#)

There are no monosaccharides in this entry.

## 5.6 Ligand geometry

Of 18 ligands modelled in this entry, 7 are monoatomic - leaving 11 for Mogul analysis.

In the following table, the Counts columns list the number of bonds (or angles) for which Mogul statistics could be retrieved, the number of bonds (or angles) that are observed in the model and the number of bonds (or angles) that are defined in the Chemical Component Dictionary. The Link column lists molecule types, if any, to which the group is linked. The Z score for a bond length (or angle) is the number of standard deviations the observed value is removed from the expected value. A bond length (or angle) with  $|Z| > 2$  is considered an outlier worth inspection. RMSZ is the root-mean-square of all Z scores of the bond lengths (or angles).

Mol	Type	Chain	Res	Link	Bond lengths			Bond angles		
					Counts	RMSZ	# Z  > 2	Counts	RMSZ	# Z  > 2
4	GOL	D	1003	-	5,5,5	0.32	0	5,5,5	0.33	0
3	FUM	A	1001	-	7,7,7	1.13	0	8,8,8	0.91	0
3	FUM	C	1001	-	7,7,7	1.07	0	8,8,8	0.93	0
6	2SA	B	1002	-	28,33,33	0.82	0	33,49,49	1.70	4 (12%)
2	AMP	C	1000	-	22,25,25	1.00	2 (9%)	25,38,38	1.38	3 (12%)
4	GOL	A	1003	-	5,5,5	0.27	0	5,5,5	0.24	0
6	2SA	D	1002	-	28,33,33	0.98	1 (3%)	33,49,49	1.78	3 (9%)
4	GOL	C	1003	-	5,5,5	0.40	0	5,5,5	0.18	0
2	AMP	A	1000	-	22,25,25	1.04	2 (9%)	25,38,38	1.41	3 (12%)
4	GOL	B	1003	-	5,5,5	0.29	0	5,5,5	0.39	0
4	GOL	B	1004	-	5,5,5	0.40	0	5,5,5	0.57	0

In the following table, the Chirals column lists the number of chiral outliers, the number of chiral centers analysed, the number of these observed in the model and the number defined in the Chemical Component Dictionary. Similar counts are reported in the Torsion and Rings columns. '-' means no outliers of that kind were identified.

Mol	Type	Chain	Res	Link	Chirals	Torsions	Rings
4	GOL	D	1003	-	-	2/4/4/4	-
3	FUM	A	1001	-	-	0/5/5/5	-
3	FUM	C	1001	-	-	0/5/5/5	-
6	2SA	B	1002	-	-	5/18/38/38	0/3/3/3
2	AMP	C	1000	-	-	1/6/26/26	0/3/3/3
4	GOL	A	1003	-	-	0/4/4/4	-
6	2SA	D	1002	-	-	3/18/38/38	0/3/3/3
4	GOL	C	1003	-	-	2/4/4/4	-
2	AMP	A	1000	-	-	1/6/26/26	0/3/3/3
4	GOL	B	1003	-	-	2/4/4/4	-
4	GOL	B	1004	-	-	4/4/4/4	-

All (5) bond length outliers are listed below:

Mol	Chain	Res	Type	Atoms	Z	Observed(Å)	Ideal(Å)
2	C	1000	AMP	O4'-C1'	2.41	1.44	1.41
2	A	1000	AMP	O4'-C1'	2.31	1.44	1.41
2	A	1000	AMP	C2-N3	2.24	1.35	1.32
6	D	1002	2SA	C2-N3	2.22	1.35	1.32
2	C	1000	AMP	C5-C4	2.12	1.46	1.40

All (13) bond angle outliers are listed below:

Mol	Chain	Res	Type	Atoms	Z	Observed(°)	Ideal(°)
6	D	1002	2SA	C2-N1-C6	6.51	122.17	116.59
6	B	1002	2SA	C2-N1-C6	5.50	121.31	116.59
6	D	1002	2SA	N3-C2-N1	-4.87	121.06	128.68
6	B	1002	2SA	N3-C2-N1	-4.66	121.39	128.68
2	A	1000	AMP	N3-C2-N1	-3.79	122.75	128.68
2	C	1000	AMP	N3-C2-N1	-3.76	122.80	128.68
6	D	1002	2SA	C63-C61-C62	-3.42	104.22	110.83
6	B	1002	2SA	C63-C61-C62	-2.80	105.41	110.83
2	A	1000	AMP	N6-C6-N1	2.35	123.45	118.57
6	B	1002	2SA	C4-C5-N7	-2.15	107.16	109.40
2	C	1000	AMP	C1'-N9-C4	-2.14	122.88	126.64
2	C	1000	AMP	N6-C6-N1	2.13	122.99	118.57
2	A	1000	AMP	C1'-N9-C4	-2.08	122.98	126.64

There are no chirality outliers.

All (20) torsion outliers are listed below:

Mol	Chain	Res	Type	Atoms
4	B	1003	GOL	O1-C1-C2-C3
4	B	1004	GOL	C1-C2-C3-O3
4	C	1003	GOL	C1-C2-C3-O3
4	C	1003	GOL	O2-C2-C3-O3
4	D	1003	GOL	C1-C2-C3-O3
6	B	1002	2SA	N1-C6-N6-C61
6	D	1002	2SA	N1-C6-N6-C61
4	B	1004	GOL	O1-C1-C2-C3
4	B	1003	GOL	O1-C1-C2-O2
4	B	1004	GOL	O2-C2-C3-O3
4	D	1003	GOL	O2-C2-C3-O3
6	B	1002	2SA	C5-C6-N6-C61
6	D	1002	2SA	C5-C6-N6-C61
6	B	1002	2SA	C61-C63-C64-O67

*Continued on next page...*

*Continued from previous page...*

Mol	Chain	Res	Type	Atoms
6	B	1002	2SA	C61-C63-C64-O68
4	B	1004	GOL	O1-C1-C2-O2
6	B	1002	2SA	O4'-C4'-C5'-O5'
2	A	1000	AMP	O4'-C4'-C5'-O5'
2	C	1000	AMP	O4'-C4'-C5'-O5'
6	D	1002	2SA	O4'-C4'-C5'-O5'

There are no ring outliers.

6 monomers are involved in 8 short contacts:

Mol	Chain	Res	Type	Clashes	Symm-Clashes
3	A	1001	FUM	2	0
3	C	1001	FUM	2	0
6	B	1002	2SA	1	0
2	C	1000	AMP	3	0
6	D	1002	2SA	1	0
2	A	1000	AMP	3	0

The following is a two-dimensional graphical depiction of Mogul quality analysis of bond lengths, bond angles, torsion angles, and ring geometry for all instances of the Ligand of Interest. In addition, ligands with molecular weight > 250 and outliers as shown on the validation Tables will also be included. For torsion angles, if less than 5% of the Mogul distribution of torsion angles is within 10 degrees of the torsion angle in question, then that torsion angle is considered an outlier. Any bond that is central to one or more torsion angles identified as an outlier by Mogul will be highlighted in the graph. For rings, the root-mean-square deviation (RMSD) between the ring in question and similar rings identified by Mogul is calculated over all ring torsion angles. If the average RMSD is greater than 60 degrees and the minimal RMSD between the ring in question and any Mogul-identified rings is also greater than 60 degrees, then that ring is considered an outlier. The outliers are highlighted in purple. The color gray indicates Mogul did not find sufficient equivalents in the CSD to analyse the geometry.

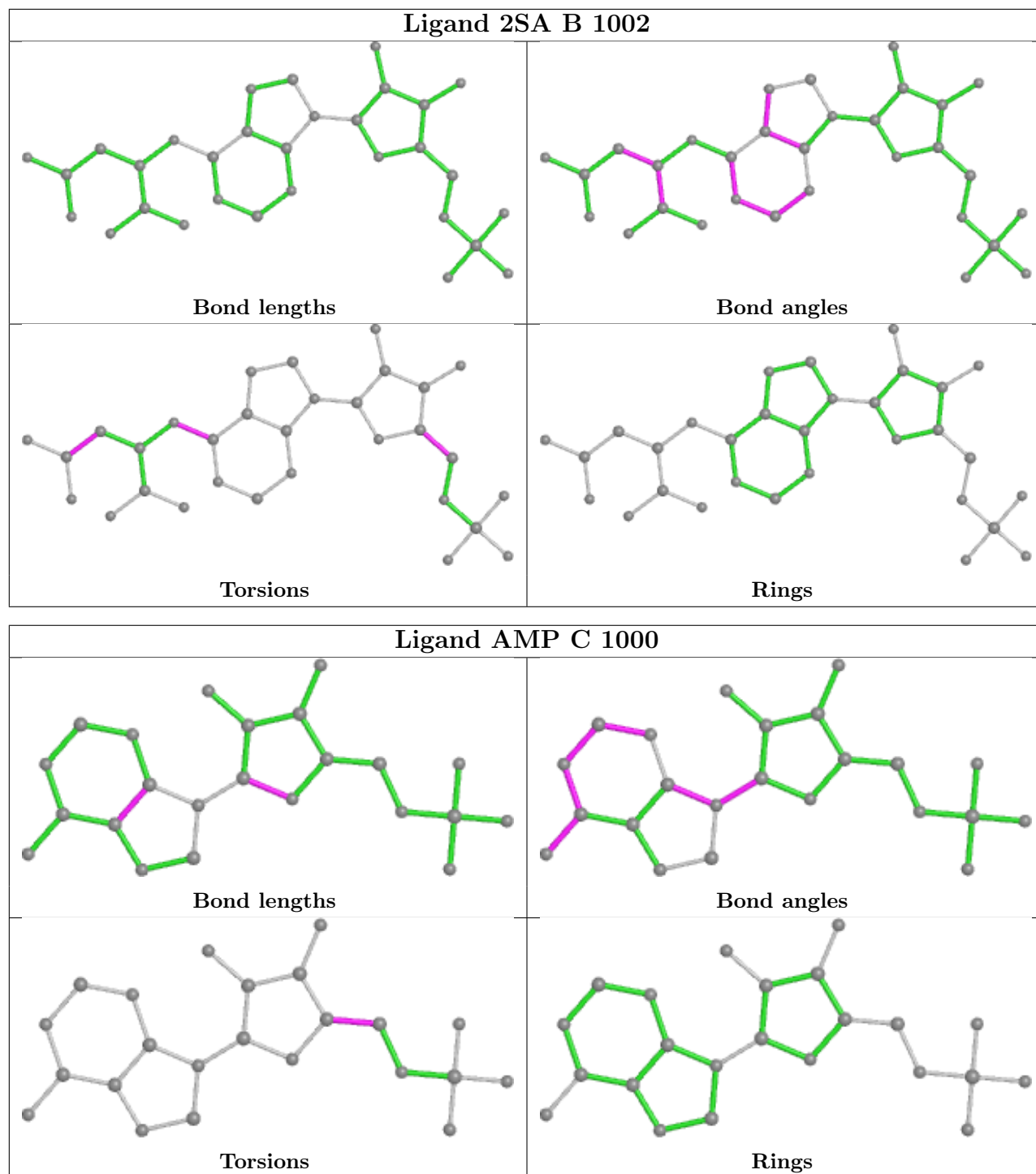

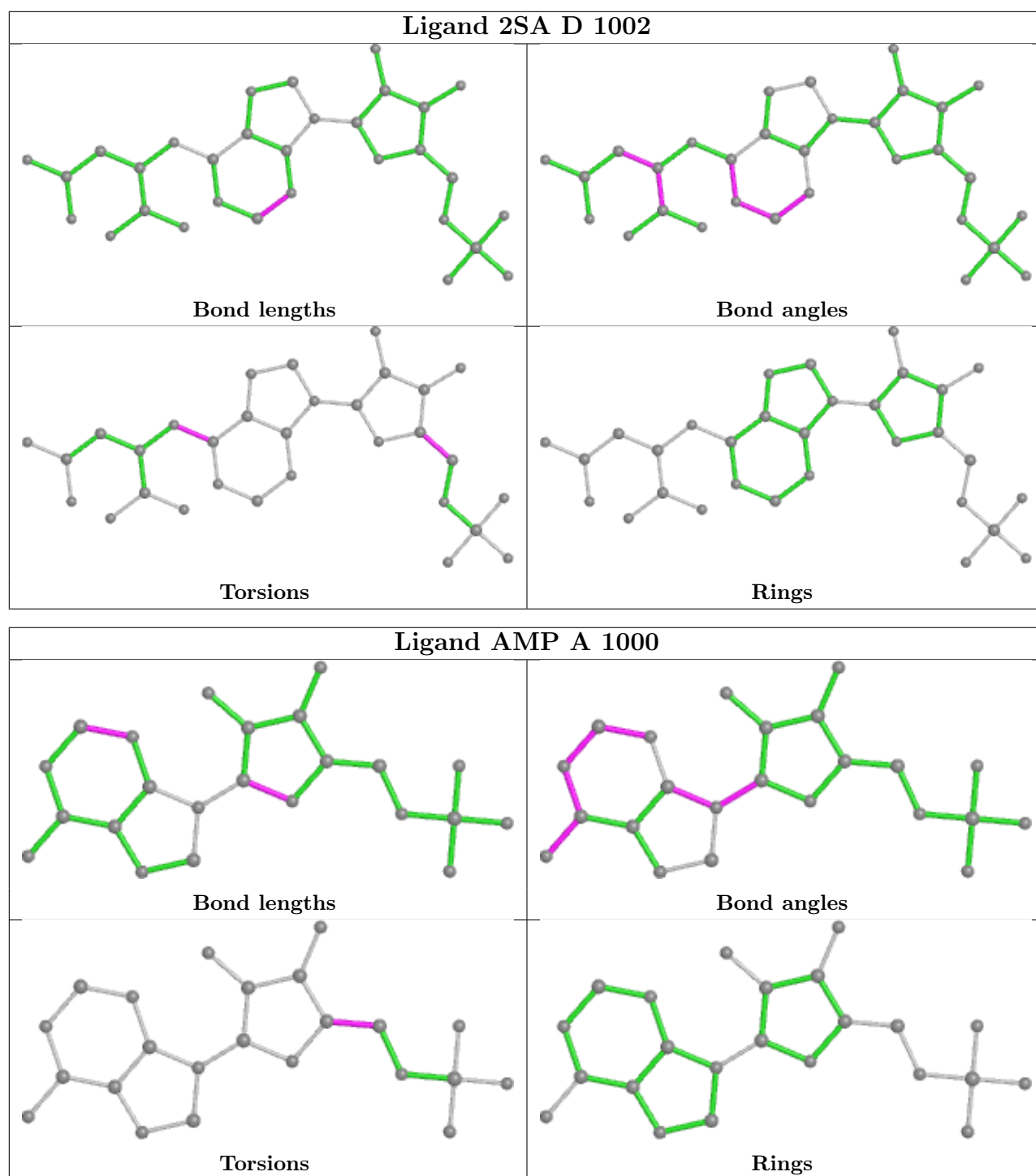

## 5.7 Other polymers [i](#)

There are no such residues in this entry.

## 5.8 Polymer linkage issues [i](#)

There are no chain breaks in this entry.



## 6 Fit of model and data

### 6.1 Protein, DNA and RNA chains

In the following table, the column labelled ‘#RSRZ > 2’ contains the number (and percentage) of RSRZ outliers, followed by percent RSRZ outliers for the chain as percentile scores relative to all X-ray entries and entries of similar resolution. The OWAB column contains the minimum, median, 95<sup>th</sup> percentile and maximum values of the occupancy-weighted average B-factor per residue. The column labelled ‘Q < 0.9’ lists the number of (and percentage) of residues with an average occupancy less than 0.9.

Mol	Chain	Analysed	<RSRZ>	#RSRZ>2	OWAB(Å <sup>2</sup> )	Q<0.9
1	A	461/503 (91%)	0.66	45 (9%) <b>7</b> <b>7</b>	27, 34, 44, 55	0
1	B	461/503 (91%)	0.79	50 (10%) <b>5</b> <b>5</b>	28, 34, 44, 50	0
1	C	457/503 (90%)	0.69	48 (10%) <b>6</b> <b>5</b>	28, 33, 50, 61	0
1	D	462/503 (91%)	0.72	56 (12%) <b>4</b> <b>3</b>	27, 33, 53, 63	0
All	All	1841/2012 (91%)	0.72	199 (10%) <b>5</b> <b>5</b>	27, 34, 47, 63	0

All (199) RSRZ outliers are listed below:

Mol	Chain	Res	Type	RSRZ
1	B	5	GLY	9.0
1	D	397	GLN	8.5
1	C	5	GLY	7.7
1	B	282	PHE	7.4
1	D	5	GLY	6.9
1	A	5	GLY	6.6
1	D	396	ARG	6.1
1	C	391	LYS	5.7
1	D	395	SER	5.7
1	B	387	MET	5.7
1	A	474	SER	5.6
1	D	391	LYS	5.5
1	D	282	PHE	5.4
1	A	293	PRO	5.3
1	D	6	ASP	5.3
1	C	397	GLN	5.2
1	C	6	ASP	5.2
1	D	392	ALA	5.2
1	D	419	GLY	5.0
1	C	404	ARG	4.9
1	D	475	VAL	4.8

*Continued on next page...*

*Continued from previous page...*

<b>Mol</b>	<b>Chain</b>	<b>Res</b>	<b>Type</b>	<b>RSRZ</b>
1	B	391	LYS	4.5
1	A	6	ASP	4.5
1	C	394	GLY	4.4
1	D	401	GLU	4.4
1	D	417	GLU	4.4
1	D	432	TYR	4.4
1	D	436	ILE	4.3
1	D	429	VAL	4.3
1	B	442	HIS	4.3
1	B	85	ARG	4.1
1	C	93	HIS	4.0
1	D	435	PRO	4.0
1	A	473	GLU	3.9
1	D	433	PHE	3.9
1	D	387	MET	3.9
1	D	393	GLY	3.8
1	D	394	GLY	3.8
1	C	60	GLU	3.7
1	D	405	VAL	3.7
1	D	400	HIS	3.7
1	C	63	GLN	3.7
1	B	294	TYR	3.6
1	C	85	ARG	3.6
1	C	96	GLY	3.6
1	B	424	ILE	3.6
1	B	423	LEU	3.6
1	D	413	VAL	3.6
1	D	404	ARG	3.6
1	B	406	LEU	3.5
1	C	84	LEU	3.5
1	A	115	VAL	3.5
1	B	390	VAL	3.5
1	D	398	ASP	3.4
1	A	105	ILE	3.4
1	B	397	GLN	3.4
1	B	475	VAL	3.4
1	A	85	ARG	3.3
1	A	93	HIS	3.3
1	A	42	LEU	3.3
1	D	431	ALA	3.3
1	A	233	LYS	3.2
1	D	82	LYS	3.2

*Continued on next page...*

*Continued from previous page...*

<b>Mol</b>	<b>Chain</b>	<b>Res</b>	<b>Type</b>	<b>RSRZ</b>
1	C	431	ALA	3.2
1	D	399	CYS	3.2
1	B	83	ARG	3.2
1	D	390	VAL	3.2
1	C	83	ARG	3.1
1	D	438	SER	3.1
1	C	7	HIS	3.1
1	B	400	HIS	3.0
1	A	43	TRP	3.0
1	C	282	PHE	3.0
1	C	79	GLU	3.0
1	B	440	LEU	3.0
1	B	436	ILE	2.9
1	A	52	THR	2.9
1	B	394	GLY	2.9
1	C	396	ARG	2.9
1	B	393	GLY	2.9
1	D	418	GLY	2.9
1	D	11	ASP	2.9
1	A	114	TYR	2.8
1	A	83	ARG	2.8
1	B	404	ARG	2.8
1	C	395	SER	2.8
1	A	272	LEU	2.8
1	A	39	TRP	2.8
1	A	58	THR	2.8
1	D	409	GLN	2.8
1	D	474	SER	2.8
1	B	265	ILE	2.8
1	A	283	GLU	2.8
1	C	101	LYS	2.8
1	C	390	VAL	2.7
1	A	466	TYR	2.7
1	C	398	ASP	2.7
1	A	71	ASN	2.7
1	A	294	TYR	2.7
1	B	114	TYR	2.7
1	A	60	GLU	2.7
1	B	9	SER	2.7
1	B	403	ILE	2.7
1	C	393	GLY	2.6
1	A	70	GLU	2.6

*Continued on next page...*

*Continued from previous page...*

<b>Mol</b>	<b>Chain</b>	<b>Res</b>	<b>Type</b>	<b>RSRZ</b>
1	B	43	TRP	2.6
1	D	114	TYR	2.6
1	D	473	GLU	2.6
1	C	42	LEU	2.6
1	D	437	HIS	2.6
1	D	441	ASP	2.6
1	B	417	GLU	2.6
1	C	429	VAL	2.6
1	B	458	GLN	2.6
1	C	401	GLU	2.6
1	D	83	ARG	2.6
1	A	7	HIS	2.6
1	A	82	LYS	2.5
1	C	67	SER	2.5
1	A	97	HIS	2.5
1	D	428	GLN	2.5
1	D	293	PRO	2.5
1	B	395	SER	2.5
1	D	403	ILE	2.5
1	B	462	GLU	2.5
1	B	101	LYS	2.4
1	C	89	MET	2.4
1	A	228	GLU	2.4
1	C	58	THR	2.4
1	A	265	ILE	2.4
1	D	424	ILE	2.4
1	C	99	CYS	2.4
1	D	406	LEU	2.4
1	D	442	HIS	2.4
1	A	282	PHE	2.4
1	D	408	GLN	2.4
1	B	433	PHE	2.3
1	B	115	VAL	2.3
1	A	24	PRO	2.3
1	A	470	LYS	2.3
1	C	75	LYS	2.3
1	C	82	LYS	2.3
1	D	389	MET	2.3
1	A	404	ARG	2.3
1	B	39	TRP	2.3
1	C	39	TRP	2.3
1	A	63	GLN	2.3

*Continued on next page...*

*Continued from previous page...*

<b>Mol</b>	<b>Chain</b>	<b>Res</b>	<b>Type</b>	<b>RSRZ</b>
1	C	57	ILE	2.3
1	B	272	LEU	2.3
1	C	46	LEU	2.3
1	C	49	ALA	2.3
1	D	420	ASP	2.3
1	C	100	PRO	2.3
1	C	294	TYR	2.3
1	C	228	GLU	2.3
1	B	226	VAL	2.3
1	D	97	HIS	2.3
1	B	402	LYS	2.2
1	B	455	GLN	2.2
1	C	403	ILE	2.2
1	B	82	LYS	2.2
1	C	387	MET	2.2
1	B	6	ASP	2.2
1	B	147	LYS	2.2
1	D	425	GLU	2.2
1	B	357	ASN	2.2
1	A	95	PHE	2.2
1	A	212	PHE	2.2
1	B	473	GLU	2.2
1	A	38	THR	2.2
1	B	434	SER	2.2
1	B	447	SER	2.2
1	C	197	GLY	2.1
1	B	56	PRO	2.1
1	D	265	ILE	2.1
1	C	275	LEU	2.1
1	B	356	GLN	2.1
1	D	439	GLN	2.1
1	D	414	VAL	2.1
1	C	212	PHE	2.1
1	A	101	LYS	2.1
1	C	24	PRO	2.1
1	C	265	ILE	2.1
1	C	11	ASP	2.1
1	A	397	GLN	2.1
1	B	67	SER	2.1
1	C	386	ILE	2.1
1	D	385	ILE	2.1
1	A	262	VAL	2.1

*Continued on next page...*

*Continued from previous page...*

Mol	Chain	Res	Type	RSRZ
1	D	388	ALA	2.1
1	A	222	LEU	2.0
1	A	258	LEU	2.0
1	A	231	GLY	2.0
1	A	37	ARG	2.0
1	B	28	PHE	2.0
1	B	437	HIS	2.0
1	A	119	THR	2.0
1	B	42	LEU	2.0
1	D	430	ASP	2.0

## 6.2 Non-standard residues in protein, DNA, RNA chains [i](#)

There are no non-standard protein/DNA/RNA residues in this entry.

## 6.3 Carbohydrates [i](#)

There are no monosaccharides in this entry.

## 6.4 Ligands [i](#)

In the following table, the Atoms column lists the number of modelled atoms in the group and the number defined in the chemical component dictionary. The B-factors column lists the minimum, median, 95<sup>th</sup> percentile and maximum values of B factors of atoms in the group. The column labelled 'Q< 0.9' lists the number of atoms with occupancy less than 0.9.

Mol	Type	Chain	Res	Atoms	RSCC	RSR	B-factors(Å <sup>2</sup> )	Q<0.9
4	GOL	C	1003	6/6	0.81	0.25	49,50,52,53	0
4	GOL	B	1004	6/6	0.82	0.22	49,50,51,51	0
3	FUM	A	1001	8/8	0.88	0.19	41,41,42,43	0
3	FUM	C	1001	8/8	0.89	0.14	41,42,43,44	0
4	GOL	A	1003	6/6	0.90	0.17	43,43,43,44	0
5	CL	A	2001	1/1	0.90	0.12	55,55,55,55	0
4	GOL	D	1003	6/6	0.91	0.14	33,35,35,36	0
4	GOL	B	1003	6/6	0.91	0.14	39,40,40,40	0
2	AMP	C	1000	23/23	0.93	0.13	37,41,41,41	0
2	AMP	A	1000	23/23	0.95	0.13	26,36,37,37	0
6	2SA	B	1002	31/31	0.97	0.12	22,24,26,29	0
6	2SA	D	1002	31/31	0.97	0.12	18,20,22,24	0
5	CL	A	2002	1/1	0.98	0.21	35,35,35,35	0

*Continued on next page...*

Continued from previous page...

Mol	Type	Chain	Res	Atoms	RSCC	RSR	B-factors( $\text{\AA}^2$ )	Q<0.9
5	CL	C	2002	1/1	0.98	0.27	38,38,38,38	0
5	CL	D	2001	1/1	0.99	0.13	29,29,29,29	0
5	CL	B	2002	1/1	0.99	0.08	25,25,25,25	0
5	CL	B	2001	1/1	0.99	0.15	31,31,31,31	0
5	CL	D	2002	1/1	1.00	0.01	18,18,18,18	0

The following is a graphical depiction of the model fit to experimental electron density of all instances of the Ligand of Interest. In addition, ligands with molecular weight > 250 and outliers as shown on the geometry validation Tables will also be included. Each fit is shown from different orientation to approximate a three-dimensional view.

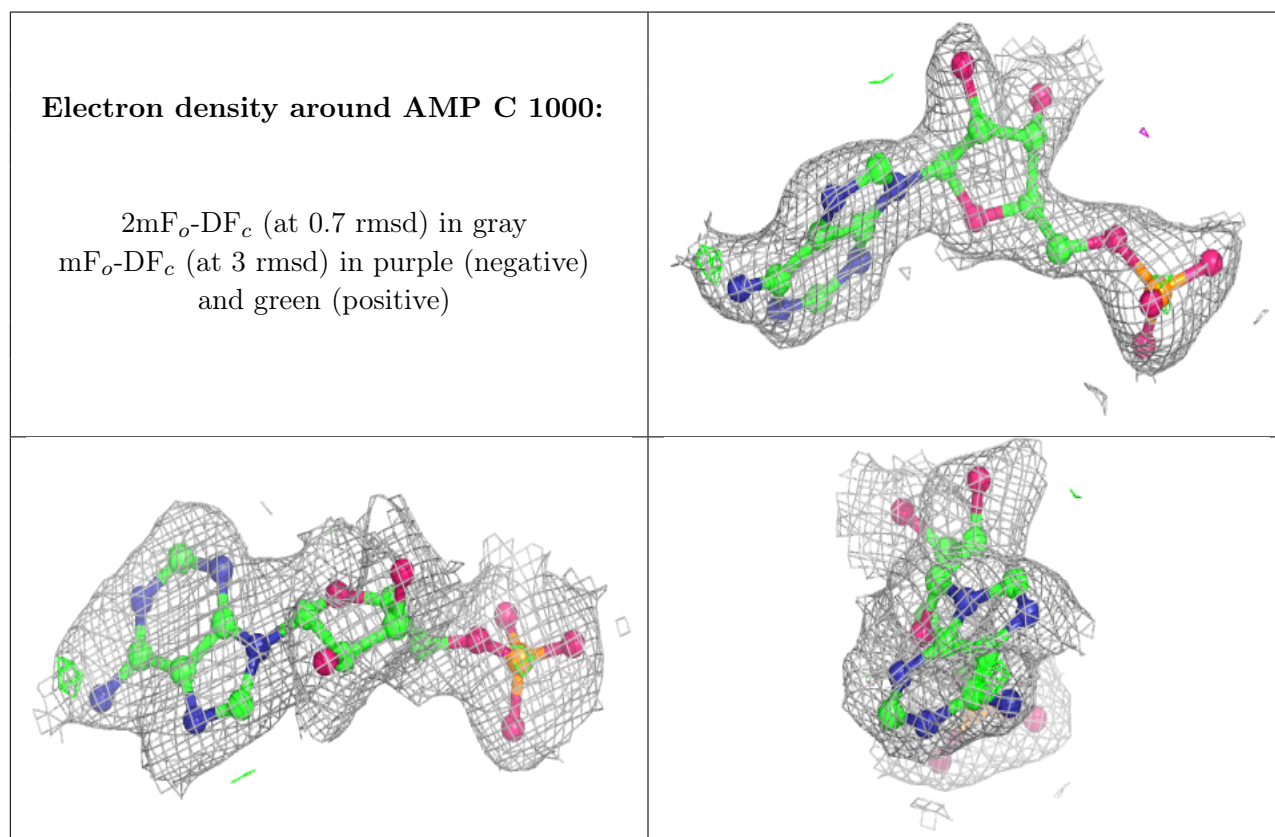

**Electron density around AMP A 1000:**

$2mF_o-DF_c$  (at 0.7 rmsd) in gray  
 $mF_o-DF_c$  (at 3 rmsd) in purple (negative)  
and green (positive)

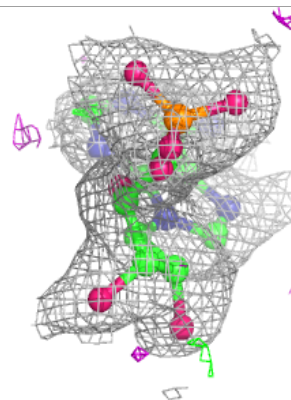
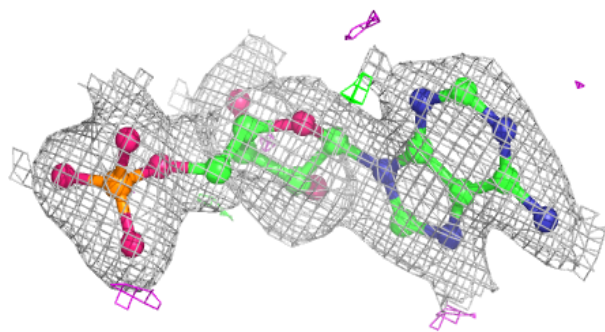
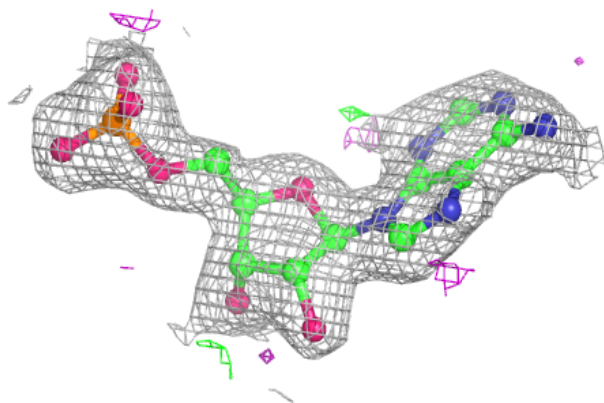
**Electron density around 2SA B 1002:**

$2mF_o-DF_c$  (at 0.7 rmsd) in gray  
 $mF_o-DF_c$  (at 3 rmsd) in purple (negative)  
and green (positive)

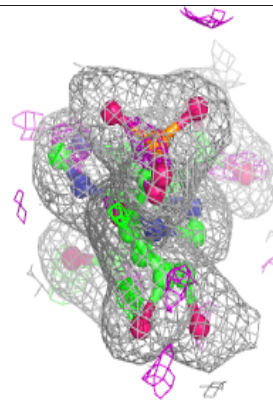
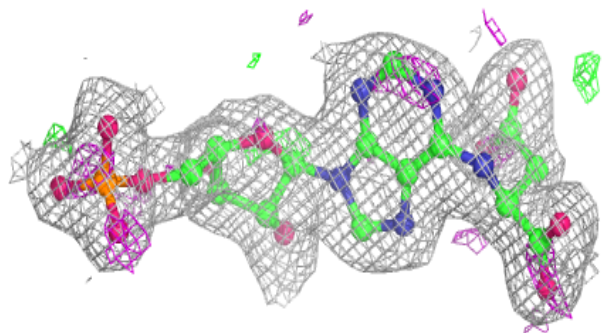
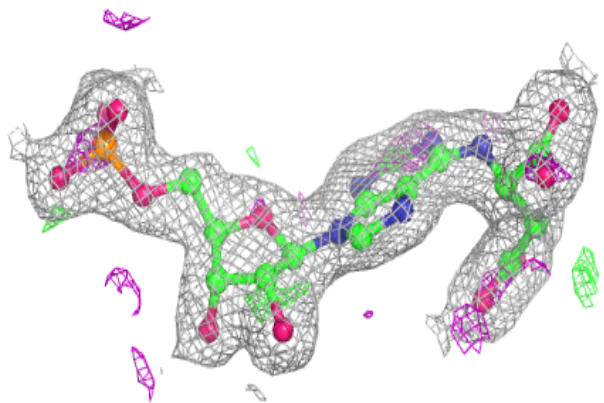



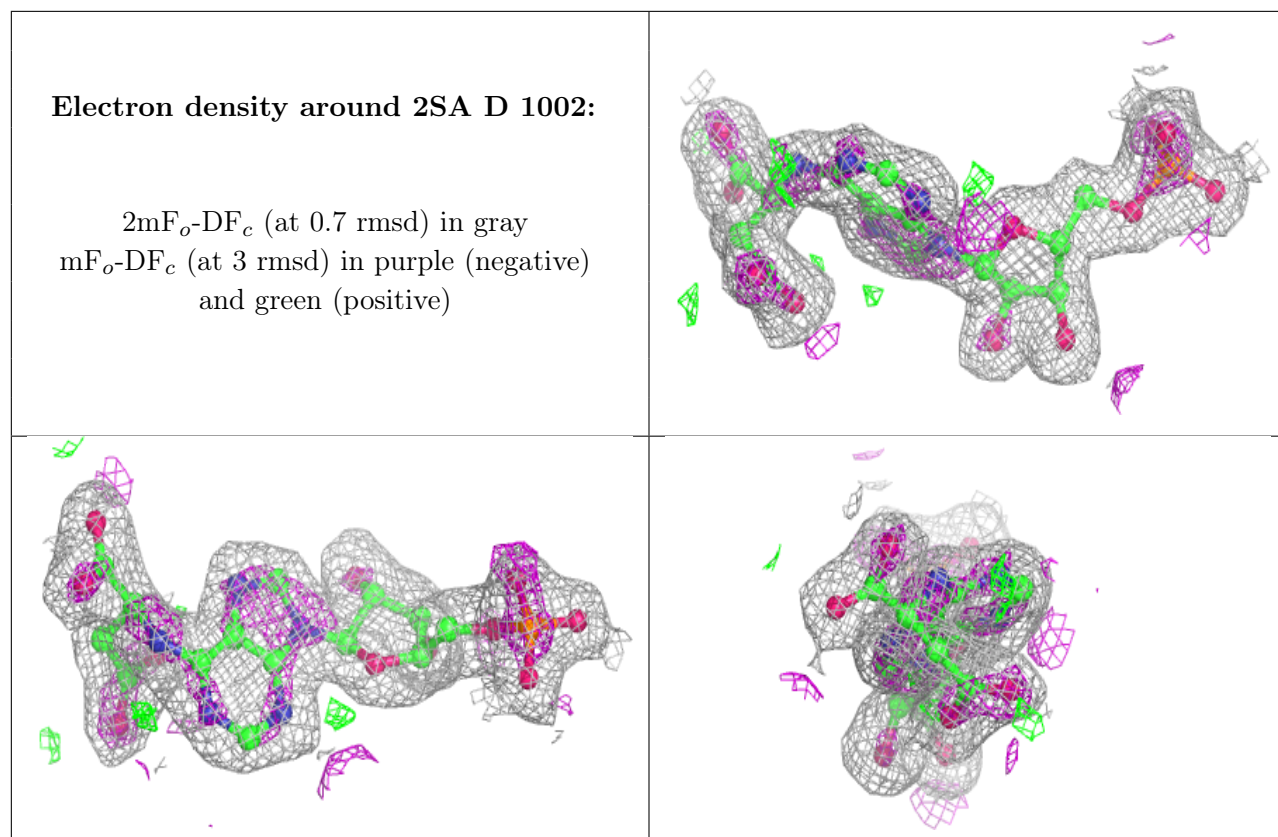

## 6.5 Other polymers [i](#)

There are no such residues in this entry.