



Full wwPDB EM Validation Report ⓘ

Feb 27, 2024 – 01:00 AM EST

PDB ID : 6VLZ
EMDB ID : EMD-21233
Title : Structure of the human mitochondrial ribosome-EF-G1 complex (ClassI)
Authors : Sharma, M.R.; Koripella, R.K.; Agrawal, R.K.
Deposited on : 2020-01-27
Resolution : 2.97 Å(reported)

This is a Full wwPDB EM Validation Report for a publicly released PDB entry.

We welcome your comments at validation@mail.wwpdb.org

A user guide is available at

<https://www.wwpdb.org/validation/2017/EMValidationReportHelp>

with specific help available everywhere you see the ⓘ symbol.

The types of validation reports are described at

<http://www.wwpdb.org/validation/2017/FAQs#types>.

The following versions of software and data (see [references ⓘ](#)) were used in the production of this report:

EMDB validation analysis : 0.0.1.dev70
Mogul : 1.8.5 (274361), CSD as541be (2020)
MolProbity : 4.02b-467
buster-report : 1.1.7 (2018)
Percentile statistics : 20191225.v01 (using entries in the PDB archive December 25th 2019)
MapQ : 1.9.13
Ideal geometry (proteins) : Engh & Huber (2001)
Ideal geometry (DNA, RNA) : Parkinson et al. (1996)
Validation Pipeline (wwPDB-VP) : 2.36

1 Overall quality at a glance

The following experimental techniques were used to determine the structure:
ELECTRON MICROSCOPY

The reported resolution of this entry is 2.97 Å.

Percentile scores (ranging between 0-100) for global validation metrics of the entry are shown in the following graphic. The table shows the number of entries on which the scores are based.

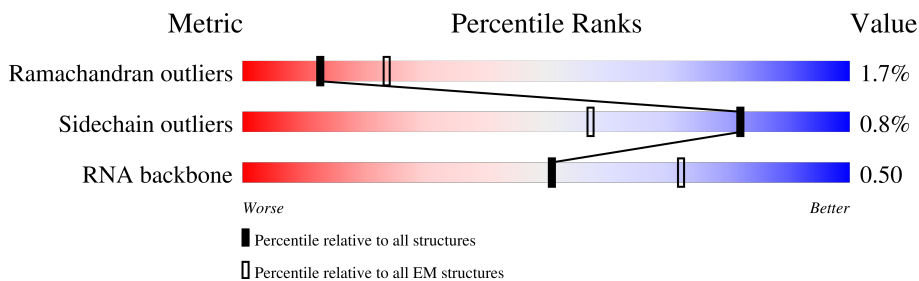

Metric	Whole archive (#Entries)	EM structures (#Entries)
Ramachandran outliers	154571	4023
Sidechain outliers	154315	3826
RNA backbone	4643	859

The table below summarises the geometric issues observed across the polymeric chains and their fit to the map. The red, orange, yellow and green segments of the bar indicate the fraction of residues that contain outliers for ≥ 3 , 2, 1 and 0 types of geometric quality criteria respectively. A grey segment represents the fraction of residues that are not modelled. The numeric value for each fraction is indicated below the corresponding segment, with a dot representing fractions $\leq 5\%$. The upper red bar (where present) indicates the fraction of residues that have poor fit to the EM map (all-atom inclusion $< 40\%$). The numeric value is given above the bar.

Mol	Chain	Length	Quality of chain
1	AA	954	
2	AB	296	
3	AC	167	
4	AE	125	
5	AI	194	
6	AJ	138	
7	AK	128	
8	AM	137	

Continued on next page...

Continued from previous page...

Mol	Chain	Length	Quality of chain
9	AN	130	81% 18%
10	AO	258	72% 26% 10%
11	AP	142	65% 32% 14%
12	AQ	87	99% 1% 9%
13	AT	173	96% 2% 6%
14	AW	187	50% 48% 10%
15	AX	398	87% 11% 54%
16	A2	118	95% 2% 47%
17	AH	201	59% 39% 34%
18	AL	257	66% 32% 9%
19	AR	360	81% 19% 17%
20	AS	190	68% 29% 23%
21	AU	205	86% 14% 10%
22	AV	414	86% 11% 29%
23	AY	395	70% 30% 17%
24	AZ	106	93% 7% 46%
25	A1	323	83% 15% 48%
26	A0	218	95% 2% 14%
27	A3	199	64% 35% 1%
28	A4	689	78% 20% 75%
29	AD	430	79% 20% 22%
30	AF	242	82% 14% 43%
31	AG	396	79% 20% 32%
32	A	1559	75% 23% 1%
33	B	73	67% 10% 23%















Continued on next page...

Continued from previous page...

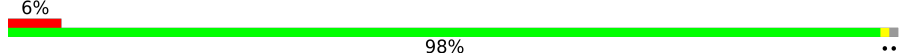
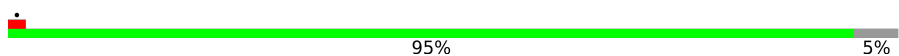
Mol	Chain	Length	Quality of chain
34	D	305	78% 22%
35	F	311	79% 20%
36	H	267	36% 63%
37	K	178	96%
38	L	145	78% 21%
39	M	296	94%
40	O	175	85% 13%
41	R	149	89% 6%
42	S	205	73% 24%
43	T	212	75% 22%
44	W	148	74% 25%
45	X	256	91% 5%
46	Y	250	68% 30%
47	Z	161	75% 25%
48	0	188	56% 43%
49	1	65	77% 20%
50	2	92	49% 50%
51	3	188	50% 49%
52	4	103	37% 63%
53	8	206	48% 52%
54	b	155	94% 5%
55	e	279	10% 77% 22%
56	g	166	75% 20%
57	i	128	75% 24%
58	j	123	75% 24%

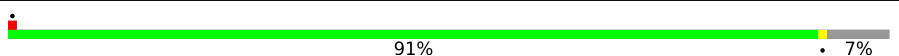
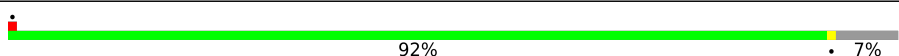
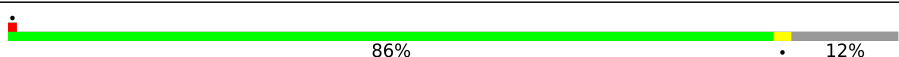
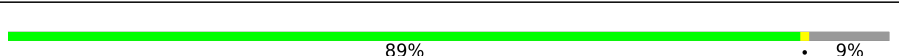
Continued on next page...

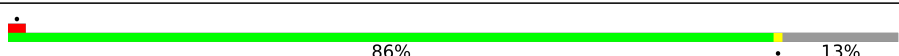
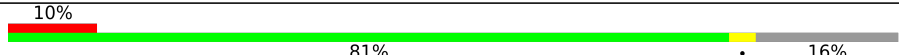
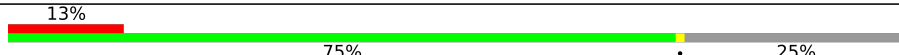
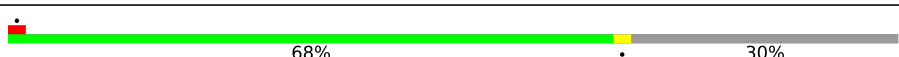
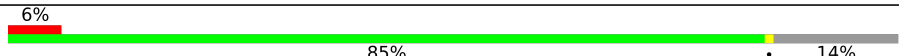
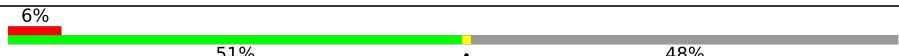
Continued from previous page...

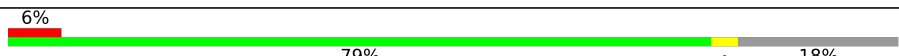
Mol	Chain	Length	Quality of chain
59	m	128	
60	o	102	
61	q	222	
62	r	196	
63	J	192	
64	I	261	
65	N	251	
66	P	179	
67	U	153	
68	V	216	
69	E	348	
70	5	423	
71	6	380	
72	7	338	
73	9	137	
74	a	142	
75	c	332	
76	d	306	
77	f	194	
78	h	158	
79	k	112	
80	l	138	
81	p	206	
82	s	439	
83	Q	292	

Continued on next page...

Continued from previous page...

Mol	Chain	Length	Quality of chain
84	TA	198	
84	TB	198	
84	TC	198	
85	u	65	
86	v	751	
87	A5	11	
88	A7	71	

2 Entry composition [i](#)

There are 92 unique types of molecules in this entry. The entry contains 174849 atoms, of which 0 are hydrogens and 0 are deuteriums.

In the tables below, the AltConf column contains the number of residues with at least one atom in alternate conformation and the Trace column contains the number of residues modelled with at most 2 atoms.

- Molecule 1 is a RNA chain called 12s rRNA.

Mol	Chain	Residues	Atoms					AltConf	Trace
			Total	C	N	O	P		
1	AA	944	20030	8980	3612	6494	944	0	0

- Molecule 2 is a protein called 28S ribosomal protein S2, mitochondrial.

Mol	Chain	Residues	Atoms					AltConf	Trace
			Total	C	N	O	S		
2	AB	220	1787	1141	324	312	10	0	0

- Molecule 3 is a protein called 28S ribosomal protein S24, mitochondrial.

Mol	Chain	Residues	Atoms					AltConf	Trace
			Total	C	N	O	S		
3	AC	132	1082	699	195	184	4	0	0

- Molecule 4 is a protein called 28S ribosomal protein S6, mitochondrial.

Mol	Chain	Residues	Atoms					AltConf	Trace
			Total	C	N	O	S		
4	AE	122	972	614	177	177	4	0	0

- Molecule 5 is a protein called 28S ribosomal protein S11, mitochondrial.

Mol	Chain	Residues	Atoms					AltConf	Trace
			Total	C	N	O	S		
5	AI	136	1011	637	192	178	4	0	0

- Molecule 6 is a protein called 28S ribosomal protein S12, mitochondrial.

Mol	Chain	Residues	Atoms					AltConf	Trace
			Total	C	N	O	S		
6	AJ	108	838	521	169	142	6	0	0

- Molecule 7 is a protein called 28S ribosomal protein S14, mitochondrial.

Mol	Chain	Residues	Atoms					AltConf	Trace
			Total	C	N	O	S		
7	AK	101	861	537	179	140	5	0	0

- Molecule 8 is a protein called 28S ribosomal protein S16, mitochondrial.

Mol	Chain	Residues	Atoms					AltConf	Trace
			Total	C	N	O	S		
8	AM	116	920	582	182	150	6	0	0

- Molecule 9 is a protein called 28S ribosomal protein S17, mitochondrial.

Mol	Chain	Residues	Atoms					AltConf	Trace
			Total	C	N	O	S		
9	AN	107	846	549	153	141	3	0	0

- Molecule 10 is a protein called 28S ribosomal protein S18b, mitochondrial.

Mol	Chain	Residues	Atoms					AltConf	Trace
			Total	C	N	O	S		
10	AO	190	1570	998	291	274	7	0	0

- Molecule 11 is a protein called 28S ribosomal protein S18c, mitochondrial.

Mol	Chain	Residues	Atoms					AltConf	Trace
			Total	C	N	O	S		
11	AP	96	774	498	133	135	8	0	0

- Molecule 12 is a protein called 28S ribosomal protein S21, mitochondrial.

Mol	Chain	Residues	Atoms					AltConf	Trace
			Total	C	N	O	S		
12	AQ	86	740	458	150	124	8	0	0

There is a discrepancy between the modelled and reference sequences:

Chain	Residue	Modelled	Actual	Comment	Reference
AQ	50	ARG	CYS	conflict	UNP P82921

- Molecule 13 is a protein called 28S ribosomal protein S25, mitochondrial.

Mol	Chain	Residues	Atoms					AltConf	Trace
			Total	C	N	O	S		
13	AT	168	1371	877	239	244	11	0	0

- Molecule 14 is a protein called 28S ribosomal protein S28, mitochondrial.

Mol	Chain	Residues	Atoms					AltConf	Trace
			Total	C	N	O	S		
14	AW	97	766	486	137	139	4	0	0

- Molecule 15 is a protein called 28S ribosomal protein S29, mitochondrial.

Mol	Chain	Residues	Atoms					AltConf	Trace
			Total	C	N	O	S		
15	AX	353	2860	1828	503	518	11	0	0

- Molecule 16 is a protein called Coiled-coil-helix-coiled-coil-helix domain-containing protein 1.

Mol	Chain	Residues	Atoms					AltConf	Trace
			Total	C	N	O	S		
16	A2	116	925	574	181	162	8	0	0

- Molecule 17 is a protein called 28S ribosomal protein S10, mitochondrial.

Mol	Chain	Residues	Atoms					AltConf	Trace
			Total	C	N	O	S		
17	AH	122	1014	656	172	183	3	0	0

- Molecule 18 is a protein called 28S ribosomal protein S15, mitochondrial.

Mol	Chain	Residues	Atoms					AltConf	Trace
			Total	C	N	O	S		
18	AL	174	1451	924	271	249	7	0	0

- Molecule 19 is a protein called 28S ribosomal protein S22, mitochondrial.

Mol	Chain	Residues	Atoms					AltConf	Trace
			Total	C	N	O	S		
19	AR	292	2388	1521	410	449	8	0	0

- Molecule 20 is a protein called 28S ribosomal protein S23, mitochondrial.

Mol	Chain	Residues	Atoms					AltConf	Trace
			Total	C	N	O	S		
20	AS	135	1111	716	198	196	1	0	0

- Molecule 21 is a protein called 28S ribosomal protein S26, mitochondrial.

Mol	Chain	Residues	Atoms					AltConf	Trace
			Total	C	N	O	S		
21	AU	177	1499	922	305	268	4	0	0

- Molecule 22 is a protein called 28S ribosomal protein S27, mitochondrial.

Mol	Chain	Residues	Atoms					AltConf	Trace
			Total	C	N	O	S		
22	AV	367	3009	1931	502	564	12	0	0

- Molecule 23 is a protein called 28S ribosomal protein S31, mitochondrial.

Mol	Chain	Residues	Atoms					AltConf	Trace
			Total	C	N	O	S		
23	AY	120	1016	657	167	190	2	0	0

- Molecule 24 is a protein called 28S ribosomal protein S33, mitochondrial.

Mol	Chain	Residues	Atoms					AltConf	Trace
			Total	C	N	O	S		
24	AZ	99	833	531	152	146	4	0	0

- Molecule 25 is a protein called 28S ribosomal protein S35, mitochondrial.

Mol	Chain	Residues	Atoms					AltConf	Trace
			Total	C	N	O	S		
25	A1	275	2231	1414	380	426	11	0	0

- Molecule 26 is a protein called 28S ribosomal protein S34, mitochondrial.

Mol	Chain	Residues	Atoms					AltConf	Trace
			Total	C	N	O	S		
26	A0	214	1781	1125	341	310	5	0	0

- Molecule 27 is a protein called Aurora kinase A-interacting protein.

Mol	Chain	Residues	Atoms					AltConf	Trace
			Total	C	N	O	S		
27	A3	72	639	409	137	92	1	0	0

- Molecule 28 is a protein called Pentatricopeptide repeat domain-containing protein 3, mitochondrial.

Mol	Chain	Residues	Atoms					AltConf	Trace
			Total	C	N	O	S		
28	A4	549	3010	1841	573	593	3	0	0

- Molecule 29 is a protein called 28S ribosomal protein S5, mitochondrial.

Mol	Chain	Residues	Atoms					AltConf	Trace
			Total	C	N	O	S		
29	AD	343	2731	1713	518	487	13	0	0

- Molecule 30 is a protein called 28S ribosomal protein S7, mitochondrial.

Mol	Chain	Residues	Atoms					AltConf	Trace
			Total	C	N	O	S		
30	AF	208	1724	1103	312	298	11	0	0

- Molecule 31 is a protein called 28S ribosomal protein S9, mitochondrial.

Mol	Chain	Residues	Atoms					AltConf	Trace
			Total	C	N	O	S		
31	AG	315	2587	1640	462	471	14	0	0

- Molecule 32 is a RNA chain called 16s rRNA.

Mol	Chain	Residues	Atoms					AltConf	Trace
			Total	C	N	O	P		
32	A	1527	32395	14536	5844	10488	1527	0	0

There is a discrepancy between the modelled and reference sequences:

Chain	Residue	Modelled	Actual	Comment	Reference
A	3107	U	C	conflict	GB 1616239084

- Molecule 33 is a RNA chain called tRNAval.

Mol	Chain	Residues	Atoms					AltConf	Trace
			Total	C	N	O	P		
33	B	56	1191	534	214	387	56	0	0

- Molecule 34 is a protein called 39S ribosomal protein L2, mitochondrial.

Mol	Chain	Residues	Atoms					AltConf	Trace
			Total	C	N	O	S		
34	D	239	1866	1162	377	318	9	0	0

- Molecule 35 is a protein called 39S ribosomal protein L4, mitochondrial.

Mol	Chain	Residues	Atoms					AltConf	Trace
			Total	C	N	O	S		
35	F	250	2013	1294	365	348	6	0	0

- Molecule 36 is a protein called 39S ribosomal protein L9, mitochondrial.

Mol	Chain	Residues	Atoms				AltConf	Trace
			Total	C	N	O		
36	H	98	806	510	156	140	0	0

- Molecule 37 is a protein called 39S ribosomal protein L13, mitochondrial.

Mol	Chain	Residues	Atoms					AltConf	Trace
			Total	C	N	O	S		
37	K	177	1451	934	259	251	7	0	0

- Molecule 38 is a protein called 39S ribosomal protein L14, mitochondrial.

Mol	Chain	Residues	Atoms					AltConf	Trace
			Total	C	N	O	S		
38	L	115	889	559	171	154	5	0	0

- Molecule 39 is a protein called 39S ribosomal protein L15, mitochondrial.

Mol	Chain	Residues	Atoms					AltConf	Trace
			Total	C	N	O	S		
39	M	287	2305	1472	425	402	6	0	0

- Molecule 40 is a protein called 39S ribosomal protein L17, mitochondrial.

Mol	Chain	Residues	Atoms					AltConf	Trace
			Total	C	N	O	S		
40	O	152	1245	784	239	215	7	0	0

- Molecule 41 is a protein called 39S ribosomal protein L20, mitochondrial.

Mol	Chain	Residues	Atoms					AltConf	Trace
			Total	C	N	O	S		
41	R	140	1153	732	231	186	4	0	0

- Molecule 42 is a protein called 39S ribosomal protein L21, mitochondrial.

Mol	Chain	Residues	Atoms					AltConf	Trace
			Total	C	N	O	S		
42	S	156	1251	806	222	219	4	0	0

- Molecule 43 is a protein called 39S ribosomal protein L22, mitochondrial.

Mol	Chain	Residues	Atoms					AltConf	Trace
			Total	C	N	O	S		
43	T	166	1368	875	254	232	7	0	0

- Molecule 44 is a protein called 39S ribosomal protein L27, mitochondrial.

Mol	Chain	Residues	Atoms					AltConf	Trace
			Total	C	N	O	S		
44	W	111	871	558	164	146	3	0	0

- Molecule 45 is a protein called 39S ribosomal protein L28, mitochondrial.

Mol	Chain	Residues	Atoms					AltConf	Trace
			Total	C	N	O	S		
45	X	243	2027	1310	350	362	5	0	0

There are 3 discrepancies between the modelled and reference sequences:

Chain	Residue	Modelled	Actual	Comment	Reference
X	148	ALA	THR	conflict	UNP Q13084
X	149	SER	PRO	conflict	UNP Q13084
X	150	GLY	LYS	conflict	UNP Q13084

- Molecule 46 is a protein called 39S ribosomal protein L47, mitochondrial.

Mol	Chain	Residues	Atoms					AltConf	Trace
46	Y	176	Total	C	N	O	S	0	0
			1517	970	291	252	4		

- Molecule 47 is a protein called 39S ribosomal protein L30, mitochondrial.

Mol	Chain	Residues	Atoms					AltConf	Trace
47	Z	120	Total	C	N	O	S	0	0
			978	626	183	166	3		

- Molecule 48 is a protein called 39S ribosomal protein L32, mitochondrial.

Mol	Chain	Residues	Atoms					AltConf	Trace
48	0	108	Total	C	N	O	S	0	0
			880	545	172	157	6		

- Molecule 49 is a protein called 39S ribosomal protein L33, mitochondrial.

Mol	Chain	Residues	Atoms					AltConf	Trace
49	1	52	Total	C	N	O	S	0	0
			433	278	83	70	2		

- Molecule 50 is a protein called 39S ribosomal protein L34, mitochondrial.

Mol	Chain	Residues	Atoms					AltConf	Trace
50	2	46	Total	C	N	O	S	0	0
			376	233	83	59	1		

- Molecule 51 is a protein called 39S ribosomal protein L35, mitochondrial.

Mol	Chain	Residues	Atoms					AltConf	Trace
51	3	95	Total	C	N	O	S	0	0
			831	539	162	127	3		

- Molecule 52 is a protein called 39S ribosomal protein L36, mitochondrial.

Mol	Chain	Residues	Atoms					AltConf	Trace
52	4	38	Total	C	N	O	S	0	0
			342	217	72	49	4		

- Molecule 53 is a protein called 39S ribosomal protein L40, mitochondrial.

Mol	Chain	Residues	Atoms					AltConf	Trace
			Total	C	N	O	S		
53	8	99	836	535	144	155	2	0	0

- Molecule 54 is a protein called 39S ribosomal protein L43, mitochondrial.

Mol	Chain	Residues	Atoms					AltConf	Trace
			Total	C	N	O	S		
54	b	148	1178	733	229	213	3	0	0

- Molecule 55 is a protein called 39S ribosomal protein L46, mitochondrial.

Mol	Chain	Residues	Atoms					AltConf	Trace
			Total	C	N	O	S		
55	e	217	1762	1124	310	323	5	0	0

- Molecule 56 is a protein called 39S ribosomal protein L49, mitochondrial.

Mol	Chain	Residues	Atoms					AltConf	Trace
			Total	C	N	O	S		
56	g	132	1096	709	191	194	2	0	0

- Molecule 57 is a protein called 39S ribosomal protein L51, mitochondrial.

Mol	Chain	Residues	Atoms					AltConf	Trace
			Total	C	N	O	S		
57	i	97	827	532	165	126	4	0	0

- Molecule 58 is a protein called cDNA FLJ76418, highly similar to Homo sapiens mitochondrial ribosomal protein L52 (MRPL52), transcript variant 1, mRNA.

Mol	Chain	Residues	Atoms					AltConf	Trace
			Total	C	N	O	S		
58	j	93	740	460	143	135	2	0	0

- Molecule 59 is a protein called 39S ribosomal protein L55, mitochondrial.

Mol	Chain	Residues	Atoms					AltConf	Trace
			Total	C	N	O	S		
59	m	45	372	232	76	62	2	0	0

- Molecule 60 is a protein called Ribosomal protein 63, mitochondrial.

Mol	Chain	Residues	Atoms					AltConf	Trace
60	o	94	Total	C	N	O	S	0	0
			797	501	165	128	3		

- Molecule 61 is a protein called Growth arrest and DNA damage-inducible proteins-interacting protein 1.

Mol	Chain	Residues	Atoms					AltConf	Trace
61	q	168	Total	C	N	O	S	0	0
			1294	801	255	233	5		

- Molecule 62 is a protein called 39S ribosomal protein S18a, mitochondrial.

Mol	Chain	Residues	Atoms					AltConf	Trace
62	r	162	Total	C	N	O	S	0	0
			1322	839	252	223	8		

- Molecule 63 is a protein called 39S ribosomal protein L11, mitochondrial.

Mol	Chain	Residues	Atoms					AltConf	Trace
63	J	175	Total	C	N	O	S	0	0
			1330	847	237	244	2		

- Molecule 64 is a protein called 39S ribosomal protein L10, mitochondrial.

Mol	Chain	Residues	Atoms					AltConf	Trace
64	I	179	Total	C	N	O	S	0	0
			1435	925	258	242	10		

- Molecule 65 is a protein called 39S ribosomal protein L16, mitochondrial.

Mol	Chain	Residues	Atoms					AltConf	Trace
65	N	222	Total	C	N	O	S	0	0
			1786	1143	326	307	10		

- Molecule 66 is a protein called Mitochondrial ribosomal protein L18, isoform CRA_b.

Mol	Chain	Residues	Atoms					AltConf	Trace
66	P	143	Total	C	N	O	S	0	0
			1165	729	223	208	5		

- Molecule 67 is a protein called 39S ribosomal protein L23, mitochondrial.

Mol	Chain	Residues	Atoms					AltConf	Trace
			Total	C	N	O	S		
67	U	152	1224	774	233	214	3	0	0

- Molecule 68 is a protein called 39S ribosomal protein L24, mitochondrial.

Mol	Chain	Residues	Atoms					AltConf	Trace
			Total	C	N	O	S		
68	V	206	1682	1071	299	304	8	0	0

- Molecule 69 is a protein called 39S ribosomal protein L3, mitochondrial.

Mol	Chain	Residues	Atoms					AltConf	Trace
			Total	C	N	O	S		
69	E	306	2410	1547	419	433	11	0	0

- Molecule 70 is a protein called 39S ribosomal protein L37, mitochondrial.

Mol	Chain	Residues	Atoms					AltConf	Trace
			Total	C	N	O	S		
70	5	394	3210	2073	560	566	11	0	0

- Molecule 71 is a protein called 39S ribosomal protein L38, mitochondrial.

Mol	Chain	Residues	Atoms					AltConf	Trace
			Total	C	N	O	S		
71	6	354	2948	1881	525	533	9	0	0

- Molecule 72 is a protein called 39S ribosomal protein L39, mitochondrial.

Mol	Chain	Residues	Atoms					AltConf	Trace
			Total	C	N	O	S		
72	7	297	2410	1540	409	443	18	0	0

- Molecule 73 is a protein called 39S ribosomal protein L41, mitochondrial.

Mol	Chain	Residues	Atoms					AltConf	Trace
			Total	C	N	O	S		
73	9	124	997	644	170	181	2	0	0

- Molecule 74 is a protein called 39S ribosomal protein L42, mitochondrial.

Mol	Chain	Residues	Atoms					AltConf	Trace
			Total	C	N	O	S		
74	a	108	896	560	162	169	5	0	0

- Molecule 75 is a protein called 39S ribosomal protein L44, mitochondrial.

Mol	Chain	Residues	Atoms					AltConf	Trace
			Total	C	N	O	S		
75	c	289	2322	1483	400	430	9	0	0

- Molecule 76 is a protein called 39S ribosomal protein L45, mitochondrial.

Mol	Chain	Residues	Atoms					AltConf	Trace
			Total	C	N	O	S		
76	d	257	2075	1326	363	372	14	0	0

- Molecule 77 is a protein called 39S ribosomal protein L48, mitochondrial.

Mol	Chain	Residues	Atoms					AltConf	Trace
			Total	C	N	O	S		
77	f	146	1126	714	186	222	4	0	0

- Molecule 78 is a protein called 39S ribosomal protein L50, mitochondrial.

Mol	Chain	Residues	Atoms					AltConf	Trace
			Total	C	N	O	S		
78	h	110	894	568	156	167	3	0	0

- Molecule 79 is a protein called 39S ribosomal protein L53, mitochondrial.

Mol	Chain	Residues	Atoms					AltConf	Trace
			Total	C	N	O	S		
79	k	96	743	462	143	133	5	0	0

- Molecule 80 is a protein called 39S ribosomal protein L54, mitochondrial.

Mol	Chain	Residues	Atoms					AltConf	Trace
			Total	C	N	O	S		
80	l	72	619	394	112	111	2	0	0

- Molecule 81 is a protein called Peptidyl-tRNA hydrolase ICT1, mitochondrial.

Mol	Chain	Residues	Atoms					AltConf	Trace
81	p	152	Total	C	N	O	S	0	0
			1227	762	232	229	4		

- Molecule 82 is a protein called 39S ribosomal protein S30, mitochondrial.

Mol	Chain	Residues	Atoms					AltConf	Trace
82	s	393	Total	C	N	O	S	0	0
			3178	2036	565	563	14		

- Molecule 83 is a protein called 39S ribosomal protein L19, mitochondrial.

Mol	Chain	Residues	Atoms					AltConf	Trace
83	Q	240	Total	C	N	O	S	0	0
			1995	1280	354	352	9		

- Molecule 84 is a protein called 39S ribosomal protein L12, mitochondrial.

Mol	Chain	Residues	Atoms				AltConf	Trace
84	TA	45	Total	C	N	O	0	0
			345	222	54	69		
84	TB	27	Total	C	N	O	0	0
			213	137	33	43		
84	TC	71	Total	C	N	O	0	0
			352	210	71	71		

- Molecule 85 is a protein called P-site finger.

Mol	Chain	Residues	Atoms				AltConf	Trace
85	u	65	Total	C	N	O	0	0
			325	195	65	65		

- Molecule 86 is a protein called Elongation factor G, mitochondrial.

Mol	Chain	Residues	Atoms					AltConf	Trace
86	v	712	Total	C	N	O	S	0	0
			5546	3494	957	1062	33		

- Molecule 87 is a DNA chain called mRNA.

Mol	Chain	Residues	Atoms					AltConf	Trace
87	A5	11	Total	C	N	O	P	0	0
			213	104	32	66	11		

- Molecule 88 is a DNA chain called E-tRNA.

Mol	Chain	Residues	Atoms					AltConf	Trace
			Total	C	N	O	P		
88	A7	62	1197	586	180	370	61	0	0

- Molecule 89 is MAGNESIUM ION (three-letter code: MG) (formula: Mg).

Mol	Chain	Residues	Atoms		AltConf
89	AA	26	Total 26	Mg 26	0
89	A2	1	Total 1	Mg 1	0
89	AH	1	Total 1	Mg 1	0
89	A	97	Total 97	Mg 97	0
89	D	1	Total 1	Mg 1	0
89	W	1	Total 1	Mg 1	0
89	g	1	Total 1	Mg 1	0
89	E	1	Total 1	Mg 1	0
89	v	1	Total 1	Mg 1	0

- Molecule 90 is ZINC ION (three-letter code: ZN) (formula: Zn).

Mol	Chain	Residues	Atoms		AltConf
90	AB	1	Total 1	Zn 1	0
90	AO	1	Total 1	Zn 1	0
90	AP	1	Total 1	Zn 1	0
90	AT	1	Total 1	Zn 1	0
90	0	1	Total 1	Zn 1	0
90	4	1	Total 1	Zn 1	0
90	r	1	Total 1	Zn 1	0

- Molecule 91 is GUANOSINE-5'-DIPHOSPHATE (three-letter code: GDP) (formula: $C_{10}H_{15}N_5O_{11}P_2$).

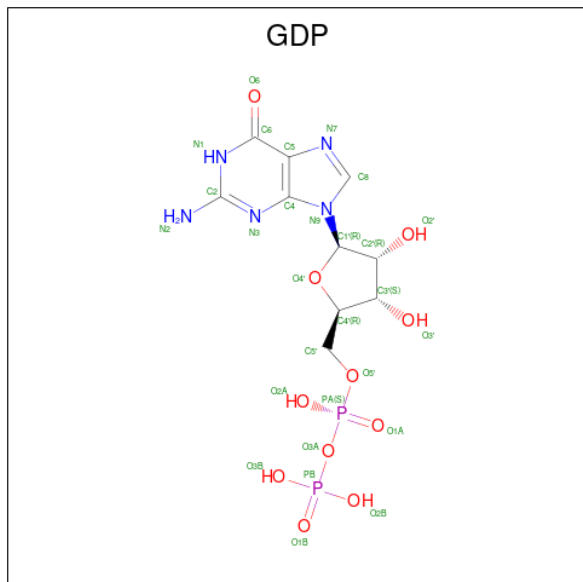

Mol	Chain	Residues	Atoms					AltConf
			Total	C	N	O	P	
91	AX	1	28	10	5	11	2	0

- Molecule 92 is PHOSPHOMETHYLPHOSPHONIC ACID GUANYLATE ESTER (three-letter code: GCP) (formula: $C_{11}H_{18}N_5O_{13}P_3$).

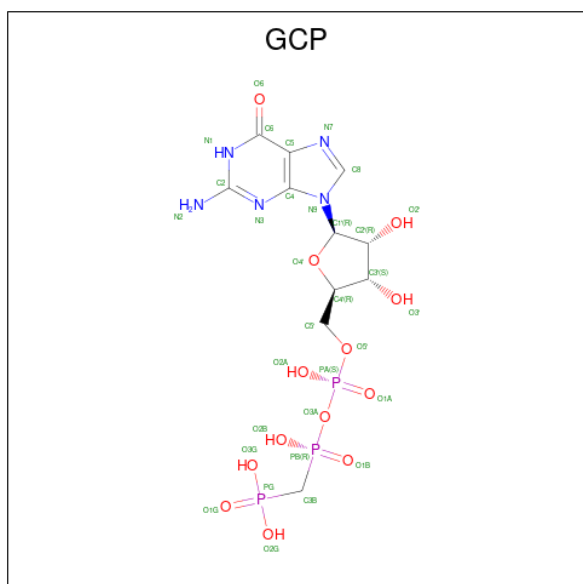

Mol	Chain	Residues	Atoms					AltConf
			Total	C	N	O	P	
92	v	1	32	11	5	13	3	0

3 Residue-property plots

These plots are drawn for all protein, RNA, DNA and oligosaccharide chains in the entry. The first graphic for a chain summarises the proportions of the various outlier classes displayed in the second graphic. The second graphic shows the sequence view annotated by issues in geometry and atom inclusion in map density. Residues are color-coded according to the number of geometric quality criteria for which they contain at least one outlier: green = 0, yellow = 1, orange = 2 and red = 3 or more. A red diamond above a residue indicates a poor fit to the EM map for this residue (all-atom inclusion < 40%). Stretches of 2 or more consecutive residues without any outlier are shown as a green connector. Residues present in the sample, but not in the model, are shown in grey.

- Molecule 1: 12s rRNA

Chain AA:

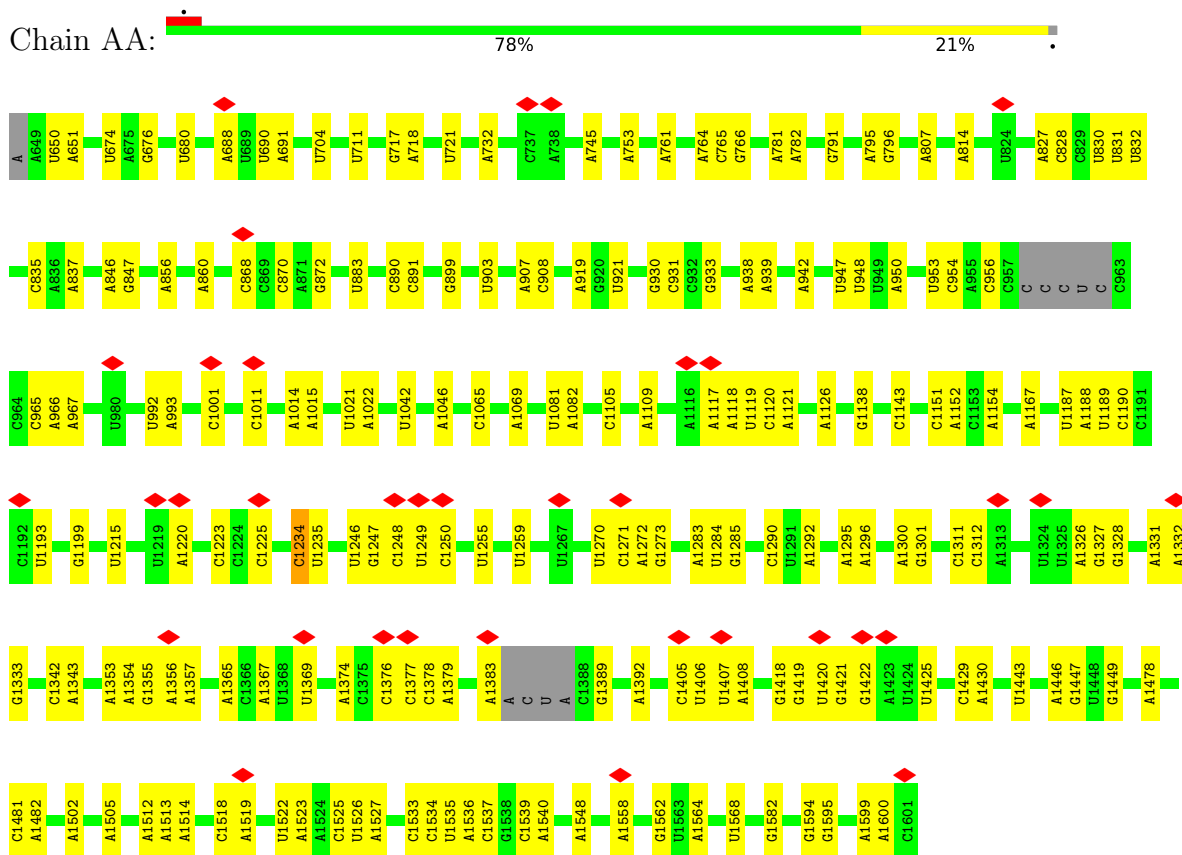

- Molecule 2: 28S ribosomal protein S2, mitochondrial

Chain AB:

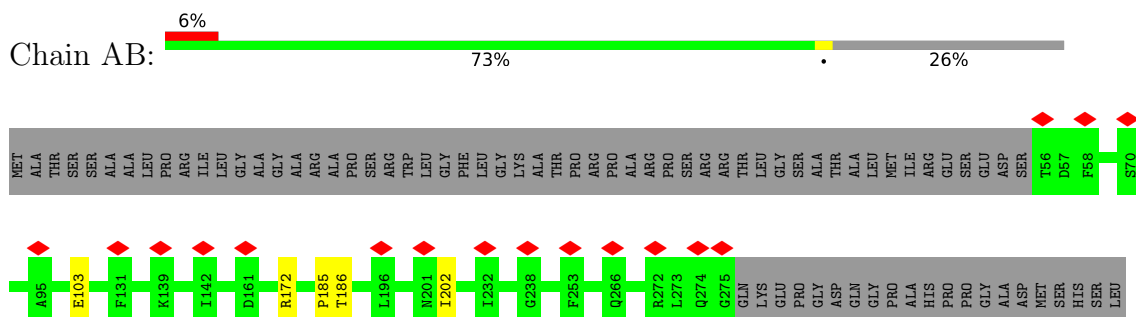

• Molecule 3: 28S ribosomal protein S24, mitochondrial

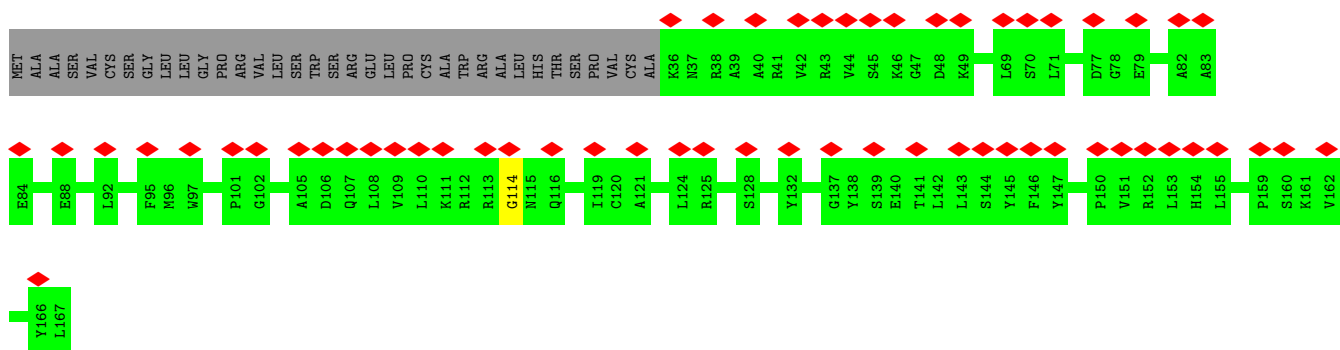
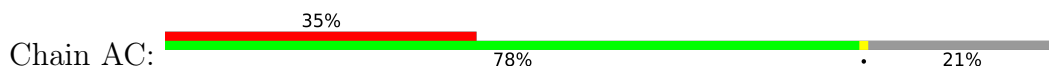

• Molecule 4: 28S ribosomal protein S6, mitochondrial

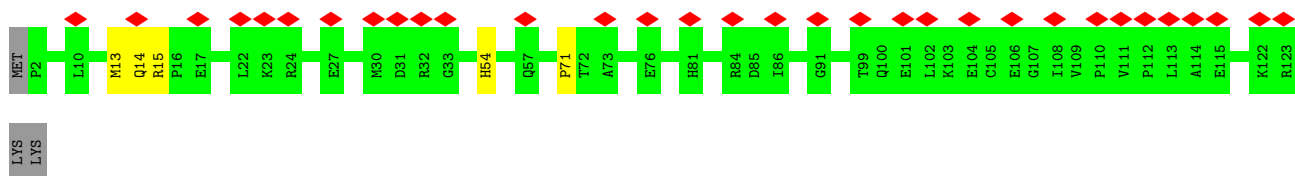

• Molecule 5: 28S ribosomal protein S11, mitochondrial

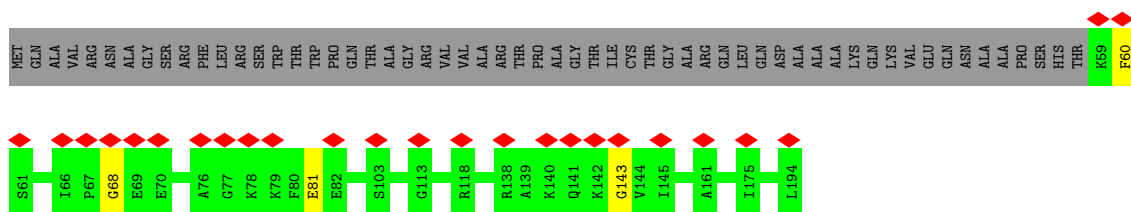

• Molecule 6: 28S ribosomal protein S12, mitochondrial

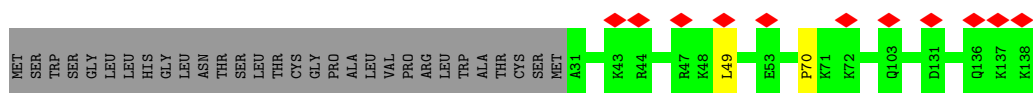
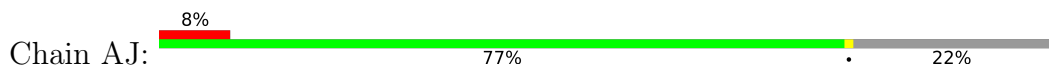

• Molecule 7: 28S ribosomal protein S14, mitochondrial

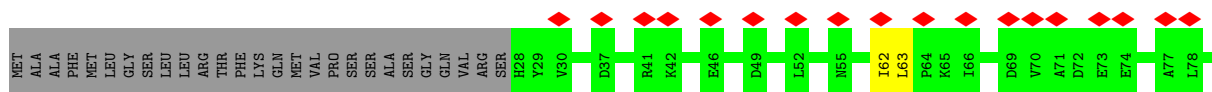
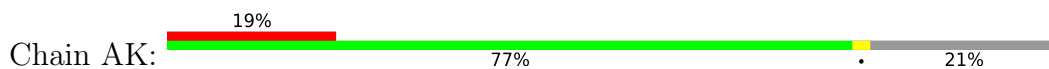

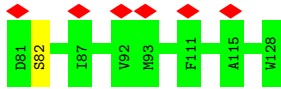

- Molecule 8: 28S ribosomal protein S16, mitochondrial

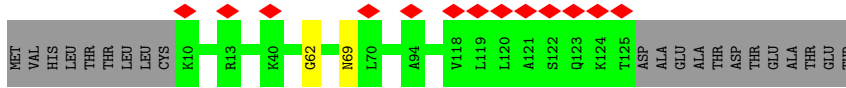
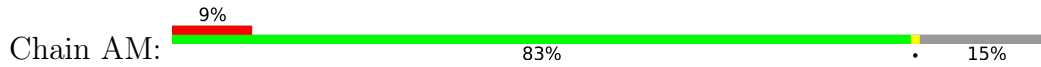

- Molecule 9: 28S ribosomal protein S17, mitochondrial

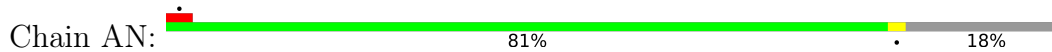

- Molecule 10: 28S ribosomal protein S18b, mitochondrial

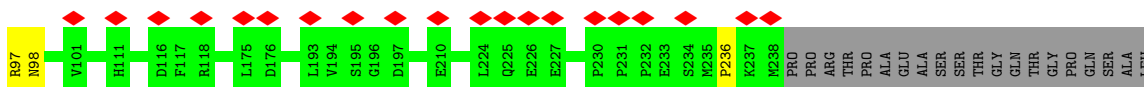
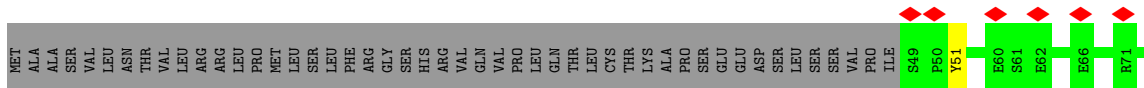
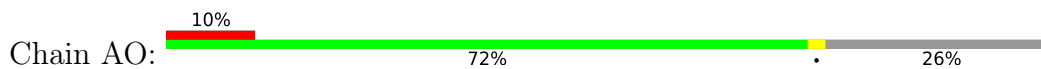

- Molecule 11: 28S ribosomal protein S18c, mitochondrial

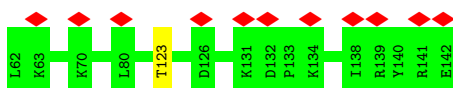
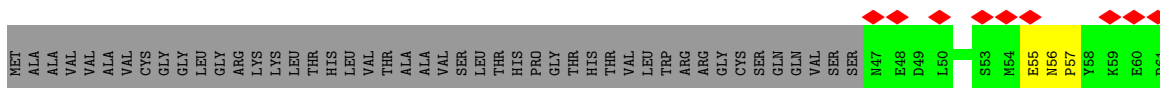

- Molecule 12: 28S ribosomal protein S21, mitochondrial

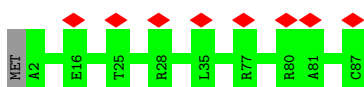

- Molecule 13: 28S ribosomal protein S25, mitochondrial

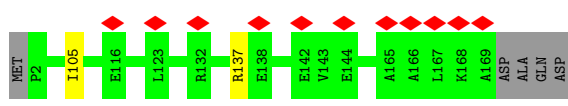

• Molecule 14: 28S ribosomal protein S28, mitochondrial

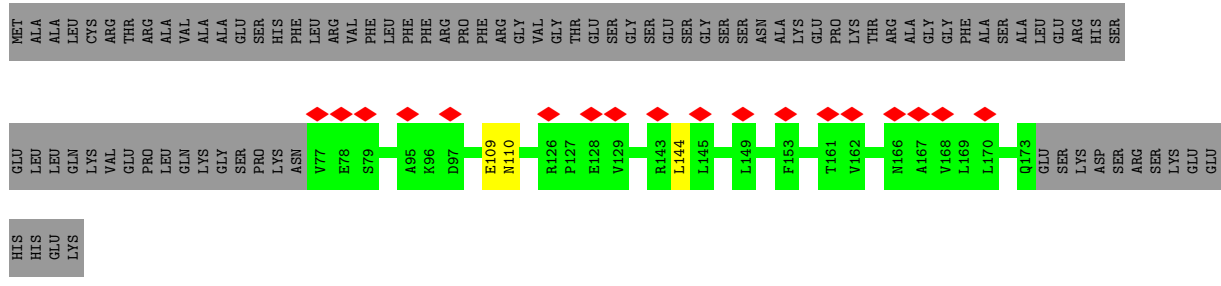

• Molecule 15: 28S ribosomal protein S29, mitochondrial

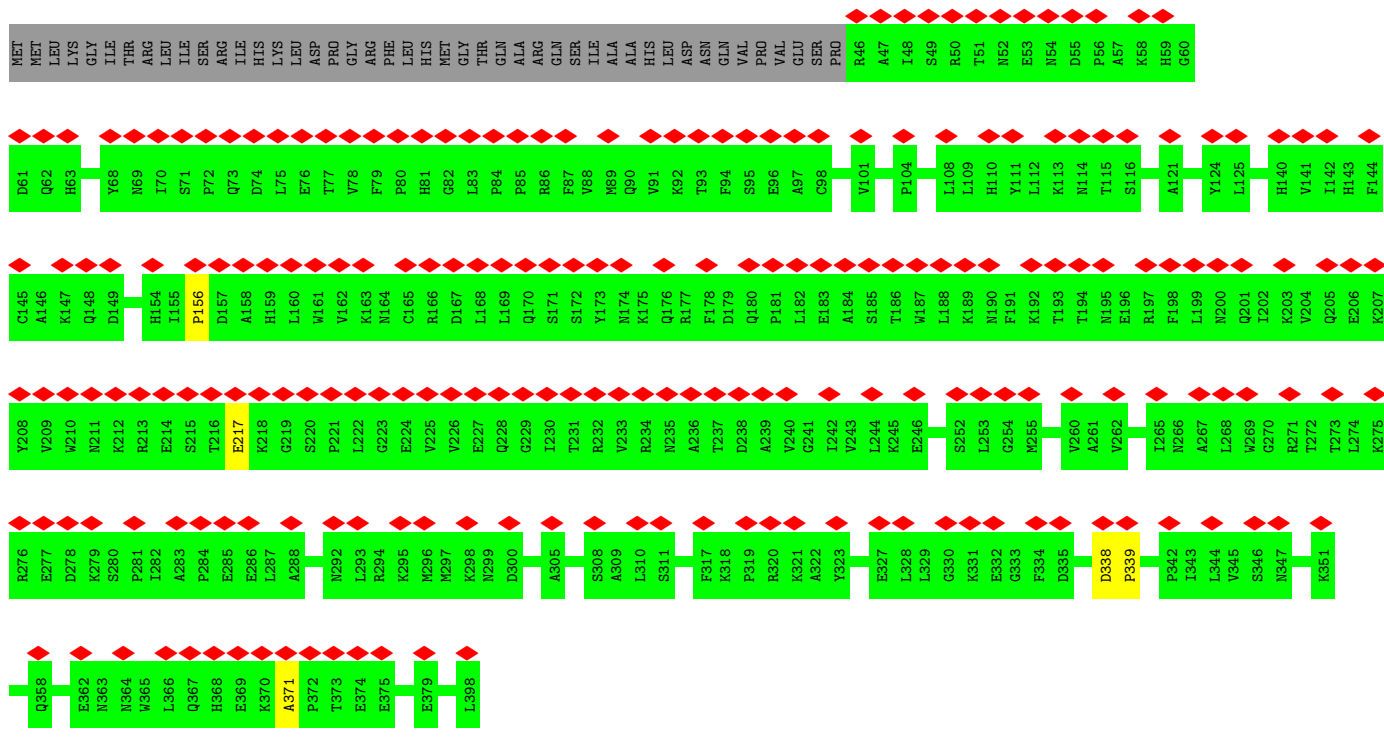
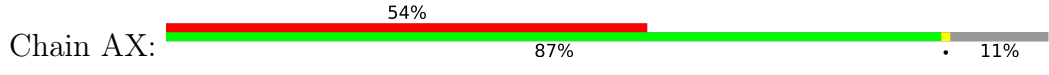

• Molecule 16: Coiled-coil-helix-coiled-coil-helix domain-containing protein 1

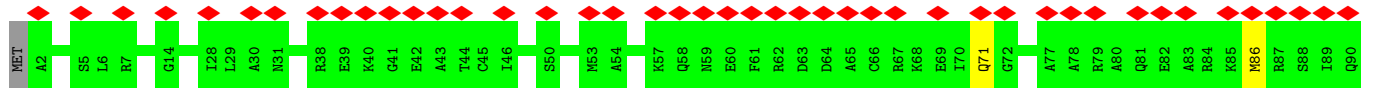

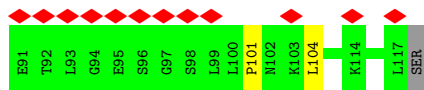

• Molecule 17: 28S ribosomal protein S10, mitochondrial

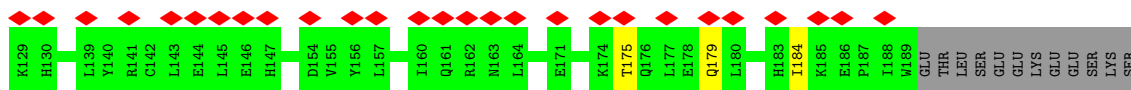
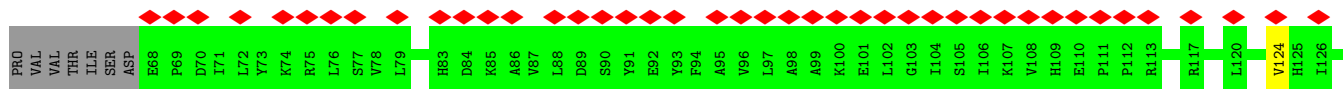

• Molecule 18: 28S ribosomal protein S15, mitochondrial

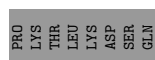
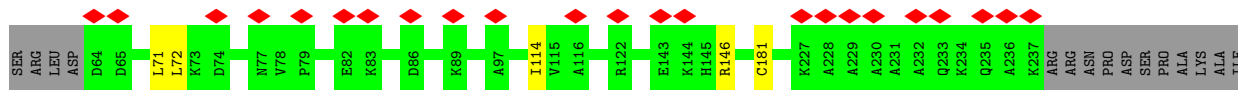
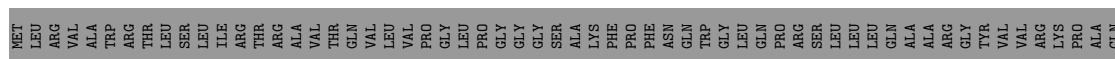

• Molecule 19: 28S ribosomal protein S22, mitochondrial

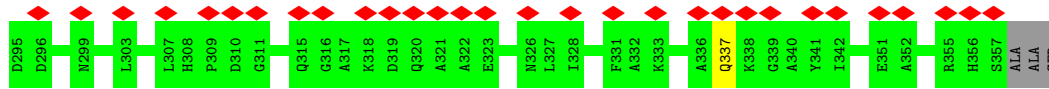
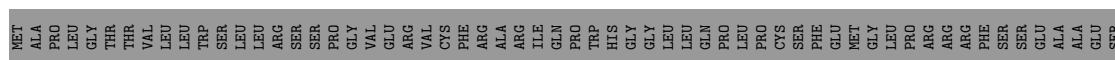
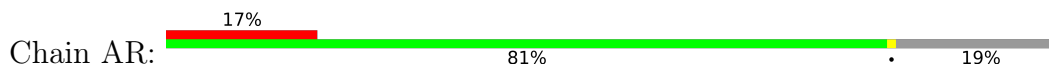

• Molecule 20: 28S ribosomal protein S23, mitochondrial



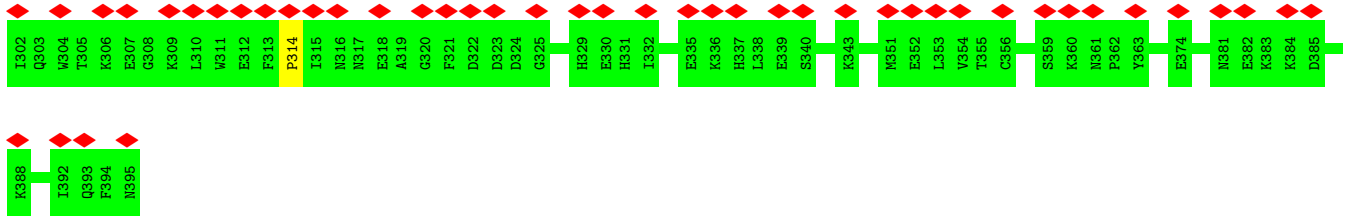

- Molecule 24: 28S ribosomal protein S33, mitochondrial

Chain AZ:

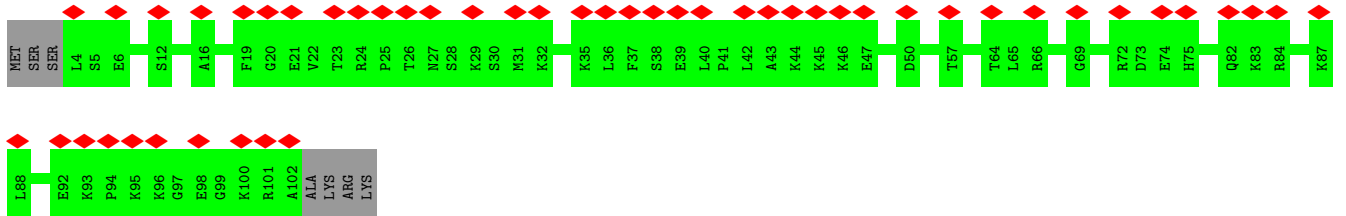

- Molecule 25: 28S ribosomal protein S35, mitochondrial

Chain A1:

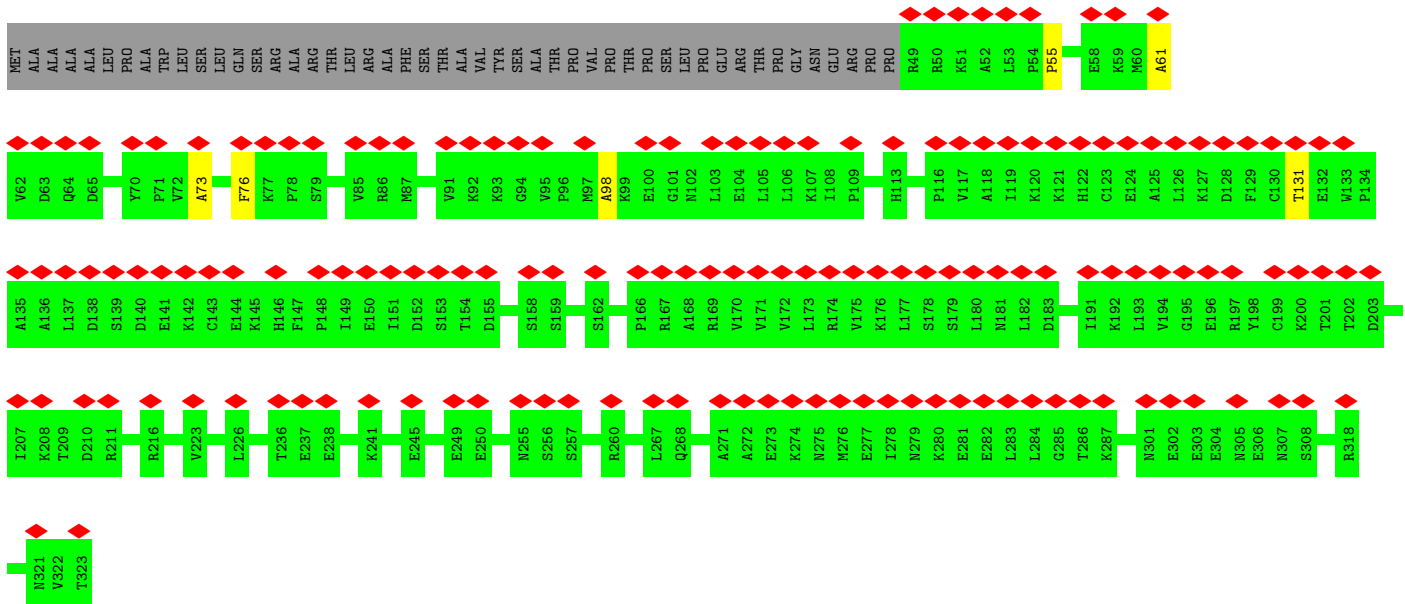

- Molecule 26: 28S ribosomal protein S34, mitochondrial

Chain A0:

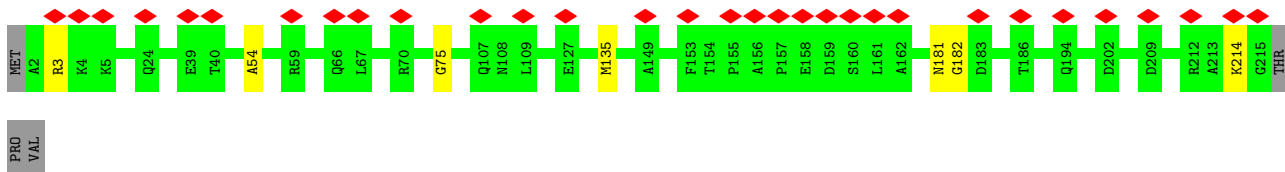

• Molecule 27: Aurora kinase A-interacting protein

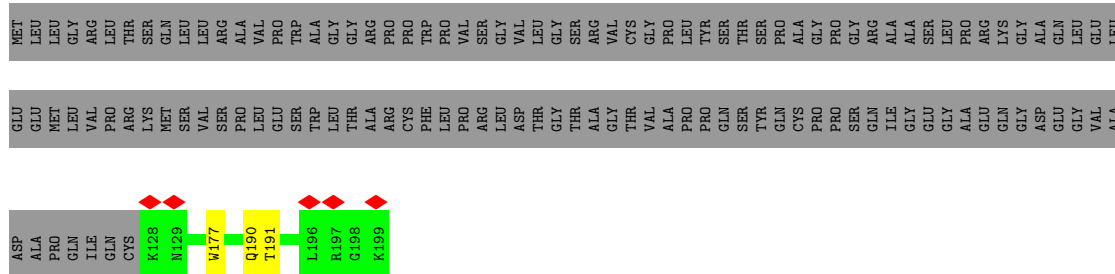

• Molecule 28: Pentatricopeptide repeat domain-containing protein 3, mitochondrial

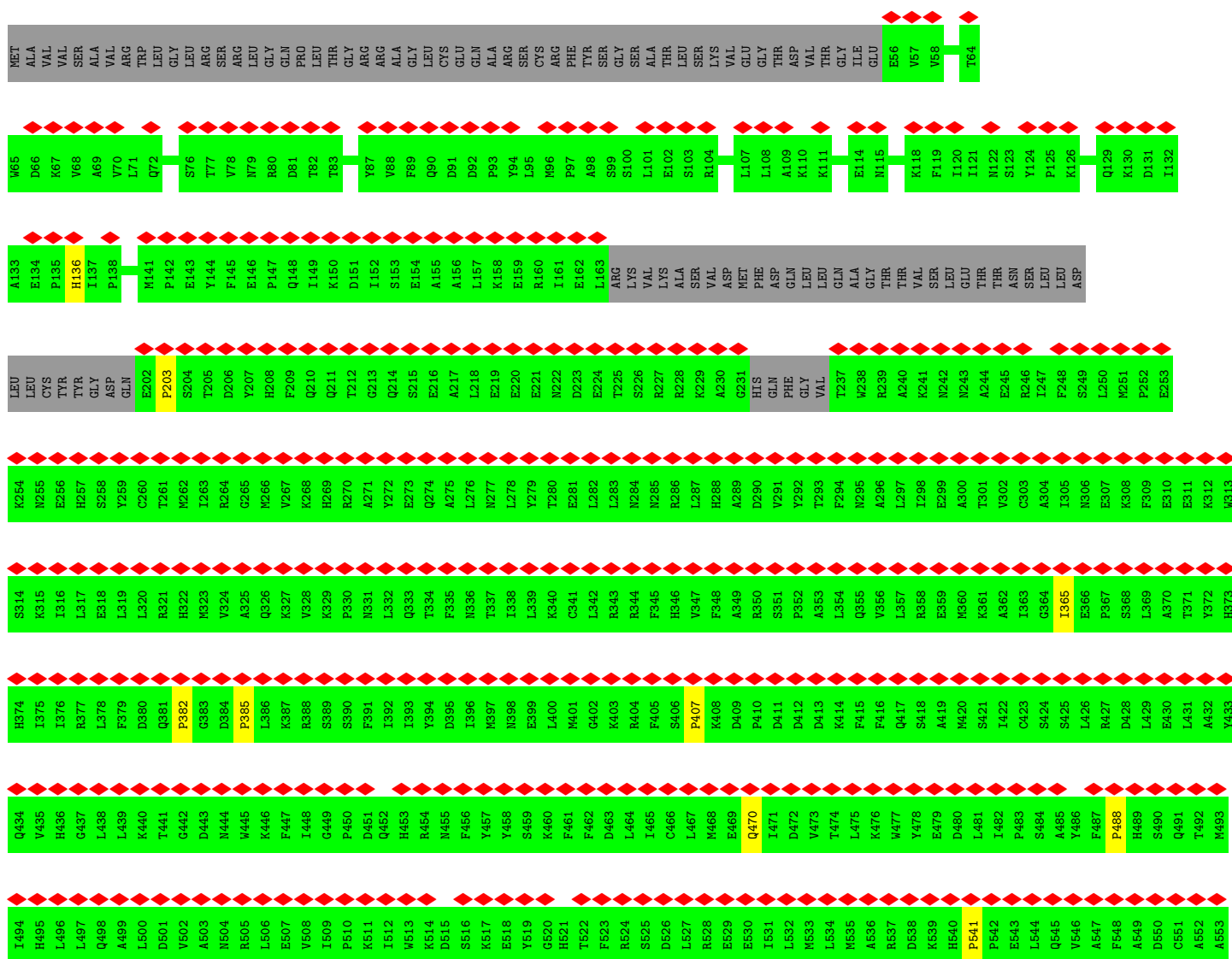
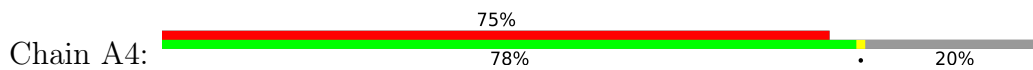

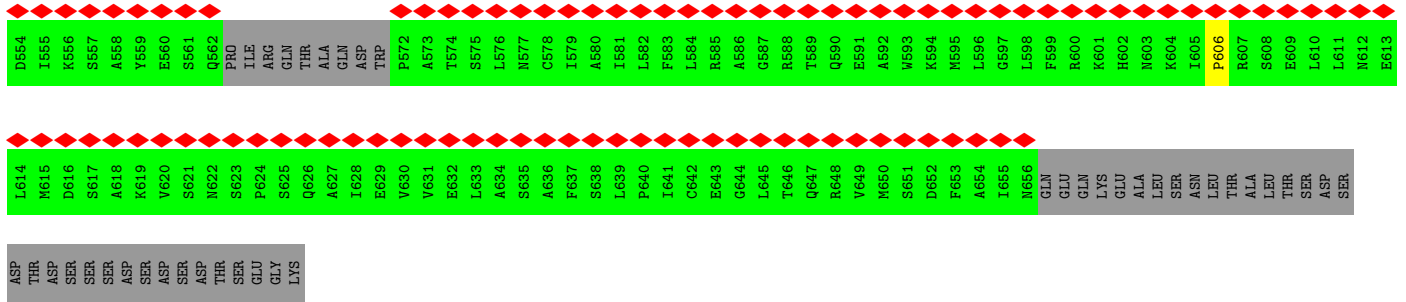

• Molecule 29: 28S ribosomal protein S5, mitochondrial

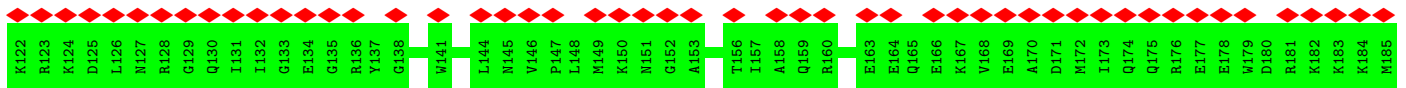
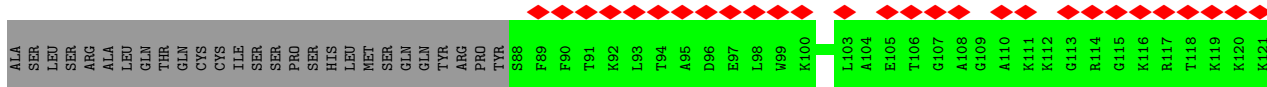
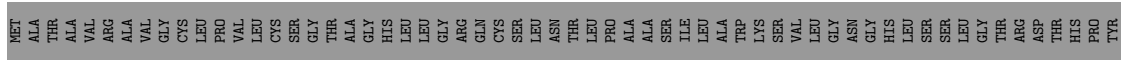
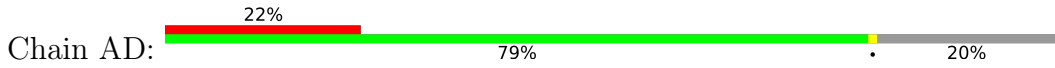

• Molecule 30: 28S ribosomal protein S7, mitochondrial

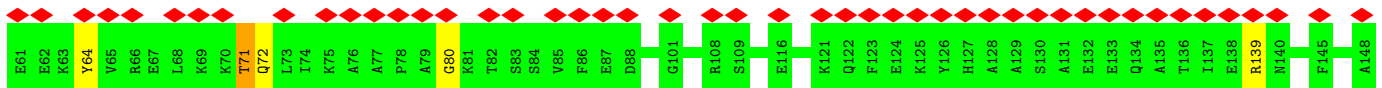
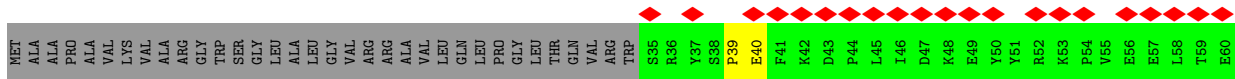
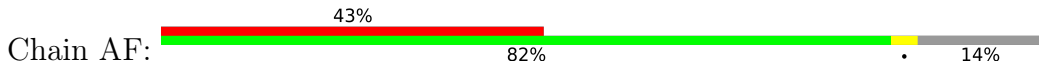

• Molecule 31: 28S ribosomal protein S9, mitochondrial

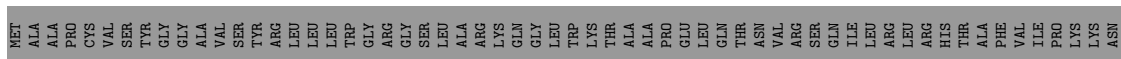
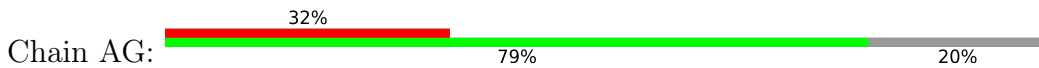

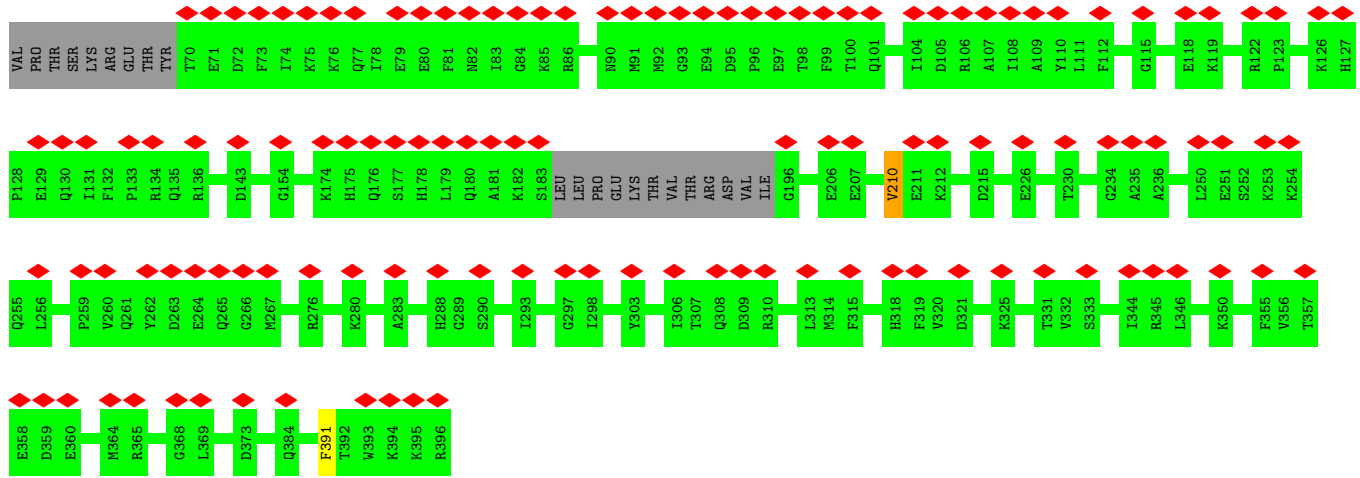

• Molecule 32: 16s rRNA

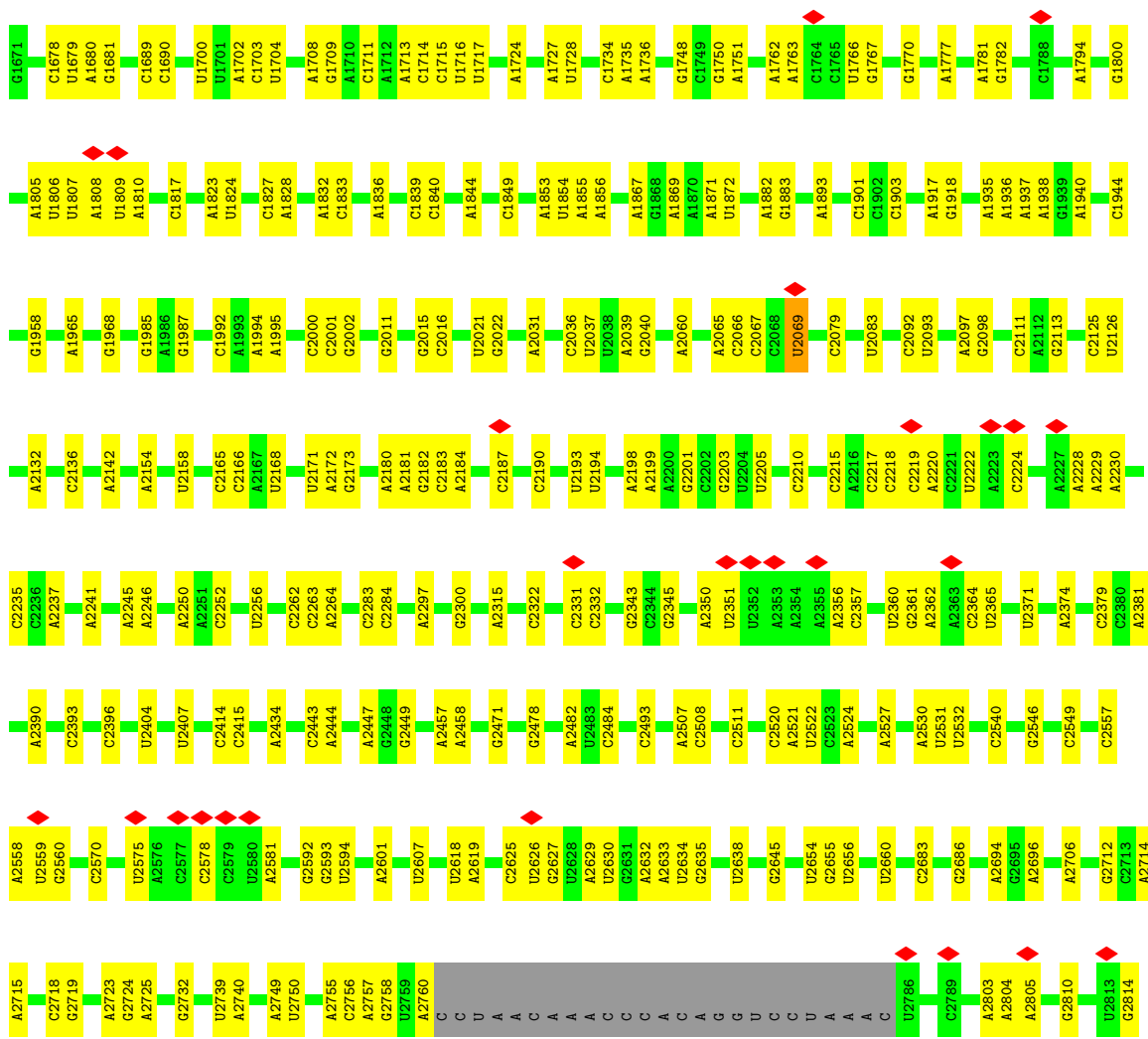
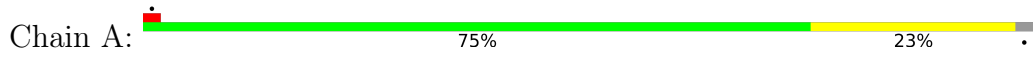

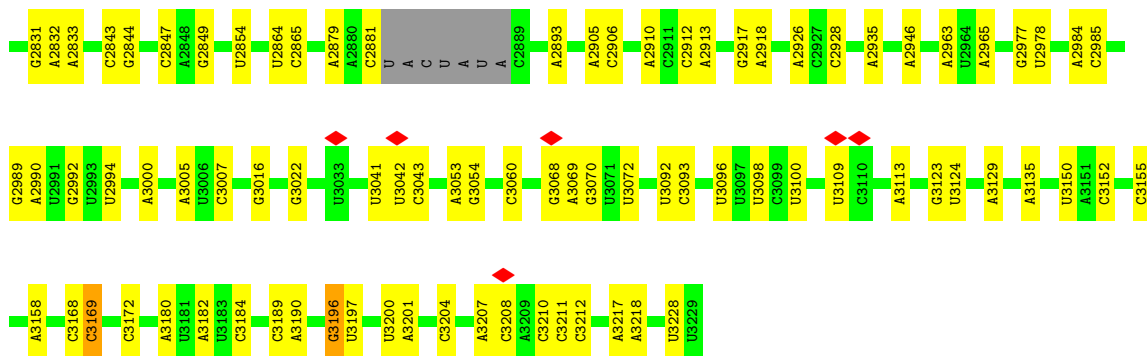

• Molecule 33: tRNAval

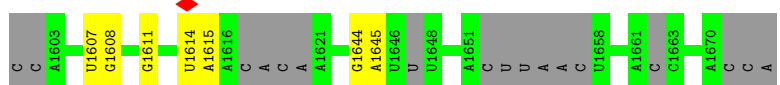

• Molecule 34: 39S ribosomal protein L2, mitochondrial

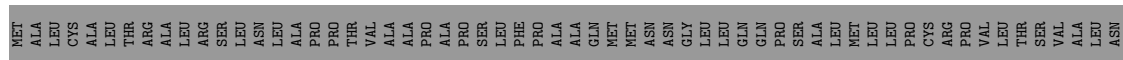
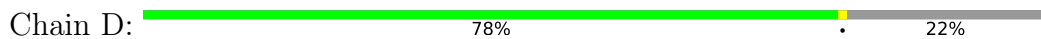

• Molecule 35: 39S ribosomal protein L4, mitochondrial

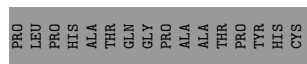
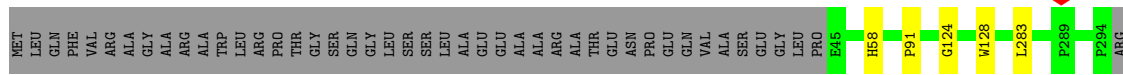
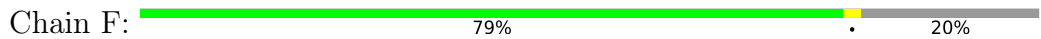

• Molecule 36: 39S ribosomal protein L9, mitochondrial

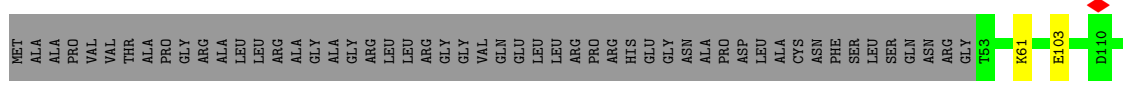

GLU GLU PRO ILE THR ARG TRP GLY GLU TYR TRP CYS GLU VAL THR VAL VAL GLY ASP THR ARG VAL PRO MET SER VAL ASN PHE GLU LYS LYS THR LYS ARG TYR TYR TRP LEU ALA GLN GLN ALA ALA ALA MET ALA ALA PRO THR SER PRO GLN ILE

- Molecule 37: 39S ribosomal protein L13, mitochondrial



- Molecule 38: 39S ribosomal protein L14, mitochondrial

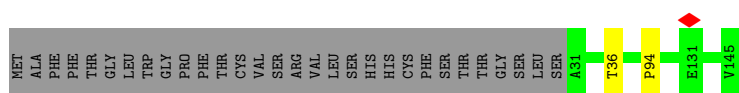
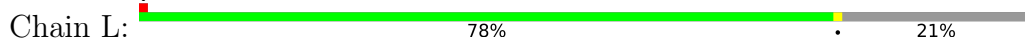

- Molecule 39: 39S ribosomal protein L15, mitochondrial



- Molecule 40: 39S ribosomal protein L17, mitochondrial

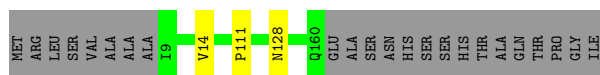
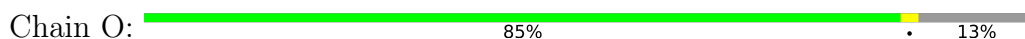

- Molecule 41: 39S ribosomal protein L20, mitochondrial

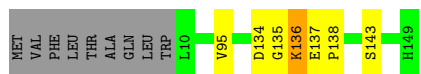
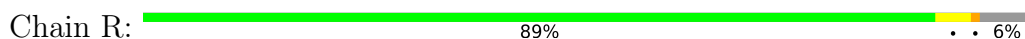

- Molecule 42: 39S ribosomal protein L21, mitochondrial

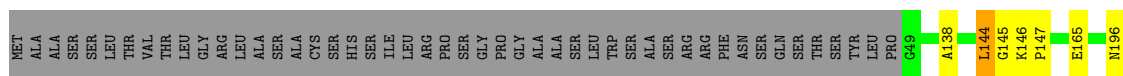

- Molecule 43: 39S ribosomal protein L22, mitochondrial

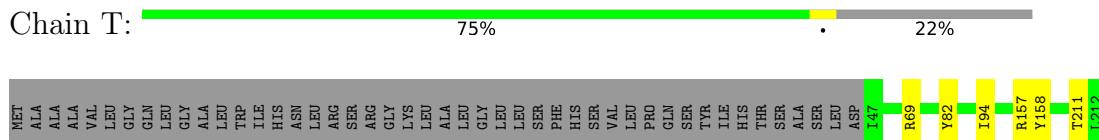

- Molecule 44: 39S ribosomal protein L27, mitochondrial

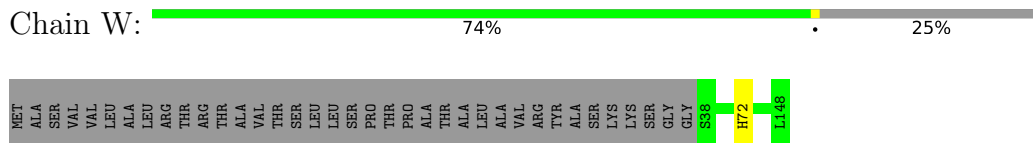

- Molecule 45: 39S ribosomal protein L28, mitochondrial

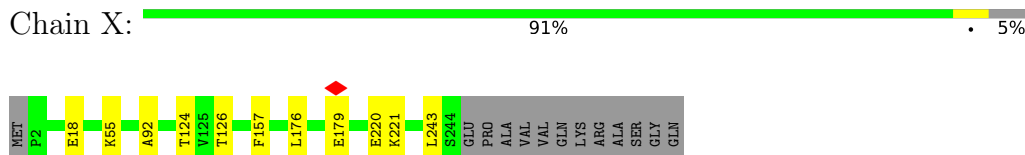

- Molecule 46: 39S ribosomal protein L47, mitochondrial

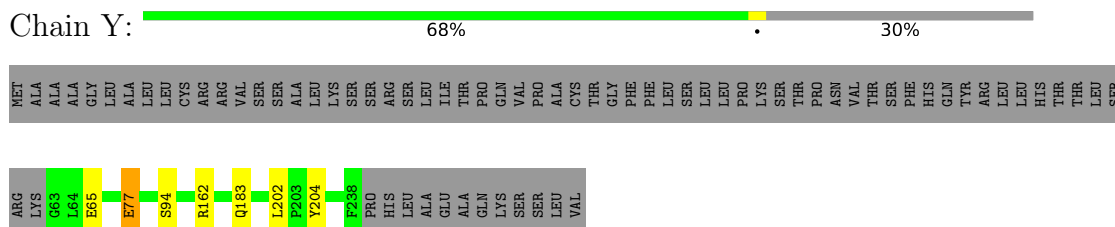

- Molecule 47: 39S ribosomal protein L30, mitochondrial

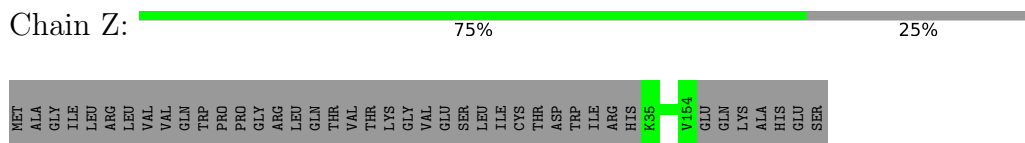

- Molecule 48: 39S ribosomal protein L32, mitochondrial

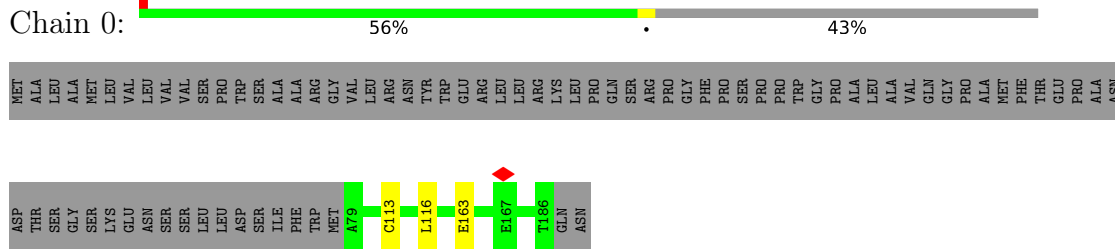

- Molecule 49: 39S ribosomal protein L33, mitochondrial

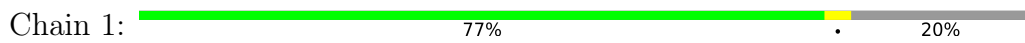

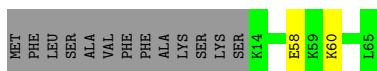

• Molecule 50: 39S ribosomal protein L34, mitochondrial

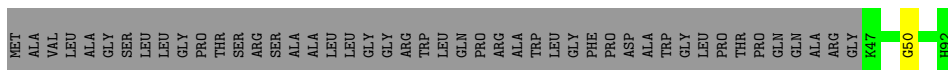

• Molecule 51: 39S ribosomal protein L35, mitochondrial

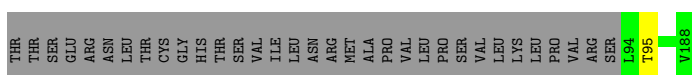

• Molecule 52: 39S ribosomal protein L36, mitochondrial

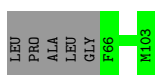
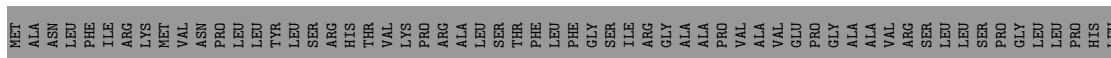

• Molecule 53: 39S ribosomal protein L40, mitochondrial

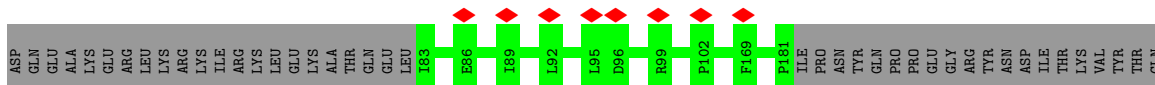
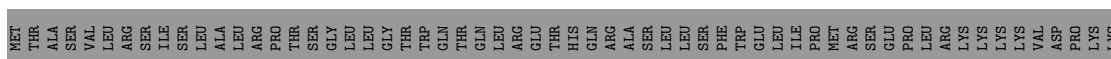

• Molecule 54: 39S ribosomal protein L43, mitochondrial



• Molecule 55: 39S ribosomal protein L46, mitochondrial

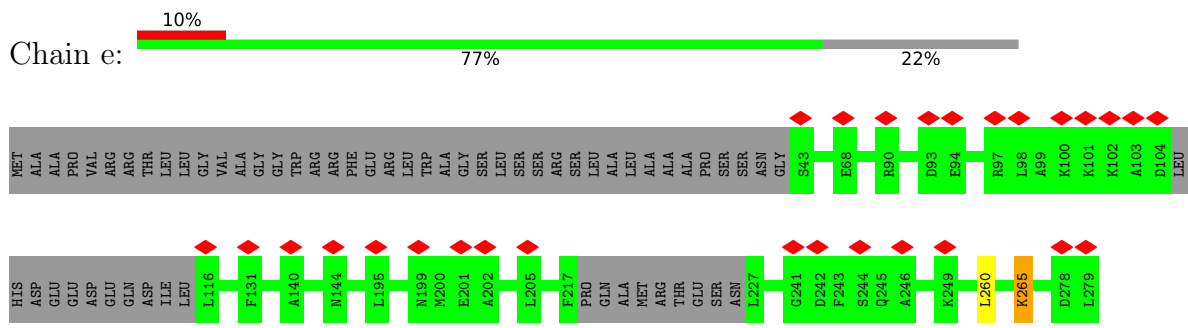

• Molecule 56: 39S ribosomal protein L49, mitochondrial

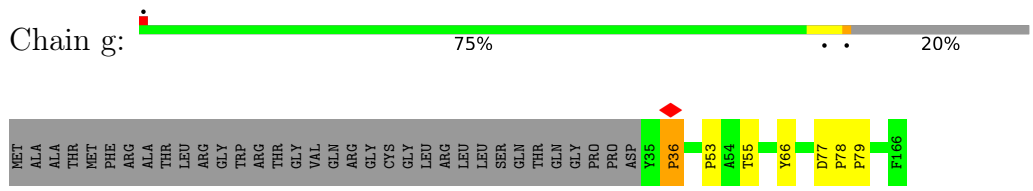

• Molecule 57: 39S ribosomal protein L51, mitochondrial

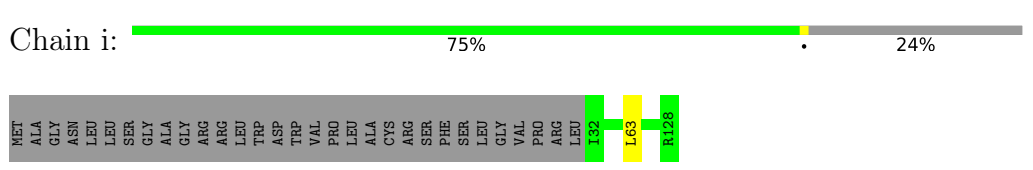

• Molecule 58: cDNA FLJ76418, highly similar to Homo sapiens mitochondrial ribosomal protein L52 (MRPL52), transcript variant 1, mRNA

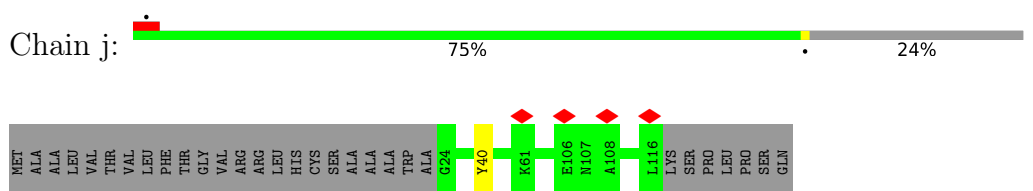

• Molecule 59: 39S ribosomal protein L55, mitochondrial

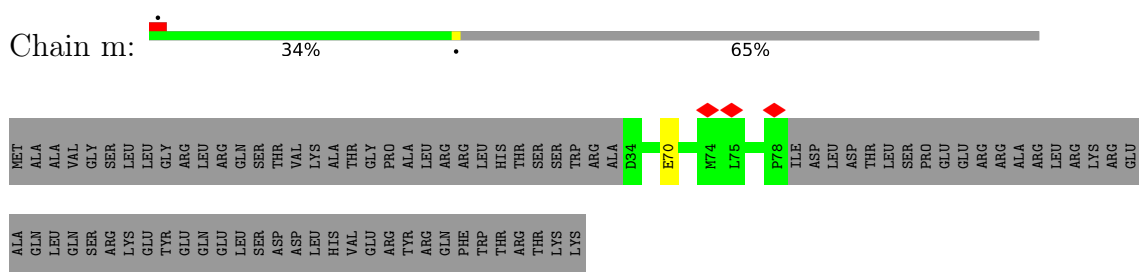

• Molecule 60: Ribosomal protein 63, mitochondrial

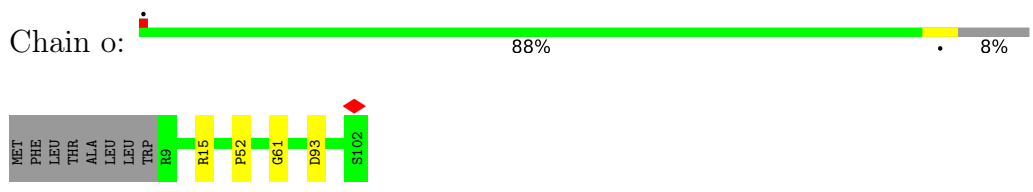

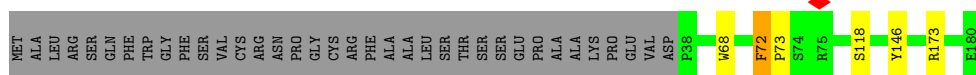
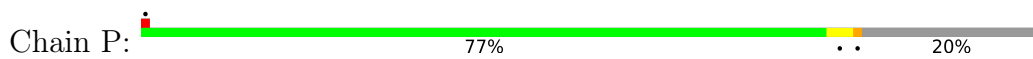

• Molecule 67: 39S ribosomal protein L23, mitochondrial



• Molecule 68: 39S ribosomal protein L24, mitochondrial

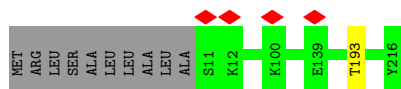

• Molecule 69: 39S ribosomal protein L3, mitochondrial

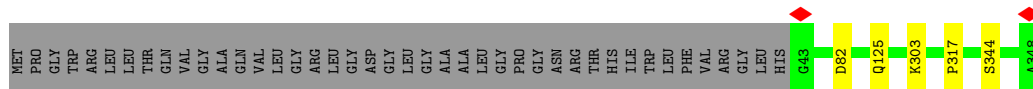
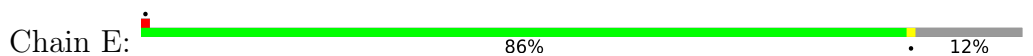

• Molecule 70: 39S ribosomal protein L37, mitochondrial

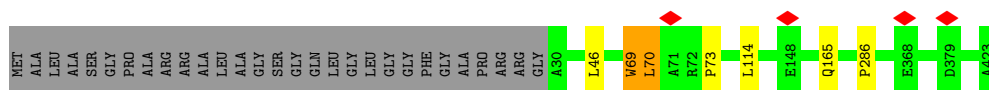
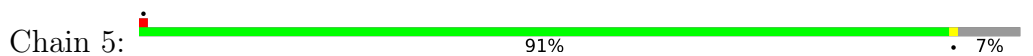

• Molecule 71: 39S ribosomal protein L38, mitochondrial

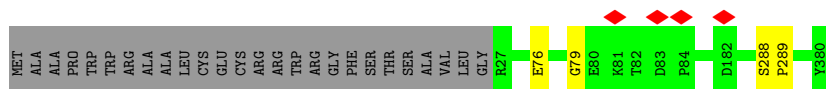
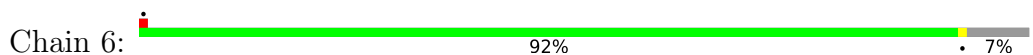

• Molecule 72: 39S ribosomal protein L39, mitochondrial

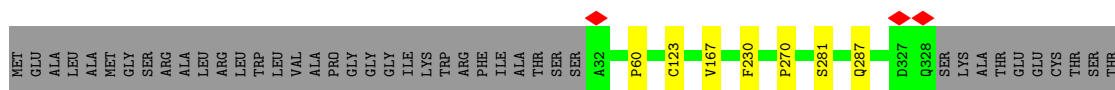
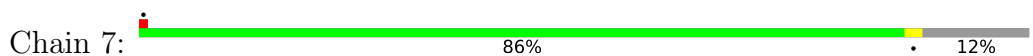

- Molecule 73: 39S ribosomal protein L41, mitochondrial

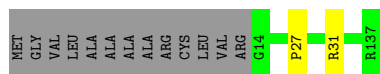
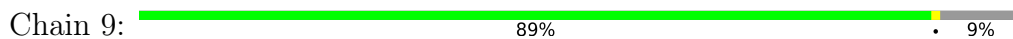

- Molecule 74: 39S ribosomal protein L42, mitochondrial

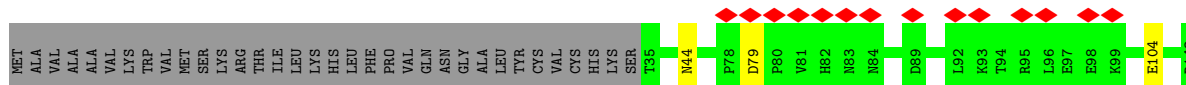
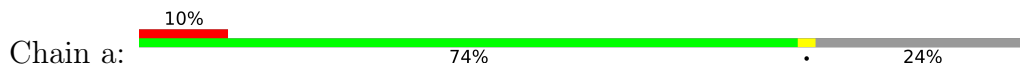

- Molecule 75: 39S ribosomal protein L44, mitochondrial

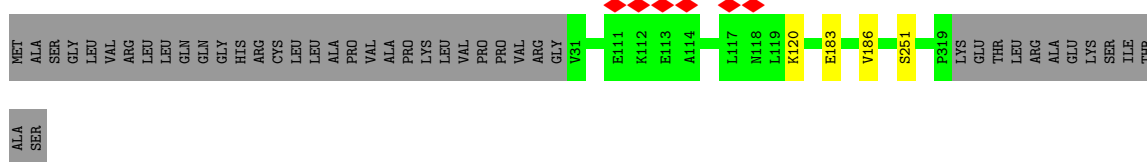
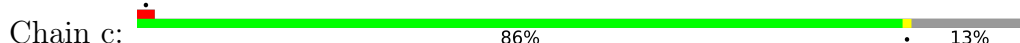

- Molecule 76: 39S ribosomal protein L45, mitochondrial

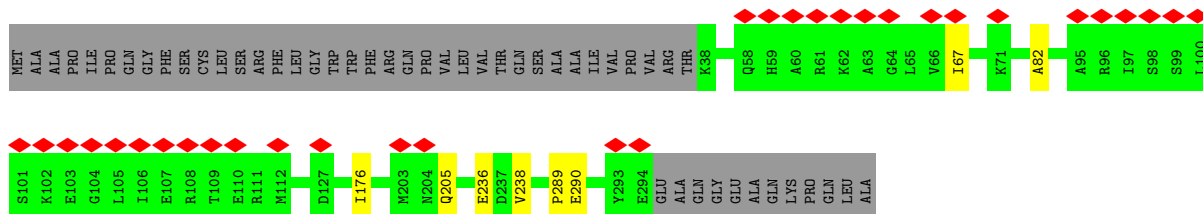
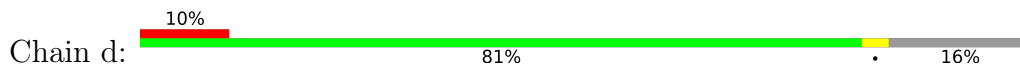

- Molecule 77: 39S ribosomal protein L48, mitochondrial

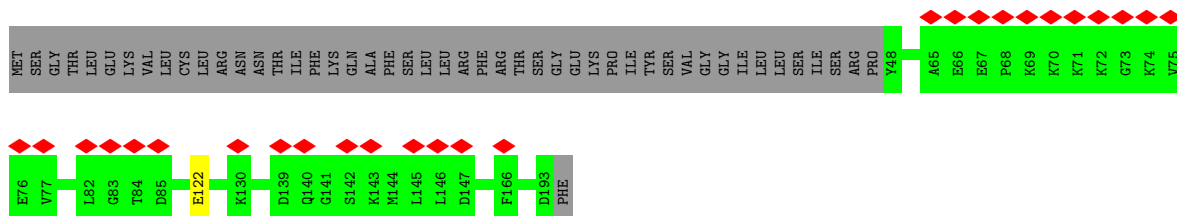
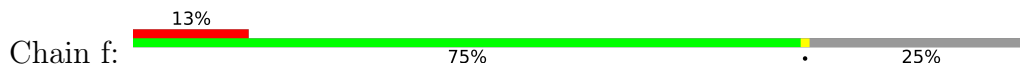

- Molecule 78: 39S ribosomal protein L50, mitochondrial



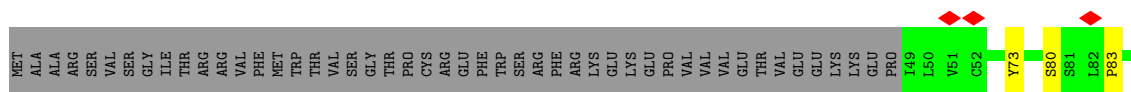

Y158

- Molecule 79: 39S ribosomal protein L53, mitochondrial

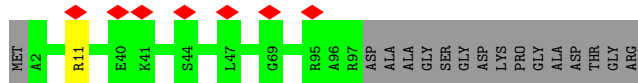
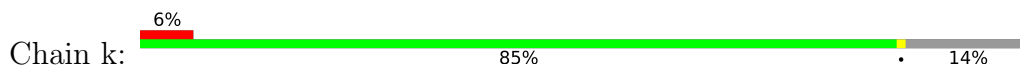

- Molecule 80: 39S ribosomal protein L54, mitochondrial

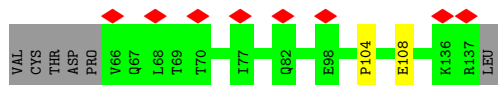
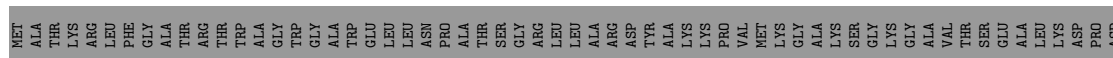

- Molecule 81: Peptidyl-tRNA hydrolase ICT1, mitochondrial

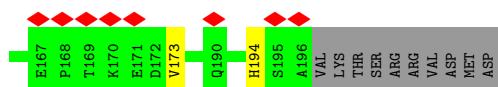
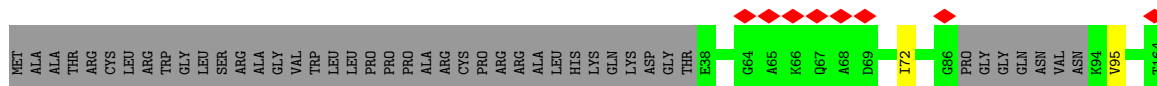

- Molecule 82: 39S ribosomal protein S30, mitochondrial

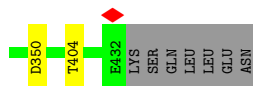
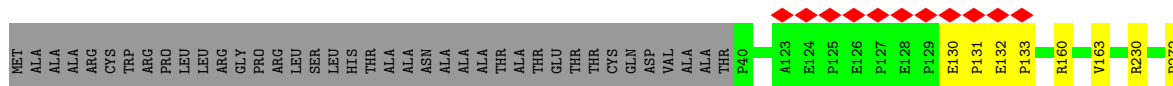
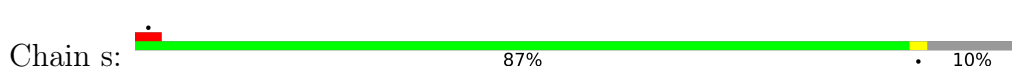

- Molecule 83: 39S ribosomal protein L19, mitochondrial

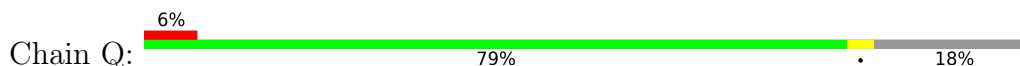

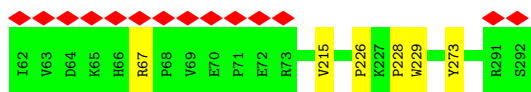
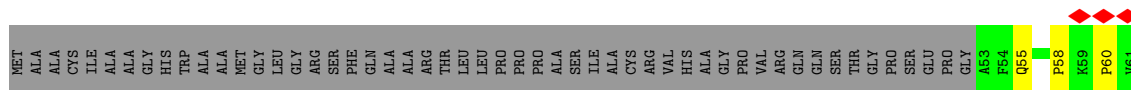

• Molecule 84: 39S ribosomal protein L12, mitochondrial

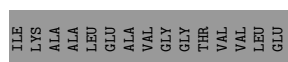
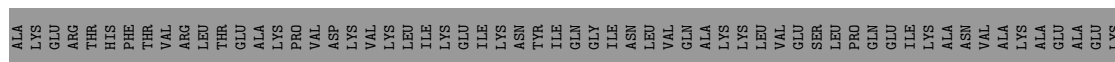
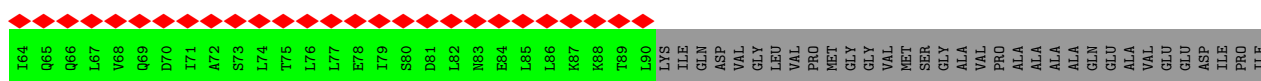
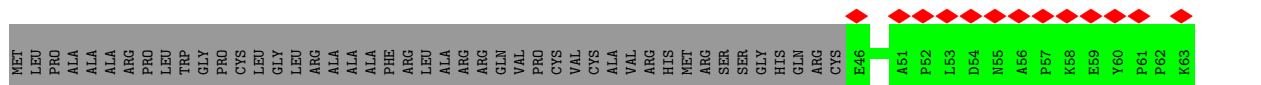

• Molecule 84: 39S ribosomal protein L12, mitochondrial

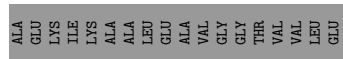
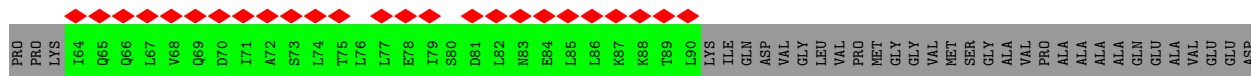
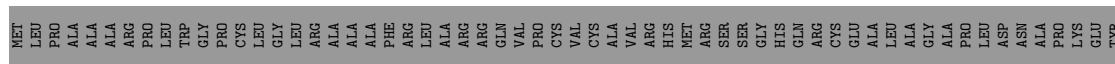

• Molecule 84: 39S ribosomal protein L12, mitochondrial

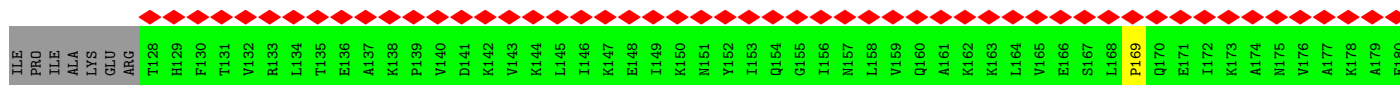
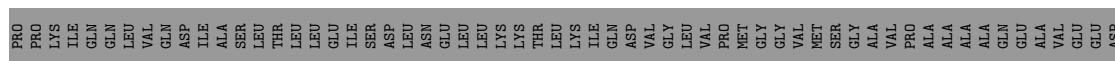

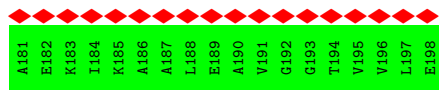

• Molecule 85: P-site finger

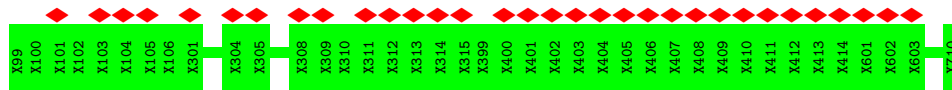

• Molecule 86: Elongation factor G, mitochondrial

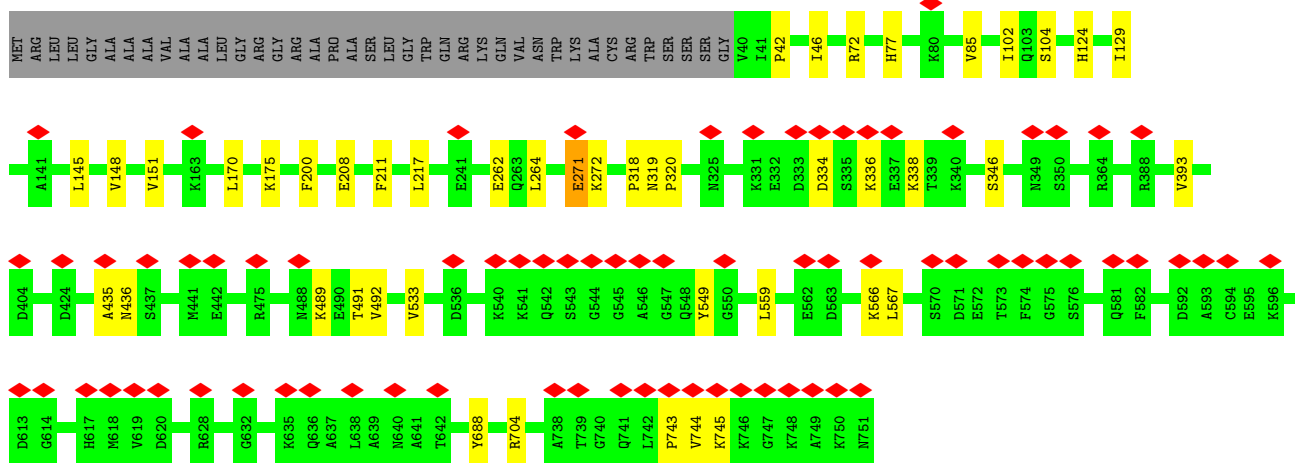
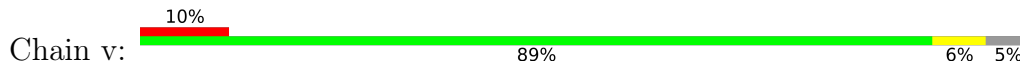

• Molecule 87: mRNA

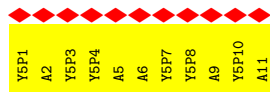

• Molecule 88: E-tRNA

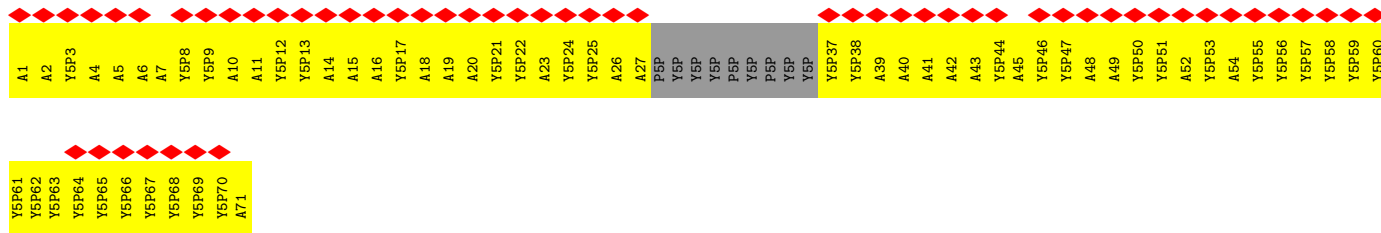
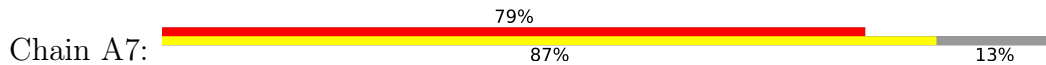

4 Experimental information

Property	Value	Source
EM reconstruction method	SINGLE PARTICLE	Depositor
Imposed symmetry	POINT, Not provided	
Number of particles used	99804	Depositor
Resolution determination method	FSC 0.143 CUT-OFF	Depositor
CTF correction method	PHASE FLIPPING AND AMPLITUDE CORRECTION	Depositor
Microscope	FEI TITAN KRIOS	Depositor
Voltage (kV)	300	Depositor
Electron dose ($e^-/\text{\AA}^2$)	69.2	Depositor
Minimum defocus (nm)	Not provided	
Maximum defocus (nm)	Not provided	
Magnification	Not provided	
Image detector	GATAN K2 SUMMIT (4k x 4k)	Depositor
Maximum map value	3.725	Depositor
Minimum map value	-1.810	Depositor
Average map value	0.003	Depositor
Map value standard deviation	0.111	Depositor
Recommended contour level	0.267	Depositor
Map size (Å)	438.44, 438.44, 438.44	wwPDB
Map dimensions	400, 400, 400	wwPDB
Map angles (°)	90.0, 90.0, 90.0	wwPDB
Pixel spacing (Å)	1.0961, 1.0961, 1.0961	Depositor

5 Model quality i

5.1 Standard geometry i

Bond lengths and bond angles in the following residue types are not validated in this section: GCP, GDP, P5P, Y5P, ZN, MG

The Z score for a bond length (or angle) is the number of standard deviations the observed value is removed from the expected value. A bond length (or angle) with $|Z| > 5$ is considered an outlier worth inspection. RMSZ is the root-mean-square of all Z scores of the bond lengths (or angles).

Mol	Chain	Bond lengths		Bond angles	
		RMSZ	# Z >5	RMSZ	# Z >5
1	AA	0.14	0/22406	0.73	11/34881 (0.0%)
2	AB	0.23	0/1830	0.38	0/2477
3	AC	0.23	0/1112	0.38	0/1505
4	AE	0.23	0/989	0.43	0/1335
5	AI	0.24	0/1031	0.45	0/1390
6	AJ	0.23	0/854	0.41	0/1148
7	AK	0.21	0/879	0.37	0/1182
8	AM	0.23	0/941	0.39	0/1265
9	AN	0.23	0/864	0.40	0/1169
10	AO	0.23	0/1624	0.37	0/2209
11	AP	0.23	0/791	0.36	0/1062
12	AQ	0.22	0/752	0.36	0/1001
13	AT	0.24	0/1402	0.39	0/1883
14	AW	0.23	0/778	0.42	0/1048
15	AX	0.23	0/2932	0.39	0/3968
16	A2	0.23	0/939	0.38	0/1256
17	AH	0.23	0/1037	0.40	0/1403
18	AL	0.23	0/1475	0.34	0/1970
19	AR	0.23	0/2435	0.37	0/3288
20	AS	0.24	0/1138	0.37	0/1533
21	AU	0.23	0/1521	0.34	0/2039
22	AV	0.23	0/3071	0.36	0/4147
23	AY	0.24	0/1046	0.40	0/1410
24	AZ	0.24	0/851	0.37	0/1133
25	A1	0.23	0/2277	0.36	0/3079
26	A0	0.22	0/1827	0.38	0/2473
27	A3	0.23	0/650	0.36	0/855
28	A4	0.23	0/3028	0.36	0/4197
29	AD	0.23	0/2783	0.39	0/3724
30	AF	0.23	0/1765	0.38	0/2369
31	AG	0.23	0/2642	0.39	0/3538
32	A	0.14	0/36246	0.74	6/56422 (0.0%)

Mol	Chain	Bond lengths		Bond angles	
		RMSZ	# Z >5	RMSZ	# Z >5
33	B	0.13	0/1328	0.71	0/2056
34	D	0.23	0/1904	0.41	0/2561
35	F	0.23	0/2071	0.39	0/2817
36	H	0.22	0/820	0.41	0/1102
37	K	0.23	0/1495	0.38	0/2029
38	L	0.23	0/904	0.41	0/1218
39	M	0.24	0/2359	0.38	0/3185
40	O	0.23	0/1269	0.39	0/1708
41	R	0.23	0/1174	0.42	1/1572 (0.1%)
42	S	0.23	0/1276	0.47	2/1729 (0.1%)
43	T	0.23	0/1402	0.38	0/1886
44	W	0.24	0/893	0.42	0/1204
45	X	0.23	0/2081	0.37	0/2812
46	Y	0.23	0/1552	0.35	0/2079
47	Z	0.23	0/1003	0.39	0/1354
48	0	0.22	0/895	0.40	0/1201
49	1	0.23	0/438	0.41	0/583
50	2	0.22	0/382	0.38	0/507
51	3	0.23	0/852	0.38	0/1136
52	4	0.22	0/350	0.39	0/461
53	8	0.23	0/855	0.38	0/1152
54	b	0.23	0/1202	0.40	0/1626
55	e	0.24	0/1797	0.40	0/2422
56	g	0.25	0/1132	0.41	0/1543
57	i	0.23	0/849	0.36	0/1135
58	j	0.23	0/755	0.38	0/1016
59	m	0.21	0/379	0.41	0/510
60	o	0.22	0/818	0.36	0/1097
61	q	0.23	0/1325	0.39	0/1799
62	r	0.22	0/1362	0.37	0/1846
63	J	0.30	0/1348	0.47	0/1813
64	I	0.24	0/1467	0.42	0/1984
65	N	0.24	0/1833	0.40	0/2468
66	P	0.25	0/1191	0.48	0/1611
67	U	0.24	0/1254	0.39	0/1700
68	V	0.23	0/1727	0.40	0/2341
69	E	0.24	0/2479	0.40	0/3360
70	5	0.29	1/3305 (0.0%)	0.43	0/4502
71	6	0.23	0/3043	0.39	0/4140
72	7	0.23	0/2467	0.39	0/3337
73	9	0.25	0/1025	0.39	0/1379
74	a	0.22	0/923	0.39	0/1254
75	c	0.24	0/2371	0.37	0/3205

Mol	Chain	Bond lengths		Bond angles	
		RMSZ	# Z >5	RMSZ	# Z >5
76	d	0.24	0/2132	0.40	0/2887
77	f	0.23	0/1144	0.43	0/1551
78	h	0.23	0/917	0.38	0/1249
79	k	0.23	0/754	0.40	0/1017
80	l	0.23	0/636	0.37	0/860
81	p	0.22	0/1246	0.39	0/1675
82	s	0.24	0/3262	0.40	0/4435
83	Q	0.24	0/2044	0.39	0/2757
84	TA	0.23	0/349	0.41	0/475
84	TB	0.21	0/212	0.39	0/286
84	TC	0.24	0/351	0.41	0/488
86	v	0.25	0/5647	0.44	0/7623
All	All	0.21	1/181965 (0.0%)	0.54	20/258102 (0.0%)

Chiral center outliers are detected by calculating the chiral volume of a chiral center and verifying if the center is modelled as a planar moiety or with the opposite hand. A planarity outlier is detected by checking planarity of atoms in a peptide group, atoms in a mainchain group or atoms of a sidechain that are expected to be planar.

Mol	Chain	#Chirality outliers	#Planarity outliers
41	R	0	1
42	S	0	1
56	g	0	1
66	P	0	1
82	s	0	1
86	v	0	1
All	All	0	6

All (1) bond length outliers are listed below:

Mol	Chain	Res	Type	Atoms	Z	Observed(Å)	Ideal(Å)
70	5	69	TRP	CD2-CE2	-6.57	1.33	1.41

All (20) bond angle outliers are listed below:

Mol	Chain	Res	Type	Atoms	Z	Observed(°)	Ideal(°)
1	AA	765	C	C2-N1-C1'	8.18	127.80	118.80
1	AA	1443	U	C2-N1-C1'	7.01	126.12	117.70
32	A	3169	C	C2-N1-C1'	6.91	126.40	118.80
1	AA	765	C	N1-C2-O2	6.87	123.02	118.90
32	A	3169	C	N1-C2-O2	6.45	122.77	118.90
1	AA	1443	U	N1-C2-O2	6.38	127.27	122.80

Continued on next page...

Continued from previous page...

Mol	Chain	Res	Type	Atoms	Z	Observed(°)	Ideal(°)
42	S	144	LEU	C-N-CA	-6.21	109.27	122.30
1	AA	1234	C	N1-C2-O2	6.15	122.59	118.90
1	AA	1443	U	N3-C2-O2	-6.03	117.98	122.20
1	AA	765	C	N3-C2-O2	-5.81	117.83	121.90
32	A	2069	U	C2-N1-C1'	5.80	124.66	117.70
42	S	145	GLY	N-CA-C	5.68	127.31	113.10
1	AA	1234	C	C2-N1-C1'	5.67	125.03	118.80
1	AA	765	C	C6-N1-C1'	-5.59	114.09	120.80
41	R	136	LYS	C-N-CA	5.55	135.58	121.70
1	AA	765	C	C6-N1-C2	-5.46	118.11	120.30
1	AA	908	C	N1-C2-O2	5.38	122.13	118.90
32	A	3169	C	N3-C2-O2	-5.21	118.25	121.90
32	A	3196	G	P-O3'-C3'	5.02	125.72	119.70
32	A	3124	U	C2-N1-C1'	5.02	123.72	117.70

There are no chirality outliers.

All (6) planarity outliers are listed below:

Mol	Chain	Res	Type	Group
66	P	72	PHE	Peptide
41	R	134	ASP	Peptide
42	S	144	LEU	Peptide
56	g	79	PRO	Peptide
82	s	160	ARG	Peptide
86	v	338	LYS	Peptide

5.2 Too-close contacts [i](#)

Due to software issues we are unable to calculate clashes - this section is therefore empty.

5.3 Torsion angles [i](#)

5.3.1 Protein backbone [i](#)

In the following table, the Percentiles column shows the percent Ramachandran outliers of the chain as a percentile score with respect to all PDB entries followed by that with respect to all EM entries.

The Analysed column shows the number of residues for which the backbone conformation was analysed, and the total number of residues.

Mol	Chain	Analysed	Favoured	Allowed	Outliers	Percentiles	
2	AB	218/296 (74%)	187 (86%)	27 (12%)	4 (2%)	8	35
3	AC	130/167 (78%)	107 (82%)	22 (17%)	1 (1%)	19	55
4	AE	120/125 (96%)	98 (82%)	18 (15%)	4 (3%)	4	19
5	AI	134/194 (69%)	113 (84%)	18 (13%)	3 (2%)	6	29
6	AJ	106/138 (77%)	92 (87%)	12 (11%)	2 (2%)	8	33
7	AK	99/128 (77%)	88 (89%)	8 (8%)	3 (3%)	4	21
8	AM	114/137 (83%)	103 (90%)	10 (9%)	1 (1%)	17	53
9	AN	105/130 (81%)	85 (81%)	18 (17%)	2 (2%)	8	33
10	AO	188/258 (73%)	166 (88%)	18 (10%)	4 (2%)	7	30
11	AP	94/142 (66%)	82 (87%)	10 (11%)	2 (2%)	7	30
12	AQ	84/87 (97%)	71 (84%)	13 (16%)	0	100	100
13	AT	166/173 (96%)	149 (90%)	16 (10%)	1 (1%)	25	61
14	AW	95/187 (51%)	77 (81%)	15 (16%)	3 (3%)	4	20
15	AX	351/398 (88%)	319 (91%)	28 (8%)	4 (1%)	14	47
16	A2	114/118 (97%)	96 (84%)	17 (15%)	1 (1%)	17	53
17	AH	120/201 (60%)	101 (84%)	16 (13%)	3 (2%)	5	26
18	AL	172/257 (67%)	154 (90%)	15 (9%)	3 (2%)	9	36
19	AR	290/360 (81%)	263 (91%)	26 (9%)	1 (0%)	41	74
20	AS	133/190 (70%)	119 (90%)	10 (8%)	4 (3%)	4	21
21	AU	175/205 (85%)	163 (93%)	12 (7%)	0	100	100
22	AV	363/414 (88%)	319 (88%)	36 (10%)	8 (2%)	6	29
23	AY	118/395 (30%)	107 (91%)	10 (8%)	1 (1%)	19	55
24	AZ	97/106 (92%)	82 (84%)	15 (16%)	0	100	100
25	A1	273/323 (84%)	242 (89%)	25 (9%)	6 (2%)	6	29
26	A0	212/218 (97%)	185 (87%)	22 (10%)	5 (2%)	6	27
27	A3	70/199 (35%)	64 (91%)	6 (9%)	0	100	100
28	A4	541/689 (78%)	465 (86%)	66 (12%)	10 (2%)	8	35
29	AD	341/430 (79%)	306 (90%)	31 (9%)	4 (1%)	13	45
30	AF	206/242 (85%)	180 (87%)	23 (11%)	3 (2%)	10	39
31	AG	311/396 (78%)	272 (88%)	37 (12%)	2 (1%)	25	61
34	D	237/305 (78%)	208 (88%)	27 (11%)	2 (1%)	19	55
35	F	248/311 (80%)	217 (88%)	27 (11%)	4 (2%)	9	38

Continued on next page...

Continued from previous page...

Mol	Chain	Analysed	Favoured	Allowed	Outliers	Percentiles	
36	H	96/267 (36%)	84 (88%)	10 (10%)	2 (2%)	7	30
37	K	175/178 (98%)	153 (87%)	16 (9%)	6 (3%)	3	18
38	L	113/145 (78%)	102 (90%)	10 (9%)	1 (1%)	17	53
39	M	285/296 (96%)	252 (88%)	26 (9%)	7 (2%)	5	26
40	O	150/175 (86%)	128 (85%)	19 (13%)	3 (2%)	7	32
41	R	138/149 (93%)	123 (89%)	10 (7%)	5 (4%)	3	17
42	S	154/205 (75%)	135 (88%)	15 (10%)	4 (3%)	5	25
43	T	164/212 (77%)	148 (90%)	13 (8%)	3 (2%)	8	35
44	W	109/148 (74%)	97 (89%)	11 (10%)	1 (1%)	17	53
45	X	241/256 (94%)	212 (88%)	24 (10%)	5 (2%)	7	30
46	Y	174/250 (70%)	161 (92%)	7 (4%)	6 (3%)	3	18
47	Z	118/161 (73%)	106 (90%)	12 (10%)	0	100	100
48	0	106/188 (56%)	93 (88%)	10 (9%)	3 (3%)	5	23
49	1	50/65 (77%)	42 (84%)	7 (14%)	1 (2%)	7	32
50	2	44/92 (48%)	41 (93%)	2 (4%)	1 (2%)	6	28
51	3	93/188 (50%)	84 (90%)	8 (9%)	1 (1%)	14	47
52	4	36/103 (35%)	34 (94%)	2 (6%)	0	100	100
53	8	97/206 (47%)	85 (88%)	12 (12%)	0	100	100
54	b	146/155 (94%)	129 (88%)	14 (10%)	3 (2%)	7	30
55	e	211/279 (76%)	188 (89%)	22 (10%)	1 (0%)	29	66
56	g	130/166 (78%)	109 (84%)	17 (13%)	4 (3%)	4	20
57	i	95/128 (74%)	75 (79%)	20 (21%)	0	100	100
58	j	91/123 (74%)	84 (92%)	6 (7%)	1 (1%)	14	47
59	m	43/128 (34%)	34 (79%)	8 (19%)	1 (2%)	6	28
60	o	92/102 (90%)	79 (86%)	10 (11%)	3 (3%)	4	19
61	q	166/222 (75%)	154 (93%)	10 (6%)	2 (1%)	13	45
62	r	160/196 (82%)	139 (87%)	16 (10%)	5 (3%)	4	20
63	J	173/192 (90%)	152 (88%)	15 (9%)	6 (4%)	3	18
64	I	177/261 (68%)	164 (93%)	12 (7%)	1 (1%)	25	61
65	N	220/251 (88%)	203 (92%)	16 (7%)	1 (0%)	29	66
66	P	141/179 (79%)	123 (87%)	14 (10%)	4 (3%)	5	23

Continued on next page...

Continued from previous page...

Mol	Chain	Analysed	Favoured	Allowed	Outliers	Percentiles	
67	U	150/153 (98%)	122 (81%)	26 (17%)	2 (1%)	12	43
68	V	204/216 (94%)	179 (88%)	25 (12%)	0	100	100
69	E	304/348 (87%)	268 (88%)	32 (10%)	4 (1%)	12	43
70	5	392/423 (93%)	347 (88%)	41 (10%)	4 (1%)	15	50
71	6	352/380 (93%)	302 (86%)	47 (13%)	3 (1%)	17	53
72	7	295/338 (87%)	260 (88%)	28 (10%)	7 (2%)	6	27
73	9	122/137 (89%)	106 (87%)	15 (12%)	1 (1%)	19	55
74	a	106/142 (75%)	95 (90%)	8 (8%)	3 (3%)	5	23
75	c	287/332 (86%)	265 (92%)	18 (6%)	4 (1%)	11	41
76	d	255/306 (83%)	216 (85%)	33 (13%)	6 (2%)	6	27
77	f	144/194 (74%)	121 (84%)	22 (15%)	1 (1%)	22	58
78	h	108/158 (68%)	93 (86%)	13 (12%)	2 (2%)	8	33
79	k	94/112 (84%)	85 (90%)	9 (10%)	0	100	100
80	l	70/138 (51%)	62 (89%)	7 (10%)	1 (1%)	11	41
81	p	148/206 (72%)	130 (88%)	16 (11%)	2 (1%)	11	41
82	s	391/439 (89%)	342 (88%)	41 (10%)	8 (2%)	7	32
83	Q	238/292 (82%)	211 (89%)	20 (8%)	7 (3%)	4	22
84	TA	43/198 (22%)	32 (74%)	11 (26%)	0	100	100
84	TB	25/198 (13%)	24 (96%)	1 (4%)	0	100	100
84	TC	69/198 (35%)	57 (83%)	11 (16%)	1 (1%)	11	41
86	v	710/751 (94%)	566 (80%)	117 (16%)	27 (4%)	3	16
All	All	14720/19244 (76%)	12876 (88%)	1589 (11%)	255 (2%)	13	36

All (255) Ramachandran outliers are listed below:

Mol	Chain	Res	Type
5	AI	68	GLY
22	AV	35	VAL
28	A4	203	PRO
40	O	111	PRO
41	R	137	GLU
42	S	147	PRO
42	S	165	GLU
45	X	18	GLU
48	0	113	CYS

Continued on next page...

Continued from previous page...

Mol	Chain	Res	Type
56	g	78	PRO
63	J	34	PRO
63	J	35	LEU
63	J	157	LYS
63	J	160	SER
66	P	73	PRO
72	7	60	PRO
75	c	251	SER
76	d	67	ILE
82	s	132	GLU
83	Q	226	PRO
84	TC	169	PRO
86	v	208	GLU
86	v	319	ASN
86	v	320	PRO
86	v	336	LYS
86	v	436	ASN
2	AB	185	PRO
4	AE	71	PRO
10	AO	97	ARG
10	AO	98	ASN
10	AO	236	PRO
15	AX	156	PRO
15	AX	371	ALA
17	AH	124	VAL
20	AS	40	PRO
26	A0	214	LYS
28	A4	407	PRO
28	A4	541	PRO
29	AD	291	PHE
30	AF	71	THR
36	H	103	GLU
37	K	101	VAL
39	M	47	ARG
39	M	280	LYS
40	O	14	VAL
41	R	135	GLY
41	R	143	SER
62	r	136	PRO
62	r	167	PRO
66	P	68	TRP
67	U	111	PHE

Continued on next page...

Continued from previous page...

Mol	Chain	Res	Type
69	E	317	PRO
70	5	70	LEU
72	7	230	PHE
72	7	270	PRO
76	d	176	ILE
76	d	236	GLU
78	h	83	PRO
82	s	131	PRO
83	Q	58	PRO
83	Q	60	PRO
86	v	148	VAL
86	v	271	GLU
86	v	272	LYS
86	v	566	LYS
86	v	744	VAL
86	v	745	LYS
2	AB	172	ARG
5	AI	143	GLY
6	AJ	70	PRO
9	AN	11	ARG
19	AR	183	LYS
20	AS	110	GLY
22	AV	121	ALA
22	AV	132	LYS
22	AV	155	GLU
22	AV	156	ASN
25	A1	61	ALA
28	A4	382	PRO
28	A4	470	GLN
29	AD	423	SER
30	AF	80	GLY
30	AF	201	MET
31	AG	391	PHE
35	F	91	PRO
38	L	94	PRO
39	M	242	TYR
45	X	92	ALA
45	X	220	GLU
45	X	221	LYS
46	Y	77	GLU
55	e	265	LYS
56	g	53	PRO

Continued on next page...

Continued from previous page...

Mol	Chain	Res	Type
56	g	55	THR
58	j	40	TYR
60	o	15	ARG
62	r	143	SER
65	N	55	ARG
72	7	167	VAL
72	7	281	SER
74	a	44	ASN
74	a	79	ASP
75	c	183	GLU
77	f	122	GLU
82	s	133	PRO
86	v	77	HIS
86	v	175	LYS
86	v	318	PRO
86	v	334	ASP
86	v	346	SER
86	v	435	ALA
86	v	743	PRO
4	AE	14	GLN
4	AE	54	HIS
6	AJ	49	LEU
7	AK	62	ILE
14	AW	110	ASN
16	A2	101	PRO
18	AL	71	LEU
22	AV	321	GLU
25	A1	73	ALA
25	A1	76	PHE
25	A1	98	ALA
25	A1	131	THR
28	A4	136	HIS
28	A4	385	PRO
29	AD	416	GLY
36	H	61	LYS
37	K	5	SER
37	K	24	LYS
37	K	143	GLU
37	K	151	ILE
37	K	153	LYS
39	M	260	LYS
39	M	266	PHE

Continued on next page...

Continued from previous page...

Mol	Chain	Res	Type
40	O	128	ASN
42	S	196	ASN
43	T	69	ARG
44	W	72	HIS
45	X	176	LEU
46	Y	94	SER
46	Y	162	ARG
46	Y	202	LEU
49	1	60	LYS
50	2	50	GLY
54	b	116	ARG
59	m	70	GLU
61	q	128	MET
61	q	161	GLN
64	I	38	ARG
69	E	82	ASP
70	5	73	PRO
70	5	114	LEU
71	6	289	PRO
72	7	123	CYS
75	c	120	LYS
75	c	186	VAL
78	h	80	SER
80	l	104	PRO
82	s	163	VAL
82	s	272	PRO
82	s	350	ASP
82	s	404	THR
2	AB	103	GLU
4	AE	15	ARG
5	AI	60	PHE
7	AK	82	SER
10	AO	51	TYR
11	AP	57	PRO
14	AW	109	GLU
17	AH	179	GLN
17	AH	184	ILE
18	AL	146	ARG
20	AS	109	LEU
22	AV	135	TYR
25	A1	55	PRO
26	A0	182	GLY

Continued on next page...

Continued from previous page...

Mol	Chain	Res	Type
39	M	267	PHE
39	M	279	ASP
41	R	136	LYS
42	S	138	ALA
43	T	158	TYR
46	Y	204	TYR
48	0	163	GLU
54	b	113	ILE
60	o	52	PRO
66	P	118	SER
66	P	173	ARG
67	U	146	GLY
69	E	125	GLN
69	E	344	SER
71	6	76	GLU
72	7	287	GLN
73	9	27	PRO
74	a	104	GLU
76	d	82	ALA
76	d	289	PRO
76	d	290	GLU
81	p	72	ILE
83	Q	67	ARG
83	Q	229	TRP
86	v	104	SER
86	v	151	VAL
86	v	217	LEU
86	v	262	GLU
86	v	549	TYR
86	v	559	LEU
86	v	567	LEU
7	AK	63	LEU
13	AT	105	ILE
14	AW	144	LEU
15	AX	339	PRO
26	A0	54	ALA
26	A0	181	ASN
28	A4	488	PRO
35	F	128	TRP
35	F	283	LEU
43	T	94	ILE
46	Y	183	GLN

Continued on next page...

Continued from previous page...

Mol	Chain	Res	Type
48	0	116	LEU
51	3	95	THR
54	b	117	LYS
86	v	42	PRO
20	AS	129	GLY
28	A4	365	ILE
31	AG	210	VAL
35	F	124	GLY
60	o	61	GLY
83	Q	228	PRO
11	AP	56	ASN
15	AX	338	ASP
18	AL	114	ILE
22	AV	176	PRO
56	g	36	PRO
70	5	286	PRO
28	A4	606	PRO
29	AD	195	GLY
34	D	98	GLY
34	D	207	ILE
41	R	138	PRO
63	J	36	GLY
83	Q	215	VAL
86	v	46	ILE
2	AB	202	ILE
3	AC	114	GLY
8	AM	62	GLY
23	AY	314	PRO
26	A0	75	GLY
62	r	140	VAL
62	r	156	PRO
71	6	79	GLY
81	p	173	VAL
82	s	130	GLU
9	AN	85	VAL
63	J	32	GLY

5.3.2 Protein sidechains [i](#)

In the following table, the Percentiles column shows the percent sidechain outliers of the chain as a percentile score with respect to all PDB entries followed by that with respect to all EM entries.

The Analysed column shows the number of residues for which the sidechain conformation was analysed, and the total number of residues.

Mol	Chain	Analysed	Rotameric	Outliers	Percentiles	
2	AB	193/249 (78%)	192 (100%)	1 (0%)	88	95
3	AC	115/143 (80%)	115 (100%)	0	100	100
4	AE	104/107 (97%)	103 (99%)	1 (1%)	76	91
5	AI	104/147 (71%)	103 (99%)	1 (1%)	76	91
6	AJ	93/118 (79%)	93 (100%)	0	100	100
7	AK	91/113 (80%)	91 (100%)	0	100	100
8	AM	95/113 (84%)	94 (99%)	1 (1%)	73	90
9	AN	93/115 (81%)	93 (100%)	0	100	100
10	AO	171/230 (74%)	171 (100%)	0	100	100
11	AP	87/123 (71%)	85 (98%)	2 (2%)	50	79
12	AQ	78/79 (99%)	78 (100%)	0	100	100
13	AT	153/157 (98%)	152 (99%)	1 (1%)	84	93
14	AW	84/158 (53%)	84 (100%)	0	100	100
15	AX	312/351 (89%)	311 (100%)	1 (0%)	92	97
16	A2	99/101 (98%)	96 (97%)	3 (3%)	41	73
17	AH	112/180 (62%)	111 (99%)	1 (1%)	78	91
18	AL	157/226 (70%)	155 (99%)	2 (1%)	69	88
19	AR	262/318 (82%)	261 (100%)	1 (0%)	91	97
20	AS	116/164 (71%)	115 (99%)	1 (1%)	78	91
21	AU	153/174 (88%)	153 (100%)	0	100	100
22	AV	328/364 (90%)	323 (98%)	5 (2%)	65	86
23	AY	111/357 (31%)	111 (100%)	0	100	100
24	AZ	89/95 (94%)	89 (100%)	0	100	100
25	A1	253/291 (87%)	253 (100%)	0	100	100
26	A0	186/190 (98%)	184 (99%)	2 (1%)	73	90
27	A3	66/166 (40%)	63 (96%)	3 (4%)	27	62
28	A4	83/609 (14%)	83 (100%)	0	100	100
29	AD	286/357 (80%)	286 (100%)	0	100	100
30	AF	185/209 (88%)	178 (96%)	7 (4%)	33	67
31	AG	273/342 (80%)	272 (100%)	1 (0%)	91	97

Continued on next page...

Continued from previous page...

Mol	Chain	Analysed	Rotameric	Outliers	Percentiles	
34	D	193/245 (79%)	193 (100%)	0	100	100
35	F	217/262 (83%)	216 (100%)	1 (0%)	88	95
36	H	88/228 (39%)	88 (100%)	0	100	100
37	K	155/156 (99%)	155 (100%)	0	100	100
38	L	98/124 (79%)	97 (99%)	1 (1%)	76	91
39	M	245/249 (98%)	242 (99%)	3 (1%)	71	89
40	O	133/150 (89%)	133 (100%)	0	100	100
41	R	118/126 (94%)	117 (99%)	1 (1%)	81	92
42	S	141/180 (78%)	140 (99%)	1 (1%)	84	93
43	T	146/182 (80%)	143 (98%)	3 (2%)	53	80
44	W	91/119 (76%)	91 (100%)	0	100	100
45	X	217/227 (96%)	211 (97%)	6 (3%)	43	75
46	Y	159/223 (71%)	157 (99%)	2 (1%)	69	88
47	Z	111/147 (76%)	111 (100%)	0	100	100
48	0	97/164 (59%)	97 (100%)	0	100	100
49	1	49/60 (82%)	48 (98%)	1 (2%)	55	81
50	2	40/72 (56%)	40 (100%)	0	100	100
51	3	88/166 (53%)	88 (100%)	0	100	100
52	4	37/89 (42%)	37 (100%)	0	100	100
53	8	91/190 (48%)	91 (100%)	0	100	100
54	b	130/135 (96%)	130 (100%)	0	100	100
55	e	188/236 (80%)	186 (99%)	2 (1%)	73	90
56	g	122/148 (82%)	119 (98%)	3 (2%)	47	77
57	i	86/110 (78%)	85 (99%)	1 (1%)	71	89
58	j	74/97 (76%)	74 (100%)	0	100	100
59	m	40/113 (35%)	40 (100%)	0	100	100
60	o	80/87 (92%)	79 (99%)	1 (1%)	69	88
61	q	114/178 (64%)	113 (99%)	1 (1%)	78	91
62	r	147/169 (87%)	145 (99%)	2 (1%)	67	86
63	J	138/150 (92%)	136 (99%)	2 (1%)	67	86
64	I	164/232 (71%)	161 (98%)	3 (2%)	59	83

Continued on next page...

Continued from previous page...

Mol	Chain	Analysed	Rotameric	Outliers	Percentiles	
65	N	189/211 (90%)	189 (100%)	0	100	100
66	P	125/154 (81%)	123 (98%)	2 (2%)	62	85
67	U	126/135 (93%)	126 (100%)	0	100	100
68	V	184/191 (96%)	183 (100%)	1 (0%)	88	95
69	E	260/290 (90%)	259 (100%)	1 (0%)	91	97
70	5	353/368 (96%)	349 (99%)	4 (1%)	73	90
71	6	313/332 (94%)	312 (100%)	1 (0%)	92	97
72	7	272/303 (90%)	272 (100%)	0	100	100
73	9	104/112 (93%)	103 (99%)	1 (1%)	76	91
74	a	101/133 (76%)	101 (100%)	0	100	100
75	c	253/288 (88%)	253 (100%)	0	100	100
76	d	224/274 (82%)	222 (99%)	2 (1%)	78	91
77	f	122/173 (70%)	122 (100%)	0	100	100
78	h	104/148 (70%)	103 (99%)	1 (1%)	76	91
79	k	81/90 (90%)	80 (99%)	1 (1%)	71	89
80	l	67/116 (58%)	66 (98%)	1 (2%)	65	86
81	p	134/181 (74%)	132 (98%)	2 (2%)	65	86
82	s	336/381 (88%)	335 (100%)	1 (0%)	92	97
83	Q	221/256 (86%)	219 (99%)	2 (1%)	78	91
84	TA	39/158 (25%)	39 (100%)	0	100	100
84	TB	26/158 (16%)	26 (100%)	0	100	100
86	v	598/630 (95%)	580 (97%)	18 (3%)	41	73
All	All	12561/16442 (76%)	12455 (99%)	106 (1%)	82	92

All (106) residues with a non-rotameric sidechain are listed below:

Mol	Chain	Res	Type
2	AB	186	THR
4	AE	13	MET
5	AI	81	GLU
8	AM	69	ASN
11	AP	55	GLU
11	AP	123	THR
13	AT	137	ARG

Continued on next page...

Continued from previous page...

Mol	Chain	Res	Type
15	AX	217	GLU
16	A2	71	GLN
16	A2	86	MET
16	A2	104	LEU
17	AH	175	THR
18	AL	72	LEU
18	AL	181	CYS
19	AR	337	GLN
20	AS	120	GLU
22	AV	52	ASP
22	AV	127	TYR
22	AV	135	TYR
22	AV	247	MET
22	AV	338	HIS
26	A0	3	ARG
26	A0	135	MET
27	A3	177	TRP
27	A3	190	GLN
27	A3	191	THR
30	AF	39	PRO
30	AF	40	GLU
30	AF	64	TYR
30	AF	71	THR
30	AF	72	GLN
30	AF	139	ARG
30	AF	177	ARG
31	AG	210	VAL
35	F	58	HIS
38	L	36	THR
39	M	64	ARG
39	M	134	ARG
39	M	266	PHE
41	R	95	VAL
42	S	146	LYS
43	T	82	TYR
43	T	157	ARG
43	T	211	THR
45	X	55	LYS
45	X	124	THR
45	X	126	THR
45	X	157	PHE
45	X	179	GLU

Continued on next page...

Continued from previous page...

Mol	Chain	Res	Type
45	X	243	LEU
46	Y	65	GLU
46	Y	77	GLU
49	1	58	GLU
55	e	260	LEU
55	e	265	LYS
56	g	36	PRO
56	g	66	TYR
56	g	77	ASP
57	i	63	LEU
60	o	93	ASP
61	q	82	LEU
62	r	45	LYS
62	r	146	GLN
63	J	126	GLN
63	J	191	LYS
64	I	34	THR
64	I	104	LEU
64	I	158	GLU
66	P	72	PHE
66	P	146	TYR
68	V	193	THR
69	E	303	LYS
70	5	46	LEU
70	5	69	TRP
70	5	70	LEU
70	5	165	GLN
71	6	288	SER
73	9	31	ARG
76	d	205	GLN
76	d	238	VAL
78	h	73	TYR
79	k	11	ARG
80	l	108	GLU
81	p	95	VAL
81	p	194	HIS
82	s	230	ARG
83	Q	55	GLN
83	Q	273	TYR
86	v	72	ARG
86	v	85	VAL
86	v	102	ILE

Continued on next page...

Continued from previous page...

Mol	Chain	Res	Type
86	v	124	HIS
86	v	129	ILE
86	v	145	LEU
86	v	170	LEU
86	v	200	PHE
86	v	211	PHE
86	v	264	LEU
86	v	271	GLU
86	v	393	VAL
86	v	489	LYS
86	v	491	THR
86	v	492	VAL
86	v	533	VAL
86	v	688	TYR
86	v	704	ARG

Sometimes sidechains can be flipped to improve hydrogen bonding and reduce clashes. All (200) such sidechains are listed below:

Mol	Chain	Res	Type
2	AB	69	HIS
2	AB	126	GLN
3	AC	156	GLN
4	AE	14	GLN
4	AE	41	ASN
4	AE	96	HIS
5	AI	96	GLN
5	AI	104	ASN
7	AK	60	ASN
8	AM	69	ASN
10	AO	65	GLN
10	AO	155	GLN
10	AO	225	GLN
11	AP	115	GLN
12	AQ	53	GLN
12	AQ	85	GLN
13	AT	14	GLN
13	AT	33	ASN
14	AW	91	GLN
14	AW	106	HIS
14	AW	135	GLN
15	AX	59	HIS
15	AX	90	GLN

Continued on next page...

Continued from previous page...

Mol	Chain	Res	Type
15	AX	164	ASN
15	AX	299	ASN
15	AX	387	ASN
16	A2	15	ASN
16	A2	71	GLN
16	A2	90	GLN
16	A2	105	ASN
17	AH	161	GLN
17	AH	179	GLN
19	AR	315	GLN
19	AR	337	GLN
21	AU	159	GLN
21	AU	161	GLN
21	AU	201	GLN
22	AV	134	GLN
22	AV	156	ASN
22	AV	261	GLN
22	AV	381	GLN
22	AV	388	GLN
23	AY	372	HIS
24	AZ	27	ASN
24	AZ	63	GLN
24	AZ	76	GLN
25	A1	64	GLN
25	A1	261	ASN
25	A1	301	ASN
26	A0	111	HIS
27	A3	190	GLN
28	A4	72	GLN
29	AD	227	ASN
29	AD	278	HIS
29	AD	292	HIS
29	AD	360	GLN
30	AF	72	GLN
30	AF	216	GLN
31	AG	87	HIS
31	AG	101	GLN
31	AG	139	GLN
31	AG	265	GLN
31	AG	308	GLN
31	AG	318	HIS
34	D	165	ASN

Continued on next page...

Continued from previous page...

Mol	Chain	Res	Type
34	D	195	ASN
34	D	205	GLN
34	D	235	GLN
35	F	58	HIS
35	F	74	GLN
35	F	103	GLN
35	F	241	ASN
36	H	77	HIS
36	H	148	GLN
37	K	26	GLN
37	K	48	HIS
38	L	72	GLN
38	L	80	GLN
38	L	104	ASN
38	L	142	GLN
39	M	26	ASN
39	M	198	GLN
39	M	276	ASN
40	O	141	HIS
40	O	146	ASN
40	O	150	GLN
40	O	154	GLN
41	R	125	HIS
42	S	140	ASN
43	T	79	GLN
43	T	151	GLN
43	T	201	GLN
43	T	210	HIS
45	X	215	GLN
46	Y	88	GLN
46	Y	117	GLN
46	Y	183	GLN
47	Z	98	GLN
48	0	170	GLN
51	3	154	GLN
51	3	170	ASN
51	3	178	GLN
53	8	144	GLN
54	b	24	GLN
54	b	102	GLN
55	e	54	GLN
55	e	126	GLN

Continued on next page...

Continued from previous page...

Mol	Chain	Res	Type
55	e	179	GLN
55	e	212	HIS
55	e	245	GLN
56	g	73	GLN
57	i	89	GLN
57	i	124	HIS
58	j	30	GLN
58	j	36	ASN
58	j	63	GLN
60	o	85	HIS
60	o	91	GLN
60	o	94	HIS
61	q	81	GLN
61	q	112	GLN
61	q	139	GLN
61	q	142	ASN
61	q	157	GLN
62	r	146	GLN
62	r	184	ASN
63	J	103	GLN
63	J	126	GLN
63	J	133	GLN
64	I	41	HIS
64	I	91	GLN
64	I	115	GLN
64	I	150	HIS
64	I	193	ASN
64	I	204	GLN
65	N	110	ASN
65	N	181	HIS
67	U	74	HIS
69	E	137	ASN
69	E	197	HIS
69	E	227	GLN
69	E	237	HIS
69	E	294	ASN
69	E	313	ASN
70	5	165	GLN
70	5	186	GLN
70	5	191	GLN
70	5	221	GLN
70	5	275	ASN

Continued on next page...

Continued from previous page...

Mol	Chain	Res	Type
70	5	302	HIS
70	5	360	ASN
70	5	385	HIS
71	6	101	GLN
71	6	111	GLN
71	6	320	GLN
71	6	332	HIS
71	6	354	GLN
72	7	45	ASN
72	7	139	ASN
74	a	62	HIS
75	c	48	GLN
75	c	155	ASN
75	c	193	GLN
75	c	204	GLN
75	c	315	ASN
76	d	119	GLN
76	d	161	HIS
76	d	205	GLN
76	d	286	GLN
77	f	136	GLN
79	k	35	GLN
79	k	93	HIS
80	l	82	GLN
80	l	124	GLN
80	l	125	ASN
80	l	129	HIS
81	p	53	GLN
81	p	123	HIS
81	p	194	HIS
82	s	87	GLN
82	s	152	GLN
82	s	238	ASN
82	s	240	GLN
82	s	280	ASN
82	s	300	HIS
82	s	391	ASN
82	s	397	GLN
83	Q	55	GLN
83	Q	158	GLN
83	Q	172	GLN
83	Q	213	GLN

Continued on next page...

Continued from previous page...

Mol	Chain	Res	Type
86	v	43	ASN
86	v	54	HIS
86	v	124	HIS
86	v	188	GLN
86	v	324	GLN
86	v	349	ASN
86	v	548	GLN
86	v	661	GLN
86	v	678	GLN

5.3.3 RNA [i](#)

Mol	Chain	Analysed	Backbone Outliers	Pucker Outliers
1	AA	940/954 (98%)	191 (20%)	7 (0%)
32	A	1523/1559 (97%)	347 (22%)	18 (1%)
33	B	51/73 (69%)	6 (11%)	1 (1%)
All	All	2514/2586 (97%)	544 (21%)	26 (1%)

All (544) RNA backbone outliers are listed below:

Mol	Chain	Res	Type
1	AA	650	U
1	AA	651	A
1	AA	674	U
1	AA	676	G
1	AA	680	U
1	AA	688	A
1	AA	690	U
1	AA	691	A
1	AA	704	U
1	AA	711	U
1	AA	718	A
1	AA	721	U
1	AA	732	A
1	AA	745	A
1	AA	753	A
1	AA	761	A
1	AA	764	A
1	AA	766	G
1	AA	781	A
1	AA	782	A

Continued on next page...

Continued from previous page...

Mol	Chain	Res	Type
1	AA	791	G
1	AA	795	A
1	AA	796	G
1	AA	807	A
1	AA	814	A
1	AA	827	A
1	AA	828	C
1	AA	830	U
1	AA	831	U
1	AA	832	U
1	AA	835	C
1	AA	837	A
1	AA	846	A
1	AA	847	G
1	AA	856	A
1	AA	860	A
1	AA	868	C
1	AA	870	C
1	AA	872	G
1	AA	883	U
1	AA	890	C
1	AA	891	C
1	AA	899	G
1	AA	903	U
1	AA	907	A
1	AA	919	A
1	AA	921	U
1	AA	930	G
1	AA	931	C
1	AA	933	G
1	AA	938	A
1	AA	939	A
1	AA	942	A
1	AA	948	U
1	AA	950	A
1	AA	954	C
1	AA	956	C
1	AA	965	C
1	AA	966	A
1	AA	967	A
1	AA	992	U
1	AA	993	A

Continued on next page...

Continued from previous page...

Mol	Chain	Res	Type
1	AA	1001	C
1	AA	1011	C
1	AA	1014	A
1	AA	1015	A
1	AA	1022	A
1	AA	1042	U
1	AA	1046	A
1	AA	1065	C
1	AA	1069	A
1	AA	1081	U
1	AA	1082	A
1	AA	1105	C
1	AA	1109	A
1	AA	1117	A
1	AA	1118	A
1	AA	1119	U
1	AA	1120	C
1	AA	1121	A
1	AA	1126	A
1	AA	1138	G
1	AA	1143	C
1	AA	1151	C
1	AA	1152	A
1	AA	1154	A
1	AA	1167	A
1	AA	1187	U
1	AA	1188	A
1	AA	1189	U
1	AA	1190	C
1	AA	1193	U
1	AA	1199	G
1	AA	1215	U
1	AA	1220	A
1	AA	1223	C
1	AA	1225	C
1	AA	1234	C
1	AA	1235	U
1	AA	1246	U
1	AA	1247	G
1	AA	1248	C
1	AA	1249	U
1	AA	1250	C

Continued on next page...

Continued from previous page...

Mol	Chain	Res	Type
1	AA	1255	U
1	AA	1259	U
1	AA	1270	U
1	AA	1271	C
1	AA	1272	A
1	AA	1273	G
1	AA	1283	A
1	AA	1284	U
1	AA	1285	G
1	AA	1290	C
1	AA	1292	A
1	AA	1295	A
1	AA	1296	A
1	AA	1300	A
1	AA	1301	G
1	AA	1311	C
1	AA	1312	C
1	AA	1326	A
1	AA	1327	G
1	AA	1328	G
1	AA	1331	A
1	AA	1332	A
1	AA	1333	G
1	AA	1342	C
1	AA	1343	A
1	AA	1353	A
1	AA	1354	A
1	AA	1355	G
1	AA	1356	A
1	AA	1357	A
1	AA	1365	A
1	AA	1367	A
1	AA	1369	U
1	AA	1374	A
1	AA	1376	C
1	AA	1377	C
1	AA	1378	C
1	AA	1379	A
1	AA	1383	A
1	AA	1389	G
1	AA	1392	A
1	AA	1405	C

Continued on next page...

Continued from previous page...

Mol	Chain	Res	Type
1	AA	1406	U
1	AA	1407	U
1	AA	1408	A
1	AA	1418	G
1	AA	1419	G
1	AA	1420	U
1	AA	1421	G
1	AA	1422	G
1	AA	1425	U
1	AA	1430	A
1	AA	1446	A
1	AA	1447	G
1	AA	1449	G
1	AA	1478	A
1	AA	1481	C
1	AA	1482	A
1	AA	1502	A
1	AA	1505	A
1	AA	1512	A
1	AA	1513	A
1	AA	1514	A
1	AA	1518	C
1	AA	1519	A
1	AA	1522	U
1	AA	1523	A
1	AA	1525	C
1	AA	1526	U
1	AA	1527	A
1	AA	1533	C
1	AA	1534	C
1	AA	1535	U
1	AA	1536	A
1	AA	1537	C
1	AA	1539	C
1	AA	1540	A
1	AA	1548	A
1	AA	1558	A
1	AA	1562	G
1	AA	1564	A
1	AA	1568	U
1	AA	1582	G
1	AA	1594	G

Continued on next page...

Continued from previous page...

Mol	Chain	Res	Type
1	AA	1595	G
1	AA	1599	A
1	AA	1600	A
32	A	1678	C
32	A	1679	U
32	A	1680	A
32	A	1681	G
32	A	1689	C
32	A	1690	C
32	A	1700	U
32	A	1702	A
32	A	1704	U
32	A	1708	A
32	A	1709	G
32	A	1711	C
32	A	1713	A
32	A	1714	C
32	A	1715	C
32	A	1716	U
32	A	1717	U
32	A	1724	A
32	A	1727	A
32	A	1728	U
32	A	1734	C
32	A	1735	A
32	A	1736	A
32	A	1748	G
32	A	1750	G
32	A	1751	A
32	A	1762	A
32	A	1763	A
32	A	1766	U
32	A	1767	G
32	A	1770	G
32	A	1777	A
32	A	1781	A
32	A	1782	G
32	A	1794	A
32	A	1800	G
32	A	1806	U
32	A	1807	U
32	A	1808	A

Continued on next page...

Continued from previous page...

Mol	Chain	Res	Type
32	A	1809	U
32	A	1810	A
32	A	1817	C
32	A	1823	A
32	A	1824	U
32	A	1827	C
32	A	1828	A
32	A	1832	A
32	A	1833	C
32	A	1836	A
32	A	1839	C
32	A	1840	C
32	A	1844	A
32	A	1849	C
32	A	1853	A
32	A	1854	U
32	A	1855	A
32	A	1856	A
32	A	1867	A
32	A	1869	A
32	A	1872	U
32	A	1882	A
32	A	1883	G
32	A	1893	A
32	A	1901	C
32	A	1903	C
32	A	1917	A
32	A	1918	G
32	A	1935	A
32	A	1936	A
32	A	1937	A
32	A	1938	A
32	A	1940	A
32	A	1944	C
32	A	1958	G
32	A	1965	A
32	A	1968	G
32	A	1985	G
32	A	1987	G
32	A	1992	C
32	A	1994	A
32	A	1995	A

Continued on next page...

Continued from previous page...

Mol	Chain	Res	Type
32	A	2000	C
32	A	2001	C
32	A	2002	G
32	A	2011	G
32	A	2015	G
32	A	2016	C
32	A	2021	U
32	A	2022	G
32	A	2031	A
32	A	2036	C
32	A	2037	U
32	A	2039	A
32	A	2040	G
32	A	2060	A
32	A	2065	A
32	A	2066	C
32	A	2067	C
32	A	2069	U
32	A	2079	C
32	A	2083	U
32	A	2092	C
32	A	2093	U
32	A	2097	A
32	A	2098	G
32	A	2111	C
32	A	2113	G
32	A	2125	C
32	A	2126	U
32	A	2132	A
32	A	2136	C
32	A	2142	A
32	A	2154	A
32	A	2158	U
32	A	2166	C
32	A	2168	U
32	A	2171	U
32	A	2172	A
32	A	2173	G
32	A	2180	A
32	A	2181	A
32	A	2183	C
32	A	2184	A

Continued on next page...

Continued from previous page...

Mol	Chain	Res	Type
32	A	2187	C
32	A	2190	C
32	A	2193	U
32	A	2194	U
32	A	2198	A
32	A	2199	A
32	A	2201	G
32	A	2203	G
32	A	2205	U
32	A	2210	C
32	A	2215	C
32	A	2217	C
32	A	2218	C
32	A	2219	C
32	A	2220	A
32	A	2222	U
32	A	2224	C
32	A	2228	A
32	A	2229	A
32	A	2230	A
32	A	2235	C
32	A	2237	A
32	A	2241	A
32	A	2245	A
32	A	2246	A
32	A	2250	A
32	A	2252	C
32	A	2256	U
32	A	2262	C
32	A	2263	C
32	A	2264	A
32	A	2283	C
32	A	2284	C
32	A	2297	A
32	A	2300	G
32	A	2315	A
32	A	2322	C
32	A	2331	C
32	A	2332	C
32	A	2343	G
32	A	2345	G
32	A	2350	A

Continued on next page...

Continued from previous page...

Mol	Chain	Res	Type
32	A	2351	U
32	A	2356	A
32	A	2357	C
32	A	2360	U
32	A	2361	G
32	A	2362	A
32	A	2364	C
32	A	2365	U
32	A	2371	U
32	A	2374	A
32	A	2379	C
32	A	2381	A
32	A	2390	A
32	A	2393	C
32	A	2396	C
32	A	2404	U
32	A	2407	U
32	A	2414	C
32	A	2415	C
32	A	2434	A
32	A	2443	C
32	A	2444	A
32	A	2447	A
32	A	2449	G
32	A	2458	A
32	A	2471	G
32	A	2478	G
32	A	2482	A
32	A	2484	C
32	A	2493	C
32	A	2507	A
32	A	2508	C
32	A	2511	C
32	A	2520	C
32	A	2521	A
32	A	2522	U
32	A	2524	A
32	A	2527	A
32	A	2530	A
32	A	2531	U
32	A	2532	U
32	A	2540	C

Continued on next page...

Continued from previous page...

Mol	Chain	Res	Type
32	A	2546	G
32	A	2549	C
32	A	2557	C
32	A	2558	A
32	A	2559	U
32	A	2560	G
32	A	2570	C
32	A	2575	U
32	A	2578	C
32	A	2581	A
32	A	2592	G
32	A	2593	G
32	A	2594	U
32	A	2601	A
32	A	2607	U
32	A	2618	U
32	A	2619	A
32	A	2625	C
32	A	2626	U
32	A	2627	G
32	A	2629	A
32	A	2630	U
32	A	2632	A
32	A	2633	A
32	A	2634	U
32	A	2635	G
32	A	2638	U
32	A	2645	G
32	A	2654	U
32	A	2655	G
32	A	2656	U
32	A	2660	U
32	A	2683	C
32	A	2686	G
32	A	2694	A
32	A	2696	A
32	A	2706	A
32	A	2712	G
32	A	2714	A
32	A	2715	A
32	A	2718	C
32	A	2719	G

Continued on next page...

Continued from previous page...

Mol	Chain	Res	Type
32	A	2723	A
32	A	2724	G
32	A	2725	A
32	A	2732	G
32	A	2739	U
32	A	2740	A
32	A	2749	A
32	A	2750	U
32	A	2755	A
32	A	2756	C
32	A	2757	A
32	A	2758	G
32	A	2760	A
32	A	2803	A
32	A	2804	A
32	A	2805	A
32	A	2810	G
32	A	2814	G
32	A	2831	G
32	A	2832	A
32	A	2833	A
32	A	2843	C
32	A	2844	G
32	A	2847	C
32	A	2849	G
32	A	2854	U
32	A	2864	U
32	A	2865	C
32	A	2879	A
32	A	2881	C
32	A	2893	A
32	A	2906	C
32	A	2910	A
32	A	2912	C
32	A	2913	A
32	A	2917	G
32	A	2918	A
32	A	2926	A
32	A	2928	C
32	A	2935	A
32	A	2946	A
32	A	2963	A

Continued on next page...

Continued from previous page...

Mol	Chain	Res	Type
32	A	2965	A
32	A	2977	G
32	A	2978	U
32	A	2984	A
32	A	2985	C
32	A	2989	G
32	A	2990	A
32	A	2992	G
32	A	2994	U
32	A	3000	A
32	A	3005	A
32	A	3007	C
32	A	3016	G
32	A	3022	G
32	A	3042	U
32	A	3043	C
32	A	3053	A
32	A	3054	G
32	A	3060	C
32	A	3068	G
32	A	3069	A
32	A	3070	G
32	A	3072	U
32	A	3093	C
32	A	3096	U
32	A	3098	U
32	A	3100	U
32	A	3109	U
32	A	3113	A
32	A	3123	G
32	A	3129	A
32	A	3135	A
32	A	3150	U
32	A	3152	C
32	A	3155	C
32	A	3158	A
32	A	3168	C
32	A	3169	C
32	A	3172	C
32	A	3180	A
32	A	3182	A
32	A	3184	C

Continued on next page...

Continued from previous page...

Mol	Chain	Res	Type
32	A	3189	C
32	A	3190	A
32	A	3197	U
32	A	3200	U
32	A	3201	A
32	A	3204	C
32	A	3207	A
32	A	3208	C
32	A	3210	C
32	A	3211	C
32	A	3212	C
32	A	3217	A
32	A	3218	A
32	A	3228	U
33	B	1608	G
33	B	1611	G
33	B	1614	U
33	B	1615	A
33	B	1644	G
33	B	1645	A

All (26) RNA pucker outliers are listed below:

Mol	Chain	Res	Type
1	AA	717	G
1	AA	947	U
1	AA	953	U
1	AA	1021	U
1	AA	1246	U
1	AA	1406	U
1	AA	1429	C
32	A	1703	C
32	A	1805	A
32	A	1806	U
32	A	1807	U
32	A	1823	A
32	A	1871	A
32	A	1994	A
32	A	2165	C
32	A	2182	G
32	A	2245	A
32	A	2457	A

Continued on next page...

Continued from previous page...

Mol	Chain	Res	Type
32	A	2507	A
32	A	2559	U
32	A	2905	A
32	A	2989	G
32	A	3041	U
32	A	3092	U
32	A	3196	G
33	B	1607	U

5.4 Non-standard residues in protein, DNA, RNA chains [i](#)

73 non-standard protein/DNA/RNA residues are modelled in this entry.

In the following table, the Counts columns list the number of bonds (or angles) for which Mogul statistics could be retrieved, the number of bonds (or angles) that are observed in the model and the number of bonds (or angles) that are defined in the Chemical Component Dictionary. The Link column lists molecule types, if any, to which the group is linked. The Z score for a bond length (or angle) is the number of standard deviations the observed value is removed from the expected value. A bond length (or angle) with $|Z| > 2$ is considered an outlier worth inspection. RMSZ is the root-mean-square of all Z scores of the bond lengths (or angles).

Mol	Type	Chain	Res	Link	Bond lengths			Bond angles		
					Counts	RMSZ	# Z > 2	Counts	RMSZ	# Z > 2
88	P5P	A7	1	88	16,20,24	1.44	1 (6%)	14,29,36	2.06	2 (14%)
88	Y5P	A7	50	88	14,19,20	3.46	1 (7%)	18,26,29	0.99	1 (5%)
88	P5P	A7	23	88	16,23,24	1.38	2 (12%)	14,33,36	1.99	2 (14%)
88	Y5P	A7	17	88	14,19,20	3.53	1 (7%)	18,26,29	0.93	1 (5%)
88	Y5P	A7	8	88	14,19,20	3.65	1 (7%)	18,26,29	0.96	2 (11%)
88	P5P	A7	19	88	16,23,24	1.43	2 (12%)	14,33,36	2.19	3 (21%)
88	P5P	A7	4	88	16,23,24	1.36	2 (12%)	14,33,36	2.21	3 (21%)
88	Y5P	A7	37	88	14,19,20	3.44	1 (7%)	18,26,29	0.99	2 (11%)
88	Y5P	A7	69	88	14,19,20	3.50	1 (7%)	18,26,29	1.00	2 (11%)
87	P5P	A5	9	87	16,23,24	1.34	2 (12%)	14,33,36	2.00	2 (14%)
88	P5P	A7	43	88	16,23,24	1.54	3 (18%)	14,33,36	2.43	4 (28%)
88	Y5P	A7	46	88	14,19,20	3.59	1 (7%)	18,26,29	1.08	2 (11%)
88	Y5P	A7	58	88	14,19,20	3.61	1 (7%)	18,26,29	1.05	1 (5%)
87	P5P	A5	5	87	16,23,24	1.38	2 (12%)	14,33,36	2.07	2 (14%)
88	P5P	A7	48	88	16,23,24	1.35	2 (12%)	14,33,36	2.16	2 (14%)
88	Y5P	A7	62	88	14,19,20	3.49	1 (7%)	18,26,29	1.08	1 (5%)

Mol	Type	Chain	Res	Link	Bond lengths			Bond angles		
					Counts	RMSZ	# Z > 2	Counts	RMSZ	# Z > 2
88	P5P	A7	49	88	16,23,24	1.39	2 (12%)	14,33,36	2.13	2 (14%)
88	Y5P	A7	55	88	14,19,20	3.44	1 (7%)	18,26,29	1.10	1 (5%)
88	P5P	A7	40	88	16,23,24	1.36	2 (12%)	14,33,36	2.13	2 (14%)
87	Y5P	A5	7	87	14,19,20	3.57	1 (7%)	18,26,29	1.03	2 (11%)
88	Y5P	A7	3	88	14,19,20	3.58	1 (7%)	18,26,29	1.09	1 (5%)
88	P5P	A7	10	88	16,23,24	1.35	2 (12%)	14,33,36	2.10	2 (14%)
87	Y5P	A5	4	87	14,19,20	3.75	2 (14%)	18,26,29	1.53	3 (16%)
88	P5P	A7	41	88	16,23,24	1.41	2 (12%)	14,33,36	1.94	2 (14%)
88	P5P	A7	16	88	16,23,24	1.54	4 (25%)	14,33,36	2.29	3 (21%)
87	P5P	A5	2	87	16,23,24	1.50	2 (12%)	14,33,36	2.09	2 (14%)
88	Y5P	A7	21	88	14,19,20	3.50	1 (7%)	18,26,29	1.14	1 (5%)
88	Y5P	A7	67	88	14,19,20	3.75	1 (7%)	18,26,29	1.15	1 (5%)
88	P5P	A7	5	88	16,23,24	1.36	1 (6%)	14,33,36	2.14	2 (14%)
88	Y5P	A7	13	88	14,19,20	3.33	1 (7%)	18,26,29	0.85	1 (5%)
88	Y5P	A7	51	88	14,19,20	3.49	1 (7%)	18,26,29	1.04	2 (11%)
88	Y5P	A7	68	88	14,19,20	3.58	1 (7%)	18,26,29	1.30	3 (16%)
88	Y5P	A7	25	88	14,19,20	3.40	1 (7%)	18,26,29	0.96	1 (5%)
88	Y5P	A7	44	88	14,19,20	3.72	1 (7%)	18,26,29	0.94	1 (5%)
88	Y5P	A7	47	88	14,19,20	3.59	1 (7%)	18,26,29	1.12	1 (5%)
87	Y5P	A5	10	87	14,19,20	3.45	1 (7%)	18,26,29	0.99	1 (5%)
88	Y5P	A7	63	88	14,19,20	3.50	1 (7%)	18,26,29	1.08	2 (11%)
88	P5P	A7	2	88	16,23,24	1.54	3 (18%)	14,33,36	2.22	2 (14%)
88	P5P	A7	52	88	16,23,24	1.42	2 (12%)	14,33,36	2.16	3 (21%)
88	P5P	A7	54	88	16,23,24	1.40	2 (12%)	14,33,36	2.05	2 (14%)
88	Y5P	A7	53	88	14,19,20	3.80	1 (7%)	18,26,29	1.18	2 (11%)
88	P5P	A7	26	88	16,23,24	1.38	2 (12%)	14,33,36	2.20	2 (14%)
88	P5P	A7	27	88	16,23,24	1.34	1 (6%)	14,33,36	2.20	2 (14%)
88	P5P	A7	39	88	16,23,24	1.35	2 (12%)	14,33,36	2.21	2 (14%)
88	Y5P	A7	24	88	14,19,20	3.35	1 (7%)	18,26,29	0.95	1 (5%)
88	Y5P	A7	9	88	14,19,20	3.65	1 (7%)	18,26,29	1.47	2 (11%)
88	P5P	A7	42	88	16,23,24	1.32	2 (12%)	14,33,36	2.16	2 (14%)
88	P5P	A7	15	88	16,23,24	1.54	4 (25%)	14,33,36	2.04	2 (14%)
88	Y5P	A7	60	88	14,19,20	3.59	1 (7%)	18,26,29	1.15	1 (5%)
87	P5P	A5	6	87	16,23,24	1.37	2 (12%)	14,33,36	2.17	3 (21%)
88	Y5P	A7	57	88	14,19,20	3.51	1 (7%)	18,26,29	1.02	1 (5%)

Mol	Type	Chain	Res	Link	Bond lengths			Bond angles		
					Counts	RMSZ	# Z > 2	Counts	RMSZ	# Z > 2
88	Y5P	A7	56	88	14,19,20	3.42	1 (7%)	18,26,29	1.08	1 (5%)
88	Y5P	A7	59	88	14,19,20	3.62	1 (7%)	18,26,29	1.02	1 (5%)
87	Y5P	A5	1	87	14,19,20	3.76	2 (14%)	18,26,29	1.55	2 (11%)
88	Y5P	A7	65	88	14,19,20	3.63	1 (7%)	18,26,29	1.04	1 (5%)
88	Y5P	A7	70	88	14,19,20	3.68	1 (7%)	18,26,29	0.93	2 (11%)
88	P5P	A7	6	88	16,23,24	1.34	1 (6%)	14,33,36	2.21	2 (14%)
88	Y5P	A7	61	88	14,19,20	3.44	1 (7%)	18,26,29	1.00	1 (5%)
87	Y5P	A5	3	87	14,19,20	3.47	1 (7%)	18,26,29	1.29	2 (11%)
87	P5P	A5	11	87	16,23,24	1.35	2 (12%)	14,33,36	2.01	2 (14%)
88	Y5P	A7	22	88	14,19,20	3.48	1 (7%)	18,26,29	1.02	1 (5%)
88	P5P	A7	18	88	16,23,24	1.43	3 (18%)	14,33,36	2.17	2 (14%)
88	Y5P	A7	38	88	14,19,20	3.49	1 (7%)	18,26,29	0.97	1 (5%)
87	Y5P	A5	8	87	14,19,20	3.51	1 (7%)	18,26,29	1.01	2 (11%)
88	P5P	A7	11	88	16,23,24	1.36	2 (12%)	14,33,36	2.18	2 (14%)
88	P5P	A7	45	88	16,23,24	1.34	2 (12%)	14,33,36	2.28	2 (14%)
88	P5P	A7	71	88,32	16,23,24	1.32	3 (18%)	14,33,36	1.99	2 (14%)
88	Y5P	A7	66	88	14,19,20	3.70	1 (7%)	18,26,29	1.02	1 (5%)
88	Y5P	A7	12	88	14,19,20	3.31	1 (7%)	18,26,29	1.00	1 (5%)
88	P5P	A7	20	88	16,23,24	1.37	1 (6%)	14,33,36	2.10	2 (14%)
88	P5P	A7	7	88	16,23,24	1.41	2 (12%)	14,33,36	2.23	2 (14%)
88	Y5P	A7	64	88	14,19,20	3.68	1 (7%)	18,26,29	0.95	1 (5%)
88	P5P	A7	14	88	16,23,24	1.41	3 (18%)	14,33,36	1.98	2 (14%)

In the following table, the Chirals column lists the number of chiral outliers, the number of chiral centers analysed, the number of these observed in the model and the number defined in the Chemical Component Dictionary. Similar counts are reported in the Torsion and Rings columns. '-' means no outliers of that kind were identified.

Mol	Type	Chain	Res	Link	Chirals	Torsions	Rings
88	P5P	A7	1	88	-	0/2/22/26	0/3/3/3
88	Y5P	A7	50	88	-	4/7/33/34	0/2/2/2
88	P5P	A7	23	88	-	0/3/25/26	0/3/3/3
88	Y5P	A7	17	88	-	2/7/33/34	0/2/2/2
88	Y5P	A7	8	88	-	1/7/33/34	0/2/2/2
88	P5P	A7	19	88	-	0/3/25/26	0/3/3/3
88	P5P	A7	4	88	-	0/3/25/26	0/3/3/3
88	Y5P	A7	37	88	-	1/7/33/34	0/2/2/2

Continued on next page...

Continued from previous page...

Mol	Type	Chain	Res	Link	Chirals	Torsions	Rings
88	Y5P	A7	69	88	-	1/7/33/34	0/2/2/2
87	P5P	A5	9	87	-	0/3/25/26	0/3/3/3
88	P5P	A7	43	88	-	3/3/25/26	0/3/3/3
88	Y5P	A7	46	88	-	3/7/33/34	0/2/2/2
88	Y5P	A7	58	88	-	3/7/33/34	0/2/2/2
87	P5P	A5	5	87	-	2/3/25/26	0/3/3/3
88	P5P	A7	48	88	-	0/3/25/26	0/3/3/3
88	Y5P	A7	62	88	-	1/7/33/34	0/2/2/2
88	P5P	A7	49	88	-	0/3/25/26	0/3/3/3
88	Y5P	A7	55	88	-	1/7/33/34	0/2/2/2
88	P5P	A7	40	88	-	0/3/25/26	0/3/3/3
87	Y5P	A5	7	87	-	3/7/33/34	0/2/2/2
88	Y5P	A7	3	88	-	1/7/33/34	0/2/2/2
88	P5P	A7	10	88	-	0/3/25/26	0/3/3/3
87	Y5P	A5	4	87	-	7/7/33/34	0/2/2/2
88	P5P	A7	41	88	-	0/3/25/26	0/3/3/3
88	P5P	A7	16	88	-	2/3/25/26	0/3/3/3
87	P5P	A5	2	87	-	2/3/25/26	0/3/3/3
88	Y5P	A7	21	88	-	3/7/33/34	0/2/2/2
88	Y5P	A7	67	88	-	1/7/33/34	0/2/2/2
88	P5P	A7	5	88	-	2/3/25/26	0/3/3/3
88	Y5P	A7	13	88	-	1/7/33/34	0/2/2/2
88	Y5P	A7	51	88	-	2/7/33/34	0/2/2/2
88	Y5P	A7	68	88	-	1/7/33/34	0/2/2/2
88	Y5P	A7	25	88	-	1/7/33/34	0/2/2/2
88	Y5P	A7	44	88	-	3/7/33/34	0/2/2/2
88	Y5P	A7	47	88	-	1/7/33/34	0/2/2/2
87	Y5P	A5	10	87	-	1/7/33/34	0/2/2/2
88	Y5P	A7	63	88	-	1/7/33/34	0/2/2/2
88	P5P	A7	2	88	-	0/3/25/26	0/3/3/3
88	P5P	A7	52	88	-	3/3/25/26	0/3/3/3
88	P5P	A7	54	88	-	1/3/25/26	0/3/3/3
88	Y5P	A7	53	88	-	3/7/33/34	0/2/2/2
88	P5P	A7	26	88	-	0/3/25/26	0/3/3/3
88	P5P	A7	27	88	-	0/3/25/26	0/3/3/3
88	P5P	A7	39	88	-	0/3/25/26	0/3/3/3
88	Y5P	A7	24	88	-	1/7/33/34	0/2/2/2
88	Y5P	A7	9	88	-	3/7/33/34	0/2/2/2
88	P5P	A7	42	88	-	0/3/25/26	0/3/3/3

Continued on next page...

Continued from previous page...

Mol	Type	Chain	Res	Link	Chirals	Torsions	Rings
88	P5P	A7	15	88	-	0/3/25/26	0/3/3/3
88	Y5P	A7	60	88	-	1/7/33/34	0/2/2/2
87	P5P	A5	6	87	-	0/3/25/26	0/3/3/3
88	Y5P	A7	57	88	-	1/7/33/34	0/2/2/2
88	Y5P	A7	56	88	-	3/7/33/34	0/2/2/2
88	Y5P	A7	59	88	-	1/7/33/34	0/2/2/2
87	Y5P	A5	1	87	-	7/7/33/34	0/2/2/2
88	Y5P	A7	65	88	-	2/7/33/34	0/2/2/2
88	Y5P	A7	70	88	-	3/7/33/34	0/2/2/2
88	P5P	A7	6	88	-	3/3/25/26	0/3/3/3
88	Y5P	A7	61	88	-	1/7/33/34	0/2/2/2
87	Y5P	A5	3	87	-	4/7/33/34	0/2/2/2
87	P5P	A5	11	87	-	0/3/25/26	0/3/3/3
88	Y5P	A7	22	88	-	3/7/33/34	0/2/2/2
88	P5P	A7	18	88	-	1/3/25/26	0/3/3/3
88	Y5P	A7	38	88	-	2/7/33/34	0/2/2/2
87	Y5P	A5	8	87	-	3/7/33/34	0/2/2/2
88	P5P	A7	11	88	-	0/3/25/26	0/3/3/3
88	P5P	A7	45	88	-	2/3/25/26	0/3/3/3
88	P5P	A7	71	88,32	-	1/3/25/26	0/3/3/3
88	Y5P	A7	66	88	-	1/7/33/34	0/2/2/2
88	Y5P	A7	12	88	-	3/7/33/34	0/2/2/2
88	P5P	A7	20	88	-	0/3/25/26	0/3/3/3
88	P5P	A7	7	88	-	3/3/25/26	0/3/3/3
88	Y5P	A7	64	88	-	2/7/33/34	0/2/2/2
88	P5P	A7	14	88	-	2/3/25/26	0/3/3/3

All (112) bond length outliers are listed below:

Mol	Chain	Res	Type	Atoms	Z	Observed(Å)	Ideal(Å)
88	A7	53	Y5P	C4-N3	-13.91	1.33	1.46
88	A7	67	Y5P	C4-N3	-13.84	1.33	1.46
88	A7	44	Y5P	C4-N3	-13.71	1.33	1.46
87	A5	1	Y5P	C4-N3	-13.62	1.33	1.46
88	A7	66	Y5P	C4-N3	-13.62	1.33	1.46
88	A7	70	Y5P	C4-N3	-13.62	1.33	1.46
87	A5	4	Y5P	C4-N3	-13.60	1.33	1.46
88	A7	64	Y5P	C4-N3	-13.46	1.34	1.46
88	A7	8	Y5P	C4-N3	-13.32	1.34	1.46

Continued on next page...

Continued from previous page...

Mol	Chain	Res	Type	Atoms	Z	Observed(Å)	Ideal(Å)
88	A7	9	Y5P	C4-N3	-13.26	1.34	1.46
88	A7	65	Y5P	C4-N3	-13.25	1.34	1.46
88	A7	59	Y5P	C4-N3	-13.22	1.34	1.46
88	A7	60	Y5P	C4-N3	-13.22	1.34	1.46
88	A7	58	Y5P	C4-N3	-13.20	1.34	1.46
88	A7	47	Y5P	C4-N3	-13.18	1.34	1.46
88	A7	3	Y5P	C4-N3	-13.17	1.34	1.46
88	A7	68	Y5P	C4-N3	-13.16	1.34	1.46
88	A7	46	Y5P	C4-N3	-13.13	1.34	1.46
87	A5	7	Y5P	C4-N3	-13.04	1.34	1.46
88	A7	17	Y5P	C4-N3	-12.94	1.34	1.46
88	A7	51	Y5P	C4-N3	-12.87	1.34	1.46
88	A7	57	Y5P	C4-N3	-12.85	1.34	1.46
88	A7	62	Y5P	C4-N3	-12.83	1.34	1.46
88	A7	38	Y5P	C4-N3	-12.78	1.34	1.46
88	A7	21	Y5P	C4-N3	-12.78	1.34	1.46
87	A5	8	Y5P	C4-N3	-12.77	1.34	1.46
88	A7	63	Y5P	C4-N3	-12.77	1.34	1.46
88	A7	69	Y5P	C4-N3	-12.76	1.34	1.46
88	A7	50	Y5P	C4-N3	-12.72	1.34	1.46
88	A7	22	Y5P	C4-N3	-12.68	1.34	1.46
87	A5	10	Y5P	C4-N3	-12.63	1.34	1.46
88	A7	37	Y5P	C4-N3	-12.63	1.34	1.46
87	A5	3	Y5P	C4-N3	-12.59	1.34	1.46
88	A7	55	Y5P	C4-N3	-12.57	1.34	1.46
88	A7	61	Y5P	C4-N3	-12.52	1.34	1.46
88	A7	56	Y5P	C4-N3	-12.46	1.34	1.46
88	A7	25	Y5P	C4-N3	-12.45	1.34	1.46
88	A7	24	Y5P	C4-N3	-12.32	1.35	1.46
88	A7	13	Y5P	C4-N3	-12.20	1.35	1.46
88	A7	12	Y5P	C4-N3	-11.99	1.35	1.46
88	A7	1	P5P	C6-N1	4.35	1.40	1.32
88	A7	2	P5P	C6-N1	4.32	1.40	1.32
88	A7	54	P5P	C6-N1	4.32	1.40	1.32
88	A7	15	P5P	C6-N1	4.25	1.39	1.32
88	A7	52	P5P	C6-N1	4.23	1.39	1.32
88	A7	39	P5P	C6-N1	4.21	1.39	1.32
88	A7	18	P5P	C6-N1	4.19	1.39	1.32
88	A7	43	P5P	C6-N1	4.17	1.39	1.32
88	A7	48	P5P	C6-N1	4.15	1.39	1.32
88	A7	26	P5P	C6-N1	4.12	1.39	1.32
88	A7	4	P5P	C6-N1	4.12	1.39	1.32

Continued on next page...

Continued from previous page...

Mol	Chain	Res	Type	Atoms	Z	Observed(Å)	Ideal(Å)
87	A5	11	P5P	C6-N1	4.12	1.39	1.32
88	A7	23	P5P	C6-N1	4.12	1.39	1.32
88	A7	19	P5P	C6-N1	4.11	1.39	1.32
87	A5	6	P5P	C6-N1	4.11	1.39	1.32
87	A5	2	P5P	C6-N1	4.09	1.39	1.32
88	A7	49	P5P	C6-N1	4.08	1.39	1.32
88	A7	6	P5P	C6-N1	4.06	1.39	1.32
88	A7	41	P5P	C6-N1	4.04	1.39	1.32
88	A7	71	P5P	C6-N1	4.04	1.39	1.32
88	A7	7	P5P	C6-N1	4.02	1.39	1.32
87	A5	9	P5P	C6-N1	4.01	1.39	1.32
87	A5	5	P5P	C6-N1	4.00	1.39	1.32
88	A7	16	P5P	C6-N1	3.99	1.39	1.32
88	A7	14	P5P	C6-N1	3.94	1.39	1.32
88	A7	10	P5P	C6-N1	3.91	1.39	1.32
88	A7	11	P5P	C6-N1	3.90	1.39	1.32
88	A7	27	P5P	C6-N1	3.88	1.39	1.32
88	A7	40	P5P	C6-N1	3.88	1.39	1.32
88	A7	5	P5P	C6-N1	3.86	1.39	1.32
88	A7	45	P5P	C6-N1	3.79	1.39	1.32
88	A7	42	P5P	C6-N1	3.78	1.39	1.32
88	A7	20	P5P	C6-N1	3.76	1.39	1.32
88	A7	16	P5P	C8-N7	-2.44	1.30	1.34
88	A7	16	P5P	C2'-C1'	-2.41	1.50	1.53
88	A7	15	P5P	C2'-C1'	-2.38	1.50	1.53
88	A7	15	P5P	C2-N1	2.27	1.38	1.33
88	A7	54	P5P	C2-N1	2.25	1.38	1.33
88	A7	2	P5P	C2-N1	2.24	1.38	1.33
88	A7	18	P5P	C2-N1	2.24	1.38	1.33
88	A7	2	P5P	C8-N7	-2.22	1.30	1.34
87	A5	9	P5P	C2-N1	2.22	1.37	1.33
88	A7	14	P5P	C2-N1	2.21	1.37	1.33
88	A7	14	P5P	C8-N7	-2.21	1.30	1.34
87	A5	5	P5P	C2-N1	2.21	1.37	1.33
88	A7	52	P5P	C2-N1	2.20	1.37	1.33
87	A5	6	P5P	C2-N1	2.20	1.37	1.33
87	A5	1	Y5P	C2-N1	2.19	1.41	1.36
88	A7	43	P5P	C2-N1	2.19	1.37	1.33
87	A5	11	P5P	C2-N1	2.18	1.37	1.33
87	A5	4	Y5P	C2-N1	2.17	1.41	1.36
87	A5	2	P5P	C2-N1	2.17	1.37	1.33
88	A7	41	P5P	C2-N1	2.16	1.37	1.33

Continued on next page...

Continued from previous page...

Mol	Chain	Res	Type	Atoms	Z	Observed(Å)	Ideal(Å)
88	A7	19	P5P	C2-N1	2.15	1.37	1.33
88	A7	15	P5P	C8-N7	-2.14	1.30	1.34
88	A7	7	P5P	C2'-C1'	-2.14	1.50	1.53
88	A7	48	P5P	C2-N1	2.13	1.37	1.33
88	A7	71	P5P	C8-N7	-2.12	1.30	1.34
88	A7	43	P5P	C2'-C1'	-2.10	1.50	1.53
88	A7	71	P5P	C2-N1	2.09	1.37	1.33
88	A7	45	P5P	C2-N1	2.09	1.37	1.33
88	A7	26	P5P	C2-N1	2.08	1.37	1.33
88	A7	42	P5P	C2-N1	2.08	1.37	1.33
88	A7	16	P5P	C2-N1	2.08	1.37	1.33
88	A7	23	P5P	C2-N1	2.07	1.37	1.33
88	A7	39	P5P	C2-N1	2.04	1.37	1.33
88	A7	10	P5P	C2-N1	2.04	1.37	1.33
88	A7	49	P5P	C2-N1	2.04	1.37	1.33
88	A7	40	P5P	C2-N1	2.03	1.37	1.33
88	A7	18	P5P	C8-N7	-2.03	1.31	1.34
88	A7	11	P5P	C2-N1	2.01	1.37	1.33
88	A7	4	P5P	C2-N1	2.01	1.37	1.33

All (130) bond angle outliers are listed below:

Mol	Chain	Res	Type	Atoms	Z	Observed(°)	Ideal(°)
88	A7	45	P5P	C6-N1-C2	7.22	126.18	115.84
88	A7	27	P5P	C6-N1-C2	7.10	126.02	115.84
88	A7	2	P5P	C6-N1-C2	7.06	125.95	115.84
88	A7	11	P5P	C6-N1-C2	7.04	125.93	115.84
88	A7	7	P5P	C6-N1-C2	6.99	125.85	115.84
88	A7	26	P5P	C6-N1-C2	6.99	125.85	115.84
88	A7	4	P5P	C6-N1-C2	6.98	125.84	115.84
88	A7	39	P5P	C6-N1-C2	6.97	125.82	115.84
88	A7	19	P5P	C6-N1-C2	6.92	125.75	115.84
88	A7	40	P5P	C6-N1-C2	6.89	125.70	115.84
88	A7	5	P5P	C6-N1-C2	6.88	125.69	115.84
88	A7	18	P5P	C6-N1-C2	6.87	125.68	115.84
88	A7	49	P5P	C6-N1-C2	6.87	125.68	115.84
88	A7	6	P5P	C6-N1-C2	6.85	125.65	115.84
88	A7	1	P5P	C6-N1-C2	6.78	125.55	115.84
88	A7	48	P5P	C6-N1-C2	6.73	125.49	115.84
88	A7	20	P5P	C6-N1-C2	6.73	125.48	115.84
88	A7	10	P5P	C6-N1-C2	6.73	125.48	115.84
88	A7	42	P5P	C6-N1-C2	6.71	125.45	115.84

Continued on next page...

Continued from previous page...

Mol	Chain	Res	Type	Atoms	Z	Observed(°)	Ideal(°)
88	A7	16	P5P	C6-N1-C2	6.66	125.38	115.84
87	A5	5	P5P	C6-N1-C2	6.65	125.37	115.84
87	A5	11	P5P	C6-N1-C2	6.64	125.35	115.84
87	A5	6	P5P	C6-N1-C2	6.61	125.31	115.84
87	A5	9	P5P	C6-N1-C2	6.61	125.31	115.84
88	A7	43	P5P	C6-N1-C2	6.60	125.30	115.84
88	A7	14	P5P	C6-N1-C2	6.56	125.24	115.84
87	A5	2	P5P	C6-N1-C2	6.49	125.14	115.84
88	A7	71	P5P	C6-N1-C2	6.49	125.14	115.84
88	A7	23	P5P	C6-N1-C2	6.48	125.13	115.84
88	A7	15	P5P	C6-N1-C2	6.48	125.13	115.84
88	A7	52	P5P	C6-N1-C2	6.40	125.02	115.84
88	A7	41	P5P	C6-N1-C2	6.39	124.99	115.84
88	A7	54	P5P	C6-N1-C2	6.39	124.99	115.84
88	A7	9	Y5P	C1'-N1-C6	-4.66	110.78	120.83
87	A5	1	Y5P	C1'-N1-C6	-4.47	111.20	120.83
87	A5	4	Y5P	C1'-N1-C6	-4.29	111.58	120.83
88	A7	52	P5P	N1-C2-N3	-3.83	122.75	127.65
88	A7	2	P5P	N1-C2-N3	-3.82	122.76	127.65
88	A7	43	P5P	N1-C2-N3	-3.75	122.85	127.65
88	A7	18	P5P	N1-C2-N3	-3.73	122.88	127.65
88	A7	6	P5P	N1-C2-N3	-3.72	122.89	127.65
88	A7	26	P5P	N1-C2-N3	-3.68	122.94	127.65
88	A7	7	P5P	N1-C2-N3	-3.66	122.97	127.65
88	A7	27	P5P	N1-C2-N3	-3.63	123.01	127.65
88	A7	39	P5P	N1-C2-N3	-3.62	123.01	127.65
88	A7	49	P5P	N1-C2-N3	-3.62	123.02	127.65
88	A7	5	P5P	N1-C2-N3	-3.60	123.05	127.65
88	A7	45	P5P	N1-C2-N3	-3.56	123.09	127.65
88	A7	20	P5P	N1-C2-N3	-3.55	123.10	127.65
88	A7	10	P5P	N1-C2-N3	-3.54	123.13	127.65
88	A7	16	P5P	C1'-N9-C4	3.51	132.81	126.64
88	A7	11	P5P	N1-C2-N3	-3.49	123.19	127.65
88	A7	40	P5P	N1-C2-N3	-3.46	123.22	127.65
88	A7	48	P5P	N1-C2-N3	-3.39	123.32	127.65
88	A7	19	P5P	N1-C2-N3	-3.37	123.34	127.65
87	A5	2	P5P	N1-C2-N3	-3.34	123.37	127.65
88	A7	1	P5P	N1-C2-N3	-3.30	123.43	127.65
88	A7	23	P5P	N1-C2-N3	-3.26	123.47	127.65
88	A7	4	P5P	N1-C2-N3	-3.23	123.51	127.65
87	A5	6	P5P	N1-C2-N3	-3.23	123.52	127.65
88	A7	15	P5P	N1-C2-N3	-3.19	123.57	127.65

Continued on next page...

Continued from previous page...

Mol	Chain	Res	Type	Atoms	Z	Observed(°)	Ideal(°)
88	A7	16	P5P	N1-C2-N3	-3.18	123.58	127.65
88	A7	54	P5P	N1-C2-N3	-3.17	123.60	127.65
87	A5	11	P5P	N1-C2-N3	-3.15	123.62	127.65
87	A5	9	P5P	N1-C2-N3	-3.15	123.62	127.65
87	A5	5	P5P	N1-C2-N3	-3.08	123.71	127.65
88	A7	42	P5P	N1-C2-N3	-3.05	123.75	127.65
88	A7	60	Y5P	O4'-C1'-N1	2.97	113.85	108.06
88	A7	47	Y5P	O4'-C1'-N1	2.94	113.80	108.06
88	A7	59	Y5P	O4'-C1'-N1	2.93	113.78	108.06
88	A7	41	P5P	N1-C2-N3	-2.92	123.91	127.65
88	A7	55	Y5P	O4'-C1'-N1	2.89	113.70	108.06
88	A7	66	Y5P	O4'-C1'-N1	2.88	113.69	108.06
88	A7	14	P5P	N1-C2-N3	-2.82	124.05	127.65
88	A7	53	Y5P	C1'-N1-C6	-2.81	114.77	120.83
88	A7	71	P5P	N1-C2-N3	-2.80	124.07	127.65
88	A7	68	Y5P	C1'-N1-C6	-2.80	114.80	120.83
87	A5	3	Y5P	O4'-C1'-N1	2.78	113.49	108.06
88	A7	3	Y5P	O4'-C1'-N1	2.75	113.43	108.06
88	A7	56	Y5P	O4'-C1'-N1	2.74	113.42	108.06
88	A7	57	Y5P	O4'-C1'-N1	2.74	113.41	108.06
88	A7	8	Y5P	O4'-C1'-N1	2.69	113.31	108.06
88	A7	62	Y5P	O4'-C1'-N1	2.65	113.24	108.06
88	A7	61	Y5P	O4'-C1'-N1	2.64	113.21	108.06
88	A7	65	Y5P	O4'-C1'-N1	2.62	113.18	108.06
88	A7	12	Y5P	O4'-C1'-N1	2.61	113.16	108.06
88	A7	24	Y5P	O4'-C1'-N1	2.60	113.14	108.06
88	A7	67	Y5P	O4'-C1'-N1	2.60	113.13	108.06
87	A5	6	P5P	O3'-C3'-C2'	2.59	120.20	111.82
88	A7	63	Y5P	O4'-C1'-N1	2.59	113.12	108.06
88	A7	4	P5P	C1'-N9-C4	-2.55	122.16	126.64
88	A7	37	Y5P	O4'-C1'-N1	2.54	113.02	108.06
88	A7	43	P5P	O4'-C1'-C2'	-2.54	103.22	106.93
88	A7	21	Y5P	O4'-C1'-N1	2.53	113.00	108.06
88	A7	25	Y5P	O4'-C1'-N1	2.51	112.97	108.06
88	A7	46	Y5P	O4'-C1'-N1	2.50	112.94	108.06
88	A7	43	P5P	O5'-C5'-C4'	2.49	117.47	108.99
87	A5	10	Y5P	O4'-C1'-N1	2.49	112.92	108.06
88	A7	38	Y5P	O4'-C1'-N1	2.35	112.66	108.06
88	A7	58	Y5P	O4'-C1'-N1	2.35	112.65	108.06
88	A7	69	Y5P	O4'-C1'-N1	2.35	112.65	108.06
88	A7	22	Y5P	O4'-C1'-N1	2.33	112.61	108.06
88	A7	51	Y5P	O4'-C1'-N1	2.29	112.53	108.06

Continued on next page...

Continued from previous page...

Mol	Chain	Res	Type	Atoms	Z	Observed(°)	Ideal(°)
88	A7	70	Y5P	N1-C2-N3	-2.27	118.67	125.33
88	A7	9	Y5P	N1-C2-N3	-2.27	118.68	125.33
88	A7	51	Y5P	N1-C2-N3	-2.25	118.72	125.33
88	A7	13	Y5P	O4'-C1'-N1	2.22	112.40	108.06
87	A5	4	Y5P	N1-C2-N3	-2.21	118.84	125.33
88	A7	68	Y5P	O4'-C1'-N1	2.21	112.38	108.06
87	A5	1	Y5P	N1-C2-N3	-2.21	118.85	125.33
87	A5	4	Y5P	O5'-C5'-C4'	2.20	116.48	108.99
88	A7	64	Y5P	O4'-C1'-N1	2.20	112.35	108.06
87	A5	7	Y5P	O4'-C1'-N1	2.16	112.27	108.06
88	A7	53	Y5P	N1-C2-N3	-2.15	119.02	125.33
87	A5	3	Y5P	N1-C2-N3	-2.15	119.02	125.33
87	A5	8	Y5P	O4'-C1'-N1	2.12	112.20	108.06
88	A7	68	Y5P	N1-C2-N3	-2.10	119.18	125.33
88	A7	50	Y5P	N1-C2-N3	-2.09	119.19	125.33
87	A5	7	Y5P	N1-C2-N3	-2.09	119.20	125.33
88	A7	70	Y5P	C4-C5-C6	-2.09	116.86	122.78
88	A7	44	Y5P	N1-C2-N3	-2.08	119.22	125.33
88	A7	19	P5P	C1'-N9-C4	-2.06	123.01	126.64
88	A7	46	Y5P	N1-C2-N3	-2.05	119.33	125.33
88	A7	8	Y5P	N1-C2-N3	-2.04	119.34	125.33
87	A5	8	Y5P	N1-C2-N3	-2.04	119.34	125.33
88	A7	69	Y5P	N1-C2-N3	-2.03	119.37	125.33
88	A7	52	P5P	O5'-C5'-C4'	2.02	115.88	108.99
88	A7	63	Y5P	N1-C2-N3	-2.02	119.39	125.33
88	A7	17	Y5P	N1-C2-N3	-2.02	119.41	125.33
88	A7	37	Y5P	N1-C2-N3	-2.01	119.45	125.33

There are no chirality outliers.

All (114) torsion outliers are listed below:

Mol	Chain	Res	Type	Atoms
87	A5	1	Y5P	O4'-C4'-C5'-O5'
87	A5	1	Y5P	C3'-C4'-C5'-O5'
87	A5	2	P5P	O4'-C4'-C5'-O5'
87	A5	4	Y5P	O4'-C4'-C5'-O5'
87	A5	4	Y5P	C3'-C4'-C5'-O5'
87	A5	5	P5P	C3'-C4'-C5'-O5'
87	A5	5	P5P	O4'-C4'-C5'-O5'
87	A5	7	Y5P	O4'-C4'-C5'-O5'
87	A5	7	Y5P	C3'-C4'-C5'-O5'
87	A5	7	Y5P	O4'-C1'-N1-C2

Continued on next page...

Continued from previous page...

Mol	Chain	Res	Type	Atoms
87	A5	8	Y5P	O4'-C4'-C5'-O5'
87	A5	8	Y5P	C3'-C4'-C5'-O5'
87	A5	8	Y5P	O4'-C1'-N1-C2
88	A7	3	Y5P	O4'-C1'-N1-C2
88	A7	6	P5P	C3'-C4'-C5'-O5'
88	A7	9	Y5P	C2'-C1'-N1-C2
88	A7	14	P5P	C3'-C4'-C5'-O5'
88	A7	14	P5P	O4'-C4'-C5'-O5'
88	A7	21	Y5P	O4'-C4'-C5'-O5'
88	A7	21	Y5P	C3'-C4'-C5'-O5'
88	A7	22	Y5P	O4'-C4'-C5'-O5'
88	A7	22	Y5P	C3'-C4'-C5'-O5'
88	A7	24	Y5P	O4'-C1'-N1-C2
88	A7	25	Y5P	O4'-C1'-N1-C2
88	A7	37	Y5P	O4'-C1'-N1-C2
88	A7	43	P5P	C3'-C4'-C5'-O5'
88	A7	43	P5P	O4'-C4'-C5'-O5'
88	A7	43	P5P	C4'-C5'-O5'-P
88	A7	45	P5P	C3'-C4'-C5'-O5'
88	A7	46	Y5P	O4'-C4'-C5'-O5'
88	A7	46	Y5P	C3'-C4'-C5'-O5'
88	A7	46	Y5P	O4'-C1'-N1-C2
88	A7	51	Y5P	O4'-C1'-N1-C2
88	A7	52	P5P	C3'-C4'-C5'-O5'
88	A7	52	P5P	O4'-C4'-C5'-O5'
88	A7	57	Y5P	O4'-C1'-N1-C2
88	A7	61	Y5P	O4'-C1'-N1-C2
88	A7	62	Y5P	O4'-C1'-N1-C2
88	A7	63	Y5P	O4'-C1'-N1-C2
88	A7	71	P5P	C4'-C5'-O5'-P
87	A5	10	Y5P	O4'-C1'-N1-C2
88	A7	8	Y5P	O4'-C1'-N1-C2
88	A7	12	Y5P	O4'-C1'-N1-C2
88	A7	13	Y5P	O4'-C1'-N1-C2
88	A7	21	Y5P	O4'-C1'-N1-C2
88	A7	22	Y5P	O4'-C1'-N1-C2
88	A7	38	Y5P	O4'-C1'-N1-C2
88	A7	47	Y5P	O4'-C1'-N1-C2
88	A7	50	Y5P	O4'-C1'-N1-C2
88	A7	55	Y5P	O4'-C1'-N1-C2
88	A7	56	Y5P	O4'-C1'-N1-C2
88	A7	58	Y5P	O4'-C1'-N1-C2

Continued on next page...

Continued from previous page...

Mol	Chain	Res	Type	Atoms
88	A7	59	Y5P	O4'-C1'-N1-C2
88	A7	60	Y5P	O4'-C1'-N1-C2
88	A7	64	Y5P	O4'-C1'-N1-C2
88	A7	65	Y5P	O4'-C1'-N1-C2
88	A7	66	Y5P	O4'-C1'-N1-C2
88	A7	69	Y5P	O4'-C1'-N1-C2
87	A5	2	P5P	C3'-C4'-C5'-O5'
87	A5	3	Y5P	O4'-C4'-C5'-O5'
88	A7	16	P5P	C3'-C4'-C5'-O5'
88	A7	58	Y5P	C3'-C4'-C5'-O5'
88	A7	9	Y5P	C2'-C1'-N1-C6
87	A5	3	Y5P	C3'-C4'-C5'-O5'
88	A7	45	P5P	O4'-C4'-C5'-O5'
88	A7	58	Y5P	O4'-C4'-C5'-O5'
87	A5	1	Y5P	C2'-C1'-N1-C6
87	A5	4	Y5P	C2'-C1'-N1-C6
88	A7	67	Y5P	O4'-C1'-N1-C2
88	A7	70	Y5P	O4'-C1'-N1-C2
87	A5	1	Y5P	C4'-C5'-O5'-P
87	A5	4	Y5P	C4'-C5'-O5'-P
88	A7	50	Y5P	C4'-C5'-O5'-P
88	A7	6	P5P	O4'-C4'-C5'-O5'
88	A7	7	P5P	O4'-C4'-C5'-O5'
88	A7	16	P5P	O4'-C4'-C5'-O5'
88	A7	70	Y5P	O4'-C4'-C5'-O5'
88	A7	12	Y5P	C3'-C4'-C5'-O5'
88	A7	50	Y5P	C3'-C4'-C5'-O5'
88	A7	18	P5P	C4'-C5'-O5'-P
87	A5	1	Y5P	O4'-C1'-N1-C2
88	A7	70	Y5P	C3'-C4'-C5'-O5'
87	A5	1	Y5P	C2'-C1'-N1-C2
87	A5	4	Y5P	O4'-C1'-N1-C2
88	A7	6	P5P	C4'-C5'-O5'-P
88	A7	17	Y5P	C4'-C5'-O5'-P
88	A7	7	P5P	C3'-C4'-C5'-O5'
88	A7	53	Y5P	O4'-C1'-N1-C6
88	A7	54	P5P	C4'-C5'-O5'-P
88	A7	56	Y5P	C4'-C5'-O5'-P
88	A7	5	P5P	C3'-C4'-C5'-O5'
88	A7	56	Y5P	O4'-C4'-C5'-O5'
88	A7	64	Y5P	C3'-C4'-C5'-O5'
87	A5	4	Y5P	C2'-C1'-N1-C2

Continued on next page...

Continued from previous page...

Mol	Chain	Res	Type	Atoms
88	A7	7	P5P	C4'-C5'-O5'-P
88	A7	51	Y5P	C4'-C5'-O5'-P
88	A7	65	Y5P	C4'-C5'-O5'-P
88	A7	12	Y5P	O4'-C4'-C5'-O5'
88	A7	9	Y5P	O4'-C1'-N1-C2
87	A5	4	Y5P	O4'-C1'-N1-C6
88	A7	44	Y5P	O4'-C1'-N1-C2
88	A7	53	Y5P	C2'-C1'-N1-C6
88	A7	68	Y5P	O4'-C1'-N1-C6
88	A7	44	Y5P	C2'-C1'-N1-C2
87	A5	3	Y5P	O4'-C1'-N1-C2
88	A7	17	Y5P	O4'-C1'-N1-C2
88	A7	52	P5P	C4'-C5'-O5'-P
88	A7	38	Y5P	C3'-C4'-C5'-O5'
87	A5	1	Y5P	O4'-C1'-N1-C6
88	A7	50	Y5P	O4'-C4'-C5'-O5'
87	A5	3	Y5P	C2'-C1'-N1-C2
88	A7	53	Y5P	O4'-C1'-N1-C2
88	A7	5	P5P	O4'-C4'-C5'-O5'
88	A7	44	Y5P	O4'-C4'-C5'-O5'

There are no ring outliers.

No monomer is involved in short contacts.

5.5 Carbohydrates [i](#)

There are no monosaccharides in this entry.

5.6 Ligand geometry [i](#)

Of 139 ligands modelled in this entry, 137 are monoatomic - leaving 2 for Mogul analysis.

In the following table, the Counts columns list the number of bonds (or angles) for which Mogul statistics could be retrieved, the number of bonds (or angles) that are observed in the model and the number of bonds (or angles) that are defined in the Chemical Component Dictionary. The Link column lists molecule types, if any, to which the group is linked. The Z score for a bond length (or angle) is the number of standard deviations the observed value is removed from the expected value. A bond length (or angle) with $|Z| > 2$ is considered an outlier worth inspection. RMSZ is the root-mean-square of all Z scores of the bond lengths (or angles).

Mol	Type	Chain	Res	Link	Bond lengths			Bond angles		
					Counts	RMSZ	# Z > 2	Counts	RMSZ	# Z > 2
92	GCP	v	802	89	27,34,34	1.82	6 (22%)	34,54,54	2.36	8 (23%)
91	GDP	AX	500	-	24,30,30	0.96	1 (4%)	30,47,47	1.30	4 (13%)

In the following table, the Chirals column lists the number of chiral outliers, the number of chiral centers analysed, the number of these observed in the model and the number defined in the Chemical Component Dictionary. Similar counts are reported in the Torsion and Rings columns. '-' means no outliers of that kind were identified.

Mol	Type	Chain	Res	Link	Chirals	Torsions	Rings
92	GCP	v	802	89	-	5/15/38/38	0/3/3/3
91	GDP	AX	500	-	-	1/12/32/32	0/3/3/3

All (7) bond length outliers are listed below:

Mol	Chain	Res	Type	Atoms	Z	Observed(Å)	Ideal(Å)
92	v	802	GCP	PG-O1G	5.34	1.61	1.50
92	v	802	GCP	C5-C6	4.49	1.49	1.41
92	v	802	GCP	PG-O3G	3.01	1.61	1.54
92	v	802	GCP	PG-O2G	-2.53	1.49	1.54
91	AX	500	GDP	C6-N1	-2.36	1.34	1.37
92	v	802	GCP	PB-O2B	2.34	1.61	1.56
92	v	802	GCP	C5-C4	2.32	1.47	1.40

All (12) bond angle outliers are listed below:

Mol	Chain	Res	Type	Atoms	Z	Observed(°)	Ideal(°)
92	v	802	GCP	PB-O3A-PA	-6.13	113.13	132.56
92	v	802	GCP	C4-C5-C6	-5.86	115.20	120.80
92	v	802	GCP	C2-N1-C6	4.66	123.34	115.93
92	v	802	GCP	C2-N3-C4	4.59	120.60	115.36
92	v	802	GCP	N3-C2-N1	-4.02	121.86	127.22
92	v	802	GCP	C5-C6-N1	-3.99	117.98	123.43
92	v	802	GCP	C1'-N9-C4	-3.88	119.83	126.64
91	AX	500	GDP	PA-O3A-PB	-3.58	120.54	132.83
91	AX	500	GDP	C3'-C2'-C1'	3.03	105.53	100.98
91	AX	500	GDP	C8-N7-C5	2.33	107.43	102.99
91	AX	500	GDP	C5-C6-N1	2.31	118.03	113.95
92	v	802	GCP	C4-C5-N7	-2.28	107.02	109.40

There are no chirality outliers.

All (6) torsion outliers are listed below:

Mol	Chain	Res	Type	Atoms
92	v	802	GCP	PG-C3B-PB-O1B
92	v	802	GCP	PG-C3B-PB-O3A
92	v	802	GCP	O4'-C4'-C5'-O5'
92	v	802	GCP	C3'-C4'-C5'-O5'
92	v	802	GCP	PG-C3B-PB-O2B
91	AX	500	GDP	O4'-C4'-C5'-O5'

There are no ring outliers.

No monomer is involved in short contacts.

The following is a two-dimensional graphical depiction of Mogul quality analysis of bond lengths, bond angles, torsion angles, and ring geometry for all instances of the Ligand of Interest. In addition, ligands with molecular weight > 250 and outliers as shown on the validation Tables will also be included. For torsion angles, if less than 5% of the Mogul distribution of torsion angles is within 10 degrees of the torsion angle in question, then that torsion angle is considered an outlier. Any bond that is central to one or more torsion angles identified as an outlier by Mogul will be highlighted in the graph. For rings, the root-mean-square deviation (RMSD) between the ring in question and similar rings identified by Mogul is calculated over all ring torsion angles. If the average RMSD is greater than 60 degrees and the minimal RMSD between the ring in question and any Mogul-identified rings is also greater than 60 degrees, then that ring is considered an outlier. The outliers are highlighted in purple. The color gray indicates Mogul did not find sufficient equivalents in the CSD to analyse the geometry.

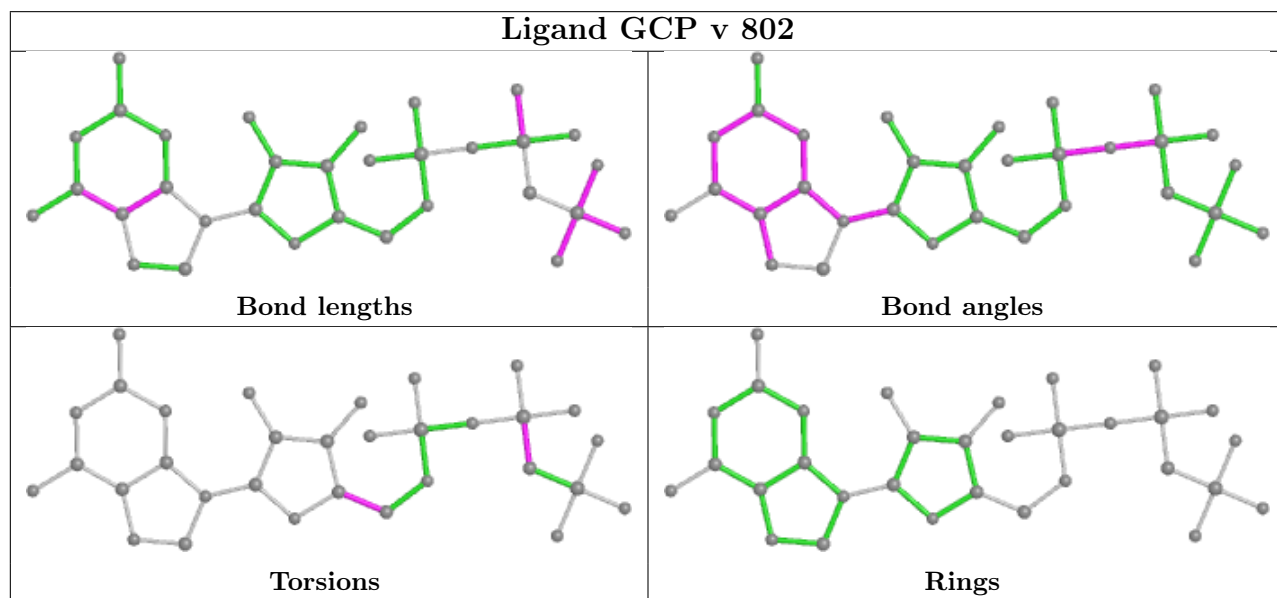

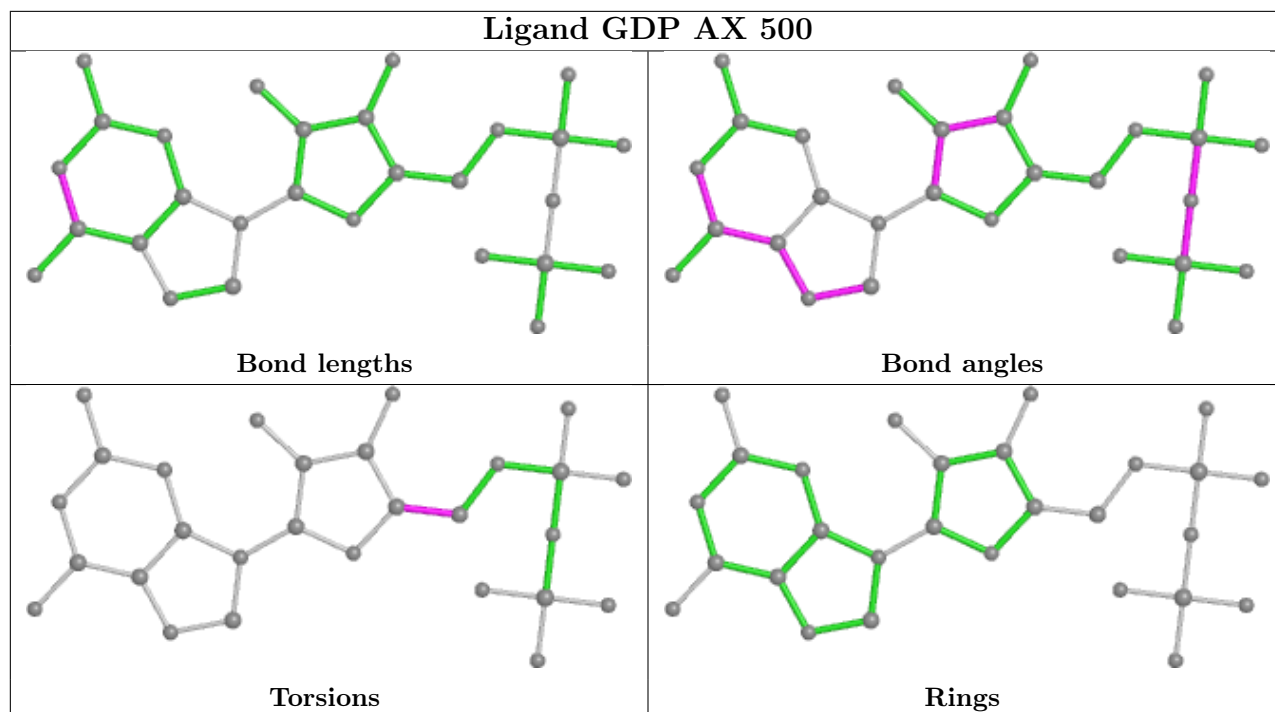

5.7 Other polymers [\(i\)](#)

There are no such residues in this entry.

5.8 Polymer linkage issues [\(i\)](#)

The following chains have linkage breaks:

Mol	Chain	Number of breaks
85	u	4

All chain breaks are listed below:

Model	Chain	Residue-1	Atom-1	Residue-2	Atom-2	Distance (Å)
1	u	414:UNK	C	601:UNK	N	48.04
1	u	106:UNK	C	301:UNK	N	30.89
1	u	315:UNK	C	399:UNK	N	19.09
1	u	615:UNK	C	700:UNK	N	18.25

6 Map visualisation [i](#)

This section contains visualisations of the EMDB entry EMD-21233. These allow visual inspection of the internal detail of the map and identification of artifacts.

No raw map or half-maps were deposited for this entry and therefore no images, graphs, etc. pertaining to the raw map can be shown.

6.1 Orthogonal projections [i](#)

6.1.1 Primary map

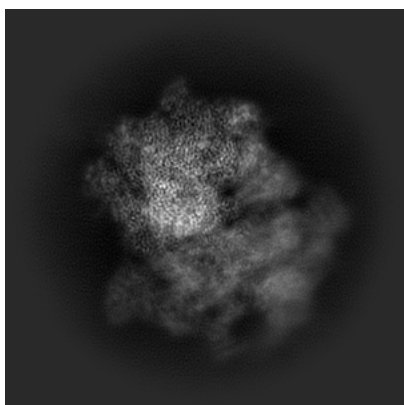

X

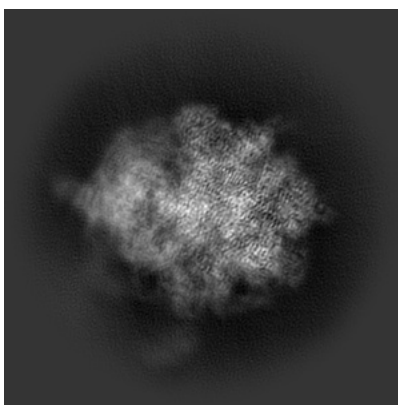

Y

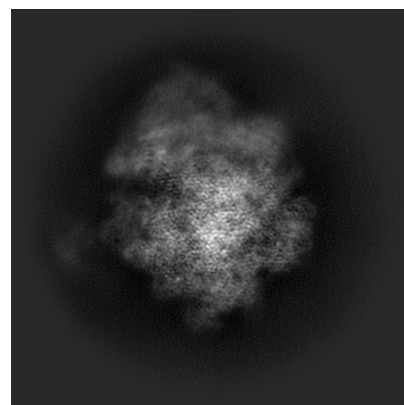

Z

The images above show the map projected in three orthogonal directions.

6.2 Central slices [i](#)

6.2.1 Primary map

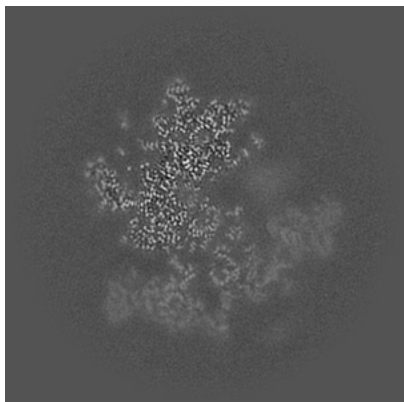

X Index: 200

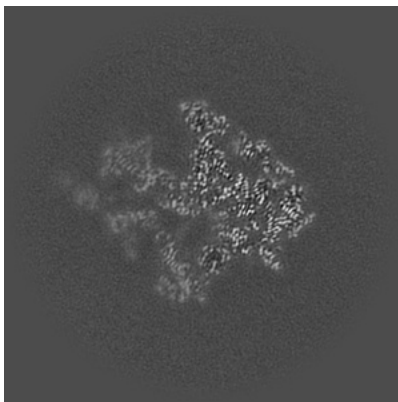

Y Index: 200

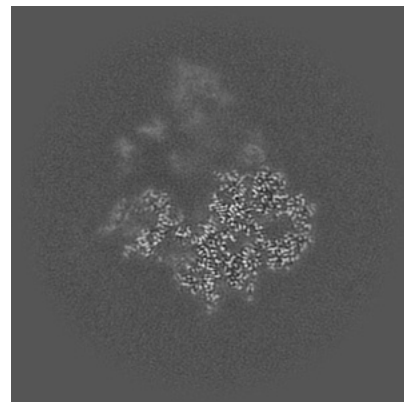

Z Index: 200

The images above show central slices of the map in three orthogonal directions.

6.3 Largest variance slices [i](#)

6.3.1 Primary map

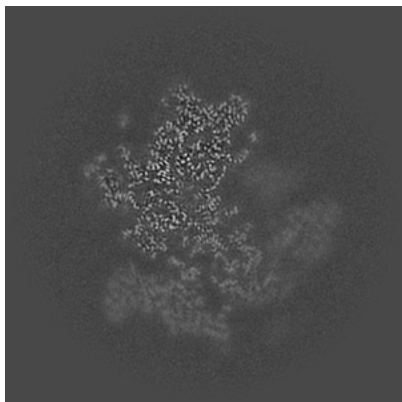

X Index: 205

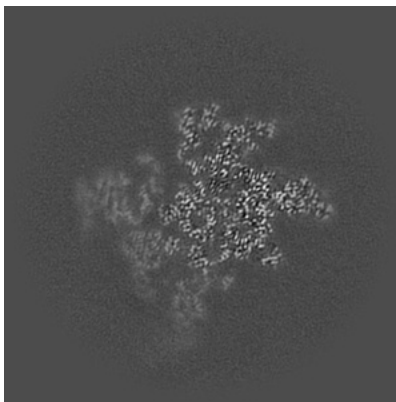

Y Index: 172

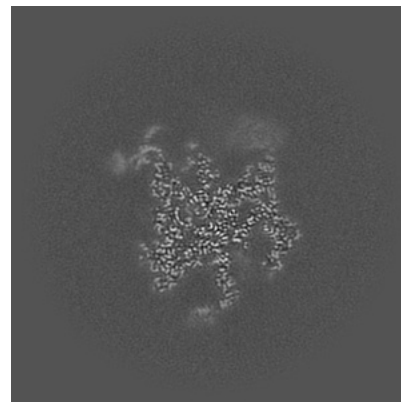

Z Index: 243

The images above show the largest variance slices of the map in three orthogonal directions.

6.4 Orthogonal standard-deviation projections (False-color) [i](#)

6.4.1 Primary map

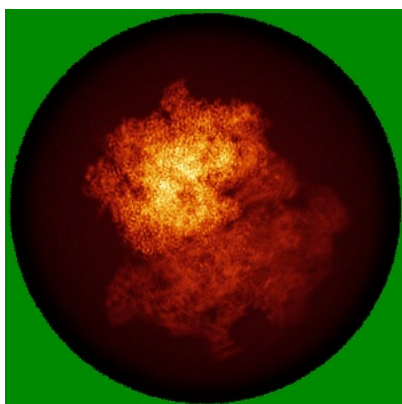

X

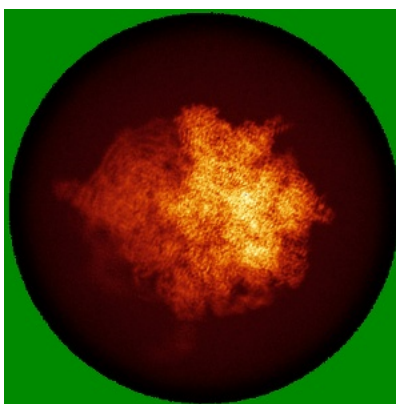

Y

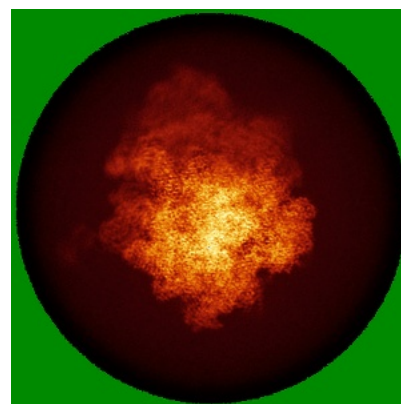

Z

The images above show the map standard deviation projections with false color in three orthogonal directions. Minimum values are shown in green, max in blue, and dark to light orange shades represent small to large values respectively.

6.5 Orthogonal surface views [i](#)

6.5.1 Primary map



X



Y



Z

The images above show the 3D surface view of the map at the recommended contour level 0.267. These images, in conjunction with the slice images, may facilitate assessment of whether an appropriate contour level has been provided.

6.6 Mask visualisation [i](#)

This section was not generated. No masks/segmentation were deposited.

7 Map analysis [i](#)

This section contains the results of statistical analysis of the map.

7.1 Map-value distribution [i](#)

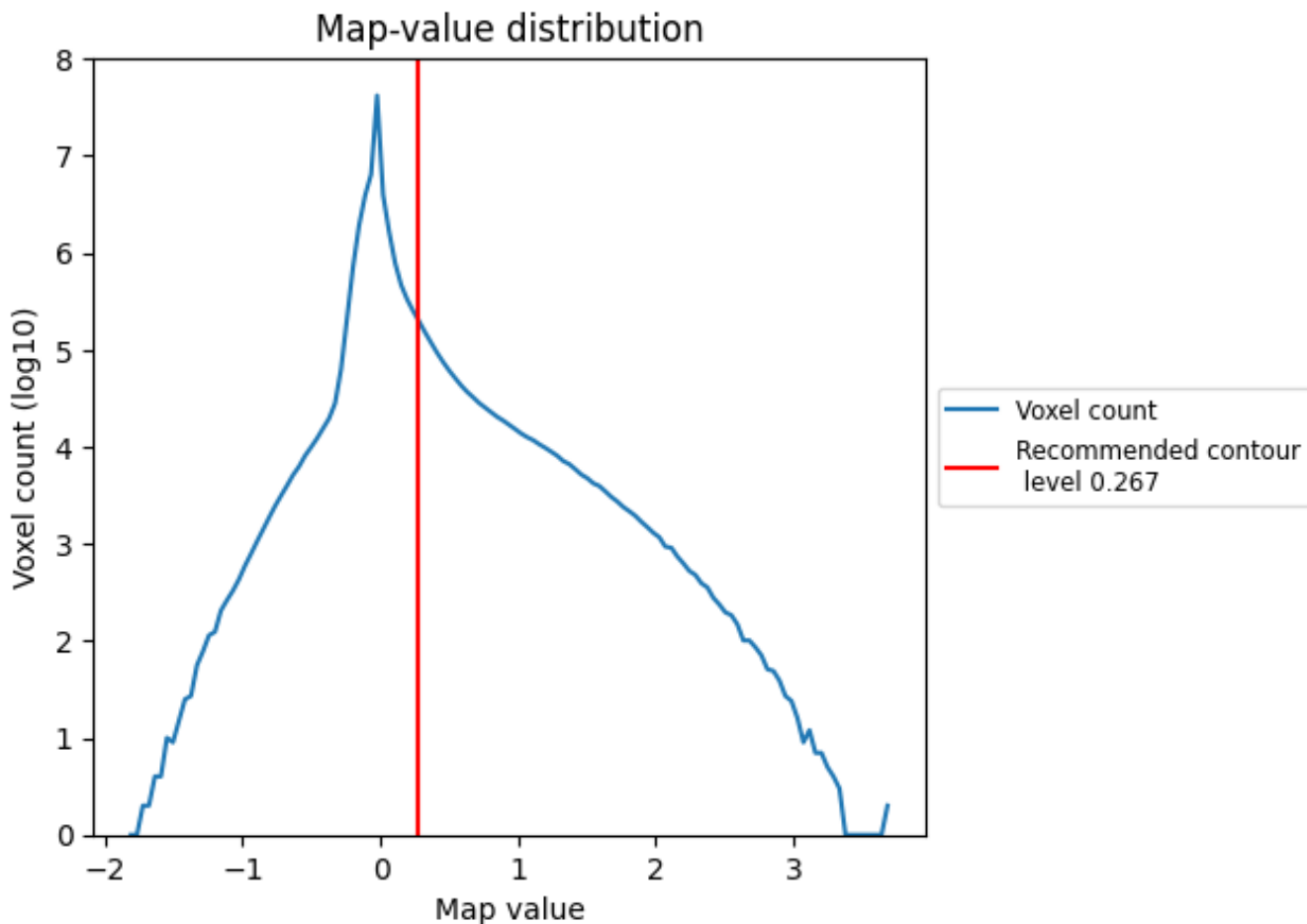

The map-value distribution is plotted in 128 intervals along the x-axis. The y-axis is logarithmic. A spike in this graph at zero usually indicates that the volume has been masked.

7.2 Volume estimate [i](#)

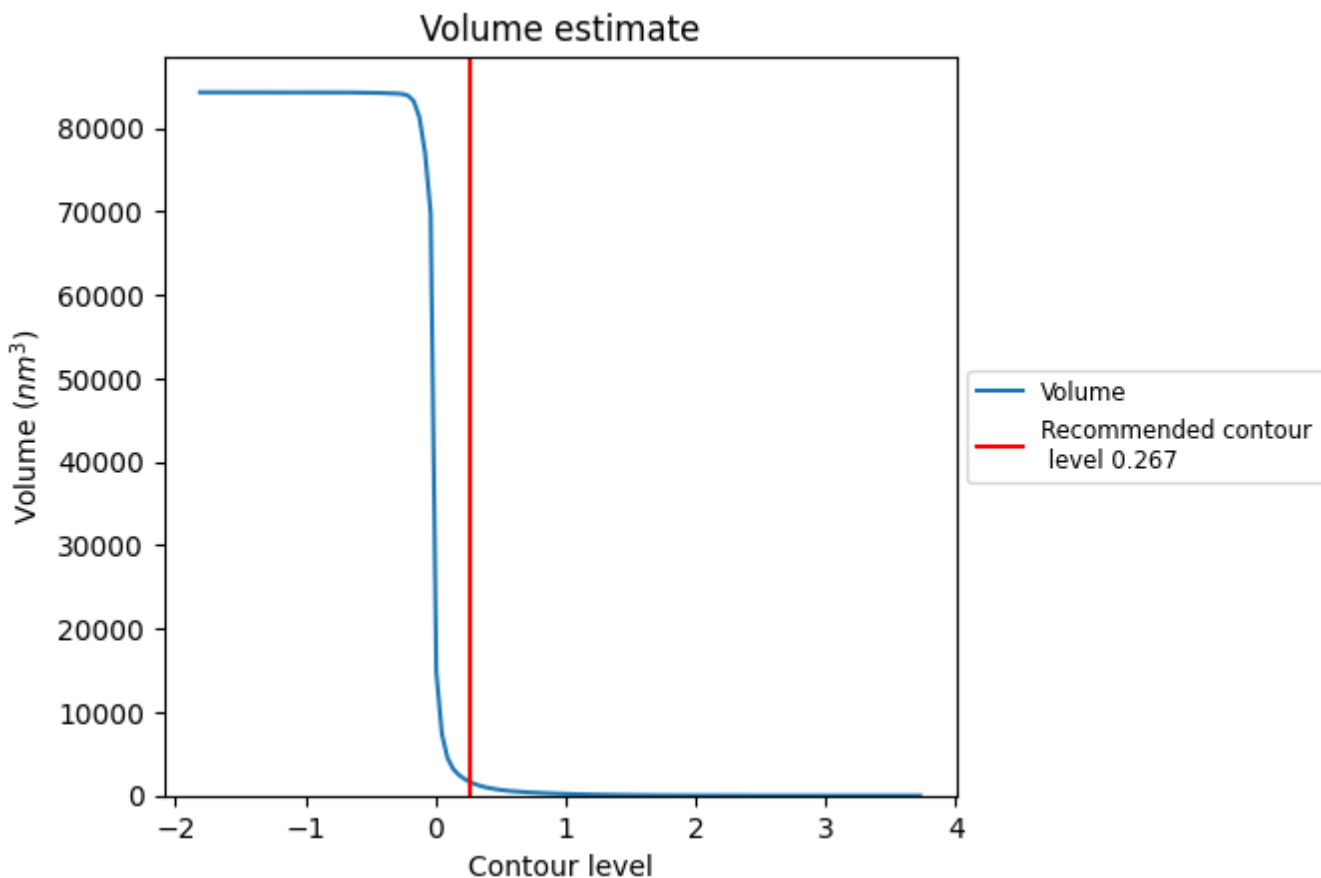

The volume at the recommended contour level is 1618 nm^3 ; this corresponds to an approximate mass of 1461 kDa.

The volume estimate graph shows how the enclosed volume varies with the contour level. The recommended contour level is shown as a vertical line and the intersection between the line and the curve gives the volume of the enclosed surface at the given level.

7.3 Rotationally averaged power spectrum i

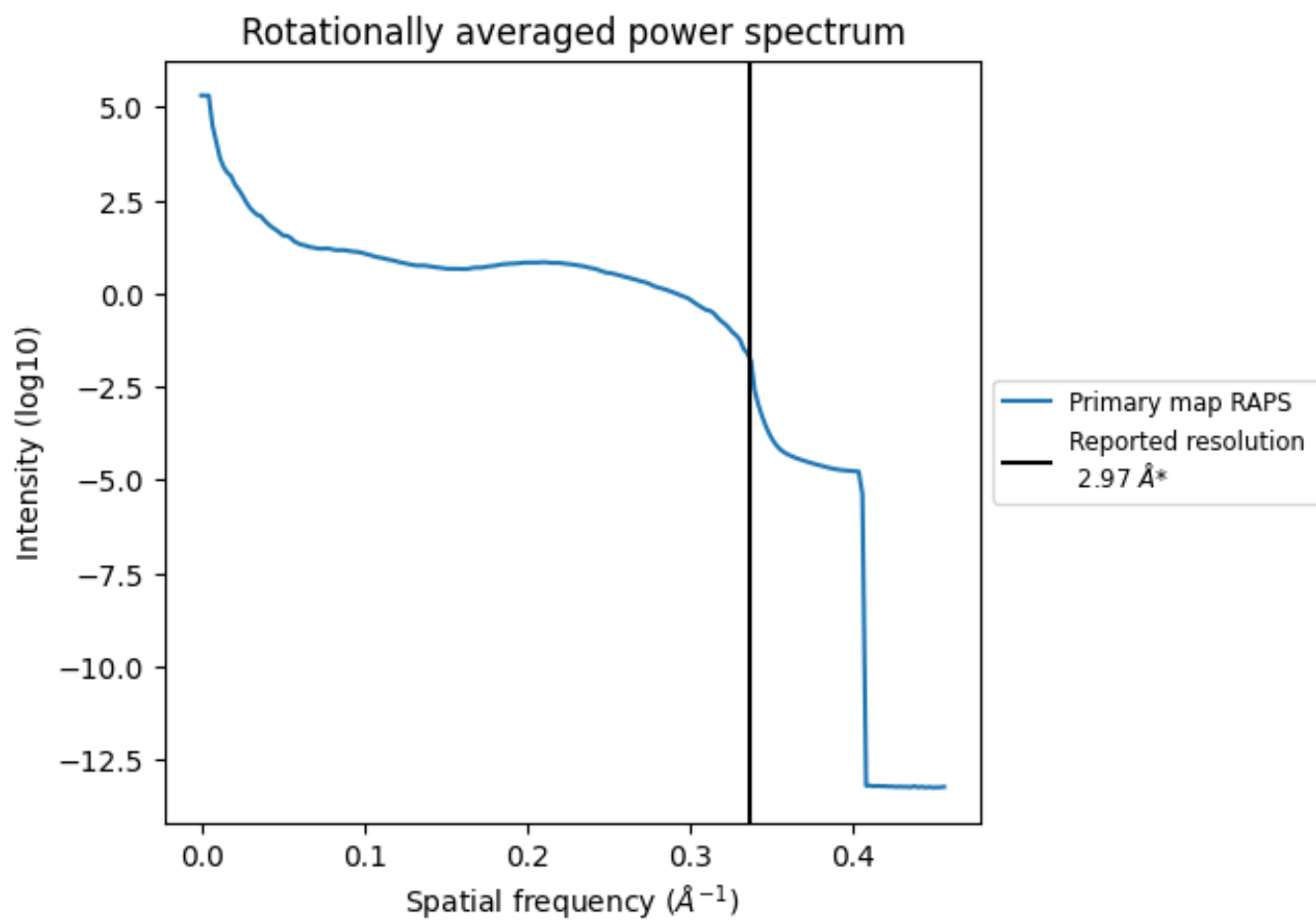

*Reported resolution corresponds to spatial frequency of 0.337 Å⁻¹

8 Fourier-Shell correlation

This section was not generated. No FSC curve or half-maps provided.

9 Map-model fit [i](#)

This section contains information regarding the fit between EMDB map EMD-21233 and PDB model 6VLZ. Per-residue inclusion information can be found in section 3 on page 22.

9.1 Map-model overlay [i](#)

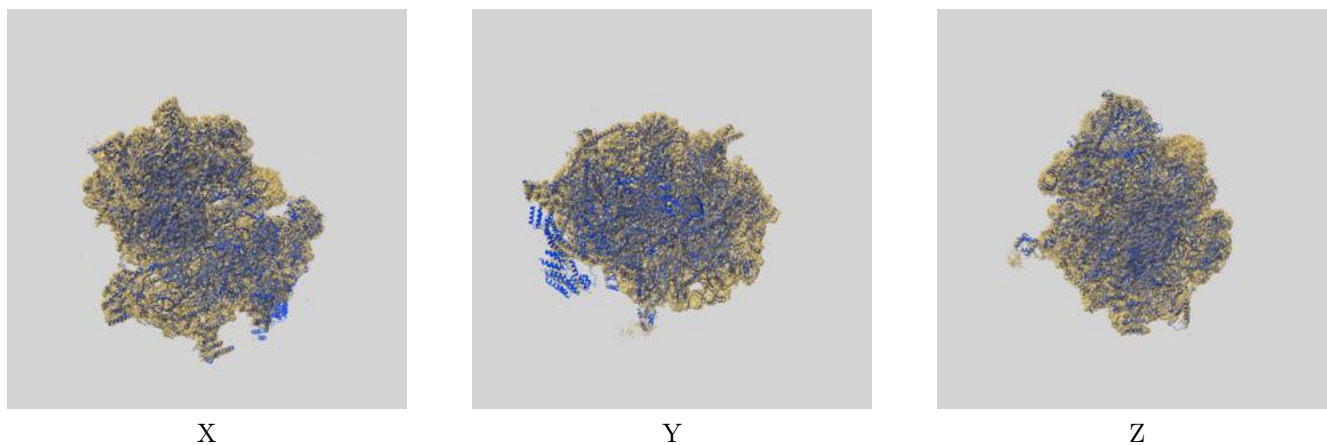

The images above show the 3D surface view of the map at the recommended contour level 0.267 at 50% transparency in yellow overlaid with a ribbon representation of the model coloured in blue. These images allow for the visual assessment of the quality of fit between the atomic model and the map.

9.2 Q-score mapped to coordinate model [i](#)

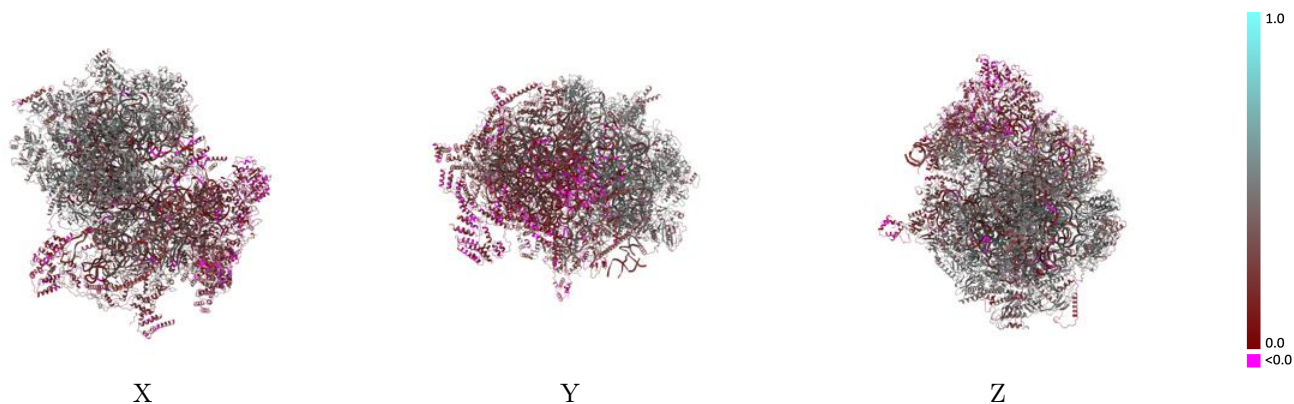

The images above show the model with each residue coloured according to its Q-score. This shows their resolvability in the map with higher Q-score values reflecting better resolvability. Please note: Q-score is calculating the resolvability of atoms, and thus high values are only expected at resolutions at which atoms can be resolved. Low Q-score values may therefore be expected for many entries.

9.3 Atom inclusion mapped to coordinate model [i](#)

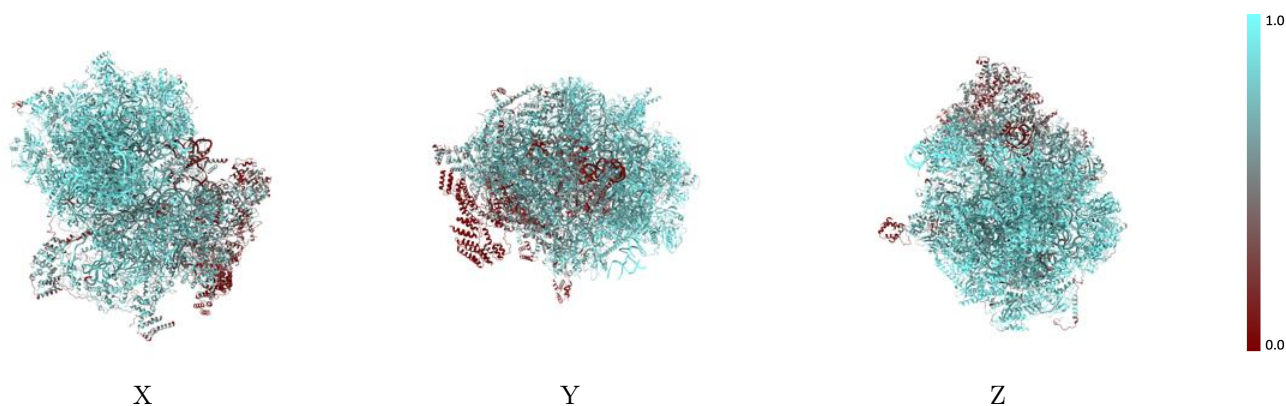

The images above show the model with each residue coloured according to its atom inclusion. This shows to what extent they are inside the map at the recommended contour level (0.267).



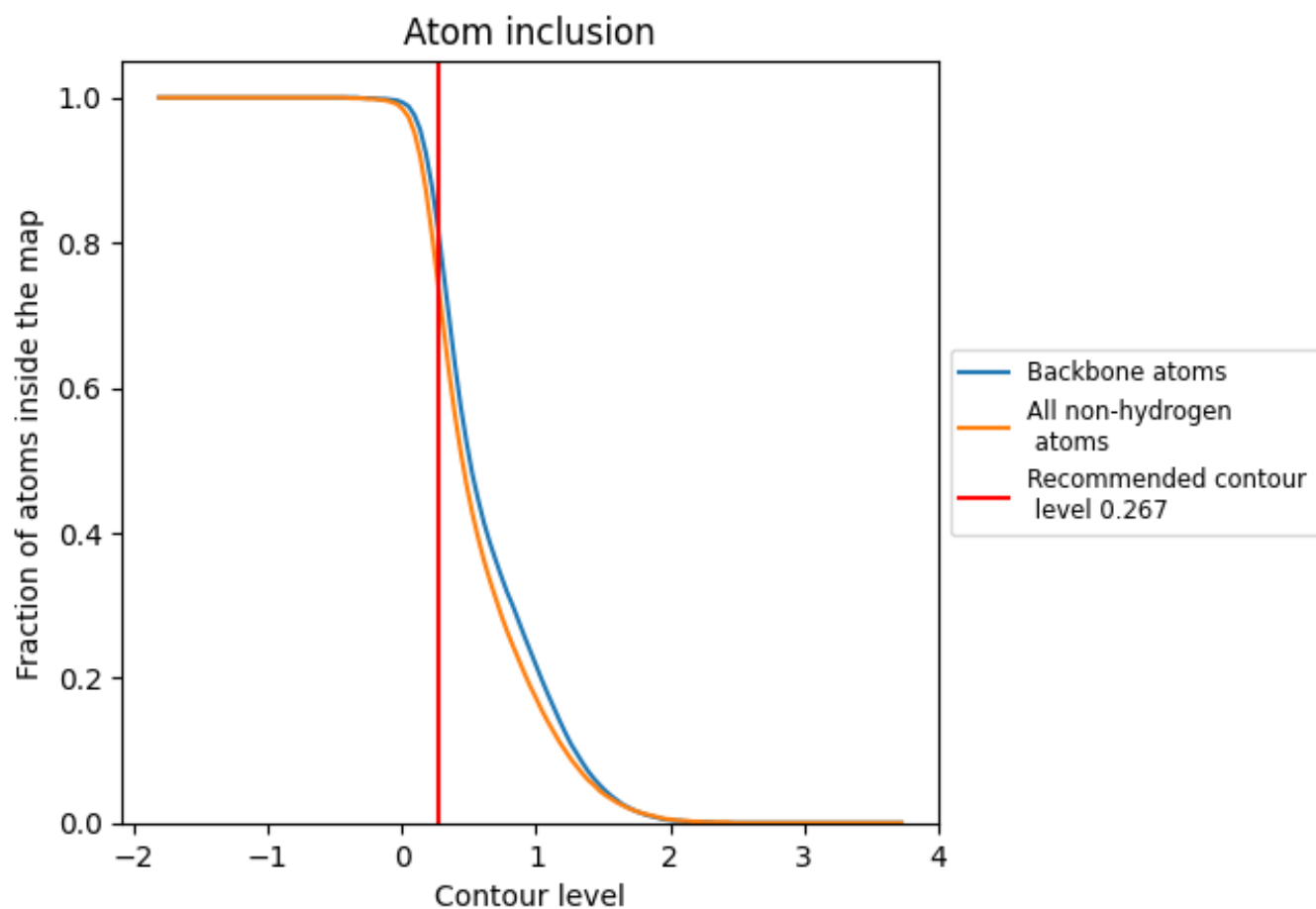



































































9.4 Atom inclusion [i](#)



At the recommended contour level, 82% of all backbone atoms, 75% of all non-hydrogen atoms, are inside the map.

9.5 Map-model fit summary

The table lists the average atom inclusion at the recommended contour level (0.267) and Q-score for the entire model and for each chain.

Chain	Atom inclusion	Q-score
All	 0.7470	 0.3170
0	 0.8580	 0.4350
1	 0.8410	 0.4250
2	 0.9110	 0.4820
3	 0.8970	 0.4990
4	 0.8590	 0.4400
5	 0.8880	 0.4360
6	 0.8750	 0.4050
7	 0.8610	 0.4030
8	 0.7270	 0.2300
9	 0.8720	 0.4070
A	 0.8440	 0.3320
A0	 0.6790	 0.2400
A1	 0.3650	 0.1370
A2	 0.4450	 0.2500
A3	 0.7270	 0.3760
A4	 0.1020	 0.1390
A5	 0.0240	 0.0310
A7	 0.1290	 0.0240
AA	 0.8170	 0.2590
AB	 0.6750	 0.2520
AC	 0.4550	 0.1700
AD	 0.5850	 0.2880
AE	 0.5540	 0.2510
AF	 0.4060	 0.2070
AG	 0.5010	 0.1720
AH	 0.4080	 0.1910
AI	 0.6400	 0.2880
AJ	 0.6970	 0.3530
AK	 0.6190	 0.1700
AL	 0.6750	 0.3090
AM	 0.7240	 0.2890
AN	 0.7960	 0.3620
AO	 0.6780	 0.2530
AP	 0.6310	 0.2770































Continued on next page...

Continued from previous page...

Chain	Atom inclusion	Q-score
AQ	0.7190	0.3230
AR	0.6150	0.2080
AS	0.5480	0.2090
AT	0.7510	0.3280
AU	0.6650	0.2020
AV	0.5190	0.1380
AW	0.6120	0.2510
AX	0.3530	0.0800
AY	0.3590	0.1320
AZ	0.4080	0.1530
B	0.9480	0.2870
D	0.8650	0.4350
E	0.8820	0.4590
F	0.8880	0.4590
H	0.8360	0.3920
I	0.6890	0.2600
J	0.7400	0.2690
K	0.9050	0.4740
L	0.8510	0.4540
M	0.8910	0.4500
N	0.8540	0.4300
O	0.8740	0.4370
P	0.8810	0.4120
Q	0.8070	0.4040
R	0.8890	0.4660
S	0.9020	0.4580
T	0.8910	0.4670
TA	0.1310	0.0810
TB	0.1550	0.0700
TC	0.0340	0.1480
U	0.8680	0.4330
V	0.8590	0.4160
W	0.8830	0.4550
X	0.8800	0.4430
Y	0.8900	0.4430
Z	0.8800	0.4520
a	0.7980	0.3920
b	0.9000	0.4710
c	0.8610	0.4180
d	0.7530	0.3680
e	0.6990	0.1610
f	0.7010	0.2860

Continued on next page...

Continued from previous page...

Chain	Atom inclusion	Q-score
g	 0.8720	 0.4180
h	 0.8210	 0.3580
i	 0.9010	 0.4680
j	 0.8450	 0.4100
k	 0.7430	 0.2880
l	 0.7680	 0.2830
m	 0.7420	 0.2190
o	 0.8580	 0.4220
p	 0.7950	 0.3700
q	 0.7480	 0.3460
r	 0.8750	 0.4280
s	 0.8800	 0.4360
u	 0.4740	 0.1660
v	 0.6950	 0.2920