



# Full wwPDB X-ray Structure Validation Report ⓘ

Nov 22, 2023 – 11:35 AM JST

PDB ID : 7VMK  
Title : Crystal structure of tubulin with 3  
Authors : Jifa, Z.; Lun, T.  
Deposited on : 2021-10-08  
Resolution : 2.50 Å(reported)

This is a Full wwPDB X-ray Structure Validation Report for a publicly released PDB entry.

We welcome your comments at [validation@mail.wwpdb.org](mailto:validation@mail.wwpdb.org)

A user guide is available at

<https://www.wwpdb.org/validation/2017/XrayValidationReportHelp>

with specific help available everywhere you see the ⓘ symbol.

The types of validation reports are described at

<http://www.wwpdb.org/validation/2017/FAQs#types>.

---

The following versions of software and data (see [references ⓘ](#)) were used in the production of this report:

MolProbity : 4.02b-467  
Mogul : 1.8.5 (274361), CSD as541be (2020)  
Xtriage (Phenix) : 1.13  
EDS : 2.36  
buster-report : 1.1.7 (2018)  
Percentile statistics : 20191225.v01 (using entries in the PDB archive December 25th 2019)  
Refmac : 5.8.0158  
CCP4 : 7.0.044 (Gargrove)  
Ideal geometry (proteins) : Engh & Huber (2001)  
Ideal geometry (DNA, RNA) : Parkinson et al. (1996)  
Validation Pipeline (wwPDB-VP) : 2.36

# 1 Overall quality at a glance

The following experimental techniques were used to determine the structure:

*X-RAY DIFFRACTION*

The reported resolution of this entry is 2.50 Å.

Percentile scores (ranging between 0-100) for global validation metrics of the entry are shown in the following graphic. The table shows the number of entries on which the scores are based.

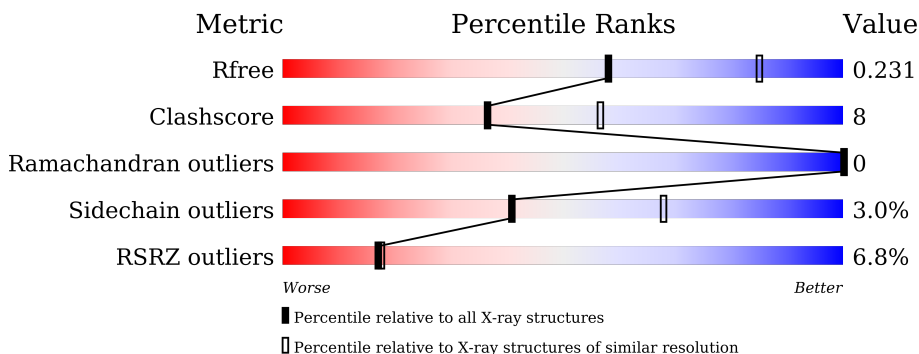

Metric	Whole archive (#Entries)	Similar resolution (#Entries, resolution range(Å))
$R_{free}$	130704	4661 (2.50-2.50)
Clashscore	141614	5346 (2.50-2.50)
Ramachandran outliers	138981	5231 (2.50-2.50)
Sidechain outliers	138945	5233 (2.50-2.50)
RSRZ outliers	127900	4559 (2.50-2.50)

The table below summarises the geometric issues observed across the polymeric chains and their fit to the electron density. The red, orange, yellow and green segments of the lower bar indicate the fraction of residues that contain outliers for  $\geq 3$ , 2, 1 and 0 types of geometric quality criteria respectively. A grey segment represents the fraction of residues that are not modelled. The numeric value for each fraction is indicated below the corresponding segment, with a dot representing fractions  $\leq 5\%$ . The upper red bar (where present) indicates the fraction of residues that have poor fit to the electron density. The numeric value is given above the bar.

Mol	Chain	Length	Quality of chain
1	A	450	 80% 17% .
1	C	450	 84% 13% ..
2	B	445	 79% 16% . .
2	D	445	 67% 27% . 5%
3	E	143	 73% 12% . 14%
4	F	384	 70% 20% . 9%

## 2 Entry composition i

There are 13 unique types of molecules in this entry. The entry contains 17937 atoms, of which 0 are hydrogens and 0 are deuteriums.

In the tables below, the ZeroOcc column contains the number of atoms modelled with zero occupancy, the AltConf column contains the number of residues with at least one atom in alternate conformation and the Trace column contains the number of residues modelled with at most 2 atoms.

- Molecule 1 is a protein called Tubulin alpha-1B chain.

Mol	Chain	Residues	Atoms					ZeroOcc	AltConf	Trace
			Total	C	N	O	S			
1	A	439	Total	C	N	O	S	0	6	0
			3458	2188	587	659	24			
1	C	440	Total	C	N	O	S	0	8	0
			3467	2195	585	661	26			

- Molecule 2 is a protein called Tubulin beta-2B chain.

Mol	Chain	Residues	Atoms					ZeroOcc	AltConf	Trace
			Total	C	N	O	S			
2	B	425	Total	C	N	O	S	0	4	0
			3378	2122	580	649	27			
2	D	421	Total	C	N	O	S	0	2	0
			3309	2080	562	641	26			

- Molecule 3 is a protein called Stathmin-4.

Mol	Chain	Residues	Atoms					ZeroOcc	AltConf	Trace
			Total	C	N	O	S			
3	E	123	Total	C	N	O	S	0	3	0
			1031	636	187	203	5			

There are 2 discrepancies between the modelled and reference sequences:

Chain	Residue	Modelled	Actual	Comment	Reference
E	3	MET	-	expression tag	UNP P63043
E	4	ALA	-	expression tag	UNP P63043

- Molecule 4 is a protein called Tubulin tyrosine ligase.

Mol	Chain	Residues	Atoms					ZeroOcc	AltConf	Trace
			Total	C	N	O	S			
4	F	351	Total	C	N	O	S	0	4	0
			2909	1867	502	525	15			

There are 6 discrepancies between the modelled and reference sequences:

Chain	Residue	Modelled	Actual	Comment	Reference
F	379	HIS	-	expression tag	UNP E1BQ43
F	380	HIS	-	expression tag	UNP E1BQ43
F	381	HIS	-	expression tag	UNP E1BQ43
F	382	HIS	-	expression tag	UNP E1BQ43
F	383	HIS	-	expression tag	UNP E1BQ43
F	384	HIS	-	expression tag	UNP E1BQ43

- Molecule 5 is GUANOSINE-5'-TRIPHOSPHATE (three-letter code: GTP) (formula:  $C_{10}H_{16}N_5O_{14}P_3$ ).



Mol	Chain	Residues	Atoms					ZeroOcc	AltConf
			Total	C	N	O	P		
5	A	1	Total	C	N	O	P	0	0
			32	10	5	14	3		
5	C	1	Total	C	N	O	P	0	0
			32	10	5	14	3		

- Molecule 6 is MAGNESIUM ION (three-letter code: MG) (formula: Mg).

Mol	Chain	Residues	Atoms		ZeroOcc	AltConf
			Total	Mg		
6	A	1	Total	Mg	0	0
			1	1		
6	B	2	Total	Mg	0	0
			2	2		
6	C	1	Total	Mg	0	0
			1	1		

- Molecule 7 is CALCIUM ION (three-letter code: CA) (formula: Ca).

Mol	Chain	Residues	Atoms	ZeroOcc	AltConf
7	A	2	Total Ca 2 2	0	0
7	B	1	Total Ca 1 1	0	0
7	C	1	Total Ca 1 1	0	0

- Molecule 8 is GUANOSINE-5'-DIPHOSPHATE (three-letter code: GDP) (formula:  $C_{10}H_{15}N_5O_{11}P_2$ ).

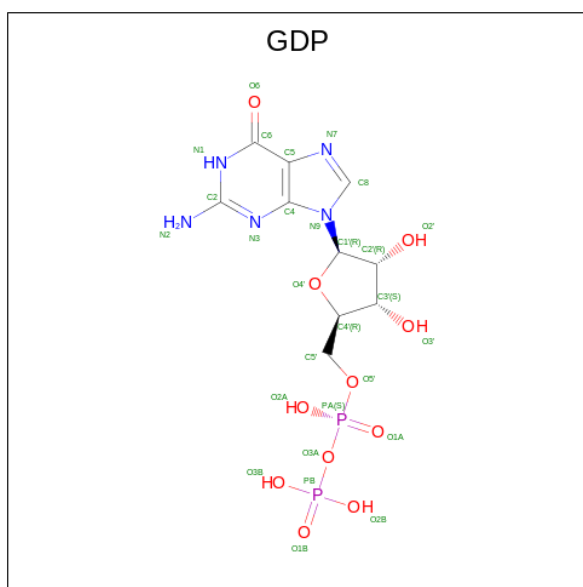

Mol	Chain	Residues	Atoms	ZeroOcc	AltConf
8	B	1	Total C N O P 28 10 5 11 2	0	0
8	D	1	Total C N O P 28 10 5 11 2	0	0

- Molecule 9 is 2-(N-MORPHOLINO)-ETHANESULFONIC ACID (three-letter code: MES) (formula:  $C_6H_{13}NO_4S$ ).



Mol	Chain	Residues	Atoms					ZeroOcc	AltConf
9	B	1	Total	C	N	O	S	0	0
			12	6	1	4	1		
9	B	1	Total	C	N	O	S	0	0
			12	6	1	4	1		

- Molecule 10 is DI(HYDROXYETHYL)ETHER (three-letter code: PEG) (formula:  $C_4H_{10}O_3$ ).

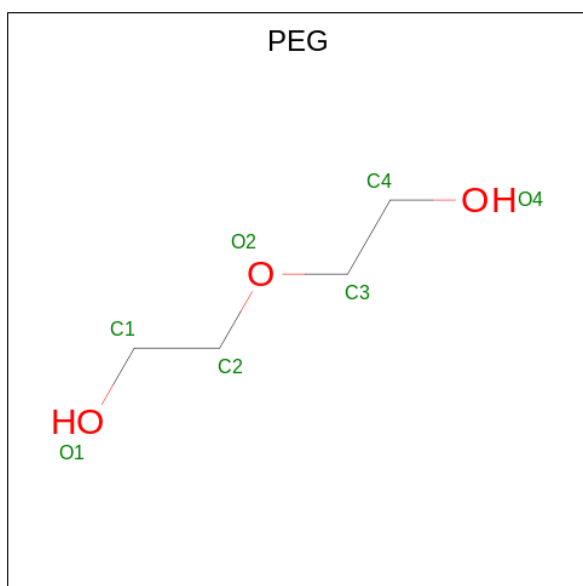

Mol	Chain	Residues	Atoms			ZeroOcc	AltConf
10	B	1	Total	C	O	0	0
			7	4	3		

- Molecule 11 is N-[3-[[6-[[3-(trifluoromethyl)phenyl]amino]pyrimidin-4-yl]amino]phenyl]cyclopropanecarboxamide (three-letter code: 7PL) (formula:  $C_{21}H_{18}F_3N_5O$ ) (labeled as "Ligand of Interest" by depositor).

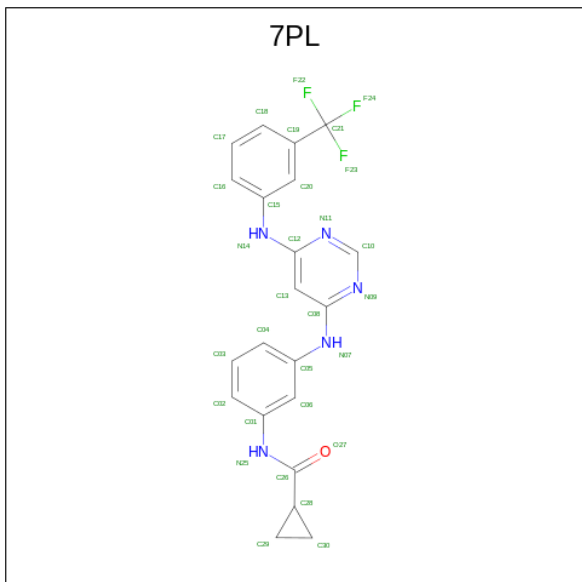

Mol	Chain	Residues	Atoms					ZeroOcc	AltConf
			Total	C	F	N	O		
11	B	1	30	21	3	5	1	0	0

- Molecule 12 is PHOSPHOMETHYLPHOSPHONIC ACID ADENYLATE ESTER (three-letter code: ACP) (formula:  $C_{11}H_{18}N_5O_{12}P_3$ ).

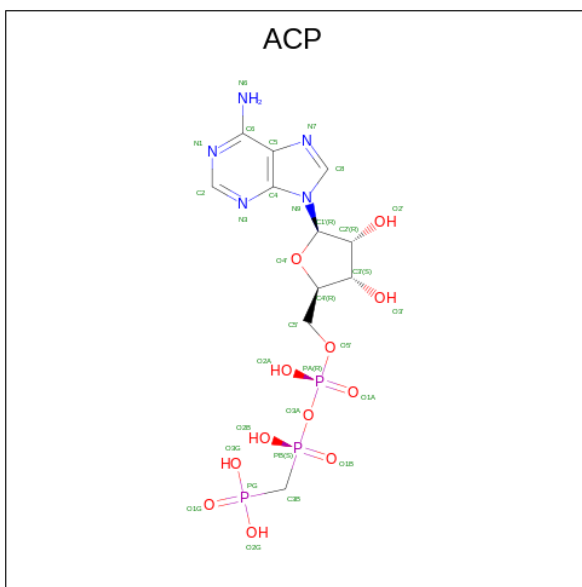

Mol	Chain	Residues	Atoms					ZeroOcc	AltConf
			Total	C	N	O	P		
12	F	1	31	11	5	12	3	0	0

- Molecule 13 is water.

Mol	Chain	Residues	Atoms		ZeroOcc	AltConf
13	A	30	Total	O	0	0
			30	30		
13	B	38	Total	O	0	0
			38	38		
13	C	81	Total	O	0	0
			81	81		
13	D	10	Total	O	0	0
			10	10		
13	E	3	Total	O	0	0
			3	3		
13	F	3	Total	O	0	0
			3	3		



### 3 Residue-property plots [i](#)

These plots are drawn for all protein, RNA, DNA and oligosaccharide chains in the entry. The first graphic for a chain summarises the proportions of the various outlier classes displayed in the second graphic. The second graphic shows the sequence view annotated by issues in geometry and electron density. Residues are color-coded according to the number of geometric quality criteria for which they contain at least one outlier: green = 0, yellow = 1, orange = 2 and red = 3 or more. A red dot above a residue indicates a poor fit to the electron density ( $RSRZ > 2$ ). Stretches of 2 or more consecutive residues without any outlier are shown as a green connector. Residues present in the sample, but not in the model, are shown in grey.

- Molecule 1: Tubulin alpha-1B chain

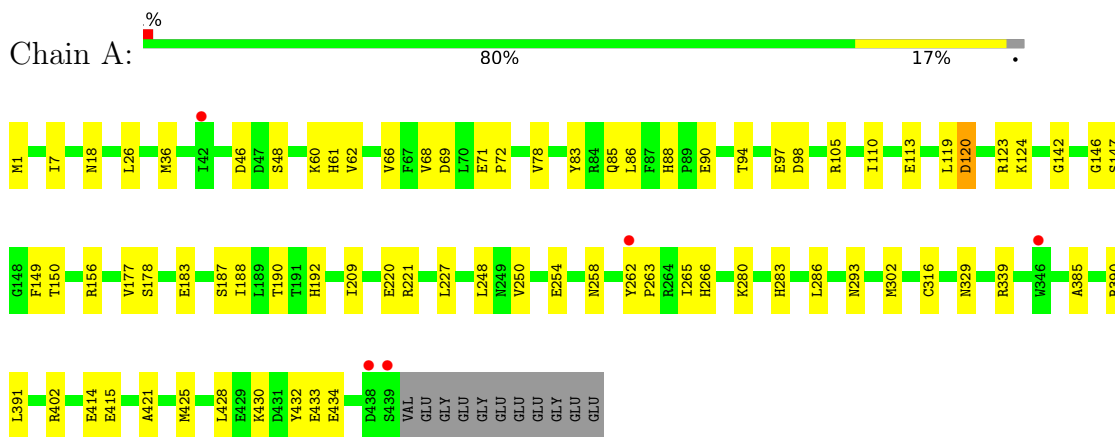

- Molecule 1: Tubulin alpha-1B chain

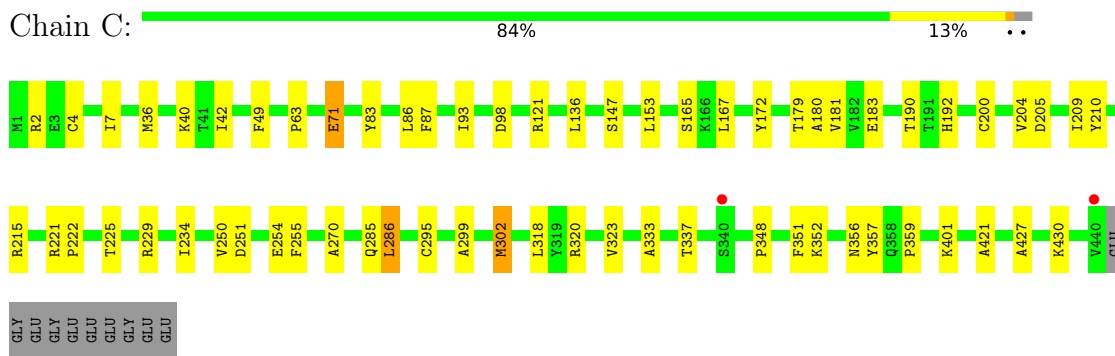

- Molecule 2: Tubulin beta-2B chain

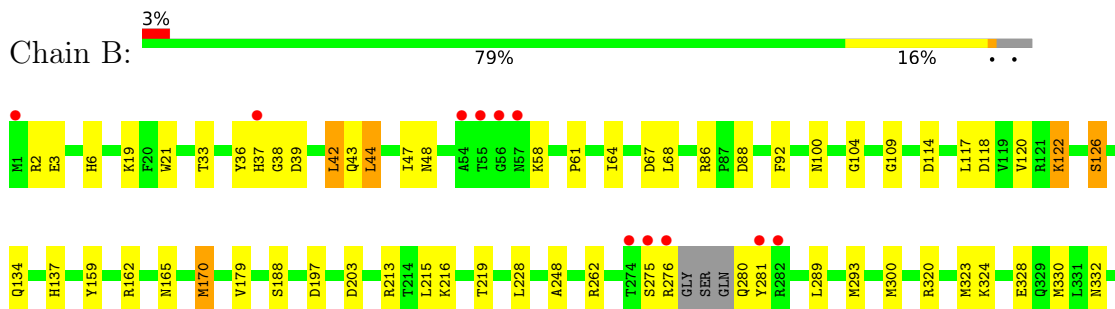



• Molecule 2: Tubulin beta-2B chain

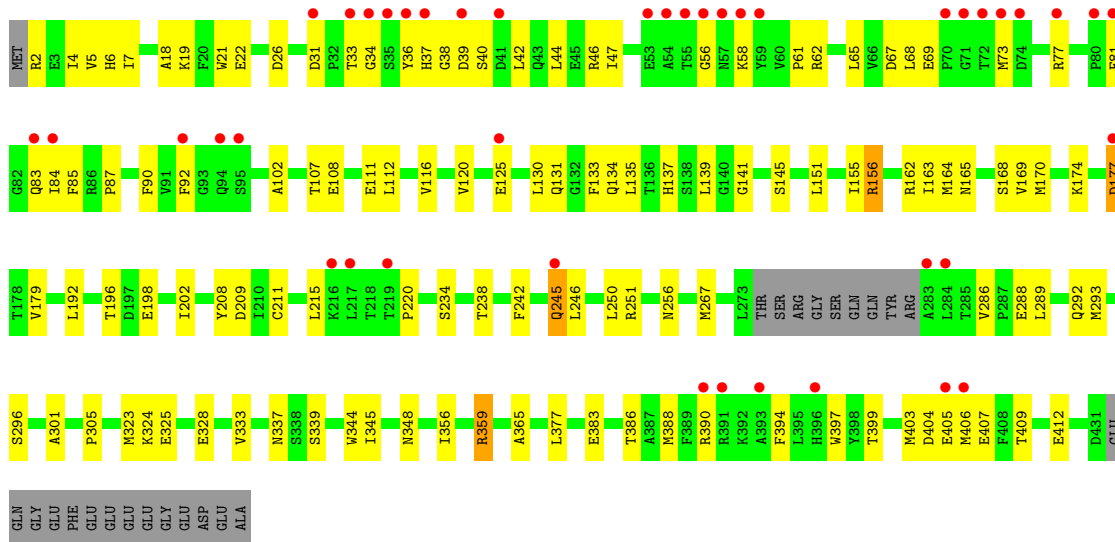

• Molecule 3: Stathmin-4

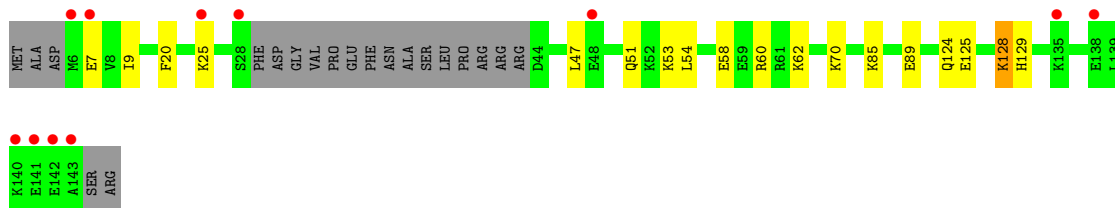

• Molecule 4: Tubulin tyrosine ligase

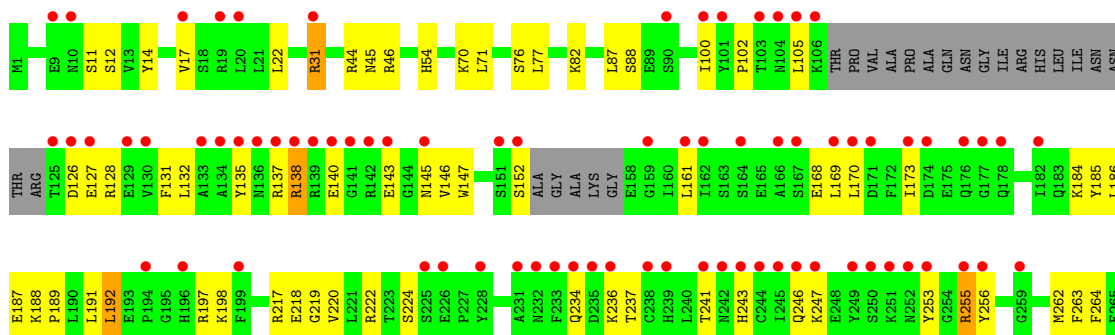



## 4 Data and refinement statistics

Property	Value	Source
Space group	P 21 21 21	Depositor
Cell constants a, b, c, $\alpha$ , $\beta$ , $\gamma$	104.83Å 157.51Å 182.19Å 90.00° 90.00° 90.00°	Depositor
Resolution (Å)	49.73 – 2.50 49.73 – 2.50	Depositor EDS
% Data completeness (in resolution range)	98.3 (49.73-2.50) 98.3 (49.73-2.50)	Depositor EDS
$R_{merge}$	0.17	Depositor
$R_{sym}$	(Not available)	Depositor
$\langle I/\sigma(I) \rangle$ <sup>1</sup>	1.95 (at 2.51Å)	Xtrriage
Refinement program	PHENIX 1.19_4092	Depositor
R, $R_{free}$	0.194 , 0.232 0.193 , 0.231	Depositor DCC
$R_{free}$ test set	1999 reflections (1.94%)	wwPDB-VP
Wilson B-factor (Å <sup>2</sup> )	37.5	Xtrriage
Anisotropy	0.040	Xtrriage
Bulk solvent $k_{sol}$ (e/Å <sup>3</sup> ), $B_{sol}$ (Å <sup>2</sup> )	0.33 , 47.2	EDS
L-test for twinning <sup>2</sup>	$\langle  L  \rangle = 0.50$ , $\langle L^2 \rangle = 0.33$	Xtrriage
Estimated twinning fraction	No twinning to report.	Xtrriage
$F_o, F_c$ correlation	0.94	EDS
Total number of atoms	17937	wwPDB-VP
Average B, all atoms (Å <sup>2</sup> )	48.0	wwPDB-VP

Xtrriage's analysis on translational NCS is as follows: *The largest off-origin peak in the Patterson function is 2.58% of the height of the origin peak. No significant pseudotranslation is detected.*

<sup>1</sup>Intensities estimated from amplitudes.

<sup>2</sup>Theoretical values of  $\langle |L| \rangle$ ,  $\langle L^2 \rangle$  for acentric reflections are 0.5, 0.333 respectively for untwinned datasets, and 0.375, 0.2 for perfectly twinned datasets.

## 5 Model quality [i](#)

### 5.1 Standard geometry [i](#)

Bond lengths and bond angles in the following residue types are not validated in this section: MG, CA, GTP, GDP, ACP, 7PL, PEG, MES

The Z score for a bond length (or angle) is the number of standard deviations the observed value is removed from the expected value. A bond length (or angle) with  $|Z| > 5$  is considered an outlier worth inspection. RMSZ is the root-mean-square of all Z scores of the bond lengths (or angles).

Mol	Chain	Bond lengths		Bond angles	
		RMSZ	# Z  >5	RMSZ	# Z  >5
1	A	0.53	0/3554	0.68	1/4824 (0.0%)
1	C	0.60	1/3566 (0.0%)	0.72	0/4841
2	B	0.53	0/3461	0.68	0/4685
2	D	0.46	0/3385	0.64	1/4586 (0.0%)
3	E	0.54	0/1049	0.64	1/1393 (0.1%)
4	F	0.41	0/2989	0.62	0/4036
All	All	0.52	1/18004 (0.0%)	0.67	3/24365 (0.0%)

All (1) bond length outliers are listed below:

Mol	Chain	Res	Type	Atoms	Z	Observed(Å)	Ideal(Å)
1	C	295	CYS	CB-SG	-6.01	1.72	1.82

All (3) bond angle outliers are listed below:

Mol	Chain	Res	Type	Atoms	Z	Observed(°)	Ideal(°)
3	E	25	LYS	CB-CA-C	5.22	120.85	110.40
2	D	69	GLU	C-N-CD	5.16	139.24	128.40
1	A	286	LEU	CA-CB-CG	-5.16	103.43	115.30

There are no chirality outliers.

There are no planarity outliers.

### 5.2 Too-close contacts [i](#)

In the following table, the Non-H and H(model) columns list the number of non-hydrogen atoms and hydrogen atoms in the chain respectively. The H(added) column lists the number of hydrogen atoms added and optimized by MolProbity. The Clashes column lists the number of clashes within the asymmetric unit, whereas Symm-Clashes lists symmetry-related clashes.

Mol	Chain	Non-H	H(model)	H(added)	Clashes	Symm-Clashes
1	A	3458	0	3379	48	0
1	C	3467	0	3387	40	0
2	B	3378	0	3269	52	0
2	D	3309	0	3187	87	0
3	E	1031	0	1048	10	0
4	F	2909	0	2886	50	0
5	A	32	0	12	0	0
5	C	32	0	12	0	0
6	A	1	0	0	0	0
6	B	2	0	0	0	0
6	C	1	0	0	0	0
7	A	2	0	0	0	0
7	B	1	0	0	0	0
7	C	1	0	0	0	0
8	B	28	0	12	0	0
8	D	28	0	12	0	0
9	B	24	0	26	4	0
10	B	7	0	10	3	0
11	B	30	0	0	1	0
12	F	31	0	13	1	0
13	A	30	0	0	0	0
13	B	38	0	0	1	0
13	C	81	0	0	1	0
13	D	10	0	0	3	0
13	E	3	0	0	1	0
13	F	3	0	0	0	0
All	All	17937	0	17253	277	0

The all-atom clashscore is defined as the number of clashes found per 1000 atoms (including hydrogen atoms). The all-atom clashscore for this structure is 8.

All (277) close contacts within the same asymmetric unit are listed below, sorted by their clash magnitude.

Atom-1	Atom-2	Interatomic distance (Å)	Clash overlap (Å)
4:F:128:ARG:HD2	4:F:170:LEU:HD22	1.58	0.86
2:D:73:MET:HE3	2:D:90:PHE:HD2	1.41	0.85
4:F:186:LEU:HD23	4:F:320[B]:MET:HE1	1.59	0.84
1:A:220:GLU:HG2	2:B:324:LYS:HD2	1.58	0.84
2:B:170:MET:HG2	2:B:377:LEU:HD21	1.62	0.82
1:A:142:GLY:HA3	1:A:183:GLU:HG2	1.67	0.76
2:D:18:ALA:O	2:D:22:GLU:HG3	1.88	0.74
1:A:430:LYS:NZ	1:A:433:GLU:OE1	2.22	0.73

*Continued on next page...*

*Continued from previous page...*

Atom-1	Atom-2	Interatomic distance (Å)	Clash overlap (Å)
2:D:179:VAL:HG12	2:D:388:MET:CE	2.19	0.73
2:B:324:LYS:O	2:B:328:GLU:HG3	1.89	0.72
1:C:234:ILE:HG21	1:C:302[B]:MET:SD	2.30	0.72
2:D:386:THR:O	2:D:390:ARG:HG2	1.90	0.71
1:C:427:ALA:HA	1:C:430:LYS:HE3	1.73	0.70
2:D:81:PHE:O	2:D:84:ILE:HG22	1.92	0.70
1:A:414:GLU:OE2	3:E:60:ARG:NH1	2.27	0.68
2:D:44:LEU:HA	2:D:47:ILE:HB	1.76	0.68
2:B:323:MET:SD	2:B:353:VAL:HG21	2.34	0.68
2:B:38:GLY:HA3	2:B:43:GLN:OE1	1.93	0.67
2:D:170:MET:HG2	2:D:377:LEU:HD11	1.78	0.66
4:F:126:ASP:OD1	4:F:127:GLU:N	2.29	0.65
1:C:204:VAL:HG22	1:C:302[B]:MET:HE1	1.77	0.65
2:D:4:ILE:HG12	2:D:250:LEU:HD11	1.79	0.65
2:D:56:GLY:HA3	2:D:58:LYS:NZ	2.12	0.65
2:B:332:ASN:O	2:B:336:LYS:HG2	1.98	0.64
2:D:36:TYR:CD2	2:D:44:LEU:HD11	2.33	0.63
1:C:71:GLU:HG2	1:C:98:ASP:HB3	1.80	0.63
4:F:102:PRO:HD2	4:F:105:LEU:HD12	1.81	0.63
2:D:5:VAL:HG22	2:D:133:PHE:CD2	2.34	0.62
2:D:286:VAL:HB	2:D:325:GLU:HG2	1.82	0.62
2:D:179:VAL:HG12	2:D:388:MET:HE1	1.81	0.61
2:B:126:SER:OG	2:B:126:SER:O	2.19	0.61
1:A:293:ASN:OD1	1:A:339:ARG:NH1	2.34	0.61
2:D:324:LYS:O	2:D:328:GLU:HG3	2.00	0.61
2:D:288:GLU:O	2:D:292:GLN:HG3	2.01	0.61
2:B:293:MET:HG2	2:B:367:PHE:HB2	1.83	0.61
1:C:204:VAL:HG22	1:C:302[B]:MET:CE	2.30	0.61
2:D:409:THR:O	2:D:412:GLU:HB3	2.02	0.60
1:A:60:LYS:HD3	1:A:62:VAL:HG22	1.83	0.60
4:F:189:PRO:HG2	4:F:191:LEU:HD21	1.84	0.60
4:F:237:THR:O	4:F:246:GLN:NE2	2.35	0.60
2:D:73:MET:HE3	2:D:90:PHE:CD2	2.31	0.59
2:D:37:HIS:CG	2:D:37:HIS:O	2.56	0.59
2:D:238:THR:HG22	13:D:707:HOH:O	2.02	0.59
1:A:414:GLU:OE2	3:E:60:ARG:CZ	2.51	0.59
2:B:179:VAL:HG12	1:C:348:PRO:HG2	1.84	0.59
1:C:36:MET:HE1	1:C:49:PHE:CE1	2.38	0.58
4:F:266:GLU:N	4:F:266:GLU:OE1	2.37	0.58
2:B:203:ASP:OD2	2:B:380:ARG:NH2	2.36	0.58
2:B:213:ARG:O	2:B:216:LYS:HE2	2.03	0.58

*Continued on next page...*

*Continued from previous page...*

Atom-1	Atom-2	Interatomic distance (Å)	Clash overlap (Å)
3:E:85:LYS:NZ	13:E:201:HOH:O	2.37	0.58
4:F:31:ARG:H	4:F:31:ARG:HD3	1.68	0.58
2:D:36:TYR:CE1	2:D:38:GLY:HA3	2.38	0.58
4:F:188:LYS:HG2	4:F:323:GLU:CD	2.24	0.58
1:A:220:GLU:CG	2:B:324:LYS:HD2	2.31	0.58
4:F:147:TRP:HB2	4:F:169:LEU:HD11	1.85	0.58
1:A:71:GLU:HG2	1:A:72:PRO:HD2	1.86	0.57
1:C:225:THR:O	1:C:229:ARG:HG3	2.03	0.57
4:F:192:LEU:HD22	4:F:262:MET:HE1	1.86	0.57
2:B:100:ASN:HB2	10:B:507:PEG:H11	1.87	0.57
2:B:330:MET:HG3	2:B:351:THR:HG21	1.86	0.57
1:A:147:SER:HB2	1:A:190:THR:HB	1.86	0.57
1:A:36:MET:HB3	1:A:61:HIS:CE1	2.39	0.57
2:D:165:ASN:OD1	2:D:198:GLU:HG3	2.05	0.57
2:D:179:VAL:HG12	2:D:388:MET:HE3	1.85	0.57
2:D:139:LEU:HA	2:D:145[A]:SER:HB3	1.86	0.56
2:D:296:SER:HB3	2:D:305:PRO:HD2	1.88	0.56
1:C:221:ARG:HG3	2:D:323:MET:HB3	1.87	0.56
4:F:128:ARG:CD	4:F:170:LEU:HD22	2.34	0.55
1:C:323:VAL:O	1:C:357:TYR:HE1	1.89	0.55
1:C:255:PHE:CZ	1:C:318:LEU:HD22	2.41	0.55
2:B:280:GLN:HG3	2:B:281:TYR:H	1.72	0.55
2:B:118:ASP:O	2:B:122:LYS:HE2	2.07	0.54
1:C:250:VAL:HG22	1:C:255:PHE:CE2	2.42	0.54
4:F:263:PHE:CE2	4:F:341:LYS:HE2	2.42	0.54
2:D:102:ALA:HB2	2:D:403:MET:SD	2.48	0.54
1:A:88:HIS:CE1	1:A:90:GLU:HB2	2.43	0.54
4:F:247:LYS:HD2	4:F:253:TYR:CE2	2.43	0.54
1:C:270:ALA:HB3	1:C:302[B]:MET:SD	2.48	0.53
1:C:4[A]:CYS:SG	1:C:136:LEU:HG	2.47	0.53
4:F:220[A]:VAL:HG12	4:F:263:PHE:CE1	2.44	0.53
13:B:622:HOH:O	1:C:2:ARG:HD2	2.07	0.53
1:C:333:ALA:O	1:C:337:THR:HG23	2.08	0.53
2:D:139:LEU:HD21	2:D:168:SER:HB3	1.91	0.53
2:D:6:HIS:CD2	2:D:21:TRP:HE1	2.27	0.53
1:A:187:SER:HB3	1:A:391:LEU:HD21	1.92	0.52
1:C:215:ARG:NH1	1:C:299:ALA:HB1	2.24	0.52
4:F:161:LEU:HD21	4:F:168:GLU:HG3	1.90	0.52
1:A:97:GLU:OE2	1:A:105:ARG:NH2	2.43	0.52
2:B:100:ASN:HD22	10:B:507:PEG:H12	1.75	0.52
2:D:141:GLY:O	2:D:145[A]:SER:OG	2.24	0.52

*Continued on next page...*



*Continued from previous page...*

Atom-1	Atom-2	Interatomic distance (Å)	Clash overlap (Å)
3:E:125:GLU:OE1	3:E:128:LYS:HD2	2.10	0.52
2:B:48:ASN:H	2:B:48:ASN:ND2	2.08	0.51
2:B:215:LEU:HD11	2:B:228:LEU:HD21	1.92	0.51
4:F:132:LEU:HD21	4:F:170:LEU:HD11	1.91	0.51
2:B:42:LEU:CD1	2:B:42:LEU:N	2.72	0.51
4:F:138:ARG:HB3	4:F:145:ASN:CG	2.30	0.51
2:D:2:ARG:O	2:D:131:GLN:NE2	2.41	0.51
2:D:56:GLY:HA3	2:D:58:LYS:HZ1	1.74	0.51
1:A:402:ARG:NH1	1:A:415:GLU:OE2	2.42	0.50
1:C:180:ALA:HB3	1:C:183:GLU:HG3	1.93	0.50
3:E:53:LYS:HG3	3:E:54:LEU:N	2.24	0.50
4:F:263:PHE:CD2	4:F:341:LYS:HE2	2.46	0.50
2:B:21:TRP:CZ3	2:B:61:PRO:HB3	2.46	0.50
4:F:138:ARG:HG3	4:F:143:GLU:HB2	1.92	0.50
4:F:234:GLN:O	4:F:236:LYS:NZ	2.45	0.50
2:D:211:CYS:HA	2:D:215:LEU:HB2	1.94	0.50
2:B:197:ASP:OD2	9:B:504:MES:H52	2.12	0.50
1:A:209:ILE:HD11	1:A:302:MET:SD	2.51	0.50
4:F:217:ARG:HG3	4:F:218:GLU:HG2	1.94	0.50
1:C:401:LYS:HG3	2:D:344:TRP:CE3	2.47	0.50
3:E:7:GLU:HG2	3:E:9:ILE:HG22	1.93	0.49
1:A:71:GLU:HB2	1:A:98:ASP:HB3	1.94	0.49
1:A:254:GLU:HG2	1:A:258:ASN:ND2	2.27	0.49
2:D:5:VAL:HG22	2:D:133:PHE:HD2	1.77	0.49
4:F:247:LYS:HA	4:F:253:TYR:CD2	2.47	0.49
2:B:215:LEU:HD13	2:B:275:SER:HB3	1.94	0.49
2:D:267:MET:HG3	2:D:301:ALA:HB3	1.95	0.49
4:F:31:ARG:HD3	4:F:31:ARG:N	2.27	0.49
2:B:197:ASP:OD1	9:B:504:MES:H32	2.13	0.49
4:F:348:GLN:NE2	4:F:352:ASP:OD1	2.46	0.49
2:D:134:GLN:HA	2:D:165:ASN:O	2.13	0.49
2:B:6:HIS:CD2	2:B:21:TRP:HE1	2.30	0.49
1:A:329:ASN:HD21	3:E:20:PHE:HE2	1.61	0.49
1:C:179:THR:HG21	2:D:246:LEU:HD13	1.93	0.48
1:C:7:ILE:HG21	1:C:153:LEU:HD21	1.95	0.48
3:E:47:LEU:O	3:E:51:GLN:HG2	2.13	0.48
1:C:254:GLU:HG2	1:C:352:LYS:HE2	1.95	0.48
2:D:164:MET:HG3	2:D:196:THR:HG22	1.95	0.48
4:F:70:LYS:HA	4:F:76:SER:HB3	1.93	0.48
1:A:83:TYR:CD1	1:A:86:LEU:HD22	2.49	0.48
4:F:45:ASN:ND2	4:F:46:ARG:HG3	2.29	0.48

*Continued on next page...*

*Continued from previous page...*

Atom-1	Atom-2	Interatomic distance (Å)	Clash overlap (Å)
2:B:33:THR:O	2:B:58:LYS:NZ	2.41	0.48
4:F:82:LYS:NZ	4:F:127:GLU:OE2	2.46	0.48
1:A:265:ILE:HG23	1:A:432:TYR:CE1	2.49	0.48
2:B:39:ASP:N	2:B:39:ASP:OD1	2.47	0.48
2:B:2:ARG:HD3	2:B:3:GLU:CD	2.34	0.47
2:D:242:PHE:CE1	2:D:356:ILE:HD12	2.49	0.47
4:F:100:ILE:HG22	4:F:173:ILE:HG21	1.96	0.47
1:C:204:VAL:HG13	1:C:302[B]:MET:HE3	1.94	0.47
2:D:26:ASP:OD2	2:D:359:ARG:HD3	2.15	0.47
4:F:255[B]:ARG:HD2	4:F:256:TYR:CD1	2.50	0.47
1:A:248:LEU:HD21	1:A:316[B]:CYS:SG	2.55	0.47
2:B:262:ARG:HH12	2:B:414:ASN:HD21	1.61	0.47
1:C:83:TYR:HD2	1:C:86:LEU:HD22	1.79	0.47
2:D:169:VAL:HA	2:D:202:ILE:O	2.15	0.47
2:B:392:LYS:HE3	2:B:405:GLU:OE2	2.15	0.47
1:C:172:TYR:HB3	1:C:205:ASP:HA	1.97	0.47
2:D:56:GLY:HA3	2:D:58:LYS:HZ2	1.79	0.47
2:B:44:LEU:HA	2:B:47:ILE:HB	1.96	0.47
3:E:58:GLU:HG2	3:E:62:LYS:HD2	1.95	0.47
4:F:219:GLY:HA3	4:F:264:PHE:CZ	2.50	0.47
2:B:67:ASP:O	2:B:92:PHE:HA	2.15	0.47
2:B:104:GLY:O	2:B:109:GLY:HA3	2.15	0.47
1:C:42:ILE:HD12	1:C:42:ILE:N	2.30	0.47
1:A:209:ILE:HG22	1:A:227:LEU:HD22	1.96	0.46
2:D:234:SER:O	2:D:238:THR:HG23	2.15	0.46
1:A:280:LYS:HD3	1:A:283:HIS:HB2	1.97	0.46
1:C:167:LEU:HG	1:C:200:CYS:HB3	1.97	0.46
2:D:394:PHE:O	2:D:397:TRP:HB2	2.16	0.46
4:F:320[B]:MET:HB2	4:F:320[B]:MET:HE2	1.64	0.46
1:A:123:ARG:HG3	1:A:123:ARG:HH11	1.81	0.46
4:F:330:ILE:HD13	4:F:330:ILE:HA	1.78	0.46
2:D:68:LEU:HD23	2:D:112:LEU:HD22	1.97	0.46
1:A:263:PRO:O	1:A:266:HIS:HD2	1.99	0.46
2:B:320:ARG:HB3	2:B:320:ARG:NH1	2.31	0.46
1:A:60:LYS:HD3	1:A:62:VAL:CG2	2.44	0.46
2:B:86[A]:ARG:HH11	2:B:88:ASP:HB2	1.80	0.46
12:F:401:ACP:H8	12:F:401:ACP:H5'2	1.96	0.46
2:D:107:THR:OG1	2:D:108:GLU:N	2.48	0.45
2:D:245:GLN:H	2:D:245:GLN:HG3	1.46	0.45
2:D:404:ASP:OD1	2:D:405:GLU:N	2.48	0.45
4:F:146:VAL:HB	4:F:187:GLU:OE2	2.16	0.45

*Continued on next page...*

*Continued from previous page...*

Atom-1	Atom-2	Interatomic distance (Å)	Clash overlap (Å)
2:D:131:GLN:HB3	2:D:250:LEU:HD12	1.97	0.45
9:B:504:MES:H31	9:B:504:MES:H81	1.79	0.45
1:C:209:ILE:HD11	1:C:302[A]:MET:HG3	1.97	0.45
1:C:215:ARG:CZ	1:C:299:ALA:HB1	2.47	0.45
2:D:107:THR:O	2:D:111:GLU:HG2	2.17	0.45
1:C:286:LEU:H	1:C:286:LEU:HD12	1.81	0.45
2:D:151:LEU:O	2:D:155:ILE:HG13	2.17	0.45
1:A:123:ARG:HG3	1:A:123:ARG:NH1	2.32	0.45
4:F:44:ARG:HE	4:F:44:ARG:HB3	1.57	0.45
4:F:132:LEU:HA	4:F:135:TYR:HB3	1.98	0.45
1:A:192:HIS:CG	1:A:421:ALA:HA	2.52	0.45
2:B:289:LEU:HD23	2:B:289:LEU:HA	1.69	0.45
1:C:320:ARG:HA	1:C:356:ASN:O	2.17	0.45
2:D:67:ASP:OD1	2:D:68:LEU:N	2.49	0.44
1:A:430:LYS:HD2	1:A:430:LYS:HA	1.51	0.44
1:C:147:SER:HB2	1:C:190:THR:HB	1.98	0.44
4:F:286:GLN:O	4:F:290:ILE:HG13	2.17	0.44
2:B:21:TRP:CE3	2:B:61:PRO:HB3	2.52	0.44
2:D:289:LEU:HD12	2:D:289:LEU:HA	1.85	0.44
2:D:156:ARG:HG2	13:D:701:HOH:O	2.18	0.44
2:B:134:GLN:HA	2:B:165:ASN:O	2.18	0.44
2:D:293:MET:HE1	2:D:365:ALA:HB1	2.00	0.44
1:C:210:TYR:CE1	1:C:222:PRO:HD2	2.53	0.44
2:D:85:PHE:O	2:D:87:PRO:HD3	2.18	0.44
2:D:165:ASN:ND2	2:D:250:LEU:HD22	2.33	0.44
2:B:332:ASN:HD21	2:B:336:LYS:HE3	1.82	0.43
2:D:407:GLU:OE1	3:E:129:HIS:NE2	2.50	0.43
2:B:406:MET:HE3	2:B:410:GLU:HG3	2.00	0.43
2:D:209:ASP:OD1	2:D:209:ASP:N	2.50	0.43
1:A:434:GLU:OE1	1:A:434:GLU:HA	2.17	0.43
4:F:14:TYR:HA	4:F:17:VAL:HB	2.00	0.43
2:B:197:ASP:OD2	9:B:504:MES:H71	2.19	0.43
2:B:248:ALA:HA	11:B:508:7PL:N09	2.33	0.43
1:A:18:ASN:OD1	1:A:78:VAL:HG22	2.19	0.43
1:C:63:PRO:HG2	1:C:87:PHE:CE1	2.54	0.43
2:D:165:ASN:CG	2:D:198:GLU:HG3	2.39	0.43
2:D:220:PRO:HD3	13:D:704:HOH:O	2.19	0.43
2:D:65:LEU:HD12	2:D:65:LEU:H	1.83	0.43
2:D:383:GLU:O	2:D:386:THR:HG22	2.18	0.43
1:A:142:GLY:CA	1:A:183:GLU:HG2	2.44	0.43
2:B:64:ILE:HD13	2:B:120:VAL:HG22	2.00	0.43

*Continued on next page...*

*Continued from previous page...*

Atom-1	Atom-2	Interatomic distance (Å)	Clash overlap (Å)
2:D:5:VAL:HG12	2:D:62:ARG:CD	2.49	0.43
2:D:7:ILE:O	2:D:135:LEU:HD12	2.18	0.43
4:F:184:LYS:HD3	4:F:185:TYR:N	2.33	0.43
2:B:392:LYS:HE3	2:B:405:GLU:CD	2.40	0.42
1:C:359:PRO:HB2	13:C:609:HOH:O	2.18	0.42
2:D:33:THR:HG22	2:D:33:THR:O	2.19	0.42
4:F:77:LEU:HD12	4:F:77:LEU:HA	1.84	0.42
4:F:161:LEU:HD22	4:F:168:GLU:OE2	2.18	0.42
1:A:69:ASP:O	1:A:94:THR:HA	2.19	0.42
2:B:2:ARG:HD3	2:B:3:GLU:OE2	2.19	0.42
2:D:77:ARG:HG3	2:D:90:PHE:CZ	2.55	0.42
2:B:159:TYR:HB3	2:B:162[B]:ARG:HG2	2.00	0.42
2:D:163:ILE:HD13	2:D:163:ILE:HA	1.86	0.42
2:B:68:LEU:HD23	2:B:68:LEU:HA	1.92	0.42
4:F:305:LYS:HD3	4:F:306:HIS:NE2	2.35	0.42
1:A:120[B]:ASP:OD1	1:A:124:LYS:NZ	2.50	0.42
2:B:170:MET:CG	2:B:377:LEU:HD21	2.39	0.42
1:C:192:HIS:CG	1:C:421:ALA:HA	2.54	0.42
1:A:7:ILE:HG12	1:A:66:VAL:CG1	2.49	0.42
1:A:68:VAL:HG11	1:A:149:PHE:CE2	2.54	0.42
1:A:83:TYR:HD1	1:A:86:LEU:HD22	1.83	0.42
2:D:293:MET:HE3	2:D:293:MET:HB2	1.84	0.42
2:D:386:THR:OG1	2:D:390:ARG:NE	2.53	0.42
1:C:210:TYR:CZ	1:C:222:PRO:HD2	2.55	0.42
2:D:46:ARG:HA	2:D:46:ARG:HD2	1.78	0.42
4:F:71:LEU:HD23	4:F:332:VAL:HG11	2.02	0.42
1:A:119:LEU:HD11	1:A:156:ARG:HB3	2.01	0.42
1:A:146:GLY:O	1:A:150:THR:HB	2.19	0.42
1:C:93:ILE:HD11	1:C:121:ARG:HG3	2.02	0.42
2:D:333:VAL:O	2:D:337:ASN:HB2	2.19	0.42
4:F:31:ARG:H	4:F:31:ARG:CD	2.32	0.42
1:A:390[B]:ARG:HD2	4:F:54:HIS:CD2	2.54	0.41
2:D:116:VAL:O	2:D:120:VAL:HG23	2.20	0.41
2:D:399:THR:HG22	2:D:403:MET:O	2.19	0.41
4:F:198:LYS:HB3	4:F:241:THR:CG2	2.50	0.41
1:A:428:LEU:HA	1:A:428:LEU:HD12	1.73	0.41
2:B:36:TYR:O	2:B:37:HIS:CD2	2.73	0.41
2:B:332:ASN:ND2	2:B:336:LYS:HE3	2.34	0.41
2:D:68:LEU:HD23	2:D:68:LEU:HA	1.89	0.41
4:F:137:ARG:HA	4:F:140:GLU:OE1	2.20	0.41
2:B:397:TRP:CZ3	10:B:507:PEG:H32	2.56	0.41

*Continued on next page...*

Continued from previous page...

Atom-1	Atom-2	Interatomic distance (Å)	Clash overlap (Å)
1:C:351:PHE:N	1:C:351:PHE:CD1	2.88	0.41
1:A:188:ILE:HD12	1:A:425:MET:HG3	2.02	0.41
2:D:36:TYR:CZ	2:D:38:GLY:HA3	2.55	0.41
2:D:174:LYS:HD3	2:D:208:TYR:HD2	1.85	0.41
4:F:243:HIS:O	4:F:243:HIS:ND1	2.54	0.41
2:D:34:GLY:O	2:D:58:LYS:HA	2.21	0.41
2:D:61:PRO:HD3	2:D:84:ILE:HG12	2.03	0.41
2:D:177:ASP:OD1	2:D:177:ASP:N	2.35	0.41
2:D:245:GLN:HE21	2:D:245:GLN:HB2	1.73	0.41
2:D:31:ASP:C	2:D:31:ASP:OD1	2.60	0.40
4:F:87:LEU:O	4:F:88:SER:OG	2.32	0.40
2:B:114:ASP:HA	2:B:117:LEU:HD12	2.04	0.40
1:A:26:LEU:HD23	1:A:26:LEU:HA	1.87	0.40
1:A:110:ILE:O	1:A:113:GLU:HG3	2.22	0.40
1:C:181:VAL:H	2:D:256:ASN:ND2	2.19	0.40
2:D:65:LEU:HD12	2:D:65:LEU:N	2.37	0.40
2:D:130:LEU:HB3	2:D:162:ARG:HH11	1.85	0.40
1:A:385:ALA:HB2	1:A:432:TYR:CG	2.56	0.40
2:D:192:LEU:HD23	2:D:192:LEU:HA	1.90	0.40
2:D:345:ILE:HG22	2:D:348:ASN:HB3	2.03	0.40
4:F:197:ARG:HD2	4:F:224:SER:O	2.20	0.40
1:A:1:MET:HB3	1:A:46:ASP:HB2	2.03	0.40
1:A:98:ASP:OD1	1:A:98:ASP:C	2.60	0.40

There are no symmetry-related clashes.

## 5.3 Torsion angles [\(i\)](#)

### 5.3.1 Protein backbone [\(i\)](#)

In the following table, the Percentiles column shows the percent Ramachandran outliers of the chain as a percentile score with respect to all X-ray entries followed by that with respect to entries of similar resolution.

The Analysed column shows the number of residues for which the backbone conformation was analysed, and the total number of residues.

Mol	Chain	Analysed	Favoured	Allowed	Outliers	Percentiles
1	A	443/450 (98%)	426 (96%)	17 (4%)	0	100 100
1	C	445/450 (99%)	430 (97%)	15 (3%)	0	100 100

Continued on next page...

Continued from previous page...

Mol	Chain	Analysed	Favoured	Allowed	Outliers	Percentiles	
2	B	425/445 (96%)	409 (96%)	16 (4%)	0	100	100
2	D	418/445 (94%)	399 (96%)	19 (4%)	0	100	100
3	E	122/143 (85%)	120 (98%)	2 (2%)	0	100	100
4	F	347/384 (90%)	326 (94%)	21 (6%)	0	100	100
All	All	2200/2317 (95%)	2110 (96%)	90 (4%)	0	100	100

There are no Ramachandran outliers to report.

### 5.3.2 Protein sidechains [i](#)

In the following table, the Percentiles column shows the percent sidechain outliers of the chain as a percentile score with respect to all X-ray entries followed by that with respect to entries of similar resolution.

The Analysed column shows the number of residues for which the sidechain conformation was analysed, and the total number of residues.

Mol	Chain	Analysed	Rotameric	Outliers	Percentiles	
1	A	376/378 (100%)	367 (98%)	9 (2%)	49	74
1	C	378/378 (100%)	370 (98%)	8 (2%)	53	78
2	B	372/383 (97%)	360 (97%)	12 (3%)	39	65
2	D	364/383 (95%)	349 (96%)	15 (4%)	30	55
3	E	113/127 (89%)	109 (96%)	4 (4%)	36	62
4	F	321/342 (94%)	309 (96%)	12 (4%)	34	60
All	All	1924/1991 (97%)	1864 (97%)	60 (3%)	41	67

All (60) residues with a non-rotameric sidechain are listed below:

Mol	Chain	Res	Type
1	A	48	SER
1	A	85	GLN
1	A	120[A]	ASP
1	A	120[B]	ASP
1	A	177	VAL
1	A	178	SER
1	A	221	ARG
1	A	250	VAL
1	A	262	TYR

Continued on next page...

*Continued from previous page...*

<b>Mol</b>	<b>Chain</b>	<b>Res</b>	<b>Type</b>
2	B	19	LYS
2	B	42	LEU
2	B	44	LEU
2	B	122	LYS
2	B	126	SER
2	B	137	HIS
2	B	170	MET
2	B	188	SER
2	B	219	THR
2	B	276	ARG
2	B	300	MET
2	B	359	ARG
1	C	40	LYS
1	C	71	GLU
1	C	165	SER
1	C	251	ASP
1	C	285	GLN
1	C	286	LEU
1	C	302[A]	MET
1	C	302[B]	MET
2	D	19	LYS
2	D	39	ASP
2	D	40	SER
2	D	42	LEU
2	D	83	GLN
2	D	92	PHE
2	D	125	GLU
2	D	137	HIS
2	D	156	ARG
2	D	177	ASP
2	D	245	GLN
2	D	251	ARG
2	D	339	SER
2	D	359	ARG
2	D	406	MET
3	E	70	LYS
3	E	89	GLU
3	E	124	GLN
3	E	128	LYS
4	F	11	SER
4	F	12	SER
4	F	22	LEU

*Continued on next page...*

*Continued from previous page...*

Mol	Chain	Res	Type
4	F	31	ARG
4	F	131	PHE
4	F	138	ARG
4	F	152	SER
4	F	192	LEU
4	F	222	ARG
4	F	255[A]	ARG
4	F	255[B]	ARG
4	F	296	MET

Sometimes sidechains can be flipped to improve hydrogen bonding and reduce clashes. All (9) such sidechains are listed below:

Mol	Chain	Res	Type
1	A	329	ASN
2	B	37	HIS
2	B	190	HIS
2	B	414	ASN
1	C	61	HIS
1	C	101	ASN
1	C	356	ASN
2	D	256	ASN
4	F	45	ASN

### 5.3.3 RNA [i](#)

There are no RNA molecules in this entry.

### 5.4 Non-standard residues in protein, DNA, RNA chains [i](#)

There are no non-standard protein/DNA/RNA residues in this entry.

### 5.5 Carbohydrates [i](#)

There are no monosaccharides in this entry.

### 5.6 Ligand geometry [i](#)

Of 17 ligands modelled in this entry, 8 are monoatomic - leaving 9 for Mogul analysis.



In the following table, the Counts columns list the number of bonds (or angles) for which Mogul statistics could be retrieved, the number of bonds (or angles) that are observed in the model and the number of bonds (or angles) that are defined in the Chemical Component Dictionary. The Link column lists molecule types, if any, to which the group is linked. The Z score for a bond length (or angle) is the number of standard deviations the observed value is removed from the expected value. A bond length (or angle) with  $|Z| > 2$  is considered an outlier worth inspection. RMSZ is the root-mean-square of all Z scores of the bond lengths (or angles).

Mol	Type	Chain	Res	Link	Bond lengths			Bond angles		
					Counts	RMSZ	# Z  > 2	Counts	RMSZ	# Z  > 2
11	7PL	B	508	-	33,33,33	1.76	8 (24%)	47,47,47	1.46	6 (12%)
5	GTP	C	501	6	26,34,34	1.11	1 (3%)	32,54,54	1.34	5 (15%)
8	GDP	B	501	6	24,30,30	1.07	3 (12%)	30,47,47	1.08	2 (6%)
9	MES	B	504	-	12,12,12	1.81	3 (25%)	14,16,16	2.18	4 (28%)
5	GTP	A	501	6	26,34,34	1.11	2 (7%)	32,54,54	1.40	5 (15%)
9	MES	B	505	-	12,12,12	1.42	3 (25%)	14,16,16	1.58	3 (21%)
12	ACP	F	401	-	27,33,33	4.82	9 (33%)	32,52,52	2.76	7 (21%)
8	GDP	D	600	-	24,30,30	1.08	2 (8%)	30,47,47	1.54	6 (20%)
10	PEG	B	507	-	6,6,6	0.65	0	5,5,5	0.51	0

In the following table, the Chirals column lists the number of chiral outliers, the number of chiral centers analysed, the number of these observed in the model and the number defined in the Chemical Component Dictionary. Similar counts are reported in the Torsion and Rings columns. '-' means no outliers of that kind were identified.

Mol	Type	Chain	Res	Link	Chirals	Torsions	Rings
11	7PL	B	508	-	-	0/22/24/24	0/4/4/4
5	GTP	C	501	6	-	9/18/38/38	0/3/3/3
8	GDP	B	501	6	-	4/12/32/32	0/3/3/3
9	MES	B	504	-	-	5/6/14/14	0/1/1/1
5	GTP	A	501	6	-	4/18/38/38	0/3/3/3
9	MES	B	505	-	-	0/6/14/14	0/1/1/1
12	ACP	F	401	-	-	2/15/38/38	0/3/3/3
8	GDP	D	600	-	-	4/12/32/32	0/3/3/3
10	PEG	B	507	-	-	3/4/4/4	-

All (31) bond length outliers are listed below:

Mol	Chain	Res	Type	Atoms	Z	Observed(Å)	Ideal(Å)
12	F	401	ACP	C2'-C1'	-15.13	1.30	1.53
12	F	401	ACP	O4'-C1'	14.90	1.61	1.41

*Continued on next page...*

*Continued from previous page...*

Mol	Chain	Res	Type	Atoms	Z	Observed(Å)	Ideal(Å)
12	F	401	ACP	PB-O3A	9.13	1.68	1.58
12	F	401	ACP	O4'-C4'	-6.22	1.31	1.45
11	B	508	7PL	C26-N25	4.90	1.46	1.35
9	B	504	MES	C8-S	4.50	1.83	1.77
11	B	508	7PL	C08-N07	4.30	1.46	1.38
11	B	508	7PL	C12-N14	3.92	1.45	1.38
5	C	501	GTP	C5-C6	-3.69	1.39	1.47
12	F	401	ACP	C6-N6	3.11	1.45	1.34
12	F	401	ACP	O3'-C3'	-3.09	1.35	1.43
5	A	501	GTP	C5-C6	-2.99	1.41	1.47
9	B	504	MES	O2S-S	2.84	1.53	1.45
9	B	505	MES	C8-S	2.78	1.81	1.77
11	B	508	7PL	C15-N14	2.70	1.46	1.40
5	A	501	GTP	C2-N3	2.68	1.39	1.33
12	F	401	ACP	O2'-C2'	2.68	1.49	1.43
9	B	505	MES	O2S-S	2.65	1.52	1.45
9	B	504	MES	O1S-S	2.60	1.52	1.45
12	F	401	ACP	C5-C4	-2.54	1.34	1.40
8	D	600	GDP	C6-N1	-2.53	1.34	1.37
11	B	508	7PL	C01-N25	2.44	1.46	1.41
12	F	401	ACP	C2-N3	2.36	1.35	1.32
11	B	508	7PL	C05-N07	2.33	1.45	1.40
8	B	501	GDP	C6-N1	-2.31	1.34	1.37
11	B	508	7PL	C28-C26	2.16	1.55	1.51
9	B	505	MES	O1S-S	2.13	1.51	1.45
8	D	600	GDP	C5-C4	2.13	1.48	1.43
11	B	508	7PL	C21-C19	2.11	1.54	1.49
8	B	501	GDP	C2'-C1'	-2.03	1.50	1.53
8	B	501	GDP	C2-N3	2.01	1.38	1.33

All (38) bond angle outliers are listed below:

Mol	Chain	Res	Type	Atoms	Z	Observed(°)	Ideal(°)
12	F	401	ACP	C5-C6-N6	9.71	135.10	120.35
12	F	401	ACP	N6-C6-N1	-6.48	105.13	118.57
12	F	401	ACP	N3-C2-N1	-5.85	119.53	128.68
11	B	508	7PL	N11-C10-N09	-5.59	119.86	128.60
9	B	504	MES	O2S-S-C8	4.95	112.88	106.92
12	F	401	ACP	C3'-C2'-C1'	4.61	107.92	100.98
9	B	504	MES	C2-C3-N4	4.05	116.25	110.10
12	F	401	ACP	O3G-PG-C3B	3.65	115.25	106.40
5	A	501	GTP	C8-N7-C5	3.57	109.78	102.99

*Continued on next page...*

*Continued from previous page...*

Mol	Chain	Res	Type	Atoms	Z	Observed(°)	Ideal(°)
11	B	508	7PL	C29-C28-C26	-3.56	113.87	117.21
9	B	505	MES	O2S-S-C8	3.50	111.13	106.92
5	C	501	GTP	C8-N7-C5	3.44	109.55	102.99
8	D	600	GDP	PA-O3A-PB	-3.40	121.17	132.83
8	D	600	GDP	O2B-PB-O3A	3.35	115.88	104.64
5	A	501	GTP	PA-O3A-PB	-3.05	122.36	132.83
11	B	508	7PL	C15-N14-C12	-2.95	120.98	128.74
9	B	504	MES	C5-N4-C3	2.86	115.26	108.83
9	B	505	MES	C5-N4-C3	2.77	115.07	108.83
5	A	501	GTP	C2-N1-C6	-2.75	120.04	125.10
8	D	600	GDP	C8-N7-C5	2.67	108.07	102.99
5	A	501	GTP	C5-C6-N1	2.61	118.56	113.95
9	B	504	MES	O2S-S-O1S	-2.58	105.01	113.95
12	F	401	ACP	C5'-C4'-C3'	-2.54	105.67	115.18
8	B	501	GDP	C5-C6-N1	2.48	118.34	113.95
8	B	501	GDP	C8-N7-C5	2.45	107.66	102.99
8	D	600	GDP	O6-C6-N1	-2.44	117.76	120.65
12	F	401	ACP	O3G-PG-O1G	-2.43	105.97	112.39
9	B	505	MES	O3S-S-O2S	-2.29	105.68	111.27
5	C	501	GTP	C5-C6-N1	2.27	117.95	113.95
11	B	508	7PL	C13-C08-N09	-2.25	119.61	122.75
5	C	501	GTP	PB-O3B-PG	-2.22	125.20	132.83
8	D	600	GDP	O3B-PB-O1B	2.22	119.35	110.68
5	C	501	GTP	O4'-C1'-C2'	-2.18	103.74	106.93
5	A	501	GTP	O5'-PA-O1A	2.17	117.56	109.07
11	B	508	7PL	C30-C28-C26	2.16	119.23	117.21
5	C	501	GTP	PA-O3A-PB	-2.15	125.45	132.83
8	D	600	GDP	O2B-PB-O1B	-2.05	102.65	110.68
11	B	508	7PL	C10-N09-C08	2.00	121.89	115.25

There are no chirality outliers.

All (31) torsion outliers are listed below:

Mol	Chain	Res	Type	Atoms
5	A	501	GTP	PB-O3B-PG-O2G
5	A	501	GTP	C5'-O5'-PA-O1A
5	A	501	GTP	C5'-O5'-PA-O2A
5	C	501	GTP	C5'-O5'-PA-O1A
5	C	501	GTP	C5'-O5'-PA-O2A
8	B	501	GDP	C5'-O5'-PA-O1A
8	D	600	GDP	C5'-O5'-PA-O1A
8	D	600	GDP	C5'-O5'-PA-O2A

*Continued on next page...*

Continued from previous page...

Mol	Chain	Res	Type	Atoms
9	B	504	MES	C8-C7-N4-C3
9	B	504	MES	N4-C7-C8-S
9	B	504	MES	C7-C8-S-O2S
9	B	504	MES	C7-C8-S-O3S
10	B	507	PEG	O1-C1-C2-O2
8	B	501	GDP	C5'-O5'-PA-O3A
8	B	501	GDP	C5'-O5'-PA-O2A
9	B	504	MES	C7-C8-S-O1S
10	B	507	PEG	C1-C2-O2-C3
10	B	507	PEG	C4-C3-O2-C2
5	C	501	GTP	C4'-C5'-O5'-PA
8	D	600	GDP	C4'-C5'-O5'-PA
12	F	401	ACP	PB-O3A-PA-O1A
12	F	401	ACP	PB-O3A-PA-O2A
8	B	501	GDP	PB-O3A-PA-O2A
5	C	501	GTP	PB-O3B-PG-O1G
5	C	501	GTP	PB-O3B-PG-O2G
5	C	501	GTP	PB-O3B-PG-O3G
5	A	501	GTP	C5'-O5'-PA-O3A
5	C	501	GTP	C5'-O5'-PA-O3A
8	D	600	GDP	C5'-O5'-PA-O3A
5	C	501	GTP	PB-O3A-PA-O1A
5	C	501	GTP	PB-O3A-PA-O2A

There are no ring outliers.

4 monomers are involved in 9 short contacts:

Mol	Chain	Res	Type	Clashes	Symm-Clashes
11	B	508	7PL	1	0
9	B	504	MES	4	0
12	F	401	ACP	1	0
10	B	507	PEG	3	0

The following is a two-dimensional graphical depiction of Mogul quality analysis of bond lengths, bond angles, torsion angles, and ring geometry for all instances of the Ligand of Interest. In addition, ligands with molecular weight > 250 and outliers as shown on the validation Tables will also be included. For torsion angles, if less than 5% of the Mogul distribution of torsion angles is within 10 degrees of the torsion angle in question, then that torsion angle is considered an outlier. Any bond that is central to one or more torsion angles identified as an outlier by Mogul will be highlighted in the graph. For rings, the root-mean-square deviation (RMSD) between the ring in question and similar rings identified by Mogul is calculated over all ring torsion angles. If the average RMSD is greater than 60 degrees and the minimal RMSD between the ring in question and

any Mogul-identified rings is also greater than 60 degrees, then that ring is considered an outlier. The outliers are highlighted in purple. The color gray indicates Mogul did not find sufficient equivalents in the CSD to analyse the geometry.

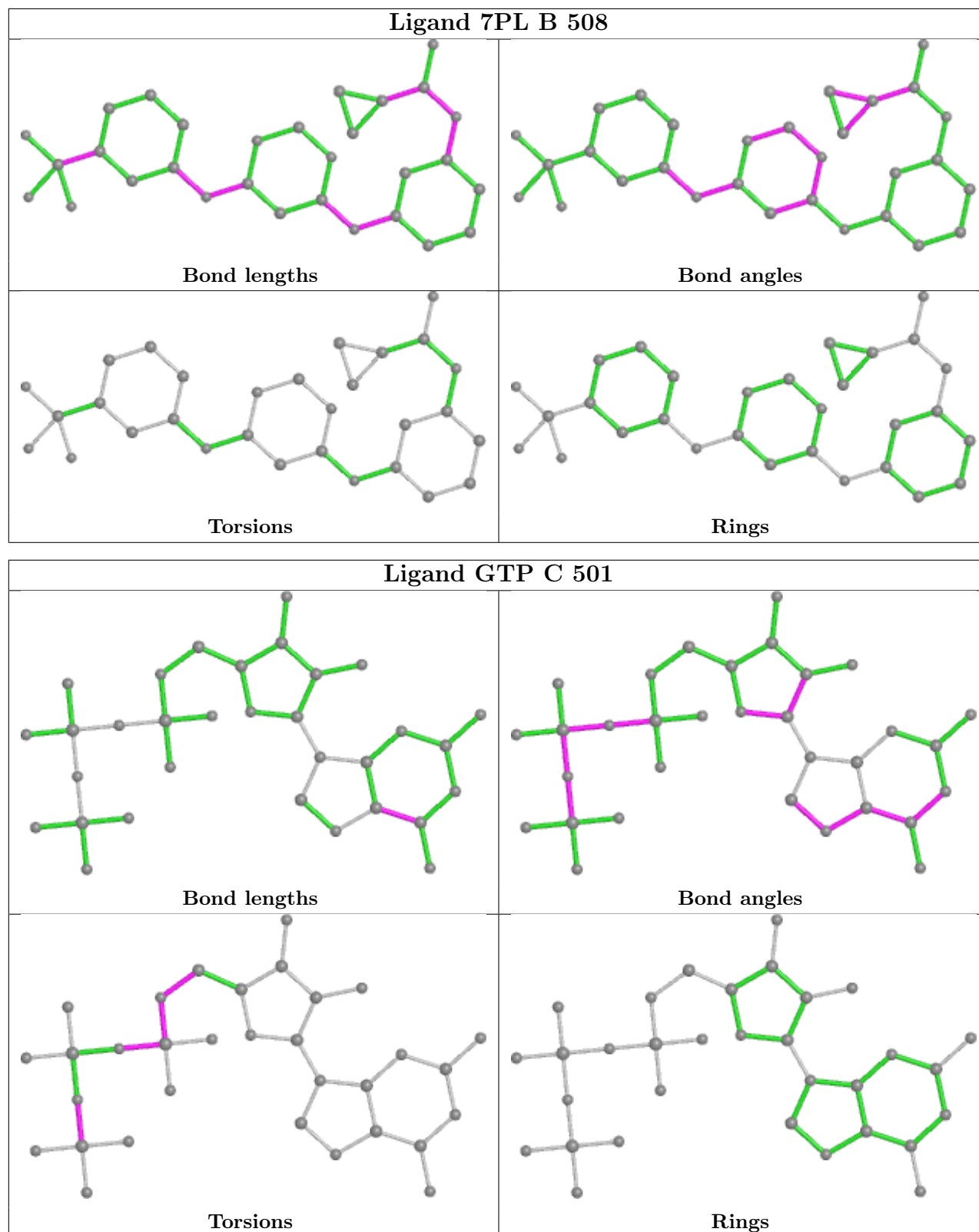

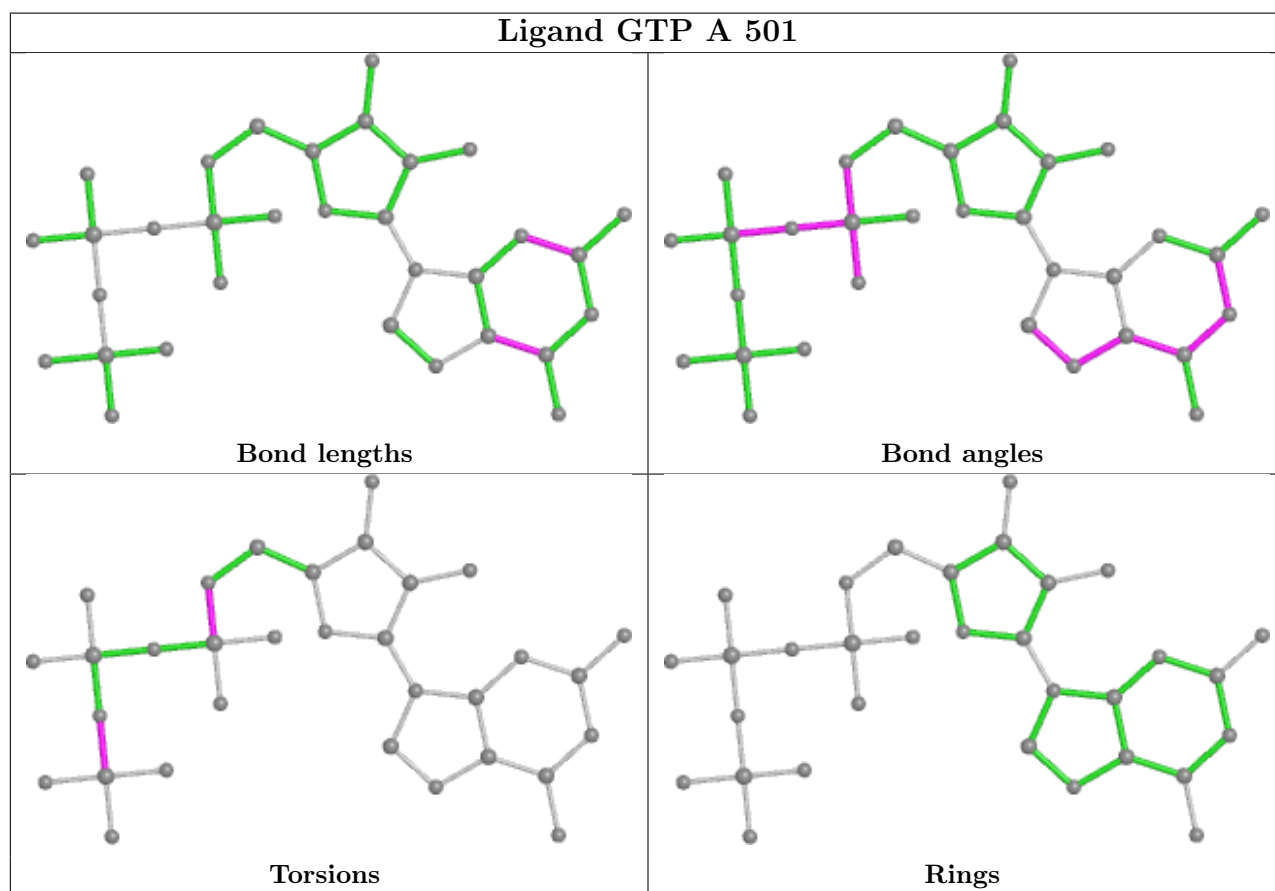
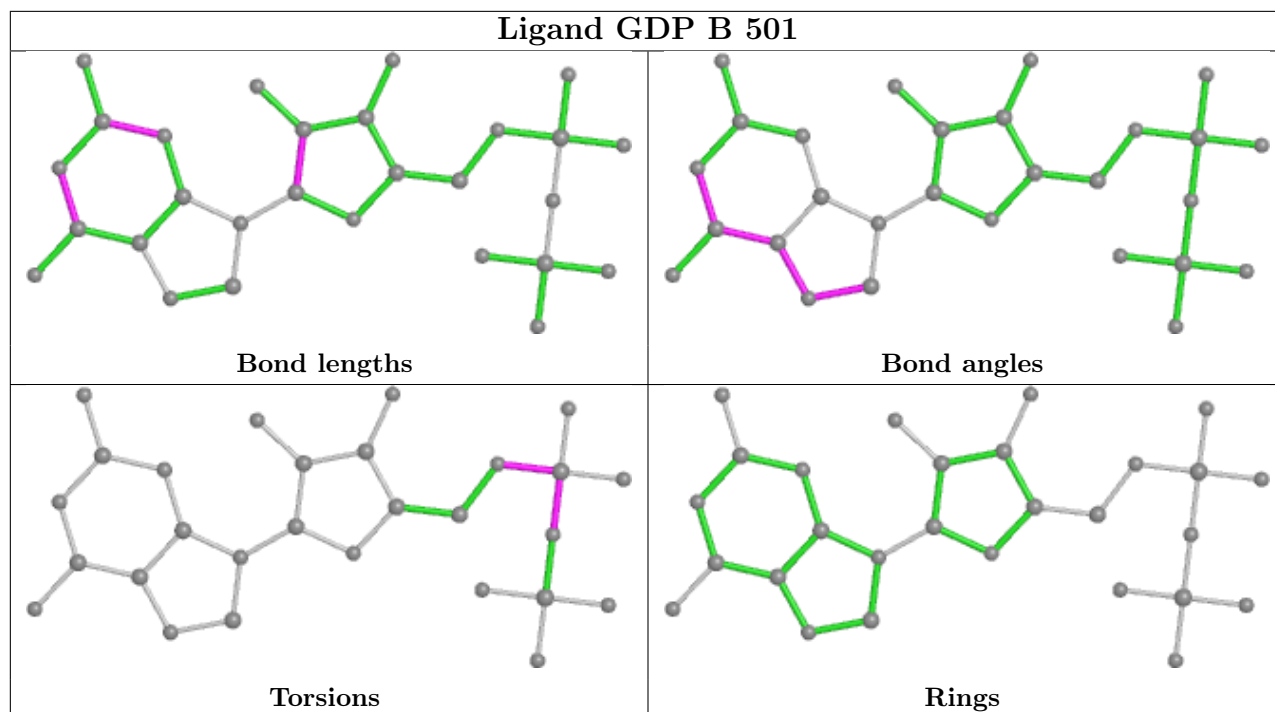

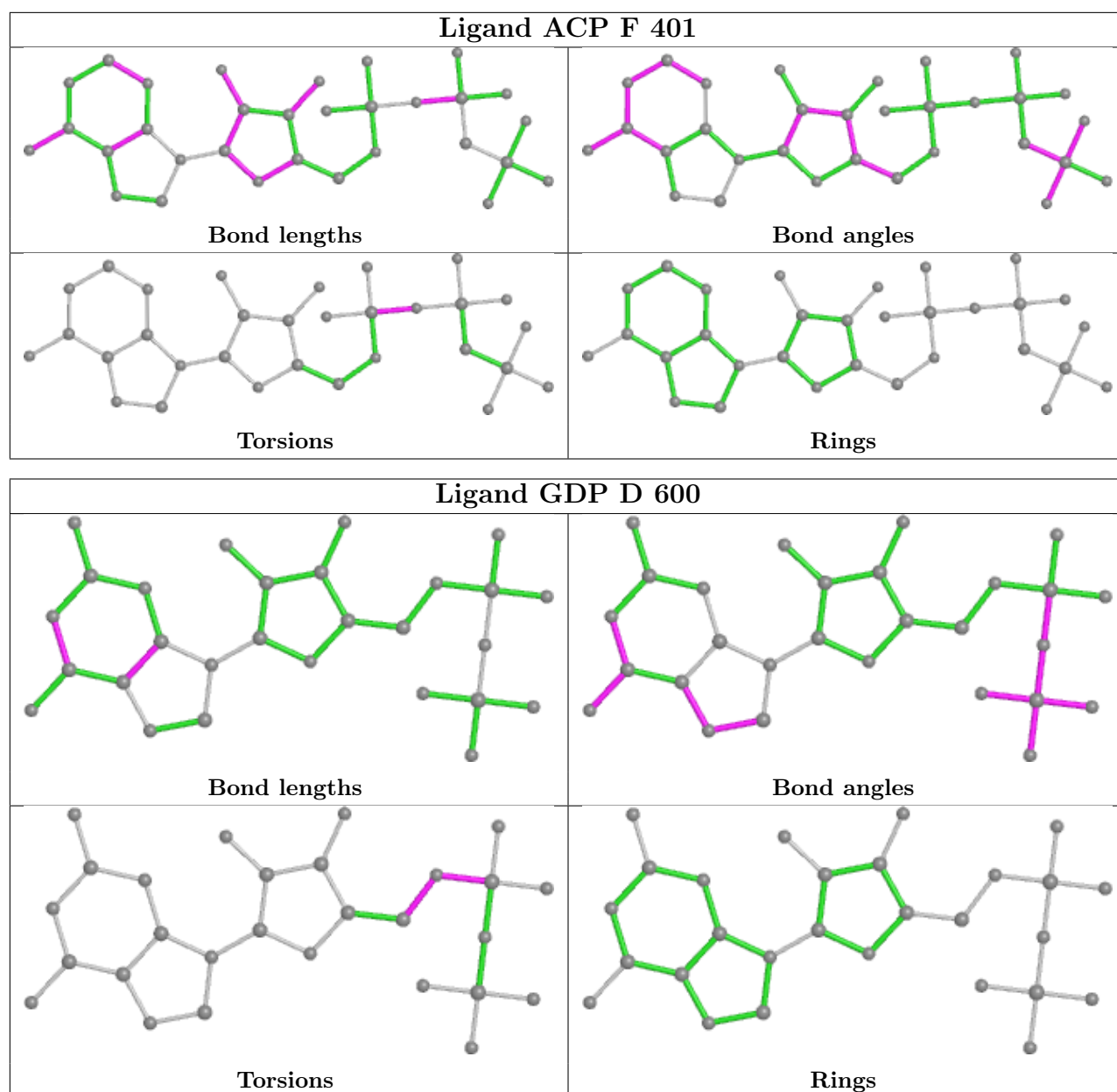

## 5.7 Other polymers [\(i\)](#)

There are no such residues in this entry.

## 5.8 Polymer linkage issues [\(i\)](#)

There are no chain breaks in this entry.

## 6 Fit of model and data [i](#)

### 6.1 Protein, DNA and RNA chains [i](#)

In the following table, the column labelled ‘#RSRZ > 2’ contains the number (and percentage) of RSRZ outliers, followed by percent RSRZ outliers for the chain as percentile scores relative to all X-ray entries and entries of similar resolution. The OWAB column contains the minimum, median, 95<sup>th</sup> percentile and maximum values of the occupancy-weighted average B-factor per residue. The column labelled ‘Q < 0.9’ lists the number of (and percentage) of residues with an average occupancy less than 0.9.

Mol	Chain	Analysed	<RSRZ>	#RSRZ>2	OWAB(Å <sup>2</sup> )	Q<0.9
1	A	439/450 (97%)	-0.01	5 (1%) 80 82	23, 37, 59, 114	0
1	C	440/450 (97%)	-0.26	2 (0%) 91 91	16, 29, 50, 73	0
2	B	425/445 (95%)	-0.05	12 (2%) 53 56	18, 36, 67, 103	1 (0%)
2	D	421/445 (94%)	0.54	42 (9%) 7 6	28, 58, 89, 119	2 (0%)
3	E	123/143 (86%)	0.43	11 (8%) 9 9	28, 51, 86, 116	0
4	F	351/384 (91%)	0.96	78 (22%) 0 0	28, 64, 128, 150	0
All	All	2199/2317 (94%)	0.22	150 (6%) 17 17	16, 43, 92, 150	3 (0%)

All (150) RSRZ outliers are listed below:

Mol	Chain	Res	Type	RSRZ
4	F	105	LEU	10.0
2	D	283	ALA	7.7
4	F	233	PHE	7.6
2	D	55	THR	7.3
4	F	250	SER	6.9
2	B	275	SER	6.8
4	F	130	VAL	6.8
4	F	252	ASN	6.1
4	F	103	THR	5.7
4	F	106	LYS	5.7
2	D	57	ASN	5.7
4	F	253	TYR	5.6
2	D	216	LYS	5.5
4	F	232	ASN	5.4
4	F	249	TYR	5.3
4	F	142	ARG	5.0
4	F	251	LYS	5.0
4	F	177	GLY	4.9
4	F	234	GLN	4.9

*Continued on next page...*



*Continued from previous page...*

<b>Mol</b>	<b>Chain</b>	<b>Res</b>	<b>Type</b>	<b>RSRZ</b>
4	F	225	SER	4.9
4	F	246	GLN	4.9
2	B	57	ASN	4.8
2	D	245	GLN	4.8
1	A	439	SER	4.8
4	F	256	TYR	4.7
4	F	244	CYS	4.7
4	F	169	LEU	4.6
2	D	284	LEU	4.6
3	E	143	ALA	4.6
2	D	56	GLY	4.5
4	F	104	ASN	4.5
4	F	152	SER	4.5
4	F	125	THR	4.5
1	C	340	SER	4.4
4	F	173	ILE	4.4
2	D	81	PHE	4.3
4	F	101	TYR	4.3
2	D	219	THR	4.2
2	D	37	HIS	4.1
4	F	134	ALA	4.0
4	F	176	GLN	4.0
4	F	239	HIS	4.0
4	F	167	SER	4.0
4	F	245	ILE	3.9
4	F	129	GLU	3.9
4	F	255[A]	ARG	3.8
2	D	92	PHE	3.8
4	F	178	GLN	3.8
2	D	84	ILE	3.8
4	F	243	HIS	3.7
4	F	164	SER	3.7
2	B	276	ARG	3.6
2	D	36	TYR	3.6
2	D	33	THR	3.5
4	F	133	ALA	3.5
3	E	140	LYS	3.5
2	B	54	ALA	3.5
2	B	1	MET	3.5
2	B	282	ARG	3.5
4	F	159	GLY	3.5
2	B	55	THR	3.5

*Continued on next page...*

*Continued from previous page...*

<b>Mol</b>	<b>Chain</b>	<b>Res</b>	<b>Type</b>	<b>RSRZ</b>
2	B	56	GLY	3.5
2	D	83	GLN	3.5
1	A	262	TYR	3.5
4	F	10	ASN	3.4
4	F	139	ARG	3.4
4	F	161	LEU	3.3
4	F	231	ALA	3.3
2	D	53	GLU	3.3
4	F	166	ALA	3.3
2	D	41	ASP	3.2
4	F	174	ASP	3.2
4	F	235	ASP	3.2
4	F	259	GLY	3.2
4	F	20	LEU	3.2
4	F	138	ARG	3.2
2	D	73	MET	3.2
2	D	54	ALA	3.1
4	F	238	CYS	3.1
4	F	126	ASP	3.1
3	E	28	SER	3.1
4	F	136	ASN	3.0
4	F	362	ALA	3.0
3	E	141	GLU	3.0
3	E	7	GLU	3.0
1	A	438	ASP	2.9
4	F	236	LYS	2.9
2	D	71	GLY	2.9
2	D	217	LEU	2.9
2	D	39	ASP	2.9
2	D	80	PRO	2.9
2	D	391	ARG	2.9
4	F	196	HIS	2.9
4	F	226	GLU	2.8
2	D	34	GLY	2.8
2	D	74	ASP	2.8
4	F	241	THR	2.8
4	F	361	LEU	2.7
4	F	127	GLU	2.7
4	F	140	GLU	2.7
4	F	145	ASN	2.7
1	C	440	VAL	2.7
3	E	142	GLU	2.7

*Continued on next page...*

*Continued from previous page...*

<b>Mol</b>	<b>Chain</b>	<b>Res</b>	<b>Type</b>	<b>RSRZ</b>
4	F	228	TYR	2.6
4	F	182	ILE	2.6
2	D	177	ASP	2.6
2	B	37	HIS	2.6
2	D	94	GLN	2.6
4	F	242	ASN	2.6
4	F	171	ASP	2.6
2	D	390	ARG	2.6
1	A	42	ILE	2.5
2	D	31	ASP	2.5
2	D	95	SER	2.5
2	D	70	PRO	2.5
4	F	137	ARG	2.4
2	D	396	HIS	2.4
4	F	100	ILE	2.4
3	E	138	GLU	2.4
4	F	143	GLU	2.4
2	B	427	ASP	2.4
4	F	151	SER	2.4
4	F	194	PRO	2.3
4	F	9	GLU	2.3
4	F	162	ILE	2.3
2	D	59	TYR	2.3
2	D	405	GLU	2.3
3	E	6	MET	2.2
2	D	72	THR	2.2
4	F	19	ARG	2.2
2	B	274	THR	2.2
4	F	141	GLY	2.2
2	D	77	ARG	2.2
4	F	135	TYR	2.1
3	E	135	LYS	2.1
2	D	35	SER	2.1
4	F	90	SER	2.1
3	E	48	GLU	2.1
2	D	393	ALA	2.1
4	F	31	ARG	2.1
2	B	281	TYR	2.1
4	F	199	PHE	2.1
2	D	58	LYS	2.1
4	F	17	VAL	2.0
4	F	170	LEU	2.0

*Continued on next page...*

*Continued from previous page...*

Mol	Chain	Res	Type	RSRZ
1	A	346	TRP	2.0
2	D	125	GLU	2.0
3	E	25	LYS	2.0
2	D	406	MET	2.0
4	F	247	LYS	2.0

## 6.2 Non-standard residues in protein, DNA, RNA chains [i](#)

There are no non-standard protein/DNA/RNA residues in this entry.

## 6.3 Carbohydrates [i](#)

There are no monosaccharides in this entry.

## 6.4 Ligands [i](#)

In the following table, the Atoms column lists the number of modelled atoms in the group and the number defined in the chemical component dictionary. The B-factors column lists the minimum, median, 95<sup>th</sup> percentile and maximum values of B factors of atoms in the group. The column labelled 'Q< 0.9' lists the number of atoms with occupancy less than 0.9.

Mol	Type	Chain	Res	Atoms	RSCC	RSR	B-factors(Å <sup>2</sup> )	Q<0.9
10	PEG	B	507	7/7	0.73	0.38	34,48,55,56	0
7	CA	C	503	1/1	0.81	0.13	43,43,43,43	0
12	ACP	F	401	31/31	0.85	0.20	75,85,103,111	0
6	MG	B	506	1/1	0.89	0.32	66,66,66,66	0
7	CA	B	503	1/1	0.90	0.23	91,91,91,91	0
7	CA	A	504	1/1	0.91	0.28	110,110,110,110	0
6	MG	C	502	1/1	0.93	0.41	33,33,33,33	0
8	GDP	D	600	28/28	0.93	0.16	53,58,68,73	0
7	CA	A	503	1/1	0.95	0.06	54,54,54,54	0
9	MES	B	505	12/12	0.95	0.20	50,52,60,67	0
9	MES	B	504	12/12	0.97	0.12	29,35,54,57	0
6	MG	A	502	1/1	0.98	0.14	30,30,30,30	0
6	MG	B	502	1/1	0.98	0.12	27,27,27,27	0
5	GTP	A	501	32/32	0.98	0.18	21,28,33,45	0
5	GTP	C	501	32/32	0.98	0.14	18,25,30,33	0
11	7PL	B	508	30/30	0.98	0.16	25,35,41,45	0
8	GDP	B	501	28/28	0.98	0.15	20,26,33,35	0

The following is a graphical depiction of the model fit to experimental electron density of all instances of the Ligand of Interest. In addition, ligands with molecular weight > 250 and outliers as shown on the geometry validation Tables will also be included. Each fit is shown from different orientation to approximate a three-dimensional view.

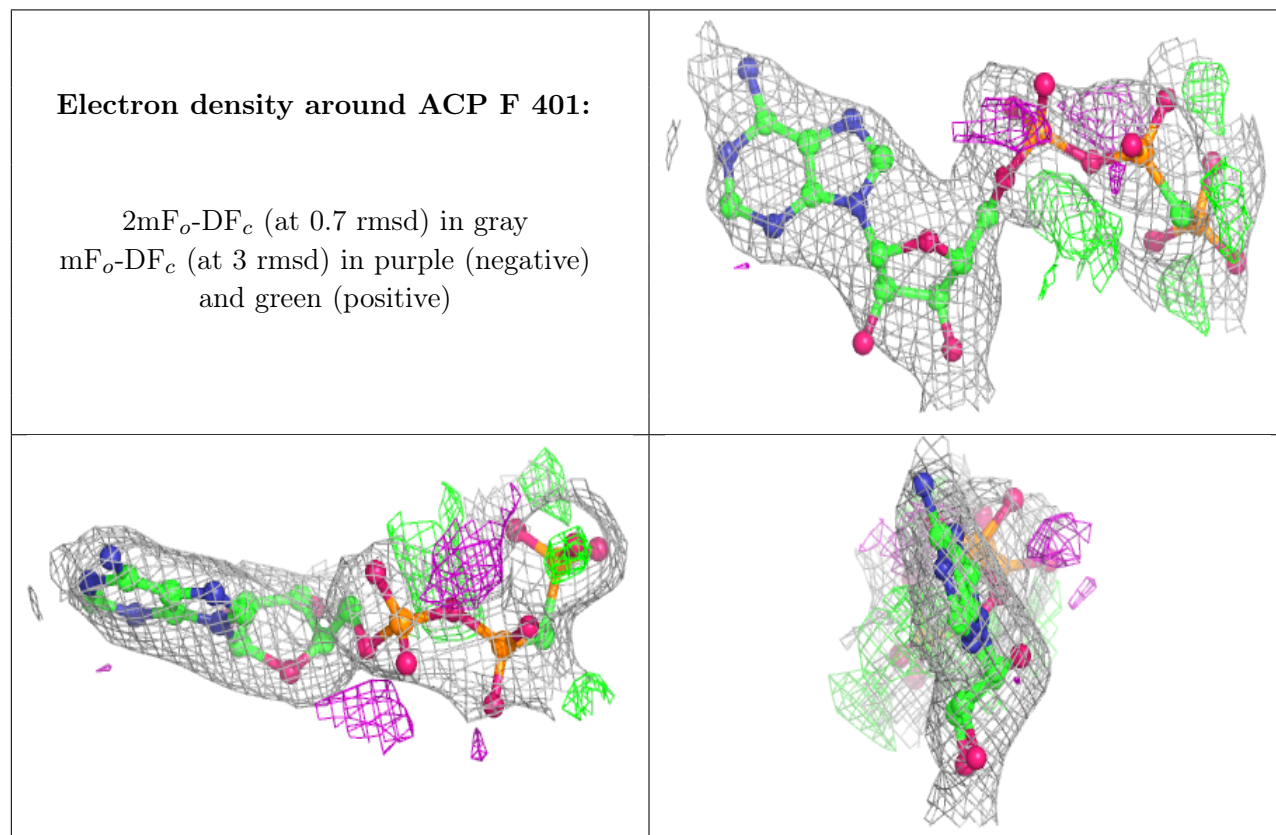

**Electron density around GDP D 600:**

$2mF_o-DF_c$  (at 0.7 rmsd) in gray  
 $mF_o-DF_c$  (at 3 rmsd) in purple (negative)  
and green (positive)

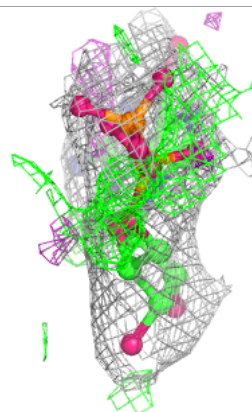
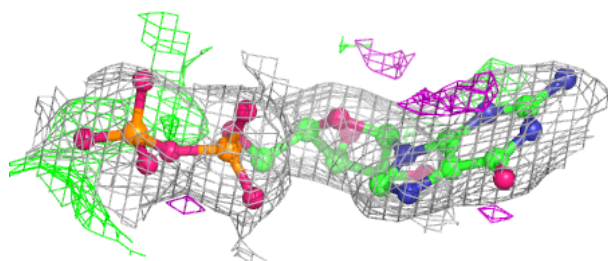
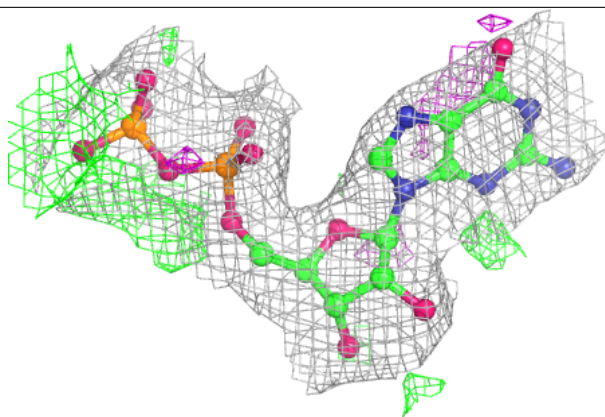
**Electron density around GTP A 501:**

$2mF_o-DF_c$  (at 0.7 rmsd) in gray  
 $mF_o-DF_c$  (at 3 rmsd) in purple (negative)  
and green (positive)

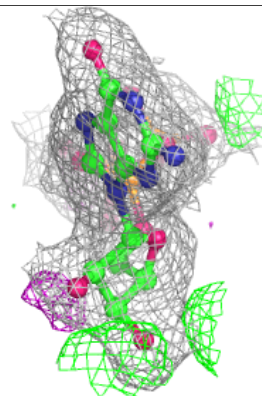
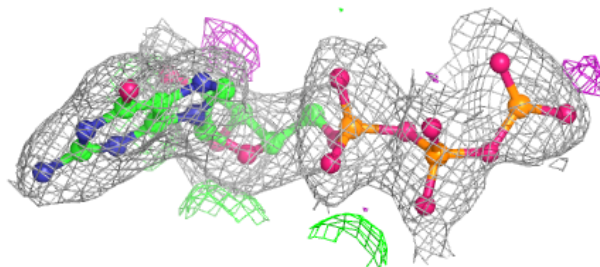
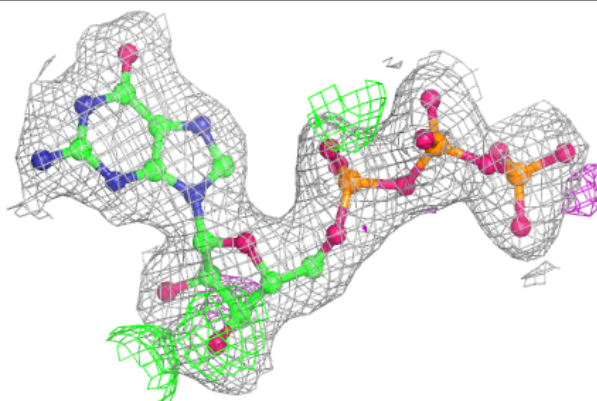



**Electron density around GTP C 501:**

$2mF_o-DF_c$  (at 0.7 rmsd) in gray  
 $mF_o-DF_c$  (at 3 rmsd) in purple (negative)  
and green (positive)

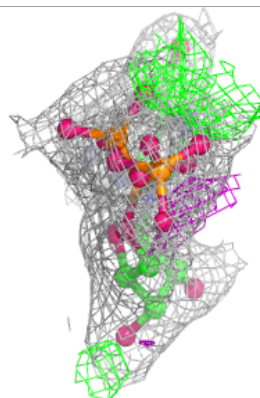
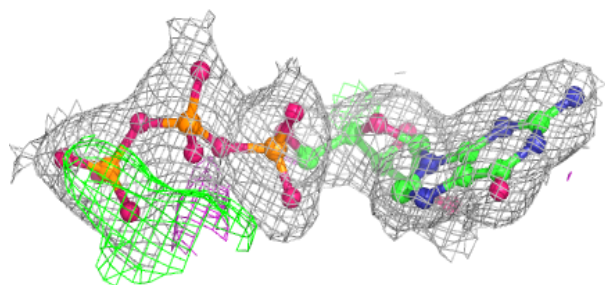
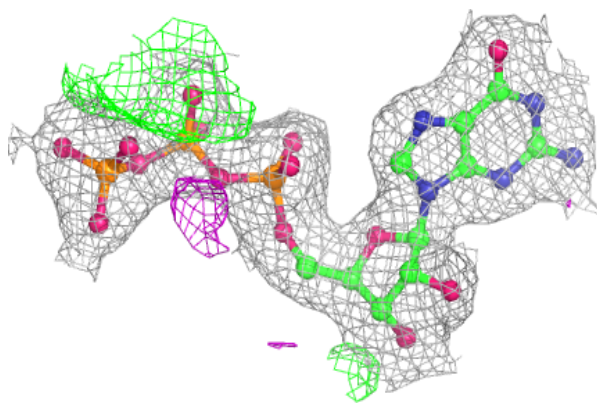
**Electron density around 7PL B 508:**

$2mF_o-DF_c$  (at 0.7 rmsd) in gray  
 $mF_o-DF_c$  (at 3 rmsd) in purple (negative)  
and green (positive)

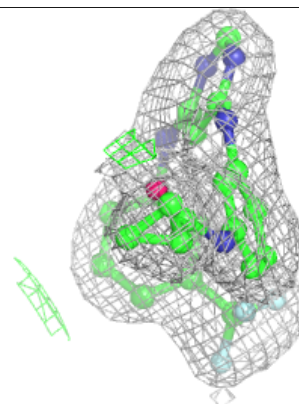
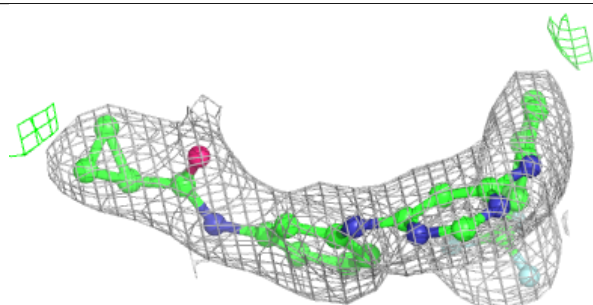
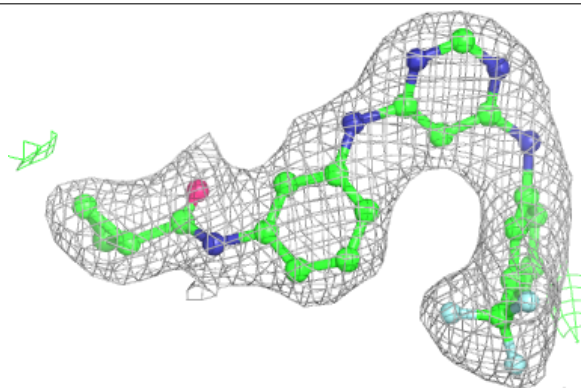

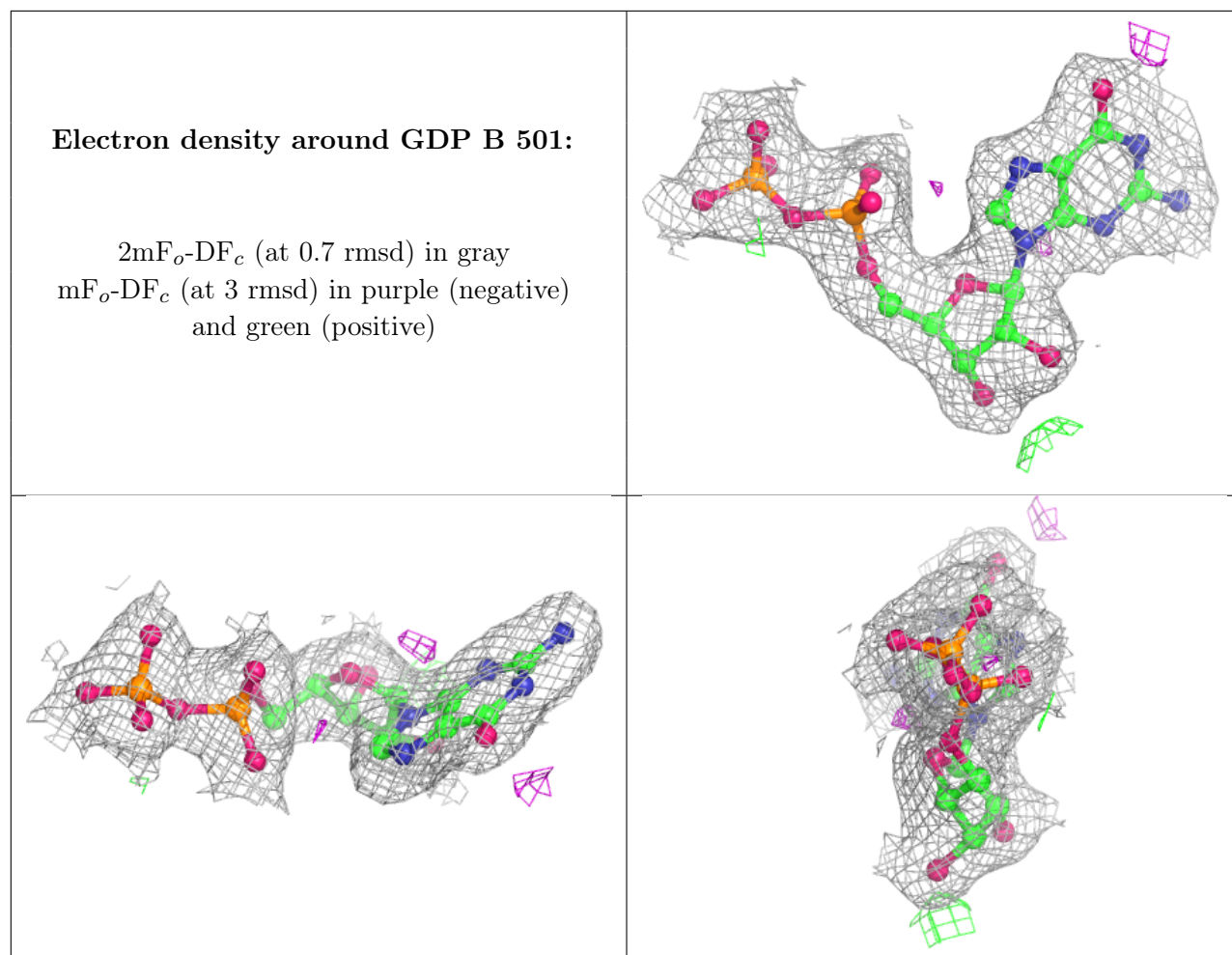

## 6.5 Other polymers [i](#)

There are no such residues in this entry.