



## Full wwPDB EM Validation Report ⓘ

Nov 29, 2022 – 08:30 AM JST

PDB ID : 7W3G  
EMDB ID : EMD-32279  
Title : Structure of USP14-bound human 26S proteasome in substrate-engaged state  
ED2.0\_USP14  
Authors : Zhang, S.; Zou, S.; Yin, D.; Wu, Z.; Mao, Y.  
Deposited on : 2021-11-25  
Resolution : 3.20 Å(reported)

This is a Full wwPDB EM Validation Report for a publicly released PDB entry.

We welcome your comments at [validation@mail.wwpdb.org](mailto:validation@mail.wwpdb.org)

A user guide is available at

<https://www.wwpdb.org/validation/2017/EMValidationReportHelp>

with specific help available everywhere you see the ⓘ symbol.

The types of validation reports are described at

<http://www.wwpdb.org/validation/2017/FAQs#types>.

---

The following versions of software and data (see [references ⓘ](#)) were used in the production of this report:

EMDB validation analysis : 0.0.1.dev43  
Mogul : 1.8.5 (274361), CSD as541be (2020)  
MolProbity : 4.02b-467  
buster-report : 1.1.7 (2018)  
Percentile statistics : 20191225.v01 (using entries in the PDB archive December 25th 2019)  
MapQ : 1.9.9  
Ideal geometry (proteins) : Engh & Huber (2001)  
Ideal geometry (DNA, RNA) : Parkinson et al. (1996)  
Validation Pipeline (wwPDB-VP) : 2.31.3

# 1 Overall quality at a glance

The following experimental techniques were used to determine the structure:  
*ELECTRON MICROSCOPY*

The reported resolution of this entry is 3.20 Å.

Percentile scores (ranging between 0-100) for global validation metrics of the entry are shown in the following graphic. The table shows the number of entries on which the scores are based.

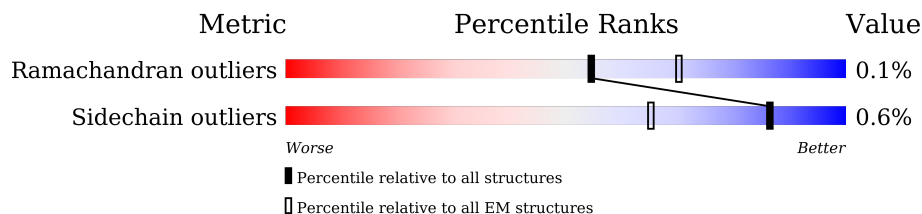











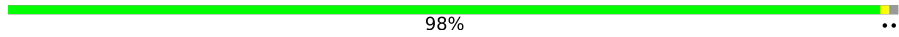
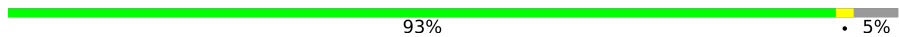
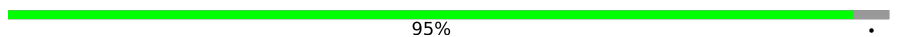
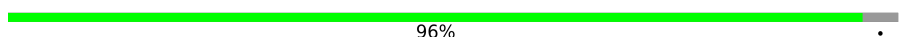
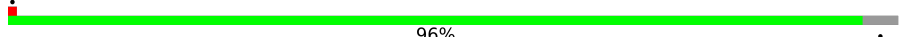
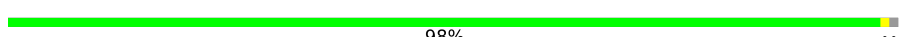

Metric	Whole archive (#Entries)	EM structures (#Entries)
Ramachandran outliers	154571	4023
Sidechain outliers	154315	3826

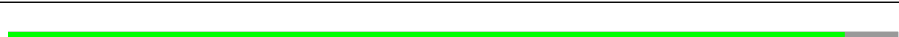
The table below summarises the geometric issues observed across the polymeric chains and their fit to the map. The red, orange, yellow and green segments of the bar indicate the fraction of residues that contain outliers for  $\geq 3$ , 2, 1 and 0 types of geometric quality criteria respectively. A grey segment represents the fraction of residues that are not modelled. The numeric value for each fraction is indicated below the corresponding segment, with a dot representing fractions  $\leq 5\%$ . The upper red bar (where present) indicates the fraction of residues that have poor fit to the EM map (all-atom inclusion  $< 40\%$ ). The numeric value is given above the bar.

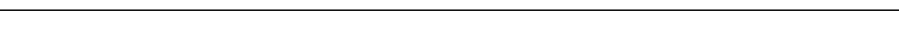
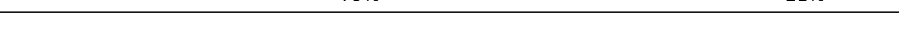
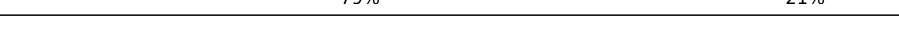
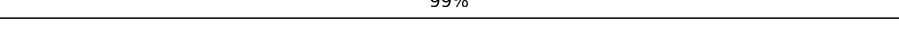
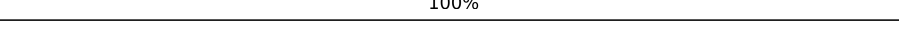
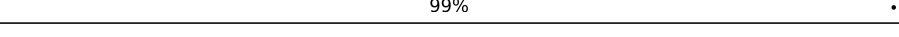
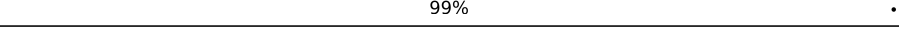
Mol	Chain	Length	Quality of chain
1	A	433	
2	B	440	
3	C	398	
4	D	418	
5	E	403	
6	F	439	
7	G	246	
7	g	246	
8	H	234	





*Continued on next page...*

Continued from previous page...

Mol	Chain	Length	Quality of chain
8	h	234	 98%
9	I	261	 93% 5%
9	i	261	 95%
10	J	248	 96%
10	j	248	 96%
11	K	241	 98%
11	k	241	 97%
12	L	269	 89% 11%
12	l	269	 88% 12%
13	M	255	 95% 5%
13	m	255	 94% 6%
14	N	239	 85% 15%
14	n	239	 85% 15%
15	O	277	 79% 21%
15	o	277	 79% 21%
16	P	205	 99%
16	p	205	 100%
17	Q	201	 99%
17	q	201	 99%
18	R	263	 76% 24%
18	r	263	 76% 24%
19	S	241	 88% 12%
19	s	241	 88% 12%
20	T	264	 82% 18%
20	t	264	 82% 18%

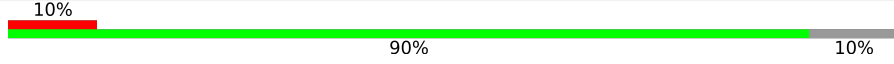
Continued on next page...

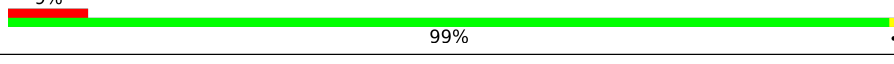
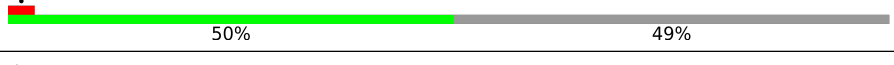
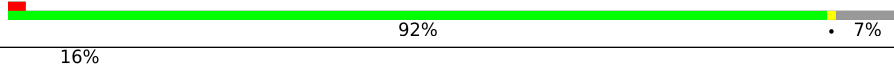
Continued from previous page...

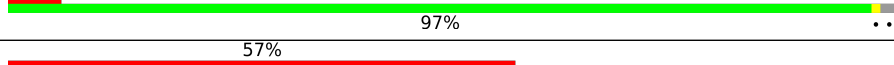
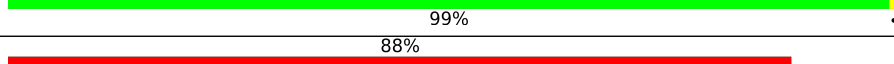
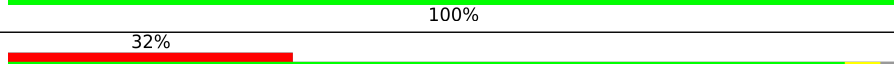
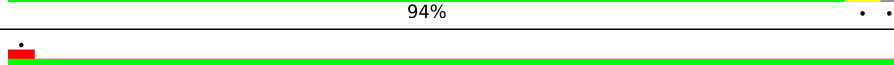
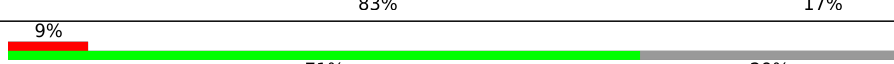
Mol	Chain	Length	Quality of chain
21	U	953	 7% 91% 8%
22	X	422	 10% 90% 10%
23	Y	389	 1% 97% 2%
24	Z	324	 1% 87% 12%
25	a	376	 9% 99% 2%
26	b	377	 1% 50% 49%
27	c	310	 1% 92% 7%
28	d	350	 16% 71% 27%
29	f	908	 6% 97% 2%
30	x	494	 57% 99% 2%
31	y	76	 88% 100%
32	W	456	 32% 94% 2%
33	v	34	 1% 100%
34	V	534	 1% 83% 17%
35	e	70	 9% 71% 29%

## 2 Entry composition [i](#)

There are 38 unique types of molecules in this entry. The entry contains 110741 atoms, of which 0 are hydrogens and 0 are deuteriums.

In the tables below, the AltConf column contains the number of residues with at least one atom in alternate conformation and the Trace column contains the number of residues modelled with at most 2 atoms.

- Molecule 1 is a protein called 26S protease regulatory subunit 7.

Mol	Chain	Residues	Atoms					AltConf	Trace
			Total	C	N	O	S		
1	A	413	3229	2034	566	611	18	0	0

- Molecule 2 is a protein called 26S protease regulatory subunit 4.

Mol	Chain	Residues	Atoms					AltConf	Trace
			Total	C	N	O	S		
2	B	411	3207	2022	548	622	15	0	0

- Molecule 3 is a protein called Isoform 2 of 26S proteasome regulatory subunit 8.

Mol	Chain	Residues	Atoms					AltConf	Trace
			Total	C	N	O	S		
3	C	396	3105	1954	558	576	17	0	0

- Molecule 4 is a protein called 26S protease regulatory subunit 6B.

Mol	Chain	Residues	Atoms					AltConf	Trace
			Total	C	N	O	S		
4	D	380	3040	1923	524	580	13	0	0

- Molecule 5 is a protein called 26S proteasome regulatory subunit 10B.

Mol	Chain	Residues	Atoms					AltConf	Trace
			Total	C	N	O	S		
5	E	389	3097	1947	552	581	17	0	0

- Molecule 6 is a protein called 26S protease regulatory subunit 6A.

Mol	Chain	Residues	Atoms					AltConf	Trace
			Total	C	N	O	S		
6	F	395	3098	1951	533	596	18	0	0

- Molecule 7 is a protein called Proteasome subunit alpha type-6.

Mol	Chain	Residues	Atoms					AltConf	Trace
			Total	C	N	O	S		
7	G	240	Total	C	N	O	S	0	0
			1867	1187	312	355	13		
7	g	244	Total	C	N	O	S	0	0
			1879	1193	318	355	13		

- Molecule 8 is a protein called Proteasome subunit alpha type-2.

Mol	Chain	Residues	Atoms					AltConf	Trace
			Total	C	N	O	S		
8	H	232	Total	C	N	O	S	0	0
			1801	1149	304	342	6		
8	h	232	Total	C	N	O	S	0	0
			1805	1154	307	338	6		

- Molecule 9 is a protein called Proteasome subunit alpha type-4.

Mol	Chain	Residues	Atoms					AltConf	Trace
			Total	C	N	O	S		
9	I	248	Total	C	N	O	S	0	0
			1933	1222	330	371	10		
9	i	250	Total	C	N	O	S	0	0
			1955	1234	336	375	10		

- Molecule 10 is a protein called Proteasome subunit alpha type-7.

Mol	Chain	Residues	Atoms					AltConf	Trace
			Total	C	N	O	S		
10	J	239	Total	C	N	O	S	0	0
			1861	1166	327	363	5		
10	j	239	Total	C	N	O	S	0	0
			1861	1168	332	356	5		

- Molecule 11 is a protein called Proteasome subunit alpha type-5.

Mol	Chain	Residues	Atoms					AltConf	Trace
			Total	C	N	O	S		
11	K	238	Total	C	N	O	S	0	0
			1813	1139	302	361	11		
11	k	234	Total	C	N	O	S	0	0
			1782	1119	295	357	11		

- Molecule 12 is a protein called Isoform Long of Proteasome subunit alpha type-1.

Mol	Chain	Residues	Atoms					AltConf	Trace
			Total	C	N	O	S		
12	L	240	1876	1175	338	352	11	0	0
12	l	238	1861	1165	335	350	11	0	0

- Molecule 13 is a protein called Proteasome subunit alpha type-3.

Mol	Chain	Residues	Atoms					AltConf	Trace
			Total	C	N	O	S		
13	M	242	1890	1200	323	356	11	0	0
13	m	240	1881	1193	321	356	11	0	0

- Molecule 14 is a protein called Proteasome subunit beta type-6.

Mol	Chain	Residues	Atoms					AltConf	Trace
			Total	C	N	O	S		
14	N	203	1521	954	259	296	12	0	0
14	n	202	1510	947	258	293	12	0	0

- Molecule 15 is a protein called Proteasome subunit beta type-7.

Mol	Chain	Residues	Atoms					AltConf	Trace
			Total	C	N	O	S		
15	O	220	1645	1035	278	320	12	0	0
15	o	220	1659	1044	283	320	12	0	0

- Molecule 16 is a protein called Proteasome subunit beta type-3.

Mol	Chain	Residues	Atoms					AltConf	Trace
			Total	C	N	O	S		
16	P	204	1587	1010	264	294	19	0	0
16	p	204	1591	1013	265	294	19	0	0

- Molecule 17 is a protein called Proteasome subunit beta type-2.

Mol	Chain	Residues	Atoms					AltConf	Trace
			Total	C	N	O	S		
17	Q	199	1588	1017	270	292	9	0	0

*Continued on next page...*

*Continued from previous page...*

Mol	Chain	Residues	Atoms					AltConf	Trace
17	q	199	Total	C	N	O	S	0	0
			1578	1012	267	290	9		

- Molecule 18 is a protein called Proteasome subunit beta type-5.

Mol	Chain	Residues	Atoms					AltConf	Trace
18	R	201	Total	C	N	O	S	0	0
			1559	982	274	294	9		
18	r	201	Total	C	N	O	S	0	0
			1549	977	270	293	9		

- Molecule 19 is a protein called Proteasome subunit beta type-1.

Mol	Chain	Residues	Atoms					AltConf	Trace
19	S	213	Total	C	N	O	S	0	0
			1641	1041	281	309	10		
19	s	213	Total	C	N	O	S	0	0
			1650	1044	283	313	10		

- Molecule 20 is a protein called Proteasome subunit beta type-4.

Mol	Chain	Residues	Atoms					AltConf	Trace
20	T	216	Total	C	N	O	S	0	0
			1683	1062	291	318	12		
20	t	216	Total	C	N	O	S	0	0
			1687	1064	291	320	12		

- Molecule 21 is a protein called 26S proteasome non-ATPase regulatory subunit 1.

Mol	Chain	Residues	Atoms					AltConf	Trace
21	U	872	Total	C	N	O	S	0	0
			6828	4328	1157	1298	45		

- Molecule 22 is a protein called 26S proteasome non-ATPase regulatory subunit 11.

Mol	Chain	Residues	Atoms					AltConf	Trace
22	X	380	Total	C	N	O	S	0	0
			3009	1918	509	570	12		

- Molecule 23 is a protein called 26S proteasome non-ATPase regulatory subunit 6.



Mol	Chain	Residues	Atoms					AltConf	Trace
			Total	C	N	O	S		
23	Y	378	3115	1987	533	578	17	0	0

- Molecule 24 is a protein called 26S proteasome non-ATPase regulatory subunit 7.

Mol	Chain	Residues	Atoms					AltConf	Trace
			Total	C	N	O	S		
24	Z	286	2281	1457	392	427	5	0	0

- Molecule 25 is a protein called 26S proteasome non-ATPase regulatory subunit 13.

Mol	Chain	Residues	Atoms					AltConf	Trace
			Total	C	N	O	S		
25	a	373	2995	1911	510	559	15	0	0

- Molecule 26 is a protein called 26S proteasome non-ATPase regulatory subunit 4.

Mol	Chain	Residues	Atoms					AltConf	Trace
			Total	C	N	O	S		
26	b	191	1458	910	261	279	8	0	0

- Molecule 27 is a protein called 26S proteasome non-ATPase regulatory subunit 14.

Mol	Chain	Residues	Atoms					AltConf	Trace
			Total	C	N	O	S		
27	c	287	2260	1430	389	422	19	0	0

- Molecule 28 is a protein called 26S proteasome non-ATPase regulatory subunit 8.

Mol	Chain	Residues	Atoms					AltConf	Trace
			Total	C	N	O	S		
28	d	257	2116	1371	346	390	9	0	0

- Molecule 29 is a protein called 26S proteasome non-ATPase regulatory subunit 2.

Mol	Chain	Residues	Atoms					AltConf	Trace
			Total	C	N	O	S		
29	f	889	6866	4315	1174	1331	46	0	0

- Molecule 30 is a protein called Ubiquitin carboxyl-terminal hydrolase 14.

Mol	Chain	Residues	Atoms					AltConf	Trace
			Total	C	N	O	S		
30	x	494	3929	2485	647	769	28	0	0

- Molecule 31 is a protein called Ubiquitin.

Mol	Chain	Residues	Atoms					AltConf	Trace
			Total	C	N	O	S		
31	y	76	601	378	105	117	1	0	0

- Molecule 32 is a protein called 26S proteasome non-ATPase regulatory subunit 12.

Mol	Chain	Residues	Atoms					AltConf	Trace
			Total	C	N	O	S		
32	W	446	3635	2302	622	687	24	0	0

- Molecule 33 is a protein called Substrate.

Mol	Chain	Residues	Atoms				AltConf	Trace
			Total	C	N	O		
33	v	34	170	102	34	34	0	0

- Molecule 34 is a protein called 26S proteasome non-ATPase regulatory subunit 3.

Mol	Chain	Residues	Atoms					AltConf	Trace
			Total	C	N	O	S		
34	V	444	3612	2301	645	653	13	0	0

- Molecule 35 is a protein called 26S proteasome complex subunit DSS1.

Mol	Chain	Residues	Atoms				AltConf	Trace
			Total	C	N	O		
35	e	50	425	260	65	100	0	0

- Molecule 36 is ADENOSINE-5'-TRIPHOSPHATE (three-letter code: ATP) (formula: C<sub>10</sub>H<sub>16</sub>N<sub>5</sub>O<sub>13</sub>P<sub>3</sub>) (labeled as "Ligand of Interest" by depositor).

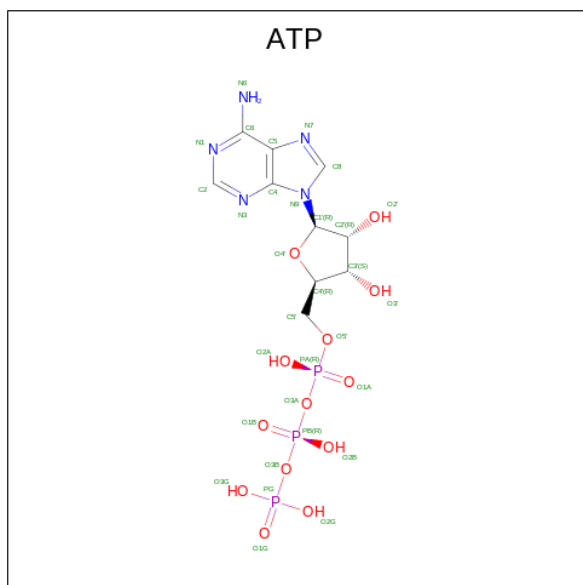

Mol	Chain	Residues	Atoms					AltConf
			Total	C	N	O	P	
36	A	1	Total	C	N	O	P	0
			31	10	5	13	3	
36	B	1	Total	C	N	O	P	0
			31	10	5	13	3	
36	C	1	Total	C	N	O	P	0
			31	10	5	13	3	
36	F	1	Total	C	N	O	P	0
			31	10	5	13	3	

- Molecule 37 is ADENOSINE-5'-DIPHOSPHATE (three-letter code: ADP) (formula:  $C_{10}H_{15}N_5O_{10}P_2$ ) (labeled as "Ligand of Interest" by depositor).

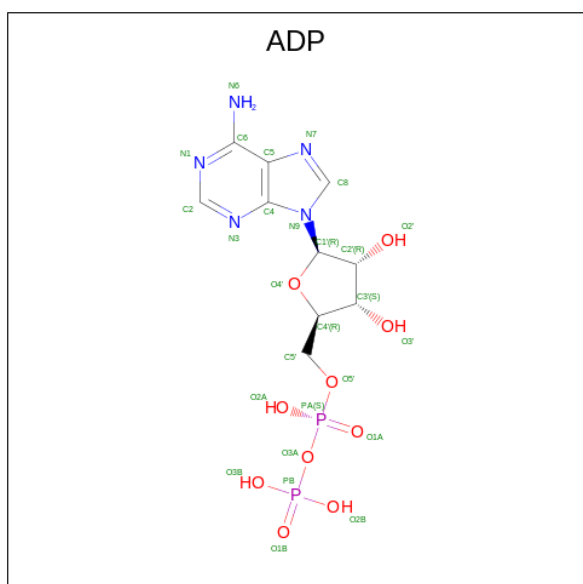

Mol	Chain	Residues	Atoms					AltConf
			Total	C	N	O	P	
37	D	1	27	10	5	10	2	0

- Molecule 38 is ZINC ION (three-letter code: ZN) (formula: Zn).

Mol	Chain	Residues	Atoms		AltConf
			Total	Zn	
38	c	1	1	1	0

### 3 Residue-property plots [i](#)

These plots are drawn for all protein, RNA, DNA and oligosaccharide chains in the entry. The first graphic for a chain summarises the proportions of the various outlier classes displayed in the second graphic. The second graphic shows the sequence view annotated by issues in geometry and atom inclusion in map density. Residues are color-coded according to the number of geometric quality criteria for which they contain at least one outlier: green = 0, yellow = 1, orange = 2 and red = 3 or more. A red diamond above a residue indicates a poor fit to the EM map for this residue (all-atom inclusion < 40%). Stretches of 2 or more consecutive residues without any outlier are shown as a green connector. Residues present in the sample, but not in the model, are shown in grey.

- Molecule 1: 26S protease regulatory subunit 7

Chain A:  94% 5%

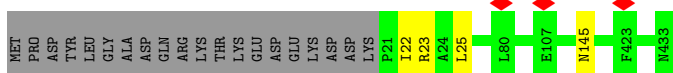

- Molecule 2: 26S protease regulatory subunit 4

Chain B:  93% 7%

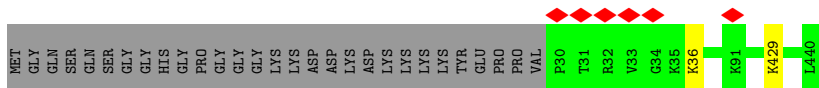

- Molecule 3: Isoform 2 of 26S proteasome regulatory subunit 8

Chain C:  99%

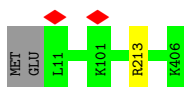

- Molecule 4: 26S protease regulatory subunit 6B

Chain D:  90% 9%

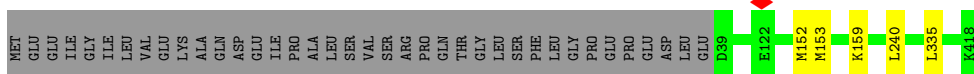

- Molecule 5: 26S proteasome regulatory subunit 10B

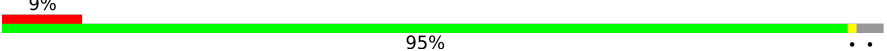
Chain E:  9% 95% 9%

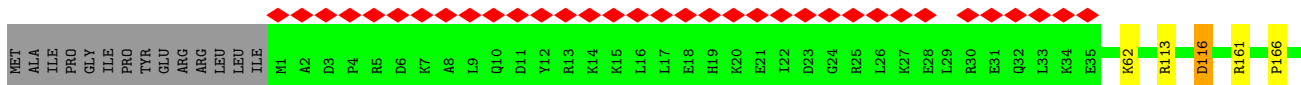

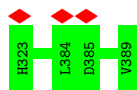

• Molecule 6: 26S protease regulatory subunit 6A

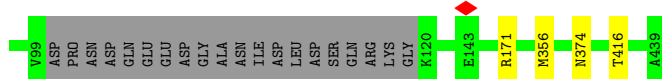
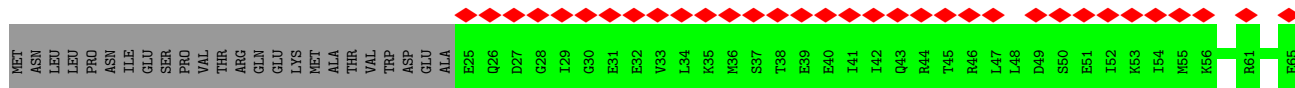
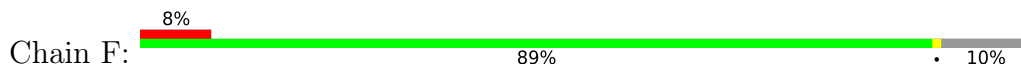

• Molecule 7: Proteasome subunit alpha type-6

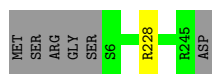

• Molecule 7: Proteasome subunit alpha type-6

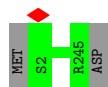

• Molecule 8: Proteasome subunit alpha type-2

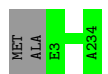

• Molecule 8: Proteasome subunit alpha type-2



• Molecule 9: Proteasome subunit alpha type-4

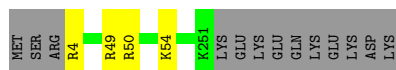
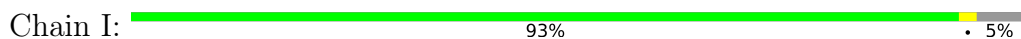

Molecule 9: Proteasome subunit alpha type-4

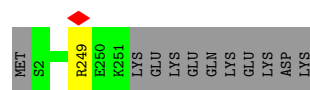

Molecule 10: Proteasome subunit alpha type-7

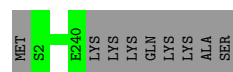

Molecule 10: Proteasome subunit alpha type-7

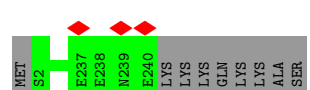

Molecule 11: Proteasome subunit alpha type-5



Molecule 11: Proteasome subunit alpha type-5

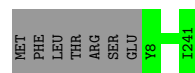

Molecule 12: Isoform Long of Proteasome subunit alpha type-1

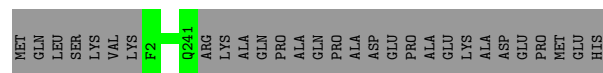
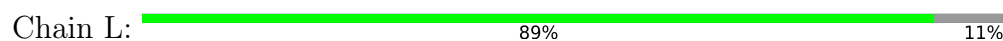

Molecule 12: Isoform Long of Proteasome subunit alpha type-1

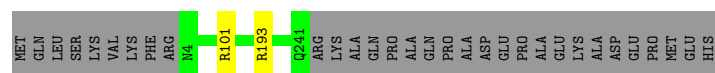
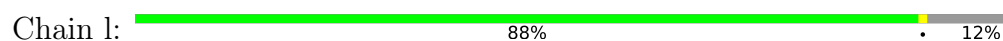

• Molecule 13: Proteasome subunit alpha type-3

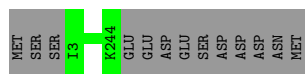

• Molecule 13: Proteasome subunit alpha type-3

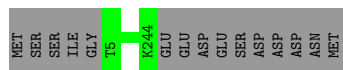

• Molecule 14: Proteasome subunit beta type-6

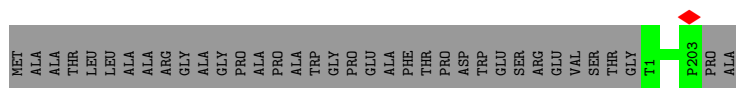
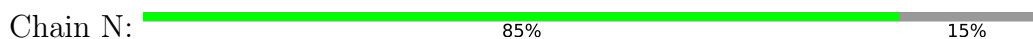

• Molecule 14: Proteasome subunit beta type-6

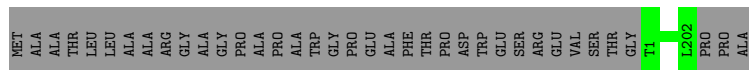
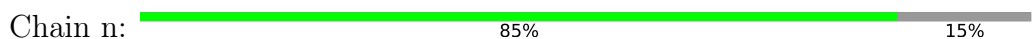

• Molecule 15: Proteasome subunit beta type-7

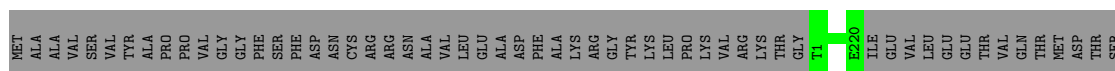
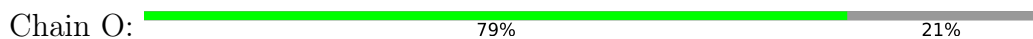

• Molecule 15: Proteasome subunit beta type-7

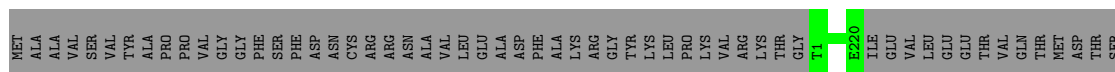
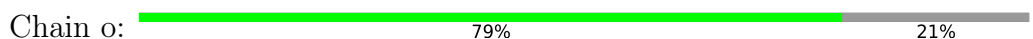

• Molecule 16: Proteasome subunit beta type-3





• Molecule 16: Proteasome subunit beta type-3



• Molecule 17: Proteasome subunit beta type-2



• Molecule 17: Proteasome subunit beta type-2

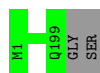

• Molecule 18: Proteasome subunit beta type-5

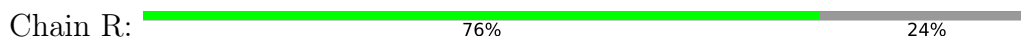

• Molecule 18: Proteasome subunit beta type-5

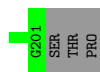

• Molecule 19: Proteasome subunit beta type-1

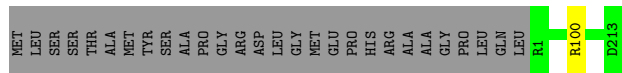
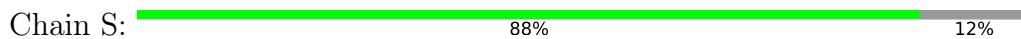

• Molecule 19: Proteasome subunit beta type-1

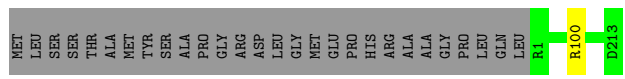
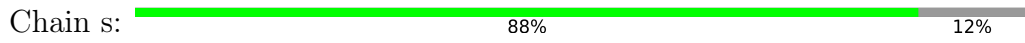

- Molecule 20: Proteasome subunit beta type-4

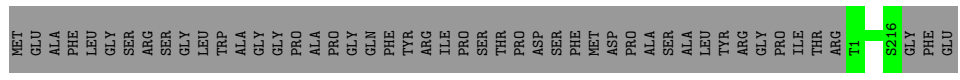
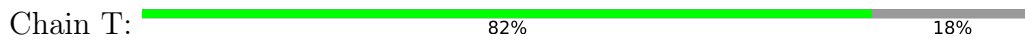

- Molecule 20: Proteasome subunit beta type-4

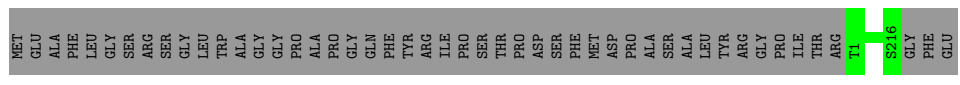
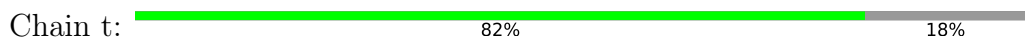

- Molecule 21: 26S proteasome non-ATPase regulatory subunit 1

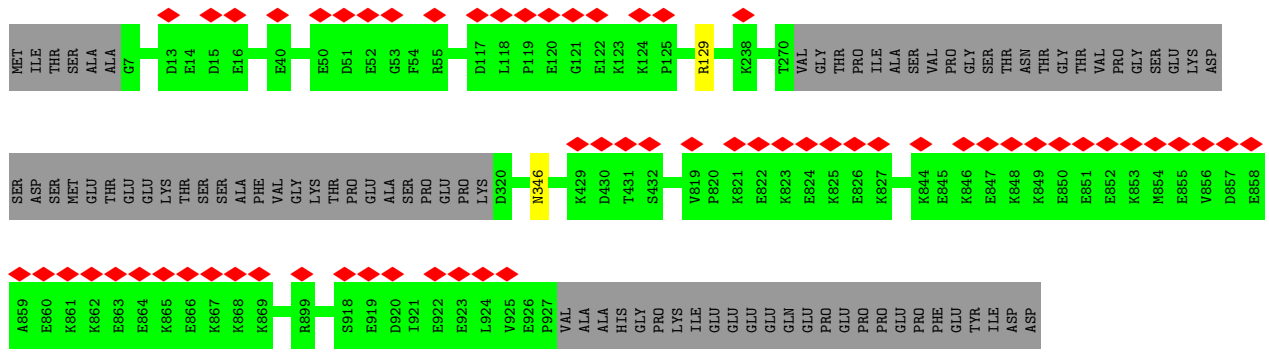
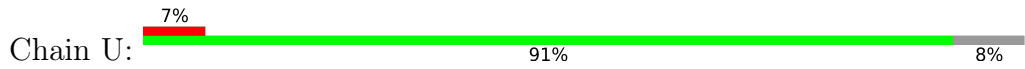

- Molecule 22: 26S proteasome non-ATPase regulatory subunit 11

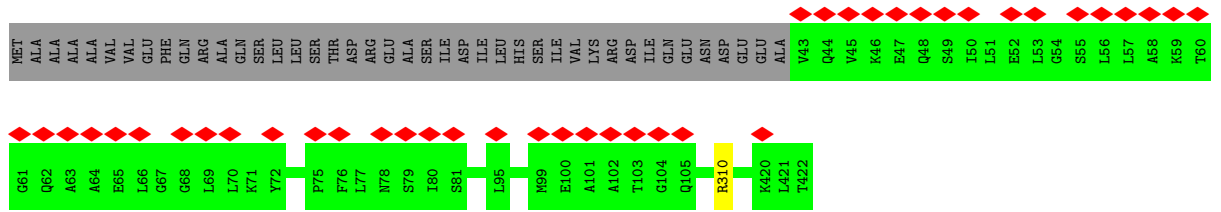
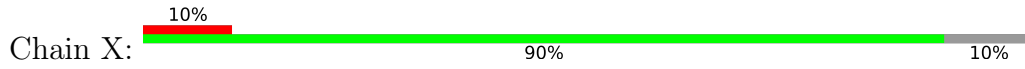

- Molecule 23: 26S proteasome non-ATPase regulatory subunit 6



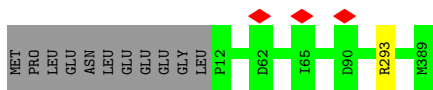

- Molecule 24: 26S proteasome non-ATPase regulatory subunit 7

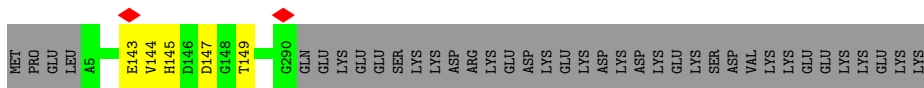
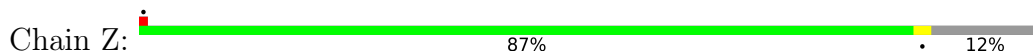

- Molecule 25: 26S proteasome non-ATPase regulatory subunit 13

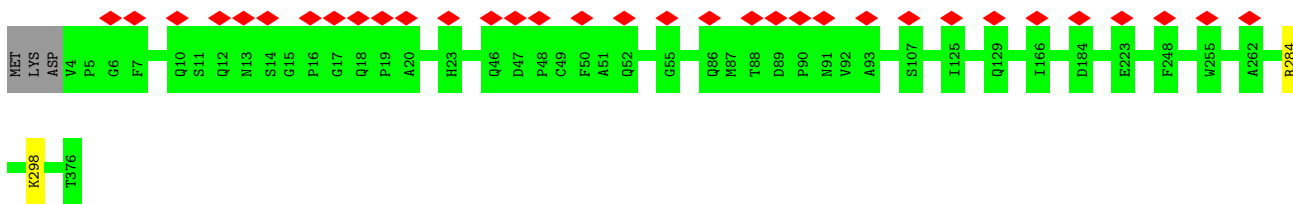

- Molecule 26: 26S proteasome non-ATPase regulatory subunit 4

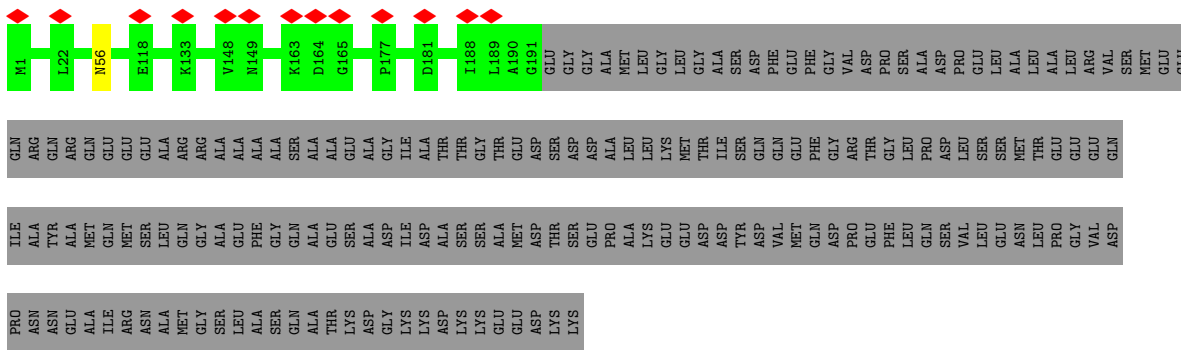

- Molecule 27: 26S proteasome non-ATPase regulatory subunit 14

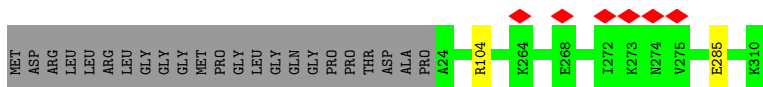
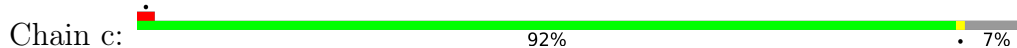

- Molecule 28: 26S proteasome non-ATPase regulatory subunit 8

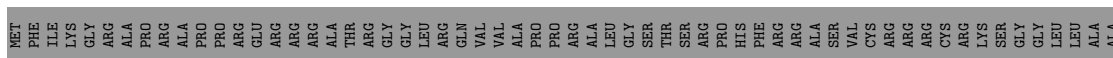

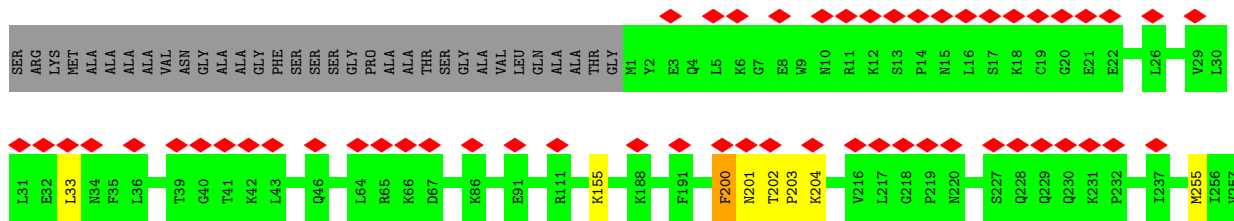

• Molecule 29: 26S proteasome non-ATPase regulatory subunit 2

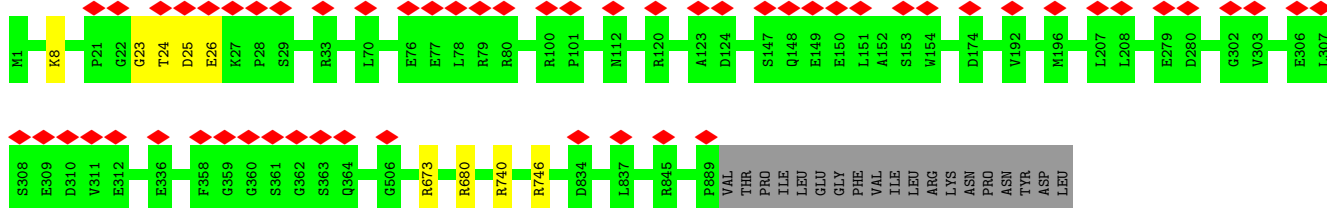

• Molecule 30: Ubiquitin carboxyl-terminal hydrolase 14

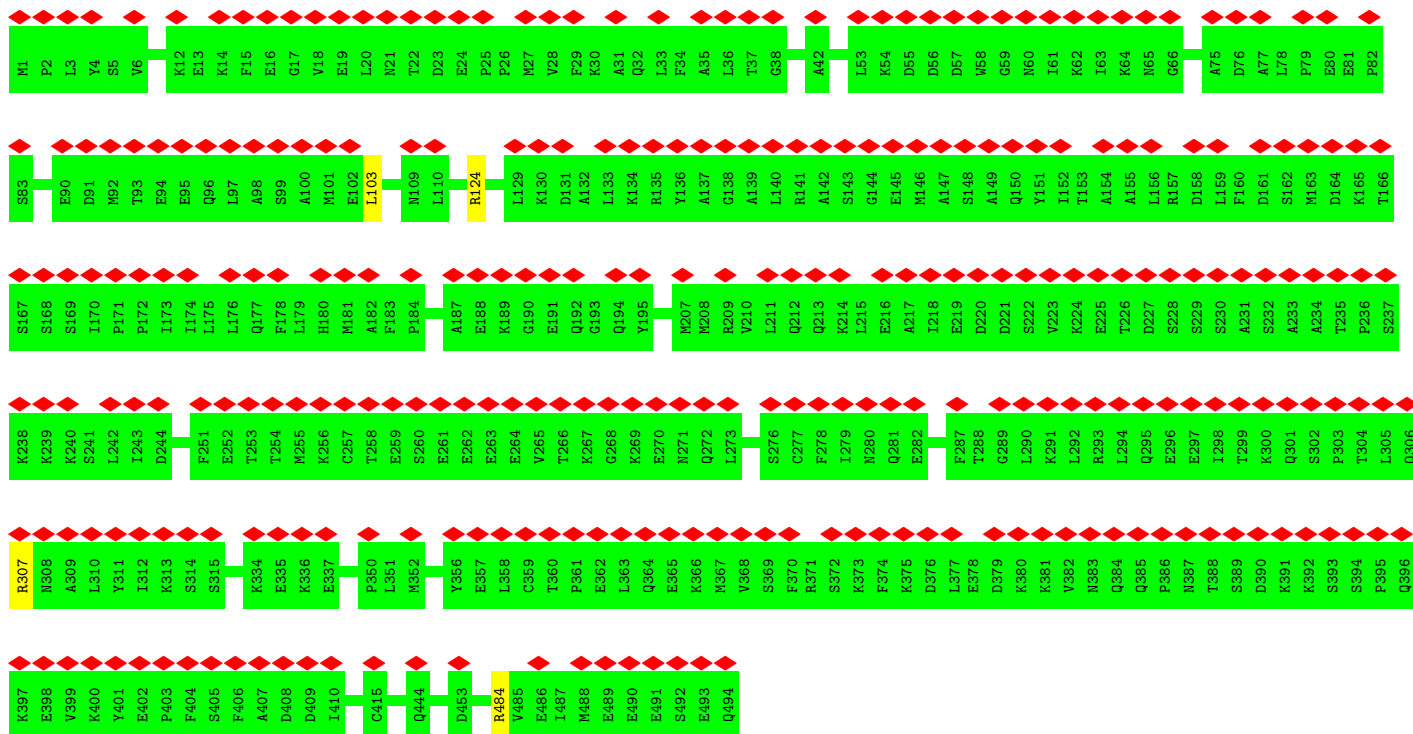

• Molecule 31: Ubiquitin

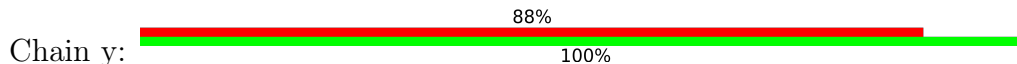



• Molecule 32: 26S proteasome non-ATPase regulatory subunit 12

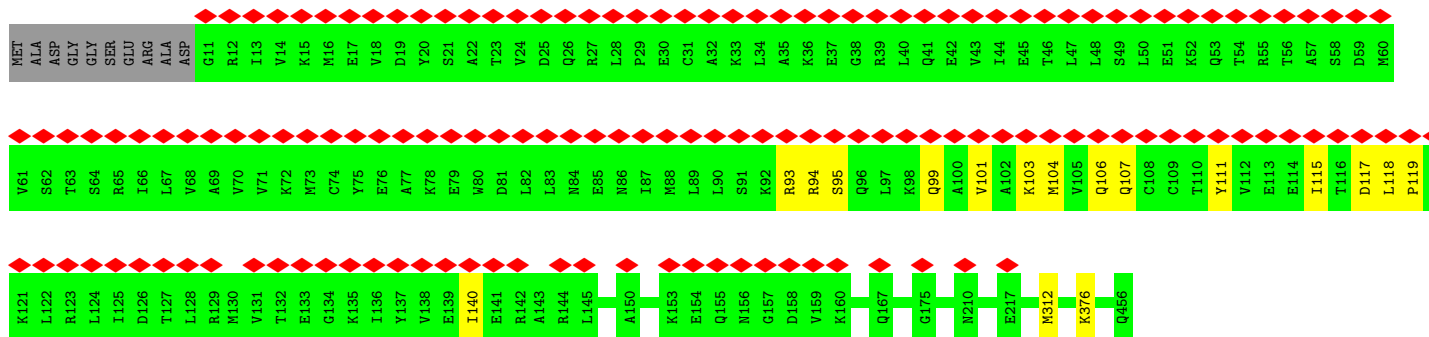

• Molecule 33: Substrate

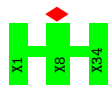

• Molecule 34: 26S proteasome non-ATPase regulatory subunit 3

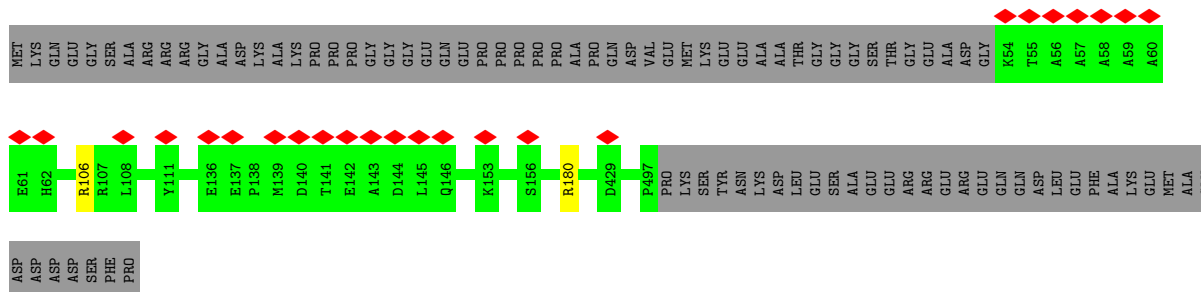
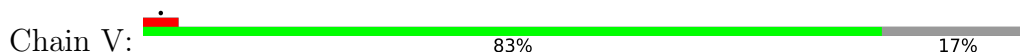

• Molecule 35: 26S proteasome complex subunit DSS1

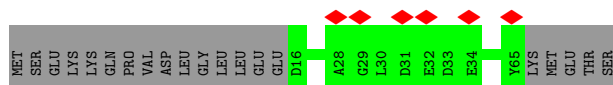

## 4 Experimental information

Property	Value	Source
EM reconstruction method	SINGLE PARTICLE	Depositor
Imposed symmetry	POINT, Not provided	
Number of particles used	291384	Depositor
Resolution determination method	FSC 0.143 CUT-OFF	Depositor
CTF correction method	PHASE FLIPPING AND AMPLITUDE CORRECTION	Depositor
Microscope	FEI TITAN KRIOS	Depositor
Voltage (kV)	300	Depositor
Electron dose ( $e^-/\text{\AA}^2$ )	50	Depositor
Minimum defocus (nm)	400	Depositor
Maximum defocus (nm)	5000	Depositor
Magnification	Not provided	
Image detector	GATAN K2 SUMMIT (4k x 4k)	Depositor
Maximum map value	0.018	Depositor
Minimum map value	-0.002	Depositor
Average map value	-0.000	Depositor
Map value standard deviation	0.001	Depositor
Recommended contour level	0.005	Depositor
Map size (Å)	438.4, 438.4, 438.4	wwPDB
Map dimensions	640, 640, 640	wwPDB
Map angles (°)	90.0, 90.0, 90.0	wwPDB
Pixel spacing (Å)	0.685, 0.685, 0.685	Depositor

## 5 Model quality [i](#)

### 5.1 Standard geometry [i](#)

Bond lengths and bond angles in the following residue types are not validated in this section: ZN, ATP, ADP

The Z score for a bond length (or angle) is the number of standard deviations the observed value is removed from the expected value. A bond length (or angle) with  $|Z| > 5$  is considered an outlier worth inspection. RMSZ is the root-mean-square of all Z scores of the bond lengths (or angles).

Mol	Chain	Bond lengths		Bond angles	
		RMSZ	# Z  >5	RMSZ	# Z  >5
1	A	0.26	0/3283	0.56	0/4433
2	B	0.26	0/3254	0.55	0/4388
3	C	0.26	0/3146	0.58	0/4226
4	D	0.28	0/3090	0.57	1/4168 (0.0%)
5	E	0.27	0/3145	0.61	0/4233
6	F	0.26	0/3137	0.57	0/4223
7	G	0.28	0/1901	0.50	0/2572
7	g	0.28	0/1913	0.50	0/2589
8	H	0.28	0/1840	0.51	0/2495
8	h	0.29	0/1844	0.51	0/2497
9	I	0.26	0/1963	0.50	0/2650
9	i	0.27	0/1985	0.51	0/2677
10	J	0.26	0/1887	0.52	0/2553
10	j	0.26	0/1887	0.55	0/2549
11	K	0.27	0/1841	0.51	1/2486 (0.0%)
11	k	0.26	0/1809	0.48	0/2444
12	L	0.27	0/1911	0.52	0/2584
12	l	0.26	0/1896	0.53	0/2565
13	M	0.28	0/1925	0.52	0/2592
13	m	0.27	0/1916	0.49	0/2580
14	N	0.27	0/1548	0.52	0/2097
14	n	0.27	0/1536	0.52	0/2080
15	O	0.27	0/1672	0.53	0/2267
15	o	0.27	0/1686	0.54	0/2282
16	P	0.27	0/1616	0.51	0/2180
16	p	0.27	0/1620	0.51	0/2184
17	Q	0.28	0/1621	0.51	0/2194
17	q	0.28	0/1611	0.51	0/2182
18	R	0.29	0/1590	0.55	0/2147
18	r	0.28	0/1580	0.52	0/2135
19	S	0.28	0/1671	0.54	0/2252
19	s	0.28	0/1680	0.53	0/2264

Mol	Chain	Bond lengths		Bond angles	
		RMSZ	# Z  >5	RMSZ	# Z  >5
20	T	0.28	0/1716	0.53	0/2323
20	t	0.27	0/1720	0.52	0/2328
21	U	0.26	0/6945	0.54	0/9382
22	X	0.26	0/3053	0.52	0/4115
23	Y	0.27	0/3173	0.57	0/4273
24	Z	0.27	0/2324	0.53	0/3150
25	a	0.26	0/3053	0.58	0/4133
26	b	0.26	0/1478	0.58	0/2001
27	c	0.27	0/2302	0.57	0/3110
28	d	0.28	0/2162	0.56	2/2919 (0.1%)
29	f	0.28	0/6980	0.61	0/9433
30	x	0.25	0/4002	0.51	0/5390
31	y	0.25	0/607	0.56	0/816
32	W	0.26	0/3683	0.56	1/4952 (0.0%)
34	V	0.26	0/3681	0.54	0/4969
35	e	0.26	0/437	0.48	0/595
All	All	0.27	0/112320	0.54	5/151657 (0.0%)

There are no bond length outliers.

All (5) bond angle outliers are listed below:

Mol	Chain	Res	Type	Atoms	Z	Observed(°)	Ideal(°)
11	K	121	LEU	CA-CB-CG	5.83	128.72	115.30
4	D	335	LEU	CA-CB-CG	5.61	128.20	115.30
28	d	255	MET	CA-CB-CG	5.30	122.31	113.30
28	d	33	LEU	CA-CB-CG	5.26	127.39	115.30
32	W	312	MET	CA-CB-CG	5.05	121.89	113.30

There are no chirality outliers.

There are no planarity outliers.

## 5.2 Too-close contacts [i](#)

Due to software issues we are unable to calculate clashes - this section is therefore empty.



## 5.3 Torsion angles

### 5.3.1 Protein backbone

In the following table, the Percentiles column shows the percent Ramachandran outliers of the chain as a percentile score with respect to all PDB entries followed by that with respect to all EM entries.

The Analysed column shows the number of residues for which the backbone conformation was analysed, and the total number of residues.

Mol	Chain	Analysed	Favoured	Allowed	Outliers	Percentiles	
1	A	411/433 (95%)	380 (92%)	31 (8%)	0	100	100
2	B	409/440 (93%)	374 (91%)	35 (9%)	0	100	100
3	C	394/398 (99%)	356 (90%)	38 (10%)	0	100	100
4	D	378/418 (90%)	327 (86%)	49 (13%)	2 (0%)	29	67
5	E	387/403 (96%)	359 (93%)	26 (7%)	2 (0%)	29	67
6	F	391/439 (89%)	357 (91%)	34 (9%)	0	100	100
7	G	238/246 (97%)	228 (96%)	10 (4%)	0	100	100
7	g	242/246 (98%)	229 (95%)	13 (5%)	0	100	100
8	H	230/234 (98%)	216 (94%)	14 (6%)	0	100	100
8	h	230/234 (98%)	215 (94%)	15 (6%)	0	100	100
9	I	246/261 (94%)	238 (97%)	8 (3%)	0	100	100
9	i	248/261 (95%)	240 (97%)	8 (3%)	0	100	100
10	J	237/248 (96%)	224 (94%)	13 (6%)	0	100	100
10	j	237/248 (96%)	224 (94%)	13 (6%)	0	100	100
11	K	236/241 (98%)	226 (96%)	10 (4%)	0	100	100
11	k	232/241 (96%)	223 (96%)	9 (4%)	0	100	100
12	L	238/269 (88%)	231 (97%)	7 (3%)	0	100	100
12	l	236/269 (88%)	227 (96%)	9 (4%)	0	100	100
13	M	240/255 (94%)	232 (97%)	8 (3%)	0	100	100
13	m	238/255 (93%)	238 (100%)	0	0	100	100
14	N	201/239 (84%)	196 (98%)	5 (2%)	0	100	100
14	n	200/239 (84%)	196 (98%)	4 (2%)	0	100	100
15	O	218/277 (79%)	212 (97%)	6 (3%)	0	100	100
15	o	218/277 (79%)	208 (95%)	10 (5%)	0	100	100
16	P	202/205 (98%)	196 (97%)	6 (3%)	0	100	100

*Continued on next page...*

Continued from previous page...

Mol	Chain	Analysed	Favoured	Allowed	Outliers	Percentiles	
16	p	202/205 (98%)	195 (96%)	7 (4%)	0	100	100
17	Q	197/201 (98%)	191 (97%)	6 (3%)	0	100	100
17	q	197/201 (98%)	191 (97%)	6 (3%)	0	100	100
18	R	199/263 (76%)	192 (96%)	7 (4%)	0	100	100
18	r	199/263 (76%)	192 (96%)	7 (4%)	0	100	100
19	S	211/241 (88%)	204 (97%)	7 (3%)	0	100	100
19	s	211/241 (88%)	204 (97%)	7 (3%)	0	100	100
20	T	214/264 (81%)	210 (98%)	4 (2%)	0	100	100
20	t	214/264 (81%)	206 (96%)	8 (4%)	0	100	100
21	U	868/953 (91%)	817 (94%)	51 (6%)	0	100	100
22	X	378/422 (90%)	363 (96%)	15 (4%)	0	100	100
23	Y	376/389 (97%)	343 (91%)	33 (9%)	0	100	100
24	Z	284/324 (88%)	253 (89%)	30 (11%)	1 (0%)	34	69
25	a	371/376 (99%)	338 (91%)	33 (9%)	0	100	100
26	b	189/377 (50%)	174 (92%)	14 (7%)	1 (0%)	29	67
27	c	285/310 (92%)	260 (91%)	24 (8%)	1 (0%)	34	69
28	d	255/350 (73%)	214 (84%)	39 (15%)	2 (1%)	19	58
29	f	887/908 (98%)	784 (88%)	101 (11%)	2 (0%)	47	79
30	x	492/494 (100%)	467 (95%)	24 (5%)	1 (0%)	47	79
31	y	74/76 (97%)	72 (97%)	2 (3%)	0	100	100
32	W	444/456 (97%)	411 (93%)	29 (6%)	4 (1%)	17	56
34	V	442/534 (83%)	426 (96%)	16 (4%)	0	100	100
35	e	48/70 (69%)	42 (88%)	6 (12%)	0	100	100
All	All	13974/15458 (90%)	13101 (94%)	857 (6%)	16 (0%)	54	83

All (16) Ramachandran outliers are listed below:

Mol	Chain	Res	Type
26	b	56	ASN
29	f	26	GLU
24	Z	145	HIS
27	c	285	GLU
32	W	140	ILE
4	D	159	LYS

Continued on next page...

*Continued from previous page...*

Mol	Chain	Res	Type
28	d	200	PHE
32	W	117	ASP
32	W	118	LEU
5	E	116	ASP
28	d	203	PRO
32	W	119	PRO
4	D	240	LEU
5	E	166	PRO
29	f	23	GLY
30	x	103	LEU

### 5.3.2 Protein sidechains [i](#)

In the following table, the Percentiles column shows the percent sidechain outliers of the chain as a percentile score with respect to all PDB entries followed by that with respect to all EM entries.

The Analysed column shows the number of residues for which the sidechain conformation was analysed, and the total number of residues.

Mol	Chain	Analysed	Rotameric	Outliers	Percentiles	
1	A	348/372 (94%)	344 (99%)	4 (1%)	73	88
2	B	357/385 (93%)	355 (99%)	2 (1%)	86	94
3	C	340/346 (98%)	339 (100%)	1 (0%)	92	96
4	D	333/366 (91%)	331 (99%)	2 (1%)	86	94
5	E	341/353 (97%)	337 (99%)	4 (1%)	71	88
6	F	340/379 (90%)	336 (99%)	4 (1%)	71	88
7	G	202/210 (96%)	201 (100%)	1 (0%)	88	95
7	g	201/210 (96%)	201 (100%)	0	100	100
8	H	187/191 (98%)	187 (100%)	0	100	100
8	h	188/191 (98%)	186 (99%)	2 (1%)	73	88
9	I	202/221 (91%)	198 (98%)	4 (2%)	55	80
9	i	206/221 (93%)	205 (100%)	1 (0%)	88	95
10	J	197/211 (93%)	197 (100%)	0	100	100
10	j	196/211 (93%)	196 (100%)	0	100	100
11	K	197/203 (97%)	196 (100%)	1 (0%)	88	95
11	k	195/203 (96%)	195 (100%)	0	100	100

*Continued on next page...*

*Continued from previous page...*

Mol	Chain	Analysed	Rotameric	Outliers	Percentiles	
12	L	202/230 (88%)	202 (100%)	0	100	100
12	l	201/230 (87%)	199 (99%)	2 (1%)	76	90
13	M	198/212 (93%)	198 (100%)	0	100	100
13	m	198/212 (93%)	198 (100%)	0	100	100
14	N	158/181 (87%)	158 (100%)	0	100	100
14	n	156/181 (86%)	156 (100%)	0	100	100
15	O	178/228 (78%)	178 (100%)	0	100	100
15	o	181/228 (79%)	181 (100%)	0	100	100
16	P	172/174 (99%)	171 (99%)	1 (1%)	86	94
16	p	173/174 (99%)	173 (100%)	0	100	100
17	Q	168/171 (98%)	167 (99%)	1 (1%)	86	94
17	q	166/171 (97%)	166 (100%)	0	100	100
18	R	156/202 (77%)	156 (100%)	0	100	100
18	r	154/202 (76%)	154 (100%)	0	100	100
19	S	175/199 (88%)	174 (99%)	1 (1%)	86	94
19	s	177/199 (89%)	176 (99%)	1 (1%)	86	94
20	T	178/215 (83%)	178 (100%)	0	100	100
20	t	179/215 (83%)	179 (100%)	0	100	100
21	U	748/816 (92%)	746 (100%)	2 (0%)	92	96
22	X	327/362 (90%)	326 (100%)	1 (0%)	92	96
23	Y	334/344 (97%)	333 (100%)	1 (0%)	92	96
24	Z	257/295 (87%)	253 (98%)	4 (2%)	62	84
25	a	333/336 (99%)	331 (99%)	2 (1%)	86	94
26	b	167/312 (54%)	167 (100%)	0	100	100
27	c	252/268 (94%)	251 (100%)	1 (0%)	91	95
28	d	231/294 (79%)	226 (98%)	5 (2%)	52	79
29	f	745/763 (98%)	738 (99%)	7 (1%)	78	91
30	x	439/439 (100%)	436 (99%)	3 (1%)	84	94
31	y	68/68 (100%)	68 (100%)	0	100	100
32	W	410/416 (99%)	398 (97%)	12 (3%)	42	74
34	V	390/460 (85%)	388 (100%)	2 (0%)	88	95

*Continued on next page...*

*Continued from previous page...*

Mol	Chain	Analysed	Rotameric	Outliers	Percentiles	
35	e	44/63 (70%)	44 (100%)	0	100	100
All	All	11945/13133 (91%)	11873 (99%)	72 (1%)	86	94

All (72) residues with a non-rotameric sidechain are listed below:

Mol	Chain	Res	Type
1	A	22	ILE
1	A	23	ARG
1	A	25	LEU
1	A	145	ASN
2	B	36	LYS
2	B	429	LYS
3	C	213	ARG
4	D	152	MET
4	D	153	MET
5	E	62	LYS
5	E	113	ARG
5	E	116	ASP
5	E	161	ARG
6	F	171	ARG
6	F	356	MET
6	F	374	ASN
6	F	416	THR
7	G	228	ARG
9	I	4	ARG
9	I	49	ARG
9	I	50	ARG
9	I	54	LYS
11	K	239	LYS
16	P	99	ARG
17	Q	145	ARG
19	S	100	ARG
21	U	129	ARG
21	U	346	ASN
22	X	310	ARG
23	Y	293	ARG
24	Z	143	GLU
24	Z	144	VAL
24	Z	147	ASP
24	Z	149	THR
25	a	284	ARG
25	a	298	LYS

*Continued on next page...*

*Continued from previous page...*

Mol	Chain	Res	Type
27	c	104	ARG
28	d	155	LYS
28	d	200	PHE
28	d	201	ASN
28	d	202	THR
28	d	204	LYS
29	f	8	LYS
29	f	24	THR
29	f	25	ASP
29	f	673	ARG
29	f	680	ARG
29	f	740	ARG
29	f	746	ARG
8	h	183	GLU
8	h	184	LEU
9	i	249	ARG
12	l	101	ARG
12	l	193	ARG
19	s	100	ARG
30	x	124	ARG
30	x	307	ARG
30	x	484	ARG
32	W	93	ARG
32	W	94	ARG
32	W	95	SER
32	W	99	GLN
32	W	101	VAL
32	W	103	LYS
32	W	104	MET
32	W	106	GLN
32	W	107	GLN
32	W	111	TYR
32	W	115	ILE
32	W	376	LYS
34	V	106	ARG
34	V	180	ARG

Sometimes sidechains can be flipped to improve hydrogen bonding and reduce clashes. All (16) such sidechains are listed below:

Mol	Chain	Res	Type
4	D	353	ASN
4	D	412	GLN

*Continued on next page...*

*Continued from previous page...*

Mol	Chain	Res	Type
9	I	235	GLN
17	Q	168	GLN
19	S	108	ASN
19	S	151	ASN
25	a	193	GLN
29	f	118	ASN
29	f	180	GLN
29	f	291	GLN
29	f	325	GLN
11	k	214	ASN
16	p	93	ASN
32	W	96	GLN
32	W	99	GLN
32	W	107	GLN

### 5.3.3 RNA [i](#)

There are no RNA molecules in this entry.

### 5.4 Non-standard residues in protein, DNA, RNA chains [i](#)

There are no non-standard protein/DNA/RNA residues in this entry.

### 5.5 Carbohydrates [i](#)

There are no monosaccharides in this entry.

### 5.6 Ligand geometry [i](#)

Of 6 ligands modelled in this entry, 1 is monoatomic - leaving 5 for Mogul analysis.

In the following table, the Counts columns list the number of bonds (or angles) for which Mogul statistics could be retrieved, the number of bonds (or angles) that are observed in the model and the number of bonds (or angles) that are defined in the Chemical Component Dictionary. The Link column lists molecule types, if any, to which the group is linked. The Z score for a bond length (or angle) is the number of standard deviations the observed value is removed from the expected value. A bond length (or angle) with  $|Z| > 2$  is considered an outlier worth inspection. RMSZ is the root-mean-square of all Z scores of the bond lengths (or angles).

Mol	Type	Chain	Res	Link	Bond lengths			Bond angles		
					Counts	RMSZ	# Z  > 2	Counts	RMSZ	# Z  > 2
36	ATP	C	501	-	26,33,33	0.61	0	31,52,52	0.81	1 (3%)
36	ATP	B	501	-	26,33,33	0.61	0	31,52,52	0.73	2 (6%)
36	ATP	F	501	-	26,33,33	0.59	0	31,52,52	0.74	2 (6%)
37	ADP	D	501	-	24,29,29	0.96	1 (4%)	29,45,45	1.33	3 (10%)
36	ATP	A	501	-	26,33,33	0.62	0	31,52,52	0.72	1 (3%)

In the following table, the Chirals column lists the number of chiral outliers, the number of chiral centers analysed, the number of these observed in the model and the number defined in the Chemical Component Dictionary. Similar counts are reported in the Torsion and Rings columns. '-' means no outliers of that kind were identified.

Mol	Type	Chain	Res	Link	Chirals	Torsions	Rings
36	ATP	C	501	-	-	7/18/38/38	0/3/3/3
36	ATP	B	501	-	-	8/18/38/38	0/3/3/3
36	ATP	F	501	-	-	6/18/38/38	0/3/3/3
37	ADP	D	501	-	-	2/12/32/32	0/3/3/3
36	ATP	A	501	-	-	4/18/38/38	0/3/3/3

All (1) bond length outliers are listed below:

Mol	Chain	Res	Type	Atoms	Z	Observed(Å)	Ideal(Å)
37	D	501	ADP	C5-C4	2.50	1.47	1.40

All (9) bond angle outliers are listed below:

Mol	Chain	Res	Type	Atoms	Z	Observed(°)	Ideal(°)
37	D	501	ADP	C3'-C2'-C1'	3.50	106.24	100.98
37	D	501	ADP	N3-C2-N1	-3.15	123.75	128.68
37	D	501	ADP	C4-C5-N7	-2.56	106.73	109.40
36	F	501	ATP	C5-C6-N6	2.30	123.85	120.35
36	A	501	ATP	C5-C6-N6	2.29	123.83	120.35
36	C	501	ATP	C5-C6-N6	2.28	123.82	120.35
36	B	501	ATP	C5-C6-N6	2.27	123.81	120.35
36	B	501	ATP	PB-O3B-PG	2.03	139.78	132.83
36	F	501	ATP	PB-O3B-PG	2.02	139.77	132.83

There are no chirality outliers.

All (27) torsion outliers are listed below:



Mol	Chain	Res	Type	Atoms
36	A	501	ATP	PB-O3B-PG-O3G
36	B	501	ATP	PB-O3B-PG-O2G
36	B	501	ATP	C5'-O5'-PA-O2A
36	C	501	ATP	C5'-O5'-PA-O2A
36	C	501	ATP	C5'-O5'-PA-O3A
36	C	501	ATP	O4'-C4'-C5'-O5'
36	F	501	ATP	C5'-O5'-PA-O1A
36	B	501	ATP	O4'-C4'-C5'-O5'
36	C	501	ATP	C3'-C4'-C5'-O5'
36	B	501	ATP	C3'-C4'-C5'-O5'
37	D	501	ADP	C3'-C4'-C5'-O5'
36	F	501	ATP	C3'-C4'-C5'-O5'
37	D	501	ADP	O4'-C4'-C5'-O5'
36	F	501	ATP	O4'-C4'-C5'-O5'
36	C	501	ATP	C4'-C5'-O5'-PA
36	A	501	ATP	O4'-C4'-C5'-O5'
36	C	501	ATP	PB-O3B-PG-O2G
36	B	501	ATP	C5'-O5'-PA-O3A
36	B	501	ATP	C5'-O5'-PA-O1A
36	F	501	ATP	C5'-O5'-PA-O2A
36	A	501	ATP	C3'-C4'-C5'-O5'
36	F	501	ATP	PA-O3A-PB-O2B
36	B	501	ATP	PB-O3B-PG-O3G
36	F	501	ATP	C5'-O5'-PA-O3A
36	A	501	ATP	C4'-C5'-O5'-PA
36	C	501	ATP	C5'-O5'-PA-O1A
36	B	501	ATP	PB-O3B-PG-O1G

There are no ring outliers.

No monomer is involved in short contacts.

The following is a two-dimensional graphical depiction of Mogul quality analysis of bond lengths, bond angles, torsion angles, and ring geometry for all instances of the Ligand of Interest. In addition, ligands with molecular weight > 250 and outliers as shown on the validation Tables will also be included. For torsion angles, if less than 5% of the Mogul distribution of torsion angles is within 10 degrees of the torsion angle in question, then that torsion angle is considered an outlier. Any bond that is central to one or more torsion angles identified as an outlier by Mogul will be highlighted in the graph. For rings, the root-mean-square deviation (RMSD) between the ring in question and similar rings identified by Mogul is calculated over all ring torsion angles. If the average RMSD is greater than 60 degrees and the minimal RMSD between the ring in question and any Mogul-identified rings is also greater than 60 degrees, then that ring is considered an outlier. The outliers are highlighted in purple. The color gray indicates Mogul did not find sufficient equivalents in the CSD to analyse the geometry.

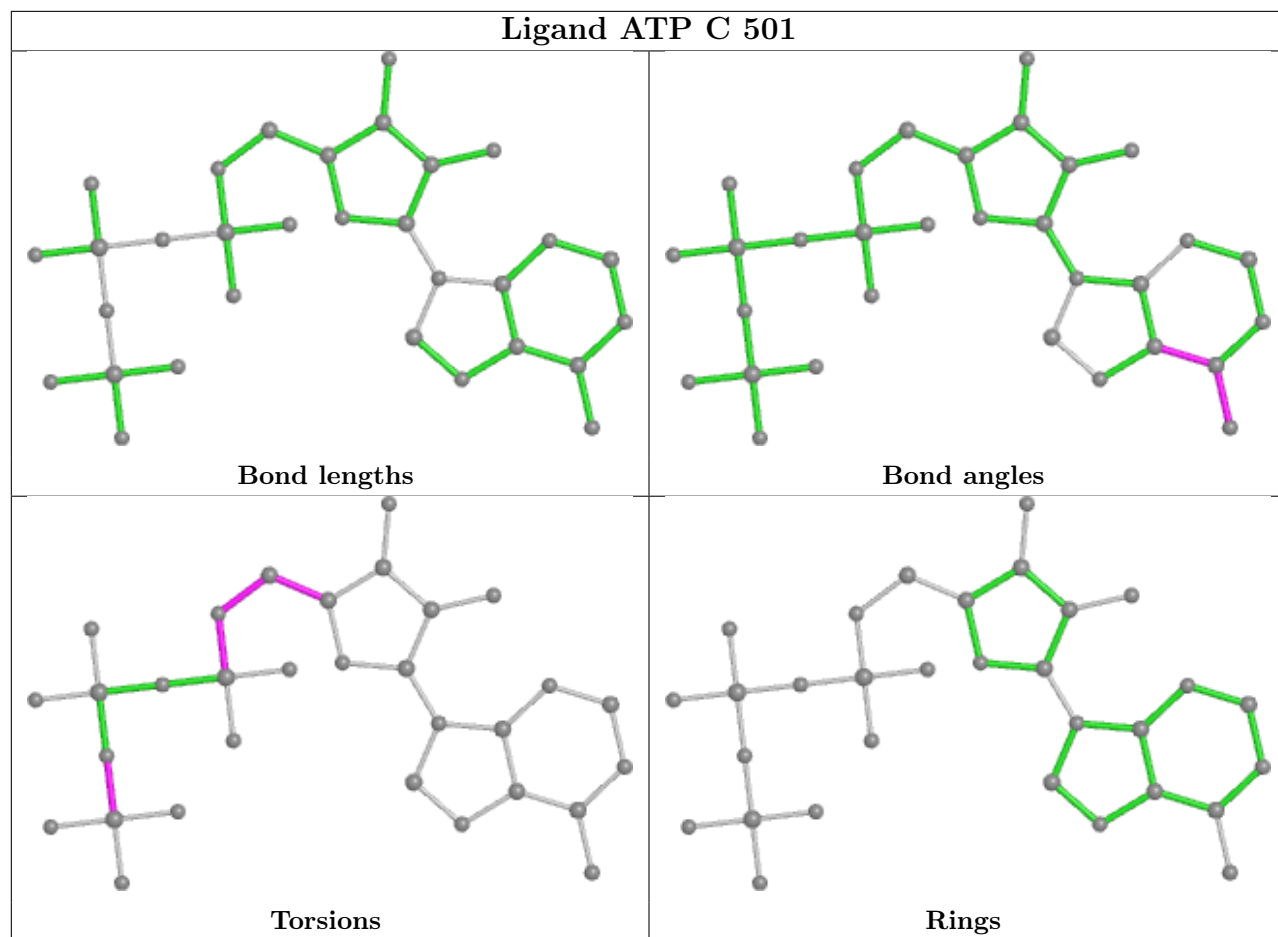

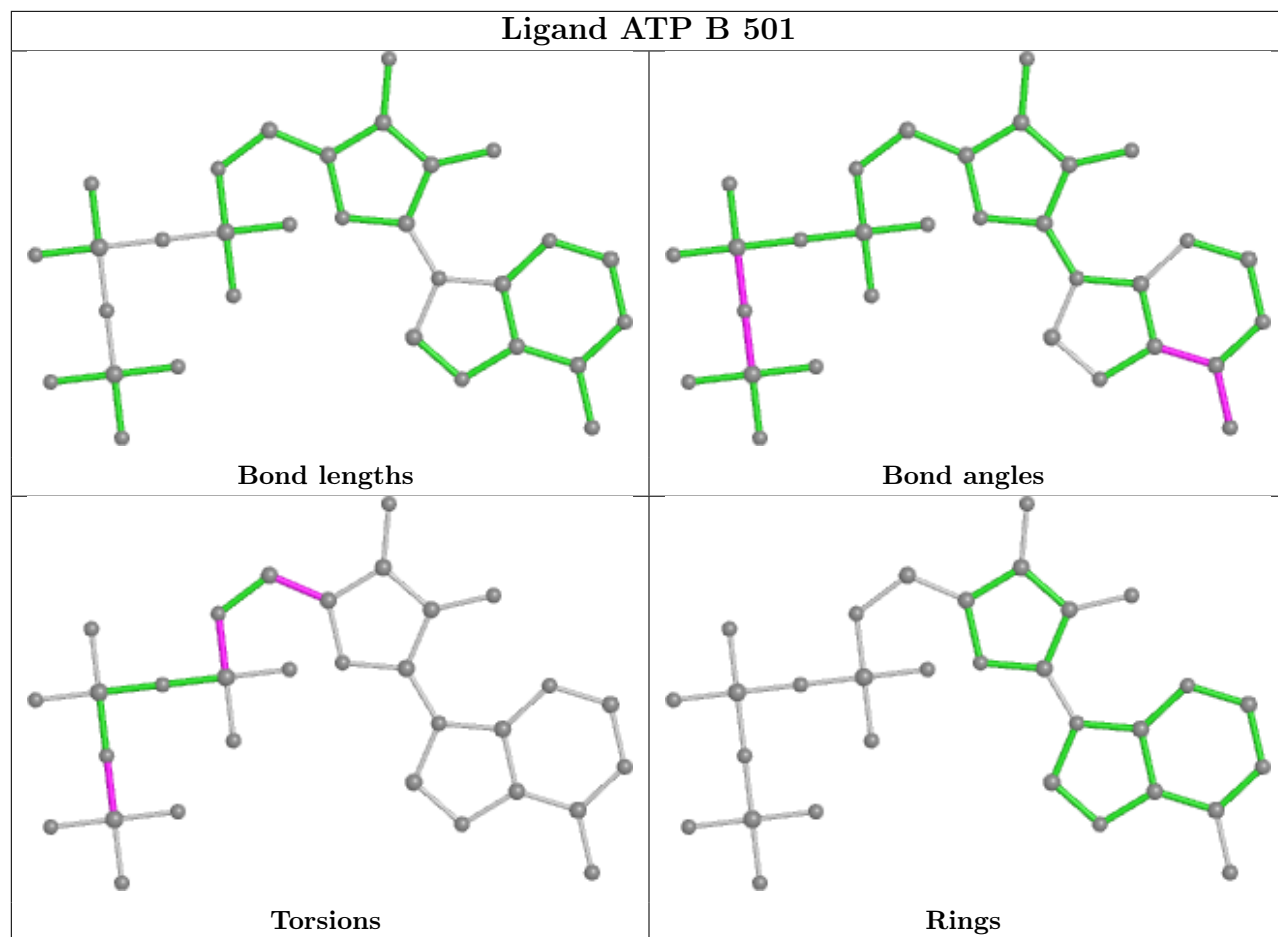

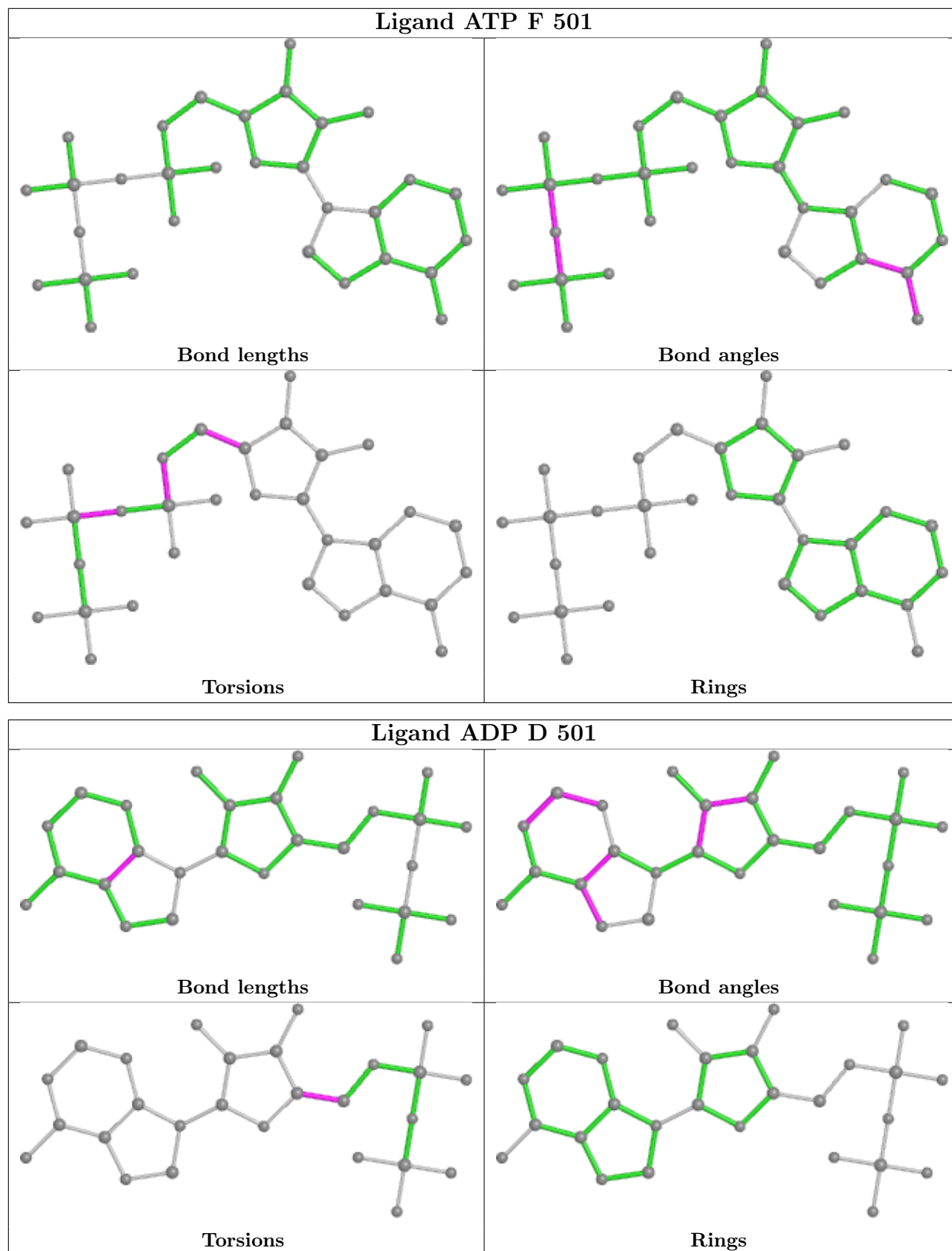

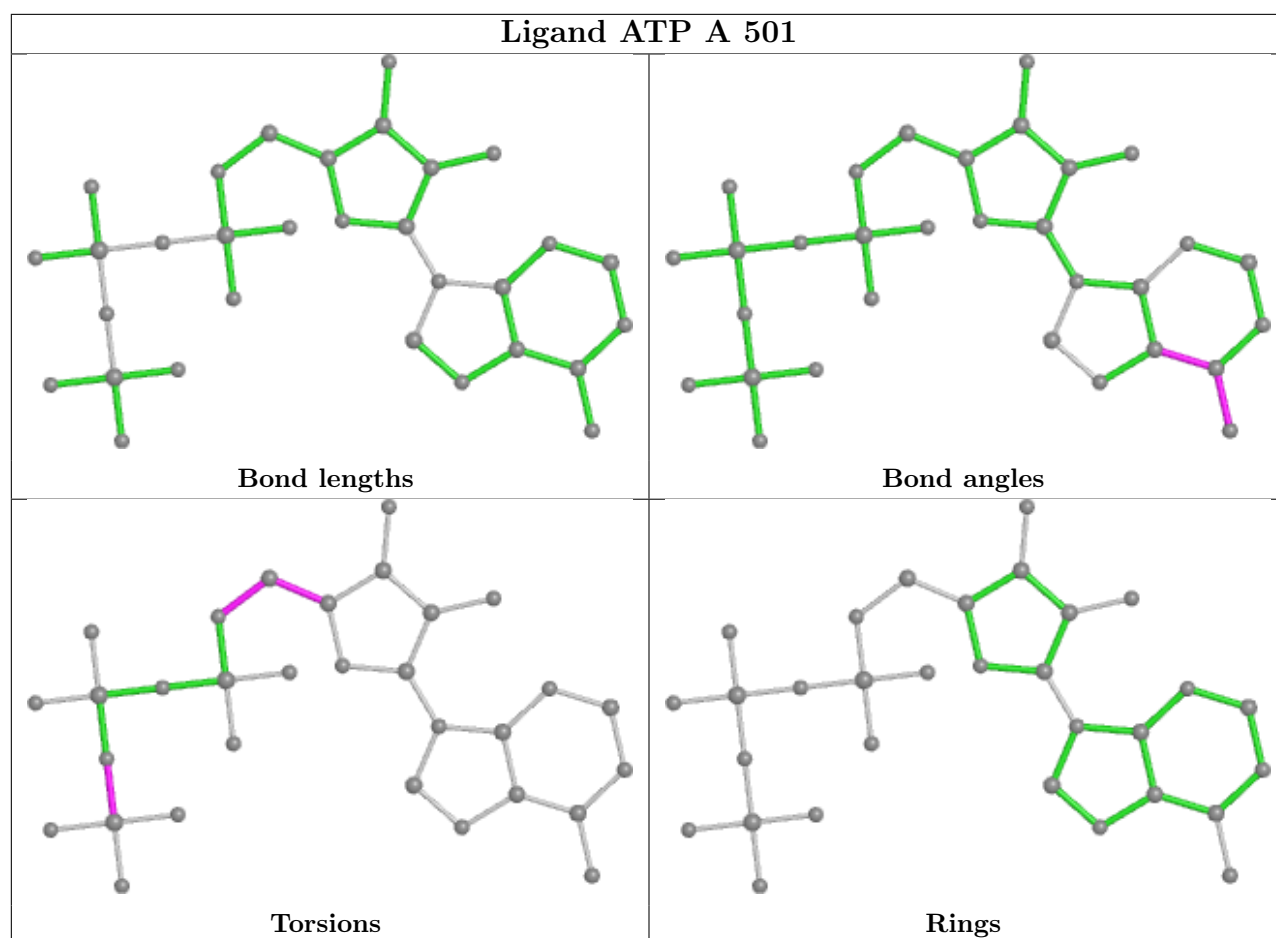

## 5.7 Other polymers [i](#)

There are no such residues in this entry.

## 5.8 Polymer linkage issues [i](#)

There are no chain breaks in this entry.

## 6 Map visualisation [i](#)

This section contains visualisations of the EMDB entry EMD-32279. These allow visual inspection of the internal detail of the map and identification of artifacts.

No raw map or half-maps were deposited for this entry and therefore no images, graphs, etc. pertaining to the raw map can be shown.

### 6.1 Orthogonal projections [i](#)

#### 6.1.1 Primary map

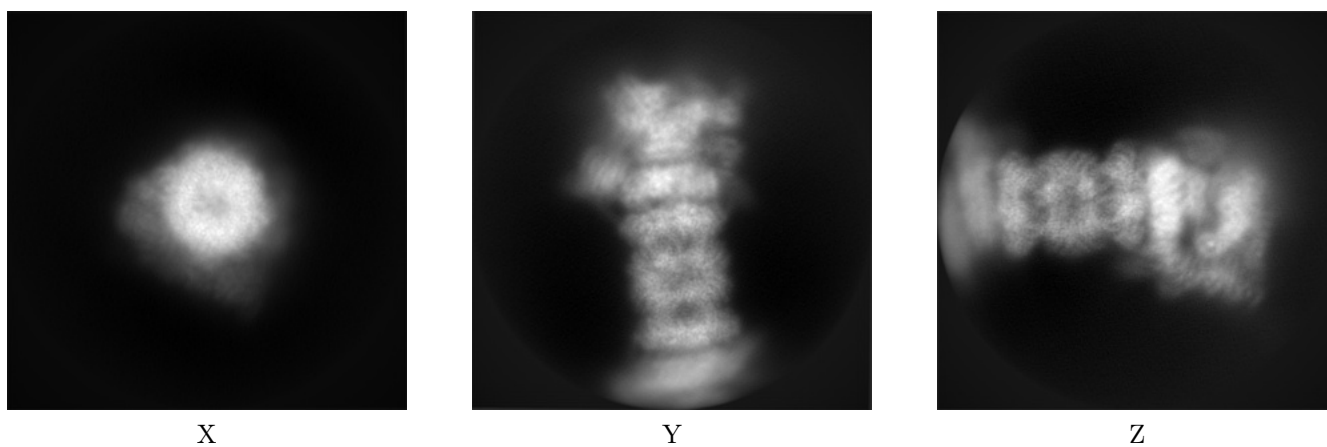

The images above show the map projected in three orthogonal directions.

### 6.2 Central slices [i](#)

#### 6.2.1 Primary map

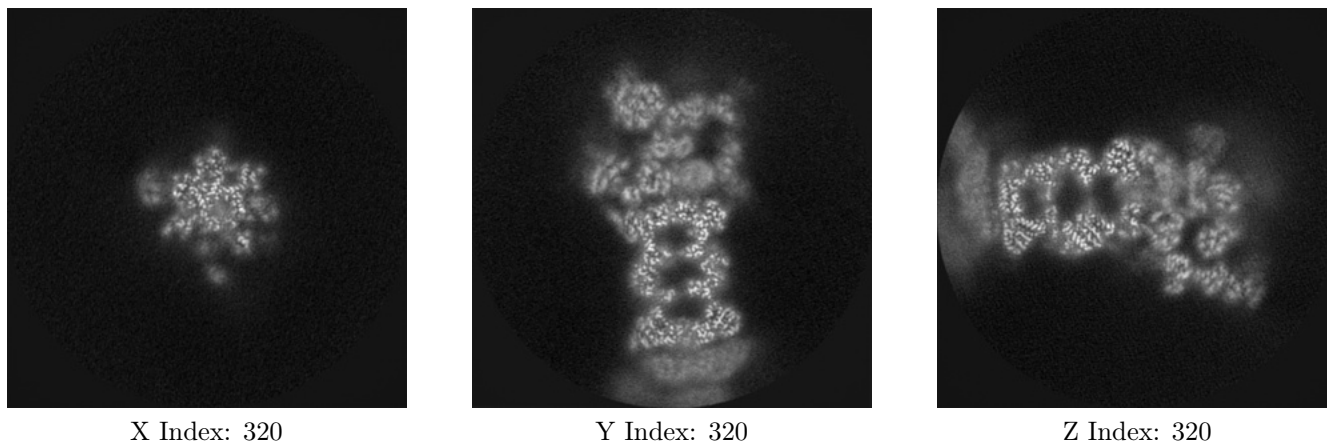

The images above show central slices of the map in three orthogonal directions.

## 6.3 Largest variance slices [i](#)

### 6.3.1 Primary map

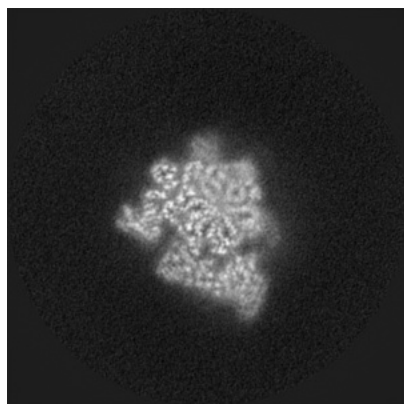

X Index: 367

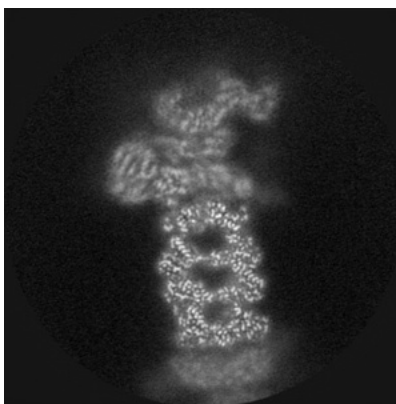

Y Index: 358

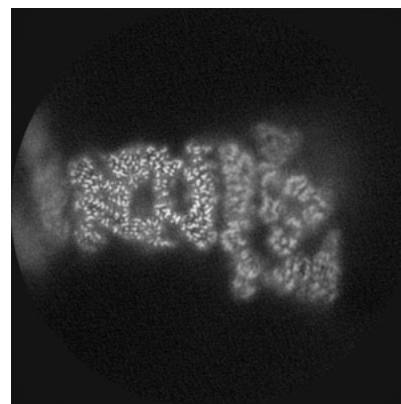

Z Index: 301

The images above show the largest variance slices of the map in three orthogonal directions.

## 6.4 Orthogonal surface views [i](#)

### 6.4.1 Primary map

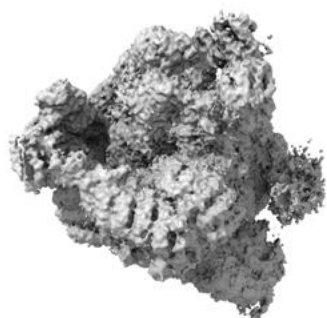

X



Y



Z

The images above show the 3D surface view of the map at the recommended contour level 0.005. These images, in conjunction with the slice images, may facilitate assessment of whether an appropriate contour level has been provided.

## 6.5 Mask visualisation

This section was not generated. No masks/segmentation were deposited.



## 7 Map analysis [i](#)

This section contains the results of statistical analysis of the map.

### 7.1 Map-value distribution [i](#)

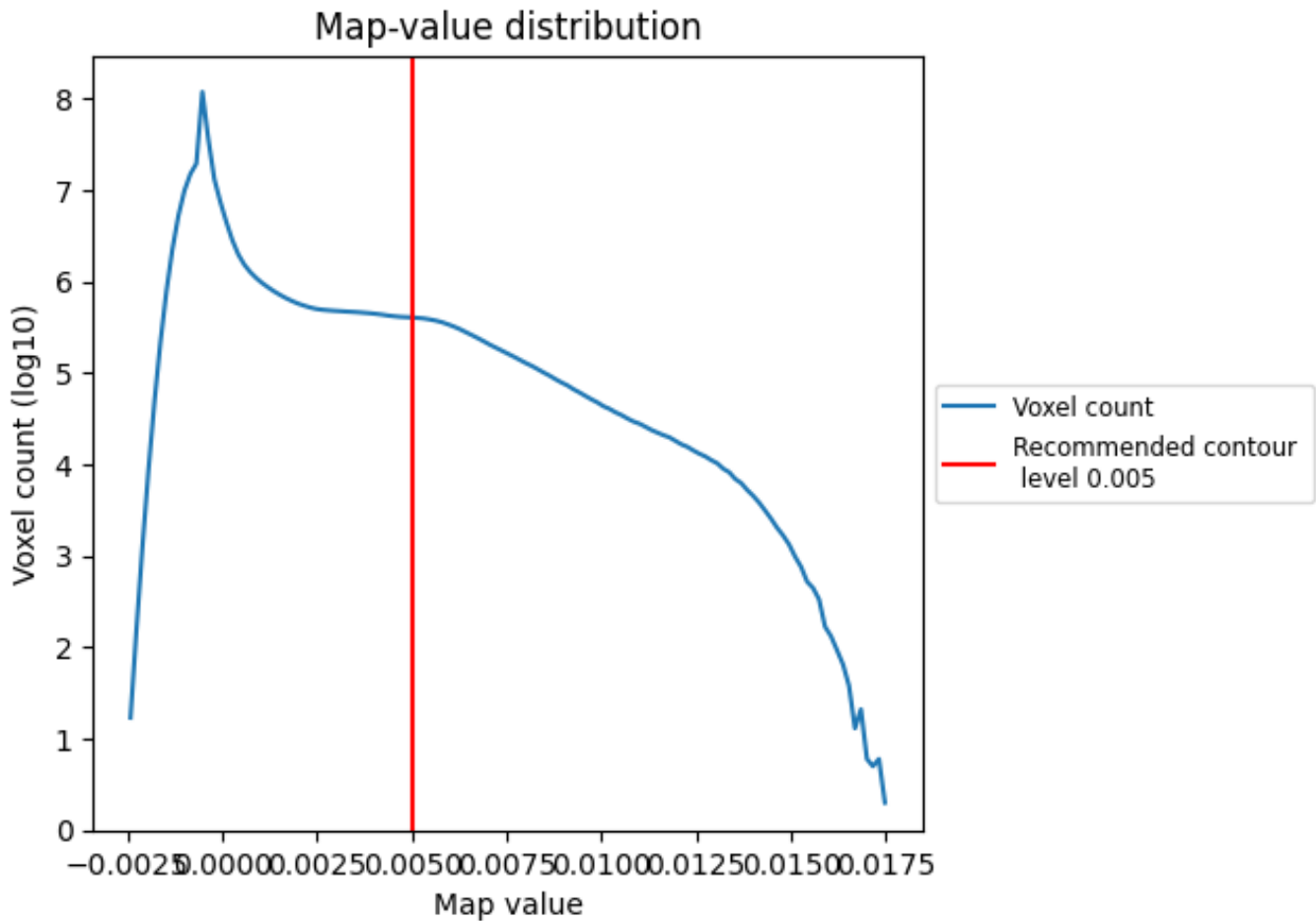

The map-value distribution is plotted in 128 intervals along the x-axis. The y-axis is logarithmic. A spike in this graph at zero usually indicates that the volume has been masked.

## 7.2 Volume estimate [i](#)

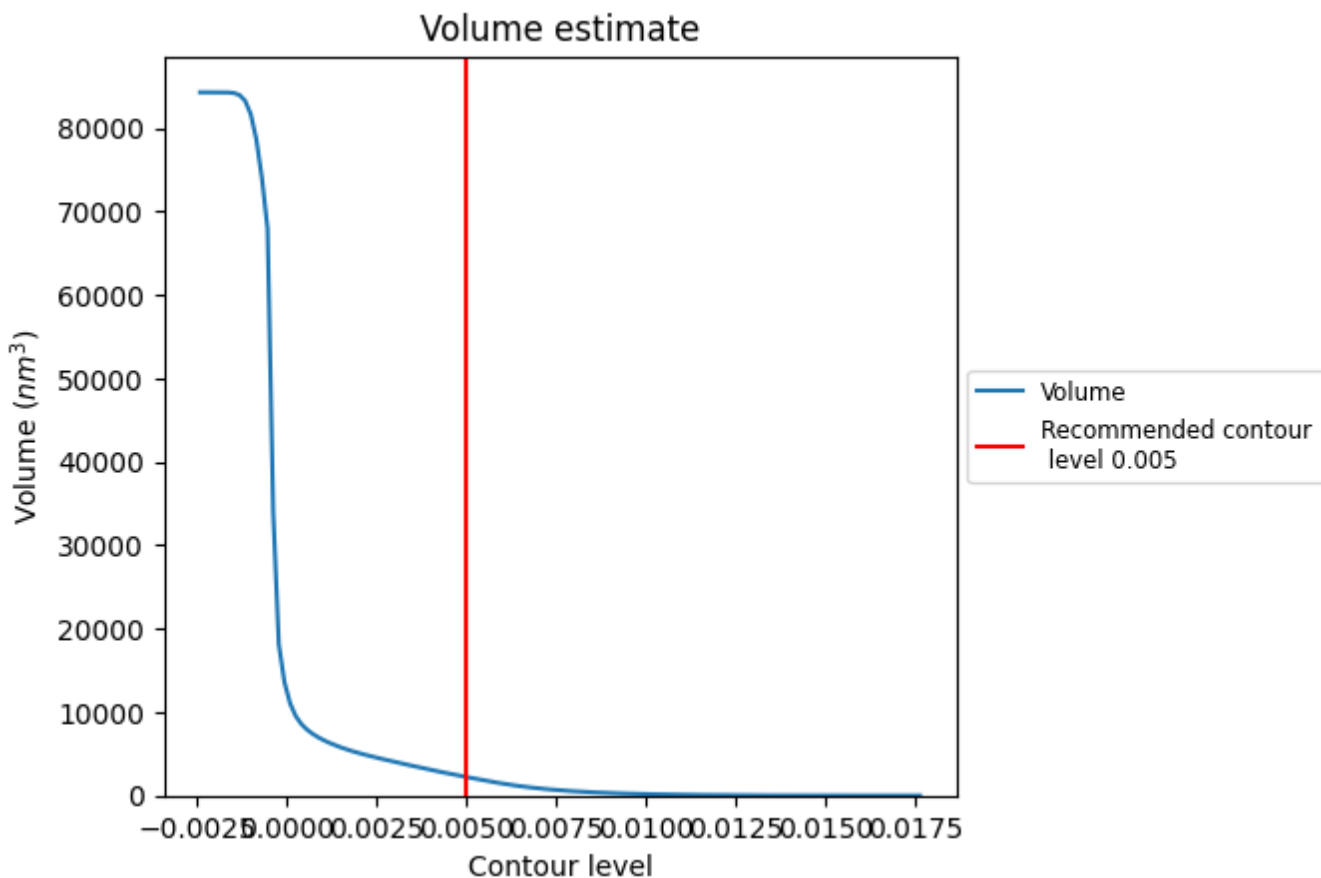

The volume at the recommended contour level is 2224  $\text{nm}^3$ ; this corresponds to an approximate mass of 2009 kDa.

The volume estimate graph shows how the enclosed volume varies with the contour level. The recommended contour level is shown as a vertical line and the intersection between the line and the curve gives the volume of the enclosed surface at the given level.

### 7.3 Rotationally averaged power spectrum [i](#)

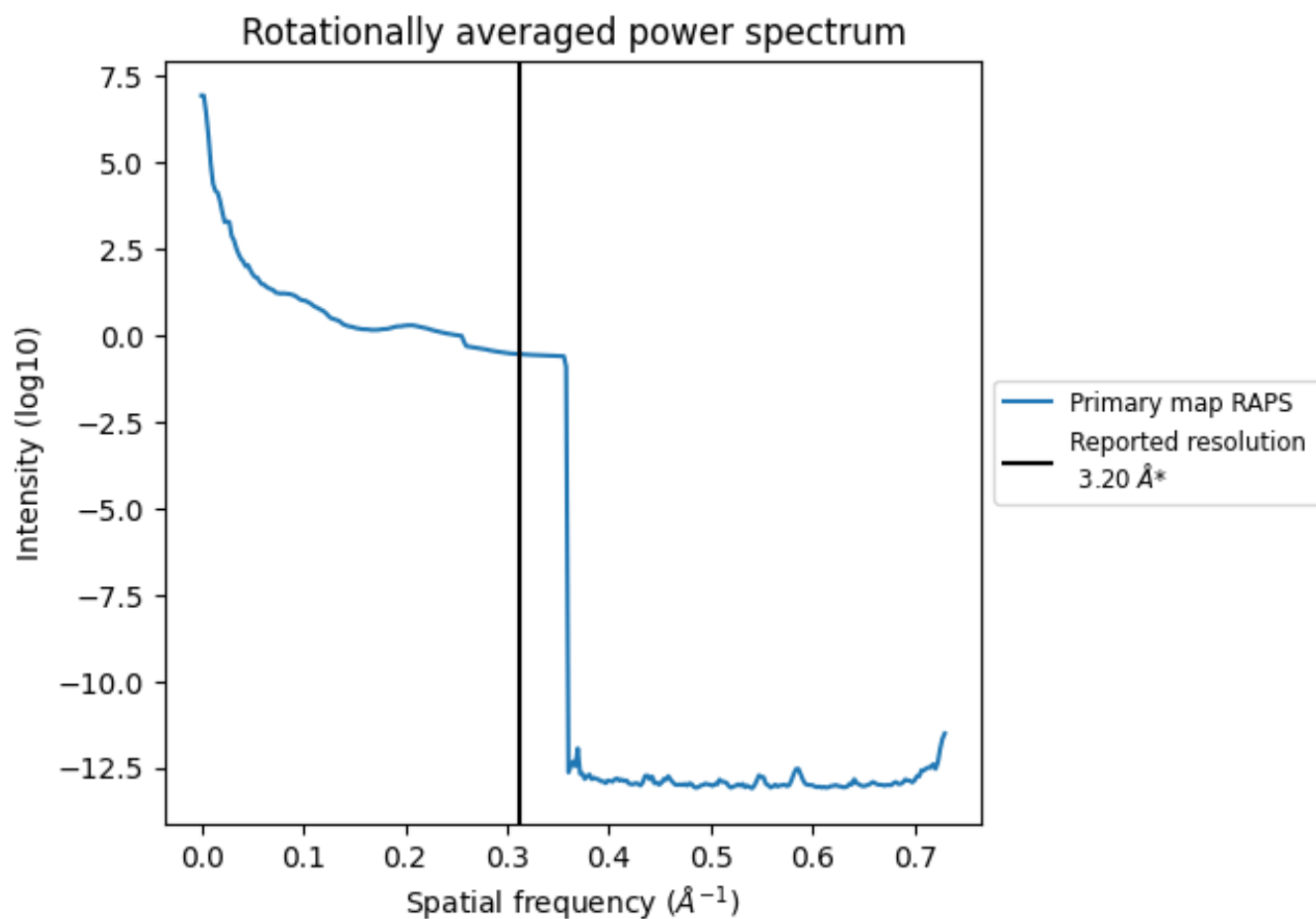

\*Reported resolution corresponds to spatial frequency of  $0.312 \text{ \AA}^{-1}$

## 8 Fourier-Shell correlation

This section was not generated. No FSC curve or half-maps provided.

## 9 Map-model fit [i](#)

This section contains information regarding the fit between EMDB map EMD-32279 and PDB model 7W3G. Per-residue inclusion information can be found in section [3](#) on page [13](#).

### 9.1 Map-model overlay [i](#)

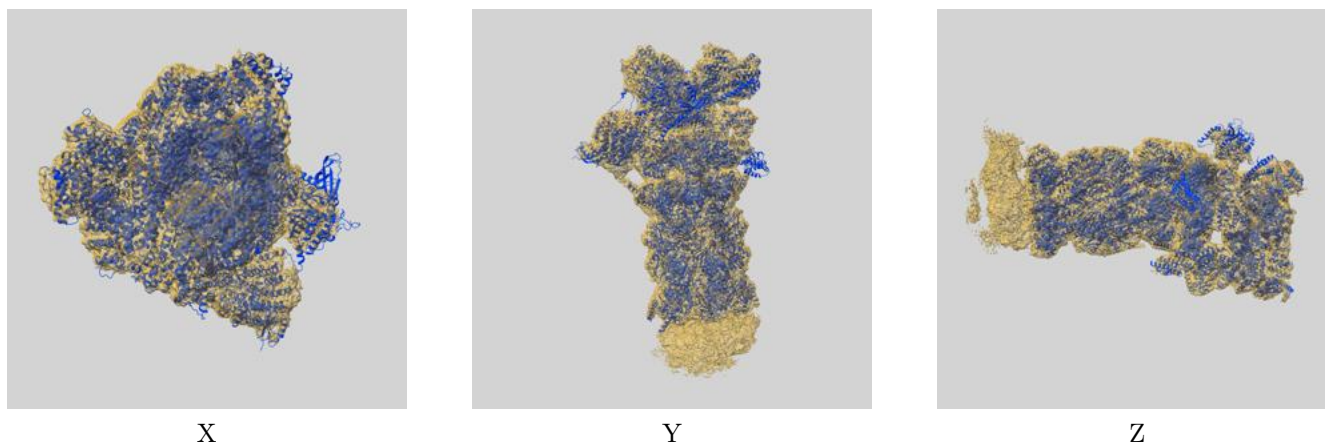

The images above show the 3D surface view of the map at the recommended contour level 0.005 at 50% transparency in yellow overlaid with a ribbon representation of the model coloured in blue. These images allow for the visual assessment of the quality of fit between the atomic model and the map.

## 9.2 Q-score mapped to coordinate model [i](#)

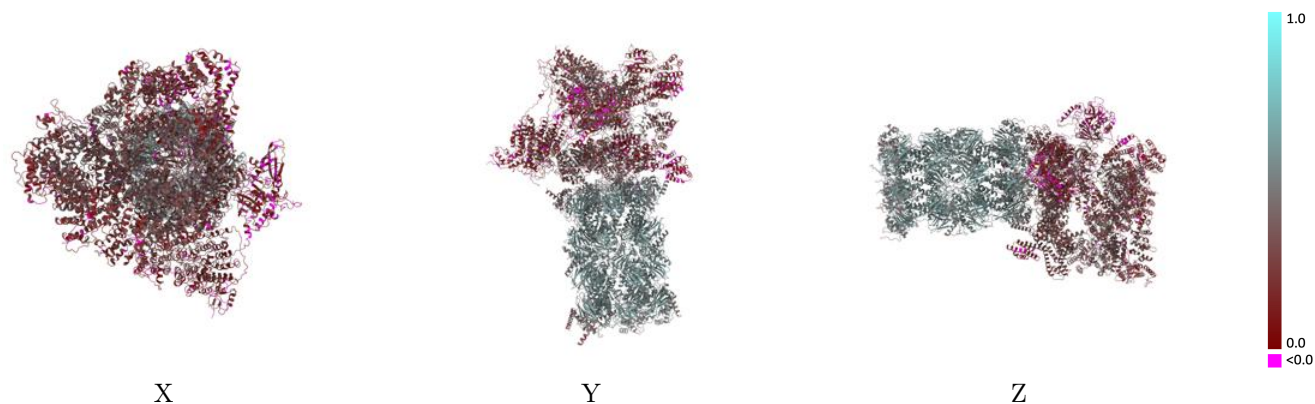

The images above show the model with each residue coloured according to its Q-score. This shows their resolvability in the map with higher Q-score values reflecting better resolvability. Please note: Q-score is calculating the resolvability of atoms, and thus high values are only expected at resolutions at which atoms can be resolved. Low Q-score values may therefore be expected for many entries.

## 9.3 Atom inclusion mapped to coordinate model [i](#)

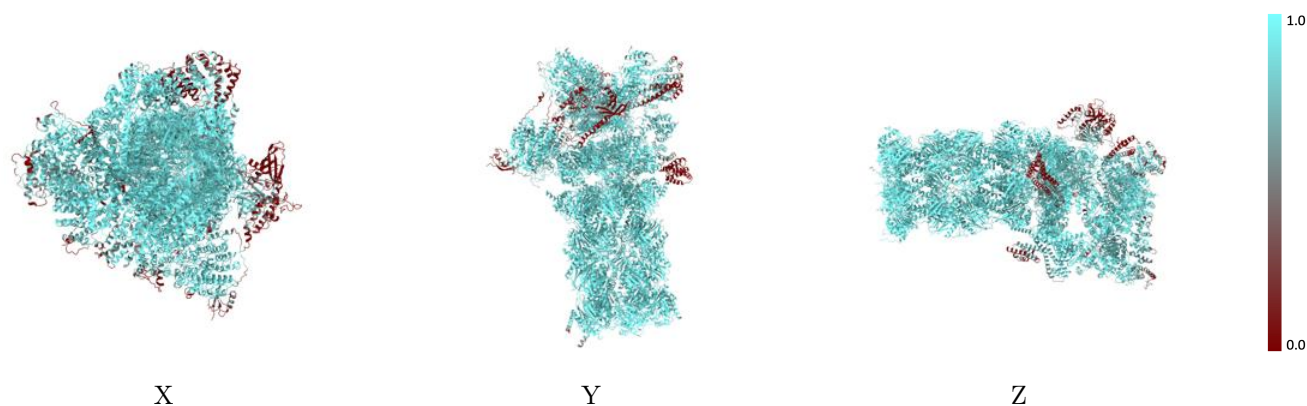

The images above show the model with each residue coloured according to its atom inclusion. This shows to what extent they are inside the map at the recommended contour level (0.005).



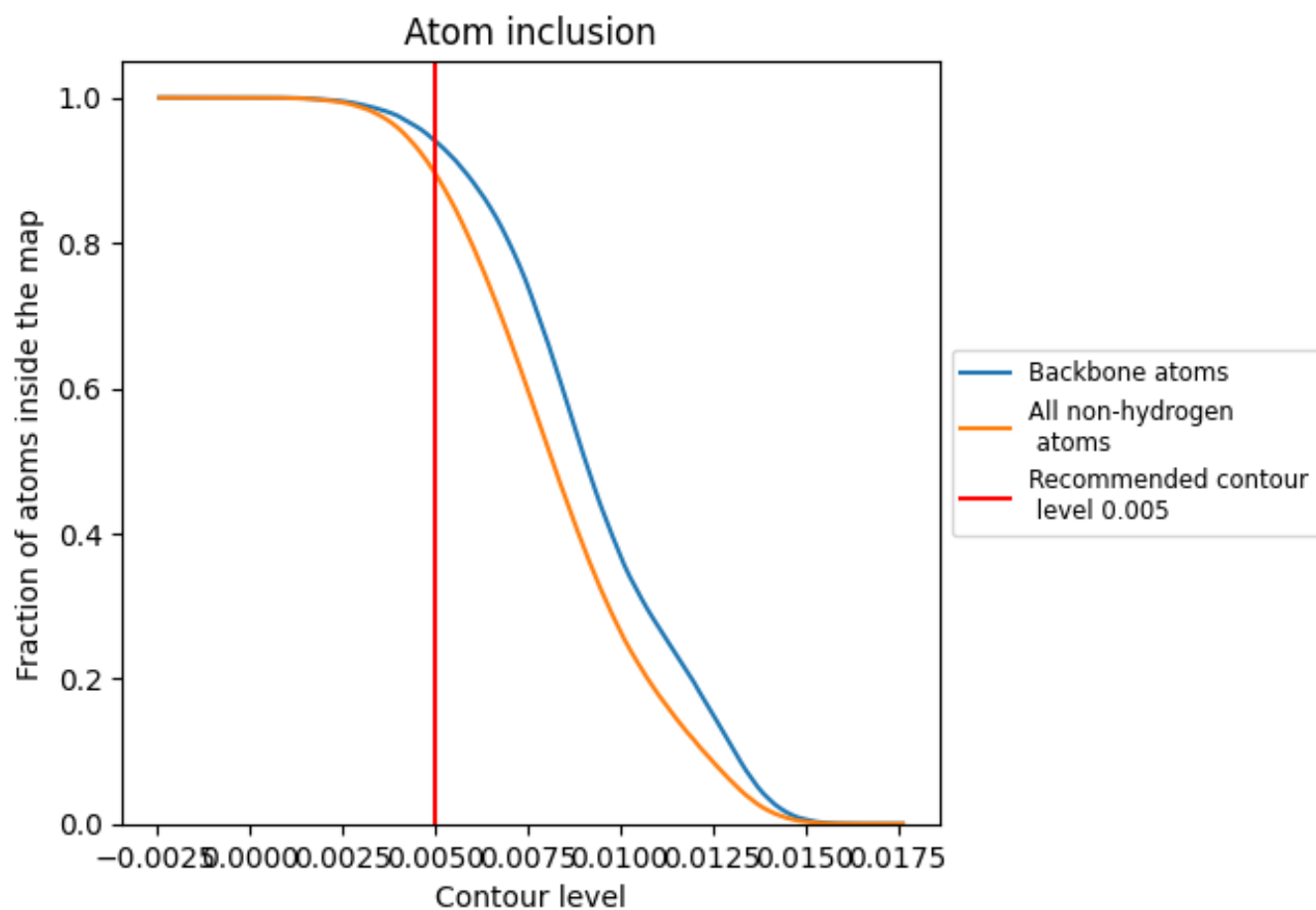



































































## 9.4 Atom inclusion [i](#)



At the recommended contour level, 94% of all backbone atoms, 90% of all non-hydrogen atoms, are inside the map.

## 9.5 Map-model fit summary

The table lists the average atom inclusion at the recommended contour level (0.005) and Q-score for the entire model and for each chain.































Chain	Atom inclusion	Q-score
All	 0.8972	 0.3760
A	 0.9565	 0.2820
B	 0.9520	 0.3130
C	 0.9743	 0.3390
D	 0.9754	 0.3230
E	 0.8615	 0.1750
F	 0.8807	 0.2150
G	 0.9804	 0.5150
H	 0.9932	 0.5220
I	 0.9773	 0.5080
J	 0.9725	 0.4850
K	 0.9744	 0.5030
L	 0.9869	 0.5330
M	 0.9789	 0.5230
N	 0.9805	 0.5510
O	 0.9932	 0.5460
P	 0.9968	 0.5580
Q	 0.9936	 0.5470
R	 0.9901	 0.5480
S	 0.9851	 0.5510
T	 0.9817	 0.5540
U	 0.8700	 0.2830
V	 0.8566	 0.2980
W	 0.6344	 0.2010
X	 0.8454	 0.2960
Y	 0.9304	 0.3150
Z	 0.9600	 0.2980
a	 0.8121	 0.2470
b	 0.8452	 0.2120
c	 0.9364	 0.2970
d	 0.6850	 0.2300
e	 0.8568	 0.2890
f	 0.8616	 0.1970
g	 0.9637	 0.5220
h	 0.9796	 0.5270



*Continued on next page...*



*Continued from previous page...*

Chain	Atom inclusion	Q-score
i	 0.9551	 0.5080
j	 0.9587	 0.4730
k	 0.9723	 0.5200
l	 0.9818	 0.5350
m	 0.9614	 0.5220
n	 0.9851	 0.5560
o	 0.9816	 0.5480
p	 0.9923	 0.5530
q	 0.9942	 0.5510
r	 0.9947	 0.5540
s	 0.9888	 0.5490
t	 0.9811	 0.5550
v	 0.9765	 0.2240
x	 0.3592	 0.1410
y	 0.1250	 0.1620