



# Full wwPDB X-ray Structure Validation Report ⓘ

Nov 9, 2024 – 09:12 AM EST

PDB ID : 5W7E  
Title : Murine acyloxyacyl hydrolase (AOAH), S262A mutant, with dimyristoyl phosphatidylcholine  
Authors : Gorelik, A.; Illes, K.; Nagar, B.  
Deposited on : 2017-06-19  
Resolution : 1.83 Å(reported)

This is a Full wwPDB X-ray Structure Validation Report for a publicly released PDB entry.

We welcome your comments at [validation@mail.wwpdb.org](mailto:validation@mail.wwpdb.org)

A user guide is available at

<https://www.wwpdb.org/validation/2017/XrayValidationReportHelp>

with specific help available everywhere you see the ⓘ symbol.

The types of validation reports are described at

<http://www.wwpdb.org/validation/2017/FAQs#types>.

---

The following versions of software and data (see [references ⓘ](#)) were used in the production of this report:

MolProbity : 4.02b-467  
Mogul : 2022.3.0, CSD as543be (2022)  
Xtrriage (Phenix) : 1.20.1  
EDS : 3.0  
buster-report : 1.1.7 (2018)  
Percentile statistics : 20231227.v01 (using entries in the PDB archive December 27th 2023)  
CCP4 : 9.0.003 (Gargrove)  
Density-Fitness : 1.0.11  
Ideal geometry (proteins) : Engh & Huber (2001)  
Ideal geometry (DNA, RNA) : Parkinson et al. (1996)  
Validation Pipeline (wwPDB-VP) : 2.39

# 1 Overall quality at a glance

The following experimental techniques were used to determine the structure:

*X-RAY DIFFRACTION*

The reported resolution of this entry is 1.83 Å.

Percentile scores (ranging between 0-100) for global validation metrics of the entry are shown in the following graphic. The table shows the number of entries on which the scores are based.

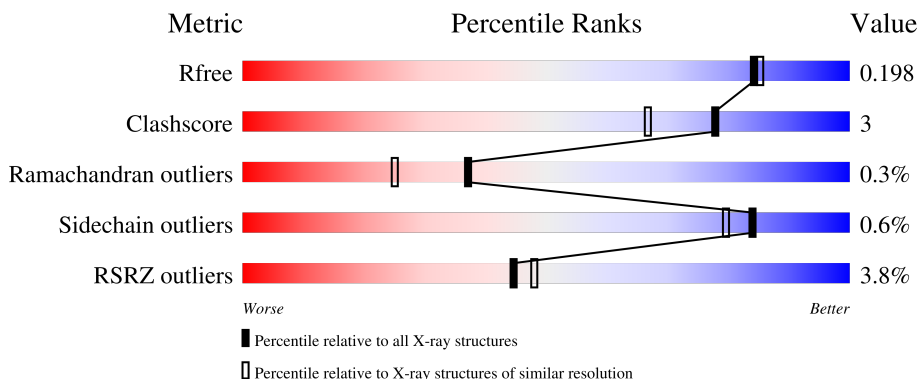

Metric	Whole archive (#Entries)	Similar resolution (#Entries, resolution range(Å))
$R_{free}$	164625	1150 (1.84-1.84)
Clashscore	180529	1248 (1.84-1.84)
Ramachandran outliers	177936	1240 (1.84-1.84)
Sidechain outliers	177891	1240 (1.84-1.84)
RSRZ outliers	164620	1149 (1.84-1.84)

The table below summarises the geometric issues observed across the polymeric chains and their fit to the electron density. The red, orange, yellow and green segments of the lower bar indicate the fraction of residues that contain outliers for  $\geq 3$ , 2, 1 and 0 types of geometric quality criteria respectively. A grey segment represents the fraction of residues that are not modelled. The numeric value for each fraction is indicated below the corresponding segment, with a dot representing fractions  $\leq 5\%$ . The upper red bar (where present) indicates the fraction of residues that have poor fit to the electron density. The numeric value is given above the bar.

Mol	Chain	Length	Quality of chain
1	A	562	
1	B	562	

## 2 Entry composition [i](#)

There are 5 unique types of molecules in this entry. The entry contains 18152 atoms, of which 8544 are hydrogens and 0 are deuteriums.

In the tables below, the ZeroOcc column contains the number of atoms modelled with zero occupancy, the AltConf column contains the number of residues with at least one atom in alternate conformation and the Trace column contains the number of residues modelled with at most 2 atoms.

- Molecule 1 is a protein called Acyloxyacyl hydrolase.

Mol	Chain	Residues	Atoms						ZeroOcc	AltConf	Trace
			Total	C	H	N	O	S			
1	A	521	8382	2699	4144	732	783	24	0	15	0
1	B	526	8531	2740	4224	745	798	24	0	21	0

There are 26 discrepancies between the modelled and reference sequences:

Chain	Residue	Modelled	Actual	Comment	Reference
A	13	ASP	-	expression tag	UNP O35298
A	14	ARG	-	expression tag	UNP O35298
A	15	HIS	-	expression tag	UNP O35298
A	16	HIS	-	expression tag	UNP O35298
A	17	HIS	-	expression tag	UNP O35298
A	18	HIS	-	expression tag	UNP O35298
A	19	HIS	-	expression tag	UNP O35298
A	20	HIS	-	expression tag	UNP O35298
A	21	LYS	-	expression tag	UNP O35298
A	22	LEU	-	expression tag	UNP O35298
A	152	ARG	PRO	conflict	UNP O35298
A	184	VAL	ILE	conflict	UNP O35298
A	262	ALA	SER	engineered mutation	UNP O35298
B	13	ASP	-	expression tag	UNP O35298
B	14	ARG	-	expression tag	UNP O35298
B	15	HIS	-	expression tag	UNP O35298
B	16	HIS	-	expression tag	UNP O35298
B	17	HIS	-	expression tag	UNP O35298
B	18	HIS	-	expression tag	UNP O35298
B	19	HIS	-	expression tag	UNP O35298
B	20	HIS	-	expression tag	UNP O35298
B	21	LYS	-	expression tag	UNP O35298
B	22	LEU	-	expression tag	UNP O35298
B	152	ARG	PRO	conflict	UNP O35298
B	184	VAL	ILE	conflict	UNP O35298

*Continued on next page...*

Continued from previous page...

Chain	Residue	Modelled	Actual	Comment	Reference
B	262	ALA	SER	engineered mutation	UNP O35298

- Molecule 2 is CALCIUM ION (three-letter code: CA) (formula: Ca) (labeled as "Ligand of Interest" by depositor).

Mol	Chain	Residues	Atoms	ZeroOcc	AltConf
2	A	3	Total Ca 3 3	0	0
2	B	3	Total Ca 3 3	0	0

- Molecule 3 is 2-acetamido-2-deoxy-beta-D-glucopyranose (three-letter code: NAG) (formula: C<sub>8</sub>H<sub>15</sub>NO<sub>6</sub>) (labeled as "Ligand of Interest" by depositor).

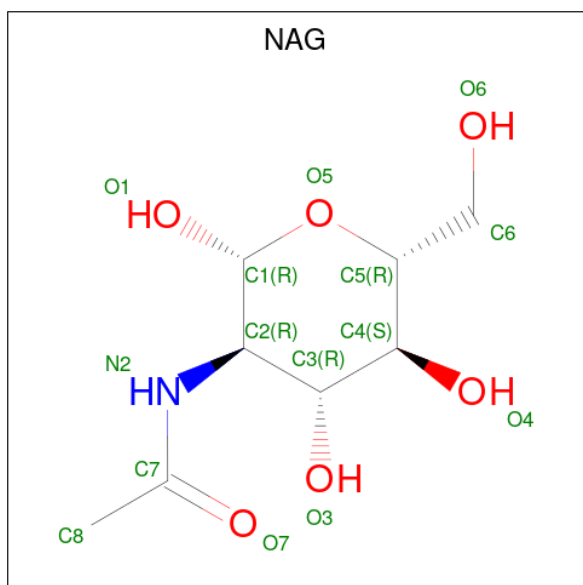

Mol	Chain	Residues	Atoms	ZeroOcc	AltConf
3	A	1	Total C H N O 28 8 14 1 5	0	0
3	A	1	Total C H N O 28 8 14 1 5	0	0
3	B	1	Total C H N O 28 8 14 1 5	0	0
3	B	1	Total C H N O 28 8 14 1 5	0	0

- Molecule 4 is (2S)-3-hydroxypropane-1,2-diyl ditetradecanoate (three-letter code: FAW) (formula: C<sub>31</sub>H<sub>60</sub>O<sub>5</sub>) (labeled as "Ligand of Interest" by depositor).

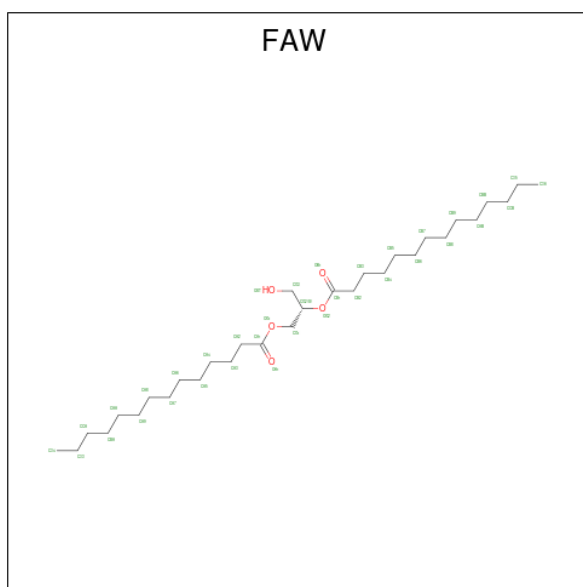

Mol	Chain	Residues	Atoms				ZeroOcc	AltConf
			Total	C	H	O		
4	A	1	96	31	60	5	0	0
4	B	1	96	31	60	5	0	0

- Molecule 5 is water.

Mol	Chain	Residues	Atoms		ZeroOcc	AltConf
			Total	O		
5	A	468	468	468	0	0
5	B	461	461	461	0	0

### 3 Residue-property plots [i](#)

These plots are drawn for all protein, RNA, DNA and oligosaccharide chains in the entry. The first graphic for a chain summarises the proportions of the various outlier classes displayed in the second graphic. The second graphic shows the sequence view annotated by issues in geometry and electron density. Residues are color-coded according to the number of geometric quality criteria for which they contain at least one outlier: green = 0, yellow = 1, orange = 2 and red = 3 or more. A red dot above a residue indicates a poor fit to the electron density ( $RSRZ > 2$ ). Stretches of 2 or more consecutive residues without any outlier are shown as a green connector. Residues present in the sample, but not in the model, are shown in grey.

- Molecule 1: Acyloxyacyl hydrolase

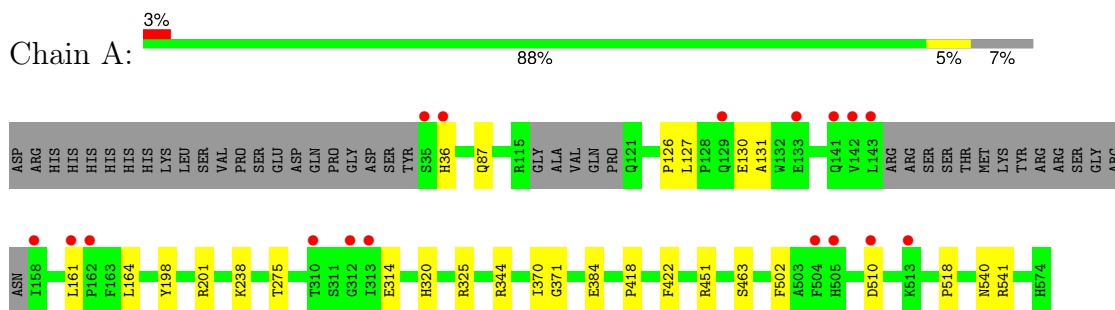

- Molecule 1: Acyloxyacyl hydrolase

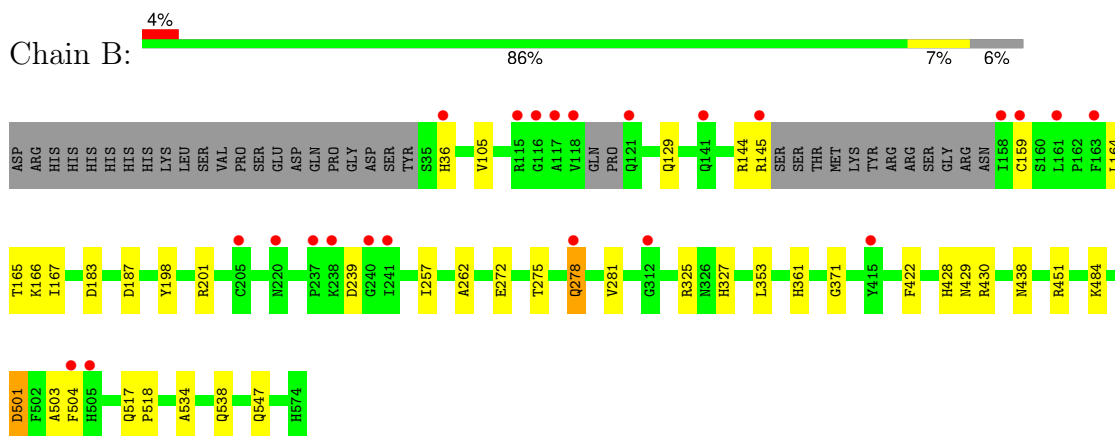

## 4 Data and refinement statistics

Property	Value	Source
Space group	P 1 21 1	Depositor
Cell constants a, b, c, $\alpha$ , $\beta$ , $\gamma$	81.42Å 85.37Å 93.40Å 90.00° 103.64° 90.00°	Depositor
Resolution (Å)	40.07 – 1.83 40.07 – 1.83	Depositor EDS
% Data completeness (in resolution range)	58.9 (40.07-1.83) 83.0 (40.07-1.83)	Depositor EDS
$R_{merge}$	(Not available)	Depositor
$R_{sym}$	(Not available)	Depositor
$\langle I/\sigma(I) \rangle$ <sup>1</sup>	1.99 (at 1.83Å)	Xtrriage
Refinement program	PHENIX (1.10.1_2155)	Depositor
R, $R_{free}$	0.157 , 0.198 0.159 , 0.198	Depositor DCC
$R_{free}$ test set	1948 reflections (2.06%)	wwPDB-VP
Wilson B-factor (Å <sup>2</sup> )	14.4	Xtrriage
Anisotropy	0.173	Xtrriage
Bulk solvent $k_{sol}$ (e/Å <sup>3</sup> ), $B_{sol}$ (Å <sup>2</sup> )	0.42 , 59.5	EDS
L-test for twinning <sup>2</sup>	$\langle  L  \rangle = 0.48$ , $\langle L^2 \rangle = 0.31$	Xtrriage
Estimated twinning fraction	No twinning to report.	Xtrriage
$F_o, F_c$ correlation	0.95	EDS
Total number of atoms	18152	wwPDB-VP
Average B, all atoms (Å <sup>2</sup> )	28.0	wwPDB-VP

Xtrriage's analysis on translational NCS is as follows: *The largest off-origin peak in the Patterson function is 3.89% of the height of the origin peak. No significant pseudotranslation is detected.*

<sup>1</sup>Intensities estimated from amplitudes.

<sup>2</sup>Theoretical values of  $\langle |L| \rangle$ ,  $\langle L^2 \rangle$  for acentric reflections are 0.5, 0.333 respectively for untwinned datasets, and 0.375, 0.2 for perfectly twinned datasets.

## 5 Model quality [i](#)

### 5.1 Standard geometry [i](#)

Bond lengths and bond angles in the following residue types are not validated in this section: NAG, CA, FAW

The Z score for a bond length (or angle) is the number of standard deviations the observed value is removed from the expected value. A bond length (or angle) with  $|Z| > 5$  is considered an outlier worth inspection. RMSZ is the root-mean-square of all Z scores of the bond lengths (or angles).

Mol	Chain	Bond lengths		Bond angles	
		RMSZ	# Z  >5	RMSZ	# Z  >5
1	A	0.42	0/4392	0.56	0/5957
1	B	0.43	0/4482	0.59	2/6079 (0.0%)
All	All	0.42	0/8874	0.58	2/12036 (0.0%)

There are no bond length outliers.

All (2) bond angle outliers are listed below:

Mol	Chain	Res	Type	Atoms	Z	Observed(°)	Ideal(°)
1	B	187	ASP	CB-CG-OD1	5.86	123.58	118.30
1	B	187	ASP	CB-CG-OD2	-5.40	113.44	118.30

There are no chirality outliers.

There are no planarity outliers.

### 5.2 Too-close contacts [i](#)

In the following table, the Non-H and H(model) columns list the number of non-hydrogen atoms and hydrogen atoms in the chain respectively. The H(added) column lists the number of hydrogen atoms added and optimized by MolProbity. The Clashes column lists the number of clashes within the asymmetric unit, whereas Symm-Clashes lists symmetry-related clashes.

Mol	Chain	Non-H	H(model)	H(added)	Clashes	Symm-Clashes
1	A	4238	4144	4153	20	1
1	B	4307	4224	4230	26	1
2	A	3	0	0	0	0
2	B	3	0	0	0	0
3	A	28	28	26	0	0
3	B	28	28	26	0	0
4	A	36	60	0	0	0

*Continued on next page...*



*Continued from previous page...*

Mol	Chain	Non-H	H(model)	H(added)	Clashes	Symm-Clashes
4	B	36	60	0	2	0
5	A	468	0	0	10	5
5	B	461	0	0	11	5
All	All	9608	8544	8435	46	6

The all-atom clashscore is defined as the number of clashes found per 1000 atoms (including hydrogen atoms). The all-atom clashscore for this structure is 3.

All (46) close contacts within the same asymmetric unit are listed below, sorted by their clash magnitude.

Atom-1	Atom-2	Interatomic distance (Å)	Clash overlap (Å)
1:A:314:GLU:OE1	5:A:701:HOH:O	2.00	0.78
1:B:325:ARG:NH2	1:B:547:GLN:OE1	2.18	0.76
1:A:130:GLU:OE2	5:A:702:HOH:O	2.04	0.75
1:A:87:GLN:OE1	5:A:703:HOH:O	2.08	0.71
1:B:438:ASN:OD1	5:B:701:HOH:O	2.09	0.70
1:A:422:PHE:HE1	1:A:518:PRO:HB3	1.65	0.61
1:B:451[A]:ARG:NE	5:B:706:HOH:O	2.29	0.58
1:B:278:GLN:NE2	1:B:278:GLN:O	2.37	0.58
1:A:344:ARG:NH2	1:A:384:GLU:O	2.38	0.57
1:B:275[B]:THR:HG21	5:B:944:HOH:O	2.06	0.54
1:A:510:ASP:OD2	1:A:541:ARG:NH2	2.38	0.54
1:B:144:ARG:O	1:B:145:ARG:HB2	2.08	0.54
1:B:257:ILE:HD13	1:B:353:LEU:HD21	1.93	0.51
1:B:361:HIS:HD2	5:B:1097:HOH:O	1.94	0.50
1:A:422:PHE:CE1	1:A:518:PRO:HB3	2.45	0.50
1:A:126:PRO:HG3	5:A:1067:HOH:O	2.13	0.49
1:B:429[A]:ASN:ND2	5:B:702:HOH:O	2.19	0.48
1:B:159:CYS:O	1:B:165:THR:HG22	2.13	0.48
1:B:451[A]:ARG:NH2	5:B:706:HOH:O	2.45	0.48
1:A:325:ARG:NH1	5:A:720:HOH:O	2.47	0.48
1:B:105[A]:VAL:HG23	5:B:920:HOH:O	2.17	0.45
1:A:418:PRO:HB3	1:A:502:PHE:CD2	2.52	0.45
1:A:275[A]:THR:HG21	5:A:947:HOH:O	2.16	0.45
1:B:262:ALA:HB3	4:B:606:FAW:CA1	2.47	0.44
1:A:127:LEU:HG	1:A:131:ALA:HB3	1.98	0.44
1:A:198:TYR:HA	1:A:201:ARG:O	2.16	0.44
1:A:161:LEU:HD12	1:A:164:LEU:HD12	2.00	0.44
1:A:451:ARG:HD3	5:A:1055:HOH:O	2.18	0.44
1:B:517:GLN:HG3	5:B:830:HOH:O	2.17	0.43
1:B:164:LEU:O	1:B:167:ILE:HG22	2.18	0.43

*Continued on next page...*

Continued from previous page...

Atom-1	Atom-2	Interatomic distance (Å)	Clash overlap (Å)
1:A:370:ILE:O	1:A:418:PRO:HD2	2.18	0.43
1:A:540:ASN:HB2	5:A:708:HOH:O	2.19	0.43
1:B:281:VAL:HG23	5:B:875:HOH:O	2.18	0.42
1:B:430:ARG:HD2	5:B:711:HOH:O	2.18	0.42
1:B:484:LYS:NZ	5:B:715:HOH:O	2.40	0.42
1:A:422:PHE:HE1	1:A:518:PRO:CB	2.30	0.41
1:B:534:ALA:O	1:B:538[B]:GLN:HG3	2.21	0.41
1:B:422:PHE:CE1	1:B:518:PRO:HB3	2.55	0.41
1:B:198:TYR:HA	1:B:201:ARG:O	2.21	0.41
1:B:428:HIS:NE2	1:B:429[A]:ASN:OD1	2.54	0.41
1:B:504:PHE:CE2	4:B:606:FAW:C33	3.04	0.40
1:B:272:GLU:HA	1:B:278:GLN:NE2	2.36	0.40
1:B:501:ASP:OD2	1:B:503:ALA:HB2	2.21	0.40
1:A:320[B]:HIS:HD2	5:A:905:HOH:O	2.05	0.40
1:A:451:ARG:NH2	1:A:463:SER:HB2	2.36	0.40
5:A:789:HOH:O	1:B:166:LYS:HE2	2.21	0.40

All (6) symmetry-related close contacts are listed below. The label for Atom-2 includes the symmetry operator and encoded unit-cell translations to be applied.

Atom-1	Atom-2	Interatomic distance (Å)	Clash overlap (Å)
5:A:1067:HOH:O	5:B:776:HOH:O[1_655]	1.98	0.22
5:A:1108:HOH:O	5:B:1077:HOH:O[1_655]	2.01	0.19
5:A:1115:HOH:O	5:B:1118:HOH:O[2_454]	2.06	0.14
1:A:238:LYS:HZ1	1:B:239:ASP:O[1_556]	1.48	0.12
5:A:987:HOH:O	5:B:1081:HOH:O[2_454]	2.10	0.10
5:A:1029:HOH:O	5:B:712:HOH:O[1_655]	2.13	0.07

## 5.3 Torsion angles [i](#)

### 5.3.1 Protein backbone [i](#)

In the following table, the Percentiles column shows the percent Ramachandran outliers of the chain as a percentile score with respect to all X-ray entries followed by that with respect to entries of similar resolution.

The Analysed column shows the number of residues for which the backbone conformation was analysed, and the total number of residues.

Mol	Chain	Analysed	Favoured	Allowed	Outliers	Percentiles	
1	A	530/562 (94%)	517 (98%)	12 (2%)	1 (0%)	44	33
1	B	542/562 (96%)	529 (98%)	11 (2%)	2 (0%)	30	18
All	All	1072/1124 (95%)	1046 (98%)	23 (2%)	3 (0%)	37	25

All (3) Ramachandran outliers are listed below:

Mol	Chain	Res	Type
1	A	371	GLY
1	B	371	GLY
1	B	183	ASP

### 5.3.2 Protein sidechains [i](#)

In the following table, the Percentiles column shows the percent sidechain outliers of the chain as a percentile score with respect to all X-ray entries followed by that with respect to entries of similar resolution.

The Analysed column shows the number of residues for which the sidechain conformation was analysed, and the total number of residues.

Mol	Chain	Analysed	Rotameric	Outliers	Percentiles	
1	A	478/500 (96%)	477 (100%)	1 (0%)	92	91
1	B	488/500 (98%)	483 (99%)	5 (1%)	73	64
All	All	966/1000 (97%)	960 (99%)	6 (1%)	84	79

All (6) residues with a non-rotameric sidechain are listed below:

Mol	Chain	Res	Type
1	A	36	HIS
1	B	36	HIS
1	B	129	GLN
1	B	278	GLN
1	B	327	HIS
1	B	501	ASP

Sometimes sidechains can be flipped to improve hydrogen bonding and reduce clashes. All (2) such sidechains are listed below:

Mol	Chain	Res	Type
1	B	278	GLN
1	B	438	ASN

### 5.3.3 RNA [i](#)

There are no RNA molecules in this entry.

## 5.4 Non-standard residues in protein, DNA, RNA chains [i](#)

There are no non-standard protein/DNA/RNA residues in this entry.

## 5.5 Carbohydrates [i](#)

There are no oligosaccharides in this entry.

## 5.6 Ligand geometry [i](#)

Of 12 ligands modelled in this entry, 6 are monoatomic - leaving 6 for Mogul analysis.

In the following table, the Counts columns list the number of bonds (or angles) for which Mogul statistics could be retrieved, the number of bonds (or angles) that are observed in the model and the number of bonds (or angles) that are defined in the Chemical Component Dictionary. The Link column lists molecule types, if any, to which the group is linked. The Z score for a bond length (or angle) is the number of standard deviations the observed value is removed from the expected value. A bond length (or angle) with  $|Z| > 2$  is considered an outlier worth inspection. RMSZ is the root-mean-square of all Z scores of the bond lengths (or angles).

Mol	Type	Chain	Res	Link	Bond lengths			Bond angles		
					Counts	RMSZ	# Z  > 2	Counts	RMSZ	# Z  > 2
3	NAG	B	604	1	14,14,15	0.26	0	17,19,21	0.85	1 (5%)
3	NAG	A	604	1	14,14,15	0.33	0	17,19,21	0.54	0
3	NAG	B	605	1	14,14,15	0.24	0	17,19,21	0.36	0
3	NAG	A	605	1	14,14,15	0.35	0	17,19,21	0.87	1 (5%)
4	FAW	B	606	-	35,35,35	0.88	4 (11%)	37,37,37	1.21	3 (8%)
4	FAW	A	606	-	35,35,35	0.92	4 (11%)	37,37,37	1.24	4 (10%)

In the following table, the Chirals column lists the number of chiral outliers, the number of chiral centers analysed, the number of these observed in the model and the number defined in the Chemical Component Dictionary. Similar counts are reported in the Torsion and Rings columns. '-' means no outliers of that kind were identified.

Mol	Type	Chain	Res	Link	Chirals	Torsions	Rings
3	NAG	B	604	1	-	0/6/23/26	0/1/1/1
3	NAG	A	604	1	-	0/6/23/26	0/1/1/1
3	NAG	B	605	1	-	2/6/23/26	0/1/1/1

*Continued on next page...*

*Continued from previous page...*

Mol	Type	Chain	Res	Link	Chirals	Torsions	Rings
3	NAG	A	605	1	-	2/6/23/26	0/1/1/1
4	FAW	B	606	-	-	11/37/37/37	-
4	FAW	A	606	-	-	17/37/37/37	-

All (8) bond length outliers are listed below:

Mol	Chain	Res	Type	Atoms	Z	Observed(Å)	Ideal(Å)
4	A	606	FAW	OG1-CG1	-2.51	1.39	1.45
4	B	606	FAW	OG1-CA1	2.37	1.40	1.33
4	B	606	FAW	OG2-CG2	-2.37	1.41	1.46
4	A	606	FAW	OG2-CG2	-2.33	1.41	1.46
4	A	606	FAW	OG2-CB1	2.33	1.40	1.34
4	B	606	FAW	OG2-CB1	2.22	1.40	1.34
4	A	606	FAW	OG1-CA1	2.19	1.39	1.33
4	B	606	FAW	OG1-CG1	-2.15	1.40	1.45

All (9) bond angle outliers are listed below:

Mol	Chain	Res	Type	Atoms	Z	Observed(°)	Ideal(°)
4	B	606	FAW	OG2-CB1-CB2	4.84	121.95	111.48
4	A	606	FAW	OG2-CB1-CB2	4.66	121.57	111.48
3	B	604	NAG	C1-O5-C5	2.90	116.08	112.19
4	A	606	FAW	OG1-CA1-CA2	2.60	119.78	111.83
4	B	606	FAW	CG2-OG2-CB1	-2.52	111.77	117.80
3	A	605	NAG	C1-O5-C5	2.47	115.50	112.19
4	A	606	FAW	CG1-OG1-CA1	-2.19	109.11	117.12
4	B	606	FAW	OG2-CB1-OB1	-2.04	118.93	123.70
4	A	606	FAW	OG2-CB1-OB1	-2.01	119.01	123.70

There are no chirality outliers.

All (32) torsion outliers are listed below:

Mol	Chain	Res	Type	Atoms
4	A	606	FAW	OG2-CG2-CG3-OXT
4	A	606	FAW	CB2-CB1-OG2-CG2
4	B	606	FAW	CB2-CB1-OG2-CG2
4	A	606	FAW	OB1-CB1-OG2-CG2
4	B	606	FAW	OB1-CB1-OG2-CG2
4	A	606	FAW	CA2-CA1-OG1-CG1
4	A	606	FAW	OA1-CA1-OG1-CG1

*Continued on next page...*

*Continued from previous page...*

Mol	Chain	Res	Type	Atoms
3	A	605	NAG	C4-C5-C6-O6
4	A	606	FAW	CA2-CA3-CA4-CA5
4	A	606	FAW	CBB-CAB-CB9-CB8
4	B	606	FAW	CB4-CB5-CB6-CB7
4	A	606	FAW	CB3-CB4-CB5-CB6
4	B	606	FAW	CAB-CBB-CCB-C35
4	B	606	FAW	OG1-CG1-CG2-CG3
4	A	606	FAW	CB7-CB8-CB9-CAB
4	A	606	FAW	CAB-CBB-CCB-C35
4	A	606	FAW	CAA-CBA-CCA-C33
4	B	606	FAW	CBB-CAB-CB9-CB8
4	B	606	FAW	CB3-CB4-CB5-CB6
3	B	605	NAG	C4-C5-C6-O6
3	B	605	NAG	O5-C5-C6-O6
3	A	605	NAG	O5-C5-C6-O6
4	A	606	FAW	CG1-CG2-CG3-OXT
4	A	606	FAW	CA8-CA9-CAA-CBA
4	A	606	FAW	CB9-CAB-CBB-CCB
4	A	606	FAW	CB5-CB6-CB7-CB8
4	B	606	FAW	OG1-CG1-CG2-OG2
4	A	606	FAW	CG3-CG2-OG2-CB1
4	B	606	FAW	CA6-CA7-CA8-CA9
4	A	606	FAW	CA9-CAA-CBA-CCA
4	B	606	FAW	C36-C35-CCB-CBB
4	B	606	FAW	C34-C33-CCA-CBA

There are no ring outliers.

1 monomer is involved in 2 short contacts:

Mol	Chain	Res	Type	Clashes	Symm-Clashes
4	B	606	FAW	2	0

The following is a two-dimensional graphical depiction of Mogul quality analysis of bond lengths, bond angles, torsion angles, and ring geometry for all instances of the Ligand of Interest. In addition, ligands with molecular weight > 250 and outliers as shown on the validation Tables will also be included. For torsion angles, if less than 5% of the Mogul distribution of torsion angles is within 10 degrees of the torsion angle in question, then that torsion angle is considered an outlier. Any bond that is central to one or more torsion angles identified as an outlier by Mogul will be highlighted in the graph. For rings, the root-mean-square deviation (RMSD) between the ring in question and similar rings identified by Mogul is calculated over all ring torsion angles. If the average RMSD is greater than 60 degrees and the minimal RMSD between the ring in question and any Mogul-identified rings is also greater than 60 degrees, then that ring is considered an outlier.

The outliers are highlighted in purple. The color gray indicates Mogul did not find sufficient equivalents in the CSD to analyse the geometry.

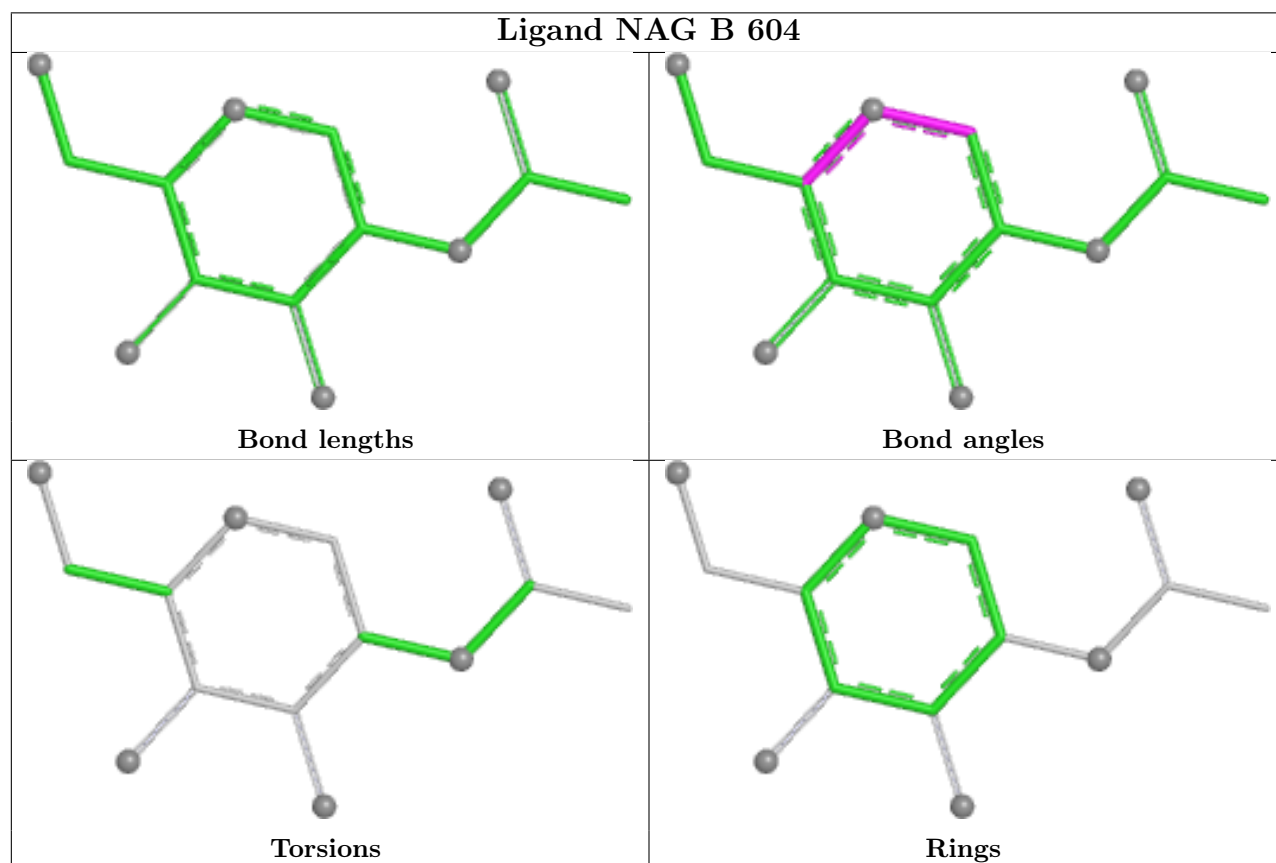

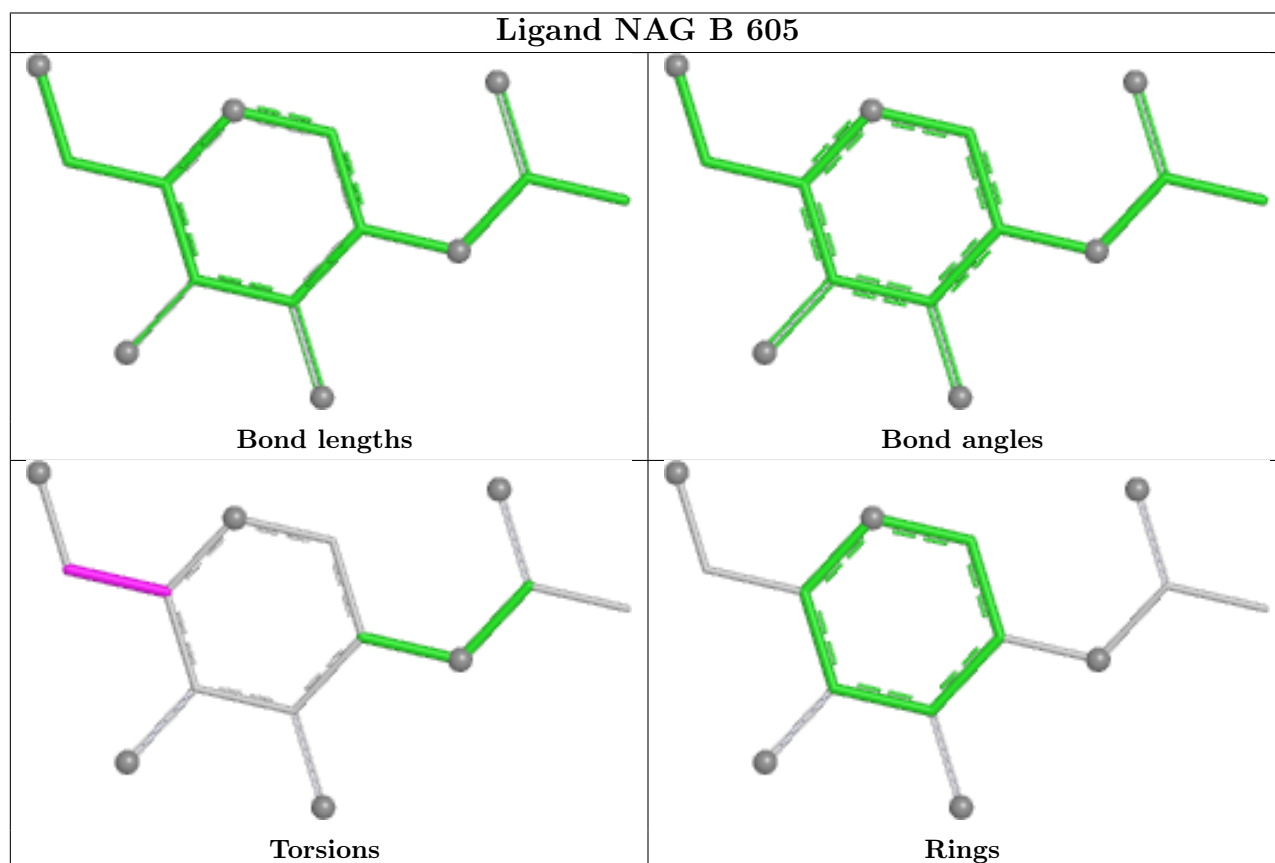
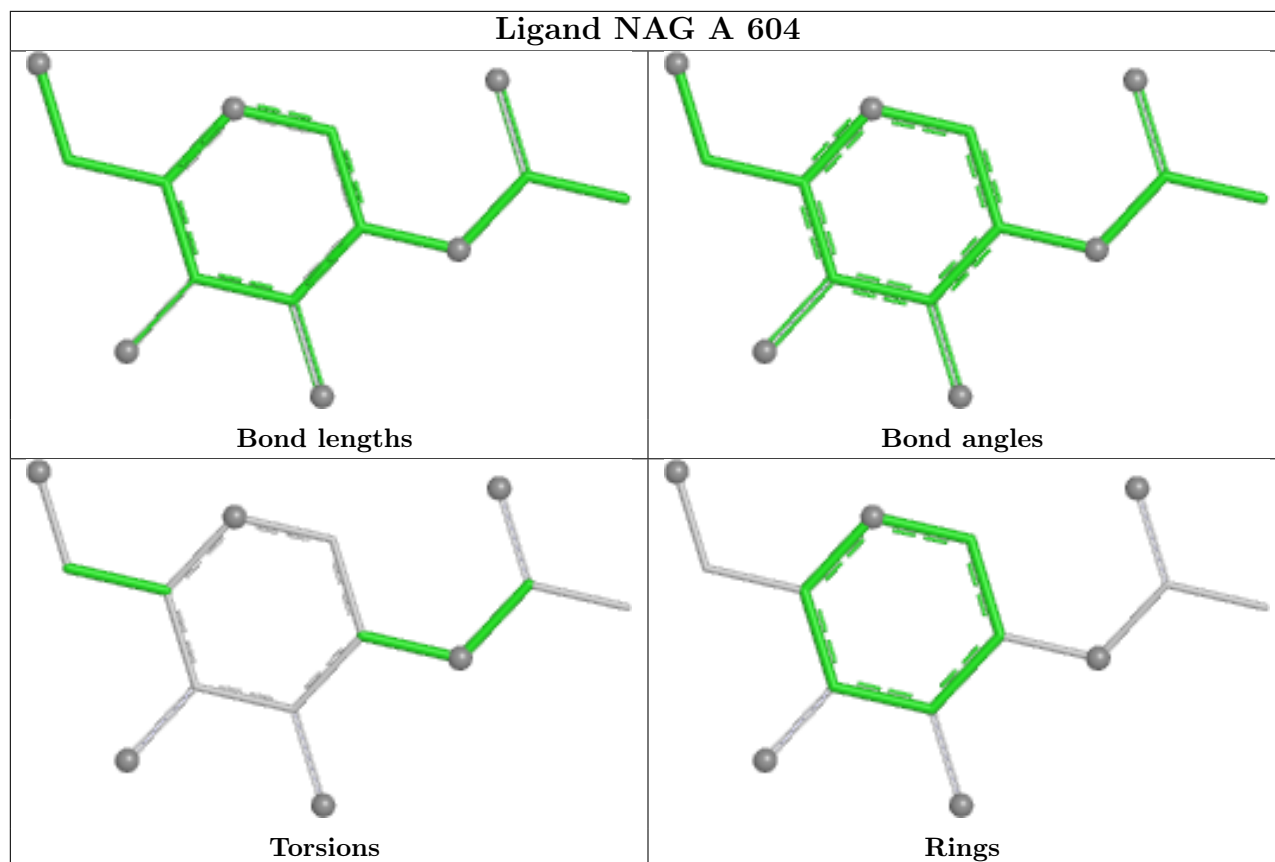



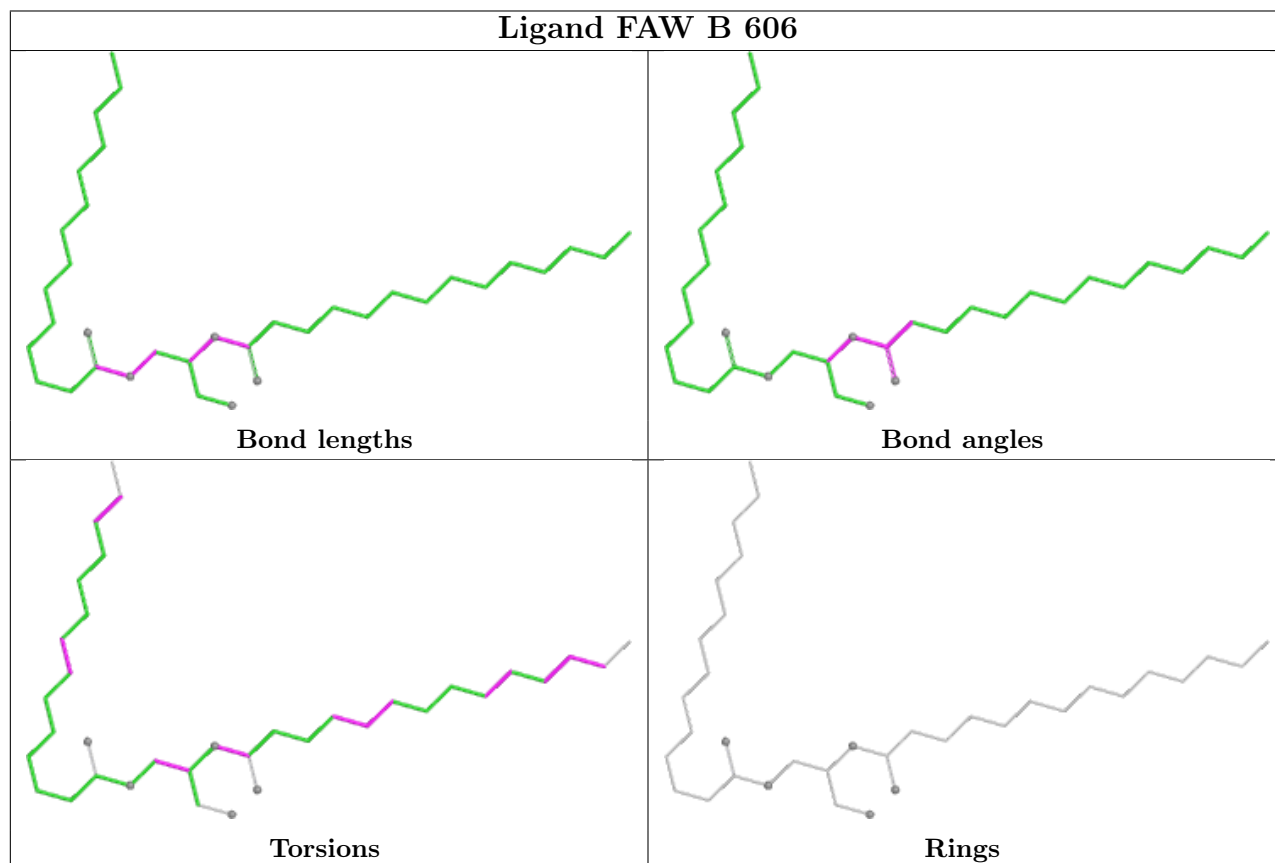
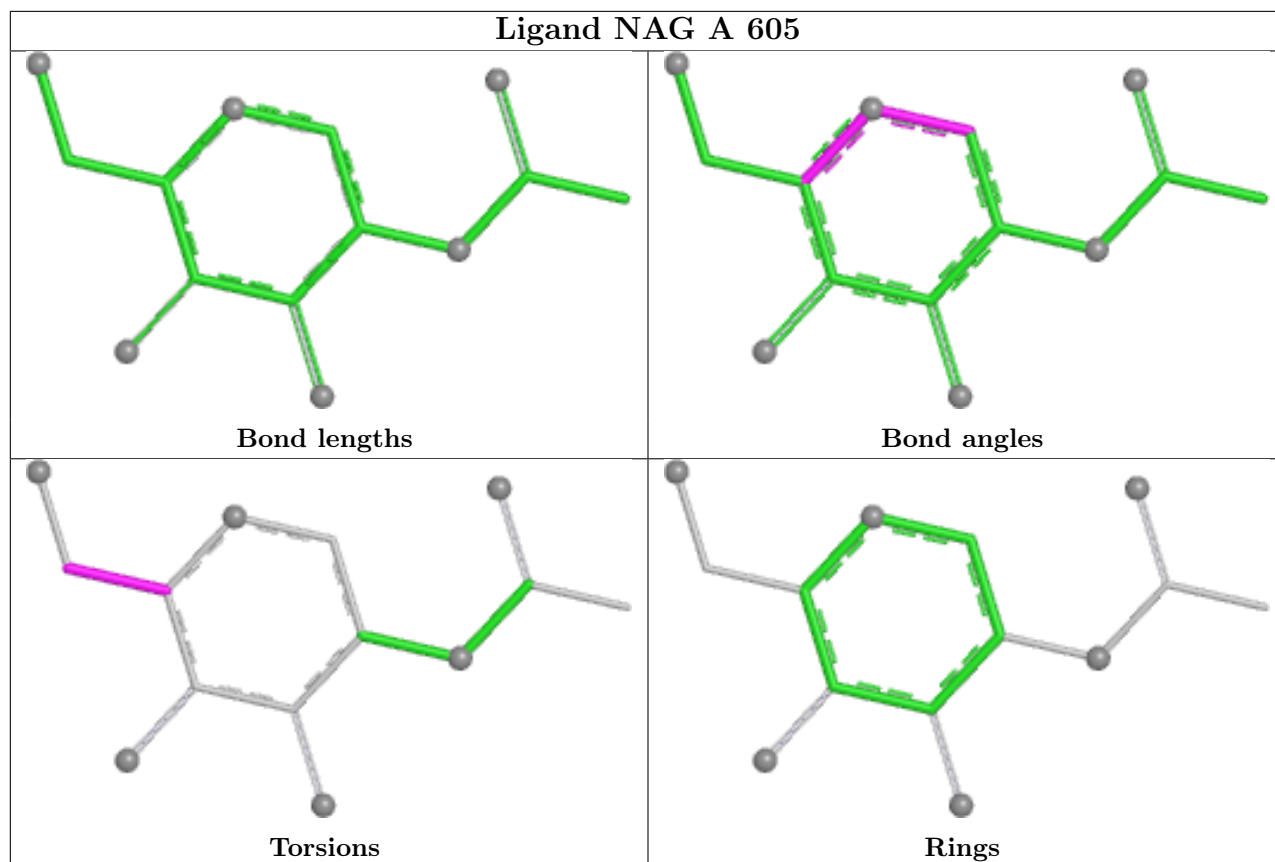

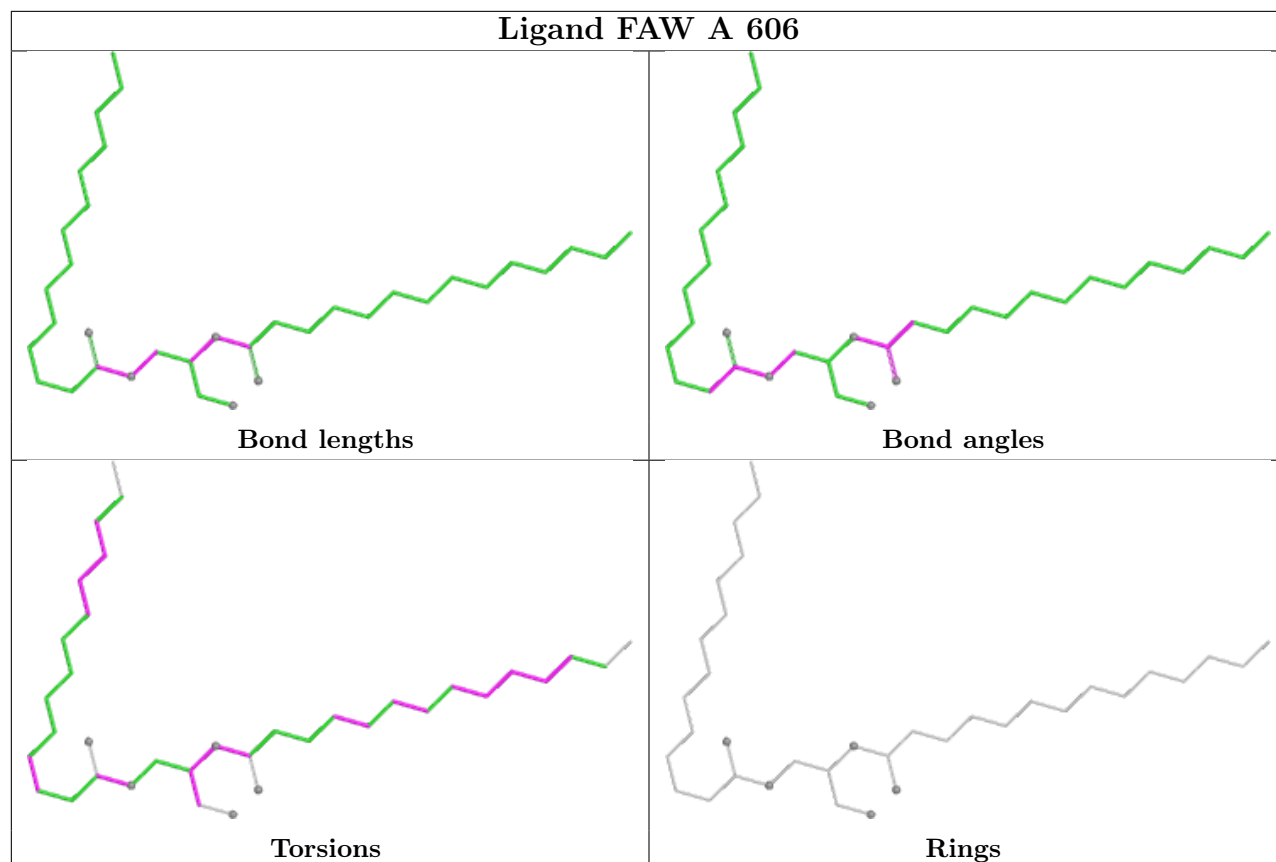

## 5.7 Other polymers [i](#)

There are no such residues in this entry.

## 5.8 Polymer linkage issues [i](#)

There are no chain breaks in this entry.

## 6 Fit of model and data

### 6.1 Protein, DNA and RNA chains

In the following table, the column labelled ‘#RSRZ > 2’ contains the number (and percentage) of RSRZ outliers, followed by percent RSRZ outliers for the chain as percentile scores relative to all X-ray entries and entries of similar resolution. The OWAB column contains the minimum, median, 95<sup>th</sup> percentile and maximum values of the occupancy-weighted average B-factor per residue. The column labelled ‘Q < 0.9’ lists the number of (and percentage) of residues with an average occupancy less than 0.9.

Mol	Chain	Analysed	<RSRZ>	#RSRZ>2	OWAB(Å <sup>2</sup> )	Q<0.9
1	A	521/562 (92%)	-0.31	17 (3%) 49 53	6, 22, 59, 91	15 (2%)
1	B	526/562 (93%)	-0.28	23 (4%) 39 42	5, 23, 59, 102	21 (3%)
All	All	1047/1124 (93%)	-0.29	40 (3%) 44 48	5, 22, 59, 102	36 (3%)

All (40) RSRZ outliers are listed below:

Mol	Chain	Res	Type	RSRZ
1	B	504	PHE	6.6
1	A	504	PHE	5.1
1	A	310	THR	4.4
1	A	36	HIS	4.2
1	B	237	PRO	4.2
1	A	158	ILE	4.0
1	A	35	SER	3.8
1	A	312	GLY	3.8
1	B	158	ILE	3.4
1	A	162	PRO	3.2
1	B	121	GLN	3.1
1	B	36	HIS	2.9
1	A	141	GLN	2.9
1	B	240	GLY	2.8
1	A	510	ASP	2.7
1	B	312	GLY	2.7
1	B	118	VAL	2.7
1	B	117	ALA	2.7
1	B	159	CYS	2.7
1	B	205	CYS	2.6
1	A	143	LEU	2.5
1	B	145	ARG	2.4
1	B	116	GLY	2.4
1	B	238	LYS	2.4

*Continued on next page...*

*Continued from previous page...*

Mol	Chain	Res	Type	RSRZ
1	A	142	VAL	2.4
1	A	505	HIS	2.3
1	B	505	HIS	2.3
1	B	161	LEU	2.3
1	A	129	GLN	2.3
1	A	313	ILE	2.3
1	A	513	LYS	2.3
1	B	141	GLN	2.3
1	B	241	ILE	2.2
1	A	133	GLU	2.2
1	B	163	PHE	2.2
1	B	220	ASN	2.1
1	A	161	LEU	2.1
1	B	278	GLN	2.0
1	B	415	TYR	2.0
1	B	115	ARG	2.0

## 6.2 Non-standard residues in protein, DNA, RNA chains [i](#)

There are no non-standard protein/DNA/RNA residues in this entry.

## 6.3 Carbohydrates [i](#)

There are no monosaccharides in this entry.

## 6.4 Ligands [i](#)

In the following table, the Atoms column lists the number of modelled atoms in the group and the number defined in the chemical component dictionary. The B-factors column lists the minimum, median, 95<sup>th</sup> percentile and maximum values of B factors of atoms in the group. The column labelled 'Q< 0.9' lists the number of atoms with occupancy less than 0.9.

Mol	Type	Chain	Res	Atoms	RSCC	RSR	B-factors(Å <sup>2</sup> )	Q<0.9
3	NAG	B	605	14/15	0.72	0.19	55,70,83,86	0
3	NAG	A	605	14/15	0.76	0.18	48,64,77,77	0
4	FAW	B	606	36/36	0.84	0.20	34,65,101,108	0
4	FAW	A	606	36/36	0.85	0.17	32,56,111,117	0
3	NAG	B	604	14/15	0.87	0.14	39,58,97,97	0
2	CA	B	602	1/1	0.96	0.06	24,24,24,24	0
2	CA	B	603	1/1	0.96	0.05	23,23,23,23	0

*Continued on next page...*

Continued from previous page...

Mol	Type	Chain	Res	Atoms	RSCC	RSR	B-factors( $\text{\AA}^2$ )	Q<0.9
3	NAG	A	604	14/15	0.96	0.06	18,28,36,44	0
2	CA	A	602	1/1	0.96	0.05	20,20,20,20	0
2	CA	A	601	1/1	0.97	0.04	17,17,17,17	0
2	CA	A	603	1/1	0.98	0.04	19,19,19,19	0
2	CA	B	601	1/1	0.98	0.04	19,19,19,19	0

The following is a graphical depiction of the model fit to experimental electron density of all instances of the Ligand of Interest. In addition, ligands with molecular weight > 250 and outliers as shown on the geometry validation Tables will also be included. Each fit is shown from different orientation to approximate a three-dimensional view.

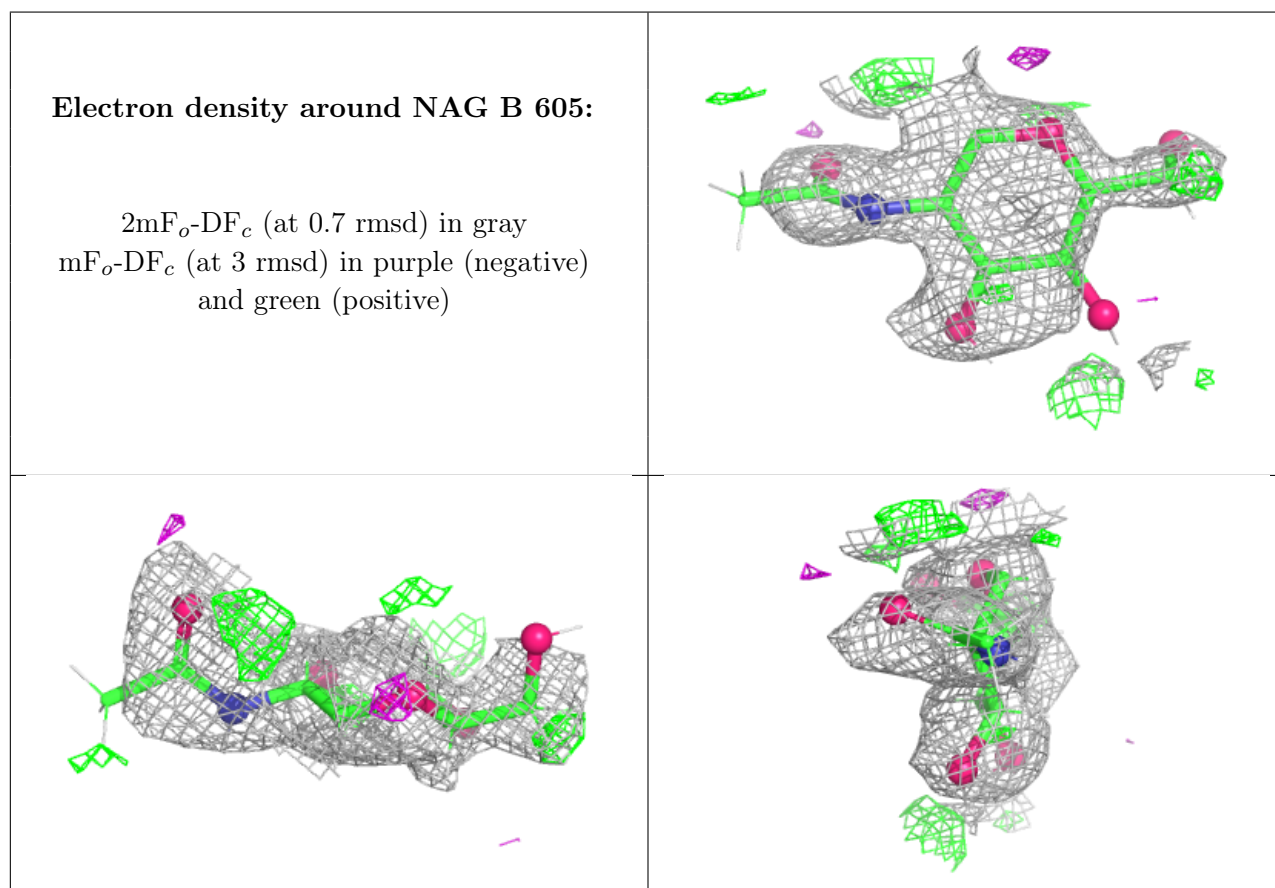

**Electron density around NAG A 605:**

$2mF_o-DF_c$  (at 0.7 rmsd) in gray  
 $mF_o-DF_c$  (at 3 rmsd) in purple (negative)  
and green (positive)

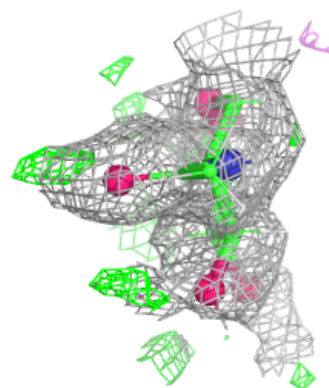
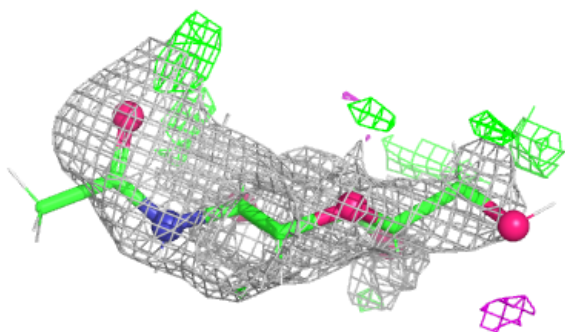
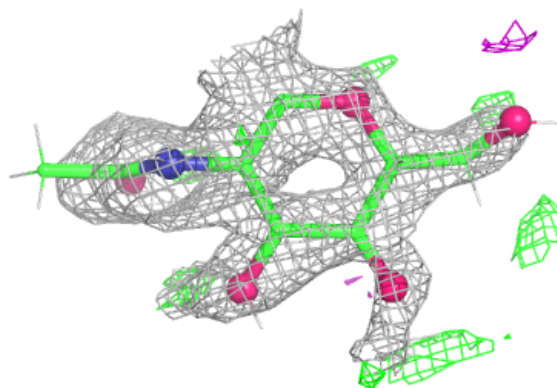
**Electron density around FAW B 606:**

$2mF_o-DF_c$  (at 0.7 rmsd) in gray  
 $mF_o-DF_c$  (at 3 rmsd) in purple (negative)  
and green (positive)

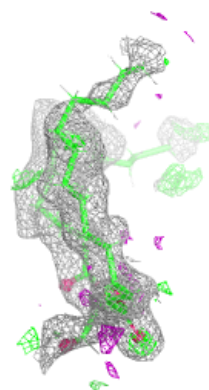
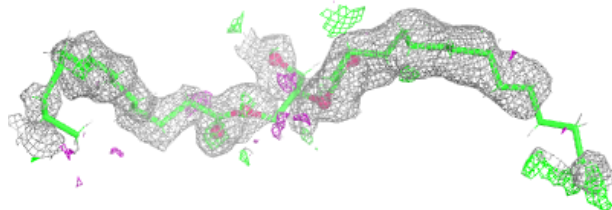
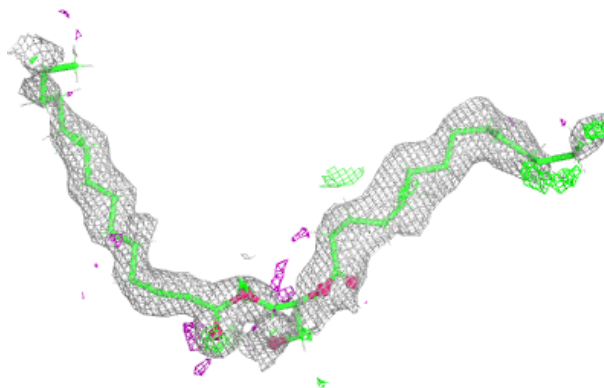

**Electron density around FAW A 606:**

$2mF_o-DF_c$  (at 0.7 rmsd) in gray  
 $mF_o-DF_c$  (at 3 rmsd) in purple (negative)  
and green (positive)

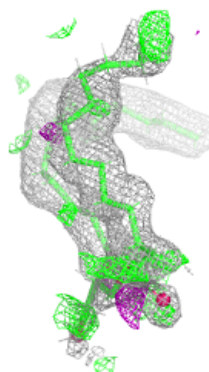
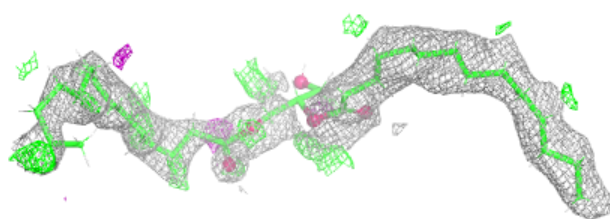
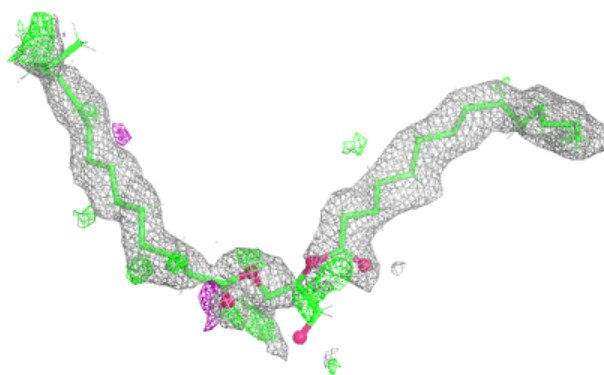
**Electron density around NAG B 604:**

$2mF_o-DF_c$  (at 0.7 rmsd) in gray  
 $mF_o-DF_c$  (at 3 rmsd) in purple (negative)  
and green (positive)

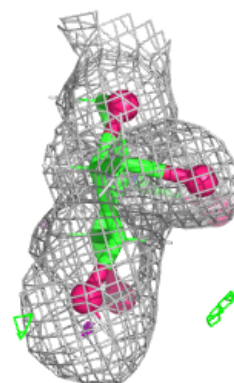
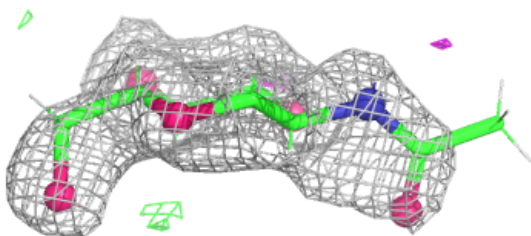
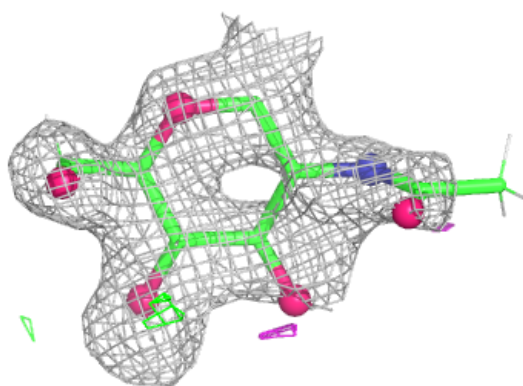

**Electron density around CA B 602:**

$2mF_o-DF_c$  (at 0.7 rmsd) in gray  
 $mF_o-DF_c$  (at 3 rmsd) in purple (negative)  
and green (positive)

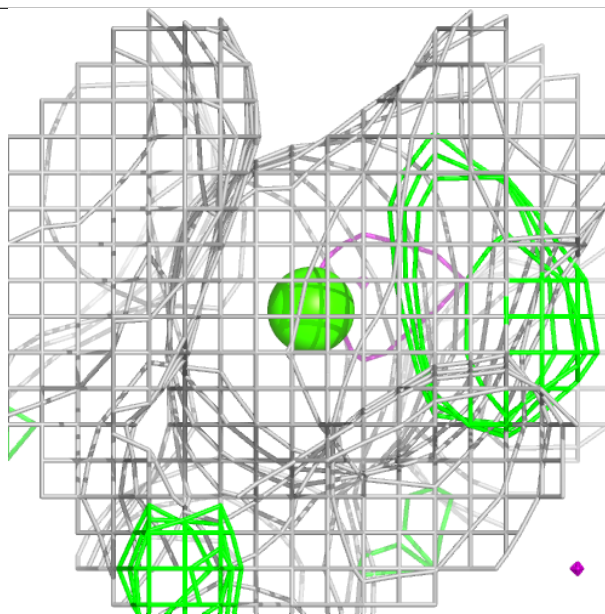
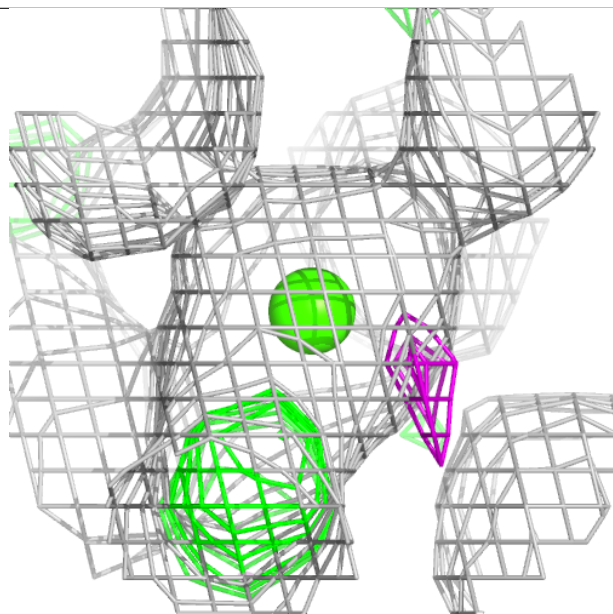
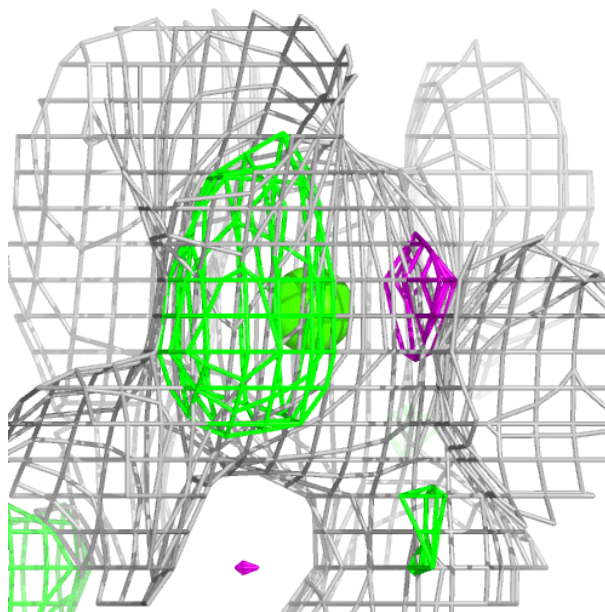



**Electron density around CA B 603:**

$2mF_o-DF_c$  (at 0.7 rmsd) in gray  
 $mF_o-DF_c$  (at 3 rmsd) in purple (negative)  
and green (positive)

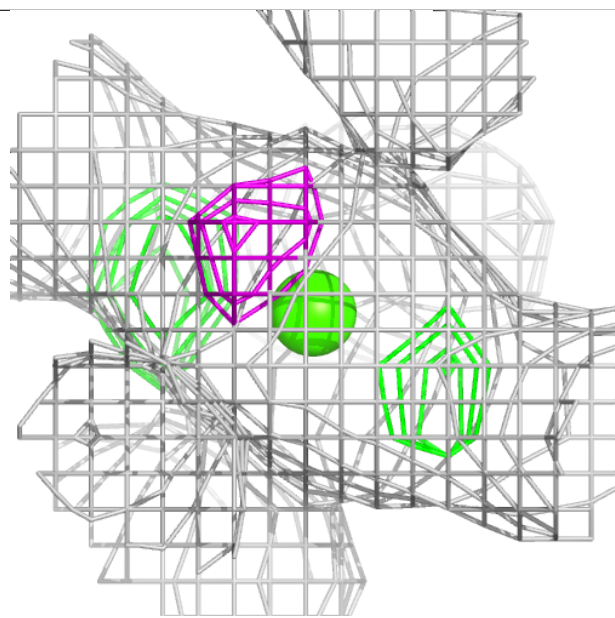
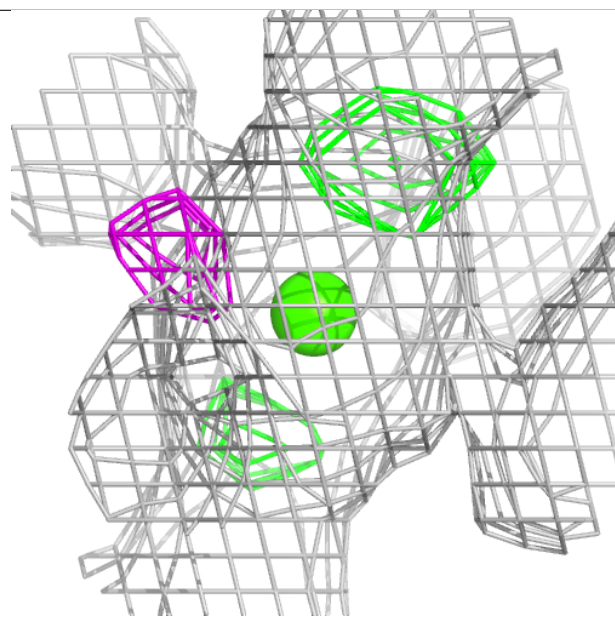
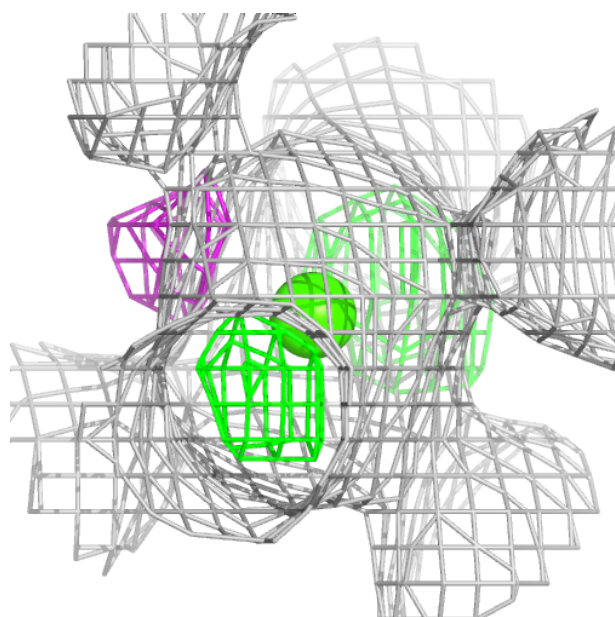

**Electron density around NAG A 604:**

$2mF_o-DF_c$  (at 0.7 rmsd) in gray  
 $mF_o-DF_c$  (at 3 rmsd) in purple (negative)  
and green (positive)

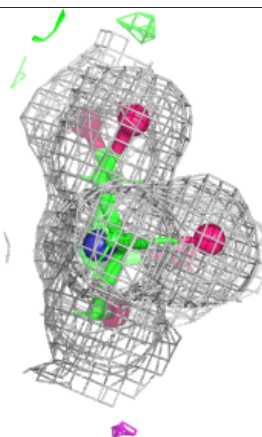
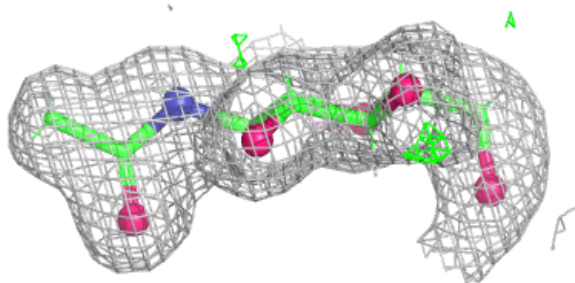
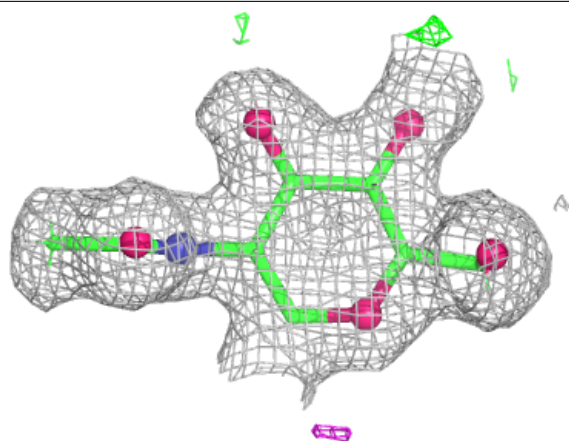

**Electron density around CA A 602:**

$2mF_o-DF_c$  (at 0.7 rmsd) in gray  
 $mF_o-DF_c$  (at 3 rmsd) in purple (negative)  
and green (positive)

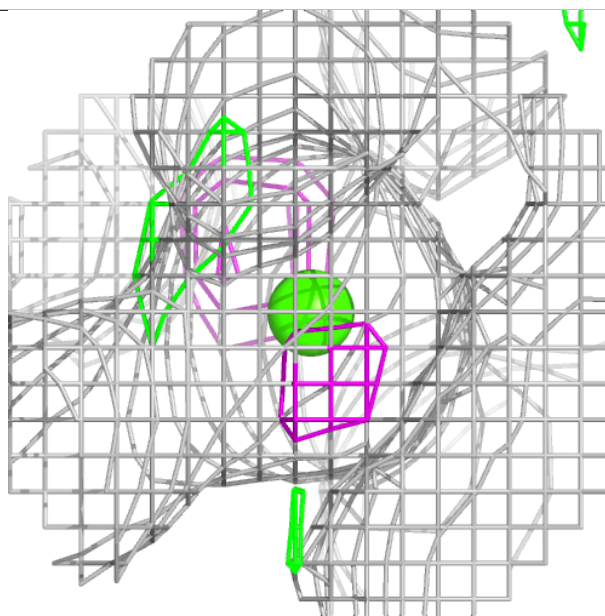
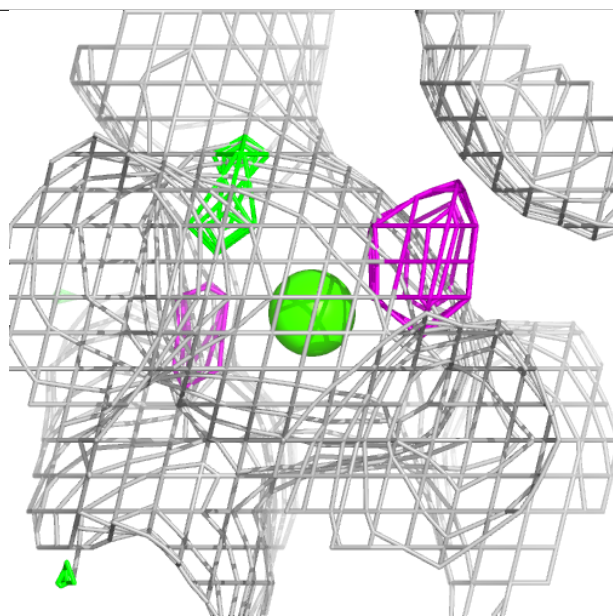
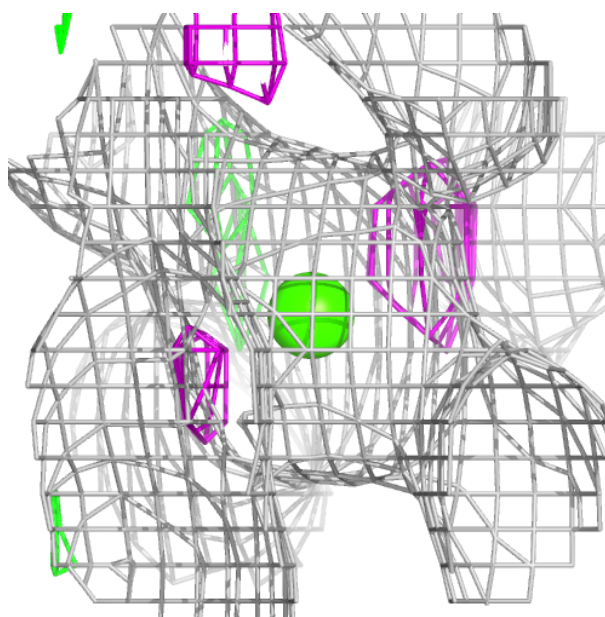

**Electron density around CA A 601:**

$2mF_o-DF_c$  (at 0.7 rmsd) in gray  
 $mF_o-DF_c$  (at 3 rmsd) in purple (negative)  
and green (positive)

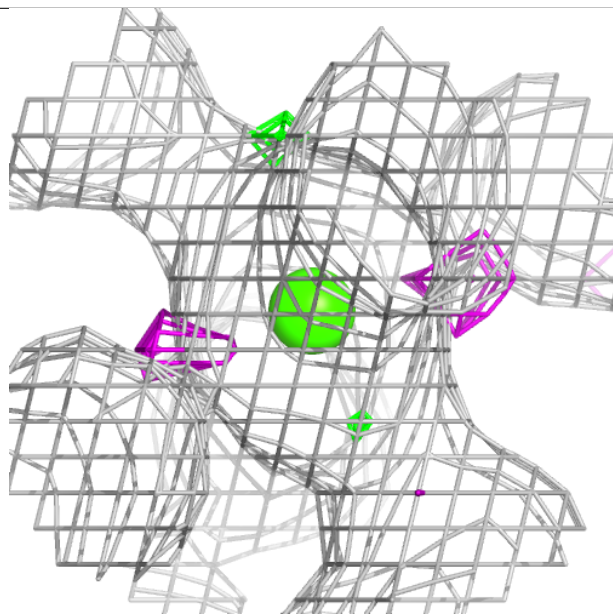
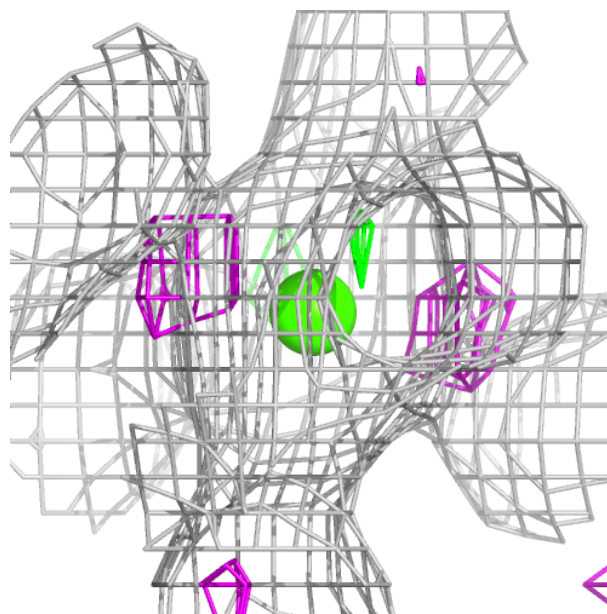

**Electron density around CA A 603:**

$2mF_o-DF_c$  (at 0.7 rmsd) in gray  
 $mF_o-DF_c$  (at 3 rmsd) in purple (negative)  
and green (positive)

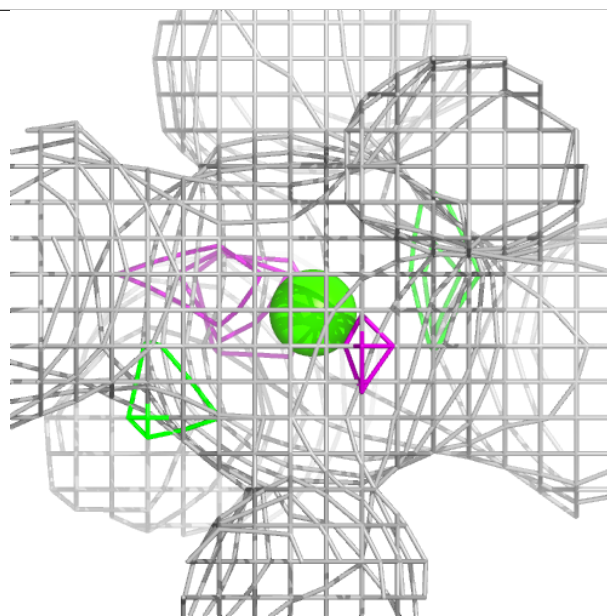
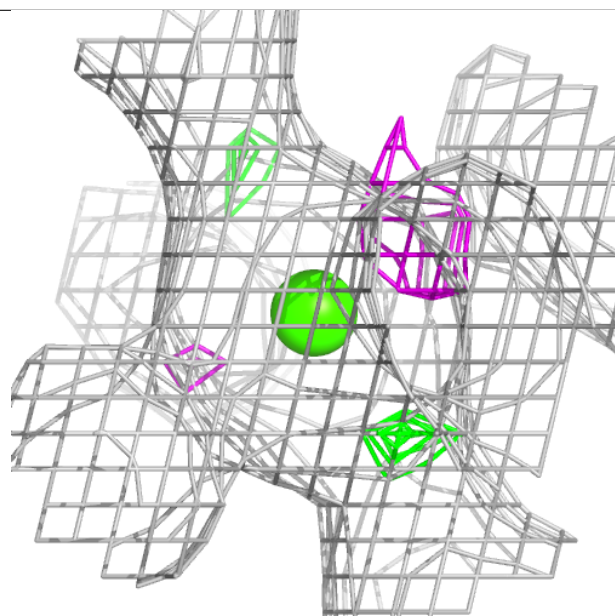
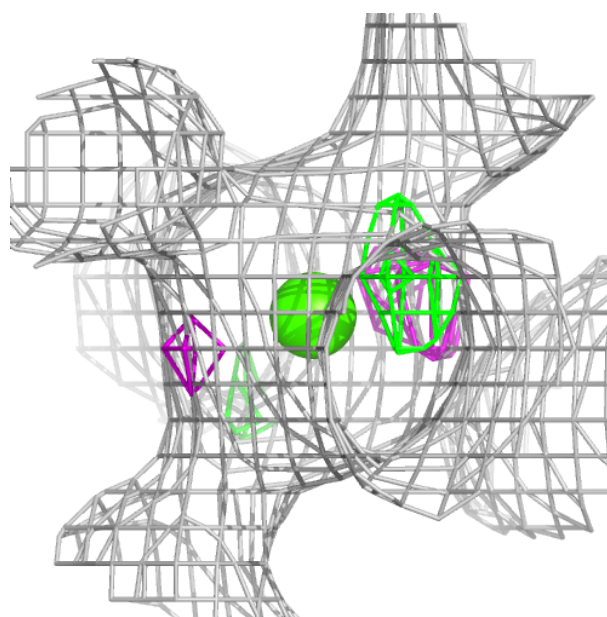

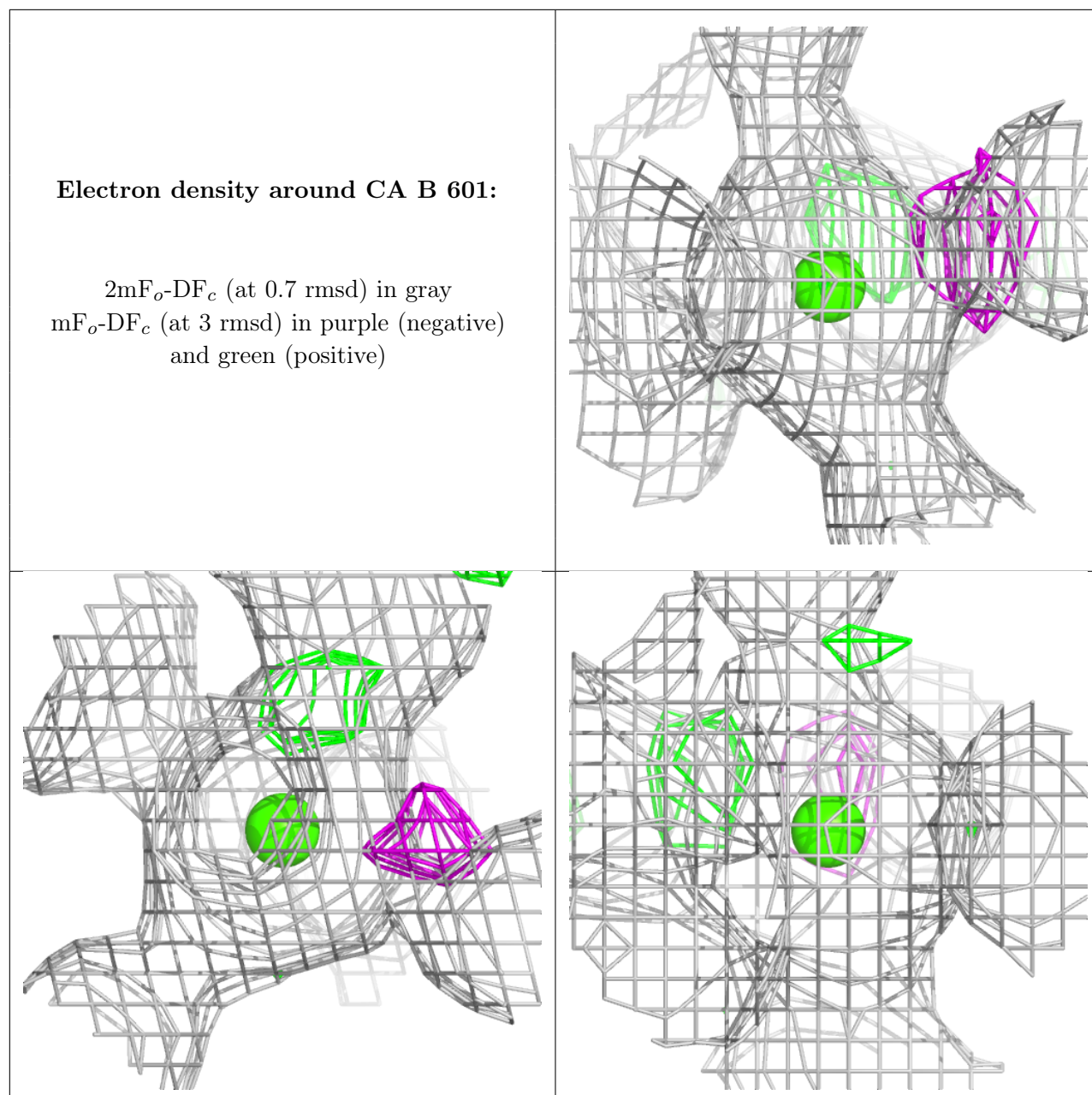

## 6.5 Other polymers ⓘ

There are no such residues in this entry.