



Full wwPDB EM Validation Report ⓘ

Oct 27, 2024 – 08:14 PM JST

PDB ID : 7W9B
EMDB ID : EMD-32363
Title : SARS-CoV-2 Delta S-ACE2-C2b
Authors : Cong, Y.; Liu, C.X.
Deposited on : 2021-12-09
Resolution : 3.40 Å(reported)

This is a Full wwPDB EM Validation Report for a publicly released PDB entry.

We welcome your comments at validation@mail.wwpdb.org

A user guide is available at

<https://www.wwpdb.org/validation/2017/EMValidationReportHelp>

with specific help available everywhere you see the ⓘ symbol.

The types of validation reports are described at

<http://www.wwpdb.org/validation/2017/FAQs#types>.

The following versions of software and data (see [references ⓘ](#)) were used in the production of this report:

EMDB validation analysis : 0.0.1.dev113
MolProbity : 4.02b-467
Percentile statistics : 20231227.v01 (using entries in the PDB archive December 27th 2023)
MapQ : 1.9.13
Ideal geometry (proteins) : Engh & Huber (2001)
Ideal geometry (DNA, RNA) : Parkinson et al. (1996)
Validation Pipeline (wwPDB-VP) : 2.39

1 Overall quality at a glance i

The following experimental techniques were used to determine the structure:
ELECTRON MICROSCOPY

The reported resolution of this entry is 3.40 Å.

Percentile scores (ranging between 0-100) for global validation metrics of the entry are shown in the following graphic. The table shows the number of entries on which the scores are based.

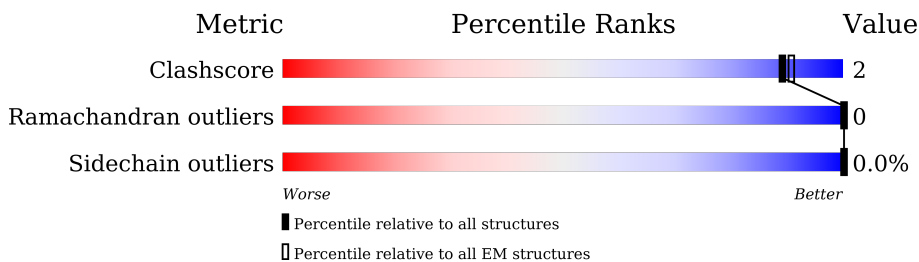

Metric	Whole archive (#Entries)	EM structures (#Entries)
Clashscore	210492	15764
Ramachandran outliers	207382	16835
Sidechain outliers	206894	16415

The table below summarises the geometric issues observed across the polymeric chains and their fit to the map. The red, orange, yellow and green segments of the bar indicate the fraction of residues that contain outliers for ≥ 3 , 2, 1 and 0 types of geometric quality criteria respectively. A grey segment represents the fraction of residues that are not modelled. The numeric value for each fraction is indicated below the corresponding segment, with a dot representing fractions $\leq 5\%$. The upper red bar (where present) indicates the fraction of residues that have poor fit to the EM map (all-atom inclusion $< 40\%$). The numeric value is given above the bar.

Mol	Chain	Length	Quality of chain
1	B	1261	
1	C	1261	
1	D	1261	
2	A	625	

2 Entry composition [i](#)

There are 2 unique types of molecules in this entry. The entry contains 29737 atoms, of which 0 are hydrogens and 0 are deuteriums.

In the tables below, the AltConf column contains the number of residues with at least one atom in alternate conformation and the Trace column contains the number of residues modelled with at most 2 atoms.

- Molecule 1 is a protein called Spike glycoprotein.

Mol	Chain	Residues	Atoms					AltConf	Trace
			Total	C	N	O	S		
1	B	1060	8289	5285	1392	1574	38	0	0
1	C	1060	8289	5285	1392	1574	38	0	0
1	D	1060	8289	5285	1392	1574	38	0	0

There are 201 discrepancies between the modelled and reference sequences:

Chain	Residue	Modelled	Actual	Comment	Reference
B	19	ARG	THR	variant	UNP P0DTC2
B	158	GLY	ARG	variant	UNP P0DTC2
B	452	ARG	LEU	variant	UNP P0DTC2
B	478	LYS	THR	variant	UNP P0DTC2
B	614	GLY	ASP	variant	UNP P0DTC2
B	681	ARG	PRO	variant	UNP P0DTC2
B	682	GLY	ARG	conflict	UNP P0DTC2
B	683	SER	ARG	conflict	UNP P0DTC2
B	685	SER	ARG	conflict	UNP P0DTC2
B	950	ASN	ASP	variant	UNP P0DTC2
B	986	PRO	LYS	conflict	UNP P0DTC2
B	987	PRO	VAL	conflict	UNP P0DTC2
B	1207	GLU	-	expression tag	UNP P0DTC2
B	1208	GLN	-	expression tag	UNP P0DTC2
B	1209	GLY	-	expression tag	UNP P0DTC2
B	1210	SER	-	expression tag	UNP P0DTC2
B	1211	GLY	-	expression tag	UNP P0DTC2
B	1212	TYR	-	expression tag	UNP P0DTC2
B	1213	ILE	-	expression tag	UNP P0DTC2
B	1214	PRO	-	expression tag	UNP P0DTC2
B	1215	GLU	-	expression tag	UNP P0DTC2
B	1216	ALA	-	expression tag	UNP P0DTC2
B	1217	PRO	-	expression tag	UNP P0DTC2
B	1218	ARG	-	expression tag	UNP P0DTC2

Continued on next page...

Continued from previous page...

Chain	Residue	Modelled	Actual	Comment	Reference
B	1219	ASP	-	expression tag	UNP P0DTC2
B	1220	GLY	-	expression tag	UNP P0DTC2
B	1221	GLN	-	expression tag	UNP P0DTC2
B	1222	ALA	-	expression tag	UNP P0DTC2
B	1223	TYR	-	expression tag	UNP P0DTC2
B	1224	VAL	-	expression tag	UNP P0DTC2
B	1225	ARG	-	expression tag	UNP P0DTC2
B	1226	LYS	-	expression tag	UNP P0DTC2
B	1227	ASP	-	expression tag	UNP P0DTC2
B	1228	GLY	-	expression tag	UNP P0DTC2
B	1229	GLU	-	expression tag	UNP P0DTC2
B	1230	TRP	-	expression tag	UNP P0DTC2
B	1231	VAL	-	expression tag	UNP P0DTC2
B	1232	LEU	-	expression tag	UNP P0DTC2
B	1233	LEU	-	expression tag	UNP P0DTC2
B	1234	SER	-	expression tag	UNP P0DTC2
B	1235	THR	-	expression tag	UNP P0DTC2
B	1236	PHE	-	expression tag	UNP P0DTC2
B	1237	LEU	-	expression tag	UNP P0DTC2
B	1238	GLU	-	expression tag	UNP P0DTC2
B	1239	ASN	-	expression tag	UNP P0DTC2
B	1240	LEU	-	expression tag	UNP P0DTC2
B	1241	TYR	-	expression tag	UNP P0DTC2
B	1242	PHE	-	expression tag	UNP P0DTC2
B	1243	GLN	-	expression tag	UNP P0DTC2
B	1244	GLY	-	expression tag	UNP P0DTC2
B	1245	ASP	-	expression tag	UNP P0DTC2
B	1246	TYR	-	expression tag	UNP P0DTC2
B	1247	LYS	-	expression tag	UNP P0DTC2
B	1248	ASP	-	expression tag	UNP P0DTC2
B	1249	ASP	-	expression tag	UNP P0DTC2
B	1250	ASP	-	expression tag	UNP P0DTC2
B	1251	ASP	-	expression tag	UNP P0DTC2
B	1252	LYS	-	expression tag	UNP P0DTC2
B	1253	HIS	-	expression tag	UNP P0DTC2
B	1254	HIS	-	expression tag	UNP P0DTC2
B	1255	HIS	-	expression tag	UNP P0DTC2
B	1256	HIS	-	expression tag	UNP P0DTC2
B	1257	HIS	-	expression tag	UNP P0DTC2
B	1258	HIS	-	expression tag	UNP P0DTC2
B	1259	HIS	-	expression tag	UNP P0DTC2
B	1260	HIS	-	expression tag	UNP P0DTC2

Continued on next page...

Continued from previous page...

Chain	Residue	Modelled	Actual	Comment	Reference
B	1261	HIS	-	expression tag	UNP P0DTC2
C	19	ARG	THR	variant	UNP P0DTC2
C	158	GLY	ARG	variant	UNP P0DTC2
C	452	ARG	LEU	variant	UNP P0DTC2
C	478	LYS	THR	variant	UNP P0DTC2
C	614	GLY	ASP	variant	UNP P0DTC2
C	681	ARG	PRO	variant	UNP P0DTC2
C	682	GLY	ARG	conflict	UNP P0DTC2
C	683	SER	ARG	conflict	UNP P0DTC2
C	685	SER	ARG	conflict	UNP P0DTC2
C	950	ASN	ASP	variant	UNP P0DTC2
C	986	PRO	LYS	conflict	UNP P0DTC2
C	987	PRO	VAL	conflict	UNP P0DTC2
C	1207	GLU	-	expression tag	UNP P0DTC2
C	1208	GLN	-	expression tag	UNP P0DTC2
C	1209	GLY	-	expression tag	UNP P0DTC2
C	1210	SER	-	expression tag	UNP P0DTC2
C	1211	GLY	-	expression tag	UNP P0DTC2
C	1212	TYR	-	expression tag	UNP P0DTC2
C	1213	ILE	-	expression tag	UNP P0DTC2
C	1214	PRO	-	expression tag	UNP P0DTC2
C	1215	GLU	-	expression tag	UNP P0DTC2
C	1216	ALA	-	expression tag	UNP P0DTC2
C	1217	PRO	-	expression tag	UNP P0DTC2
C	1218	ARG	-	expression tag	UNP P0DTC2
C	1219	ASP	-	expression tag	UNP P0DTC2
C	1220	GLY	-	expression tag	UNP P0DTC2
C	1221	GLN	-	expression tag	UNP P0DTC2
C	1222	ALA	-	expression tag	UNP P0DTC2
C	1223	TYR	-	expression tag	UNP P0DTC2
C	1224	VAL	-	expression tag	UNP P0DTC2
C	1225	ARG	-	expression tag	UNP P0DTC2
C	1226	LYS	-	expression tag	UNP P0DTC2
C	1227	ASP	-	expression tag	UNP P0DTC2
C	1228	GLY	-	expression tag	UNP P0DTC2
C	1229	GLU	-	expression tag	UNP P0DTC2
C	1230	TRP	-	expression tag	UNP P0DTC2
C	1231	VAL	-	expression tag	UNP P0DTC2
C	1232	LEU	-	expression tag	UNP P0DTC2
C	1233	LEU	-	expression tag	UNP P0DTC2
C	1234	SER	-	expression tag	UNP P0DTC2
C	1235	THR	-	expression tag	UNP P0DTC2

Continued on next page...

Continued from previous page...

Chain	Residue	Modelled	Actual	Comment	Reference
C	1236	PHE	-	expression tag	UNP P0DTC2
C	1237	LEU	-	expression tag	UNP P0DTC2
C	1238	GLU	-	expression tag	UNP P0DTC2
C	1239	ASN	-	expression tag	UNP P0DTC2
C	1240	LEU	-	expression tag	UNP P0DTC2
C	1241	TYR	-	expression tag	UNP P0DTC2
C	1242	PHE	-	expression tag	UNP P0DTC2
C	1243	GLN	-	expression tag	UNP P0DTC2
C	1244	GLY	-	expression tag	UNP P0DTC2
C	1245	ASP	-	expression tag	UNP P0DTC2
C	1246	TYR	-	expression tag	UNP P0DTC2
C	1247	LYS	-	expression tag	UNP P0DTC2
C	1248	ASP	-	expression tag	UNP P0DTC2
C	1249	ASP	-	expression tag	UNP P0DTC2
C	1250	ASP	-	expression tag	UNP P0DTC2
C	1251	ASP	-	expression tag	UNP P0DTC2
C	1252	LYS	-	expression tag	UNP P0DTC2
C	1253	HIS	-	expression tag	UNP P0DTC2
C	1254	HIS	-	expression tag	UNP P0DTC2
C	1255	HIS	-	expression tag	UNP P0DTC2
C	1256	HIS	-	expression tag	UNP P0DTC2
C	1257	HIS	-	expression tag	UNP P0DTC2
C	1258	HIS	-	expression tag	UNP P0DTC2
C	1259	HIS	-	expression tag	UNP P0DTC2
C	1260	HIS	-	expression tag	UNP P0DTC2
C	1261	HIS	-	expression tag	UNP P0DTC2
D	19	ARG	THR	variant	UNP P0DTC2
D	158	GLY	ARG	variant	UNP P0DTC2
D	452	ARG	LEU	variant	UNP P0DTC2
D	478	LYS	THR	variant	UNP P0DTC2
D	614	GLY	ASP	variant	UNP P0DTC2
D	681	ARG	PRO	variant	UNP P0DTC2
D	682	GLY	ARG	conflict	UNP P0DTC2
D	683	SER	ARG	conflict	UNP P0DTC2
D	685	SER	ARG	conflict	UNP P0DTC2
D	950	ASN	ASP	variant	UNP P0DTC2
D	986	PRO	LYS	conflict	UNP P0DTC2
D	987	PRO	VAL	conflict	UNP P0DTC2
D	1207	GLU	-	expression tag	UNP P0DTC2
D	1208	GLN	-	expression tag	UNP P0DTC2
D	1209	GLY	-	expression tag	UNP P0DTC2
D	1210	SER	-	expression tag	UNP P0DTC2

Continued on next page...

Continued from previous page...

Chain	Residue	Modelled	Actual	Comment	Reference
D	1211	GLY	-	expression tag	UNP P0DTC2
D	1212	TYR	-	expression tag	UNP P0DTC2
D	1213	ILE	-	expression tag	UNP P0DTC2
D	1214	PRO	-	expression tag	UNP P0DTC2
D	1215	GLU	-	expression tag	UNP P0DTC2
D	1216	ALA	-	expression tag	UNP P0DTC2
D	1217	PRO	-	expression tag	UNP P0DTC2
D	1218	ARG	-	expression tag	UNP P0DTC2
D	1219	ASP	-	expression tag	UNP P0DTC2
D	1220	GLY	-	expression tag	UNP P0DTC2
D	1221	GLN	-	expression tag	UNP P0DTC2
D	1222	ALA	-	expression tag	UNP P0DTC2
D	1223	TYR	-	expression tag	UNP P0DTC2
D	1224	VAL	-	expression tag	UNP P0DTC2
D	1225	ARG	-	expression tag	UNP P0DTC2
D	1226	LYS	-	expression tag	UNP P0DTC2
D	1227	ASP	-	expression tag	UNP P0DTC2
D	1228	GLY	-	expression tag	UNP P0DTC2
D	1229	GLU	-	expression tag	UNP P0DTC2
D	1230	TRP	-	expression tag	UNP P0DTC2
D	1231	VAL	-	expression tag	UNP P0DTC2
D	1232	LEU	-	expression tag	UNP P0DTC2
D	1233	LEU	-	expression tag	UNP P0DTC2
D	1234	SER	-	expression tag	UNP P0DTC2
D	1235	THR	-	expression tag	UNP P0DTC2
D	1236	PHE	-	expression tag	UNP P0DTC2
D	1237	LEU	-	expression tag	UNP P0DTC2
D	1238	GLU	-	expression tag	UNP P0DTC2
D	1239	ASN	-	expression tag	UNP P0DTC2
D	1240	LEU	-	expression tag	UNP P0DTC2
D	1241	TYR	-	expression tag	UNP P0DTC2
D	1242	PHE	-	expression tag	UNP P0DTC2
D	1243	GLN	-	expression tag	UNP P0DTC2
D	1244	GLY	-	expression tag	UNP P0DTC2
D	1245	ASP	-	expression tag	UNP P0DTC2
D	1246	TYR	-	expression tag	UNP P0DTC2
D	1247	LYS	-	expression tag	UNP P0DTC2
D	1248	ASP	-	expression tag	UNP P0DTC2
D	1249	ASP	-	expression tag	UNP P0DTC2
D	1250	ASP	-	expression tag	UNP P0DTC2
D	1251	ASP	-	expression tag	UNP P0DTC2
D	1252	LYS	-	expression tag	UNP P0DTC2

Continued on next page...

Continued from previous page...

Chain	Residue	Modelled	Actual	Comment	Reference
D	1253	HIS	-	expression tag	UNP P0DTC2
D	1254	HIS	-	expression tag	UNP P0DTC2
D	1255	HIS	-	expression tag	UNP P0DTC2
D	1256	HIS	-	expression tag	UNP P0DTC2
D	1257	HIS	-	expression tag	UNP P0DTC2
D	1258	HIS	-	expression tag	UNP P0DTC2
D	1259	HIS	-	expression tag	UNP P0DTC2
D	1260	HIS	-	expression tag	UNP P0DTC2
D	1261	HIS	-	expression tag	UNP P0DTC2

- Molecule 2 is a protein called Angiotensin-converting enzyme 2.

Mol	Chain	Residues	Atoms					AltConf	Trace
			Total	C	N	O	S		
2	A	597	4870	3115	806	920	29	0	0

There are 26 discrepancies between the modelled and reference sequences:

Chain	Residue	Modelled	Actual	Comment	Reference
A	0	MET	-	initiating methionine	UNP Q9BYF1
A	1	HIS	-	expression tag	UNP Q9BYF1
A	2	SER	-	expression tag	UNP Q9BYF1
A	3	SER	-	expression tag	UNP Q9BYF1
A	4	ALA	-	expression tag	UNP Q9BYF1
A	5	LEU	-	expression tag	UNP Q9BYF1
A	6	LEU	-	expression tag	UNP Q9BYF1
A	7	CYS	-	expression tag	UNP Q9BYF1
A	8	CYS	-	expression tag	UNP Q9BYF1
A	9	LEU	-	expression tag	UNP Q9BYF1
A	10	VAL	-	expression tag	UNP Q9BYF1
A	11	LEU	-	expression tag	UNP Q9BYF1
A	12	LEU	-	expression tag	UNP Q9BYF1
A	13	THR	-	expression tag	UNP Q9BYF1
A	14	GLY	-	expression tag	UNP Q9BYF1
A	15	VAL	-	expression tag	UNP Q9BYF1
A	16	ARG	-	expression tag	UNP Q9BYF1
A	616	HIS	-	expression tag	UNP Q9BYF1
A	617	HIS	-	expression tag	UNP Q9BYF1
A	618	HIS	-	expression tag	UNP Q9BYF1
A	619	HIS	-	expression tag	UNP Q9BYF1
A	620	HIS	-	expression tag	UNP Q9BYF1
A	621	HIS	-	expression tag	UNP Q9BYF1

Continued on next page...

Continued from previous page...

Chain	Residue	Modelled	Actual	Comment	Reference
A	622	HIS	-	expression tag	UNP Q9BYF1
A	623	HIS	-	expression tag	UNP Q9BYF1
A	624	HIS	-	expression tag	UNP Q9BYF1

3 Residue-property plots

These plots are drawn for all protein, RNA, DNA and oligosaccharide chains in the entry. The first graphic for a chain summarises the proportions of the various outlier classes displayed in the second graphic. The second graphic shows the sequence view annotated by issues in geometry and atom inclusion in map density. Residues are color-coded according to the number of geometric quality criteria for which they contain at least one outlier: green = 0, yellow = 1, orange = 2 and red = 3 or more. A red diamond above a residue indicates a poor fit to the EM map for this residue (all-atom inclusion < 40%). Stretches of 2 or more consecutive residues without any outlier are shown as a green connector. Residues present in the sample, but not in the model, are shown in grey.

- Molecule 1: Spike glycoprotein

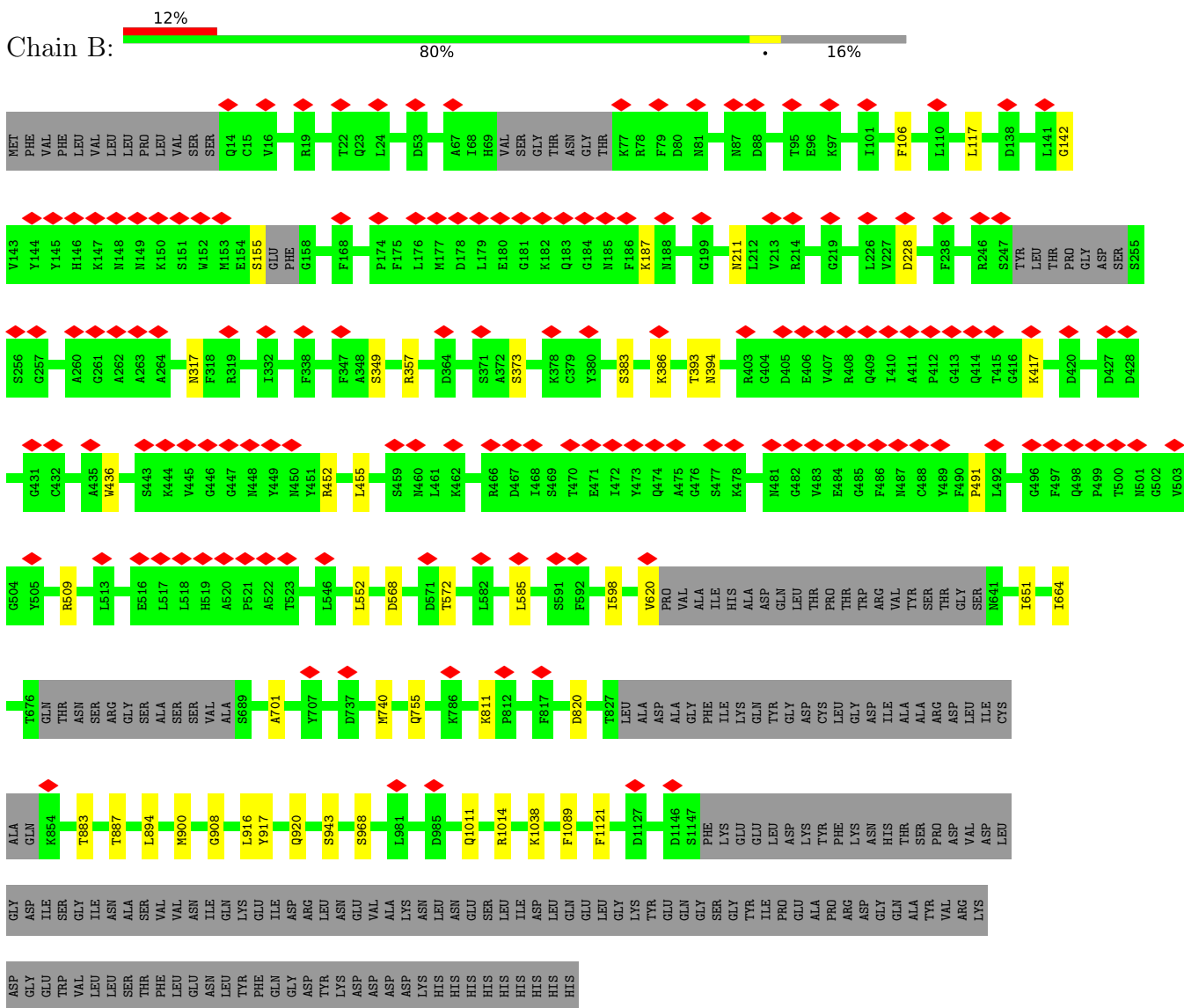

- Molecule 1: Spike glycoprotein

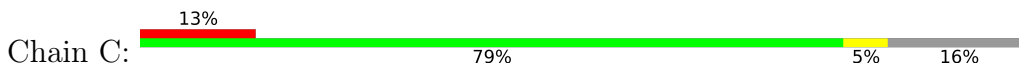

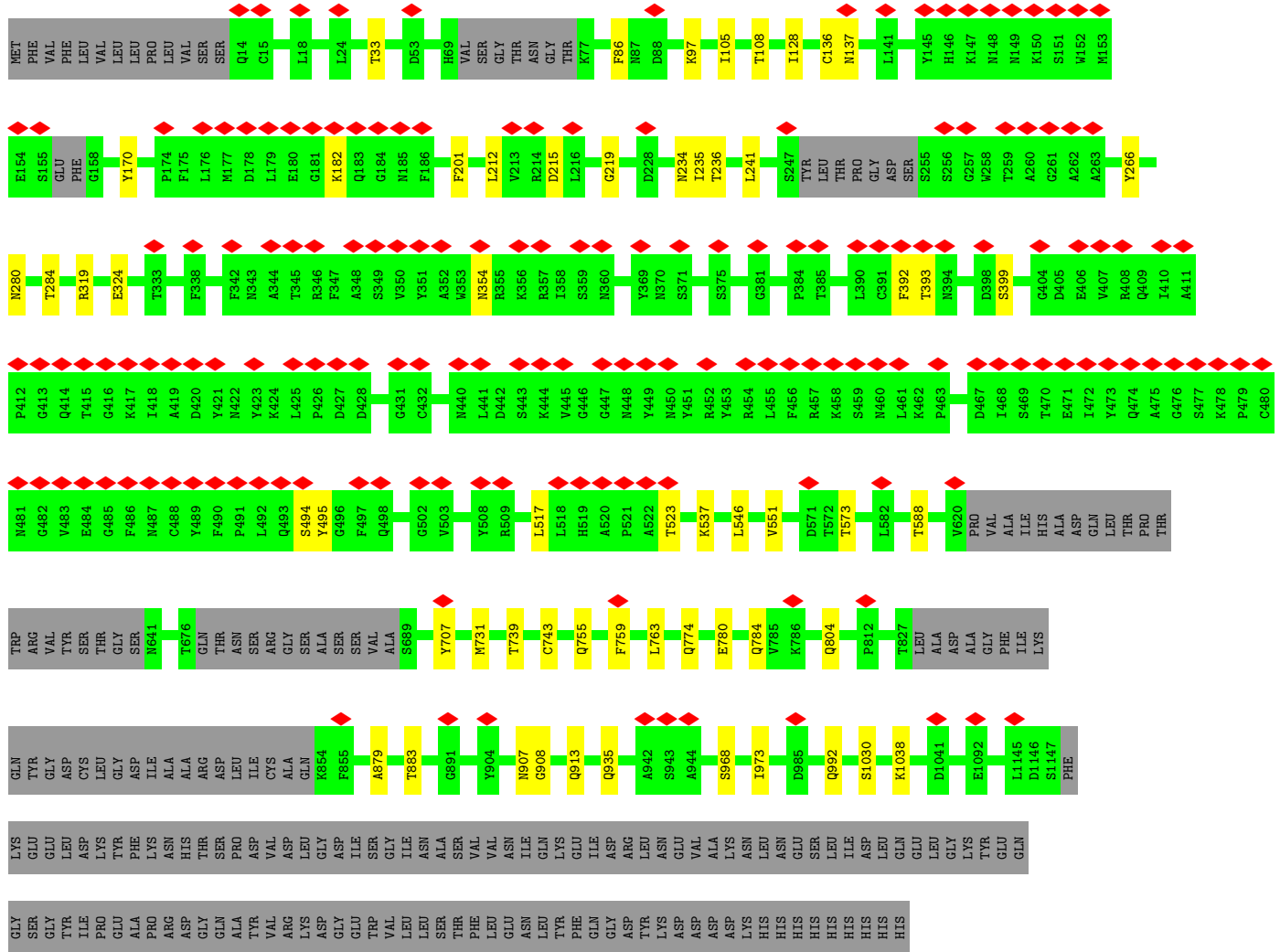

● Molecule 1: Spike glycoprotein

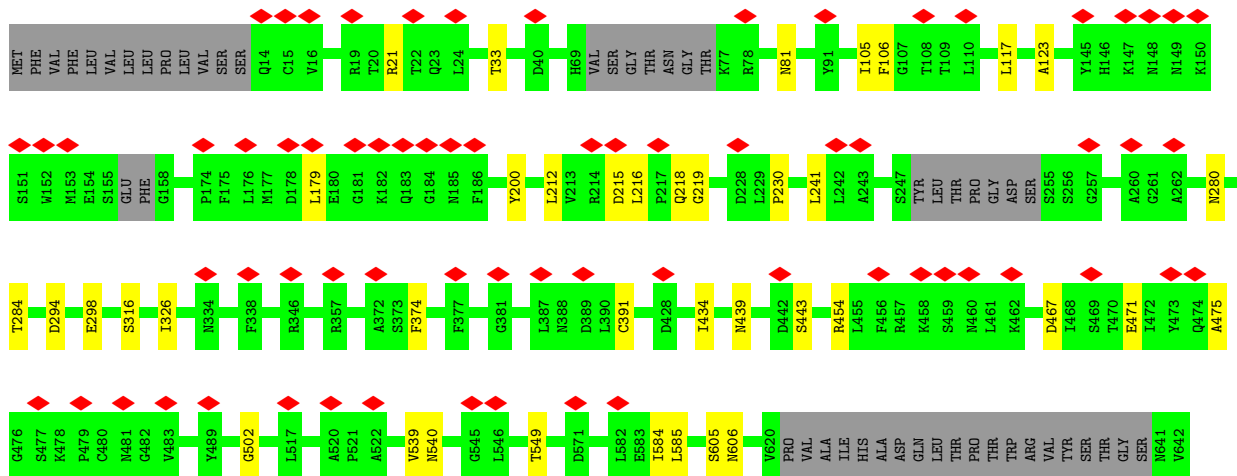
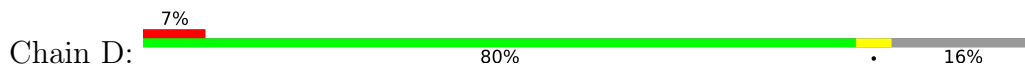

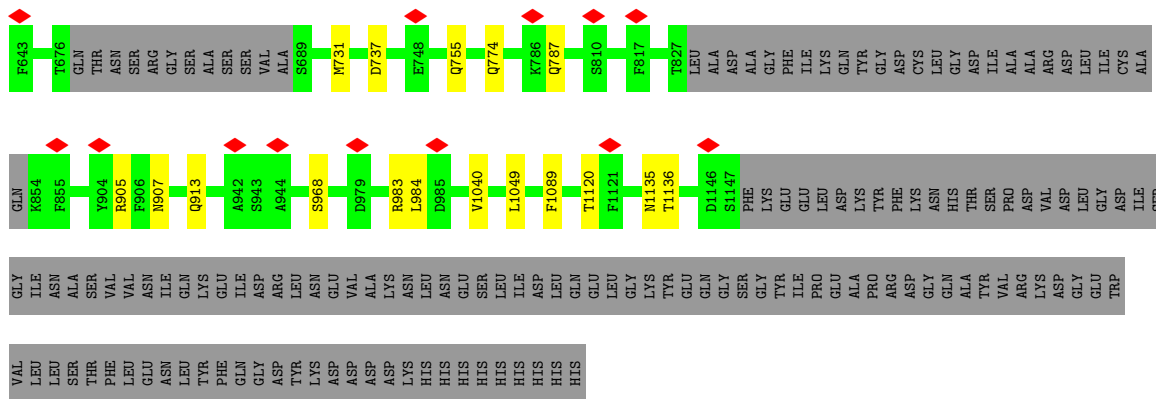

• Molecule 2: Angiotensin-converting enzyme 2

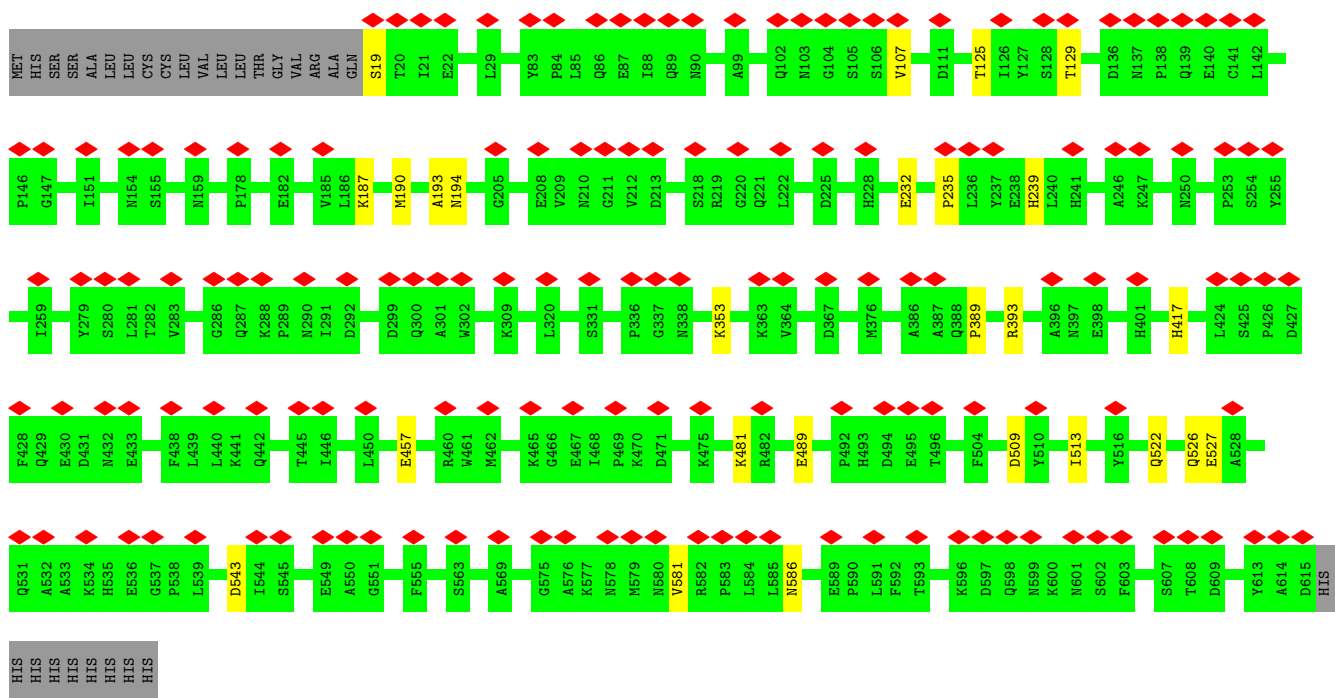
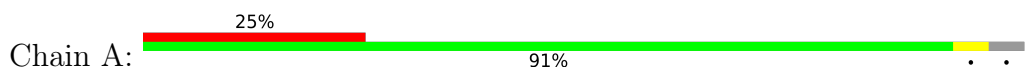

4 Experimental information

Property	Value	Source
EM reconstruction method	SINGLE PARTICLE	Depositor
Imposed symmetry	POINT, Not provided	
Number of particles used	41938	Depositor
Resolution determination method	FSC 0.143 CUT-OFF	Depositor
CTF correction method	PHASE FLIPPING AND AMPLITUDE CORRECTION	Depositor
Microscope	FEI TITAN KRIOS	Depositor
Voltage (kV)	300	Depositor
Electron dose ($e^-/\text{\AA}^2$)	50.2	Depositor
Minimum defocus (nm)	800	Depositor
Maximum defocus (nm)	2500	Depositor
Magnification	Not provided	
Image detector	GATAN K3 BIOQUANTUM (6k x 4k)	Depositor
Maximum map value	3.944	Depositor
Minimum map value	-2.268	Depositor
Average map value	0.007	Depositor
Map value standard deviation	0.111	Depositor
Recommended contour level	0.8	Depositor
Map size (\AA)	393.48, 393.48, 393.48	wwPDB
Map dimensions	360, 360, 360	wwPDB
Map angles ($^\circ$)	90.0, 90.0, 90.0	wwPDB
Pixel spacing (\AA)	1.093, 1.093, 1.093	Depositor

5 Model quality [i](#)

5.1 Standard geometry [i](#)

The Z score for a bond length (or angle) is the number of standard deviations the observed value is removed from the expected value. A bond length (or angle) with $|Z| > 5$ is considered an outlier worth inspection. RMSZ is the root-mean-square of all Z scores of the bond lengths (or angles).

Mol	Chain	Bond lengths		Bond angles	
		RMSZ	# Z >5	RMSZ	# Z >5
1	B	0.27	0/8479	0.48	0/11531
1	C	0.27	0/8479	0.47	0/11531
1	D	0.27	0/8479	0.47	0/11531
2	A	0.26	0/5007	0.42	0/6803
All	All	0.27	0/30444	0.46	0/41396

There are no bond length outliers.

There are no bond angle outliers.

There are no chirality outliers.

There are no planarity outliers.

5.2 Too-close contacts [i](#)

In the following table, the Non-H and H(model) columns list the number of non-hydrogen atoms and hydrogen atoms in the chain respectively. The H(added) column lists the number of hydrogen atoms added and optimized by MolProbity. The Clashes column lists the number of clashes within the asymmetric unit, whereas Symm-Clashes lists symmetry-related clashes.

Mol	Chain	Non-H	H(model)	H(added)	Clashes	Symm-Clashes
1	B	8289	0	8096	33	0
1	C	8289	0	8096	35	0
1	D	8289	0	8096	35	0
2	A	4870	0	4643	14	0
All	All	29737	0	28931	102	0

The all-atom clashscore is defined as the number of clashes found per 1000 atoms (including hydrogen atoms). The all-atom clashscore for this structure is 2.

All (102) close contacts within the same asymmetric unit are listed below, sorted by their clash magnitude.

Atom-1	Atom-2	Interatomic distance (Å)	Clash overlap (Å)
1:C:755:GLN:O	1:D:968:SER:OG	2.06	0.73
1:B:755:GLN:O	1:C:968:SER:OG	2.08	0.70
1:C:908:GLY:O	1:C:1038:LYS:NZ	2.24	0.70
1:C:879:ALA:O	1:C:883:THR:OG1	2.06	0.70
1:B:386:LYS:NZ	1:D:984:LEU:O	2.26	0.68
1:B:1011:GLN:OE1	1:B:1014:ARG:NH1	2.27	0.68
1:B:417:LYS:NZ	1:B:455:LEU:O	2.27	0.66
1:B:883:THR:OG1	1:C:707:TYR:OH	2.06	0.66
1:C:780:GLU:O	1:C:784:GLN:NE2	2.29	0.65
1:B:811:LYS:NZ	1:B:820:ASP:OD2	2.28	0.64
1:D:298:GLU:OE2	1:D:316:SER:OG	2.14	0.63
1:C:1030:SER:OG	1:D:1040:VAL:O	2.17	0.63
2:A:190:MET:O	2:A:194:ASN:ND2	2.31	0.62
1:C:105:ILE:HD11	1:C:241:LEU:HD21	1.82	0.61
1:C:324:GLU:OE2	1:C:537:LYS:NZ	2.29	0.61
1:B:394:ASN:ND2	1:D:200:TYR:OH	2.34	0.60
1:D:212:LEU:HD11	1:D:215:ASP:HA	1.85	0.58
1:D:907:ASN:ND2	1:D:913:GLN:OE1	2.37	0.57
1:B:968:SER:OG	1:D:755:GLN:O	2.24	0.55
1:C:759:PHE:CE2	1:C:763:LEU:HD11	2.41	0.55
1:C:280:ASN:OD1	1:C:284:THR:N	2.38	0.55
1:D:216:LEU:O	1:D:218:GLN:NE2	2.41	0.54
1:B:349:SER:OG	1:B:452:ARG:O	2.25	0.54
1:D:1135:ASN:OD1	1:D:1136:THR:N	2.40	0.54
2:A:353:LYS:O	1:D:502:GLY:N	2.41	0.54
1:D:326:ILE:HD12	1:D:539:VAL:HG21	1.90	0.53
1:D:454:ARG:NH2	1:D:467:ASP:OD2	2.42	0.53
1:C:804:GLN:OE1	1:C:935:GLN:NE2	2.41	0.53
2:A:235:PRO:O	2:A:239:HIS:ND1	2.40	0.53
1:D:540:ASN:OD1	1:D:549:THR:OG1	2.23	0.53
1:D:294:ASP:N	1:D:294:ASP:OD1	2.39	0.53
1:B:701:ALA:O	1:D:787:GLN:NE2	2.42	0.53
1:D:731:MET:N	1:D:774:GLN:OE1	2.42	0.53
1:B:900:MET:SD	1:B:917:TYR:OH	2.65	0.52
1:B:1089:PHE:O	1:B:1121:PHE:N	2.41	0.52
1:C:136:CYS:SG	1:C:137:ASN:N	2.83	0.52
1:C:393:THR:O	1:C:523:THR:OG1	2.24	0.52
2:A:389:PRO:O	2:A:393:ARG:N	2.43	0.52
1:B:373:SER:O	1:B:373:SER:OG	2.29	0.51
1:B:383:SER:N	1:D:983:ARG:O	2.43	0.51
2:A:125:THR:O	2:A:129:THR:OG1	2.20	0.51
1:C:128:ILE:HD12	1:C:170:TYR:HD2	1.76	0.51

Continued on next page...

Continued from previous page...

Atom-1	Atom-2	Interatomic distance (Å)	Clash overlap (Å)
1:C:907:ASN:ND2	1:C:913:GLN:OE1	2.43	0.51
1:C:33:THR:OG1	1:C:219:GLY:O	2.28	0.50
1:C:215:ASP:O	1:C:266:TYR:OH	2.22	0.49
2:A:19:SER:N	1:D:475:ALA:O	2.45	0.49
1:B:887:THR:HG21	1:B:894:LEU:HB2	1.94	0.49
1:C:973:ILE:N	1:C:992:GLN:OE1	2.44	0.49
1:B:142:GLY:O	1:B:155:SER:OG	2.30	0.48
1:B:943:SER:O	1:B:943:SER:OG	2.29	0.48
1:C:392:PHE:CD1	1:C:517:LEU:HD21	2.48	0.48
1:C:739:THR:O	1:C:743:CYS:N	2.44	0.48
1:D:105:ILE:CD1	1:D:241:LEU:HD21	2.42	0.48
1:D:280:ASN:OD1	1:D:284:THR:N	2.43	0.48
1:B:187:LYS:NZ	1:B:211:ASN:OD1	2.39	0.48
1:D:212:LEU:HD11	1:D:215:ASP:CA	2.42	0.48
1:C:108:THR:OG1	1:C:234:ASN:O	2.32	0.48
1:B:436:TRP:O	1:B:509:ARG:N	2.46	0.47
2:A:107:VAL:HG21	2:A:193:ALA:HB3	1.95	0.47
1:B:908:GLY:O	1:B:1038:LYS:NZ	2.48	0.47
2:A:527:GLU:OE2	2:A:586:ASN:ND2	2.46	0.47
1:D:33:THR:OG1	1:D:219:GLY:O	2.32	0.47
1:C:551:VAL:N	1:C:588:THR:O	2.47	0.46
1:D:1089:PHE:O	1:D:1120:THR:OG1	2.20	0.46
1:C:212:LEU:HD11	1:C:215:ASP:HA	1.97	0.46
1:B:228:ASP:OD2	1:B:228:ASP:N	2.46	0.46
1:B:357:ARG:NH1	1:D:230:PRO:O	2.49	0.46
1:C:201:PHE:CZ	1:C:235:ILE:HD12	2.51	0.45
1:C:128:ILE:HD12	1:C:170:TYR:CD2	2.51	0.45
1:C:546:LEU:HD11	1:C:573:THR:HG21	1.97	0.45
1:C:494:SER:OG	1:C:495:TYR:N	2.50	0.45
1:D:584:ILE:C	1:D:585:LEU:HD12	2.37	0.45
1:D:471:GLU:OE2	1:D:471:GLU:N	2.48	0.45
2:A:481:LYS:NZ	2:A:489:GLU:OE2	2.43	0.45
1:C:731:MET:N	1:C:774:GLN:OE1	2.49	0.44
1:C:97:LYS:O	1:C:182:LYS:NZ	2.28	0.44
2:A:522:GLN:NE2	2:A:526:GLN:OE1	2.50	0.44
1:D:21:ARG:NH2	1:D:81:ASN:O	2.51	0.44
1:C:105:ILE:CD1	1:C:241:LEU:HD21	2.47	0.44
1:B:317:ASN:ND2	1:D:737:ASP:OD2	2.51	0.43
1:B:916:LEU:O	1:B:920:GLN:N	2.51	0.43
1:D:905:ARG:NH1	1:D:1049:LEU:O	2.47	0.43
1:B:393:THR:OG1	1:B:394:ASN:N	2.52	0.43

Continued on next page...

Continued from previous page...

Atom-1	Atom-2	Interatomic distance (Å)	Clash overlap (Å)
1:C:86:PHE:N	1:C:236:THR:O	2.46	0.43
1:B:740:MET:SD	1:C:319:ARG:NE	2.91	0.43
1:C:354:ASN:OD1	1:C:399:SER:OG	2.28	0.43
2:A:187:LYS:NZ	2:A:509:ASP:OD2	2.48	0.43
2:A:417:HIS:N	2:A:543:ASP:OD2	2.51	0.43
1:D:439:ASN:O	1:D:443:SER:OG	2.26	0.42
1:B:455:LEU:N	1:B:491:PRO:O	2.52	0.42
1:B:620:VAL:HG12	1:B:651:ILE:HD12	2.00	0.42
1:B:598:ILE:HG23	1:B:664:ILE:HG21	2.01	0.42
1:D:123:ALA:HB2	1:D:179:LEU:HD11	2.02	0.42
1:B:883:THR:HG23	1:C:707:TYR:CE2	2.55	0.41
1:B:568:ASP:OD1	1:B:572:THR:N	2.47	0.41
1:B:106:PHE:O	1:B:117:LEU:N	2.52	0.41
1:B:552:LEU:HD11	1:B:585:LEU:HB2	2.02	0.41
1:D:106:PHE:O	1:D:117:LEU:N	2.50	0.41
2:A:457:GLU:OE2	2:A:513:ILE:N	2.53	0.41
1:D:374:PHE:CG	1:D:434:ILE:HD11	2.56	0.41
2:A:232:GLU:HB2	2:A:581:VAL:HG21	2.03	0.40
1:D:605:SER:OG	1:D:606:ASN:N	2.54	0.40

There are no symmetry-related clashes.

5.3 Torsion angles [i](#)

5.3.1 Protein backbone [i](#)

In the following table, the Percentiles column shows the percent Ramachandran outliers of the chain as a percentile score with respect to all PDB entries followed by that with respect to all EM entries.

The Analysed column shows the number of residues for which the backbone conformation was analysed, and the total number of residues.

Mol	Chain	Analysed	Favoured	Allowed	Outliers	Percentiles	
1	B	1046/1261 (83%)	1012 (97%)	34 (3%)	0	100	100
1	C	1046/1261 (83%)	1014 (97%)	32 (3%)	0	100	100
1	D	1046/1261 (83%)	1014 (97%)	32 (3%)	0	100	100
2	A	595/625 (95%)	587 (99%)	8 (1%)	0	100	100
All	All	3733/4408 (85%)	3627 (97%)	106 (3%)	0	100	100

There are no Ramachandran outliers to report.

5.3.2 Protein sidechains [i](#)

In the following table, the Percentiles column shows the percent sidechain outliers of the chain as a percentile score with respect to all PDB entries followed by that with respect to all EM entries.

The Analysed column shows the number of residues for which the sidechain conformation was analysed, and the total number of residues.

Mol	Chain	Analysed	Rotameric	Outliers	Percentiles	
1	B	925/1097 (84%)	925 (100%)	0	100	100
1	C	925/1097 (84%)	925 (100%)	0	100	100
1	D	925/1097 (84%)	924 (100%)	1 (0%)	92	97
2	A	527/552 (96%)	527 (100%)	0	100	100
All	All	3302/3843 (86%)	3301 (100%)	1 (0%)	100	100

All (1) residues with a non-rotameric sidechain are listed below:

Mol	Chain	Res	Type
1	D	391	CYS

Sometimes sidechains can be flipped to improve hydrogen bonding and reduce clashes. All (9) such sidechains are listed below:

Mol	Chain	Res	Type
1	B	317	ASN
1	B	703	ASN
1	C	148	ASN
1	C	334	ASN
1	C	437	ASN
2	A	121	ASN
2	A	139	GLN
2	A	522	GLN
1	D	787	GLN

5.3.3 RNA [i](#)

There are no RNA molecules in this entry.

5.4 Non-standard residues in protein, DNA, RNA chains [i](#)

There are no non-standard protein/DNA/RNA residues in this entry.

5.5 Carbohydrates [i](#)

There are no oligosaccharides in this entry.

5.6 Ligand geometry [i](#)

There are no ligands in this entry.

5.7 Other polymers [i](#)

There are no such residues in this entry.

5.8 Polymer linkage issues [i](#)

There are no chain breaks in this entry.

6 Map visualisation [i](#)

This section contains visualisations of the EMDB entry EMD-32363. These allow visual inspection of the internal detail of the map and identification of artifacts.

No raw map or half-maps were deposited for this entry and therefore no images, graphs, etc. pertaining to the raw map can be shown.

6.1 Orthogonal projections [i](#)

6.1.1 Primary map

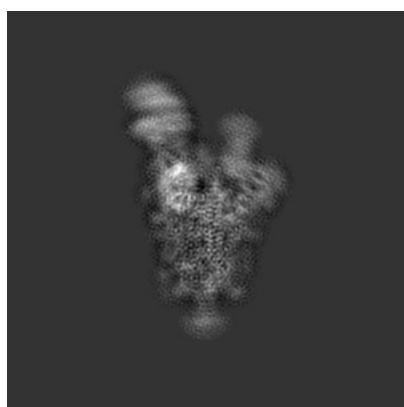

X

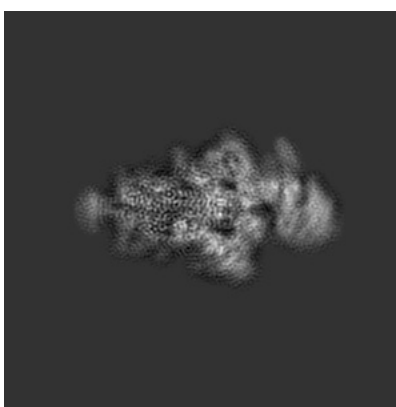

Y

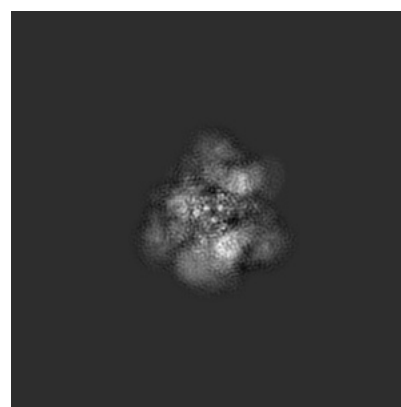

Z

The images above show the map projected in three orthogonal directions.

6.2 Central slices [i](#)

6.2.1 Primary map

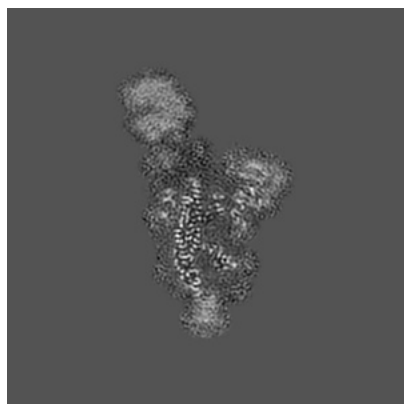

X Index: 180

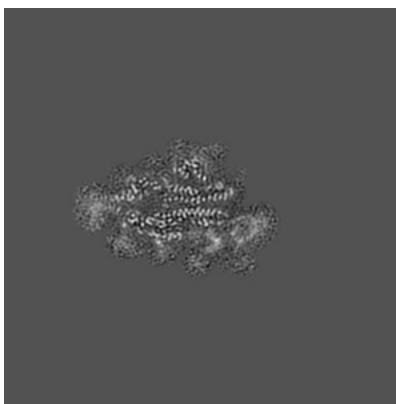

Y Index: 180

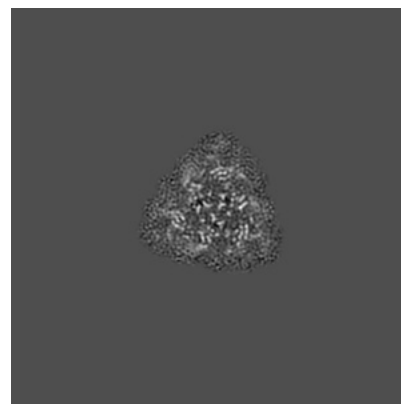

Z Index: 180

The images above show central slices of the map in three orthogonal directions.

6.3 Largest variance slices [i](#)

6.3.1 Primary map

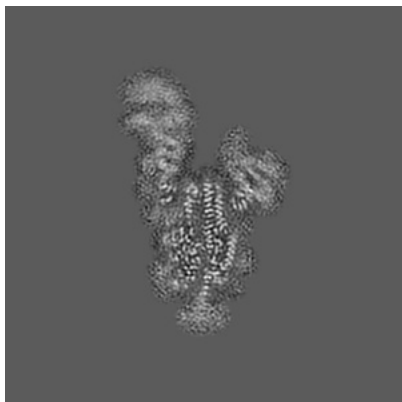

X Index: 189

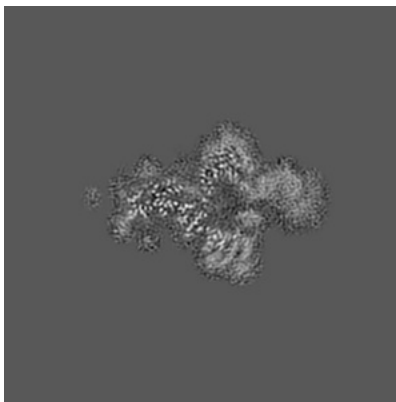

Y Index: 156

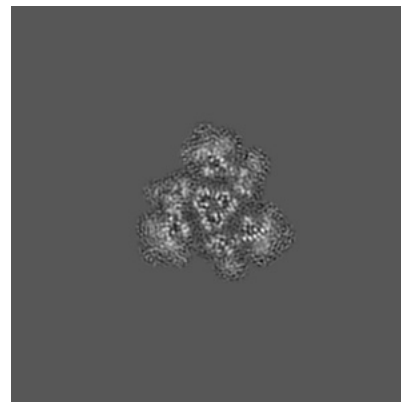

Z Index: 193

The images above show the largest variance slices of the map in three orthogonal directions.

6.4 Orthogonal standard-deviation projections (False-color) [i](#)

6.4.1 Primary map

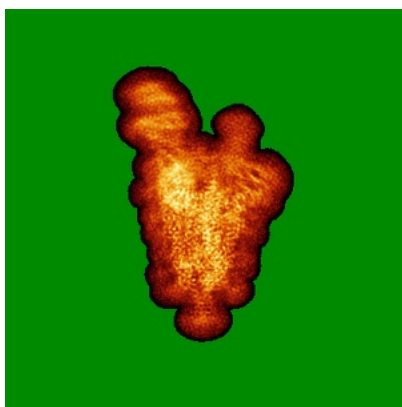

X

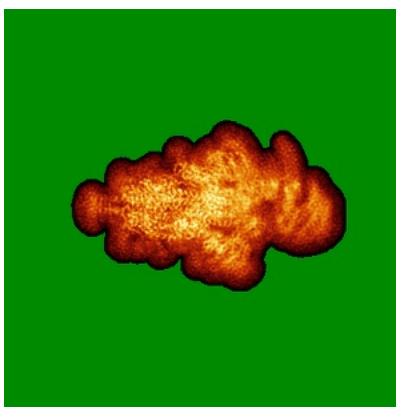

Y

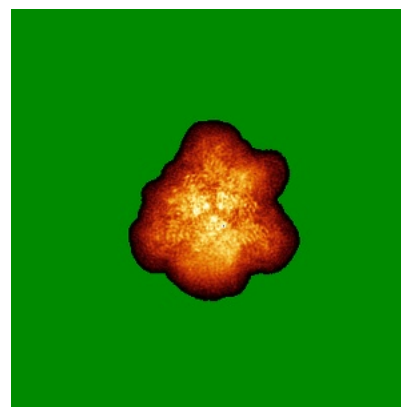

Z

The images above show the map standard deviation projections with false color in three orthogonal directions. Minimum values are shown in green, max in blue, and dark to light orange shades represent small to large values respectively.

6.5 Orthogonal surface views [i](#)

6.5.1 Primary map

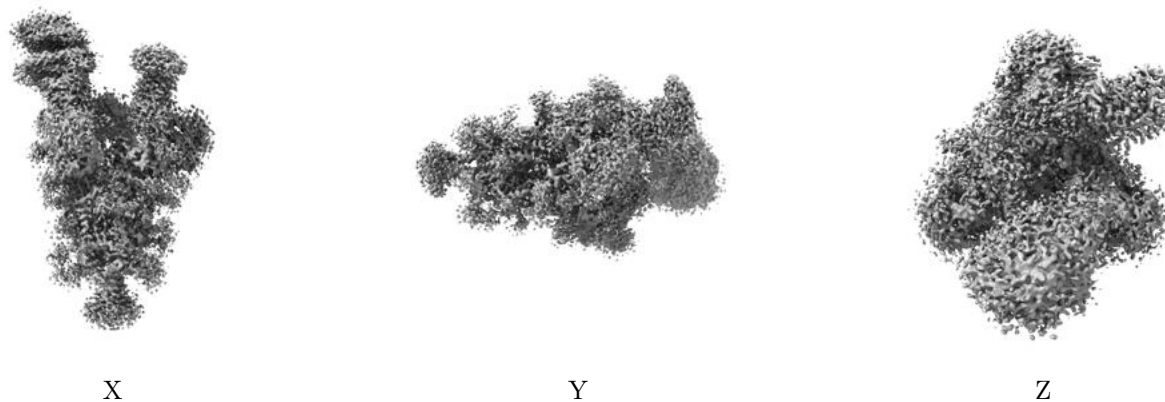

The images above show the 3D surface view of the map at the recommended contour level 0.8. These images, in conjunction with the slice images, may facilitate assessment of whether an appropriate contour level has been provided.

6.6 Mask visualisation [i](#)

This section was not generated. No masks/segmentation were deposited.

7 Map analysis [i](#)

This section contains the results of statistical analysis of the map.

7.1 Map-value distribution [i](#)

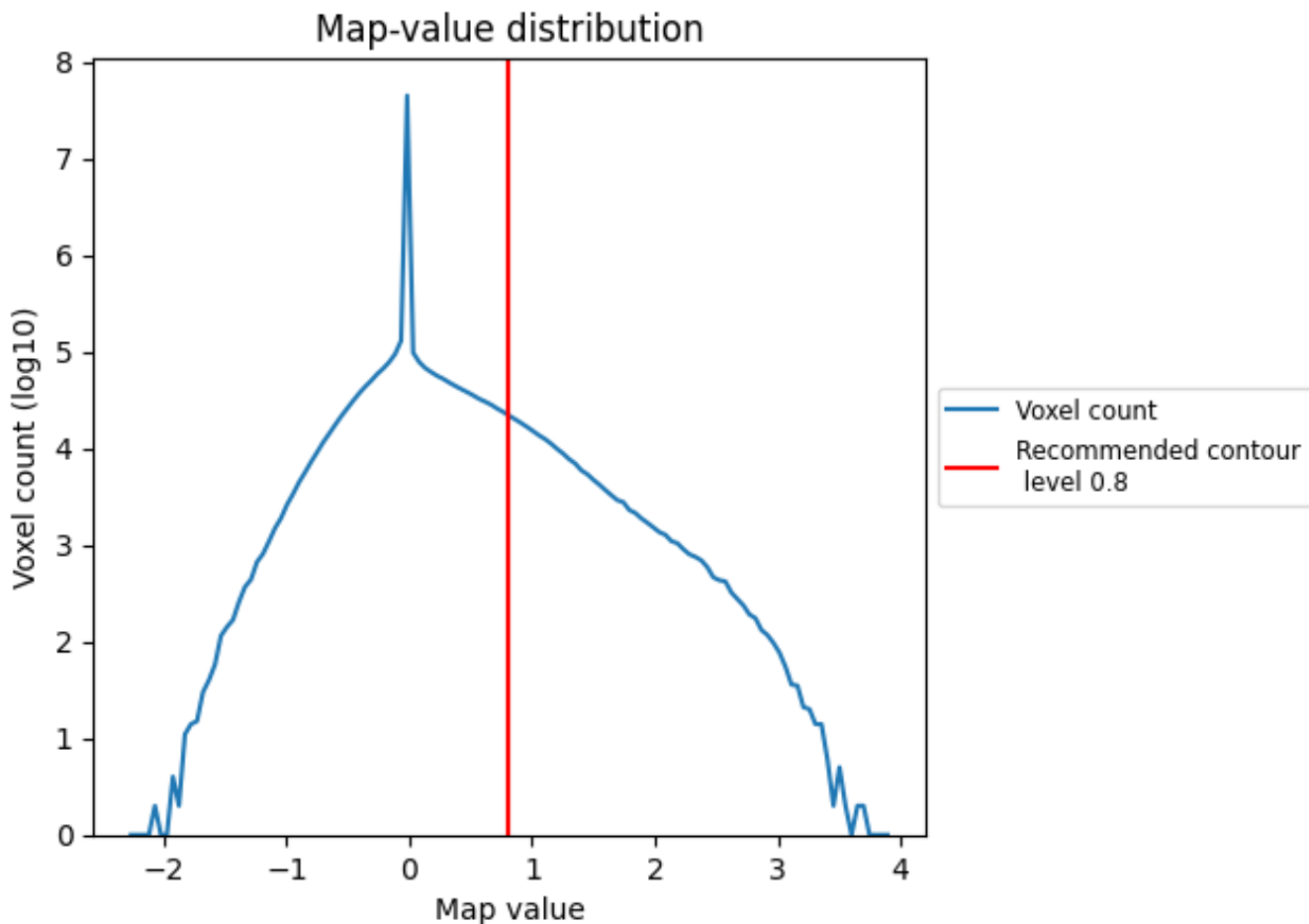

The map-value distribution is plotted in 128 intervals along the x-axis. The y-axis is logarithmic. A spike in this graph at zero usually indicates that the volume has been masked.

7.2 Volume estimate [i](#)

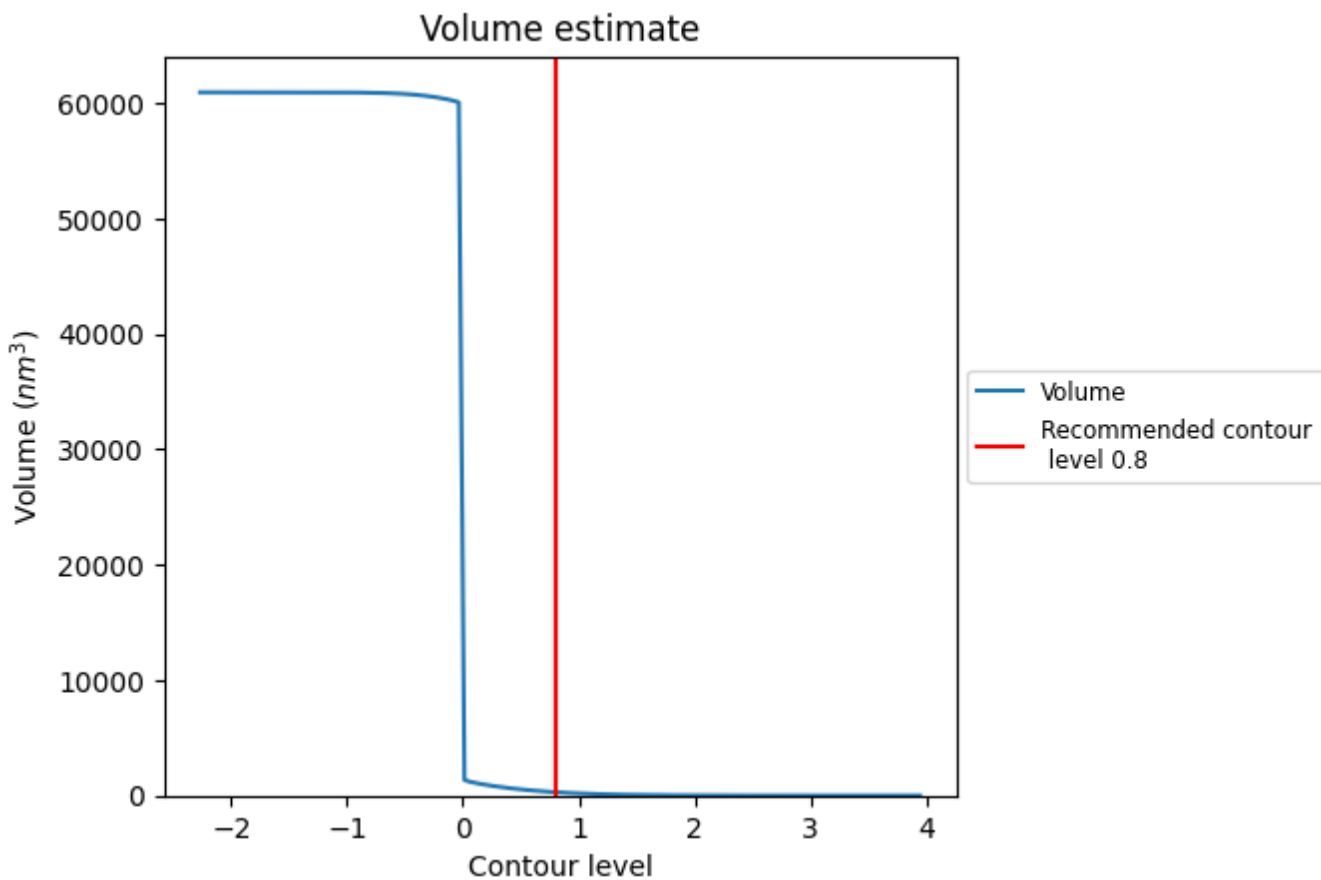

The volume at the recommended contour level is 291 nm³; this corresponds to an approximate mass of 263 kDa.

The volume estimate graph shows how the enclosed volume varies with the contour level. The recommended contour level is shown as a vertical line and the intersection between the line and the curve gives the volume of the enclosed surface at the given level.

7.3 Rotationally averaged power spectrum [i](#)

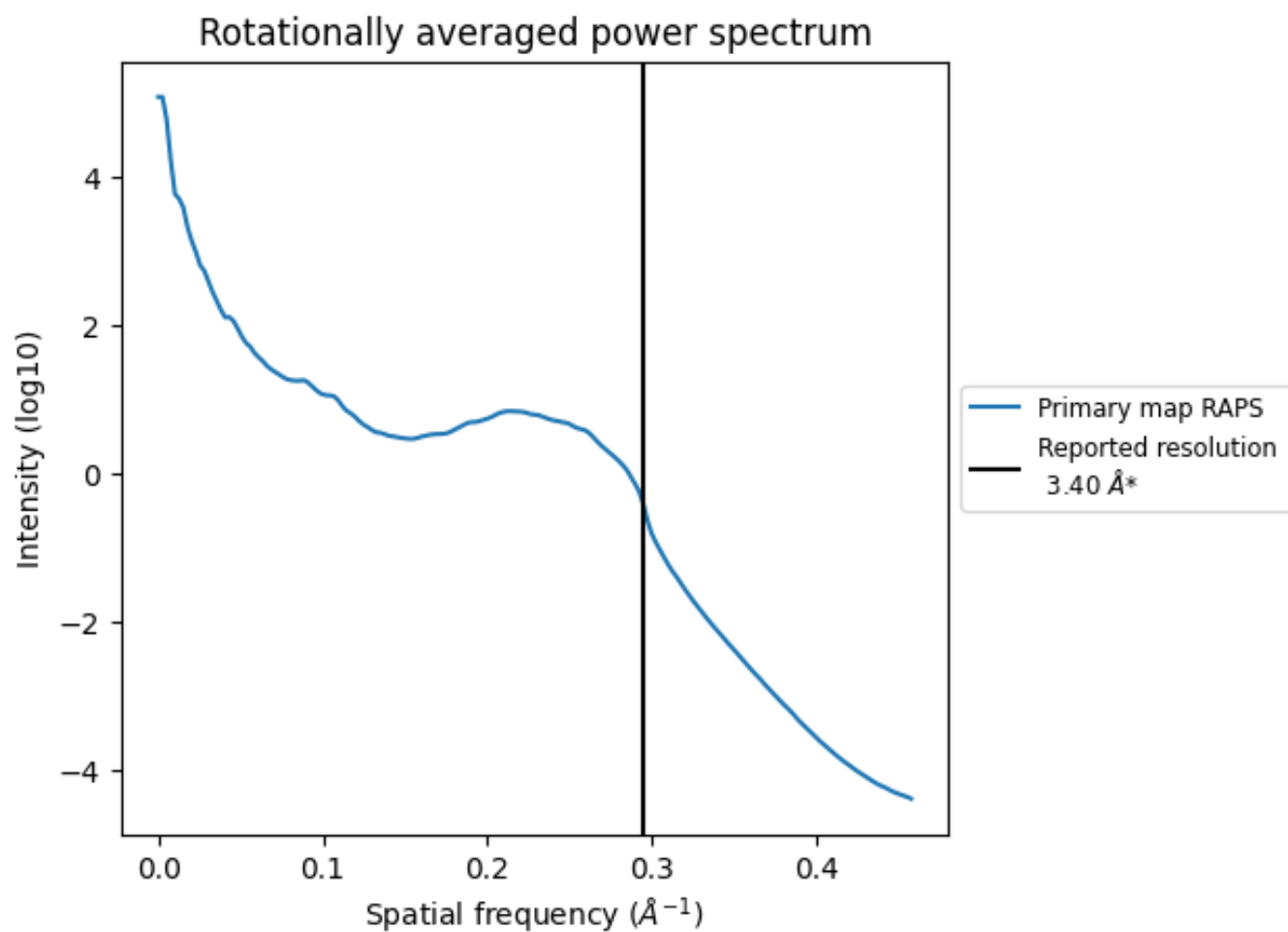

*Reported resolution corresponds to spatial frequency of 0.294 Å⁻¹

8 Fourier-Shell correlation

This section was not generated. No FSC curve or half-maps provided.

9 Map-model fit [i](#)

This section contains information regarding the fit between EMDB map EMD-32363 and PDB model 7W9B. Per-residue inclusion information can be found in section [3](#) on page [10](#).

9.1 Map-model overlay [i](#)

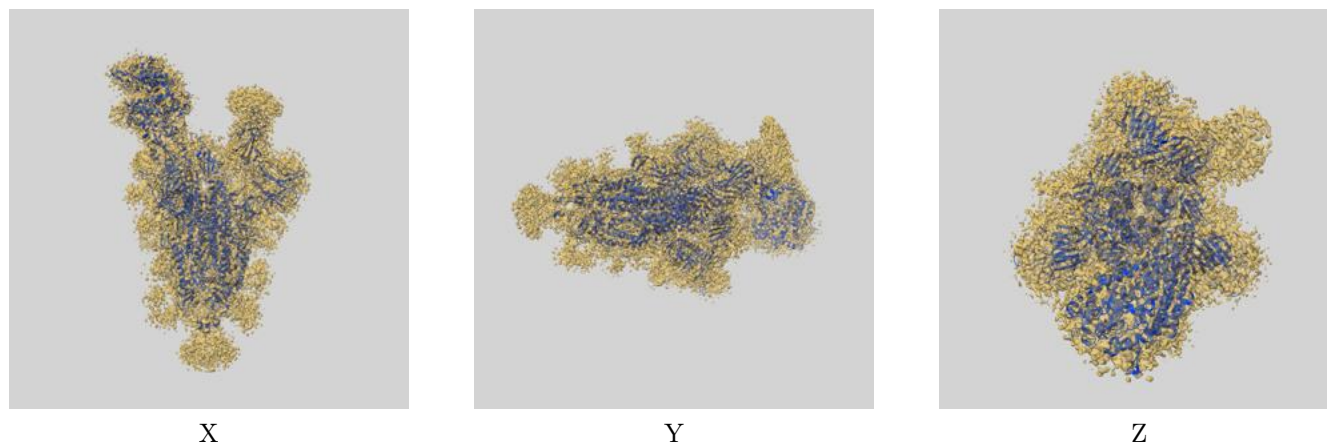

The images above show the 3D surface view of the map at the recommended contour level 0.8 at 50% transparency in yellow overlaid with a ribbon representation of the model coloured in blue. These images allow for the visual assessment of the quality of fit between the atomic model and the map.

9.2 Q-score mapped to coordinate model [i](#)

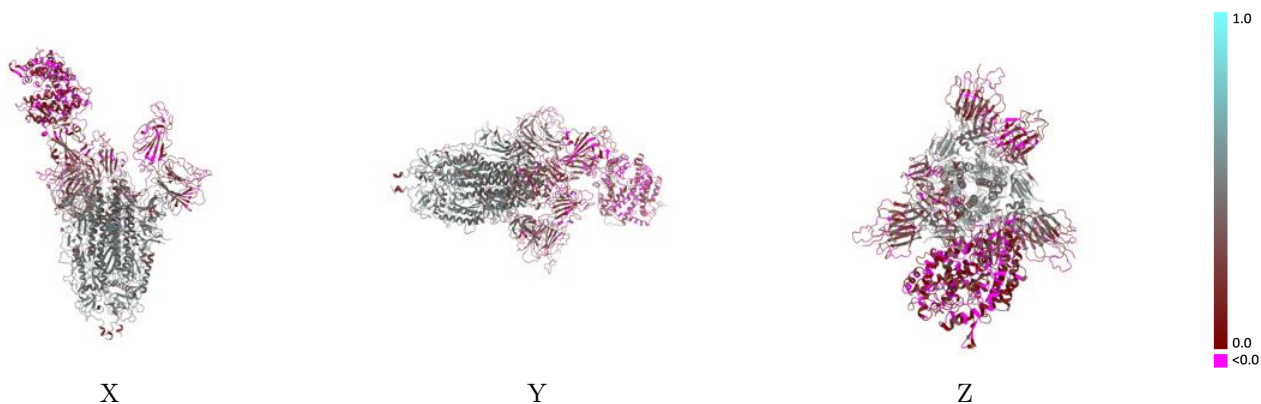

The images above show the model with each residue coloured according to its Q-score. This shows their resolvability in the map with higher Q-score values reflecting better resolvability. Please note: Q-score is calculating the resolvability of atoms, and thus high values are only expected at resolutions at which atoms can be resolved. Low Q-score values may therefore be expected for many entries.

9.3 Atom inclusion mapped to coordinate model [i](#)

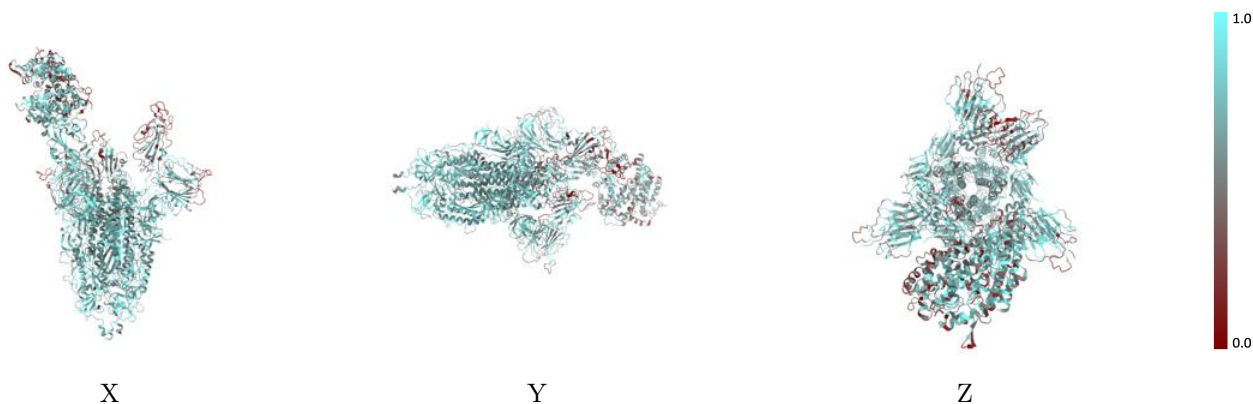

The images above show the model with each residue coloured according to its atom inclusion. This shows to what extent they are inside the map at the recommended contour level (0.8).



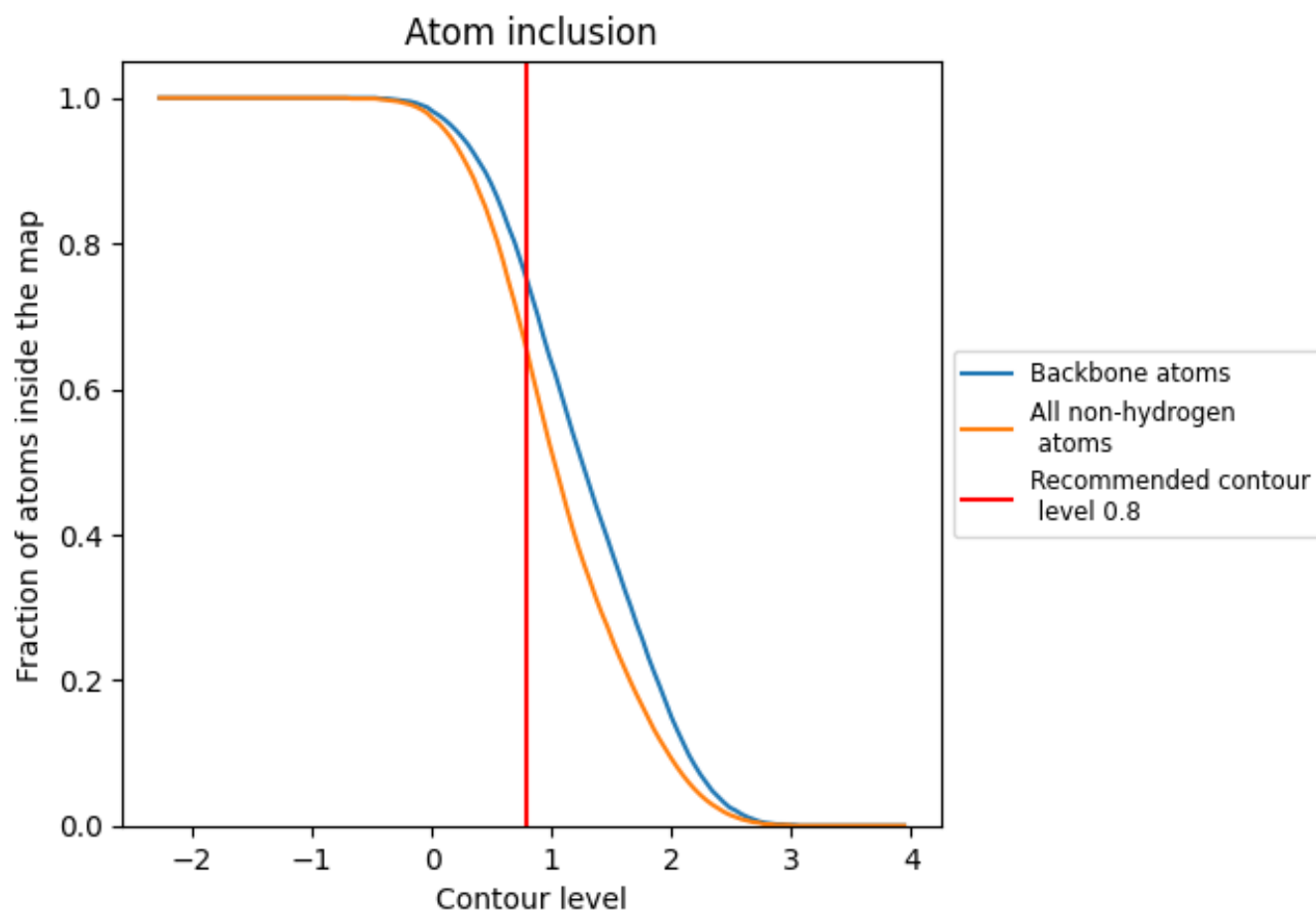







9.4 Atom inclusion [i](#)



At the recommended contour level, 75% of all backbone atoms, 65% of all non-hydrogen atoms, are inside the map.

9.5 Map-model fit summary [i](#)

The table lists the average atom inclusion at the recommended contour level (0.8) and Q-score for the entire model and for each chain.

Chain	Atom inclusion	Q-score
All	 0.6500	 0.3080
A	 0.5760	 0.0970
B	 0.6520	 0.3410
C	 0.6440	 0.3500
D	 0.6960	 0.3580

