



Full wwPDB X-ray Structure Validation Report ⓘ

Dec 6, 2023 – 10:24 pm GMT

PDB ID : 2WGS
Title : Crystal structure of Mycobacterium Tuberculosis Glutamine Synthetase in complex with a purine analogue inhibitor.
Authors : Nilsson, M.T.; Krajewski, W.W.; Jones, T.A.; Mowbray, S.L.
Deposited on : 2009-04-27
Resolution : 2.55 Å(reported)

This is a Full wwPDB X-ray Structure Validation Report for a publicly released PDB entry.

We welcome your comments at validation@mail.wwpdb.org

A user guide is available at

<https://www.wwpdb.org/validation/2017/XrayValidationReportHelp>

with specific help available everywhere you see the ⓘ symbol.

The types of validation reports are described at

<http://www.wwpdb.org/validation/2017/FAQs#types>.

The following versions of software and data (see [references ⓘ](#)) were used in the production of this report:

MolProbity : 4.02b-467
Mogul : 1.8.4, CSD as541be (2020)
Xtriage (Phenix) : 1.13
EDS : 2.36
buster-report : 1.1.7 (2018)
Percentile statistics : 20191225.v01 (using entries in the PDB archive December 25th 2019)
Refmac : 5.8.0158
CCP4 : 7.0.044 (Gargrove)
Ideal geometry (proteins) : Engh & Huber (2001)
Ideal geometry (DNA, RNA) : Parkinson et al. (1996)
Validation Pipeline (wwPDB-VP) : 2.36

1 Overall quality at a glance

The following experimental techniques were used to determine the structure:

X-RAY DIFFRACTION

The reported resolution of this entry is 2.55 Å.

Percentile scores (ranging between 0-100) for global validation metrics of the entry are shown in the following graphic. The table shows the number of entries on which the scores are based.

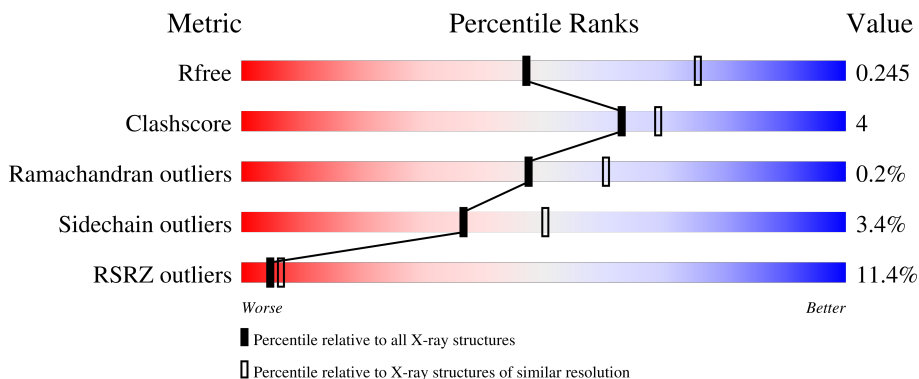

Metric	Whole archive (#Entries)	Similar resolution (#Entries, resolution range(Å))
R_{free}	130704	1284 (2.56-2.52)
Clashscore	141614	1332 (2.56-2.52)
Ramachandran outliers	138981	1315 (2.56-2.52)
Sidechain outliers	138945	1315 (2.56-2.52)
RSRZ outliers	127900	1272 (2.56-2.52)

The table below summarises the geometric issues observed across the polymeric chains and their fit to the electron density. The red, orange, yellow and green segments of the lower bar indicate the fraction of residues that contain outliers for ≥ 3 , 2, 1 and 0 types of geometric quality criteria respectively. A grey segment represents the fraction of residues that are not modelled. The numeric value for each fraction is indicated below the corresponding segment, with a dot representing fractions $\leq 5\%$. The upper red bar (where present) indicates the fraction of residues that have poor fit to the electron density. The numeric value is given above the bar.

Mol	Chain	Length	Quality of chain
1	A	486	 9% 83% 12% • 5%
1	B	486	 10% 85% 9% • 5%
1	C	486	 14% 85% 9% • 5%
1	D	486	 9% 84% 10% • 5%
1	E	486	 8% 85% 9% • 5%

Continued on next page...

Continued from previous page...

Mol	Chain	Length	Quality of chain
1	F	486	<p>9% 84% 11% • 5%</p>
1	G	486	<p>10% 84% 10% • 5%</p>
1	H	486	<p>10% 85% 9% • 5%</p>
1	I	486	<p>12% 85% 9% • 5%</p>
1	J	486	<p>17% 83% 11% • 5%</p>
1	K	486	<p>11% 85% 10% • 5%</p>
1	L	486	<p>10% 86% 8% • 5%</p>

2 Entry composition [i](#)

There are 4 unique types of molecules in this entry. The entry contains 45804 atoms, of which 0 are hydrogens and 0 are deuteriums.

In the tables below, the ZeroOcc column contains the number of atoms modelled with zero occupancy, the AltConf column contains the number of residues with at least one atom in alternate conformation and the Trace column contains the number of residues modelled with at most 2 atoms.

- Molecule 1 is a protein called GLUTAMINE SYNTHETASE 1.

Mol	Chain	Residues	Atoms					ZeroOcc	AltConf	Trace
			Total	C	N	O	S			
1	A	463	3660	2331	617	700	12	0	0	0
1	B	463	3660	2331	617	700	12	0	0	0
1	C	463	3660	2331	617	700	12	0	0	0
1	D	463	3660	2331	617	700	12	0	0	0
1	E	463	3660	2331	617	700	12	0	0	0
1	F	463	3660	2331	617	700	12	0	0	0
1	G	463	3660	2331	617	700	12	0	0	0
1	H	463	3660	2331	617	700	12	0	0	0
1	I	463	3660	2331	617	700	12	0	0	0
1	J	463	3660	2331	617	700	12	0	0	0
1	K	463	3660	2331	617	700	12	0	0	0
1	L	463	3660	2331	617	700	12	0	0	0

- Molecule 2 is 1-(3,4-dichlorobenzyl)-3,7-dimethyl-8-morpholin-4-yl-3,7-dihydro-1H-purine-2,6-dione (three-letter code: 1AZ) (formula: C₁₈H₁₉Cl₂N₅O₃).

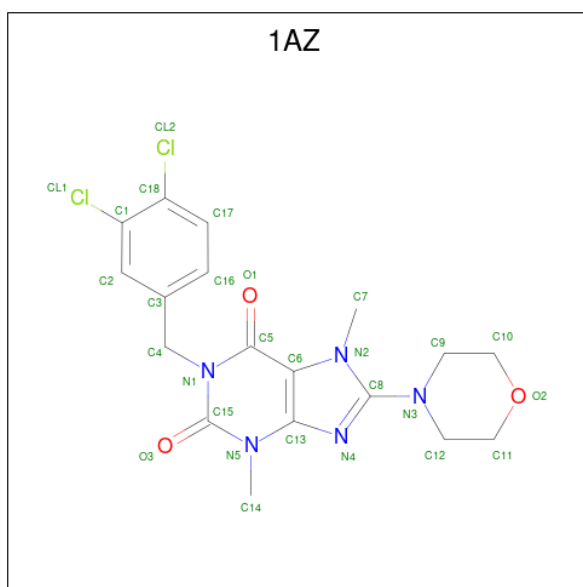

Mol	Chain	Residues	Atoms				ZeroOcc	AltConf	
			Total	C	Cl	N			O
2	A	1	Total	C	Cl	N	O	0	0
			28	18	2	5	3		
2	B	1	Total	C	Cl	N	O	0	0
			28	18	2	5	3		
2	C	1	Total	C	Cl	N	O	0	0
			28	18	2	5	3		
2	D	1	Total	C	Cl	N	O	0	0
			28	18	2	5	3		
2	E	1	Total	C	Cl	N	O	0	0
			28	18	2	5	3		
2	F	1	Total	C	Cl	N	O	0	0
			28	18	2	5	3		
2	G	1	Total	C	Cl	N	O	0	0
			28	18	2	5	3		
2	H	1	Total	C	Cl	N	O	0	0
			28	18	2	5	3		
2	I	1	Total	C	Cl	N	O	0	0
			28	18	2	5	3		
2	J	1	Total	C	Cl	N	O	0	0
			28	18	2	5	3		
2	K	1	Total	C	Cl	N	O	0	0
			28	18	2	5	3		
2	L	1	Total	C	Cl	N	O	0	0
			28	18	2	5	3		

- Molecule 3 is CHLORIDE ION (three-letter code: CL) (formula: Cl).

Mol	Chain	Residues	Atoms	ZeroOcc	AltConf
3	A	1	Total Cl 1 1	0	0
3	B	1	Total Cl 1 1	0	0
3	C	1	Total Cl 1 1	0	0
3	D	1	Total Cl 1 1	0	0
3	E	1	Total Cl 1 1	0	0
3	F	1	Total Cl 1 1	0	0
3	G	1	Total Cl 1 1	0	0
3	H	1	Total Cl 1 1	0	0
3	I	1	Total Cl 1 1	0	0
3	J	1	Total Cl 1 1	0	0
3	K	1	Total Cl 1 1	0	0
3	L	1	Total Cl 1 1	0	0

- Molecule 4 is water.

Mol	Chain	Residues	Atoms	ZeroOcc	AltConf
4	A	126	Total O 126 126	0	0
4	B	129	Total O 129 129	0	0
4	C	130	Total O 130 130	0	0
4	D	127	Total O 127 127	0	0
4	E	130	Total O 130 130	0	0
4	F	127	Total O 127 127	0	0
4	G	126	Total O 126 126	0	0
4	H	129	Total O 129 129	0	0

Continued on next page...

Continued from previous page...

Mol	Chain	Residues	Atoms		ZeroOcc	AltConf
4	I	126	Total 126	O 126	0	0
4	J	126	Total 126	O 126	0	0
4	K	131	Total 131	O 131	0	0
4	L	129	Total 129	O 129	0	0

3 Residue-property plots [i](#)

These plots are drawn for all protein, RNA, DNA and oligosaccharide chains in the entry. The first graphic for a chain summarises the proportions of the various outlier classes displayed in the second graphic. The second graphic shows the sequence view annotated by issues in geometry and electron density. Residues are color-coded according to the number of geometric quality criteria for which they contain at least one outlier: green = 0, yellow = 1, orange = 2 and red = 3 or more. A red dot above a residue indicates a poor fit to the electron density ($RSRZ > 2$). Stretches of 2 or more consecutive residues without any outlier are shown as a green connector. Residues present in the sample, but not in the model, are shown in grey.

• Molecule 1: GLUTAMINE SYNTHETASE 1

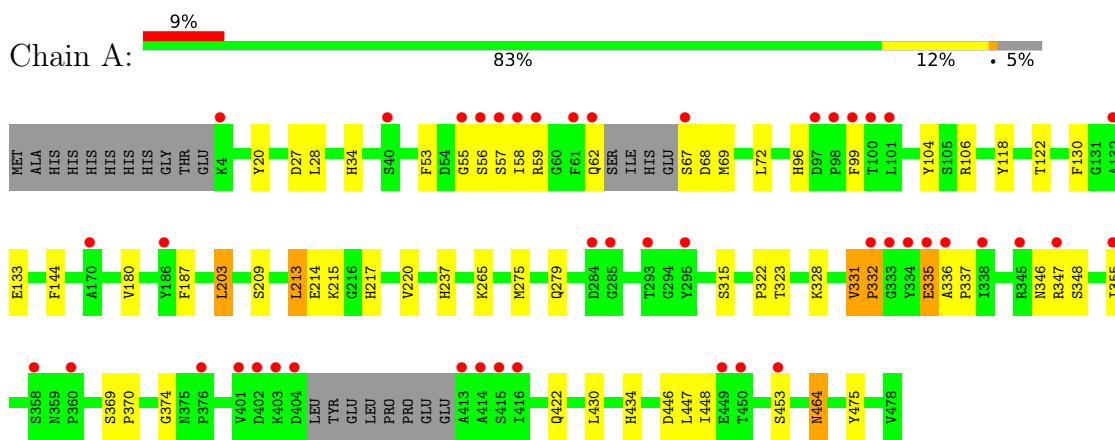

• Molecule 1: GLUTAMINE SYNTHETASE 1

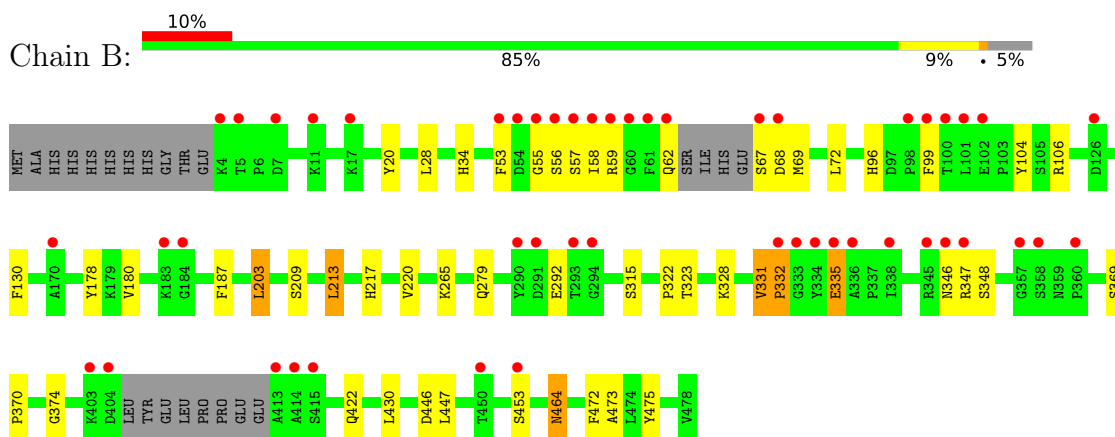

• Molecule 1: GLUTAMINE SYNTHETASE 1

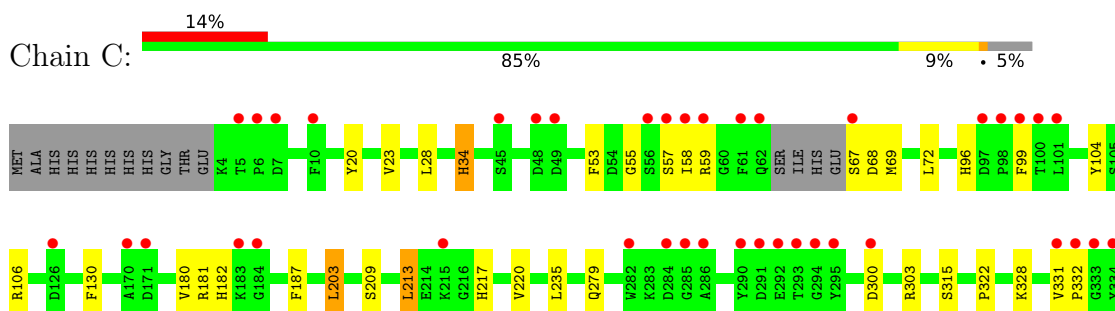

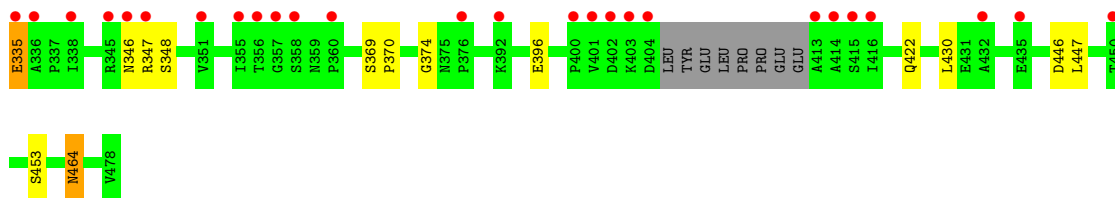

• Molecule 1: GLUTAMINE SYNTHETASE 1

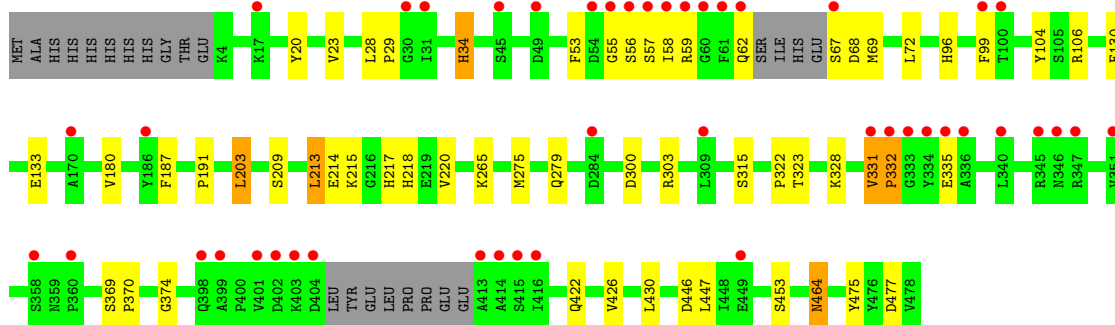
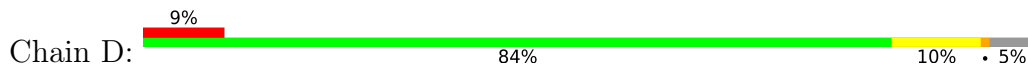

• Molecule 1: GLUTAMINE SYNTHETASE 1

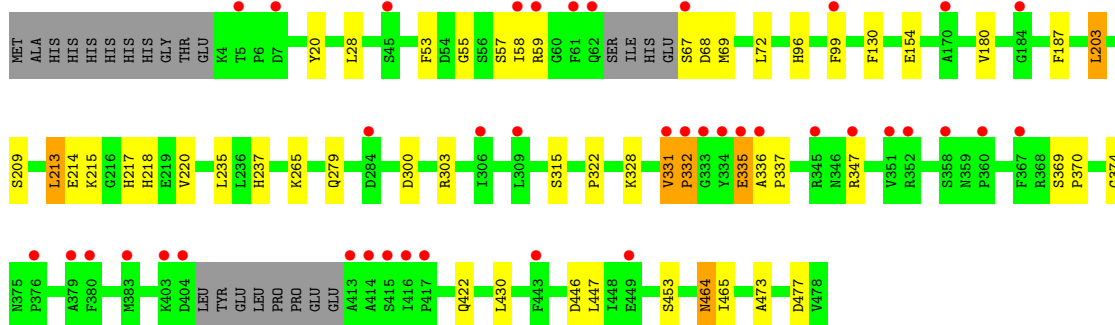
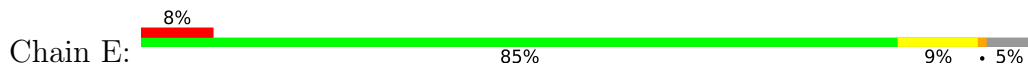

• Molecule 1: GLUTAMINE SYNTHETASE 1

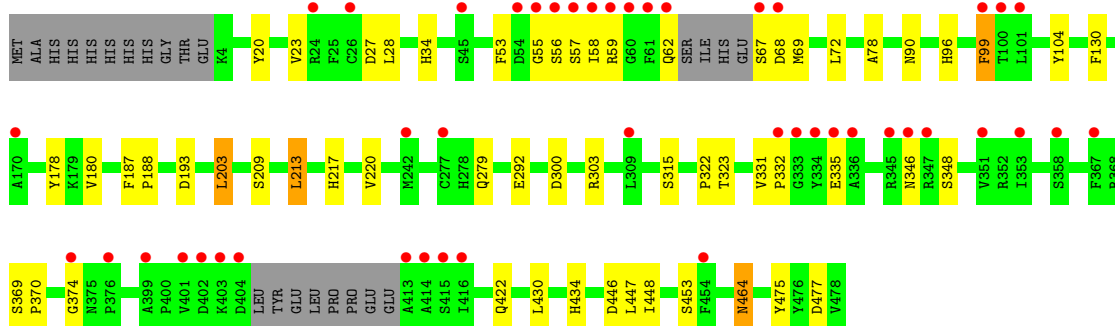
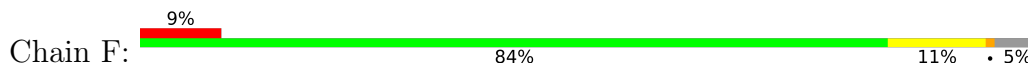

• Molecule 1: GLUTAMINE SYNTHETASE 1

Chain G:  10% 84% 10% • 5%

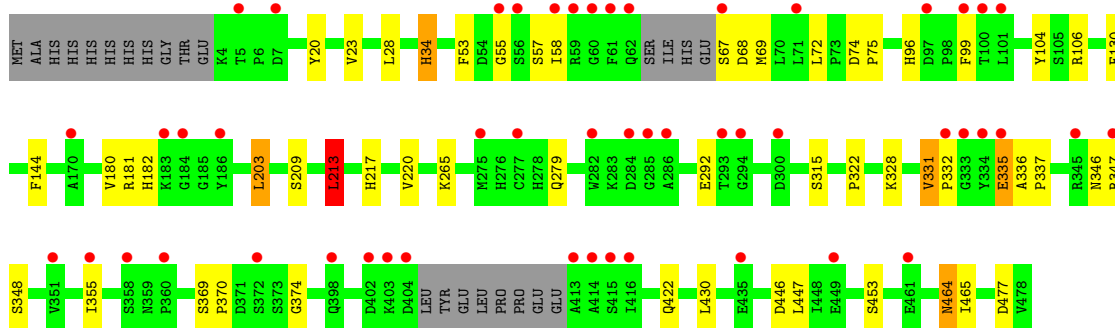

• Molecule 1: GLUTAMINE SYNTHETASE 1

Chain H:  10% 85% 9% • 5%

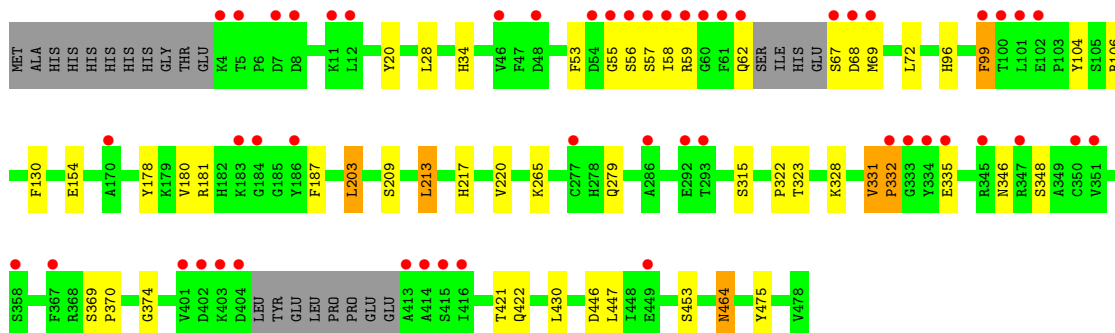

• Molecule 1: GLUTAMINE SYNTHETASE 1

Chain I:  12% 85% 9% • 5%

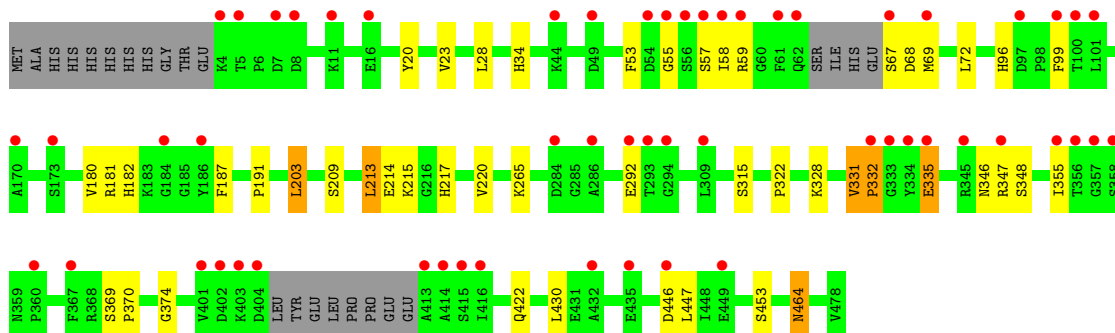

• Molecule 1: GLUTAMINE SYNTHETASE 1

Chain J:  17% 83% 11% • 5%



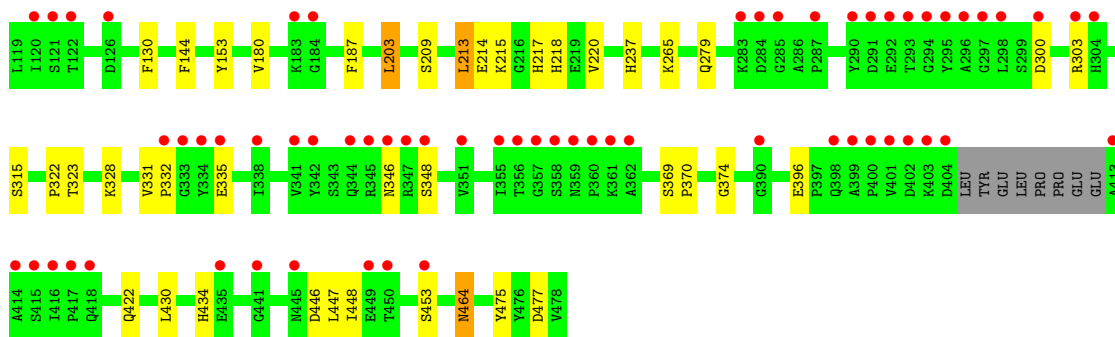

• Molecule 1: GLUTAMINE SYNTHETASE 1

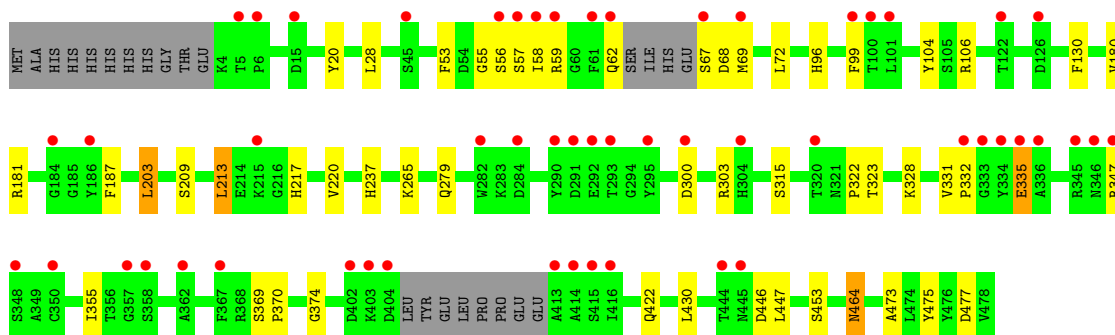
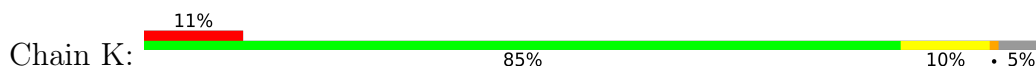

• Molecule 1: GLUTAMINE SYNTHETASE 1

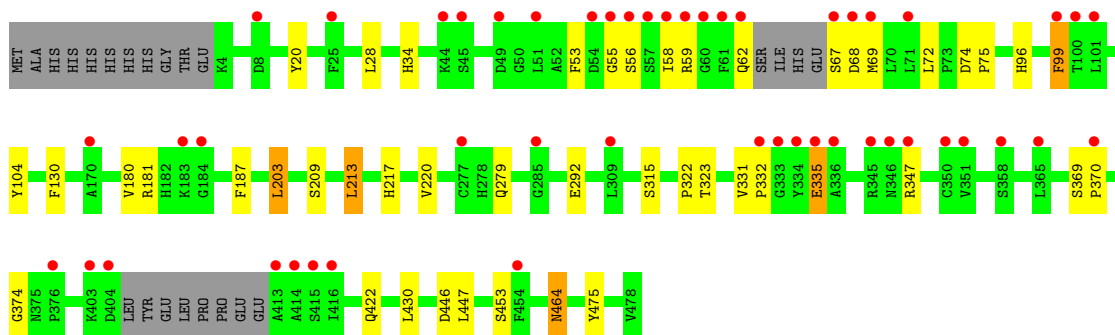
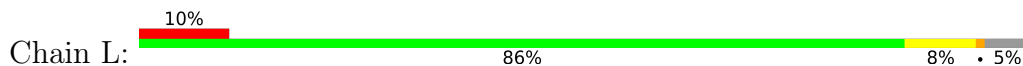

4 Data and refinement statistics

Property	Value	Source
Space group	P 21 21 21	Depositor
Cell constants a, b, c, α , β , γ	134.95Å 203.18Å 230.20Å 90.00° 90.00° 90.00°	Depositor
Resolution (Å)	29.95 – 2.55 29.94 – 2.55	Depositor EDS
% Data completeness (in resolution range)	99.8 (29.95-2.55) 99.8 (29.94-2.55)	Depositor EDS
R_{merge}	0.09	Depositor
R_{sym}	(Not available)	Depositor
$\langle I/\sigma(I) \rangle$ ¹	3.35 (at 2.54Å)	Xtrriage
Refinement program	REFMAC 5.2.0019	Depositor
R, R_{free}	0.230 , 0.246 0.229 , 0.245	Depositor DCC
R_{free} test set	10318 reflections (5.03%)	wwPDB-VP
Wilson B-factor (Å ²)	42.3	Xtrriage
Anisotropy	0.210	Xtrriage
Bulk solvent k_{sol} (e/Å ³), B_{sol} (Å ²)	0.33 , 30.6	EDS
L-test for twinning ²	$\langle L \rangle = 0.48$, $\langle L^2 \rangle = 0.32$	Xtrriage
Estimated twinning fraction	No twinning to report.	Xtrriage
F_o, F_c correlation	0.93	EDS
Total number of atoms	45804	wwPDB-VP
Average B, all atoms (Å ²)	41.0	wwPDB-VP

Xtrriage's analysis on translational NCS is as follows: *The analyses of the Patterson function reveals a significant off-origin peak that is 46.94 % of the origin peak, indicating pseudo-translational symmetry. The chance of finding a peak of this or larger height randomly in a structure without pseudo-translational symmetry is equal to 1.0653e-04. The detected translational NCS is most likely also responsible for the elevated intensity ratio.*

¹Intensities estimated from amplitudes.

²Theoretical values of $\langle |L| \rangle$, $\langle L^2 \rangle$ for acentric reflections are 0.5, 0.333 respectively for untwinned datasets, and 0.375, 0.2 for perfectly twinned datasets.

5 Model quality [i](#)

5.1 Standard geometry [i](#)

Bond lengths and bond angles in the following residue types are not validated in this section: CL, 1AZ

The Z score for a bond length (or angle) is the number of standard deviations the observed value is removed from the expected value. A bond length (or angle) with $|Z| > 5$ is considered an outlier worth inspection. RMSZ is the root-mean-square of all Z scores of the bond lengths (or angles).

Mol	Chain	Bond lengths		Bond angles	
		RMSZ	# Z >5	RMSZ	# Z >5
1	A	0.52	0/3760	0.60	1/5105 (0.0%)
1	B	0.53	0/3760	0.60	0/5105
1	C	0.54	0/3760	0.59	0/5105
1	D	0.52	0/3760	0.60	0/5105
1	E	0.52	0/3760	0.60	0/5105
1	F	0.51	0/3760	0.60	1/5105 (0.0%)
1	G	0.53	0/3760	0.60	1/5105 (0.0%)
1	H	0.53	0/3760	0.60	0/5105
1	I	0.53	0/3760	0.60	0/5105
1	J	0.59	0/3760	0.60	0/5105
1	K	0.55	0/3760	0.59	0/5105
1	L	0.52	0/3760	0.59	0/5105
All	All	0.53	0/45120	0.60	3/61260 (0.0%)

There are no bond length outliers.

All (3) bond angle outliers are listed below:

Mol	Chain	Res	Type	Atoms	Z	Observed(°)	Ideal(°)
1	F	27	ASP	CB-CG-OD1	5.66	123.39	118.30
1	A	27	ASP	CB-CG-OD1	5.14	122.93	118.30
1	G	213	LEU	CA-CB-CG	5.09	127.02	115.30

There are no chirality outliers.

There are no planarity outliers.

5.2 Too-close contacts [i](#)

In the following table, the Non-H and H(model) columns list the number of non-hydrogen atoms and hydrogen atoms in the chain respectively. The H(added) column lists the number of hydrogen

atoms added and optimized by MolProbity. The Clashes column lists the number of clashes within the asymmetric unit, whereas Symm-Clashes lists symmetry-related clashes.

Mol	Chain	Non-H	H(model)	H(added)	Clashes	Symm-Clashes
1	A	3660	0	3497	47	0
1	B	3660	0	3497	41	0
1	C	3660	0	3497	39	0
1	D	3660	0	3497	40	0
1	E	3660	0	3497	43	0
1	F	3660	0	3497	41	0
1	G	3660	0	3497	41	0
1	H	3660	0	3497	42	0
1	I	3660	0	3497	39	0
1	J	3660	0	3497	43	0
1	K	3660	0	3497	42	0
1	L	3660	0	3497	35	0
2	A	28	0	19	0	0
2	B	28	0	19	0	0
2	C	28	0	19	0	0
2	D	28	0	19	0	0
2	E	28	0	19	0	0
2	F	28	0	19	0	0
2	G	28	0	19	0	0
2	H	28	0	19	0	0
2	I	28	0	19	0	0
2	J	28	0	19	0	0
2	K	28	0	19	0	0
2	L	28	0	19	0	0
3	A	1	0	0	0	0
3	B	1	0	0	0	0
3	C	1	0	0	0	0
3	D	1	0	0	0	0
3	E	1	0	0	0	0
3	F	1	0	0	0	0
3	G	1	0	0	0	0
3	H	1	0	0	0	0
3	I	1	0	0	0	0
3	J	1	0	0	0	0
3	K	1	0	0	0	0
3	L	1	0	0	0	0
4	A	126	0	0	1	0
4	B	129	0	0	0	0
4	C	130	0	0	0	0
4	D	127	0	0	1	0
4	E	130	0	0	2	0

Continued on next page...

Continued from previous page...

Mol	Chain	Non-H	H(model)	H(added)	Clashes	Symm-Clashes
4	F	127	0	0	0	0
4	G	126	0	0	0	0
4	H	129	0	0	0	0
4	I	126	0	0	0	0
4	J	126	0	0	2	0
4	K	131	0	0	1	0
4	L	129	0	0	0	0
All	All	45804	0	42192	372	0

The all-atom clashscore is defined as the number of clashes found per 1000 atoms (including hydrogen atoms). The all-atom clashscore for this structure is 4.

All (372) close contacts within the same asymmetric unit are listed below, sorted by their clash magnitude.

Atom-1	Atom-2	Interatomic distance (Å)	Clash overlap (Å)
1:L:55:GLY:HA3	1:L:67:SER:O	1.35	1.26
1:B:55:GLY:HA3	1:B:67:SER:O	1.36	1.23
1:C:55:GLY:HA3	1:C:67:SER:O	1.39	1.22
1:H:55:GLY:HA3	1:H:67:SER:O	1.37	1.22
1:I:55:GLY:HA3	1:I:67:SER:O	1.41	1.20
1:J:55:GLY:HA3	1:J:67:SER:O	1.39	1.19
1:G:55:GLY:HA3	1:G:67:SER:O	1.41	1.19
1:A:55:GLY:HA3	1:A:67:SER:O	1.37	1.18
1:D:55:GLY:HA3	1:D:67:SER:O	1.39	1.18
1:F:55:GLY:HA3	1:F:67:SER:O	1.39	1.18
1:K:55:GLY:HA3	1:K:67:SER:O	1.42	1.17
1:E:55:GLY:HA3	1:E:67:SER:O	1.40	1.16
1:C:464:ASN:HD21	1:I:422:GLN:HE22	1.09	0.99
1:E:422:GLN:HE22	1:G:464:ASN:HD21	1.11	0.98
1:L:55:GLY:CA	1:L:67:SER:O	2.17	0.93
1:A:55:GLY:CA	1:A:67:SER:O	2.18	0.92
1:B:55:GLY:CA	1:B:67:SER:O	2.17	0.91
1:C:422:GLN:HE22	1:I:464:ASN:HD21	1.13	0.91
1:H:55:GLY:CA	1:H:67:SER:O	2.18	0.90
1:J:55:GLY:CA	1:J:67:SER:O	2.20	0.90
1:F:55:GLY:CA	1:F:67:SER:O	2.19	0.90
1:D:55:GLY:CA	1:D:67:SER:O	2.20	0.89
1:G:335:GLU:OE1	1:L:62:GLN:HB3	1.73	0.89
1:E:464:ASN:HD21	1:G:422:GLN:HE22	1.19	0.89
1:C:55:GLY:CA	1:C:67:SER:O	2.20	0.89
1:E:55:GLY:CA	1:E:67:SER:O	2.20	0.88

Continued on next page...

Continued from previous page...

Atom-1	Atom-2	Interatomic distance (Å)	Clash overlap (Å)
1:K:55:GLY:CA	1:K:67:SER:O	2.21	0.88
1:I:55:GLY:CA	1:I:67:SER:O	2.21	0.87
1:G:55:GLY:CA	1:G:67:SER:O	2.22	0.87
1:H:62:GLN:HB3	1:I:335:GLU:OE1	1.77	0.85
1:A:335:GLU:OE1	1:F:62:GLN:HB3	1.78	0.82
1:A:464:ASN:HD21	1:K:422:GLN:HE22	1.30	0.79
1:I:57:SER:HB3	1:J:187:PHE:HE2	1.46	0.78
1:D:464:ASN:HD21	1:H:422:GLN:HE22	1.29	0.78
1:G:57:SER:HB3	1:H:187:PHE:HE2	1.50	0.77
1:B:422:GLN:HE22	1:J:464:ASN:HD21	1.33	0.76
1:E:57:SER:HB3	1:F:187:PHE:HE2	1.51	0.76
1:E:422:GLN:NE2	1:G:464:ASN:HD21	1.81	0.75
1:C:20:TYR:CE1	1:D:203:LEU:HD13	2.21	0.75
1:C:464:ASN:HD21	1:I:422:GLN:NE2	1.85	0.75
1:G:347:ARG:HH11	1:L:56:SER:HB3	1.50	0.75
1:H:56:SER:HB3	1:I:347:ARG:HH11	1.52	0.73
1:E:20:TYR:CE1	1:F:203:LEU:HD13	2.22	0.72
1:K:20:TYR:CE1	1:L:203:LEU:HD13	2.23	0.72
1:A:347:ARG:HH11	1:F:56:SER:HB3	1.54	0.72
1:I:57:SER:HB3	1:J:187:PHE:CE2	2.24	0.71
1:B:20:TYR:CE1	1:C:203:LEU:HD13	2.25	0.71
1:B:62:GLN:HB3	1:C:335:GLU:OE1	1.90	0.71
1:G:355:ILE:HG21	1:L:99:PHE:HE1	1.56	0.71
1:E:422:GLN:HE22	1:G:464:ASN:ND2	1.87	0.70
1:A:422:GLN:HE22	1:K:464:ASN:HD21	1.40	0.69
1:G:203:LEU:HD13	1:L:20:TYR:CE1	2.27	0.69
1:C:422:GLN:NE2	1:I:464:ASN:HD21	1.89	0.69
1:A:20:TYR:CE1	1:B:203:LEU:HD13	2.27	0.69
1:A:203:LEU:HD13	1:F:20:TYR:CE1	2.28	0.69
1:G:57:SER:HB3	1:H:187:PHE:CE2	2.28	0.69
1:E:57:SER:HB3	1:F:187:PHE:CE2	2.28	0.69
1:H:20:TYR:CE1	1:I:203:LEU:HD13	2.28	0.68
1:E:464:ASN:HD21	1:G:422:GLN:NE2	1.93	0.67
1:F:422:GLN:HE22	1:L:464:ASN:HD21	1.41	0.67
1:D:422:GLN:HE22	1:H:464:ASN:HD21	1.42	0.67
1:J:62:GLN:HB3	1:K:335:GLU:OE1	1.95	0.66
1:J:20:TYR:CE1	1:K:203:LEU:HD13	2.31	0.66
1:G:20:TYR:CE1	1:H:203:LEU:HD13	2.30	0.65
1:F:464:ASN:HD21	1:L:422:GLN:HE22	1.45	0.63
1:I:20:TYR:CE1	1:J:203:LEU:HD13	2.33	0.63
1:E:464:ASN:O	1:G:328:LYS:HE3	1.99	0.63

Continued on next page...

Continued from previous page...

Atom-1	Atom-2	Interatomic distance (Å)	Clash overlap (Å)
1:J:57:SER:HB3	1:K:187:PHE:CE2	2.34	0.62
1:D:58:ILE:HD12	1:D:69:MET:HB2	1.80	0.61
1:L:58:ILE:HD12	1:L:69:MET:HB2	1.81	0.61
1:E:464:ASN:ND2	1:G:422:GLN:HE22	1.95	0.61
1:C:57:SER:HB3	1:D:187:PHE:HE2	1.65	0.61
1:H:58:ILE:HD12	1:H:69:MET:HB2	1.83	0.61
1:J:56:SER:HB3	1:K:347:ARG:HH11	1.66	0.61
1:B:56:SER:HB3	1:C:347:ARG:HH11	1.66	0.60
1:B:475:TYR:CZ	1:J:323:THR:HB	2.36	0.60
1:K:62:GLN:HB3	1:L:335:GLU:OE1	2.02	0.60
1:B:58:ILE:HD12	1:B:69:MET:HB2	1.84	0.60
1:E:477:ASP:HB2	1:H:178:TYR:CE1	2.36	0.60
1:C:464:ASN:ND2	1:I:422:GLN:HE22	1.91	0.59
1:K:28:LEU:HD11	1:K:447:LEU:HD11	1.84	0.59
1:F:28:LEU:HD11	1:F:447:LEU:HD11	1.84	0.59
1:I:58:ILE:HD12	1:I:69:MET:HB2	1.84	0.59
1:K:58:ILE:HD12	1:K:69:MET:HB2	1.84	0.59
1:H:28:LEU:HD11	1:H:447:LEU:HD11	1.84	0.58
1:F:58:ILE:HD12	1:F:69:MET:HB2	1.83	0.58
1:D:218:HIS:ND1	4:D:2080:HOH:O	2.32	0.58
1:L:28:LEU:HD11	1:L:447:LEU:HD11	1.84	0.58
1:B:464:ASN:HD21	1:J:422:GLN:HE22	1.50	0.58
1:B:422:GLN:NE2	1:J:464:ASN:HD21	2.00	0.58
1:D:57:SER:HB3	1:E:187:PHE:HE2	1.69	0.58
1:E:58:ILE:HD12	1:E:69:MET:HB2	1.86	0.58
1:C:58:ILE:HD12	1:C:69:MET:HB2	1.86	0.57
1:E:328:LYS:HE3	1:G:464:ASN:O	2.03	0.57
1:A:28:LEU:HD11	1:A:447:LEU:HD11	1.87	0.57
1:J:58:ILE:HD12	1:J:69:MET:HB2	1.86	0.57
1:J:315:SER:HB2	1:J:430:LEU:HA	1.85	0.57
1:D:57:SER:HB3	1:E:187:PHE:CE2	2.39	0.57
1:H:99:PHE:HE1	1:I:355:ILE:HG21	1.70	0.57
1:K:57:SER:HB3	1:L:187:PHE:CE2	2.39	0.56
1:A:57:SER:HB3	1:B:187:PHE:CE2	2.40	0.56
1:G:58:ILE:HD12	1:G:69:MET:HB2	1.88	0.56
1:K:57:SER:HB3	1:L:187:PHE:HE2	1.70	0.56
1:D:20:TYR:CE1	1:E:203:LEU:HD13	2.41	0.56
1:B:315:SER:HB2	1:B:430:LEU:HA	1.88	0.56
1:A:464:ASN:HD21	1:K:422:GLN:NE2	1.99	0.56
1:C:57:SER:HB3	1:D:187:PHE:CE2	2.41	0.56
1:J:57:SER:HB3	1:K:187:PHE:HE2	1.70	0.56

Continued on next page...

Continued from previous page...

Atom-1	Atom-2	Interatomic distance (Å)	Clash overlap (Å)
1:L:59:ARG:HE	1:L:69:MET:HE2	1.71	0.56
1:A:57:SER:HB3	1:B:187:PHE:HE2	1.71	0.56
1:H:59:ARG:HE	1:H:69:MET:HE2	1.71	0.55
1:A:58:ILE:HD12	1:A:69:MET:HB2	1.88	0.55
1:C:315:SER:HB2	1:C:430:LEU:HA	1.88	0.55
1:A:464:ASN:O	1:K:328:LYS:HE3	2.07	0.55
1:C:28:LEU:HD11	1:C:447:LEU:HD11	1.88	0.55
1:B:59:ARG:HE	1:B:69:MET:HE2	1.71	0.55
1:D:464:ASN:HD21	1:H:422:GLN:NE2	2.01	0.55
1:B:28:LEU:HD11	1:B:447:LEU:HD11	1.88	0.54
1:F:323:THR:HB	1:L:475:TYR:CZ	2.42	0.54
1:D:62:GLN:HB3	1:E:335:GLU:OE1	2.08	0.54
1:C:464:ASN:O	1:I:328:LYS:HE3	2.08	0.54
1:K:315:SER:HB2	1:K:430:LEU:HA	1.89	0.54
1:E:28:LEU:HD11	1:E:447:LEU:HD11	1.89	0.54
1:J:53:PHE:HB3	1:J:58:ILE:HD11	1.89	0.54
1:F:53:PHE:HB3	1:F:58:ILE:HD11	1.90	0.53
1:F:315:SER:HB2	1:F:430:LEU:HA	1.91	0.53
1:H:56:SER:HB3	1:I:347:ARG:NH1	2.21	0.53
1:I:315:SER:HB2	1:I:430:LEU:HA	1.90	0.53
1:A:53:PHE:HB3	1:A:58:ILE:HD11	1.89	0.53
1:B:53:PHE:HB3	1:B:58:ILE:HD11	1.90	0.53
1:D:323:THR:HB	1:H:475:TYR:CZ	2.43	0.53
1:A:59:ARG:HE	1:A:69:MET:HE2	1.72	0.53
1:A:62:GLN:HB3	1:B:335:GLU:OE1	2.08	0.53
1:K:56:SER:HB3	1:L:347:ARG:HH11	1.73	0.53
1:H:315:SER:HB2	1:H:430:LEU:HA	1.90	0.53
1:L:72:LEU:HD12	1:L:96:HIS:CD2	2.43	0.53
1:G:28:LEU:HD11	1:G:447:LEU:HD11	1.90	0.53
1:F:72:LEU:HD12	1:F:96:HIS:CD2	2.44	0.52
1:C:213:LEU:HD13	1:C:217:HIS:HB3	1.91	0.52
1:K:130:PHE:CE1	1:K:279:GLN:HG2	2.44	0.52
1:D:464:ASN:O	1:H:328:LYS:HE3	2.10	0.52
1:J:56:SER:HB3	1:K:347:ARG:NH1	2.25	0.52
1:I:28:LEU:HD11	1:I:447:LEU:HD11	1.91	0.52
1:J:28:LEU:HD11	1:J:447:LEU:HD11	1.92	0.52
1:D:28:LEU:HD11	1:D:447:LEU:HD11	1.92	0.52
1:D:315:SER:HB2	1:D:430:LEU:HA	1.92	0.52
1:G:347:ARG:NH1	1:L:56:SER:HB3	2.21	0.52
1:A:187:PHE:CE2	1:F:57:SER:HB3	2.45	0.52
1:E:315:SER:HB2	1:E:430:LEU:HA	1.92	0.52

Continued on next page...

Continued from previous page...

Atom-1	Atom-2	Interatomic distance (Å)	Clash overlap (Å)
1:J:237:HIS:ND1	4:J:2083:HOH:O	2.34	0.51
1:H:213:LEU:HD13	1:H:217:HIS:HB3	1.92	0.51
1:A:213:LEU:HD13	1:A:217:HIS:HB3	1.93	0.51
1:E:53:PHE:HB3	1:E:58:ILE:HD11	1.92	0.51
1:J:130:PHE:CE1	1:J:279:GLN:HG2	2.45	0.51
1:L:53:PHE:HB3	1:L:58:ILE:HD11	1.92	0.51
1:D:477:ASP:OD1	1:I:182:HIS:NE2	2.44	0.51
1:E:331:VAL:HG11	1:G:465:ILE:HG22	1.91	0.51
1:E:465:ILE:HG22	1:G:331:VAL:HG11	1.92	0.51
1:A:347:ARG:NH1	1:F:56:SER:HB3	2.22	0.51
1:G:53:PHE:HB3	1:G:58:ILE:HD11	1.93	0.51
1:A:315:SER:HB2	1:A:430:LEU:HA	1.93	0.51
1:E:265:LYS:HG2	1:E:328:LYS:HB3	1.93	0.51
1:K:53:PHE:HB3	1:K:58:ILE:HD11	1.92	0.50
1:F:475:TYR:CZ	1:L:323:THR:HB	2.46	0.50
1:A:355:ILE:HG21	1:F:99:PHE:HE1	1.75	0.50
1:E:72:LEU:HD12	1:E:96:HIS:CD2	2.47	0.50
1:E:473:ALA:HA	1:G:144:PHE:CE1	2.46	0.50
1:F:59:ARG:HE	1:F:69:MET:HE2	1.76	0.50
1:H:53:PHE:HB3	1:H:58:ILE:HD11	1.93	0.50
1:B:213:LEU:HD13	1:B:217:HIS:HB3	1.94	0.50
1:D:213:LEU:HD13	1:D:217:HIS:HB3	1.93	0.50
1:J:99:PHE:HE1	1:K:355:ILE:HG21	1.76	0.50
1:G:72:LEU:HD12	1:G:96:HIS:CD2	2.47	0.50
1:A:237:HIS:ND1	4:A:2086:HOH:O	2.34	0.49
1:A:323:THR:HB	1:K:475:TYR:CZ	2.47	0.49
1:D:475:TYR:CZ	1:H:323:THR:HB	2.46	0.49
1:K:72:LEU:HD12	1:K:96:HIS:CD2	2.47	0.49
1:A:53:PHE:HD2	1:A:58:ILE:HG13	1.78	0.49
1:F:130:PHE:CE1	1:F:279:GLN:HG2	2.47	0.49
1:J:59:ARG:HE	1:J:69:MET:HE2	1.78	0.49
1:B:57:SER:HB3	1:C:187:PHE:CE2	2.47	0.49
1:D:328:LYS:HE3	1:H:464:ASN:O	2.13	0.49
1:H:130:PHE:CE1	1:H:279:GLN:HG2	2.47	0.49
1:C:53:PHE:HB3	1:C:58:ILE:HD11	1.94	0.49
1:D:53:PHE:HB3	1:D:58:ILE:HD11	1.95	0.49
1:E:130:PHE:CE1	1:E:279:GLN:HG2	2.48	0.49
1:B:130:PHE:CE1	1:B:279:GLN:HG2	2.47	0.49
1:A:328:LYS:HE3	1:K:464:ASN:O	2.13	0.49
1:H:57:SER:HB3	1:I:187:PHE:CE2	2.48	0.48
1:E:237:HIS:ND1	4:E:2085:HOH:O	2.35	0.48

Continued on next page...

Continued from previous page...

Atom-1	Atom-2	Interatomic distance (Å)	Clash overlap (Å)
1:I:72:LEU:HD12	1:I:96:HIS:CD2	2.48	0.48
1:H:265:LYS:HG2	1:H:328:LYS:HB3	1.96	0.48
1:A:56:SER:HB3	1:B:347:ARG:HH11	1.78	0.48
1:C:328:LYS:HE3	1:I:464:ASN:O	2.14	0.48
1:F:213:LEU:HD13	1:F:217:HIS:HB3	1.96	0.48
1:H:322:PRO:HG3	1:H:374:GLY:HA3	1.95	0.48
1:J:218:HIS:ND1	4:J:2078:HOH:O	2.34	0.48
1:I:213:LEU:HD13	1:I:217:HIS:HB3	1.95	0.48
1:J:53:PHE:HD2	1:J:58:ILE:HG13	1.79	0.48
1:D:130:PHE:CE1	1:D:279:GLN:HG2	2.49	0.48
1:E:59:ARG:HE	1:E:69:MET:HE2	1.79	0.48
1:G:315:SER:HB2	1:G:430:LEU:HA	1.96	0.48
1:L:315:SER:HB2	1:L:430:LEU:HA	1.96	0.48
1:B:57:SER:HB3	1:C:187:PHE:HE2	1.79	0.47
1:A:422:GLN:NE2	1:K:464:ASN:HD21	2.10	0.47
1:B:72:LEU:HD12	1:B:96:HIS:CD2	2.49	0.47
1:C:72:LEU:HD12	1:C:96:HIS:CD2	2.50	0.47
1:J:300:ASP:OD1	1:J:303:ARG:NH2	2.47	0.47
1:J:369:SER:N	1:J:370:PRO:CD	2.77	0.47
1:L:53:PHE:HD2	1:L:58:ILE:HG13	1.80	0.47
1:H:72:LEU:HD12	1:H:96:HIS:CD2	2.49	0.47
1:I:369:SER:N	1:I:370:PRO:CD	2.77	0.47
1:I:53:PHE:HB3	1:I:58:ILE:HD11	1.95	0.47
1:B:472:PHE:CZ	1:J:153:TYR:CE1	3.03	0.47
1:D:72:LEU:HD12	1:D:96:HIS:CD2	2.50	0.47
1:H:104:TYR:CZ	1:H:106:ARG:HB2	2.50	0.47
1:K:213:LEU:HD13	1:K:217:HIS:HB3	1.97	0.47
1:K:59:ARG:HE	1:K:69:MET:HE2	1.80	0.47
1:J:72:LEU:HD12	1:J:96:HIS:CD2	2.49	0.47
1:C:369:SER:N	1:C:370:PRO:CD	2.78	0.46
1:K:322:PRO:HG3	1:K:374:GLY:HA3	1.97	0.46
1:G:130:PHE:CE1	1:G:279:GLN:HG2	2.51	0.46
1:K:369:SER:N	1:K:370:PRO:CD	2.78	0.46
1:J:104:TYR:CZ	1:J:106:ARG:HB2	2.50	0.46
1:H:53:PHE:HD2	1:H:58:ILE:HG13	1.80	0.46
1:I:59:ARG:HE	1:I:69:MET:HE2	1.81	0.46
1:J:265:LYS:HG2	1:J:328:LYS:HB3	1.97	0.46
1:E:213:LEU:HD13	1:E:217:HIS:HB3	1.98	0.46
1:F:53:PHE:HD2	1:F:58:ILE:HG13	1.80	0.46
1:D:331:VAL:HA	1:D:332:PRO:HD3	1.85	0.46
1:F:322:PRO:HG3	1:F:374:GLY:HA3	1.98	0.46

Continued on next page...

Continued from previous page...

Atom-1	Atom-2	Interatomic distance (Å)	Clash overlap (Å)
1:A:133:GLU:O	1:A:275:MET:HA	2.16	0.46
1:A:335:GLU:CD	1:F:62:GLN:HB3	2.36	0.46
1:B:323:THR:HB	1:J:475:TYR:CZ	2.51	0.46
1:C:53:PHE:HD2	1:C:58:ILE:HG13	1.81	0.46
1:C:59:ARG:HE	1:C:69:MET:HE2	1.80	0.46
1:D:56:SER:HB3	1:E:347:ARG:HH11	1.80	0.46
1:A:130:PHE:CE1	1:A:279:GLN:HG2	2.51	0.45
1:A:475:TYR:CZ	1:K:323:THR:HB	2.50	0.45
1:F:477:ASP:OD1	1:G:182:HIS:NE2	2.50	0.45
1:K:53:PHE:HD2	1:K:58:ILE:HG13	1.81	0.45
1:G:322:PRO:HG3	1:G:374:GLY:HA3	1.99	0.45
1:I:181:ARG:HE	1:I:181:ARG:HB2	1.58	0.45
1:L:213:LEU:HD13	1:L:217:HIS:HB3	1.98	0.45
1:I:53:PHE:HD2	1:I:58:ILE:HG13	1.81	0.45
1:I:265:LYS:HG2	1:I:328:LYS:HB3	1.99	0.45
1:D:53:PHE:HD2	1:D:58:ILE:HG13	1.81	0.45
1:D:369:SER:N	1:D:370:PRO:CD	2.79	0.45
1:I:23:VAL:O	1:I:34:HIS:HA	2.17	0.45
1:A:322:PRO:HG3	1:A:374:GLY:HA3	1.99	0.45
1:J:213:LEU:HD13	1:J:217:HIS:HB3	1.98	0.45
1:B:53:PHE:HD2	1:B:58:ILE:HG13	1.82	0.45
1:B:464:ASN:O	1:J:328:LYS:HE3	2.16	0.45
1:G:213:LEU:HD13	1:G:217:HIS:HB3	1.98	0.45
1:E:369:SER:N	1:E:370:PRO:CD	2.80	0.45
1:L:322:PRO:HG3	1:L:374:GLY:HA3	1.99	0.45
1:C:235:LEU:HD23	1:C:235:LEU:C	2.37	0.45
1:E:331:VAL:HA	1:E:332:PRO:HD3	1.83	0.45
1:B:322:PRO:HG3	1:B:374:GLY:HA3	1.99	0.44
1:E:53:PHE:HD2	1:E:58:ILE:HG13	1.82	0.44
1:A:144:PHE:CE1	1:K:473:ALA:HA	2.52	0.44
1:C:181:ARG:HE	1:C:181:ARG:HB2	1.55	0.44
1:C:20:TYR:CZ	1:D:203:LEU:HD13	2.51	0.44
1:G:53:PHE:HD2	1:G:58:ILE:HG13	1.81	0.44
1:B:265:LYS:HG2	1:B:328:LYS:HB3	1.99	0.44
1:E:300:ASP:OD1	1:E:303:ARG:NH2	2.51	0.44
1:G:181:ARG:HE	1:G:181:ARG:HB2	1.59	0.44
1:B:104:TYR:CZ	1:B:106:ARG:HB2	2.53	0.44
1:E:322:PRO:HG3	1:E:374:GLY:HA3	1.99	0.44
1:A:72:LEU:HD12	1:A:96:HIS:CD2	2.51	0.44
1:B:328:LYS:HE3	1:J:464:ASN:O	2.18	0.44
1:D:300:ASP:OD1	1:D:303:ARG:NH2	2.50	0.44

Continued on next page...

Continued from previous page...

Atom-1	Atom-2	Interatomic distance (Å)	Clash overlap (Å)
1:C:322:PRO:HG3	1:C:374:GLY:HA3	1.99	0.44
1:L:130:PHE:CE1	1:L:279:GLN:HG2	2.52	0.44
1:A:331:VAL:HA	1:A:332:PRO:HD3	1.84	0.44
1:A:346:ASN:OD1	1:A:348:SER:HB3	2.18	0.44
1:H:346:ASN:OD1	1:H:348:SER:HB3	2.17	0.44
1:K:69:MET:HE3	1:K:104:TYR:CG	2.53	0.44
1:G:265:LYS:HG2	1:G:328:LYS:HB3	2.00	0.43
1:C:130:PHE:CE1	1:C:279:GLN:HG2	2.53	0.43
1:K:181:ARG:HE	1:K:181:ARG:HB2	1.58	0.43
1:E:477:ASP:HB2	1:H:178:TYR:CD1	2.53	0.43
1:A:104:TYR:CZ	1:A:106:ARG:HB2	2.53	0.43
1:B:59:ARG:NE	1:B:69:MET:HE2	2.33	0.43
1:E:336:ALA:HA	1:E:337:PRO:HD2	1.94	0.43
1:F:323:THR:HB	1:L:475:TYR:CE1	2.53	0.43
1:A:187:PHE:HE2	1:F:57:SER:HB3	1.83	0.43
1:C:346:ASN:OD1	1:C:348:SER:HB3	2.19	0.43
1:J:303:ARG:NH1	1:J:396:GLU:OE2	2.52	0.43
1:G:346:ASN:OD1	1:G:348:SER:HB3	2.18	0.43
1:H:331:VAL:HA	1:H:332:PRO:HD3	1.86	0.43
1:I:322:PRO:HG3	1:I:374:GLY:HA3	1.99	0.43
1:I:331:VAL:HA	1:I:332:PRO:HD3	1.81	0.43
1:J:346:ASN:OD1	1:J:348:SER:HB3	2.18	0.43
1:L:292:GLU:H	1:L:292:GLU:HG3	1.65	0.43
1:B:346:ASN:OD1	1:B:348:SER:HB3	2.19	0.42
1:D:104:TYR:CZ	1:D:106:ARG:HB2	2.54	0.42
1:D:59:ARG:HE	1:D:69:MET:HE2	1.85	0.42
1:H:369:SER:N	1:H:370:PRO:CD	2.82	0.42
1:C:422:GLN:HE22	1:I:464:ASN:ND2	1.96	0.42
1:E:218:HIS:ND1	4:E:2079:HOH:O	2.37	0.42
1:E:235:LEU:HD23	1:E:235:LEU:C	2.40	0.42
1:B:369:SER:N	1:B:370:PRO:CD	2.82	0.42
1:F:292:GLU:H	1:F:292:GLU:HG3	1.69	0.42
1:K:300:ASP:OD1	1:K:303:ARG:NH2	2.52	0.42
1:B:292:GLU:H	1:B:292:GLU:HG3	1.68	0.42
1:L:369:SER:N	1:L:370:PRO:CD	2.82	0.42
1:C:182:HIS:NE2	1:J:477:ASP:OD1	2.53	0.42
1:E:214:GLU:HB3	1:E:215:LYS:H	1.74	0.42
1:J:322:PRO:HG3	1:J:374:GLY:HA3	2.02	0.42
1:D:322:PRO:HG3	1:D:374:GLY:HA3	2.02	0.42
1:G:104:TYR:CZ	1:G:106:ARG:HB2	2.55	0.42
1:H:57:SER:HB3	1:I:187:PHE:HE2	1.83	0.42

Continued on next page...

Continued from previous page...

Atom-1	Atom-2	Interatomic distance (Å)	Clash overlap (Å)
1:K:265:LYS:HG2	1:K:328:LYS:HB3	2.02	0.42
1:L:74:ASP:HA	1:L:75:PRO:HD2	1.95	0.42
1:D:214:GLU:HB3	1:D:215:LYS:H	1.74	0.41
1:D:23:VAL:O	1:D:34:HIS:HA	2.20	0.41
1:D:28:LEU:HB3	1:D:29:PRO:HD3	2.02	0.41
1:H:181:ARG:HE	1:H:181:ARG:HB2	1.64	0.41
1:A:336:ALA:HA	1:A:337:PRO:HD2	1.96	0.41
1:B:69:MET:HE3	1:B:104:TYR:CG	2.56	0.41
1:C:23:VAL:O	1:C:34:HIS:HA	2.20	0.41
1:F:188:PRO:O	1:F:193:ASP:HB2	2.20	0.41
1:G:292:GLU:H	1:G:292:GLU:HG3	1.66	0.41
1:H:62:GLN:HB3	1:I:335:GLU:CD	2.39	0.41
1:H:69:MET:HE3	1:H:104:TYR:CG	2.55	0.41
1:H:332:PRO:HG3	1:H:421:THR:HG21	2.02	0.41
1:C:104:TYR:CZ	1:C:106:ARG:HB2	2.56	0.41
1:C:303:ARG:NH1	1:C:396:GLU:OE2	2.53	0.41
1:G:336:ALA:HA	1:G:337:PRO:HD2	1.96	0.41
1:G:369:SER:N	1:G:370:PRO:CD	2.84	0.41
1:I:214:GLU:HB3	1:I:215:LYS:H	1.74	0.41
1:L:58:ILE:CD1	1:L:69:MET:HB2	2.48	0.41
1:F:346:ASN:OD1	1:F:348:SER:HB3	2.20	0.41
1:L:181:ARG:HE	1:L:181:ARG:HB2	1.60	0.41
1:A:265:LYS:HG2	1:A:328:LYS:HB3	2.02	0.41
1:H:59:ARG:NE	1:H:69:MET:HE2	2.35	0.41
1:I:292:GLU:H	1:I:292:GLU:HG3	1.68	0.41
1:K:20:TYR:CZ	1:L:203:LEU:HD13	2.54	0.41
1:B:56:SER:HB3	1:C:347:ARG:NH1	2.34	0.41
1:F:178:TYR:CE1	1:G:477:ASP:HB2	2.56	0.41
1:A:434:HIS:HB2	1:A:448:ILE:HD13	2.03	0.41
1:D:265:LYS:HG2	1:D:328:LYS:HB3	2.03	0.41
1:H:58:ILE:CD1	1:H:69:MET:HB2	2.49	0.41
1:B:331:VAL:HA	1:B:332:PRO:HD3	1.86	0.41
1:B:473:ALA:HA	1:J:144:PHE:CE1	2.56	0.41
1:F:78:ALA:HA	1:F:90:ASN:O	2.21	0.41
1:I:346:ASN:OD1	1:I:348:SER:HB3	2.20	0.41
1:J:214:GLU:HB3	1:J:215:LYS:H	1.72	0.41
1:J:369:SER:N	1:J:370:PRO:HD3	2.36	0.41
1:A:369:SER:N	1:A:370:PRO:CD	2.84	0.40
1:F:69:MET:HE3	1:F:104:TYR:CG	2.56	0.40
1:F:369:SER:N	1:F:370:PRO:CD	2.84	0.40
1:K:237:HIS:ND1	4:K:2087:HOH:O	2.37	0.40

Continued on next page...

Continued from previous page...

Atom-1	Atom-2	Interatomic distance (Å)	Clash overlap (Å)
1:B:178:TYR:CE1	1:K:477:ASP:HB2	2.56	0.40
1:D:69:MET:HE3	1:D:104:TYR:CG	2.56	0.40
1:F:23:VAL:O	1:F:34:HIS:HA	2.22	0.40
1:F:434:HIS:HB2	1:F:448:ILE:HD13	2.03	0.40
1:G:23:VAL:O	1:G:34:HIS:HA	2.22	0.40
1:A:335:GLU:OE2	1:F:62:GLN:CB	2.70	0.40
1:D:133:GLU:O	1:D:275:MET:HA	2.21	0.40
1:F:300:ASP:OD1	1:F:303:ARG:NH2	2.54	0.40
1:L:59:ARG:NE	1:L:69:MET:HE2	2.36	0.40
1:A:214:GLU:HB3	1:A:215:LYS:H	1.70	0.40
1:E:20:TYR:CZ	1:F:203:LEU:HD13	2.57	0.40
1:G:74:ASP:HA	1:G:75:PRO:HD2	1.98	0.40
1:L:69:MET:HE3	1:L:104:TYR:CG	2.57	0.40
1:A:69:MET:HE3	1:A:104:TYR:CG	2.56	0.40
1:A:118:TYR:O	1:A:122:THR:HG23	2.22	0.40
1:C:300:ASP:OD1	1:C:303:ARG:NH2	2.54	0.40
1:J:434:HIS:HB2	1:J:448:ILE:HD13	2.03	0.40
1:K:104:TYR:CZ	1:K:106:ARG:HB2	2.56	0.40

There are no symmetry-related clashes.

5.3 Torsion angles [i](#)

5.3.1 Protein backbone [i](#)

In the following table, the Percentiles column shows the percent Ramachandran outliers of the chain as a percentile score with respect to all X-ray entries followed by that with respect to entries of similar resolution.

The Analysed column shows the number of residues for which the backbone conformation was analysed, and the total number of residues.

Mol	Chain	Analysed	Favoured	Allowed	Outliers	Percentiles
1	A	457/486 (94%)	442 (97%)	14 (3%)	1 (0%)	47 60
1	B	457/486 (94%)	439 (96%)	17 (4%)	1 (0%)	47 60
1	C	457/486 (94%)	439 (96%)	17 (4%)	1 (0%)	47 60
1	D	457/486 (94%)	440 (96%)	16 (4%)	1 (0%)	47 60
1	E	457/486 (94%)	440 (96%)	16 (4%)	1 (0%)	47 60
1	F	457/486 (94%)	440 (96%)	16 (4%)	1 (0%)	47 60

Continued on next page...

Continued from previous page...

Mol	Chain	Analysed	Favoured	Allowed	Outliers	Percentiles
1	G	457/486 (94%)	439 (96%)	17 (4%)	1 (0%)	47 60
1	H	457/486 (94%)	441 (96%)	15 (3%)	1 (0%)	47 60
1	I	457/486 (94%)	439 (96%)	17 (4%)	1 (0%)	47 60
1	J	457/486 (94%)	439 (96%)	17 (4%)	1 (0%)	47 60
1	K	457/486 (94%)	441 (96%)	15 (3%)	1 (0%)	47 60
1	L	457/486 (94%)	440 (96%)	16 (4%)	1 (0%)	47 60
All	All	5484/5832 (94%)	5279 (96%)	193 (4%)	12 (0%)	47 60

All (12) Ramachandran outliers are listed below:

Mol	Chain	Res	Type
1	A	332	PRO
1	B	332	PRO
1	C	332	PRO
1	D	332	PRO
1	E	332	PRO
1	F	332	PRO
1	G	332	PRO
1	H	332	PRO
1	I	332	PRO
1	J	332	PRO
1	K	332	PRO
1	L	332	PRO

5.3.2 Protein sidechains [i](#)

In the following table, the Percentiles column shows the percent sidechain outliers of the chain as a percentile score with respect to all X-ray entries followed by that with respect to entries of similar resolution.

The Analysed column shows the number of residues for which the sidechain conformation was analysed, and the total number of residues.

Mol	Chain	Analysed	Rotameric	Outliers	Percentiles
1	A	390/411 (95%)	377 (97%)	13 (3%)	38 51
1	B	390/411 (95%)	377 (97%)	13 (3%)	38 51
1	C	390/411 (95%)	377 (97%)	13 (3%)	38 51
1	D	390/411 (95%)	375 (96%)	15 (4%)	33 45

Continued on next page...

Continued from previous page...

Mol	Chain	Analysed	Rotameric	Outliers	Percentiles	
1	E	390/411 (95%)	377 (97%)	13 (3%)	38	51
1	F	390/411 (95%)	378 (97%)	12 (3%)	40	54
1	G	390/411 (95%)	377 (97%)	13 (3%)	38	51
1	H	390/411 (95%)	376 (96%)	14 (4%)	35	47
1	I	390/411 (95%)	377 (97%)	13 (3%)	38	51
1	J	390/411 (95%)	377 (97%)	13 (3%)	38	51
1	K	390/411 (95%)	378 (97%)	12 (3%)	40	54
1	L	390/411 (95%)	377 (97%)	13 (3%)	38	51
All	All	4680/4932 (95%)	4523 (97%)	157 (3%)	37	50

All (157) residues with a non-rotameric sidechain are listed below:

Mol	Chain	Res	Type
1	A	34	HIS
1	A	68	ASP
1	A	99	PHE
1	A	180	VAL
1	A	203	LEU
1	A	209	SER
1	A	213	LEU
1	A	220	VAL
1	A	331	VAL
1	A	335	GLU
1	A	446	ASP
1	A	453	SER
1	A	464	ASN
1	B	34	HIS
1	B	68	ASP
1	B	99	PHE
1	B	180	VAL
1	B	203	LEU
1	B	209	SER
1	B	213	LEU
1	B	220	VAL
1	B	331	VAL
1	B	335	GLU
1	B	446	ASP
1	B	453	SER
1	B	464	ASN

Continued on next page...

Continued from previous page...

Mol	Chain	Res	Type
1	C	34	HIS
1	C	68	ASP
1	C	99	PHE
1	C	180	VAL
1	C	203	LEU
1	C	209	SER
1	C	213	LEU
1	C	220	VAL
1	C	331	VAL
1	C	335	GLU
1	C	446	ASP
1	C	453	SER
1	C	464	ASN
1	D	34	HIS
1	D	68	ASP
1	D	99	PHE
1	D	180	VAL
1	D	191	PRO
1	D	203	LEU
1	D	209	SER
1	D	213	LEU
1	D	220	VAL
1	D	331	VAL
1	D	335	GLU
1	D	426	VAL
1	D	446	ASP
1	D	453	SER
1	D	464	ASN
1	E	68	ASP
1	E	99	PHE
1	E	154	GLU
1	E	180	VAL
1	E	203	LEU
1	E	209	SER
1	E	213	LEU
1	E	220	VAL
1	E	331	VAL
1	E	335	GLU
1	E	446	ASP
1	E	453	SER
1	E	464	ASN
1	F	68	ASP

Continued on next page...

Continued from previous page...

Mol	Chain	Res	Type
1	F	99	PHE
1	F	180	VAL
1	F	203	LEU
1	F	209	SER
1	F	213	LEU
1	F	220	VAL
1	F	331	VAL
1	F	335	GLU
1	F	446	ASP
1	F	453	SER
1	F	464	ASN
1	G	34	HIS
1	G	68	ASP
1	G	99	PHE
1	G	180	VAL
1	G	203	LEU
1	G	209	SER
1	G	213	LEU
1	G	220	VAL
1	G	331	VAL
1	G	335	GLU
1	G	446	ASP
1	G	453	SER
1	G	464	ASN
1	H	34	HIS
1	H	68	ASP
1	H	99	PHE
1	H	154	GLU
1	H	180	VAL
1	H	203	LEU
1	H	209	SER
1	H	213	LEU
1	H	220	VAL
1	H	331	VAL
1	H	335	GLU
1	H	446	ASP
1	H	453	SER
1	H	464	ASN
1	I	68	ASP
1	I	99	PHE
1	I	180	VAL
1	I	191	PRO

Continued on next page...

Continued from previous page...

Mol	Chain	Res	Type
1	I	203	LEU
1	I	209	SER
1	I	213	LEU
1	I	220	VAL
1	I	331	VAL
1	I	335	GLU
1	I	446	ASP
1	I	453	SER
1	I	464	ASN
1	J	34	HIS
1	J	68	ASP
1	J	99	PHE
1	J	180	VAL
1	J	203	LEU
1	J	209	SER
1	J	213	LEU
1	J	220	VAL
1	J	331	VAL
1	J	335	GLU
1	J	446	ASP
1	J	453	SER
1	J	464	ASN
1	K	68	ASP
1	K	99	PHE
1	K	180	VAL
1	K	203	LEU
1	K	209	SER
1	K	213	LEU
1	K	220	VAL
1	K	331	VAL
1	K	335	GLU
1	K	446	ASP
1	K	453	SER
1	K	464	ASN
1	L	34	HIS
1	L	68	ASP
1	L	99	PHE
1	L	180	VAL
1	L	203	LEU
1	L	209	SER
1	L	213	LEU
1	L	220	VAL

Continued on next page...

Continued from previous page...

Mol	Chain	Res	Type
1	L	331	VAL
1	L	335	GLU
1	L	446	ASP
1	L	453	SER
1	L	464	ASN

Sometimes sidechains can be flipped to improve hydrogen bonding and reduce clashes. All (36) such sidechains are listed below:

Mol	Chain	Res	Type
1	A	398	GLN
1	A	458	ASN
1	B	398	GLN
1	B	422	GLN
1	B	458	ASN
1	B	464	ASN
1	C	398	GLN
1	C	422	GLN
1	C	458	ASN
1	D	398	GLN
1	D	458	ASN
1	E	398	GLN
1	E	422	GLN
1	E	458	ASN
1	F	398	GLN
1	F	458	ASN
1	F	464	ASN
1	G	398	GLN
1	G	422	GLN
1	G	458	ASN
1	H	398	GLN
1	H	422	GLN
1	H	458	ASN
1	H	464	ASN
1	I	398	GLN
1	I	422	GLN
1	I	458	ASN
1	J	398	GLN
1	J	458	ASN
1	K	398	GLN
1	K	422	GLN
1	K	458	ASN
1	K	464	ASN

Continued on next page...

Continued from previous page...

Mol	Chain	Res	Type
1	L	398	GLN
1	L	458	ASN
1	L	464	ASN

5.3.3 RNA [i](#)

There are no RNA molecules in this entry.

5.4 Non-standard residues in protein, DNA, RNA chains [i](#)

There are no non-standard protein/DNA/RNA residues in this entry.

5.5 Carbohydrates [i](#)

There are no monosaccharides in this entry.

5.6 Ligand geometry [i](#)

Of 24 ligands modelled in this entry, 12 are monoatomic - leaving 12 for Mogul analysis.

In the following table, the Counts columns list the number of bonds (or angles) for which Mogul statistics could be retrieved, the number of bonds (or angles) that are observed in the model and the number of bonds (or angles) that are defined in the Chemical Component Dictionary. The Link column lists molecule types, if any, to which the group is linked. The Z score for a bond length (or angle) is the number of standard deviations the observed value is removed from the expected value. A bond length (or angle) with $|Z| > 2$ is considered an outlier worth inspection. RMSZ is the root-mean-square of all Z scores of the bond lengths (or angles).

Mol	Type	Chain	Res	Link	Bond lengths			Bond angles		
					Counts	RMSZ	# Z > 2	Counts	RMSZ	# Z > 2
2	1AZ	B	501	-	27,31,31	1.41	8 (29%)	33,46,46	2.47	12 (36%)
2	1AZ	I	501	-	27,31,31	1.43	7 (25%)	33,46,46	2.42	11 (33%)
2	1AZ	F	501	-	27,31,31	1.28	6 (22%)	33,46,46	2.44	11 (33%)
2	1AZ	E	501	-	27,31,31	1.36	6 (22%)	33,46,46	2.47	12 (36%)
2	1AZ	C	501	-	27,31,31	1.38	9 (33%)	33,46,46	2.34	13 (39%)
2	1AZ	K	501	-	27,31,31	1.44	8 (29%)	33,46,46	2.35	13 (39%)
2	1AZ	J	501	-	27,31,31	1.64	8 (29%)	33,46,46	2.38	12 (36%)
2	1AZ	D	501	-	27,31,31	1.45	7 (25%)	33,46,46	2.39	11 (33%)
2	1AZ	A	501	-	27,31,31	1.45	7 (25%)	33,46,46	2.38	10 (30%)

Mol	Type	Chain	Res	Link	Bond lengths			Bond angles		
					Counts	RMSZ	# Z > 2	Counts	RMSZ	# Z > 2
2	1AZ	H	501	-	27,31,31	1.32	6 (22%)	33,46,46	2.46	11 (33%)
2	1AZ	L	501	-	27,31,31	1.41	6 (22%)	33,46,46	2.37	12 (36%)
2	1AZ	G	501	-	27,31,31	1.47	7 (25%)	33,46,46	2.42	11 (33%)

In the following table, the Chirals column lists the number of chiral outliers, the number of chiral centers analysed, the number of these observed in the model and the number defined in the Chemical Component Dictionary. Similar counts are reported in the Torsion and Rings columns. '-' means no outliers of that kind were identified.

Mol	Type	Chain	Res	Link	Chirals	Torsions	Rings
2	1AZ	B	501	-	-	0/4/16/16	0/4/4/4
2	1AZ	I	501	-	-	0/4/16/16	0/4/4/4
2	1AZ	F	501	-	-	0/4/16/16	0/4/4/4
2	1AZ	E	501	-	-	0/4/16/16	0/4/4/4
2	1AZ	C	501	-	-	0/4/16/16	0/4/4/4
2	1AZ	K	501	-	-	0/4/16/16	0/4/4/4
2	1AZ	J	501	-	-	0/4/16/16	0/4/4/4
2	1AZ	D	501	-	-	0/4/16/16	0/4/4/4
2	1AZ	A	501	-	-	0/4/16/16	0/4/4/4
2	1AZ	H	501	-	-	0/4/16/16	0/4/4/4
2	1AZ	L	501	-	-	0/4/16/16	0/4/4/4
2	1AZ	G	501	-	-	0/4/16/16	0/4/4/4

All (85) bond length outliers are listed below:

Mol	Chain	Res	Type	Atoms	Z	Observed(Å)	Ideal(Å)
2	J	501	1AZ	C18-CL2	3.58	1.82	1.73
2	J	501	1AZ	C13-N5	-3.34	1.34	1.38
2	K	501	1AZ	C13-N5	-3.33	1.34	1.38
2	A	501	1AZ	C15-N5	-3.11	1.34	1.38
2	L	501	1AZ	C18-CL2	3.04	1.80	1.73
2	L	501	1AZ	C15-N5	-3.03	1.34	1.38
2	A	501	1AZ	C1-CL1	2.99	1.80	1.73
2	B	501	1AZ	C13-N5	-2.98	1.35	1.38
2	G	501	1AZ	C13-N5	-2.94	1.35	1.38
2	E	501	1AZ	C13-N5	-2.88	1.35	1.38
2	H	501	1AZ	C18-CL2	2.85	1.80	1.73
2	D	501	1AZ	C1-CL1	2.84	1.80	1.73
2	J	501	1AZ	C5-N1	-2.84	1.34	1.40
2	D	501	1AZ	C13-N5	-2.81	1.35	1.38
2	F	501	1AZ	C5-N1	-2.78	1.34	1.40
2	I	501	1AZ	C18-CL2	2.77	1.80	1.73

Continued on next page...

Continued from previous page...

Mol	Chain	Res	Type	Atoms	Z	Observed(Å)	Ideal(Å)
2	G	501	1AZ	C15-N5	-2.74	1.34	1.38
2	I	501	1AZ	C13-N5	-2.74	1.35	1.38
2	I	501	1AZ	C15-N5	-2.69	1.34	1.38
2	A	501	1AZ	C13-N5	-2.68	1.35	1.38
2	J	501	1AZ	C1-CL1	2.66	1.80	1.73
2	K	501	1AZ	C1-CL1	2.65	1.79	1.73
2	B	501	1AZ	C5-N1	-2.64	1.35	1.40
2	G	501	1AZ	C1-CL1	2.58	1.79	1.73
2	G	501	1AZ	C6-C5	-2.57	1.40	1.46
2	B	501	1AZ	C15-N1	2.57	1.43	1.38
2	L	501	1AZ	C13-N5	-2.57	1.35	1.38
2	E	501	1AZ	C6-C5	-2.55	1.40	1.46
2	D	501	1AZ	C18-CL2	2.51	1.79	1.73
2	L	501	1AZ	C5-N1	-2.50	1.35	1.40
2	G	501	1AZ	C15-N1	2.49	1.43	1.38
2	J	501	1AZ	C15-N1	2.48	1.43	1.38
2	L	501	1AZ	C6-C5	-2.48	1.40	1.46
2	H	501	1AZ	C6-C5	-2.48	1.40	1.46
2	C	501	1AZ	C1-CL1	2.47	1.79	1.73
2	G	501	1AZ	C5-N1	-2.47	1.35	1.40
2	I	501	1AZ	C6-C5	-2.46	1.40	1.46
2	J	501	1AZ	O3-C15	2.45	1.27	1.22
2	E	501	1AZ	C15-N5	-2.43	1.35	1.38
2	H	501	1AZ	C1-CL1	2.43	1.79	1.73
2	K	501	1AZ	C5-N1	-2.43	1.35	1.40
2	D	501	1AZ	C5-N1	-2.42	1.35	1.40
2	K	501	1AZ	O3-C15	2.42	1.27	1.22
2	C	501	1AZ	C13-N5	-2.41	1.35	1.38
2	D	501	1AZ	C15-N1	2.41	1.43	1.38
2	H	501	1AZ	C15-N5	-2.39	1.35	1.38
2	F	501	1AZ	C15-N5	-2.39	1.35	1.38
2	H	501	1AZ	C5-N1	-2.38	1.35	1.40
2	I	501	1AZ	C5-N1	-2.38	1.35	1.40
2	F	501	1AZ	C13-N5	-2.36	1.35	1.38
2	D	501	1AZ	C6-C5	-2.35	1.41	1.46
2	A	501	1AZ	C6-C5	-2.35	1.41	1.46
2	A	501	1AZ	C5-N1	-2.34	1.35	1.40
2	B	501	1AZ	C1-CL1	2.34	1.79	1.73
2	J	501	1AZ	C15-N5	-2.34	1.35	1.38
2	B	501	1AZ	C15-N5	-2.33	1.35	1.38
2	C	501	1AZ	C15-N1	2.32	1.42	1.38
2	I	501	1AZ	C15-N1	2.31	1.42	1.38

Continued on next page...

Continued from previous page...

Mol	Chain	Res	Type	Atoms	Z	Observed(Å)	Ideal(Å)
2	E	501	1AZ	C1-CL1	2.31	1.79	1.73
2	C	501	1AZ	O1-C5	2.29	1.27	1.22
2	E	501	1AZ	C5-N1	-2.29	1.35	1.40
2	K	501	1AZ	C6-C5	-2.27	1.41	1.46
2	F	501	1AZ	C18-CL2	2.27	1.79	1.73
2	A	501	1AZ	C15-N1	2.25	1.42	1.38
2	C	501	1AZ	C15-N5	-2.25	1.35	1.38
2	L	501	1AZ	O1-C5	2.24	1.26	1.22
2	K	501	1AZ	C15-N1	2.21	1.42	1.38
2	D	501	1AZ	C15-N5	-2.19	1.35	1.38
2	J	501	1AZ	C6-C5	-2.19	1.41	1.46
2	B	501	1AZ	C6-C5	-2.19	1.41	1.46
2	F	501	1AZ	C1-CL1	2.17	1.78	1.73
2	C	501	1AZ	C6-C5	-2.16	1.41	1.46
2	B	501	1AZ	O3-C15	2.16	1.26	1.22
2	A	501	1AZ	C18-CL2	2.14	1.78	1.73
2	E	501	1AZ	C15-N1	2.13	1.42	1.38
2	K	501	1AZ	O1-C5	2.11	1.26	1.22
2	G	501	1AZ	C18-CL2	2.10	1.78	1.73
2	K	501	1AZ	C15-N5	-2.06	1.35	1.38
2	C	501	1AZ	O3-C15	2.06	1.26	1.22
2	C	501	1AZ	C5-N1	-2.05	1.36	1.40
2	I	501	1AZ	C1-CL1	2.05	1.78	1.73
2	C	501	1AZ	C18-CL2	2.03	1.78	1.73
2	F	501	1AZ	C6-C5	-2.03	1.41	1.46
2	H	501	1AZ	C13-N5	-2.02	1.36	1.38
2	B	501	1AZ	C18-CL2	2.02	1.78	1.73

All (139) bond angle outliers are listed below:

Mol	Chain	Res	Type	Atoms	Z	Observed(°)	Ideal(°)
2	H	501	1AZ	C6-C5-N1	7.77	119.95	113.58
2	F	501	1AZ	C6-C5-N1	7.45	119.69	113.58
2	G	501	1AZ	C6-C5-N1	7.42	119.66	113.58
2	E	501	1AZ	C6-C5-N1	7.04	119.35	113.58
2	B	501	1AZ	C6-C5-N1	6.99	119.31	113.58
2	I	501	1AZ	C6-C5-N1	6.83	119.17	113.58
2	K	501	1AZ	C6-C5-N1	6.82	119.16	113.58
2	A	501	1AZ	C6-C5-N1	6.67	119.05	113.58
2	D	501	1AZ	C6-C5-N1	6.51	118.91	113.58
2	C	501	1AZ	C6-C5-N1	6.43	118.85	113.58
2	J	501	1AZ	C6-C5-N1	6.40	118.82	113.58

Continued on next page...

Continued from previous page...

Mol	Chain	Res	Type	Atoms	Z	Observed(°)	Ideal(°)
2	L	501	1AZ	C6-C5-N1	5.92	118.43	113.58
2	J	501	1AZ	C12-N3-C8	-5.46	110.32	122.03
2	E	501	1AZ	C12-N3-C8	-5.30	110.67	122.03
2	L	501	1AZ	C12-N3-C8	-5.30	110.67	122.03
2	B	501	1AZ	C12-N3-C8	-5.26	110.76	122.03
2	D	501	1AZ	C12-N3-C8	-5.24	110.81	122.03
2	K	501	1AZ	C12-N3-C8	-5.11	111.08	122.03
2	I	501	1AZ	C12-N3-C8	-5.07	111.16	122.03
2	F	501	1AZ	C12-N3-C8	-5.05	111.20	122.03
2	H	501	1AZ	C12-N3-C8	-4.98	111.37	122.03
2	A	501	1AZ	C12-N3-C8	-4.95	111.43	122.03
2	B	501	1AZ	C1-C2-C3	-4.85	117.15	120.46
2	G	501	1AZ	C12-N3-C8	-4.80	111.76	122.03
2	C	501	1AZ	C12-N3-C8	-4.79	111.76	122.03
2	J	501	1AZ	C9-N3-C8	-4.69	111.99	122.03
2	H	501	1AZ	C9-N3-C8	-4.62	112.12	122.03
2	B	501	1AZ	C9-N3-C8	-4.61	112.16	122.03
2	F	501	1AZ	C9-N3-C8	-4.60	112.18	122.03
2	D	501	1AZ	C9-N3-C8	-4.59	112.19	122.03
2	E	501	1AZ	C9-N3-C8	-4.58	112.22	122.03
2	A	501	1AZ	C9-N3-C8	-4.55	112.29	122.03
2	I	501	1AZ	C9-N3-C8	-4.53	112.32	122.03
2	G	501	1AZ	C9-N3-C8	-4.52	112.34	122.03
2	K	501	1AZ	C9-N3-C8	-4.48	112.44	122.03
2	L	501	1AZ	C9-N3-C8	-4.45	112.50	122.03
2	L	501	1AZ	C1-C2-C3	-4.39	117.46	120.46
2	E	501	1AZ	C1-C2-C3	-4.32	117.51	120.46
2	C	501	1AZ	C9-N3-C8	-4.28	112.86	122.03
2	J	501	1AZ	C10-C9-N3	-4.27	102.15	110.02
2	L	501	1AZ	C10-C9-N3	-4.16	102.34	110.02
2	H	501	1AZ	C10-C9-N3	-4.02	102.61	110.02
2	C	501	1AZ	C10-C9-N3	-4.01	102.62	110.02
2	D	501	1AZ	C10-C9-N3	-4.00	102.63	110.02
2	A	501	1AZ	C10-C9-N3	-3.93	102.76	110.02
2	G	501	1AZ	C10-C9-N3	-3.78	103.05	110.02
2	F	501	1AZ	C10-C9-N3	-3.74	103.12	110.02
2	B	501	1AZ	C10-C9-N3	-3.72	103.16	110.02
2	K	501	1AZ	C1-C2-C3	-3.71	117.93	120.46
2	A	501	1AZ	O3-C15-N5	-3.62	118.93	122.08
2	I	501	1AZ	C10-C9-N3	-3.60	103.38	110.02
2	I	501	1AZ	C1-C2-C3	-3.59	118.01	120.46
2	G	501	1AZ	C1-C2-C3	-3.51	118.06	120.46

Continued on next page...

Continued from previous page...

Mol	Chain	Res	Type	Atoms	Z	Observed(°)	Ideal(°)
2	K	501	1AZ	C10-C9-N3	-3.45	103.66	110.02
2	C	501	1AZ	C1-C2-C3	-3.42	118.12	120.46
2	G	501	1AZ	O3-C15-N5	-3.40	119.12	122.08
2	F	501	1AZ	C1-C2-C3	-3.40	118.14	120.46
2	E	501	1AZ	C10-C9-N3	-3.34	103.86	110.02
2	F	501	1AZ	O3-C15-N5	-3.29	119.22	122.08
2	J	501	1AZ	C1-C2-C3	-3.25	118.24	120.46
2	H	501	1AZ	C1-C2-C3	-3.19	118.28	120.46
2	H	501	1AZ	C4-N1-C5	3.16	121.48	117.42
2	H	501	1AZ	O1-C5-C6	-3.15	120.16	125.33
2	E	501	1AZ	O1-C5-C6	-3.13	120.18	125.33
2	D	501	1AZ	C1-C2-C3	-3.13	118.33	120.46
2	I	501	1AZ	O3-C15-N5	-3.09	119.39	122.08
2	H	501	1AZ	C11-C12-N3	-3.07	104.35	110.02
2	D	501	1AZ	O1-C5-C6	-3.06	120.31	125.33
2	C	501	1AZ	O3-C15-N5	-3.03	119.44	122.08
2	G	501	1AZ	O1-C5-C6	-3.00	120.39	125.33
2	I	501	1AZ	O1-C5-C6	-2.91	120.55	125.33
2	A	501	1AZ	N1-C15-N5	2.84	120.77	116.75
2	D	501	1AZ	O3-C15-N5	-2.84	119.61	122.08
2	A	501	1AZ	O1-C5-C6	-2.83	120.68	125.33
2	L	501	1AZ	C11-C12-N3	-2.81	104.84	110.02
2	K	501	1AZ	C11-C12-N3	-2.78	104.89	110.02
2	F	501	1AZ	N1-C15-N5	2.78	120.68	116.75
2	J	501	1AZ	C11-C12-N3	-2.78	104.90	110.02
2	C	501	1AZ	N1-C15-N5	2.76	120.66	116.75
2	A	501	1AZ	C1-C2-C3	-2.76	118.58	120.46
2	I	501	1AZ	C11-C12-N3	-2.74	104.97	110.02
2	D	501	1AZ	C13-N5-C15	-2.71	119.61	122.20
2	C	501	1AZ	O1-C5-C6	-2.67	120.94	125.33
2	D	501	1AZ	N1-C15-N5	2.65	120.50	116.75
2	B	501	1AZ	O3-C15-N5	-2.65	119.77	122.08
2	J	501	1AZ	O3-C15-N5	-2.65	119.77	122.08
2	F	501	1AZ	C11-C12-N3	-2.64	105.16	110.02
2	H	501	1AZ	N1-C15-N5	2.63	120.47	116.75
2	I	501	1AZ	N1-C15-N5	2.60	120.42	116.75
2	L	501	1AZ	O1-C5-C6	-2.59	121.07	125.33
2	C	501	1AZ	C13-N5-C15	-2.56	119.75	122.20
2	E	501	1AZ	O3-C15-N5	-2.54	119.87	122.08
2	A	501	1AZ	C13-N5-C15	-2.49	119.82	122.20
2	K	501	1AZ	C4-N1-C5	2.48	120.61	117.42
2	E	501	1AZ	N1-C15-N5	2.48	120.26	116.75

Continued on next page...

Continued from previous page...

Mol	Chain	Res	Type	Atoms	Z	Observed(°)	Ideal(°)
2	B	501	1AZ	C11-C12-N3	-2.46	105.48	110.02
2	K	501	1AZ	N1-C15-N5	2.46	120.22	116.75
2	A	501	1AZ	C4-N1-C5	2.43	120.54	117.42
2	J	501	1AZ	C7-N2-C6	2.43	127.15	124.49
2	J	501	1AZ	N1-C15-N5	2.43	120.18	116.75
2	L	501	1AZ	N1-C15-N5	2.43	120.18	116.75
2	F	501	1AZ	O1-C5-C6	-2.40	121.39	125.33
2	L	501	1AZ	C7-N2-C6	2.33	127.05	124.49
2	K	501	1AZ	O1-C5-C6	-2.33	121.51	125.33
2	B	501	1AZ	O1-C5-C6	-2.31	121.53	125.33
2	G	501	1AZ	N1-C15-N5	2.31	120.02	116.75
2	B	501	1AZ	N1-C15-N5	2.31	120.01	116.75
2	J	501	1AZ	C13-N5-C15	-2.29	120.01	122.20
2	D	501	1AZ	C4-N1-C5	2.28	120.34	117.42
2	L	501	1AZ	O3-C15-N5	-2.27	120.10	122.08
2	L	501	1AZ	C13-N5-C15	-2.21	120.08	122.20
2	F	501	1AZ	C4-N1-C5	2.21	120.26	117.42
2	H	501	1AZ	O3-C15-N1	-2.20	118.94	121.99
2	K	501	1AZ	O3-C15-N1	-2.20	118.94	121.99
2	C	501	1AZ	C16-C3-C2	2.20	121.62	118.54
2	G	501	1AZ	C11-C12-N3	-2.20	105.97	110.02
2	I	501	1AZ	C13-N5-C15	-2.19	120.11	122.20
2	E	501	1AZ	C4-N1-C5	2.17	120.21	117.42
2	C	501	1AZ	C4-N1-C5	2.17	120.20	117.42
2	G	501	1AZ	C4-N1-C15	2.16	120.08	116.97
2	I	501	1AZ	C4-N1-C5	2.16	120.19	117.42
2	K	501	1AZ	C7-N2-C6	2.16	126.86	124.49
2	L	501	1AZ	C4-N1-C5	2.15	120.18	117.42
2	E	501	1AZ	C13-N5-C15	-2.15	120.15	122.20
2	J	501	1AZ	O1-C5-C6	-2.13	121.83	125.33
2	G	501	1AZ	C4-N1-C5	2.11	120.13	117.42
2	H	501	1AZ	C13-N5-C15	-2.11	120.19	122.20
2	J	501	1AZ	C4-N1-C15	2.11	120.00	116.97
2	C	501	1AZ	C11-C12-N3	-2.08	106.18	110.02
2	K	501	1AZ	C13-N5-C15	-2.08	120.21	122.20
2	B	501	1AZ	C16-C3-C2	2.08	121.45	118.54
2	B	501	1AZ	C7-N2-C6	2.08	126.77	124.49
2	F	501	1AZ	C4-N1-C15	2.07	119.95	116.97
2	D	501	1AZ	C11-C12-N3	-2.05	106.23	110.02
2	K	501	1AZ	C16-C3-C2	2.04	121.40	118.54
2	C	501	1AZ	C7-N2-C6	2.04	126.72	124.49
2	E	501	1AZ	C11-C12-N3	-2.02	106.30	110.02

Continued on next page...

Continued from previous page...

Mol	Chain	Res	Type	Atoms	Z	Observed(°)	Ideal(°)
2	B	501	1AZ	C4-N1-C15	2.02	119.87	116.97
2	E	501	1AZ	C16-C17-C18	-2.00	117.11	120.00

There are no chirality outliers.

There are no torsion outliers.

There are no ring outliers.

No monomer is involved in short contacts.

The following is a two-dimensional graphical depiction of Mogul quality analysis of bond lengths, bond angles, torsion angles, and ring geometry for all instances of the Ligand of Interest. In addition, ligands with molecular weight > 250 and outliers as shown on the validation Tables will also be included. For torsion angles, if less than 5% of the Mogul distribution of torsion angles is within 10 degrees of the torsion angle in question, then that torsion angle is considered an outlier. Any bond that is central to one or more torsion angles identified as an outlier by Mogul will be highlighted in the graph. For rings, the root-mean-square deviation (RMSD) between the ring in question and similar rings identified by Mogul is calculated over all ring torsion angles. If the average RMSD is greater than 60 degrees and the minimal RMSD between the ring in question and any Mogul-identified rings is also greater than 60 degrees, then that ring is considered an outlier. The outliers are highlighted in purple. The color gray indicates Mogul did not find sufficient equivalents in the CSD to analyse the geometry.

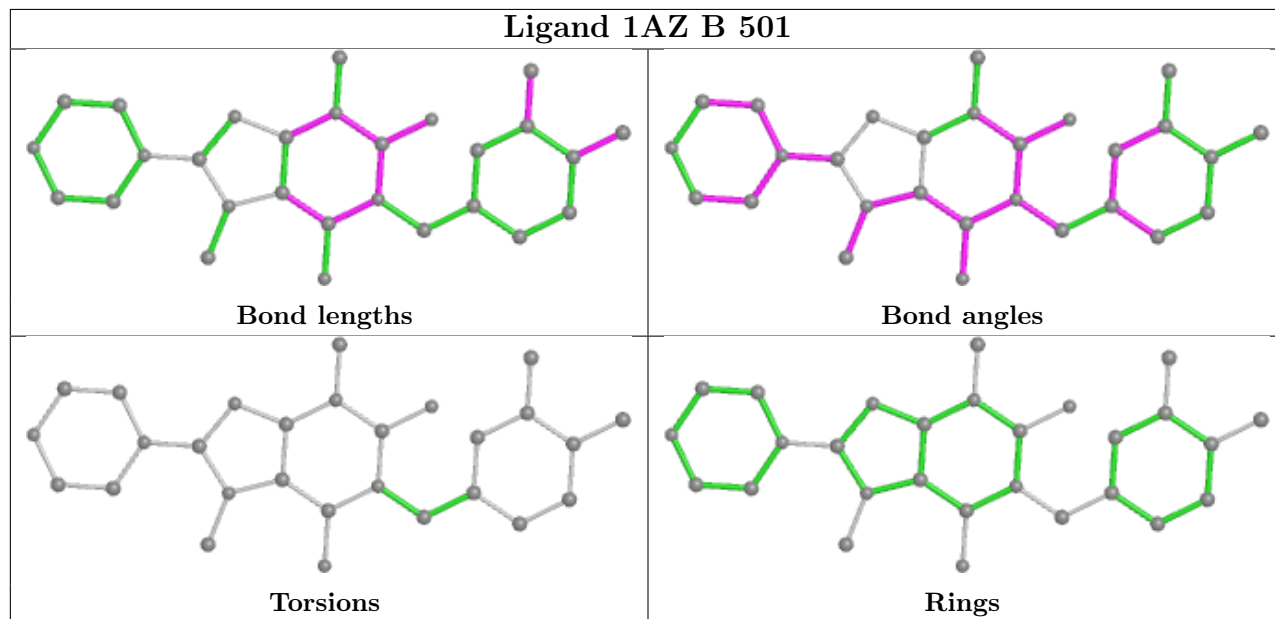

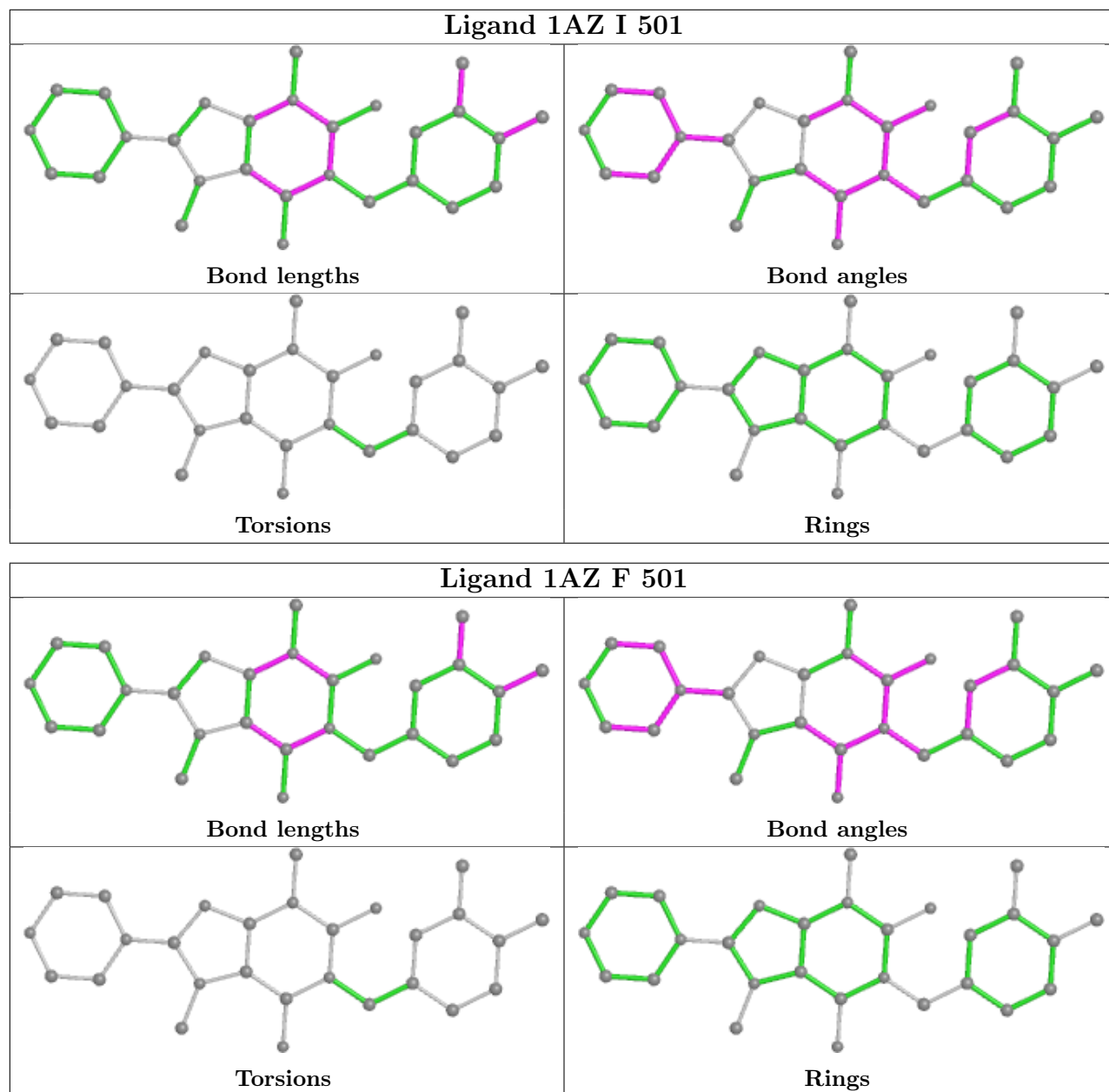

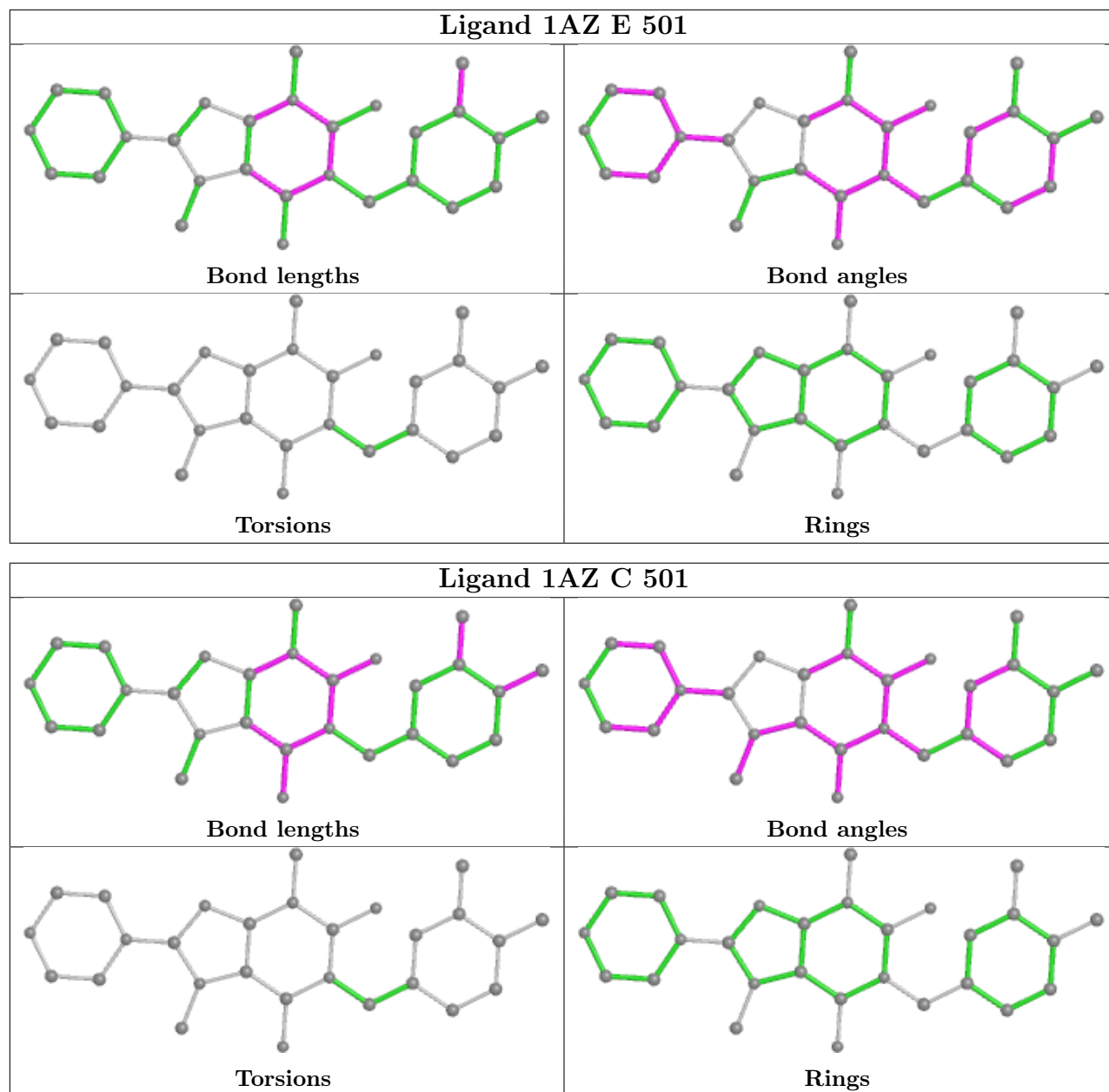

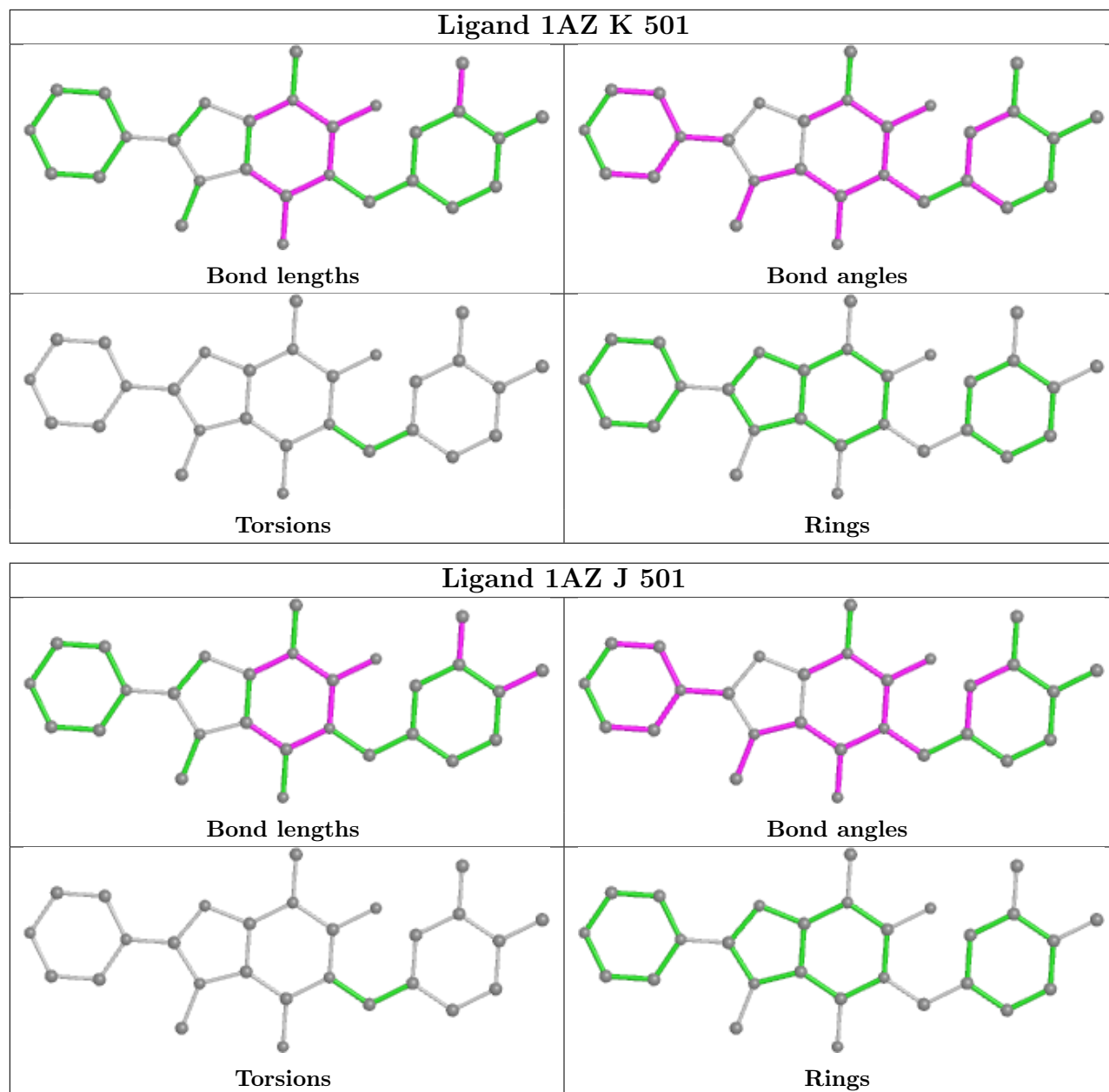

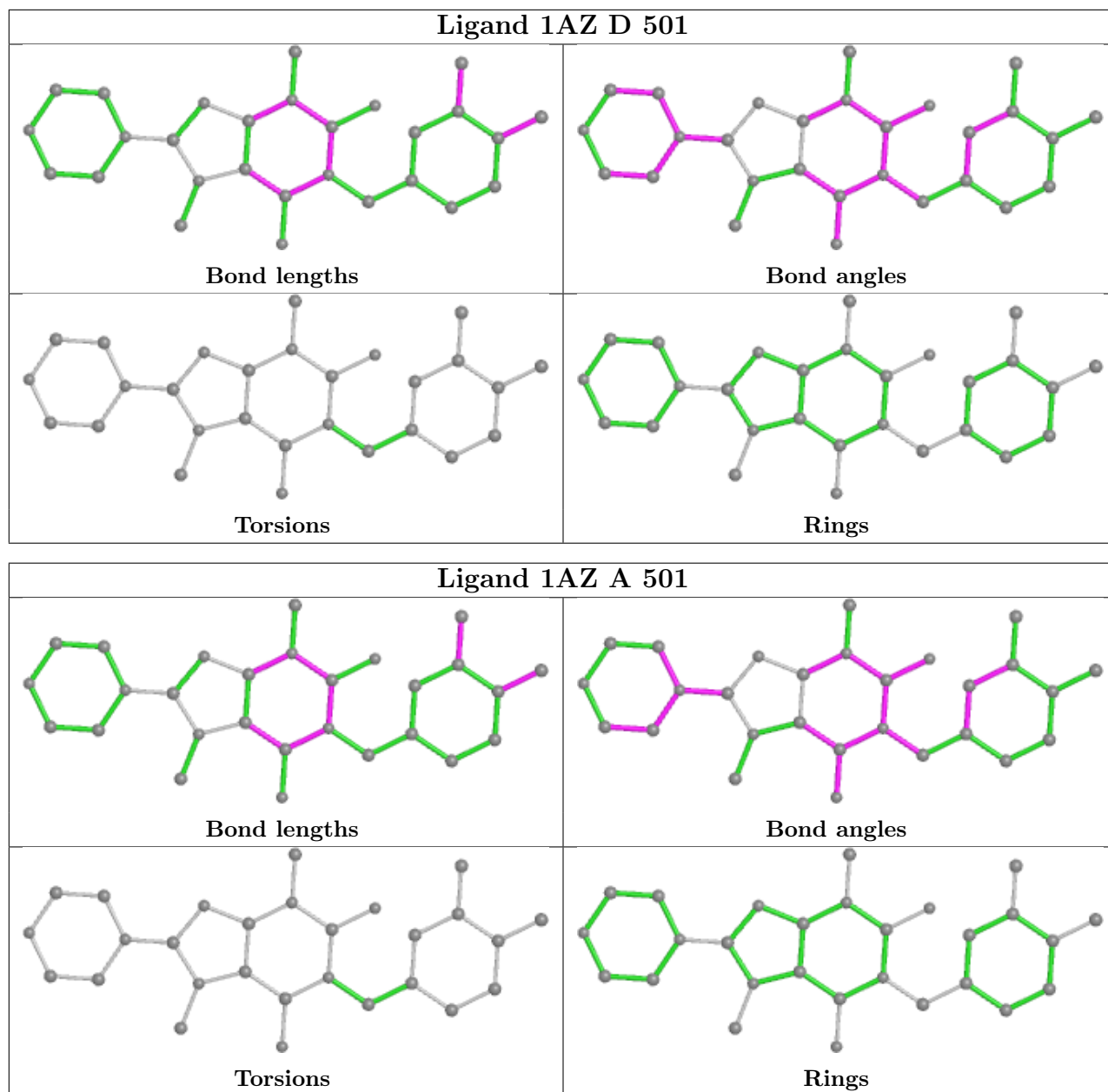

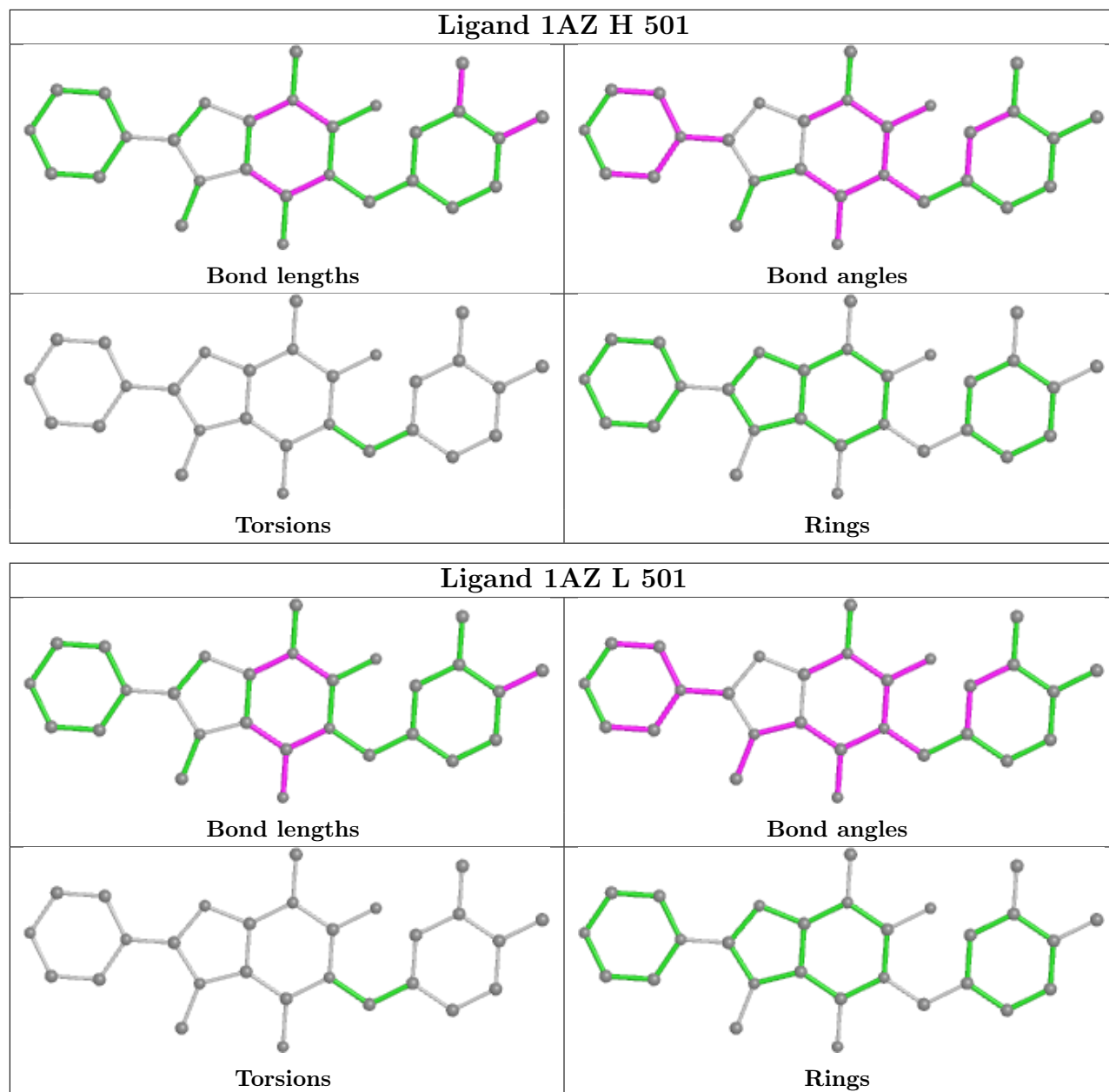

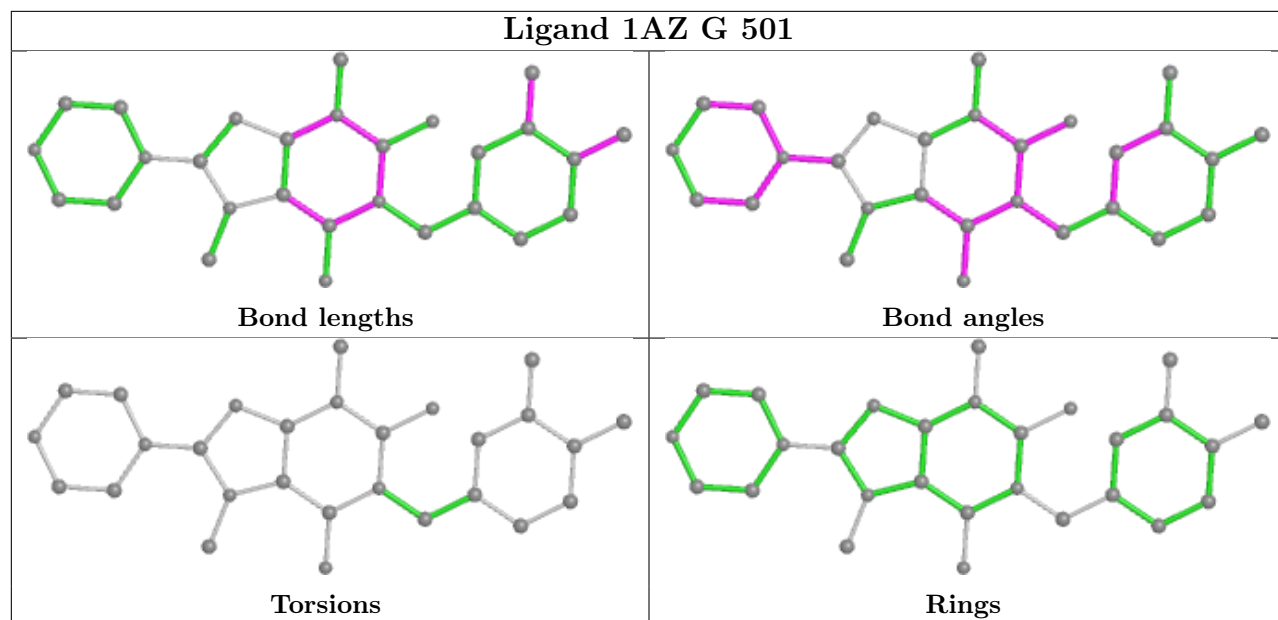

5.7 Other polymers [\(i\)](#)

There are no such residues in this entry.

5.8 Polymer linkage issues [\(i\)](#)

There are no chain breaks in this entry.

6 Fit of model and data [i](#)

6.1 Protein, DNA and RNA chains [i](#)

In the following table, the column labelled ‘#RSRZ> 2’ contains the number (and percentage) of RSRZ outliers, followed by percent RSRZ outliers for the chain as percentile scores relative to all X-ray entries and entries of similar resolution. The OWAB column contains the minimum, median, 95th percentile and maximum values of the occupancy-weighted average B-factor per residue. The column labelled ‘Q< 0.9’ lists the number of (and percentage) of residues with an average occupancy less than 0.9.

Mol	Chain	Analysed	<RSRZ>	#RSRZ>2	OWAB(Å ²)	Q<0.9
1	A	463/486 (95%)	0.60	45 (9%) 7 9	22, 38, 70, 99	0
1	B	463/486 (95%)	0.59	49 (10%) 6 8	22, 38, 70, 99	0
1	C	463/486 (95%)	0.69	66 (14%) 2 3	22, 39, 70, 99	0
1	D	463/486 (95%)	0.61	45 (9%) 7 9	22, 38, 70, 99	0
1	E	463/486 (95%)	0.63	40 (8%) 10 12	22, 38, 70, 99	0
1	F	463/486 (95%)	0.73	45 (9%) 7 9	22, 38, 70, 99	0
1	G	463/486 (95%)	0.62	50 (10%) 5 7	22, 38, 70, 99	0
1	H	463/486 (95%)	0.69	51 (11%) 5 7	22, 38, 70, 99	0
1	I	463/486 (95%)	0.66	56 (12%) 4 5	22, 39, 70, 99	0
1	J	463/486 (95%)	1.06	84 (18%) 1 1	22, 39, 70, 99	0
1	K	463/486 (95%)	0.64	53 (11%) 5 6	22, 39, 70, 99	0
1	L	463/486 (95%)	0.72	49 (10%) 6 8	22, 38, 70, 99	0
All	All	5556/5832 (95%)	0.69	633 (11%) 5 6	22, 39, 71, 99	0

All (633) RSRZ outliers are listed below:

Mol	Chain	Res	Type	RSRZ
1	J	333	GLY	12.8
1	I	334	TYR	11.1
1	L	61	PHE	9.5
1	J	296	ALA	9.3
1	C	414	ALA	9.2
1	I	61	PHE	9.2
1	J	347	ARG	9.0
1	J	334	TYR	9.0
1	H	58	ILE	8.9
1	L	413	ALA	8.8
1	G	414	ALA	8.8

Continued on next page...

Continued from previous page...

Mol	Chain	Res	Type	RSRZ
1	H	59	ARG	8.7
1	J	414	ALA	8.5
1	L	99	PHE	8.4
1	I	333	GLY	8.4
1	A	58	ILE	8.3
1	J	403	LYS	8.3
1	H	413	ALA	8.2
1	A	413	ALA	8.1
1	J	60	GLY	7.9
1	J	59	ARG	7.9
1	J	413	ALA	7.9
1	L	60	GLY	7.8
1	F	99	PHE	7.7
1	I	414	ALA	7.7
1	L	334	TYR	7.6
1	E	414	ALA	7.6
1	H	56	SER	7.6
1	A	414	ALA	7.5
1	H	57	SER	7.5
1	J	57	SER	7.4
1	K	414	ALA	7.4
1	H	61	PHE	7.4
1	C	99	PHE	7.3
1	K	332	PRO	7.2
1	J	401	VAL	7.1
1	A	404	ASP	7.1
1	J	61	PHE	7.1
1	B	58	ILE	7.1
1	F	404	ASP	7.1
1	G	99	PHE	7.0
1	K	333	GLY	7.0
1	E	415	SER	7.0
1	B	413	ALA	7.0
1	D	334	TYR	6.9
1	G	67	SER	6.8
1	A	403	LYS	6.8
1	A	334	TYR	6.7
1	E	334	TYR	6.7
1	L	403	LYS	6.6
1	L	58	ILE	6.6
1	J	58	ILE	6.6
1	F	61	PHE	6.5

Continued on next page...

Continued from previous page...

Mol	Chain	Res	Type	RSRZ
1	B	56	SER	6.5
1	F	413	ALA	6.4
1	B	61	PHE	6.4
1	D	99	PHE	6.4
1	D	333	GLY	6.4
1	C	332	PRO	6.4
1	J	402	ASP	6.4
1	H	67	SER	6.4
1	C	347	ARG	6.4
1	H	347	ARG	6.3
1	D	413	ALA	6.2
1	D	403	LYS	6.2
1	B	414	ALA	6.2
1	C	355	ILE	6.1
1	A	61	PHE	6.1
1	A	347	ARG	6.1
1	F	56	SER	6.0
1	J	404	ASP	6.0
1	F	335	GLU	6.0
1	H	404	ASP	6.0
1	C	403	LYS	5.9
1	J	415	SER	5.9
1	F	58	ILE	5.9
1	C	357	GLY	5.8
1	G	61	PHE	5.8
1	F	334	TYR	5.8
1	F	403	LYS	5.8
1	B	404	ASP	5.8
1	F	414	ALA	5.8
1	J	56	SER	5.7
1	I	413	ALA	5.7
1	H	332	PRO	5.7
1	C	334	TYR	5.7
1	B	59	ARG	5.6
1	H	55	GLY	5.6
1	I	67	SER	5.6
1	I	355	ILE	5.6
1	E	67	SER	5.5
1	H	333	GLY	5.5
1	A	99	PHE	5.5
1	L	56	SER	5.5
1	G	413	ALA	5.5

Continued on next page...

Continued from previous page...

Mol	Chain	Res	Type	RSRZ
1	D	347	ARG	5.5
1	J	184	GLY	5.5
1	H	334	TYR	5.5
1	B	347	ARG	5.4
1	H	403	LYS	5.4
1	F	62	GLN	5.4
1	F	401	VAL	5.4
1	J	292	GLU	5.4
1	K	62	GLN	5.4
1	D	58	ILE	5.4
1	E	333	GLY	5.4
1	B	62	GLN	5.4
1	B	99	PHE	5.4
1	H	335	GLU	5.3
1	J	293	THR	5.3
1	E	403	LYS	5.3
1	C	413	ALA	5.3
1	C	358	SER	5.3
1	J	416	ILE	5.3
1	D	404	ASP	5.3
1	H	414	ALA	5.3
1	I	56	SER	5.3
1	J	356	THR	5.3
1	D	415	SER	5.3
1	J	346	ASN	5.2
1	L	57	SER	5.2
1	L	404	ASP	5.2
1	D	60	GLY	5.2
1	H	184	GLY	5.2
1	B	336	ALA	5.2
1	C	404	ASP	5.2
1	B	335	GLU	5.1
1	J	358	SER	5.1
1	F	333	GLY	5.1
1	G	347	ARG	5.1
1	D	61	PHE	5.1
1	J	355	ILE	5.1
1	J	295	TYR	5.1
1	L	335	GLU	5.1
1	D	332	PRO	5.1
1	B	403	LYS	5.1
1	F	68	ASP	5.0

Continued on next page...

Continued from previous page...

Mol	Chain	Res	Type	RSRZ
1	L	59	ARG	5.0
1	L	45	SER	5.0
1	J	332	PRO	5.0
1	K	334	TYR	5.0
1	C	335	GLU	5.0
1	K	293	THR	5.0
1	J	357	GLY	5.0
1	D	335	GLU	5.0
1	L	414	ALA	4.9
1	K	345	ARG	4.9
1	G	334	TYR	4.9
1	H	62	GLN	4.9
1	L	68	ASP	4.9
1	C	333	GLY	4.9
1	D	414	ALA	4.9
1	K	58	ILE	4.8
1	I	99	PHE	4.8
1	J	122	THR	4.8
1	J	345	ARG	4.8
1	B	334	TYR	4.8
1	A	335	GLU	4.8
1	I	403	LYS	4.7
1	D	345	ARG	4.7
1	A	67	SER	4.7
1	A	333	GLY	4.6
1	G	293	THR	4.6
1	G	403	LYS	4.6
1	G	335	GLU	4.6
1	I	402	ASP	4.6
1	D	55	GLY	4.5
1	G	404	ASP	4.5
1	J	398	GLN	4.5
1	B	332	PRO	4.5
1	I	332	PRO	4.5
1	F	57	SER	4.5
1	D	67	SER	4.5
1	I	358	SER	4.5
1	D	416	ILE	4.5
1	H	99	PHE	4.5
1	C	401	VAL	4.5
1	K	358	SER	4.4
1	H	415	SER	4.4

Continued on next page...

Continued from previous page...

Mol	Chain	Res	Type	RSRZ
1	E	5	THR	4.4
1	C	331	VAL	4.4
1	G	415	SER	4.4
1	K	415	SER	4.4
1	J	399	ALA	4.4
1	B	333	GLY	4.4
1	J	341	VAL	4.4
1	B	57	SER	4.4
1	L	358	SER	4.4
1	K	347	ARG	4.4
1	H	60	GLY	4.4
1	A	345	ARG	4.4
1	C	61	PHE	4.4
1	C	62	GLN	4.3
1	F	415	SER	4.3
1	D	59	ARG	4.3
1	K	335	GLU	4.3
1	E	58	ILE	4.3
1	E	332	PRO	4.3
1	A	57	SER	4.2
1	A	401	VAL	4.2
1	C	415	SER	4.2
1	A	62	GLN	4.2
1	D	62	GLN	4.2
1	J	335	GLU	4.2
1	D	170	ALA	4.2
1	I	184	GLY	4.2
1	C	45	SER	4.2
1	H	345	ARG	4.1
1	J	120	ILE	4.1
1	L	62	GLN	4.1
1	J	362	ALA	4.1
1	E	345	ARG	4.1
1	I	62	GLN	4.1
1	J	62	GLN	4.1
1	E	335	GLU	4.1
1	J	99	PHE	4.0
1	I	335	GLU	4.0
1	B	5	THR	4.0
1	E	336	ALA	4.0
1	H	401	VAL	4.0
1	B	55	GLY	4.0

Continued on next page...

Continued from previous page...

Mol	Chain	Res	Type	RSRZ
1	J	45	SER	4.0
1	B	101	LEU	3.9
1	A	336	ALA	3.9
1	D	57	SER	3.9
1	G	62	GLN	3.9
1	E	309	LEU	3.9
1	J	449	GLU	3.9
1	G	56	SER	3.9
1	I	69	MET	3.9
1	C	67	SER	3.9
1	I	404	ASP	3.8
1	I	59	ARG	3.8
1	F	59	ARG	3.8
1	I	170	ALA	3.8
1	B	68	ASP	3.8
1	A	358	SER	3.8
1	K	57	SER	3.8
1	B	415	SER	3.8
1	E	61	PHE	3.8
1	E	404	ASP	3.8
1	J	342	TYR	3.8
1	K	300	ASP	3.7
1	B	293	THR	3.7
1	C	56	SER	3.7
1	K	362	ALA	3.7
1	C	346	ASN	3.7
1	C	183	LYS	3.6
1	C	360	PRO	3.6
1	A	402	ASP	3.6
1	J	284	ASP	3.6
1	E	413	ALA	3.6
1	G	100	THR	3.6
1	K	403	LYS	3.6
1	D	56	SER	3.5
1	K	67	SER	3.5
1	G	449	GLU	3.5
1	I	415	SER	3.5
1	J	55	GLY	3.5
1	L	55	GLY	3.5
1	J	348	SER	3.5
1	J	291	ASP	3.5
1	C	293	THR	3.5

Continued on next page...

Continued from previous page...

Mol	Chain	Res	Type	RSRZ
1	C	336	ALA	3.5
1	H	358	SER	3.5
1	J	344	GLN	3.5
1	K	404	ASP	3.5
1	H	293	THR	3.5
1	F	60	GLY	3.5
1	B	345	ARG	3.4
1	A	415	SER	3.4
1	C	59	ARG	3.4
1	C	402	ASP	3.4
1	K	367	PHE	3.4
1	B	346	ASN	3.4
1	D	100	THR	3.4
1	E	347	ARG	3.4
1	D	402	ASP	3.4
1	C	416	ILE	3.4
1	F	347	ARG	3.4
1	I	347	ARG	3.4
1	L	54	ASP	3.4
1	I	58	ILE	3.4
1	E	45	SER	3.4
1	L	415	SER	3.4
1	A	101	LEU	3.3
1	A	56	SER	3.3
1	F	332	PRO	3.3
1	I	5	THR	3.3
1	I	293	THR	3.3
1	L	100	THR	3.3
1	K	59	ARG	3.3
1	F	346	ASN	3.3
1	G	355	ILE	3.3
1	C	285	GLY	3.3
1	E	351	VAL	3.3
1	F	101	LEU	3.3
1	F	277	CYS	3.3
1	J	400	PRO	3.2
1	K	336	ALA	3.2
1	J	67	SER	3.2
1	J	118	TYR	3.2
1	D	401	VAL	3.2
1	G	333	GLY	3.2
1	H	100	THR	3.2

Continued on next page...

Continued from previous page...

Mol	Chain	Res	Type	RSRZ
1	K	184	GLY	3.2
1	A	416	ILE	3.2
1	I	292	GLU	3.2
1	L	332	PRO	3.2
1	J	418	GLN	3.2
1	G	416	ILE	3.2
1	C	48	ASP	3.1
1	H	416	ILE	3.1
1	K	61	PHE	3.1
1	J	360	PRO	3.1
1	F	402	ASP	3.1
1	I	55	GLY	3.1
1	G	59	ARG	3.1
1	H	170	ALA	3.1
1	L	101	LEU	3.1
1	B	183	LYS	3.1
1	J	417	PRO	3.1
1	A	170	ALA	3.1
1	J	450	THR	3.1
1	B	54	ASP	3.0
1	C	345	ARG	3.0
1	K	99	PHE	3.0
1	D	186	TYR	3.0
1	B	357	GLY	3.0
1	G	285	GLY	3.0
1	L	454	PHE	3.0
1	A	59	ARG	3.0
1	F	45	SER	3.0
1	H	5	THR	3.0
1	H	101	LEU	3.0
1	C	6	PRO	3.0
1	I	435	GLU	3.0
1	C	7	ASP	3.0
1	B	67	SER	3.0
1	D	45	SER	3.0
1	B	17	LYS	3.0
1	E	383	MET	3.0
1	J	283	LYS	3.0
1	E	99	PHE	3.0
1	C	290	TYR	3.0
1	I	284	ASP	3.0
1	A	295	TYR	3.0

Continued on next page...

Continued from previous page...

Mol	Chain	Res	Type	RSRZ
1	C	286	ALA	3.0
1	C	291	ASP	2.9
1	L	416	ILE	2.9
1	J	44	LYS	2.9
1	G	101	LEU	2.9
1	I	97	ASP	2.9
1	F	67	SER	2.9
1	K	416	ILE	2.9
1	K	445	ASN	2.9
1	E	449	GLU	2.9
1	D	449	GLU	2.9
1	J	102	GLU	2.9
1	J	290	TYR	2.9
1	F	54	ASP	2.9
1	F	454	PHE	2.9
1	C	5	THR	2.9
1	C	170	ALA	2.9
1	I	100	THR	2.9
1	I	101	LEU	2.9
1	L	67	SER	2.8
1	K	444	THR	2.8
1	G	300	ASP	2.8
1	F	358	SER	2.8
1	L	347	ARG	2.8
1	B	98	PRO	2.8
1	K	350	CYS	2.8
1	B	450	THR	2.8
1	J	304	HIS	2.8
1	K	5	THR	2.8
1	L	333	GLY	2.8
1	H	69	MET	2.8
1	K	304	HIS	2.8
1	J	300	ASP	2.8
1	K	291	ASP	2.8
1	C	338	ILE	2.8
1	J	42	PHE	2.8
1	H	48	ASP	2.8
1	B	100	THR	2.8
1	D	30	GLY	2.8
1	G	170	ALA	2.8
1	J	351	VAL	2.7
1	J	183	LYS	2.7

Continued on next page...

Continued from previous page...

Mol	Chain	Res	Type	RSRZ
1	E	352	ARG	2.7
1	G	358	SER	2.7
1	C	98	PRO	2.7
1	B	60	GLY	2.7
1	A	450	THR	2.7
1	L	170	ALA	2.7
1	E	358	SER	2.7
1	L	365	LEU	2.7
1	A	293	THR	2.7
1	C	356	THR	2.7
1	B	290	TYR	2.7
1	B	291	ASP	2.7
1	E	7	ASP	2.7
1	J	11	LYS	2.7
1	L	351	VAL	2.7
1	A	186	TYR	2.7
1	J	297	GLY	2.7
1	F	351	VAL	2.7
1	C	450	THR	2.7
1	C	294	GLY	2.7
1	L	346	ASN	2.7
1	A	332	PRO	2.7
1	D	336	ALA	2.6
1	I	44	LYS	2.6
1	K	101	LEU	2.6
1	H	68	ASP	2.6
1	F	336	ALA	2.6
1	G	58	ILE	2.6
1	G	345	ARG	2.6
1	F	100	THR	2.6
1	J	441	GLY	2.6
1	G	332	PRO	2.6
1	J	121	SER	2.6
1	G	284	ASP	2.6
1	H	8	ASP	2.6
1	L	277	CYS	2.6
1	C	184	GLY	2.6
1	C	49	ASP	2.6
1	A	360	PRO	2.6
1	B	338	ILE	2.6
1	E	380	PHE	2.6
1	J	435	GLU	2.6

Continued on next page...

Continued from previous page...

Mol	Chain	Res	Type	RSRZ
1	A	285	GLY	2.6
1	G	55	GLY	2.6
1	J	445	ASN	2.6
1	L	285	GLY	2.6
1	G	5	THR	2.6
1	C	435	GLU	2.6
1	D	309	LEU	2.6
1	C	58	ILE	2.6
1	F	367	PHE	2.6
1	F	55	GLY	2.6
1	G	184	GLY	2.6
1	H	351	VAL	2.5
1	J	46	VAL	2.5
1	A	355	ILE	2.5
1	I	416	ILE	2.5
1	K	15	ASP	2.5
1	G	286	ALA	2.5
1	A	98	PRO	2.5
1	L	345	ARG	2.5
1	C	300	ASP	2.5
1	I	8	ASP	2.5
1	I	173	SER	2.5
1	C	97	ASP	2.5
1	J	294	GLY	2.5
1	K	126	ASP	2.5
1	C	392	LYS	2.5
1	C	292	GLU	2.5
1	C	126	ASP	2.5
1	G	183	LYS	2.5
1	B	184	GLY	2.5
1	L	350	CYS	2.5
1	C	282	TRP	2.5
1	G	402	ASP	2.5
1	C	101	LEU	2.5
1	A	100	THR	2.5
1	K	357	GLY	2.5
1	B	126	ASP	2.5
1	D	360	PRO	2.5
1	J	285	GLY	2.5
1	K	413	ALA	2.5
1	A	40	SER	2.4
1	D	346	ASN	2.4

Continued on next page...

Continued from previous page...

Mol	Chain	Res	Type	RSRZ
1	F	376	PRO	2.4
1	E	62	GLN	2.4
1	C	57	SER	2.4
1	B	102	GLU	2.4
1	G	97	ASP	2.4
1	H	54	ASP	2.4
1	H	367	PHE	2.4
1	H	183	LYS	2.4
1	F	399	ALA	2.4
1	D	284	ASP	2.4
1	I	294	GLY	2.4
1	K	6	PRO	2.4
1	H	4	LYS	2.4
1	C	295	TYR	2.4
1	F	170	ALA	2.4
1	I	309	LEU	2.4
1	I	345	ARG	2.4
1	I	357	GLY	2.4
1	H	292	GLU	2.4
1	I	16	GLU	2.4
1	B	4	LYS	2.4
1	A	284	ASP	2.4
1	B	170	ALA	2.4
1	I	432	ALA	2.4
1	I	57	SER	2.4
1	J	303	ARG	2.4
1	I	360	PRO	2.4
1	K	69	MET	2.4
1	K	100	THR	2.4
1	F	309	LEU	2.4
1	J	298	LEU	2.4
1	K	295	TYR	2.3
1	E	379	ALA	2.3
1	D	17	LYS	2.3
1	J	361	LYS	2.3
1	D	49	ASP	2.3
1	E	417	PRO	2.3
1	K	402	ASP	2.3
1	L	376	PRO	2.3
1	H	449	GLU	2.3
1	A	453	SER	2.3
1	J	126	ASP	2.3

Continued on next page...

Continued from previous page...

Mol	Chain	Res	Type	RSRZ
1	F	26	CYS	2.3
1	H	11	LYS	2.3
1	J	338	ILE	2.3
1	A	55	GLY	2.3
1	E	284	ASP	2.3
1	H	402	ASP	2.3
1	D	331	VAL	2.3
1	J	54	ASP	2.3
1	G	282	TRP	2.3
1	A	338	ILE	2.3
1	J	390	GLY	2.3
1	K	56	SER	2.3
1	D	31	ILE	2.3
1	A	132	ALA	2.3
1	D	398	GLN	2.3
1	G	398	GLN	2.3
1	I	356	THR	2.3
1	K	122	THR	2.3
1	C	215	LYS	2.2
1	E	376	PRO	2.2
1	F	24	ARG	2.2
1	G	351	VAL	2.2
1	K	346	ASN	2.2
1	E	170	ALA	2.2
1	E	367	PHE	2.2
1	B	360	PRO	2.2
1	C	171	ASP	2.2
1	I	7	ASP	2.2
1	K	45	SER	2.2
1	H	186	TYR	2.2
1	J	359	ASN	2.2
1	K	186	TYR	2.2
1	G	294	GLY	2.2
1	H	7	ASP	2.2
1	L	184	GLY	2.2
1	K	292	GLU	2.2
1	B	358	SER	2.2
1	B	453	SER	2.2
1	G	277	CYS	2.2
1	G	372	SER	2.2
1	J	69	MET	2.2
1	J	453	SER	2.2

Continued on next page...

Continued from previous page...

Mol	Chain	Res	Type	RSRZ
1	L	44	LYS	2.2
1	I	367	PHE	2.2
1	G	71	LEU	2.2
1	A	449	GLU	2.2
1	G	360	PRO	2.2
1	I	449	GLU	2.2
1	I	49	ASP	2.2
1	K	284	ASP	2.2
1	L	8	ASP	2.2
1	K	348	SER	2.2
1	I	401	VAL	2.2
1	H	286	ALA	2.2
1	C	100	THR	2.2
1	B	7	ASP	2.2
1	E	360	PRO	2.2
1	L	183	LYS	2.2
1	K	290	TYR	2.2
1	D	358	SER	2.2
1	I	286	ALA	2.2
1	C	284	ASP	2.2
1	G	7	ASP	2.2
1	D	340	LEU	2.2
1	H	350	CYS	2.2
1	J	287	PRO	2.2
1	G	186	TYR	2.2
1	G	275	MET	2.2
1	A	4	LYS	2.2
1	C	432	ALA	2.2
1	F	374	GLY	2.2
1	L	25	PHE	2.2
1	C	400	PRO	2.2
1	L	309	LEU	2.2
1	F	242	MET	2.1
1	K	282	TRP	2.1
1	B	294	GLY	2.1
1	B	53	PHE	2.1
1	L	51	LEU	2.1
1	L	49	ASP	2.1
1	D	351	VAL	2.1
1	D	399	ALA	2.1
1	L	336	ALA	2.1
1	F	416	ILE	2.1

Continued on next page...

Continued from previous page...

Mol	Chain	Res	Type	RSRZ
1	K	215	LYS	2.1
1	I	54	ASP	2.1
1	I	186	TYR	2.1
1	C	351	VAL	2.1
1	E	416	ILE	2.1
1	E	59	ARG	2.1
1	A	376	PRO	2.1
1	A	97	ASP	2.1
1	I	11	LYS	2.1
1	E	184	GLY	2.1
1	L	69	MET	2.1
1	I	446	ASP	2.1
1	L	71	LEU	2.1
1	G	435	GLU	2.1
1	C	376	PRO	2.0
1	L	370	PRO	2.0
1	H	46	VAL	2.0
1	K	320	THR	2.0
1	E	306	ILE	2.0
1	F	353	ILE	2.0
1	H	12	LEU	2.0
1	H	102	GLU	2.0
1	J	4	LYS	2.0
1	E	331	VAL	2.0
1	B	11	LYS	2.0
1	F	345	ARG	2.0
1	J	15	ASP	2.0
1	H	277	CYS	2.0
1	G	60	GLY	2.0
1	C	10	PHE	2.0
1	E	443	PHE	2.0
1	D	54	ASP	2.0
1	G	461	GLU	2.0
1	I	4	LYS	2.0

6.2 Non-standard residues in protein, DNA, RNA chains [\(i\)](#)

There are no non-standard protein/DNA/RNA residues in this entry.

6.3 Carbohydrates [i](#)

There are no monosaccharides in this entry.

6.4 Ligands [i](#)

In the following table, the Atoms column lists the number of modelled atoms in the group and the number defined in the chemical component dictionary. The B-factors column lists the minimum, median, 95th percentile and maximum values of B factors of atoms in the group. The column labelled 'Q< 0.9' lists the number of atoms with occupancy less than 0.9.

Mol	Type	Chain	Res	Atoms	RSCC	RSR	B-factors(Å ²)	Q<0.9
2	1AZ	H	501	28/28	0.85	0.21	46,47,48,50	0
2	1AZ	K	501	28/28	0.86	0.22	46,47,49,50	0
3	CL	J	502	1/1	0.86	0.20	57,57,57,57	0
2	1AZ	J	501	28/28	0.87	0.28	46,47,49,50	0
2	1AZ	E	501	28/28	0.87	0.18	46,47,48,49	0
2	1AZ	D	501	28/28	0.87	0.19	46,47,48,49	0
2	1AZ	A	501	28/28	0.88	0.25	46,47,49,49	0
2	1AZ	L	501	28/28	0.88	0.16	46,47,48,49	0
2	1AZ	C	501	28/28	0.88	0.25	46,47,49,50	0
2	1AZ	G	501	28/28	0.89	0.23	46,47,48,50	0
3	CL	A	502	1/1	0.89	0.10	57,57,57,57	0
3	CL	C	502	1/1	0.89	0.14	57,57,57,57	0
3	CL	G	502	1/1	0.89	0.14	57,57,57,57	0
2	1AZ	B	501	28/28	0.89	0.17	46,47,48,50	0
2	1AZ	F	501	28/28	0.90	0.17	46,47,48,49	0
2	1AZ	I	501	28/28	0.92	0.23	46,47,49,50	0
3	CL	B	502	1/1	0.93	0.22	57,57,57,57	0
3	CL	F	502	1/1	0.94	0.21	57,57,57,57	0
3	CL	I	502	1/1	0.95	0.13	57,57,57,57	0
3	CL	H	502	1/1	0.95	0.16	57,57,57,57	0
3	CL	E	502	1/1	0.97	0.18	57,57,57,57	0
3	CL	D	502	1/1	0.97	0.14	57,57,57,57	0
3	CL	K	502	1/1	0.98	0.36	58,58,58,58	0
3	CL	L	502	1/1	0.98	0.31	57,57,57,57	0

The following is a graphical depiction of the model fit to experimental electron density of all instances of the Ligand of Interest. In addition, ligands with molecular weight > 250 and outliers as shown on the geometry validation Tables will also be included. Each fit is shown from different orientation to approximate a three-dimensional view.

Electron density around 1AZ H 501:

$2mF_o-DF_c$ (at 0.7 rmsd) in gray
 mF_o-DF_c (at 3 rmsd) in purple (negative)
and green (positive)

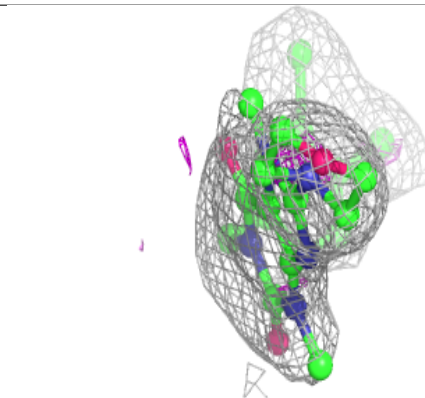
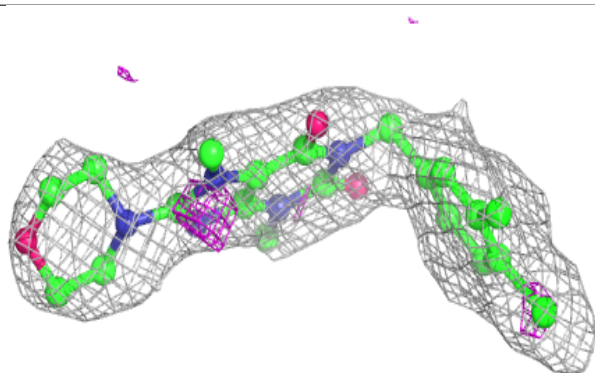
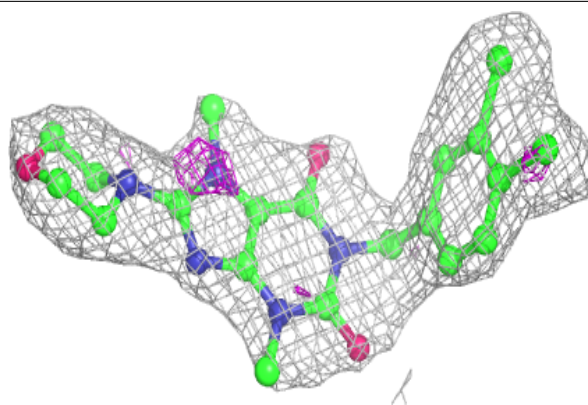
**Electron density around 1AZ K 501:**

$2mF_o-DF_c$ (at 0.7 rmsd) in gray
 mF_o-DF_c (at 3 rmsd) in purple (negative)
and green (positive)

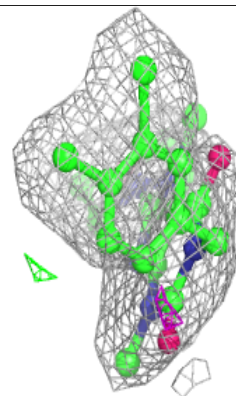
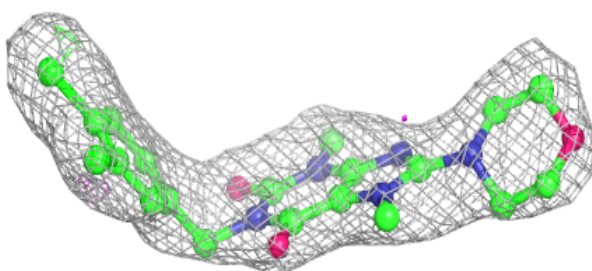
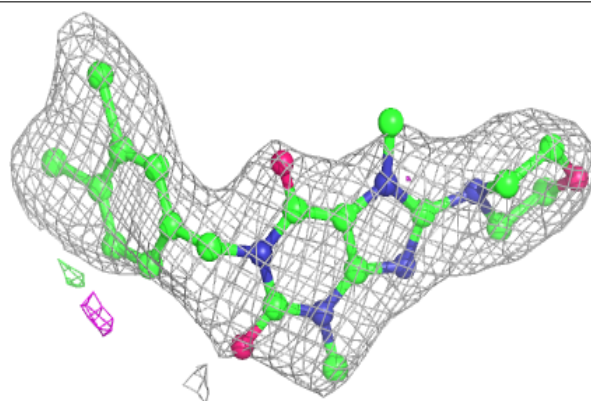

Electron density around 1AZ J 501:

$2mF_o-DF_c$ (at 0.7 rmsd) in gray
 mF_o-DF_c (at 3 rmsd) in purple (negative)
and green (positive)

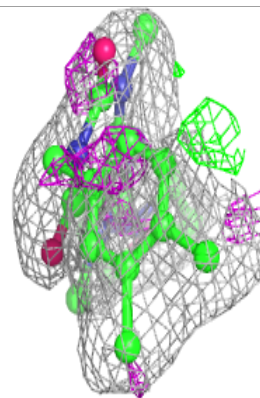
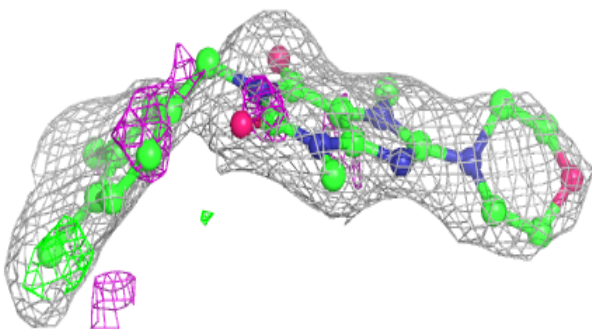
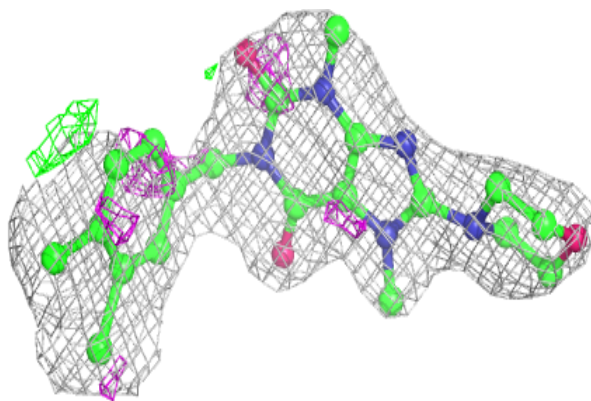
**Electron density around 1AZ E 501:**

$2mF_o-DF_c$ (at 0.7 rmsd) in gray
 mF_o-DF_c (at 3 rmsd) in purple (negative)
and green (positive)

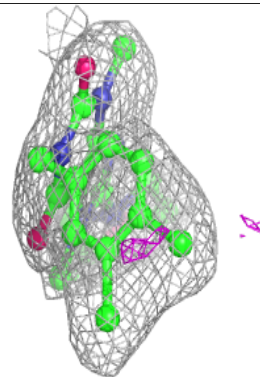
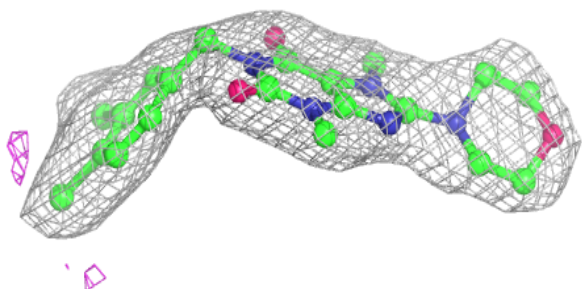
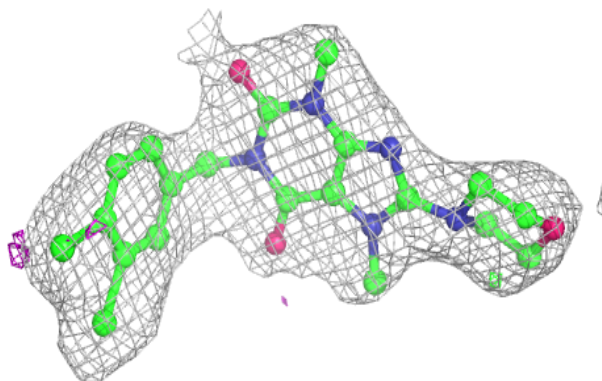

Electron density around 1AZ D 501:

$2mF_o-DF_c$ (at 0.7 rmsd) in gray
 mF_o-DF_c (at 3 rmsd) in purple (negative)
and green (positive)

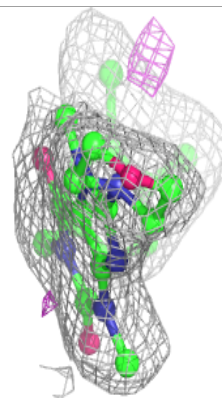
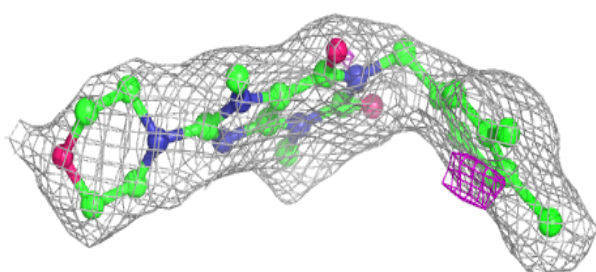
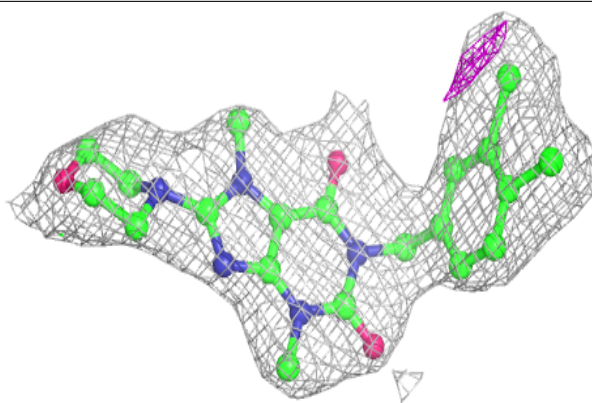
**Electron density around 1AZ A 501:**

$2mF_o-DF_c$ (at 0.7 rmsd) in gray
 mF_o-DF_c (at 3 rmsd) in purple (negative)
and green (positive)

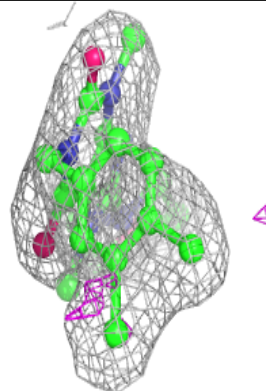
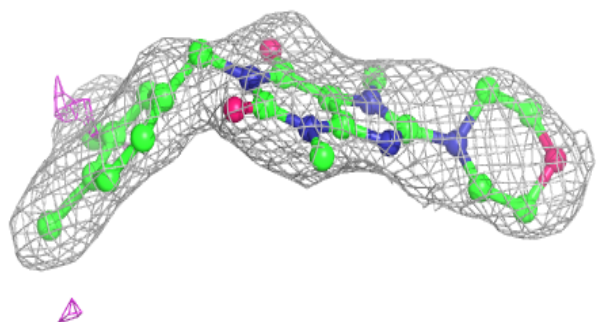
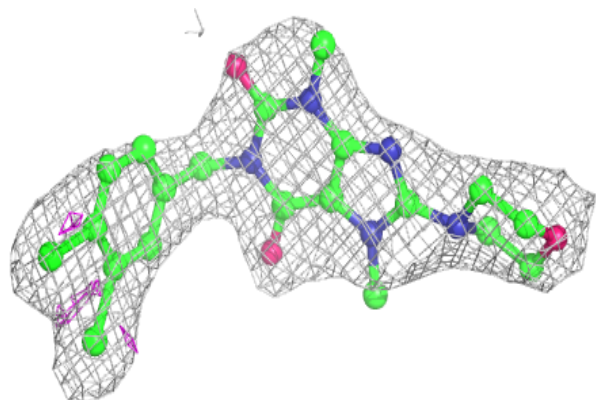

Electron density around 1AZ L 501:

$2mF_o-DF_c$ (at 0.7 rmsd) in gray
 mF_o-DF_c (at 3 rmsd) in purple (negative)
and green (positive)

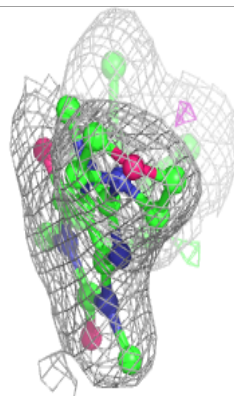
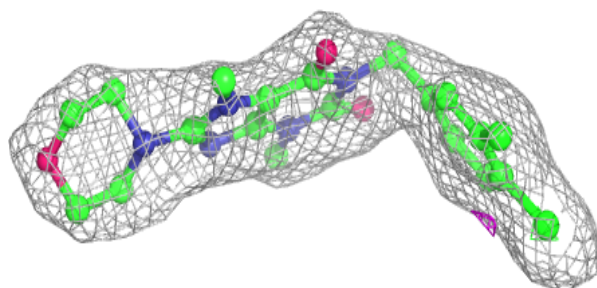
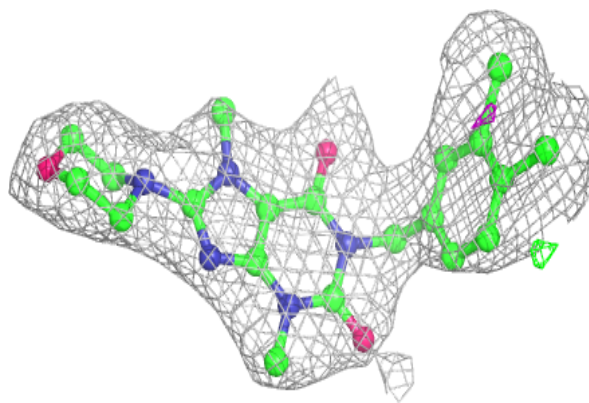
**Electron density around 1AZ C 501:**

$2mF_o-DF_c$ (at 0.7 rmsd) in gray
 mF_o-DF_c (at 3 rmsd) in purple (negative)
and green (positive)

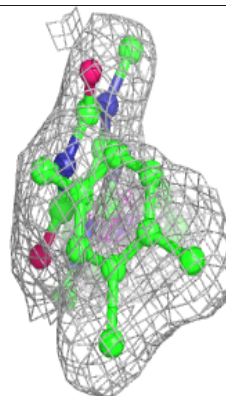
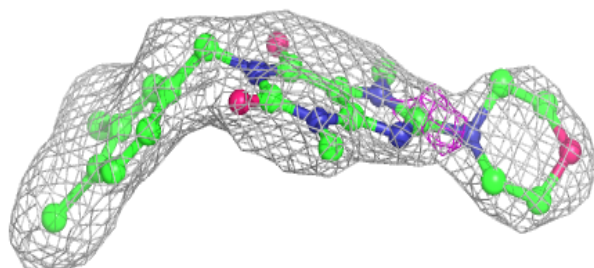
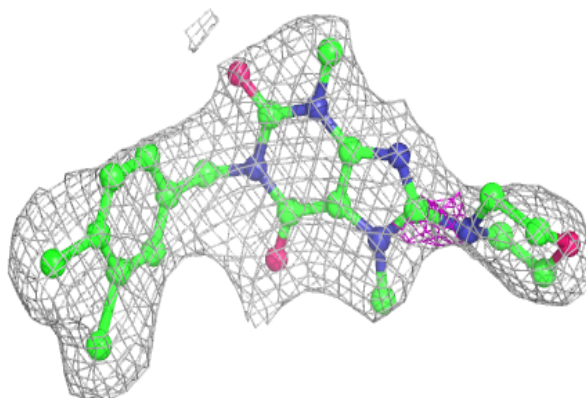

Electron density around 1AZ G 501:

$2mF_o-DF_c$ (at 0.7 rmsd) in gray
 mF_o-DF_c (at 3 rmsd) in purple (negative)
and green (positive)

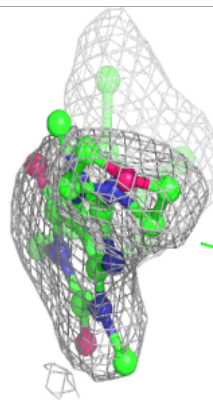
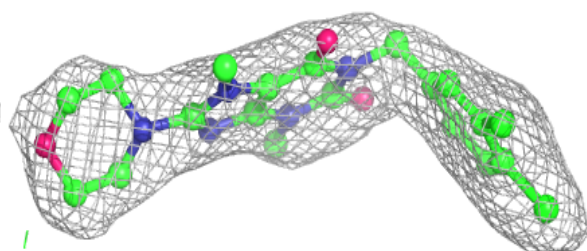
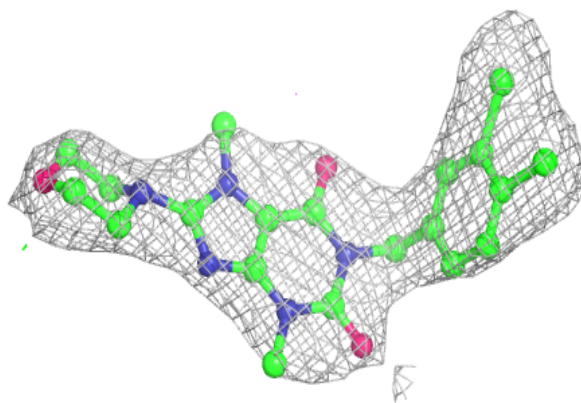
**Electron density around 1AZ B 501:**

$2mF_o-DF_c$ (at 0.7 rmsd) in gray
 mF_o-DF_c (at 3 rmsd) in purple (negative)
and green (positive)

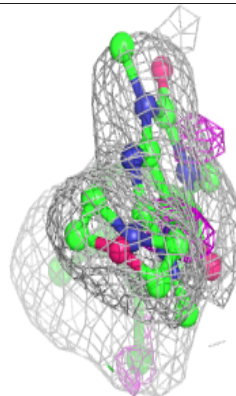
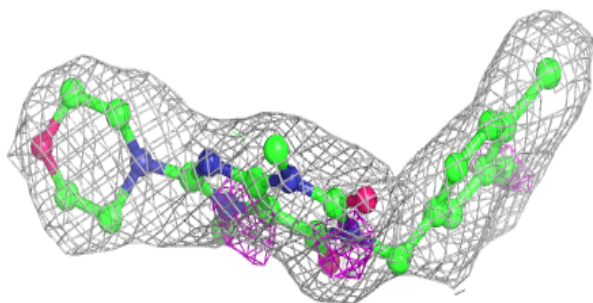
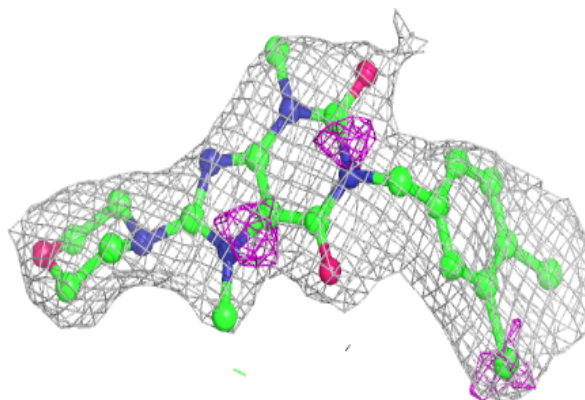

Electron density around 1AZ F 501:

$2mF_o-DF_c$ (at 0.7 rmsd) in gray
 mF_o-DF_c (at 3 rmsd) in purple (negative)
and green (positive)

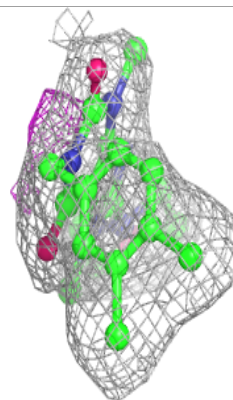
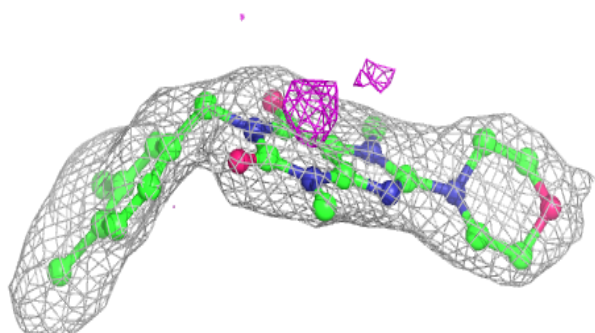
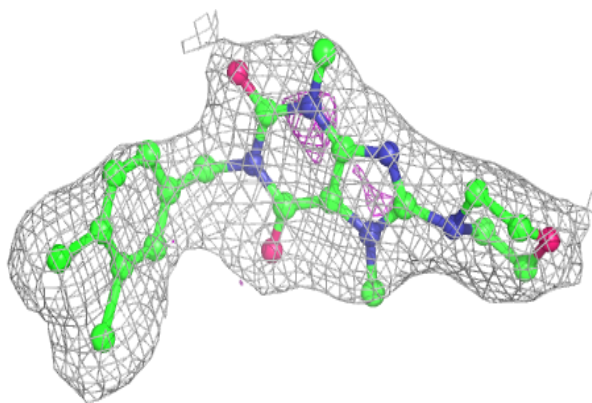
**Electron density around 1AZ I 501:**

$2mF_o-DF_c$ (at 0.7 rmsd) in gray
 mF_o-DF_c (at 3 rmsd) in purple (negative)
and green (positive)

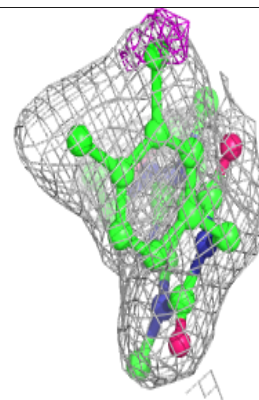
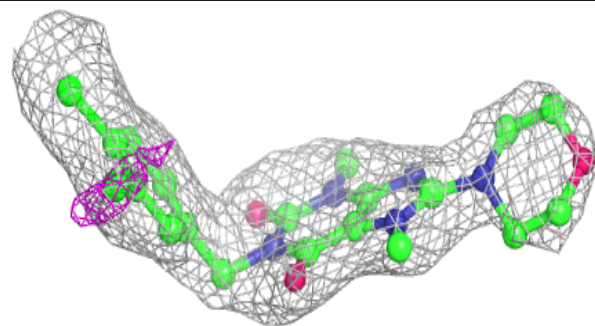
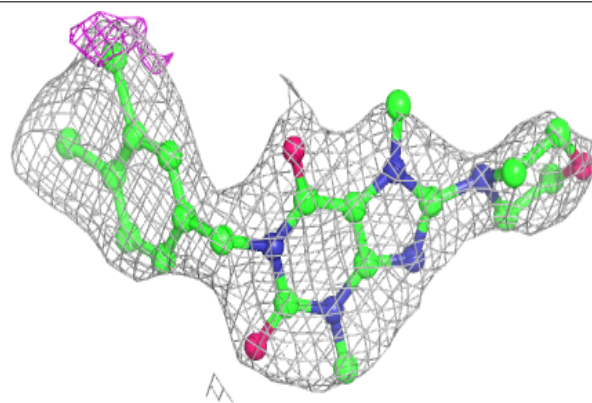

6.5 Other polymers [i](#)

There are no such residues in this entry.