



Full wwPDB EM Validation Report ⓘ

Dec 29, 2024 – 08:19 PM EST

PDB ID : 7WMP
EMDB ID : EMD-32616
Title : Tail structure of Helicobacter pylori bacteriophage KHP30
Authors : Kamiya, R.; Uchiyama, J.; Matsuzaki, S.; Murata, K.; Iwasaki, K.; Miyazaki, N.
Deposited on : 2022-01-15
Resolution : 3.60 Å(reported)

This is a Full wwPDB EM Validation Report for a publicly released PDB entry.

We welcome your comments at validation@mail.wwpdb.org

A user guide is available at

<https://www.wwpdb.org/validation/2017/EMValidationReportHelp>

with specific help available everywhere you see the ⓘ symbol.

The types of validation reports are described at

<http://www.wwpdb.org/validation/2017/FAQs#types>.

The following versions of software and data (see [references ⓘ](#)) were used in the production of this report:

EMDB validation analysis : 0.0.1.dev113
MolProbity : 4.02b-467
Percentile statistics : 20231227.v01 (using entries in the PDB archive December 27th 2023)
MapQ : 1.9.13
Ideal geometry (proteins) : Engh & Huber (2001)
Ideal geometry (DNA, RNA) : Parkinson et al. (1996)
Validation Pipeline (wwPDB-VP) : 2.40

1 Overall quality at a glance i

The following experimental techniques were used to determine the structure:
ELECTRON MICROSCOPY

The reported resolution of this entry is 3.60 Å.

Percentile scores (ranging between 0-100) for global validation metrics of the entry are shown in the following graphic. The table shows the number of entries on which the scores are based.

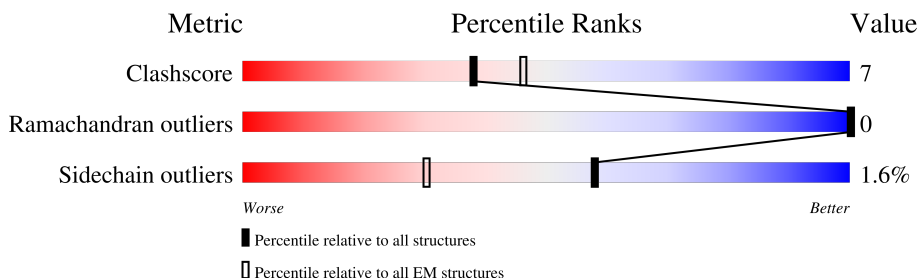





Metric	Whole archive (#Entries)	EM structures (#Entries)
Clashscore	210492	15764
Ramachandran outliers	207382	16835
Sidechain outliers	206894	16415

The table below summarises the geometric issues observed across the polymeric chains and their fit to the map. The red, orange, yellow and green segments of the bar indicate the fraction of residues that contain outliers for ≥ 3 , 2, 1 and 0 types of geometric quality criteria respectively. A grey segment represents the fraction of residues that are not modelled. The numeric value for each fraction is indicated below the corresponding segment, with a dot representing fractions $\leq 5\%$. The upper red bar (where present) indicates the fraction of residues that have poor fit to the EM map (all-atom inclusion $< 40\%$). The numeric value is given above the bar.

Mol	Chain	Length	Quality of chain
1	a	602	
1	b	602	
1	c	602	
1	d	602	
1	e	602	
1	f	602	
1	g	602	
1	h	602	

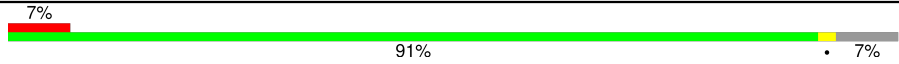
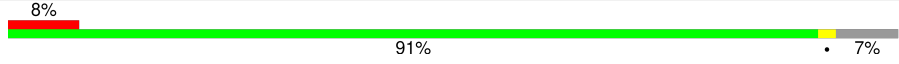
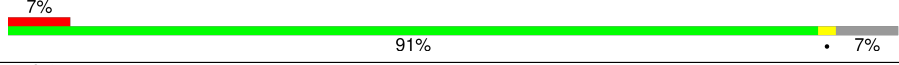
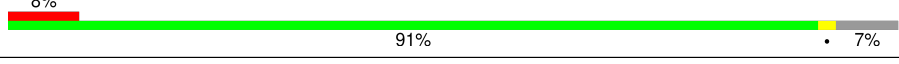
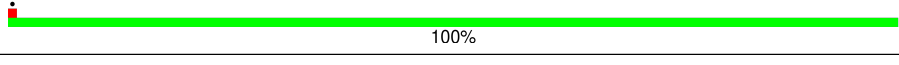
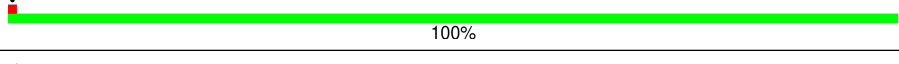
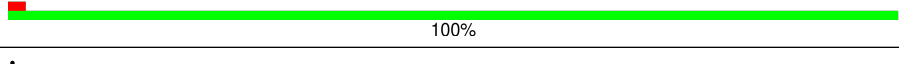
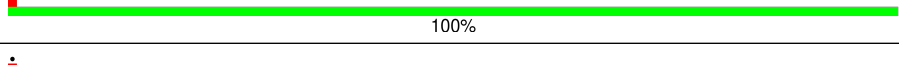
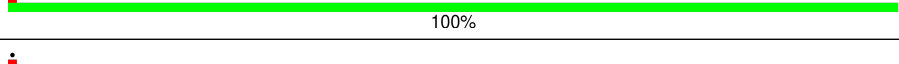
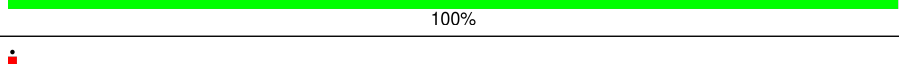
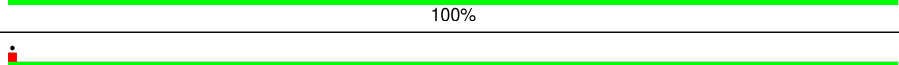
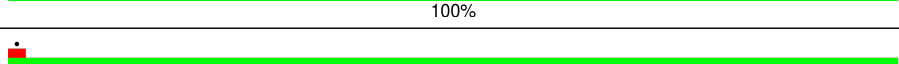
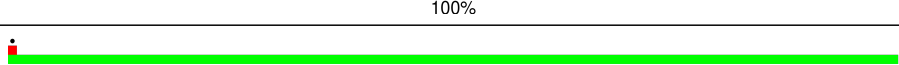
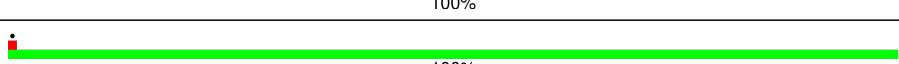
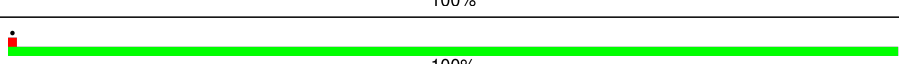
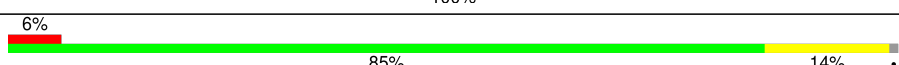
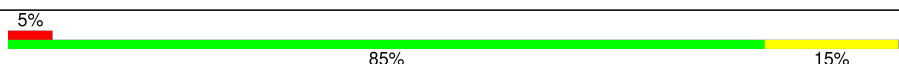
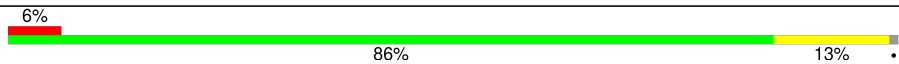
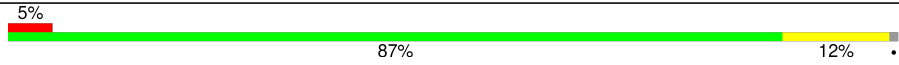

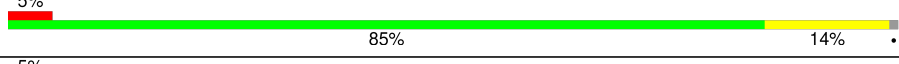
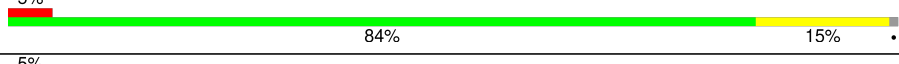
Continued on next page...

Continued from previous page...

Mol	Chain	Length	Quality of chain
1	i	602	 7% 91% 7%
1	j	602	 8% 91% 7%
1	k	602	 7% 91% 7%
1	l	602	 8% 91% 7%
2	m	195	 100%
2	n	195	 100%
2	o	195	 100%
2	p	195	 100%
2	q	195	 100%
2	r	195	 100%
2	s	195	 100%
2	t	195	 100%
2	u	195	 100%
2	v	195	 100%
2	w	195	 100%
2	x	195	 100%
3	A	265	 6% 85% 14%
3	B	265	 5% 85% 15%
3	C	265	 6% 86% 13%
3	D	265	 5% 87% 12%
3	E	265	 5% 86% 13%
3	F	265	 86% 13%
3	G	265	 5% 85% 14%
3	H	265	 5% 84% 15%
3	I	265	 5% 84% 15%

Continued on next page...

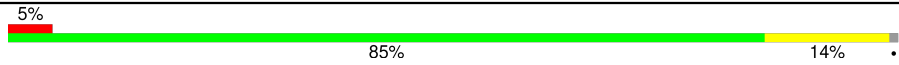
Continued from previous page...

Mol	Chain	Length	Quality of chain
3	J	265	
3	K	265	
3	L	265	

2 Entry composition i

There are 3 unique types of molecules in this entry. The entry contains 98184 atoms, of which 0 are hydrogens and 0 are deuteriums.

In the tables below, the AltConf column contains the number of residues with at least one atom in alternate conformation and the Trace column contains the number of residues modelled with at most 2 atoms.

- Molecule 1 is a protein called Portal protein.

Mol	Chain	Residues	Atoms					AltConf	Trace
			Total	C	N	O	S		
1	a	559	Total	C	N	O	S	0	0
			4532	2875	767	870	20		
1	b	559	Total	C	N	O	S	0	0
			4532	2875	767	870	20		
1	c	559	Total	C	N	O	S	0	0
			4532	2875	767	870	20		
1	d	559	Total	C	N	O	S	0	0
			4532	2875	767	870	20		
1	e	559	Total	C	N	O	S	0	0
			4532	2875	767	870	20		
1	f	559	Total	C	N	O	S	0	0
			4532	2875	767	870	20		
1	g	559	Total	C	N	O	S	0	0
			4532	2875	767	870	20		
1	h	559	Total	C	N	O	S	0	0
			4532	2875	767	870	20		
1	i	559	Total	C	N	O	S	0	0
			4532	2875	767	870	20		
1	j	559	Total	C	N	O	S	0	0
			4532	2875	767	870	20		
1	k	559	Total	C	N	O	S	0	0
			4532	2875	767	870	20		
1	l	559	Total	C	N	O	S	0	0
			4532	2875	767	870	20		

- Molecule 2 is a protein called Adaptor protein gp12.

Mol	Chain	Residues	Atoms					AltConf	Trace
			Total	C	N	O	S		
2	m	195	Total	C	N	O	S	0	0
			1586	1018	259	304	5		
2	n	195	Total	C	N	O	S	0	0
			1586	1018	259	304	5		
2	o	195	Total	C	N	O	S	0	0
			1586	1018	259	304	5		

Continued on next page...

Continued from previous page...

Mol	Chain	Residues	Atoms					AltConf	Trace
2	p	195	Total	C	N	O	S	0	0
			1586	1018	259	304	5		
2	q	195	Total	C	N	O	S	0	0
			1586	1018	259	304	5		
2	r	195	Total	C	N	O	S	0	0
			1586	1018	259	304	5		
2	s	195	Total	C	N	O	S	0	0
			1586	1018	259	304	5		
2	t	195	Total	C	N	O	S	0	0
			1586	1018	259	304	5		
2	u	195	Total	C	N	O	S	0	0
			1586	1018	259	304	5		
2	v	195	Total	C	N	O	S	0	0
			1586	1018	259	304	5		
2	w	195	Total	C	N	O	S	0	0
			1586	1018	259	304	5		
2	x	195	Total	C	N	O	S	0	0
			1586	1018	259	304	5		

- Molecule 3 is a protein called Nozzle protein gp25.

Mol	Chain	Residues	Atoms					AltConf	Trace
3	A	263	Total	C	N	O	S	0	0
			2064	1286	364	406	8		
3	B	263	Total	C	N	O	S	0	0
			2064	1286	364	406	8		
3	C	263	Total	C	N	O	S	0	0
			2064	1286	364	406	8		
3	D	263	Total	C	N	O	S	0	0
			2064	1286	364	406	8		
3	E	263	Total	C	N	O	S	0	0
			2064	1286	364	406	8		
3	F	263	Total	C	N	O	S	0	0
			2064	1286	364	406	8		
3	G	263	Total	C	N	O	S	0	0
			2064	1286	364	406	8		
3	H	263	Total	C	N	O	S	0	0
			2064	1286	364	406	8		
3	I	263	Total	C	N	O	S	0	0
			2064	1286	364	406	8		
3	J	263	Total	C	N	O	S	0	0
			2064	1286	364	406	8		

Continued on next page...

Continued from previous page...

Mol	Chain	Residues	Atoms					AltConf	Trace
			Total	C	N	O	S		
3	K	263	Total	C	N	O	S	0	0
			2064	1286	364	406	8		
3	L	263	Total	C	N	O	S	0	0
			2064	1286	364	406	8		

TRP
ARG
LYS
TYR
PRO
SER
ALA
GLN
ASN
LEU
ASP
TYR

• Molecule 1: Portal protein

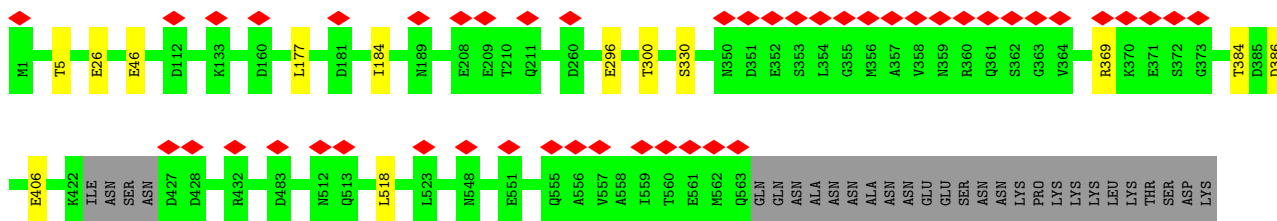

THR
TRP
ARG
LYS
TYR
PRO
SER
ALA
GLN
ASN
LEU
ASP
TYR

• Molecule 1: Portal protein

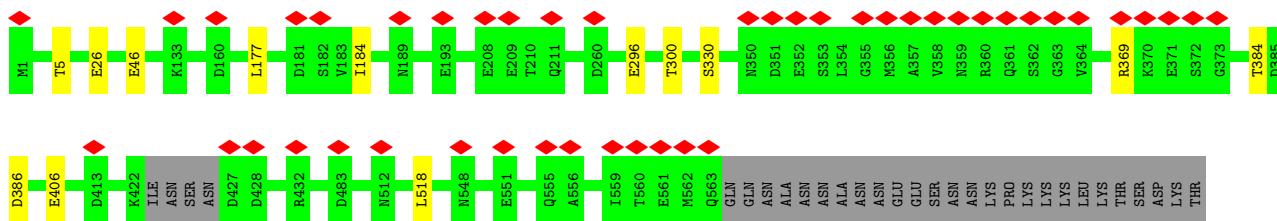

THR
TRP
ARG
LYS
TYR
PRO
SER
ALA
GLN
ASN
LEU
ASP
TYR

• Molecule 1: Portal protein

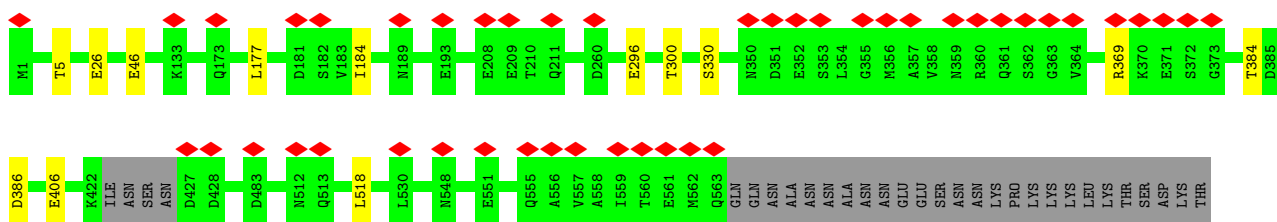
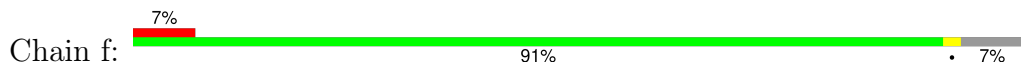

THR
TRP
ARG
LYS
TYR
PRO
SER
ALA
GLN
ASN
LEU
ASP
TYR

• Molecule 1: Portal protein

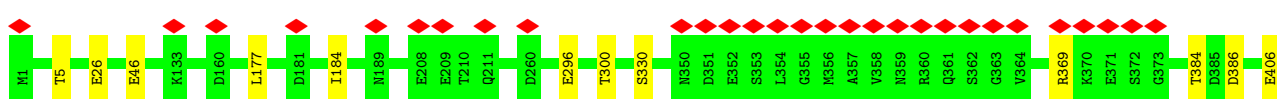
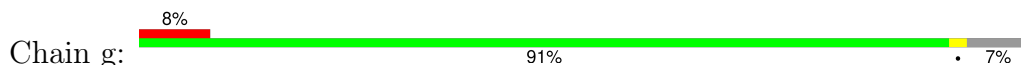

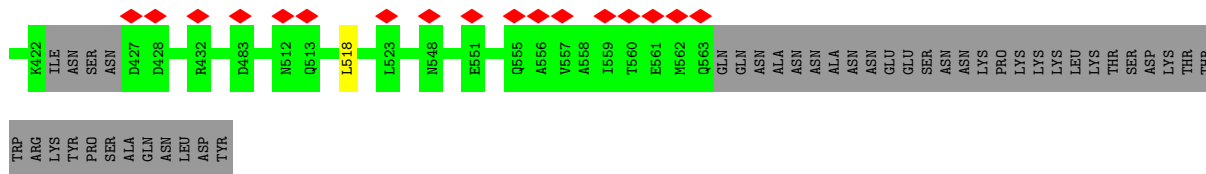

• Molecule 1: Portal protein

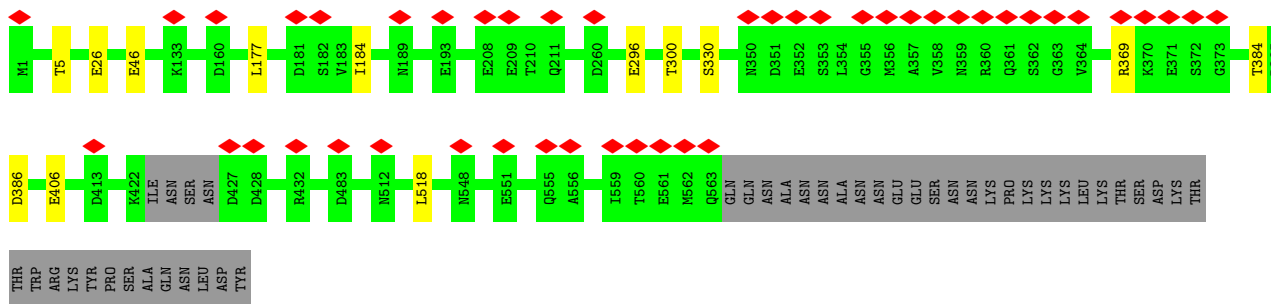
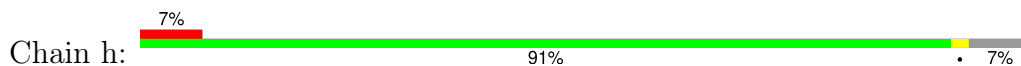

• Molecule 1: Portal protein

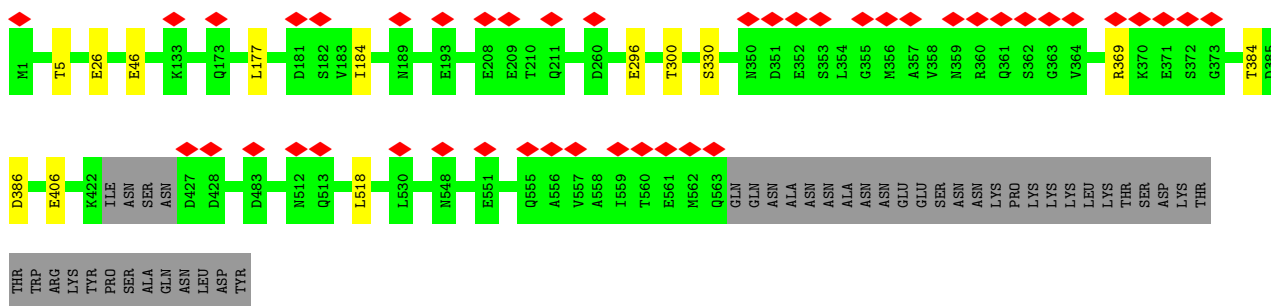
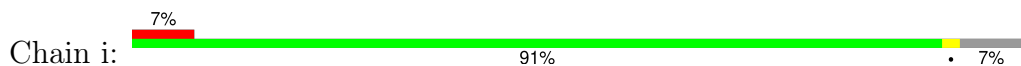

• Molecule 1: Portal protein

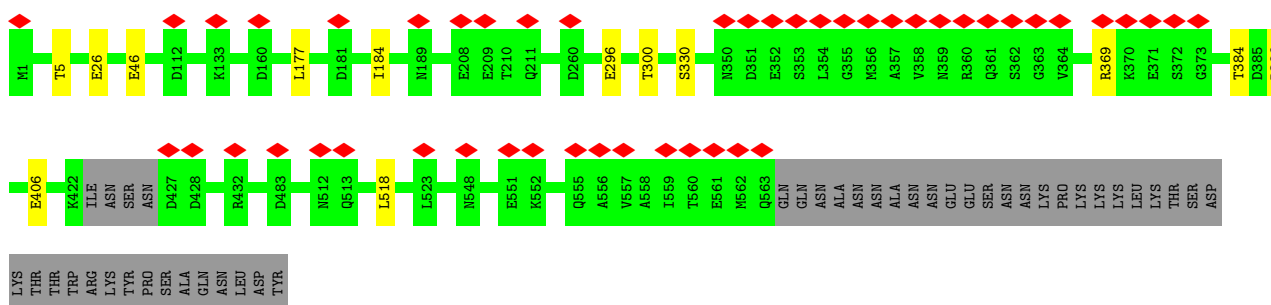
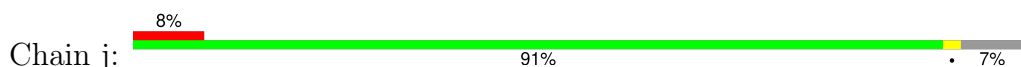

• Molecule 1: Portal protein



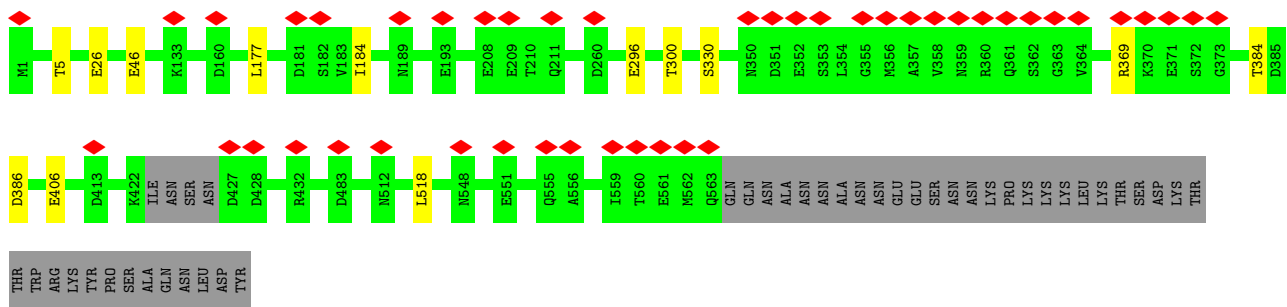

• Molecule 1: Portal protein

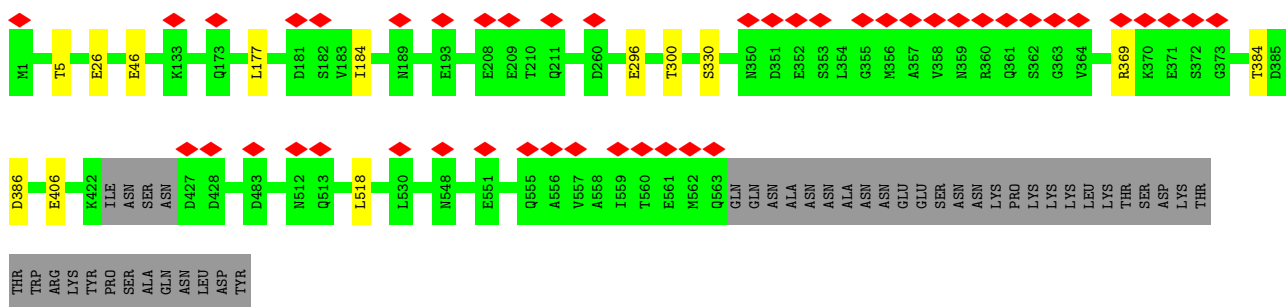
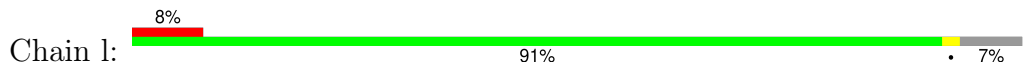

• Molecule 2: Adaptor protein gp12



• Molecule 2: Adaptor protein gp12

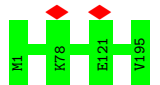

• Molecule 2: Adaptor protein gp12

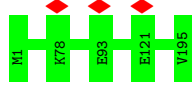

• Molecule 2: Adaptor protein gp12



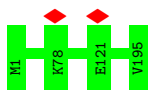

- Molecule 2: Adaptor protein gp12

Chain q: 100%

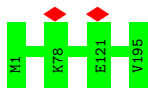

- Molecule 2: Adaptor protein gp12

Chain r: 100%

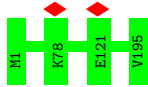

- Molecule 2: Adaptor protein gp12

Chain s: 100%

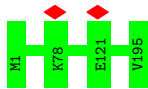

- Molecule 2: Adaptor protein gp12

Chain t: 100%

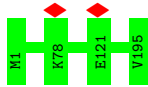

- Molecule 2: Adaptor protein gp12

Chain u: 100%

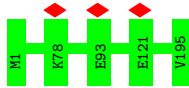

- Molecule 2: Adaptor protein gp12

Chain v: 100%

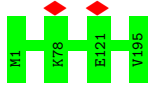

- Molecule 2: Adaptor protein gp12

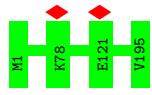

• Molecule 2: Adaptor protein gp12

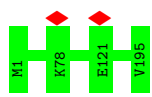

• Molecule 3: Nozzle protein gp25

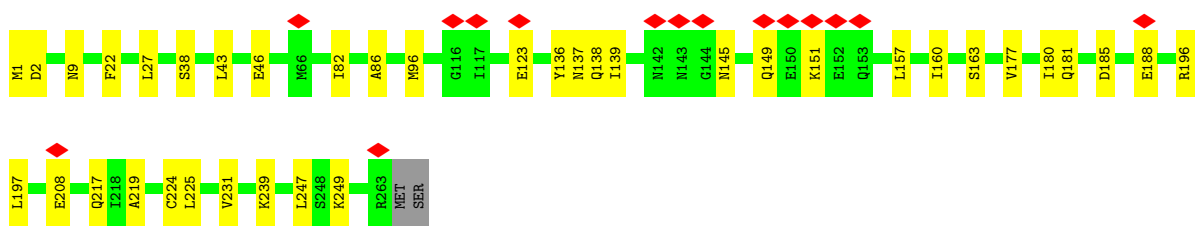
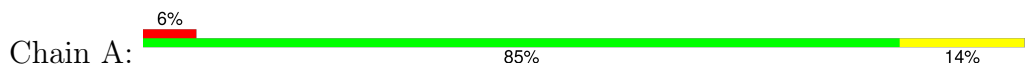

• Molecule 3: Nozzle protein gp25

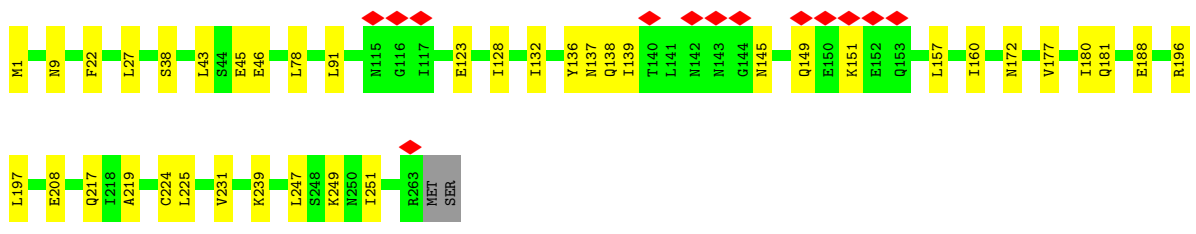
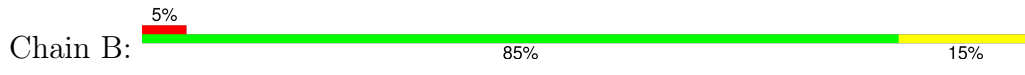

• Molecule 3: Nozzle protein gp25

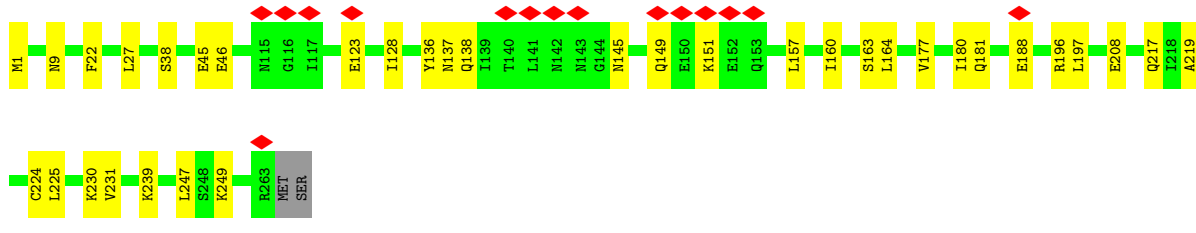
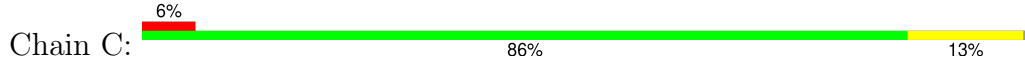

• Molecule 3: Nozzle protein gp25

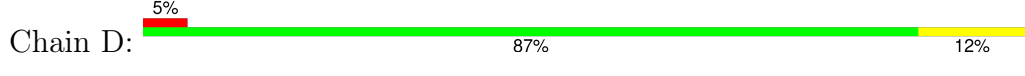

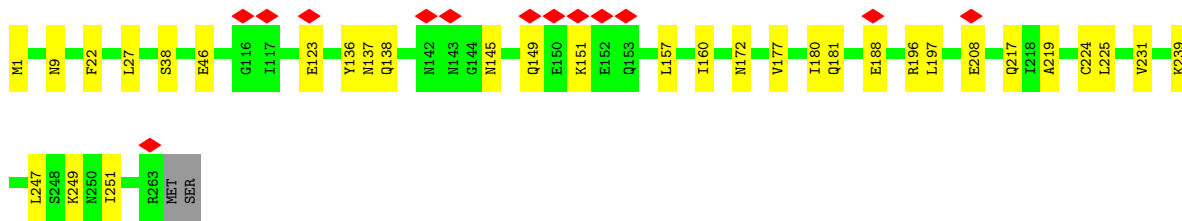

• Molecule 3: Nozzle protein gp25

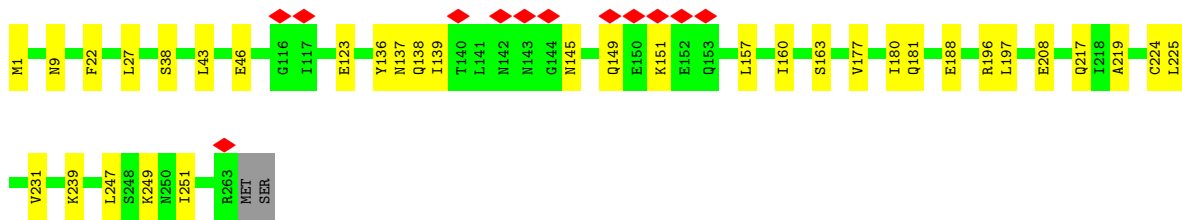
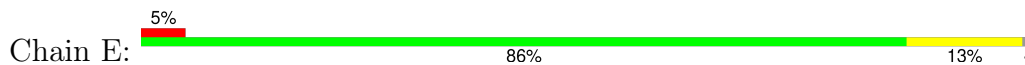

• Molecule 3: Nozzle protein gp25

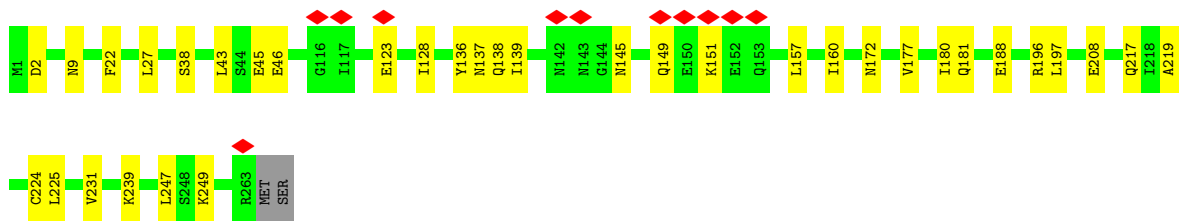
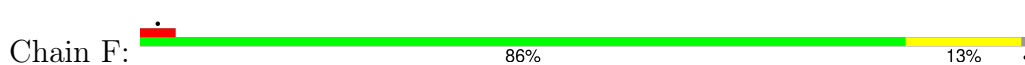

• Molecule 3: Nozzle protein gp25

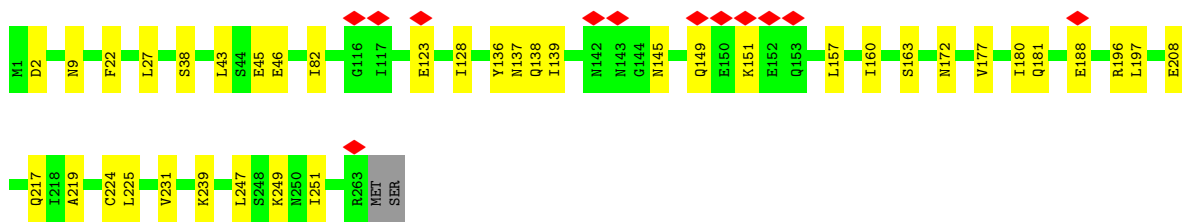
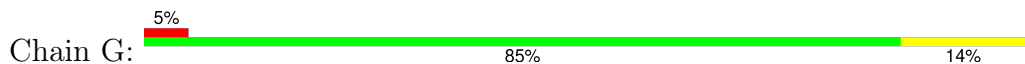

• Molecule 3: Nozzle protein gp25

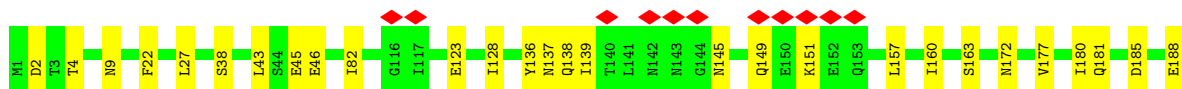
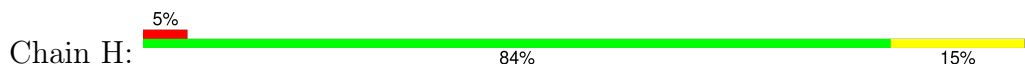



• Molecule 3: Nozzle protein gp25

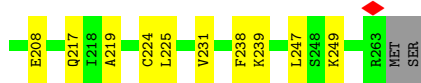
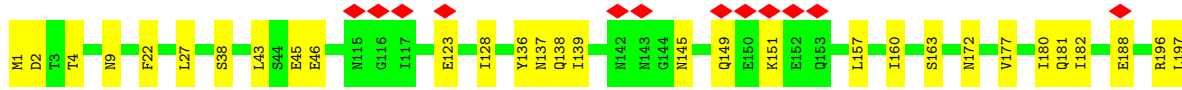
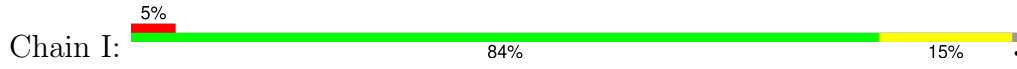

• Molecule 3: Nozzle protein gp25

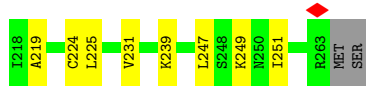
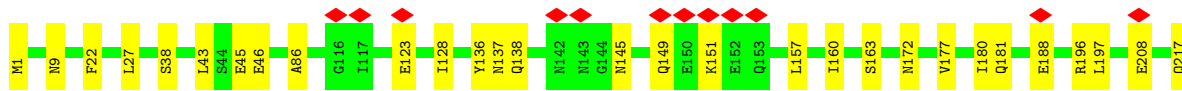
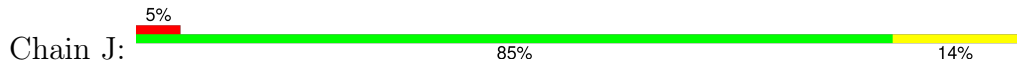

• Molecule 3: Nozzle protein gp25

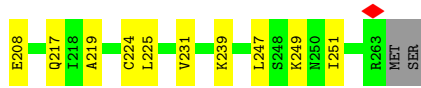
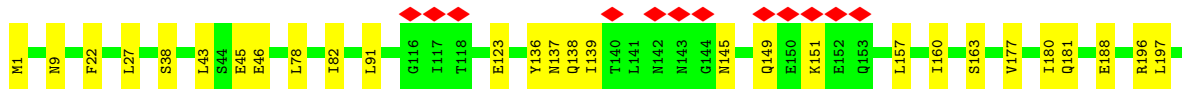
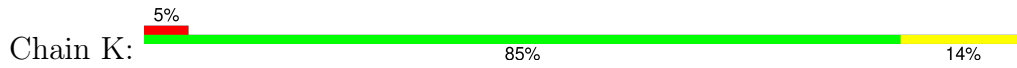

• Molecule 3: Nozzle protein gp25

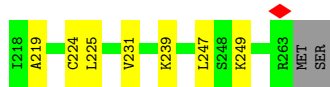
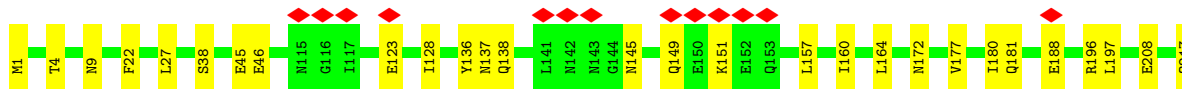
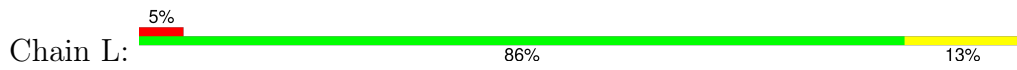

4 Experimental information

Property	Value	Source
EM reconstruction method	SINGLE PARTICLE	Depositor
Imposed symmetry	POINT, C12	Depositor
Number of particles used	27422	Depositor
Resolution determination method	FSC 0.143 CUT-OFF	Depositor
CTF correction method	PHASE FLIPPING AND AMPLITUDE CORRECTION	Depositor
Microscope	FEI TITAN KRIOS	Depositor
Voltage (kV)	300	Depositor
Electron dose ($e^-/\text{\AA}^2$)	50	Depositor
Minimum defocus (nm)	1000	Depositor
Maximum defocus (nm)	2500	Depositor
Magnification	Not provided	
Image detector	FEI FALCON III (4k x 4k)	Depositor
Maximum map value	0.172	Depositor
Minimum map value	-0.105	Depositor
Average map value	0.000	Depositor
Map value standard deviation	0.004	Depositor
Recommended contour level	0.03	Depositor
Map size (Å)	639.41205, 639.41205, 639.41205	wwPDB
Map dimensions	400, 400, 400	wwPDB
Map angles (°)	90.0, 90.0, 90.0	wwPDB
Pixel spacing (Å)	1.5985302, 1.5985302, 1.5985302	Depositor

5 Model quality [i](#)

5.1 Standard geometry [i](#)

The Z score for a bond length (or angle) is the number of standard deviations the observed value is removed from the expected value. A bond length (or angle) with $|Z| > 5$ is considered an outlier worth inspection. RMSZ is the root-mean-square of all Z scores of the bond lengths (or angles).

Mol	Chain	Bond lengths		Bond angles	
		RMSZ	# Z >5	RMSZ	# Z >5
1	a	0.31	0/4606	0.52	0/6211
1	b	0.31	0/4606	0.52	0/6211
1	c	0.31	0/4606	0.52	0/6211
1	d	0.31	0/4606	0.52	0/6211
1	e	0.31	0/4606	0.52	0/6211
1	f	0.31	0/4606	0.52	0/6211
1	g	0.31	0/4606	0.52	0/6211
1	h	0.31	0/4606	0.52	0/6211
1	i	0.31	0/4606	0.52	0/6211
1	j	0.31	0/4606	0.52	0/6211
1	k	0.31	0/4606	0.52	0/6211
1	l	0.31	0/4606	0.52	0/6211
2	m	0.39	0/1602	0.52	0/2164
2	n	0.39	0/1602	0.52	0/2164
2	o	0.39	0/1602	0.52	0/2164
2	p	0.39	0/1602	0.52	0/2164
2	q	0.39	0/1602	0.52	0/2164
2	r	0.39	0/1602	0.52	0/2164
2	s	0.39	0/1602	0.52	0/2164
2	t	0.39	0/1602	0.52	0/2164
2	u	0.39	0/1602	0.52	0/2164
2	v	0.39	0/1602	0.52	0/2164
2	w	0.39	0/1602	0.52	0/2164
2	x	0.39	0/1602	0.52	0/2164
3	A	0.27	0/2082	0.46	0/2799
3	B	0.27	0/2082	0.46	0/2799
3	C	0.27	0/2082	0.46	0/2799
3	D	0.27	0/2082	0.46	0/2799
3	E	0.27	0/2082	0.46	0/2799
3	F	0.27	0/2082	0.46	0/2799
3	G	0.27	0/2082	0.46	0/2799
3	H	0.27	0/2082	0.46	0/2799
3	I	0.27	0/2082	0.46	0/2799
3	J	0.27	0/2082	0.46	0/2799

Mol	Chain	Bond lengths		Bond angles	
		RMSZ	# Z >5	RMSZ	# Z >5
3	K	0.27	0/2082	0.46	0/2799
3	L	0.27	0/2082	0.46	0/2799
All	All	0.32	0/99480	0.50	0/134088

There are no bond length outliers.

There are no bond angle outliers.

There are no chirality outliers.

There are no planarity outliers.

5.2 Too-close contacts [i](#)

In the following table, the Non-H and H(model) columns list the number of non-hydrogen atoms and hydrogen atoms in the chain respectively. The H(added) column lists the number of hydrogen atoms added and optimized by MolProbity. The Clashes column lists the number of clashes within the asymmetric unit, whereas Symm-Clashes lists symmetry-related clashes.

Mol	Chain	Non-H	H(model)	H(added)	Clashes	Symm-Clashes
1	a	4532	0	4522	0	0
1	b	4532	0	4522	0	0
1	c	4532	0	4522	0	0
1	d	4532	0	4522	0	0
1	e	4532	0	4522	0	0
1	f	4532	0	4522	0	0
1	g	4532	0	4522	0	0
1	h	4532	0	4522	0	0
1	i	4532	0	4522	0	0
1	j	4532	0	4522	0	0
1	k	4532	0	4522	0	0
1	l	4532	0	4522	0	0
2	m	1586	0	1670	0	0
2	n	1586	0	1670	0	0
2	o	1586	0	1670	0	0
2	p	1586	0	1670	0	0
2	q	1586	0	1670	0	0
2	r	1586	0	1670	0	0
2	s	1586	0	1670	0	0
2	t	1586	0	1670	0	0
2	u	1586	0	1670	0	0
2	v	1586	0	1670	0	0
2	w	1586	0	1670	0	0

Continued on next page...

Continued from previous page...

Mol	Chain	Non-H	H(model)	H(added)	Clashes	Symm-Clashes
2	x	1586	0	1670	0	0
3	A	2064	0	2107	29	0
3	B	2064	0	2107	32	0
3	C	2064	0	2107	26	0
3	D	2064	0	2107	23	0
3	E	2064	0	2107	25	0
3	F	2064	0	2107	27	0
3	G	2064	0	2107	29	0
3	H	2064	0	2107	31	0
3	I	2064	0	2107	31	0
3	J	2064	0	2107	29	0
3	K	2064	0	2107	31	0
3	L	2064	0	2107	26	0
All	All	98184	0	99588	258	0

The all-atom clashscore is defined as the number of clashes found per 1000 atoms (including hydrogen atoms). The all-atom clashscore for this structure is 7.

All (258) close contacts within the same asymmetric unit are listed below, sorted by their clash magnitude.

Atom-1	Atom-2	Interatomic distance (Å)	Clash overlap (Å)
3:A:208:GLU:HA	3:A:239:LYS:O	2.02	0.59
3:G:208:GLU:HA	3:G:239:LYS:O	2.02	0.59
3:L:208:GLU:HA	3:L:239:LYS:O	2.02	0.59
3:H:208:GLU:HA	3:H:239:LYS:O	2.02	0.59
3:C:208:GLU:HA	3:C:239:LYS:O	2.02	0.59
3:F:208:GLU:HA	3:F:239:LYS:O	2.02	0.59
3:B:208:GLU:HA	3:B:239:LYS:O	2.02	0.59
3:E:208:GLU:HA	3:E:239:LYS:O	2.02	0.58
3:J:208:GLU:HA	3:J:239:LYS:O	2.02	0.58
3:K:208:GLU:HA	3:K:239:LYS:O	2.02	0.58
3:I:208:GLU:HA	3:I:239:LYS:O	2.02	0.57
3:D:208:GLU:HA	3:D:239:LYS:O	2.02	0.57
3:D:46:GLU:OE1	3:E:196:ARG:NH2	2.41	0.54
3:A:46:GLU:OE1	3:B:196:ARG:NH2	2.42	0.52
3:I:46:GLU:OE1	3:J:196:ARG:NH2	2.43	0.52
3:A:196:ARG:NH2	3:L:46:GLU:OE1	2.42	0.52
3:B:217:GLN:NE2	3:B:219:ALA:O	2.43	0.52
3:H:217:GLN:NE2	3:H:219:ALA:O	2.43	0.52
3:I:217:GLN:NE2	3:I:219:ALA:O	2.43	0.52
3:K:217:GLN:NE2	3:K:219:ALA:O	2.43	0.52

Continued on next page...

Continued from previous page...

Atom-1	Atom-2	Interatomic distance (Å)	Clash overlap (Å)
3:C:217:GLN:NE2	3:C:219:ALA:O	2.43	0.52
3:G:46:GLU:OE1	3:H:196:ARG:NH2	2.42	0.52
3:L:217:GLN:NE2	3:L:219:ALA:O	2.43	0.52
3:J:138:GLN:HE22	3:J:151:LYS:HD3	1.75	0.51
3:A:138:GLN:HE22	3:A:151:LYS:HD3	1.76	0.51
3:E:225:LEU:HD21	3:F:188:GLU:HG2	1.92	0.51
3:G:217:GLN:NE2	3:G:219:ALA:O	2.43	0.51
3:E:217:GLN:NE2	3:E:219:ALA:O	2.43	0.51
3:J:217:GLN:NE2	3:J:219:ALA:O	2.43	0.51
3:D:217:GLN:NE2	3:D:219:ALA:O	2.43	0.51
3:F:217:GLN:NE2	3:F:219:ALA:O	2.43	0.51
3:G:181:GLN:OE1	3:G:249:LYS:NZ	2.44	0.51
3:L:138:GLN:HE22	3:L:151:LYS:HD3	1.75	0.51
3:J:1:MET:SD	3:J:1:MET:N	4.77	0.51
3:J:46:GLU:OE1	3:K:196:ARG:NH2	2.43	0.51
3:A:217:GLN:NE2	3:A:219:ALA:O	2.43	0.51
3:F:181:GLN:OE1	3:F:249:LYS:NZ	2.44	0.51
3:H:181:GLN:OE1	3:H:249:LYS:NZ	2.44	0.51
3:C:138:GLN:HE22	3:C:151:LYS:HD3	1.76	0.50
3:D:181:GLN:OE1	3:D:249:LYS:NZ	2.44	0.50
3:E:181:GLN:OE1	3:E:249:LYS:NZ	2.44	0.50
3:I:138:GLN:HE22	3:I:151:LYS:HD3	1.76	0.50
3:D:138:GLN:HE22	3:D:151:LYS:HD3	1.76	0.50
3:F:145:ASN:ND2	3:G:123:GLU:OE2	2.45	0.50
3:E:138:GLN:HE22	3:E:151:LYS:HD3	1.76	0.50
3:F:46:GLU:OE1	3:G:196:ARG:NH2	2.45	0.50
3:H:46:GLU:OE1	3:I:196:ARG:NH2	2.44	0.50
3:L:181:GLN:OE1	3:L:249:LYS:NZ	2.44	0.50
3:A:181:GLN:OE1	3:A:249:LYS:NZ	2.44	0.50
3:C:181:GLN:OE1	3:C:249:LYS:NZ	2.44	0.50
3:E:1:MET:SD	3:E:1:MET:N	4.77	0.50
3:I:1:MET:SD	3:I:1:MET:N	4.77	0.50
3:K:1:MET:SD	3:K:1:MET:N	4.77	0.50
3:I:181:GLN:OE1	3:I:249:LYS:NZ	2.44	0.50
3:F:138:GLN:HE22	3:F:151:LYS:HD3	1.76	0.50
3:H:138:GLN:HE22	3:H:151:LYS:HD3	1.75	0.50
3:B:181:GLN:OE1	3:B:249:LYS:NZ	2.44	0.50
3:B:225:LEU:HD21	3:C:188:GLU:HG2	1.93	0.50
3:D:46:GLU:OE2	3:E:196:ARG:NH1	2.44	0.50
3:G:46:GLU:OE2	3:H:196:ARG:NH1	2.45	0.50
3:G:138:GLN:HE22	3:G:151:LYS:HD3	1.76	0.50

Continued on next page...

Continued from previous page...

Atom-1	Atom-2	Interatomic distance (Å)	Clash overlap (Å)
3:K:138:GLN:HE22	3:K:151:LYS:HD3	1.76	0.50
3:K:181:GLN:OE1	3:K:249:LYS:NZ	2.44	0.50
3:A:196:ARG:NH1	3:L:46:GLU:OE2	2.45	0.50
3:K:225:LEU:HD21	3:L:188:GLU:HG2	1.94	0.50
3:B:138:GLN:HE22	3:B:151:LYS:HD3	1.76	0.49
3:J:181:GLN:OE1	3:J:249:LYS:NZ	2.44	0.49
3:A:46:GLU:OE2	3:B:196:ARG:NH1	2.44	0.49
3:B:46:GLU:OE1	3:C:196:ARG:NH2	2.45	0.49
3:J:9:ASN:ND2	3:J:38:SER:OG	2.46	0.49
3:I:9:ASN:ND2	3:I:38:SER:OG	2.46	0.49
3:J:46:GLU:OE2	3:K:196:ARG:NH1	2.46	0.49
3:E:46:GLU:OE1	3:F:196:ARG:NH2	2.46	0.49
3:I:46:GLU:OE2	3:J:196:ARG:NH1	2.45	0.49
3:K:9:ASN:ND2	3:K:38:SER:OG	2.46	0.49
3:H:9:ASN:ND2	3:H:38:SER:OG	2.46	0.48
3:F:225:LEU:HD21	3:G:188:GLU:HG2	1.96	0.48
3:H:225:LEU:HD21	3:I:188:GLU:HG2	1.96	0.48
3:L:9:ASN:ND2	3:L:38:SER:OG	2.46	0.48
3:B:145:ASN:ND2	3:C:123:GLU:OE2	2.46	0.48
3:C:225:LEU:HD21	3:D:188:GLU:HG2	1.95	0.48
3:D:1:MET:SD	3:D:1:MET:N	4.77	0.48
3:A:9:ASN:ND2	3:A:38:SER:OG	2.46	0.48
3:B:9:ASN:ND2	3:B:38:SER:OG	2.46	0.48
3:K:46:GLU:OE1	3:L:196:ARG:NH2	2.46	0.48
3:D:9:ASN:ND2	3:D:38:SER:OG	2.46	0.48
3:F:138:GLN:O	3:F:149:GLN:NE2	2.47	0.48
3:I:138:GLN:O	3:I:149:GLN:NE2	2.47	0.48
3:C:9:ASN:ND2	3:C:38:SER:OG	2.46	0.48
3:E:9:ASN:ND2	3:E:38:SER:OG	2.46	0.48
3:G:138:GLN:O	3:G:149:GLN:NE2	2.47	0.48
3:J:138:GLN:O	3:J:149:GLN:NE2	2.47	0.48
3:H:138:GLN:O	3:H:149:GLN:NE2	2.47	0.48
3:K:138:GLN:O	3:K:149:GLN:NE2	2.47	0.48
3:B:138:GLN:O	3:B:149:GLN:NE2	2.47	0.48
3:G:9:ASN:ND2	3:G:38:SER:OG	2.46	0.48
3:H:46:GLU:OE2	3:I:196:ARG:NH1	2.47	0.48
3:B:180:ILE:HG23	3:B:247:LEU:HD22	1.96	0.47
3:C:138:GLN:O	3:C:149:GLN:NE2	2.47	0.47
3:A:138:GLN:O	3:A:149:GLN:NE2	2.47	0.47
3:C:180:ILE:HG23	3:C:247:LEU:HD22	1.97	0.47
3:E:138:GLN:O	3:E:149:GLN:NE2	2.47	0.47

Continued on next page...

Continued from previous page...

Atom-1	Atom-2	Interatomic distance (Å)	Clash overlap (Å)
3:A:123:GLU:OE2	3:L:145:ASN:ND2	2.47	0.47
3:A:180:ILE:HG23	3:A:247:LEU:HD22	1.96	0.47
3:D:180:ILE:HG23	3:D:247:LEU:HD22	1.97	0.47
3:F:9:ASN:ND2	3:F:38:SER:OG	2.46	0.47
3:L:138:GLN:O	3:L:149:GLN:NE2	2.47	0.47
3:B:46:GLU:OE2	3:C:196:ARG:NH1	2.48	0.47
3:D:138:GLN:O	3:D:149:GLN:NE2	2.47	0.47
3:F:46:GLU:OE2	3:G:196:ARG:NH1	2.47	0.47
3:L:180:ILE:HG23	3:L:247:LEU:HD22	1.96	0.47
3:J:225:LEU:HD21	3:K:188:GLU:HG2	1.97	0.47
3:A:1:MET:SD	3:A:1:MET:N	4.77	0.47
3:G:145:ASN:ND2	3:H:123:GLU:OE2	2.48	0.47
3:H:180:ILE:HG23	3:H:247:LEU:HD22	1.96	0.47
3:I:180:ILE:HG23	3:I:247:LEU:HD22	1.96	0.47
3:J:145:ASN:ND2	3:K:123:GLU:OE2	2.46	0.47
3:C:46:GLU:OE1	3:D:196:ARG:NH2	2.48	0.47
3:E:180:ILE:HG23	3:E:247:LEU:HD22	1.96	0.47
3:L:1:MET:SD	3:L:1:MET:N	4.77	0.47
3:G:225:LEU:HD21	3:H:188:GLU:HG2	1.98	0.46
3:H:145:ASN:ND2	3:I:123:GLU:OE2	2.48	0.46
3:K:46:GLU:OE2	3:L:196:ARG:NH1	2.48	0.46
3:E:46:GLU:OE2	3:F:196:ARG:NH1	2.48	0.46
3:G:180:ILE:HG23	3:G:247:LEU:HD22	1.97	0.46
3:A:145:ASN:ND2	3:B:123:GLU:OE2	2.48	0.46
3:A:225:LEU:HD21	3:B:188:GLU:HG2	1.97	0.46
3:J:180:ILE:HG23	3:J:247:LEU:HD22	1.96	0.46
3:K:180:ILE:HG23	3:K:247:LEU:HD22	1.97	0.46
3:I:136:TYR:O	3:I:151:LYS:NZ	2.49	0.46
3:J:136:TYR:O	3:J:151:LYS:NZ	2.49	0.46
3:H:136:TYR:O	3:H:151:LYS:NZ	2.49	0.46
3:K:136:TYR:O	3:K:151:LYS:NZ	2.49	0.46
3:G:136:TYR:O	3:G:151:LYS:NZ	2.49	0.46
3:D:136:TYR:O	3:D:151:LYS:NZ	2.48	0.46
3:I:145:ASN:ND2	3:J:123:GLU:OE2	2.48	0.46
3:A:139:ILE:HG12	3:B:128:ILE:HD11	1.98	0.46
3:B:139:ILE:HG12	3:C:128:ILE:HD11	1.98	0.46
3:E:145:ASN:ND2	3:F:123:GLU:OE2	2.49	0.46
3:F:136:TYR:O	3:F:151:LYS:NZ	2.49	0.46
3:C:1:MET:SD	3:C:1:MET:N	4.77	0.46
3:C:136:TYR:O	3:C:151:LYS:NZ	2.49	0.46
3:I:225:LEU:HD21	3:J:188:GLU:HG2	1.98	0.46

Continued on next page...

Continued from previous page...

Atom-1	Atom-2	Interatomic distance (Å)	Clash overlap (Å)
3:L:136:TYR:O	3:L:151:LYS:NZ	2.49	0.46
3:B:136:TYR:O	3:B:151:LYS:NZ	2.49	0.45
3:F:180:ILE:HG23	3:F:247:LEU:HD22	1.96	0.45
3:E:136:TYR:O	3:E:151:LYS:NZ	2.49	0.45
3:I:4:THR:HG21	3:K:188:GLU:HB3	1.98	0.45
3:I:157:LEU:HD23	3:I:160:ILE:HD12	1.99	0.45
3:A:163:SER:OG	3:L:172:ASN:ND2	2.50	0.45
3:J:22:PHE:HB3	3:J:27:LEU:HB2	1.99	0.45
3:J:157:LEU:HD23	3:J:160:ILE:HD12	1.99	0.45
3:A:43:LEU:HD12	3:B:45:GLU:HG2	1.97	0.45
3:A:136:TYR:O	3:A:151:LYS:NZ	2.49	0.45
3:E:22:PHE:HB3	3:E:27:LEU:HB2	1.99	0.45
3:F:22:PHE:HB3	3:F:27:LEU:HB2	1.99	0.45
3:G:22:PHE:HB3	3:G:27:LEU:HB2	1.99	0.45
3:H:22:PHE:HB3	3:H:27:LEU:HB2	1.99	0.45
3:H:157:LEU:HD23	3:H:160:ILE:HD12	1.99	0.45
3:I:22:PHE:HB3	3:I:27:LEU:HB2	1.99	0.45
3:K:145:ASN:ND2	3:L:123:GLU:OE2	2.49	0.45
3:C:157:LEU:HD23	3:C:160:ILE:HD12	1.99	0.45
3:K:22:PHE:HB3	3:K:27:LEU:HB2	1.99	0.45
3:B:157:LEU:HD23	3:B:160:ILE:HD12	1.99	0.45
3:D:22:PHE:HB3	3:D:27:LEU:HB2	1.99	0.45
3:G:157:LEU:HD23	3:G:160:ILE:HD12	1.99	0.45
3:A:22:PHE:HB3	3:A:27:LEU:HB2	1.99	0.44
3:B:22:PHE:HB3	3:B:27:LEU:HB2	1.99	0.44
3:K:157:LEU:HD23	3:K:160:ILE:HD12	1.99	0.44
3:L:22:PHE:HB3	3:L:27:LEU:HB2	1.99	0.44
3:A:188:GLU:HG2	3:L:225:LEU:HD21	1.99	0.44
3:C:22:PHE:HB3	3:C:27:LEU:HB2	1.99	0.44
3:D:157:LEU:HD23	3:D:160:ILE:HD12	1.99	0.44
3:K:43:LEU:HD12	3:L:45:GLU:HG2	2.00	0.44
3:C:46:GLU:OE2	3:D:196:ARG:NH1	2.50	0.44
3:F:157:LEU:HD23	3:F:160:ILE:HD12	1.99	0.44
3:I:172:ASN:ND2	3:J:163:SER:OG	2.51	0.44
3:A:157:LEU:HD23	3:A:160:ILE:HD12	1.99	0.44
3:G:251:ILE:HD12	3:G:251:ILE:HA	1.90	0.44
3:E:43:LEU:HD12	3:F:45:GLU:HG2	1.98	0.44
3:H:197:LEU:HB2	3:H:224:CYS:HB3	2.00	0.44
3:I:197:LEU:HB2	3:I:224:CYS:HB3	2.00	0.44
3:K:139:ILE:HG12	3:L:128:ILE:HD11	1.99	0.44
3:B:43:LEU:HD12	3:C:45:GLU:HG2	1.99	0.44

Continued on next page...

Continued from previous page...

Atom-1	Atom-2	Interatomic distance (Å)	Clash overlap (Å)
3:E:157:LEU:HD23	3:E:160:ILE:HD12	1.99	0.44
3:J:172:ASN:ND2	3:K:163:SER:OG	2.51	0.44
3:J:197:LEU:HB2	3:J:224:CYS:HB3	2.00	0.44
3:K:251:ILE:HD12	3:K:251:ILE:HA	1.90	0.44
3:F:172:ASN:ND2	3:G:163:SER:OG	2.51	0.43
3:K:197:LEU:HB2	3:K:224:CYS:HB3	2.00	0.43
3:A:197:LEU:HB2	3:A:224:CYS:HB3	2.00	0.43
3:D:225:LEU:HD21	3:E:188:GLU:HG2	2.00	0.43
3:D:251:ILE:HD12	3:D:251:ILE:HA	1.91	0.43
3:G:197:LEU:HB2	3:G:224:CYS:HB3	2.00	0.43
3:L:197:LEU:HB2	3:L:224:CYS:HB3	2.00	0.43
3:B:197:LEU:HB2	3:B:224:CYS:HB3	2.00	0.43
3:D:145:ASN:ND2	3:E:123:GLU:OE2	2.52	0.43
3:H:4:THR:HG21	3:J:188:GLU:HB3	2.00	0.43
3:H:43:LEU:HD12	3:I:45:GLU:HG2	2.01	0.43
3:L:157:LEU:HD23	3:L:160:ILE:HD12	1.99	0.43
3:G:43:LEU:HD12	3:H:45:GLU:HG2	2.00	0.43
3:K:82:ILE:HD13	3:K:82:ILE:HA	1.92	0.43
3:C:197:LEU:HB2	3:C:224:CYS:HB3	2.00	0.43
3:D:172:ASN:ND2	3:E:163:SER:OG	2.51	0.43
3:F:197:LEU:HB2	3:F:224:CYS:HB3	2.00	0.43
3:I:137:ASN:OD1	3:I:137:ASN:N	2.52	0.43
3:D:197:LEU:HB2	3:D:224:CYS:HB3	2.00	0.43
3:F:137:ASN:OD1	3:F:137:ASN:N	2.52	0.43
3:K:137:ASN:OD1	3:K:137:ASN:N	2.52	0.43
3:B:1:MET:SD	3:B:1:MET:N	4.77	0.42
3:F:139:ILE:HG12	3:G:128:ILE:HD11	2.01	0.42
3:L:137:ASN:OD1	3:L:137:ASN:N	2.52	0.42
3:A:185:ASP:OD2	3:A:196:ARG:NH2	2.45	0.42
3:E:197:LEU:HB2	3:E:224:CYS:HB3	2.00	0.42
3:E:251:ILE:HD12	3:E:251:ILE:HA	1.91	0.42
3:B:78:LEU:HD13	3:C:164:LEU:HD22	2.01	0.42
3:G:137:ASN:OD1	3:G:137:ASN:N	2.52	0.42
3:G:172:ASN:ND2	3:H:163:SER:OG	2.52	0.42
3:H:137:ASN:OD1	3:H:137:ASN:N	2.52	0.42
3:J:43:LEU:HD12	3:K:45:GLU:HG2	2.01	0.42
3:B:137:ASN:OD1	3:B:137:ASN:N	2.52	0.42
3:B:188:GLU:HB3	3:L:4:THR:HG21	2.00	0.42
3:C:145:ASN:ND2	3:D:123:GLU:OE2	2.53	0.42
3:I:43:LEU:HD12	3:J:45:GLU:HG2	2.01	0.42
3:C:137:ASN:OD1	3:C:137:ASN:N	2.52	0.42

Continued on next page...

Continued from previous page...

Atom-1	Atom-2	Interatomic distance (Å)	Clash overlap (Å)
3:D:137:ASN:OD1	3:D:137:ASN:N	2.52	0.42
3:G:139:ILE:HG12	3:H:128:ILE:HD11	2.01	0.42
3:A:137:ASN:OD1	3:A:137:ASN:N	2.52	0.42
3:B:172:ASN:ND2	3:C:163:SER:OG	2.53	0.42
3:B:251:ILE:HD12	3:B:251:ILE:HA	1.91	0.41
3:H:251:ILE:HD12	3:H:251:ILE:HA	1.90	0.41
3:A:82:ILE:HD13	3:A:82:ILE:HA	1.92	0.41
3:E:137:ASN:OD1	3:E:137:ASN:N	2.52	0.41
3:H:139:ILE:HG12	3:I:128:ILE:HD11	2.02	0.41
3:F:43:LEU:HD12	3:G:45:GLU:HG2	2.02	0.41
3:G:82:ILE:HD13	3:G:82:ILE:HA	1.92	0.41
3:J:137:ASN:OD1	3:J:137:ASN:N	2.52	0.41
3:H:172:ASN:ND2	3:I:163:SER:OG	2.53	0.41
3:J:251:ILE:HD12	3:J:251:ILE:HA	1.90	0.41
3:K:239:LYS:HE2	3:K:239:LYS:HB2	1.96	0.41
3:E:139:ILE:HG12	3:F:128:ILE:HD11	2.03	0.41
3:I:139:ILE:HG12	3:J:128:ILE:HD11	2.02	0.41
3:J:86:ALA:HA	3:K:91:LEU:HD11	2.03	0.41
3:K:78:LEU:HD13	3:L:164:LEU:HD22	2.01	0.41
3:A:96:MET:HB3	3:B:132:ILE:HD13	2.02	0.41
3:B:91:LEU:HD23	3:B:91:LEU:HA	2.12	0.41
3:A:2:ASP:N	3:A:2:ASP:OD1	4.31	0.40
3:H:185:ASP:OD2	3:H:196:ARG:NH2	2.45	0.40
3:C:230:LYS:HE3	3:C:230:LYS:HB3	1.95	0.40
3:I:2:ASP:N	3:I:2:ASP:OD1	4.31	0.40
3:F:2:ASP:OD1	3:F:2:ASP:N	4.31	0.40
3:G:2:ASP:OD1	3:G:2:ASP:N	4.31	0.40
3:H:2:ASP:OD1	3:H:2:ASP:N	4.31	0.40
3:I:182:ILE:HD12	3:I:238:PHE:HB2	2.04	0.40
3:A:86:ALA:HA	3:B:91:LEU:HD11	2.04	0.40
3:F:239:LYS:HE2	3:F:239:LYS:HB2	1.96	0.40
3:H:82:ILE:HD13	3:H:82:ILE:HA	1.92	0.40
3:I:239:LYS:HE2	3:I:239:LYS:HB2	1.96	0.40

There are no symmetry-related clashes.

5.3 Torsion angles

5.3.1 Protein backbone

In the following table, the Percentiles column shows the percent Ramachandran outliers of the chain as a percentile score with respect to all PDB entries followed by that with respect to all EM entries.

The Analysed column shows the number of residues for which the backbone conformation was analysed, and the total number of residues.

Mol	Chain	Analysed	Favoured	Allowed	Outliers	Percentiles	
1	a	555/602 (92%)	519 (94%)	36 (6%)	0	100	100
1	b	555/602 (92%)	519 (94%)	36 (6%)	0	100	100
1	c	555/602 (92%)	519 (94%)	36 (6%)	0	100	100
1	d	555/602 (92%)	519 (94%)	36 (6%)	0	100	100
1	e	555/602 (92%)	519 (94%)	36 (6%)	0	100	100
1	f	555/602 (92%)	520 (94%)	35 (6%)	0	100	100
1	g	555/602 (92%)	519 (94%)	36 (6%)	0	100	100
1	h	555/602 (92%)	520 (94%)	35 (6%)	0	100	100
1	i	555/602 (92%)	519 (94%)	36 (6%)	0	100	100
1	j	555/602 (92%)	519 (94%)	36 (6%)	0	100	100
1	k	555/602 (92%)	519 (94%)	36 (6%)	0	100	100
1	l	555/602 (92%)	519 (94%)	36 (6%)	0	100	100
2	m	193/195 (99%)	177 (92%)	16 (8%)	0	100	100
2	n	193/195 (99%)	177 (92%)	16 (8%)	0	100	100
2	o	193/195 (99%)	177 (92%)	16 (8%)	0	100	100
2	p	193/195 (99%)	177 (92%)	16 (8%)	0	100	100
2	q	193/195 (99%)	177 (92%)	16 (8%)	0	100	100
2	r	193/195 (99%)	177 (92%)	16 (8%)	0	100	100
2	s	193/195 (99%)	177 (92%)	16 (8%)	0	100	100
2	t	193/195 (99%)	177 (92%)	16 (8%)	0	100	100
2	u	193/195 (99%)	177 (92%)	16 (8%)	0	100	100
2	v	193/195 (99%)	177 (92%)	16 (8%)	0	100	100
2	w	193/195 (99%)	177 (92%)	16 (8%)	0	100	100
2	x	193/195 (99%)	177 (92%)	16 (8%)	0	100	100
3	A	261/265 (98%)	238 (91%)	23 (9%)	0	100	100

Continued on next page...

Continued from previous page...

Mol	Chain	Analysed	Favoured	Allowed	Outliers	Percentiles	
3	B	261/265 (98%)	238 (91%)	23 (9%)	0	100	100
3	C	261/265 (98%)	237 (91%)	24 (9%)	0	100	100
3	D	261/265 (98%)	238 (91%)	23 (9%)	0	100	100
3	E	261/265 (98%)	238 (91%)	23 (9%)	0	100	100
3	F	261/265 (98%)	238 (91%)	23 (9%)	0	100	100
3	G	261/265 (98%)	237 (91%)	24 (9%)	0	100	100
3	H	261/265 (98%)	238 (91%)	23 (9%)	0	100	100
3	I	261/265 (98%)	238 (91%)	23 (9%)	0	100	100
3	J	261/265 (98%)	238 (91%)	23 (9%)	0	100	100
3	K	261/265 (98%)	238 (91%)	23 (9%)	0	100	100
3	L	261/265 (98%)	238 (91%)	23 (9%)	0	100	100
All	All	12108/12744 (95%)	11208 (93%)	900 (7%)	0	100	100

There are no Ramachandran outliers to report.

5.3.2 Protein sidechains [i](#)

In the following table, the Percentiles column shows the percent sidechain outliers of the chain as a percentile score with respect to all PDB entries followed by that with respect to all EM entries.

The Analysed column shows the number of residues for which the sidechain conformation was analysed, and the total number of residues.

Mol	Chain	Analysed	Rotameric	Outliers	Percentiles	
1	a	496/539 (92%)	483 (97%)	13 (3%)	41	65
1	b	496/539 (92%)	483 (97%)	13 (3%)	41	65
1	c	496/539 (92%)	483 (97%)	13 (3%)	41	65
1	d	496/539 (92%)	483 (97%)	13 (3%)	41	65
1	e	496/539 (92%)	483 (97%)	13 (3%)	41	65
1	f	496/539 (92%)	483 (97%)	13 (3%)	41	65
1	g	496/539 (92%)	483 (97%)	13 (3%)	41	65
1	h	496/539 (92%)	483 (97%)	13 (3%)	41	65
1	i	496/539 (92%)	483 (97%)	13 (3%)	41	65
1	j	496/539 (92%)	483 (97%)	13 (3%)	41	65

Continued on next page...

Continued from previous page...

Mol	Chain	Analysed	Rotameric	Outliers	Percentiles	
1	k	496/539 (92%)	483 (97%)	13 (3%)	41	65
1	l	496/539 (92%)	483 (97%)	13 (3%)	41	65
2	m	186/186 (100%)	186 (100%)	0	100	100
2	n	186/186 (100%)	186 (100%)	0	100	100
2	o	186/186 (100%)	186 (100%)	0	100	100
2	p	186/186 (100%)	186 (100%)	0	100	100
2	q	186/186 (100%)	186 (100%)	0	100	100
2	r	186/186 (100%)	186 (100%)	0	100	100
2	s	186/186 (100%)	186 (100%)	0	100	100
2	t	186/186 (100%)	186 (100%)	0	100	100
2	u	186/186 (100%)	186 (100%)	0	100	100
2	v	186/186 (100%)	186 (100%)	0	100	100
2	w	186/186 (100%)	186 (100%)	0	100	100
2	x	186/186 (100%)	186 (100%)	0	100	100
3	A	230/233 (99%)	228 (99%)	2 (1%)	75	87
3	B	230/233 (99%)	228 (99%)	2 (1%)	75	87
3	C	230/233 (99%)	228 (99%)	2 (1%)	75	87
3	D	230/233 (99%)	228 (99%)	2 (1%)	75	87
3	E	230/233 (99%)	228 (99%)	2 (1%)	75	87
3	F	230/233 (99%)	228 (99%)	2 (1%)	75	87
3	G	230/233 (99%)	228 (99%)	2 (1%)	75	87
3	H	230/233 (99%)	228 (99%)	2 (1%)	75	87
3	I	230/233 (99%)	228 (99%)	2 (1%)	75	87
3	J	230/233 (99%)	228 (99%)	2 (1%)	75	87
3	K	230/233 (99%)	228 (99%)	2 (1%)	75	87
3	L	230/233 (99%)	228 (99%)	2 (1%)	75	87
All	All	10944/11496 (95%)	10764 (98%)	180 (2%)	58	76

All (180) residues with a non-rotameric sidechain are listed below:

Mol	Chain	Res	Type
1	a	5	THR
1	a	26	GLU

Continued on next page...

Continued from previous page...

Mol	Chain	Res	Type
1	a	46	GLU
1	a	177	LEU
1	a	184	ILE
1	a	296	GLU
1	a	300	THR
1	a	330	SER
1	a	369	ARG
1	a	384	THR
1	a	386	ASP
1	a	406	GLU
1	a	518	LEU
1	b	5	THR
1	b	26	GLU
1	b	46	GLU
1	b	177	LEU
1	b	184	ILE
1	b	296	GLU
1	b	300	THR
1	b	330	SER
1	b	369	ARG
1	b	384	THR
1	b	386	ASP
1	b	406	GLU
1	b	518	LEU
1	c	5	THR
1	c	26	GLU
1	c	46	GLU
1	c	177	LEU
1	c	184	ILE
1	c	296	GLU
1	c	300	THR
1	c	330	SER
1	c	369	ARG
1	c	384	THR
1	c	386	ASP
1	c	406	GLU
1	c	518	LEU
1	d	5	THR
1	d	26	GLU
1	d	46	GLU
1	d	177	LEU
1	d	184	ILE

Continued on next page...

Continued from previous page...

Mol	Chain	Res	Type
1	d	296	GLU
1	d	300	THR
1	d	330	SER
1	d	369	ARG
1	d	384	THR
1	d	386	ASP
1	d	406	GLU
1	d	518	LEU
1	e	5	THR
1	e	26	GLU
1	e	46	GLU
1	e	177	LEU
1	e	184	ILE
1	e	296	GLU
1	e	300	THR
1	e	330	SER
1	e	369	ARG
1	e	384	THR
1	e	386	ASP
1	e	406	GLU
1	e	518	LEU
1	f	5	THR
1	f	26	GLU
1	f	46	GLU
1	f	177	LEU
1	f	184	ILE
1	f	296	GLU
1	f	300	THR
1	f	330	SER
1	f	369	ARG
1	f	384	THR
1	f	386	ASP
1	f	406	GLU
1	f	518	LEU
1	g	5	THR
1	g	26	GLU
1	g	46	GLU
1	g	177	LEU
1	g	184	ILE
1	g	296	GLU
1	g	300	THR
1	g	330	SER

Continued on next page...

Continued from previous page...

Mol	Chain	Res	Type
1	g	369	ARG
1	g	384	THR
1	g	386	ASP
1	g	406	GLU
1	g	518	LEU
1	h	5	THR
1	h	26	GLU
1	h	46	GLU
1	h	177	LEU
1	h	184	ILE
1	h	296	GLU
1	h	300	THR
1	h	330	SER
1	h	369	ARG
1	h	384	THR
1	h	386	ASP
1	h	406	GLU
1	h	518	LEU
1	i	5	THR
1	i	26	GLU
1	i	46	GLU
1	i	177	LEU
1	i	184	ILE
1	i	296	GLU
1	i	300	THR
1	i	330	SER
1	i	369	ARG
1	i	384	THR
1	i	386	ASP
1	i	406	GLU
1	i	518	LEU
1	j	5	THR
1	j	26	GLU
1	j	46	GLU
1	j	177	LEU
1	j	184	ILE
1	j	296	GLU
1	j	300	THR
1	j	330	SER
1	j	369	ARG
1	j	384	THR
1	j	386	ASP

Continued on next page...

Continued from previous page...

Mol	Chain	Res	Type
1	j	406	GLU
1	j	518	LEU
1	k	5	THR
1	k	26	GLU
1	k	46	GLU
1	k	177	LEU
1	k	184	ILE
1	k	296	GLU
1	k	300	THR
1	k	330	SER
1	k	369	ARG
1	k	384	THR
1	k	386	ASP
1	k	406	GLU
1	k	518	LEU
1	l	5	THR
1	l	26	GLU
1	l	46	GLU
1	l	177	LEU
1	l	184	ILE
1	l	296	GLU
1	l	300	THR
1	l	330	SER
1	l	369	ARG
1	l	384	THR
1	l	386	ASP
1	l	406	GLU
1	l	518	LEU
3	A	177	VAL
3	A	231	VAL
3	B	177	VAL
3	B	231	VAL
3	C	177	VAL
3	C	231	VAL
3	D	177	VAL
3	D	231	VAL
3	E	177	VAL
3	E	231	VAL
3	F	177	VAL
3	F	231	VAL
3	G	177	VAL
3	G	231	VAL

Continued on next page...

Continued from previous page...

Mol	Chain	Res	Type
3	H	177	VAL
3	H	231	VAL
3	I	177	VAL
3	I	231	VAL
3	J	177	VAL
3	J	231	VAL
3	K	177	VAL
3	K	231	VAL
3	L	177	VAL
3	L	231	VAL

Sometimes sidechains can be flipped to improve hydrogen bonding and reduce clashes. All (119) such sidechains are listed below:

Mol	Chain	Res	Type
1	a	129	GLN
1	a	157	ASN
1	a	378	GLN
1	a	501	GLN
1	b	129	GLN
1	b	157	ASN
1	b	378	GLN
1	b	501	GLN
1	c	129	GLN
1	c	157	ASN
1	c	378	GLN
1	c	501	GLN
1	d	129	GLN
1	d	157	ASN
1	d	378	GLN
1	d	501	GLN
1	e	129	GLN
1	e	157	ASN
1	e	378	GLN
1	e	501	GLN
1	f	129	GLN
1	f	157	ASN
1	f	378	GLN
1	f	501	GLN
1	g	129	GLN
1	g	157	ASN
1	g	378	GLN
1	g	501	GLN

Continued on next page...

Continued from previous page...

Mol	Chain	Res	Type
1	h	129	GLN
1	h	157	ASN
1	h	378	GLN
1	h	501	GLN
1	i	129	GLN
1	i	157	ASN
1	i	378	GLN
1	i	501	GLN
1	j	129	GLN
1	j	157	ASN
1	j	378	GLN
1	j	501	GLN
1	k	129	GLN
1	k	157	ASN
1	k	378	GLN
1	k	501	GLN
1	l	129	GLN
1	l	157	ASN
1	l	378	GLN
1	l	501	GLN
3	A	9	ASN
3	A	131	GLN
3	A	145	ASN
3	A	149	GLN
3	A	153	GLN
3	A	172	ASN
3	B	9	ASN
3	B	131	GLN
3	B	145	ASN
3	B	149	GLN
3	B	153	GLN
3	B	172	ASN
3	C	9	ASN
3	C	131	GLN
3	C	145	ASN
3	C	149	GLN
3	C	172	ASN
3	D	9	ASN
3	D	131	GLN
3	D	145	ASN
3	D	149	GLN
3	D	153	GLN

Continued on next page...

Continued from previous page...

Mol	Chain	Res	Type
3	D	172	ASN
3	E	9	ASN
3	E	131	GLN
3	E	145	ASN
3	E	149	GLN
3	E	153	GLN
3	E	172	ASN
3	F	9	ASN
3	F	131	GLN
3	F	145	ASN
3	F	149	GLN
3	F	153	GLN
3	F	172	ASN
3	G	9	ASN
3	G	131	GLN
3	G	145	ASN
3	G	149	GLN
3	G	153	GLN
3	G	172	ASN
3	H	9	ASN
3	H	131	GLN
3	H	145	ASN
3	H	149	GLN
3	H	153	GLN
3	H	172	ASN
3	I	9	ASN
3	I	131	GLN
3	I	145	ASN
3	I	149	GLN
3	I	153	GLN
3	I	172	ASN
3	J	9	ASN
3	J	131	GLN
3	J	145	ASN
3	J	149	GLN
3	J	153	GLN
3	J	172	ASN
3	K	9	ASN
3	K	131	GLN
3	K	145	ASN
3	K	149	GLN
3	K	153	GLN

Continued on next page...

Continued from previous page...

Mol	Chain	Res	Type
3	K	172	ASN
3	L	9	ASN
3	L	131	GLN
3	L	145	ASN
3	L	149	GLN
3	L	153	GLN
3	L	172	ASN

5.3.3 RNA [i](#)

There are no RNA molecules in this entry.

5.4 Non-standard residues in protein, DNA, RNA chains [i](#)

There are no non-standard protein/DNA/RNA residues in this entry.

5.5 Carbohydrates [i](#)

There are no oligosaccharides in this entry.

5.6 Ligand geometry [i](#)

There are no ligands in this entry.

5.7 Other polymers [i](#)

There are no such residues in this entry.

5.8 Polymer linkage issues [i](#)

There are no chain breaks in this entry.

6 Map visualisation [i](#)

This section contains visualisations of the EMDB entry EMD-32616. These allow visual inspection of the internal detail of the map and identification of artifacts.

No raw map or half-maps were deposited for this entry and therefore no images, graphs, etc. pertaining to the raw map can be shown.

6.1 Orthogonal projections [i](#)

6.1.1 Primary map

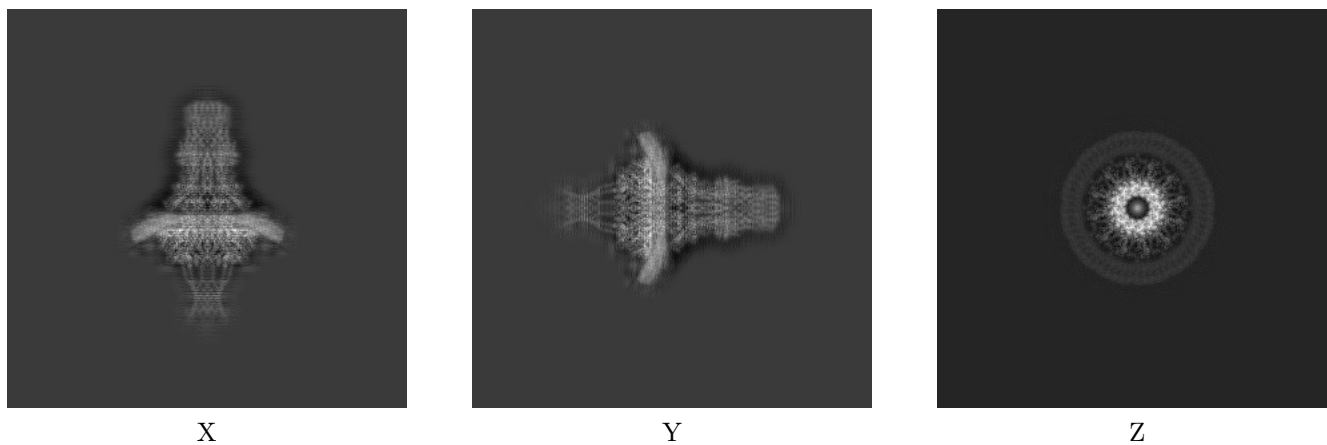

The images above show the map projected in three orthogonal directions.

6.2 Central slices [i](#)

6.2.1 Primary map

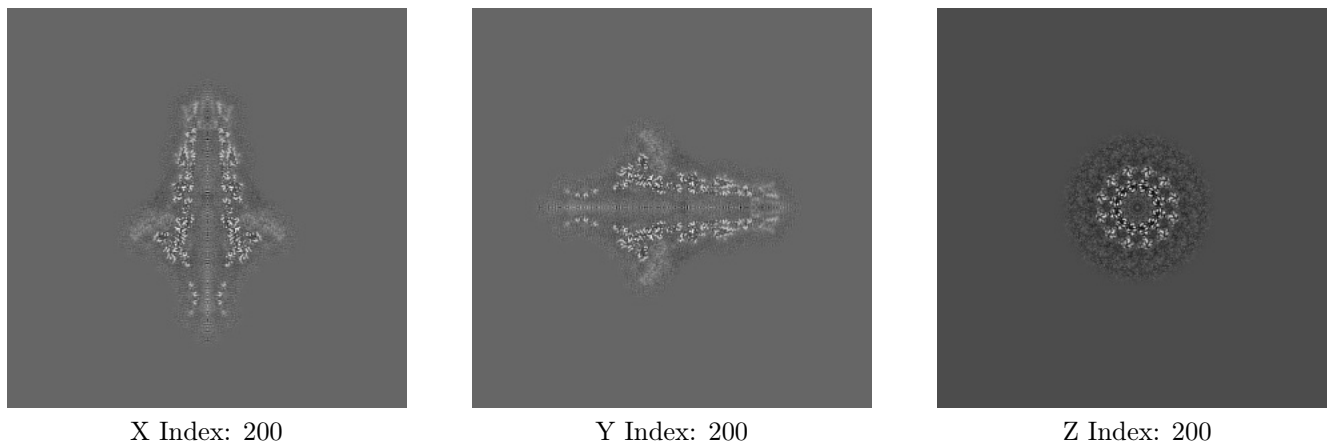

The images above show central slices of the map in three orthogonal directions.

6.3 Largest variance slices [i](#)

6.3.1 Primary map

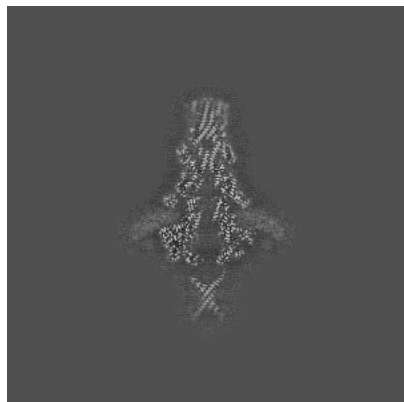

X Index: 187

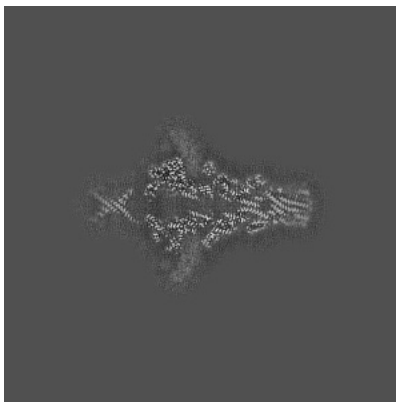

Y Index: 187

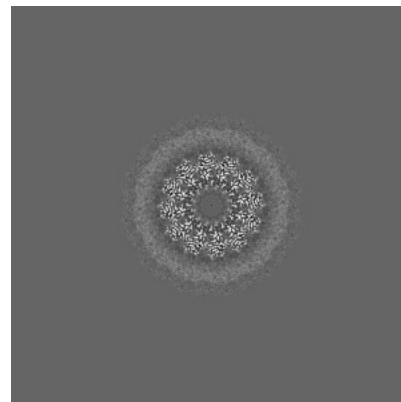

Z Index: 172

The images above show the largest variance slices of the map in three orthogonal directions.

6.4 Orthogonal standard-deviation projections (False-color) [i](#)

6.4.1 Primary map

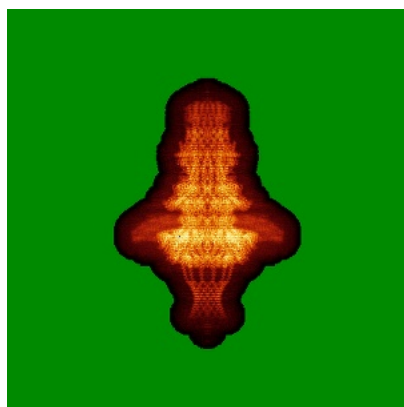

X

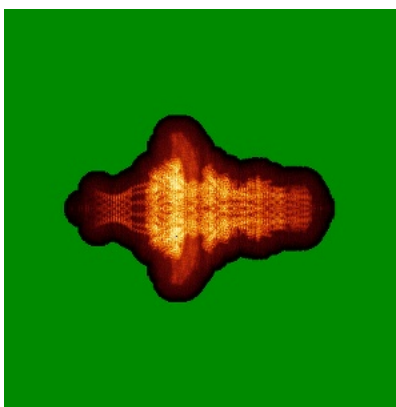

Y

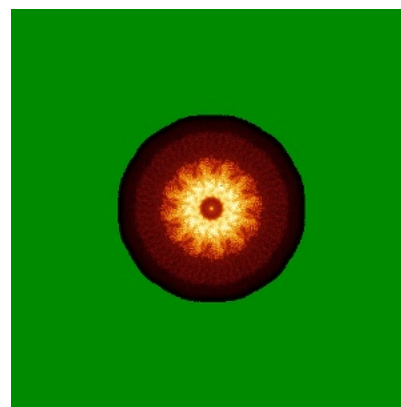

Z

The images above show the map standard deviation projections with false color in three orthogonal directions. Minimum values are shown in green, max in blue, and dark to light orange shades represent small to large values respectively.

6.5 Orthogonal surface views [i](#)

6.5.1 Primary map

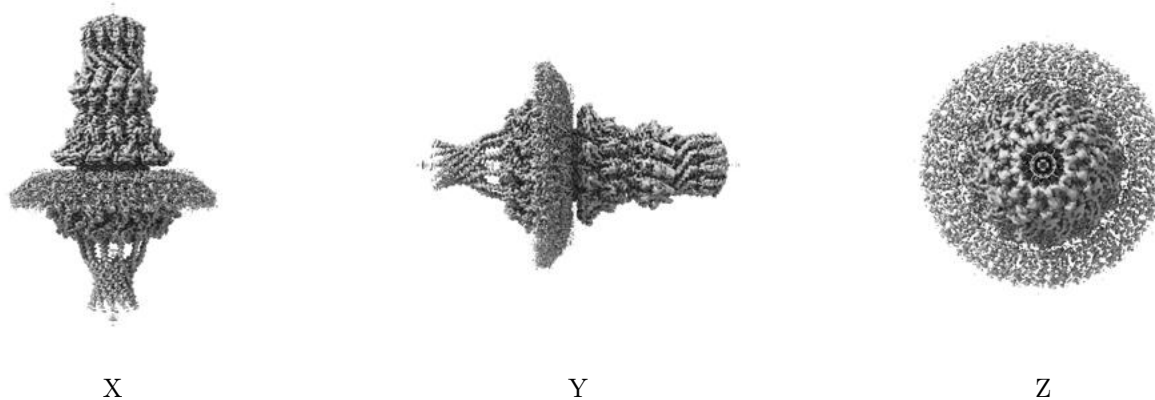

The images above show the 3D surface view of the map at the recommended contour level 0.03. These images, in conjunction with the slice images, may facilitate assessment of whether an appropriate contour level has been provided.

6.6 Mask visualisation [i](#)

This section was not generated. No masks/segmentation were deposited.

7 Map analysis [i](#)

This section contains the results of statistical analysis of the map.

7.1 Map-value distribution [i](#)

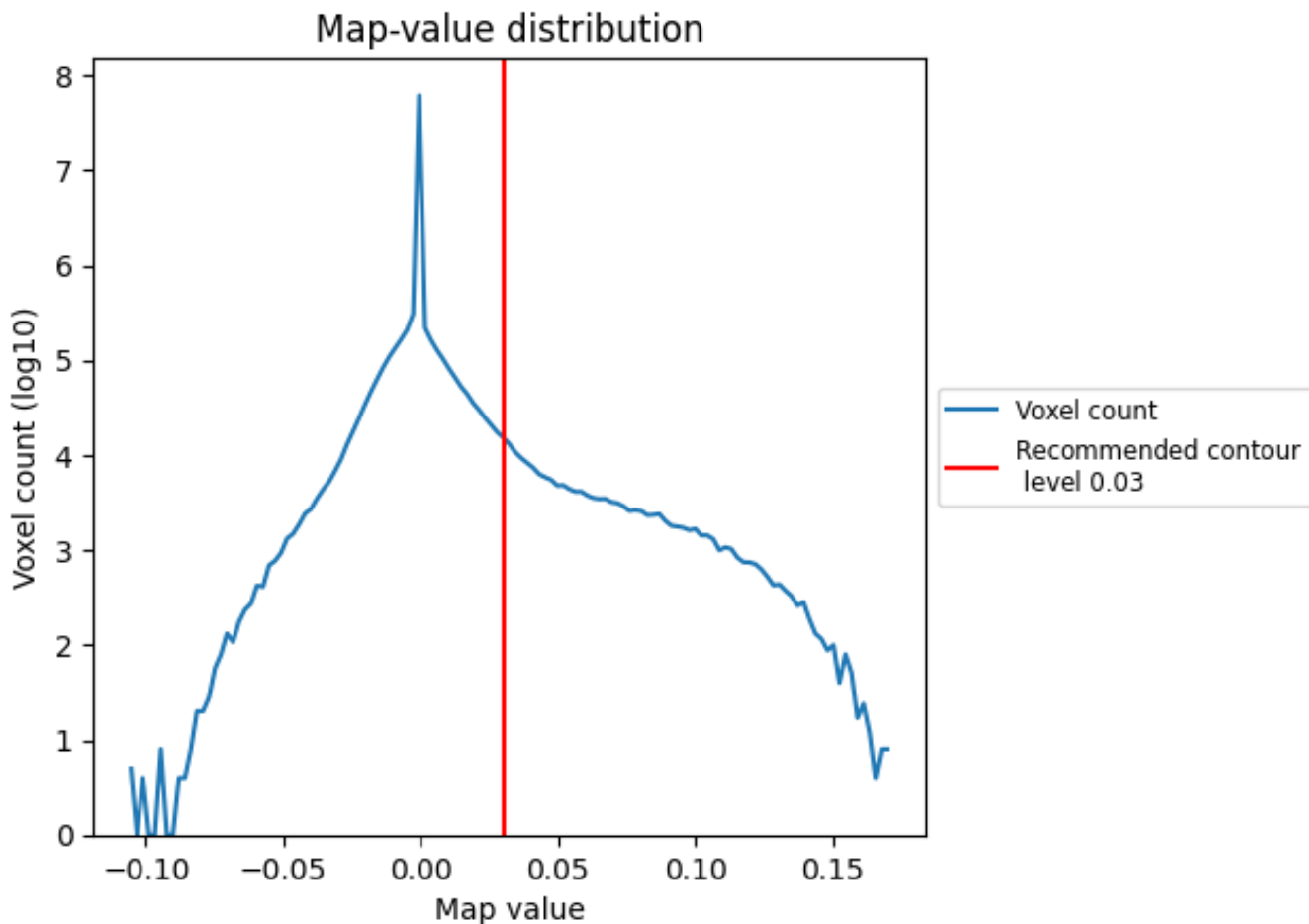

The map-value distribution is plotted in 128 intervals along the x-axis. The y-axis is logarithmic. A spike in this graph at zero usually indicates that the volume has been masked.

7.2 Volume estimate [i](#)

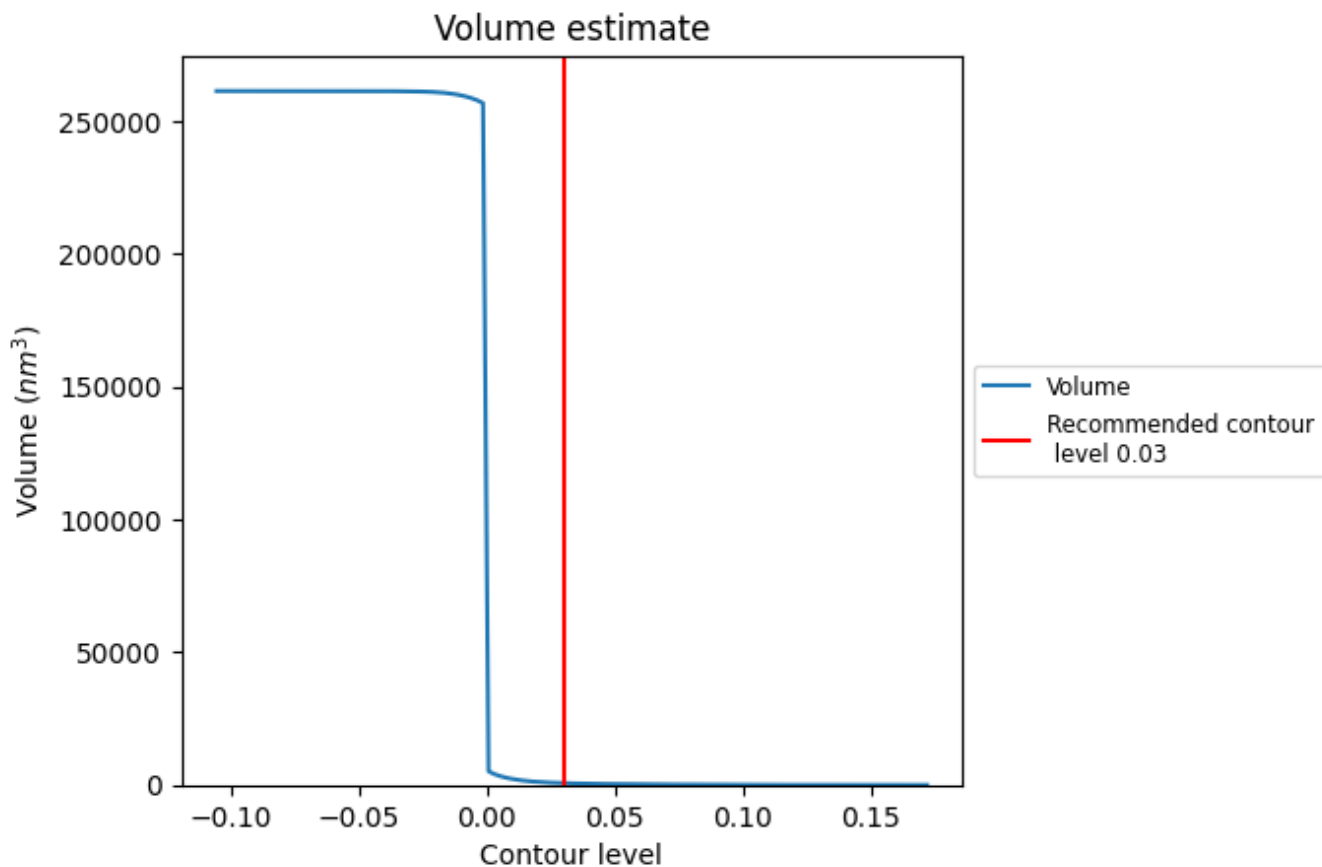

The volume at the recommended contour level is 688 nm^3 ; this corresponds to an approximate mass of 621 kDa.

The volume estimate graph shows how the enclosed volume varies with the contour level. The recommended contour level is shown as a vertical line and the intersection between the line and the curve gives the volume of the enclosed surface at the given level.

7.3 Rotationally averaged power spectrum i

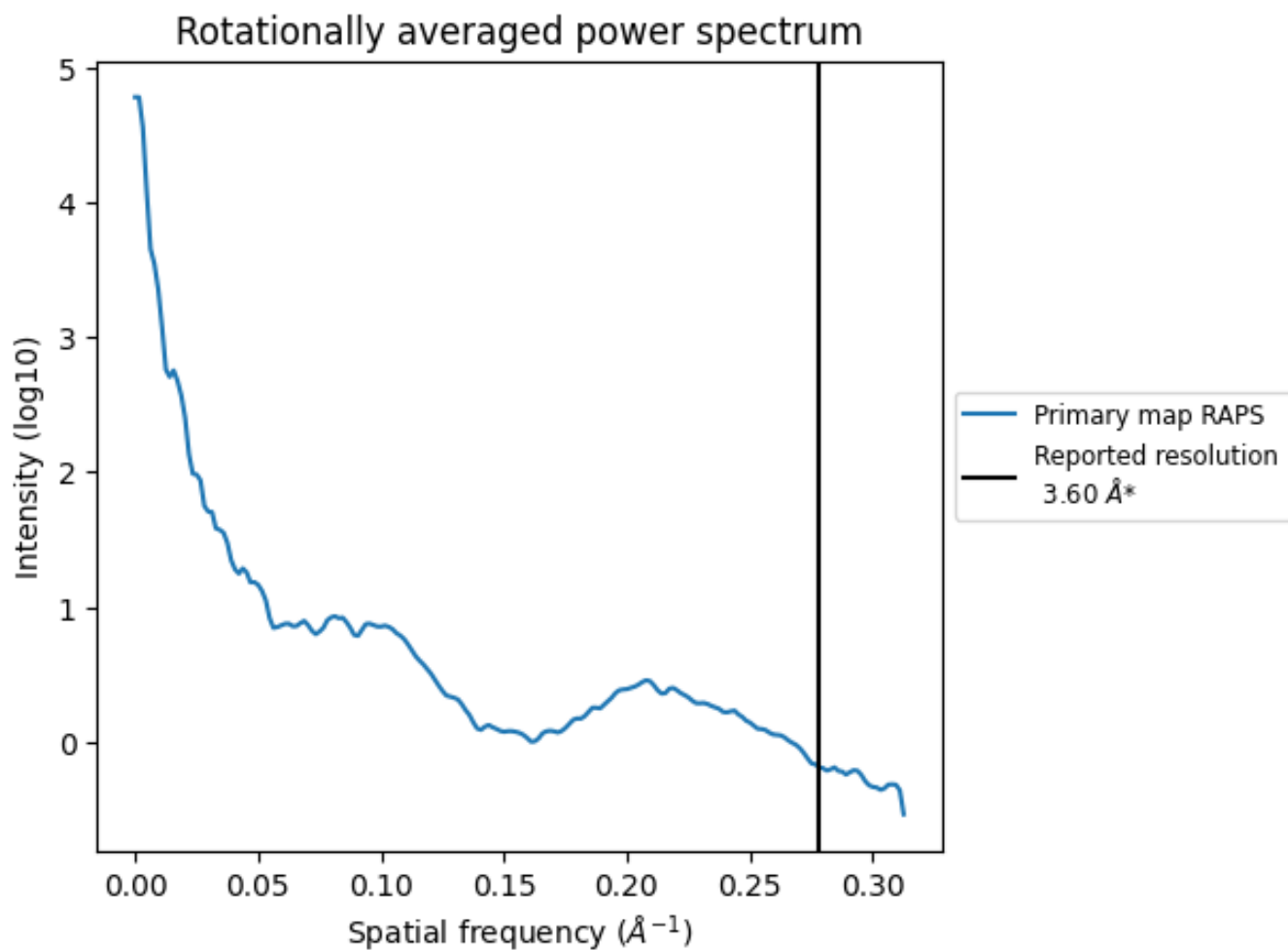

*Reported resolution corresponds to spatial frequency of 0.278 Å⁻¹

8 Fourier-Shell correlation [i](#)

Fourier-Shell Correlation (FSC) is the most commonly used method to estimate the resolution of single-particle and subtomogram-averaged maps. The shape of the curve depends on the imposed symmetry, mask and whether or not the two 3D reconstructions used were processed from a common reference. The reported resolution is shown as a black line. A curve is displayed for the half-bit criterion in addition to lines showing the 0.143 gold standard cut-off and 0.5 cut-off.

8.1 FSC [i](#)

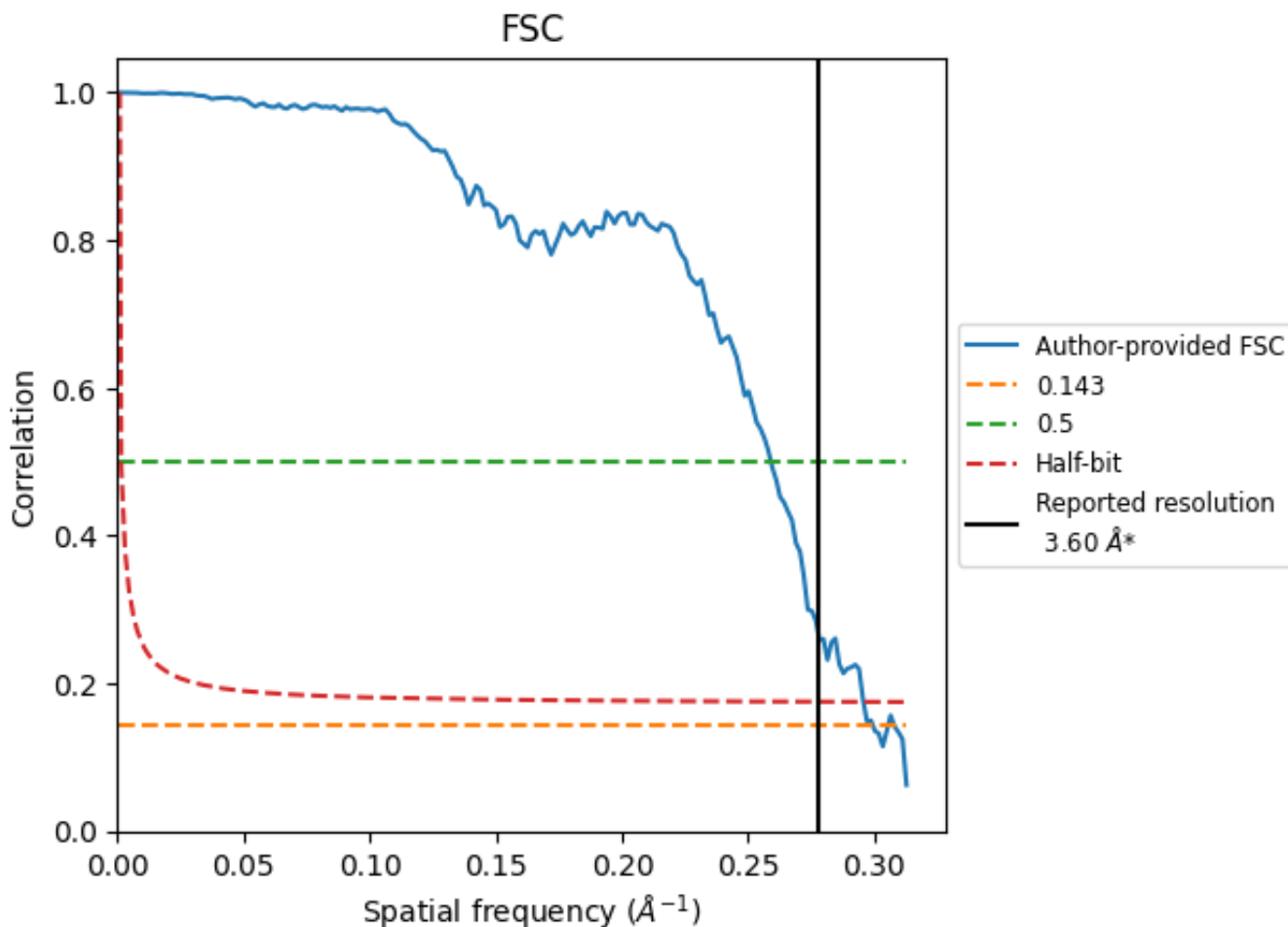

*Reported resolution corresponds to spatial frequency of 0.278 Å⁻¹

8.2 Resolution estimates [i](#)

Resolution estimate (Å)	Estimation criterion (FSC cut-off)		
	0.143	0.5	Half-bit
Reported by author	3.60	-	-
Author-provided FSC curve	3.34	3.86	3.38
Unmasked-calculated*	-	-	-

*Resolution estimate based on FSC curve calculated by comparison of deposited half-maps.

9 Map-model fit [i](#)

This section contains information regarding the fit between EMDB map EMD-32616 and PDB model 7WMP. Per-residue inclusion information can be found in section 3 on page 8.

9.1 Map-model overlay [i](#)

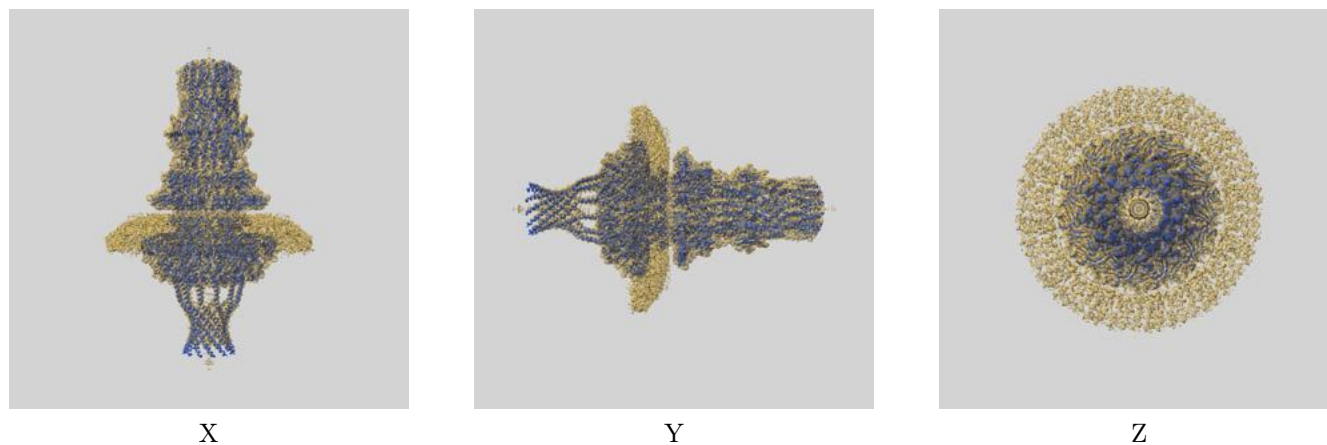

The images above show the 3D surface view of the map at the recommended contour level 0.03 at 50% transparency in yellow overlaid with a ribbon representation of the model coloured in blue. These images allow for the visual assessment of the quality of fit between the atomic model and the map.

9.2 Q-score mapped to coordinate model [i](#)

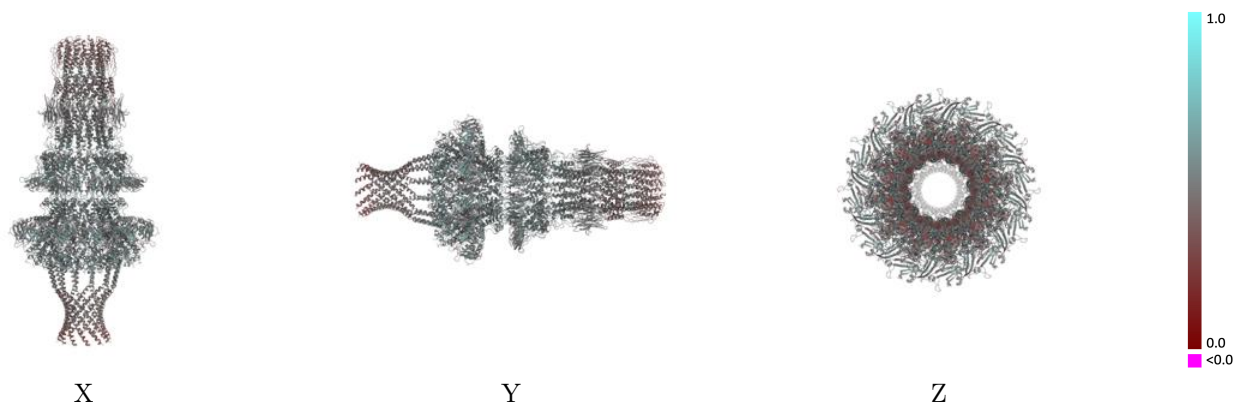

The images above show the model with each residue coloured according its Q-score. This shows their resolvability in the map with higher Q-score values reflecting better resolvability. Please note: Q-score is calculating the resolvability of atoms, and thus high values are only expected at resolutions at which atoms can be resolved. Low Q-score values may therefore be expected for many entries.

9.3 Atom inclusion mapped to coordinate model [i](#)

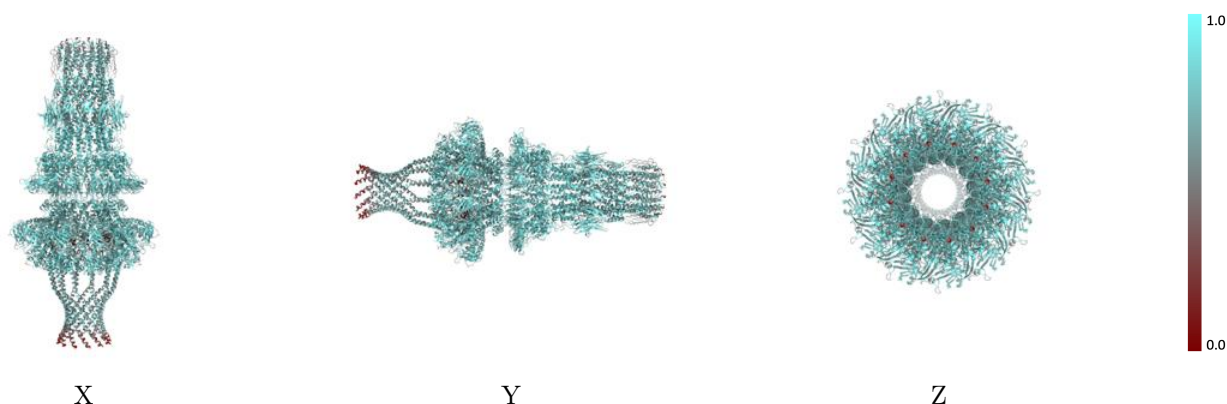

The images above show the model with each residue coloured according to its atom inclusion. This shows to what extent they are inside the map at the recommended contour level (0.03).



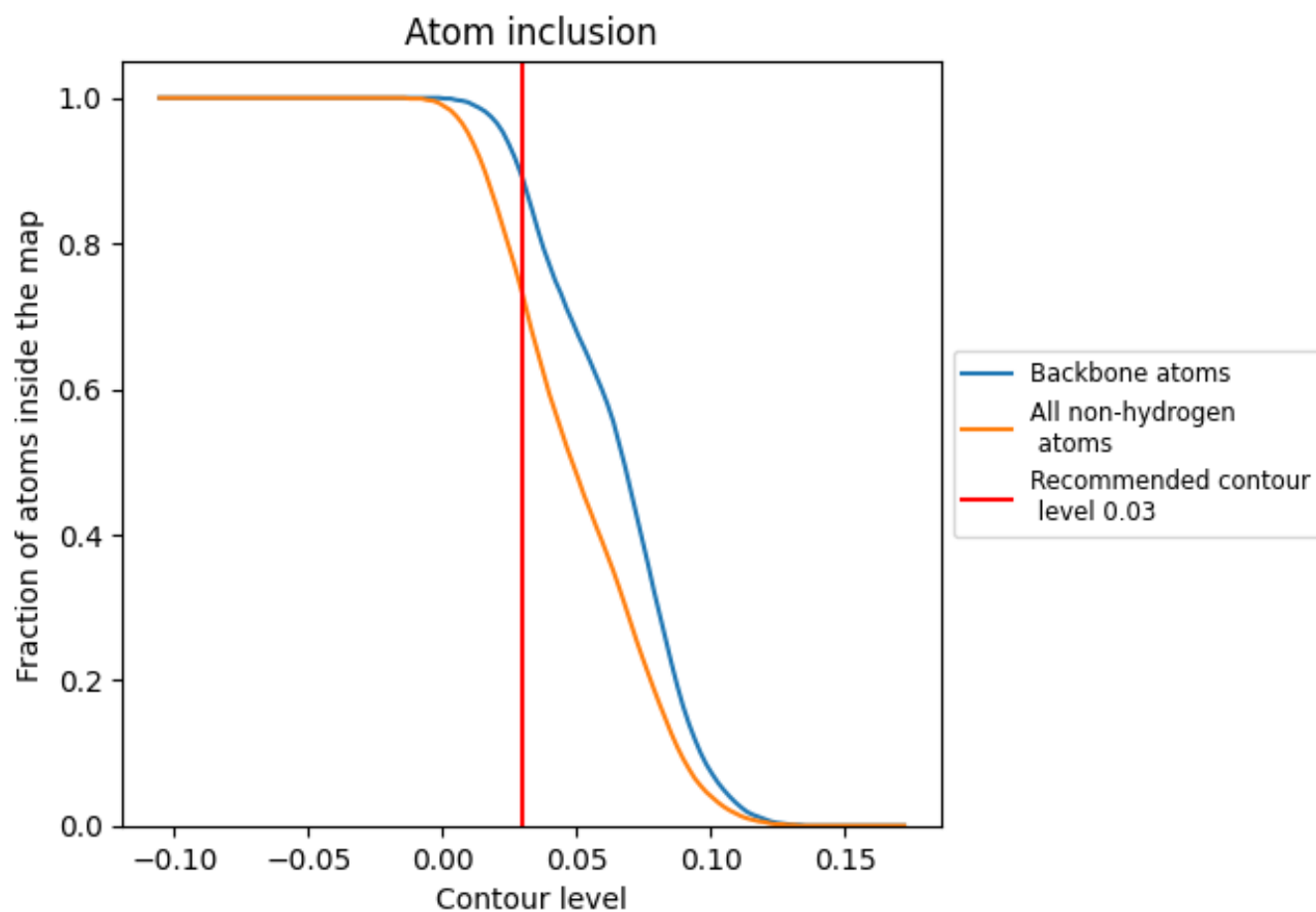



































































9.4 Atom inclusion [i](#)



At the recommended contour level, 89% of all backbone atoms, 73% of all non-hydrogen atoms, are inside the map.

9.5 Map-model fit summary





The table lists the average atom inclusion at the recommended contour level (0.03) and Q-score for the entire model and for each chain.

Chain	Atom inclusion	Q-score
All	 0.7280	 0.4870
A	 0.7120	 0.4450
B	 0.7150	 0.4440
C	 0.7140	 0.4440
D	 0.7130	 0.4440
E	 0.7170	 0.4450
F	 0.7150	 0.4420
G	 0.7120	 0.4450
H	 0.7130	 0.4430
I	 0.7150	 0.4420
J	 0.7120	 0.4440
K	 0.7160	 0.4440
L	 0.7160	 0.4420
a	 0.7130	 0.5000
b	 0.7200	 0.4980
c	 0.7130	 0.5000
d	 0.7130	 0.5000
e	 0.7190	 0.4980
f	 0.7140	 0.5000
g	 0.7150	 0.5000
h	 0.7200	 0.4990
i	 0.7150	 0.4990
j	 0.7130	 0.4990
k	 0.7190	 0.4970
l	 0.7130	 0.4990
m	 0.7780	 0.5110
n	 0.7790	 0.5090
o	 0.7850	 0.5120
p	 0.7780	 0.5100
q	 0.7810	 0.5070
r	 0.7860	 0.5090
s	 0.7770	 0.5070
t	 0.7830	 0.5060
u	 0.7820	 0.5090
v	 0.7800	 0.5080



Continued on next page...

Continued from previous page...

Chain	Atom inclusion	Q-score
w	 0.7790	 0.5080
x	 0.7850	 0.5100