



Full wwPDB EM Validation Report ⓘ

Feb 25, 2024 – 12:49 PM EST

PDB ID : 6X33
EMDB ID : EMD-22016
Title : Wt pig RyR1 in complex with apoCaM, EGTA condition (class 3, open)
Authors : Woll, K.W.; Haji-Ghassemi, O.; Van Petegem, F.
Deposited on : 2020-05-21
Resolution : 4.20 Å (reported)

This is a Full wwPDB EM Validation Report for a publicly released PDB entry.

We welcome your comments at validation@mail.wwpdb.org

A user guide is available at

<https://www.wwpdb.org/validation/2017/EMValidationReportHelp>

with specific help available everywhere you see the ⓘ symbol.

The types of validation reports are described at

<http://www.wwpdb.org/validation/2017/FAQs#types>.

The following versions of software and data (see [references ⓘ](#)) were used in the production of this report:

EMDB validation analysis : 0.0.1.dev70
MolProbity : 4.02b-467
Percentile statistics : 20191225.v01 (using entries in the PDB archive December 25th 2019)
MapQ : 1.9.13
Ideal geometry (proteins) : Engh & Huber (2001)
Ideal geometry (DNA, RNA) : Parkinson et al. (1996)
Validation Pipeline (wwPDB-VP) : 2.36

1 Overall quality at a glance i

The following experimental techniques were used to determine the structure:

ELECTRON MICROSCOPY

The reported resolution of this entry is 4.20 Å.

Percentile scores (ranging between 0-100) for global validation metrics of the entry are shown in the following graphic. The table shows the number of entries on which the scores are based.

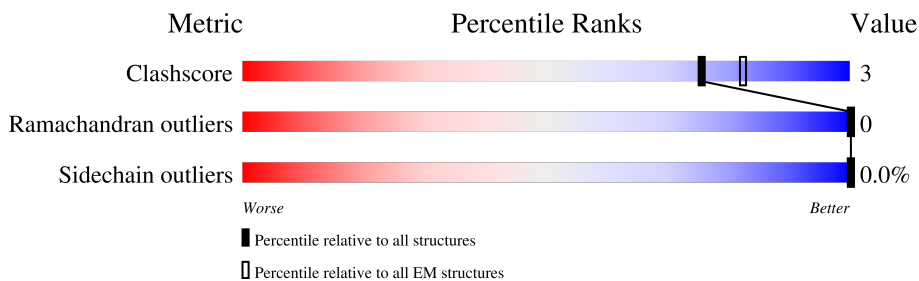

Metric	Whole archive (#Entries)	EM structures (#Entries)
Clashscore	158937	4297
Ramachandran outliers	154571	4023
Sidechain outliers	154315	3826

The table below summarises the geometric issues observed across the polymeric chains and their fit to the map. The red, orange, yellow and green segments of the bar indicate the fraction of residues that contain outliers for ≥ 3 , 2, 1 and 0 types of geometric quality criteria respectively. A grey segment represents the fraction of residues that are not modelled. The numeric value for each fraction is indicated below the corresponding segment, with a dot representing fractions $\leq 5\%$. The upper red bar (where present) indicates the fraction of residues that have poor fit to the EM map (all-atom inclusion $< 40\%$). The numeric value is given above the bar.

Mol	Chain	Length	Quality of chain
1	A	107	
1	D	107	
1	G	107	
1	J	107	
2	B	3816	
2	E	3816	
2	H	3816	
2	K	3816	

Continued on next page...

Continued from previous page...

Mol	Chain	Length	Quality of chain
3	C	148	
3	F	148	
3	I	148	
3	L	148	

2 Entry composition [i](#)

There are 4 unique types of molecules in this entry. The entry contains 112372 atoms, of which 0 are hydrogens and 0 are deuteriums.

In the tables below, the AltConf column contains the number of residues with at least one atom in alternate conformation and the Trace column contains the number of residues modelled with at most 2 atoms.

- Molecule 1 is a protein called Peptidyl-prolyl cis-trans isomerase FKBP1B.

Mol	Chain	Residues	Atoms					AltConf	Trace
			Total	C	N	O	S		
1	A	106	727	460	124	139	4	0	0
1	D	106	727	460	124	139	4	0	0
1	G	106	727	460	124	139	4	0	0
1	J	106	727	460	124	139	4	0	0

- Molecule 2 is a protein called Ryanodine Receptor.

Mol	Chain	Residues	Atoms					AltConf	Trace
			Total	C	N	O	S		
2	B	3816	26597	17002	4711	4735	149	6	0
2	E	3816	26597	17002	4711	4735	149	6	0
2	H	3816	26597	17002	4711	4735	149	6	0
2	K	3816	26597	17002	4711	4735	149	6	0

- Molecule 3 is a protein called Calmodulin-1.

Mol	Chain	Residues	Atoms					AltConf	Trace
			Total	C	N	O	S		
3	C	135	768	477	138	151	2	0	0
3	F	135	768	477	138	151	2	0	0
3	I	135	768	477	138	151	2	0	0
3	L	135	768	477	138	151	2	0	0

- Molecule 4 is ZINC ION (three-letter code: ZN) (formula: Zn).

Mol	Chain	Residues	Atoms		AltConf
4	B	1	Total 1	Zn 1	0
4	E	1	Total 1	Zn 1	0
4	H	1	Total 1	Zn 1	0
4	K	1	Total 1	Zn 1	0

3 Residue-property plots

These plots are drawn for all protein, RNA, DNA and oligosaccharide chains in the entry. The first graphic for a chain summarises the proportions of the various outlier classes displayed in the second graphic. The second graphic shows the sequence view annotated by issues in geometry and atom inclusion in map density. Residues are color-coded according to the number of geometric quality criteria for which they contain at least one outlier: green = 0, yellow = 1, orange = 2 and red = 3 or more. A red diamond above a residue indicates a poor fit to the EM map for this residue (all-atom inclusion < 40%). Stretches of 2 or more consecutive residues without any outlier are shown as a green connector. Residues present in the sample, but not in the model, are shown in grey.

- Molecule 1: Peptidyl-prolyl cis-trans isomerase FKBP1B

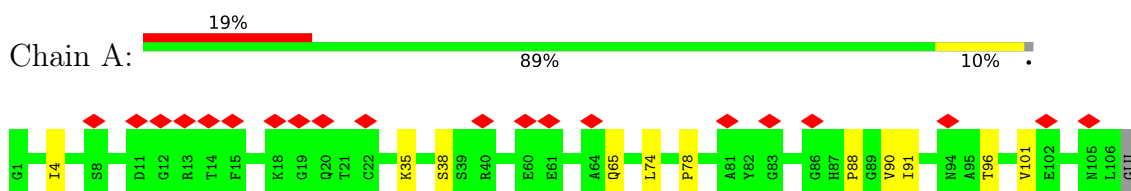

- Molecule 1: Peptidyl-prolyl cis-trans isomerase FKBP1B

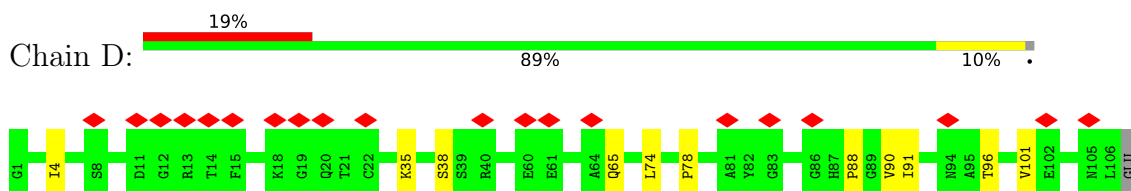

- Molecule 1: Peptidyl-prolyl cis-trans isomerase FKBP1B

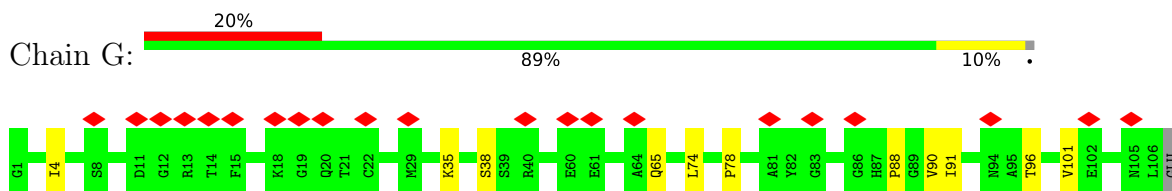

- Molecule 1: Peptidyl-prolyl cis-trans isomerase FKBP1B

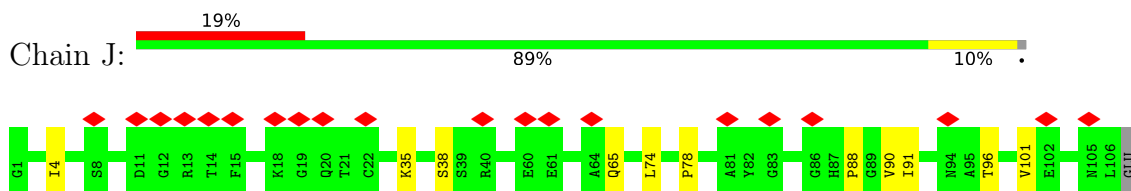

- Molecule 2: Ryanodine Receptor

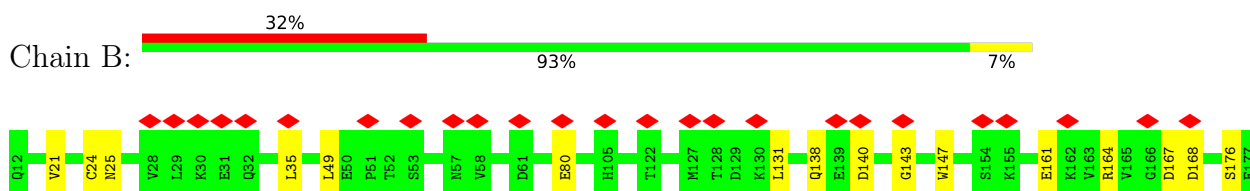

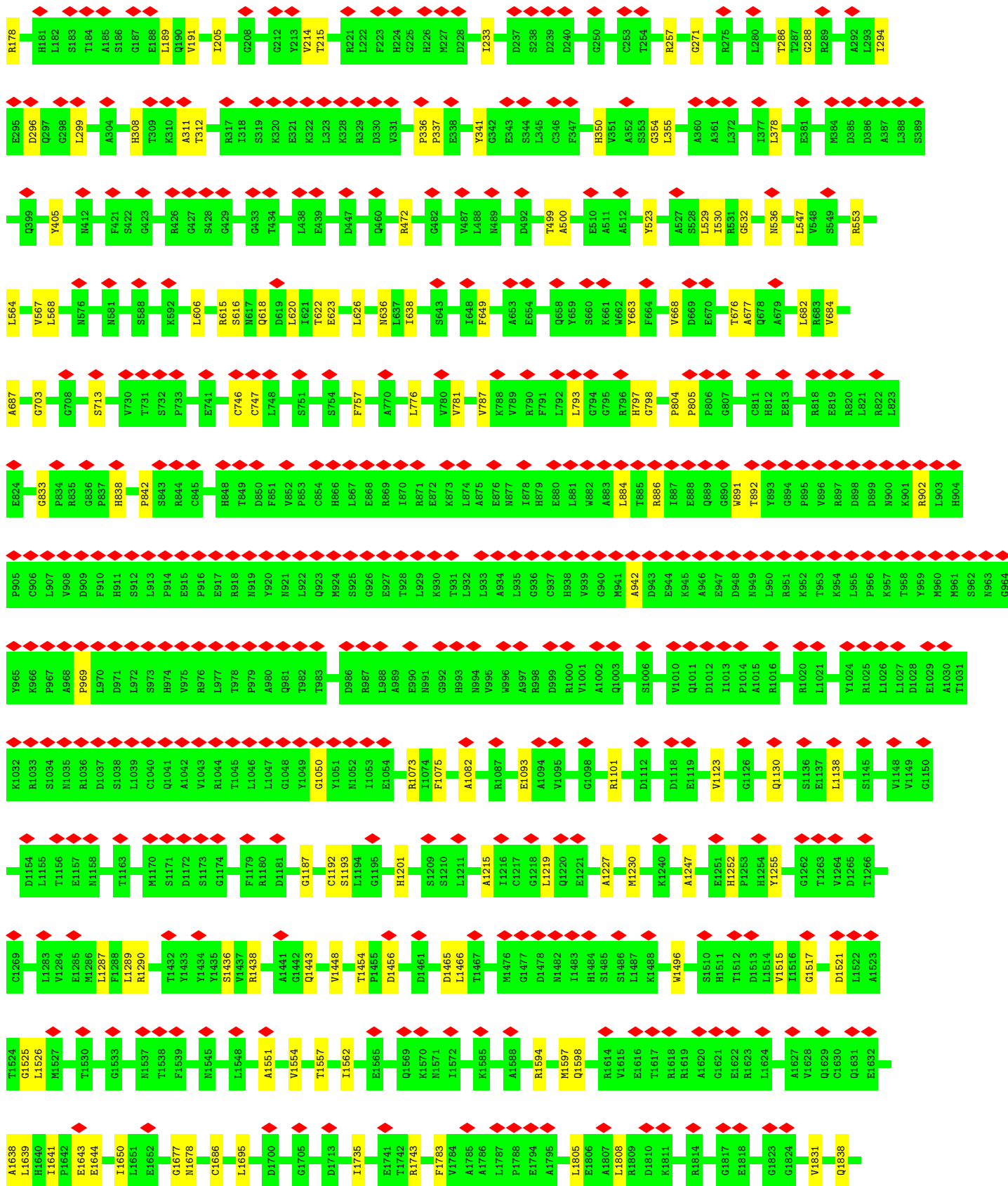

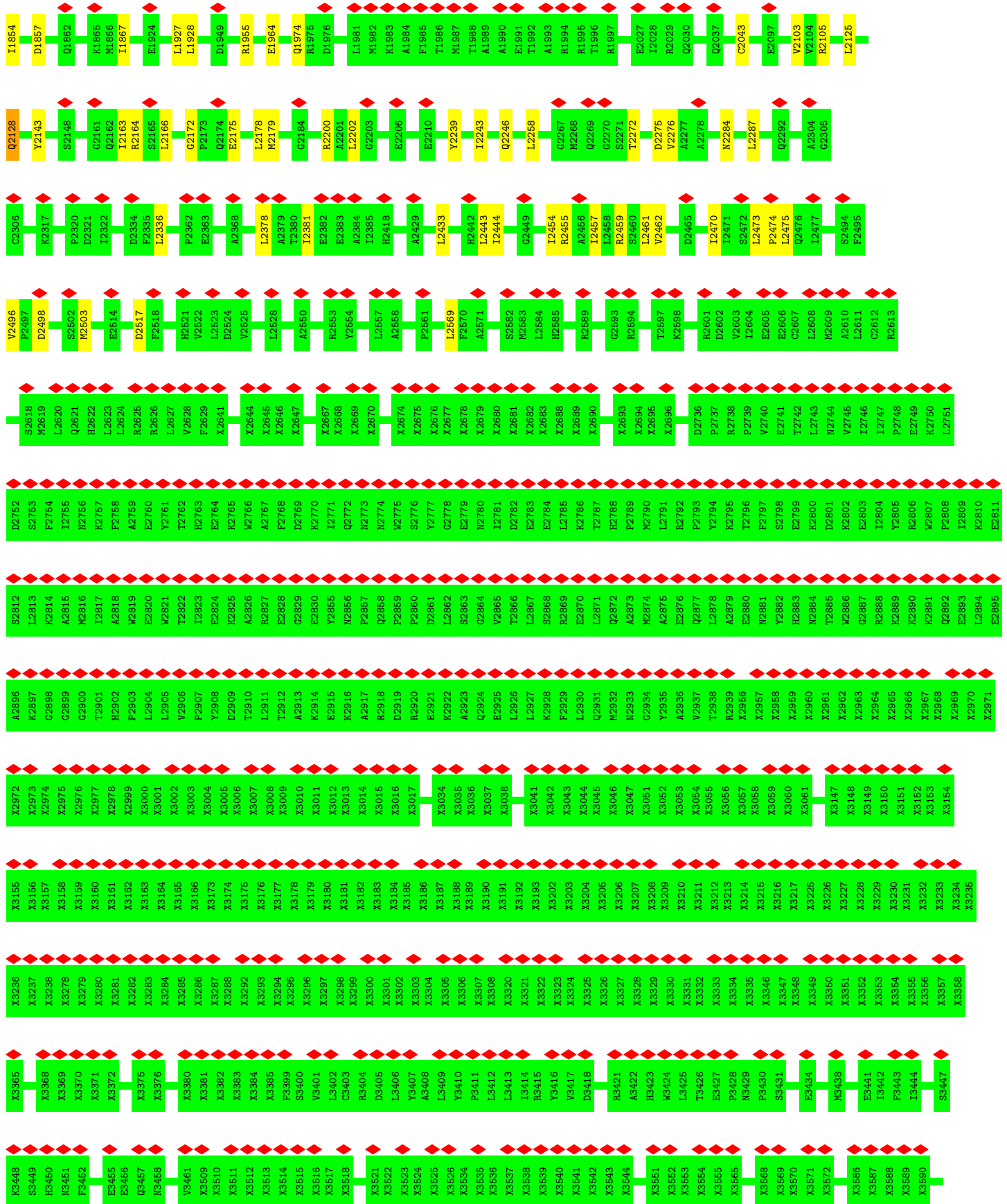

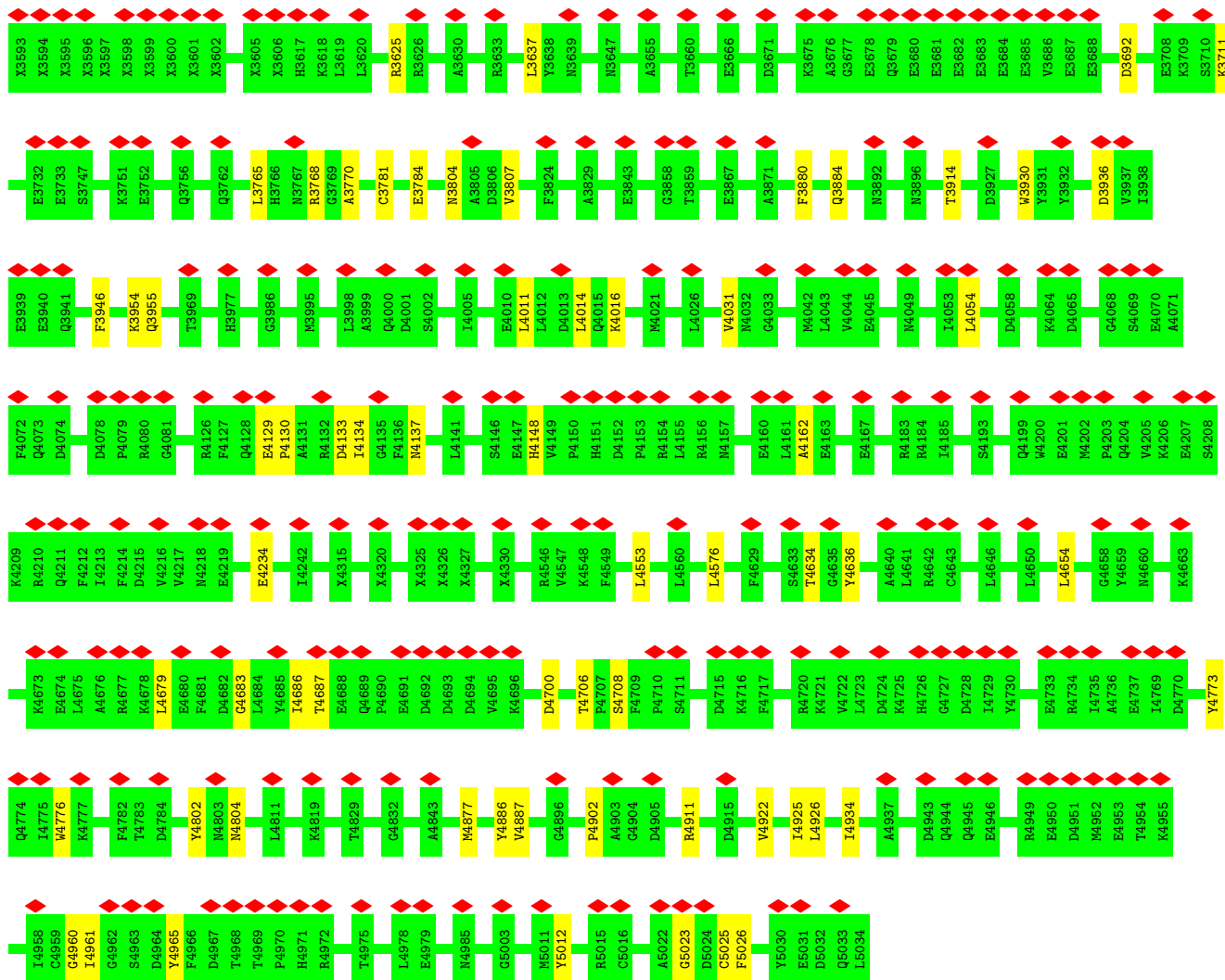

• Molecule 2: Ryanodine Receptor

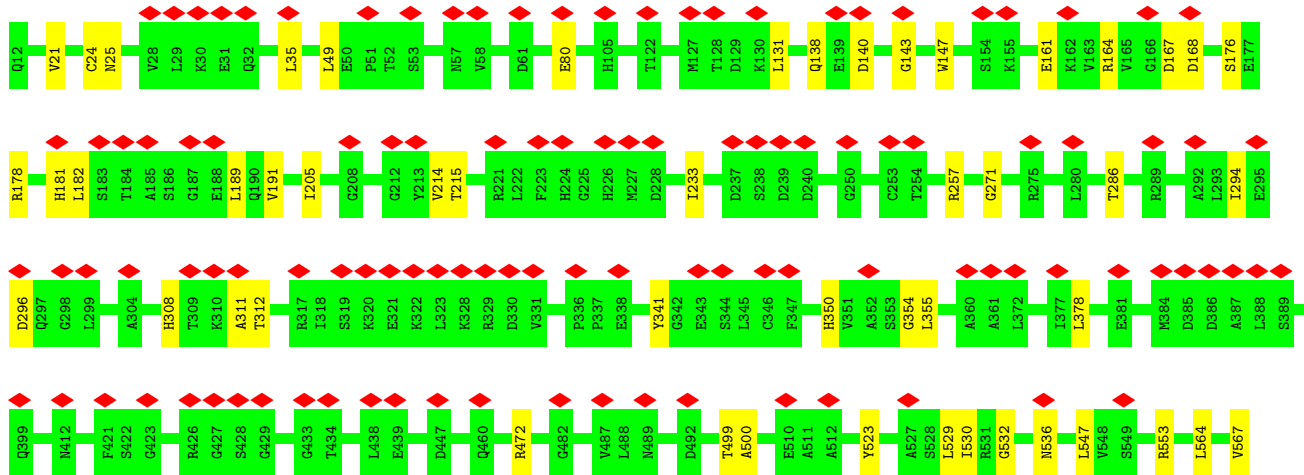
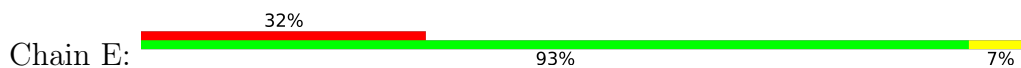

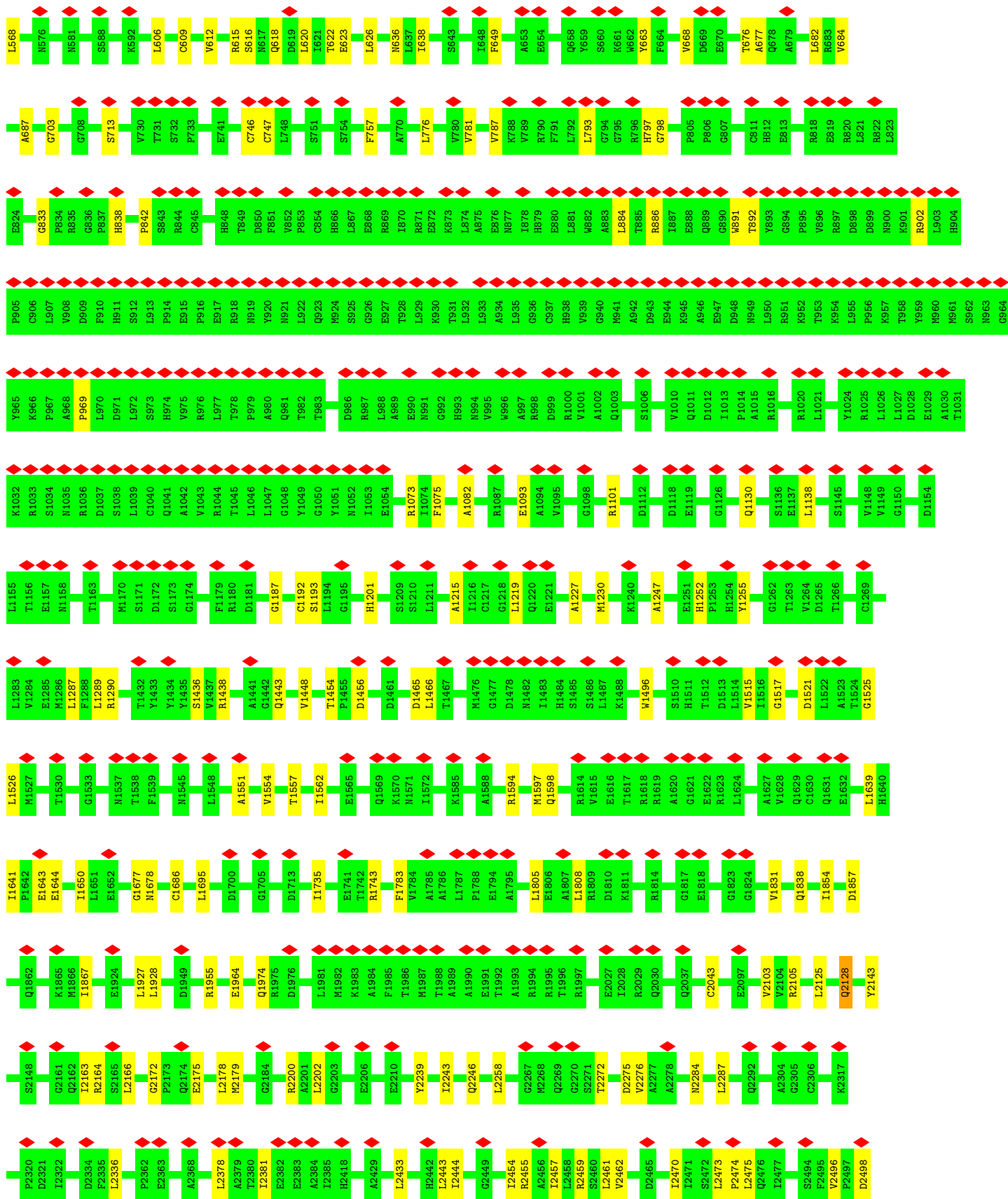

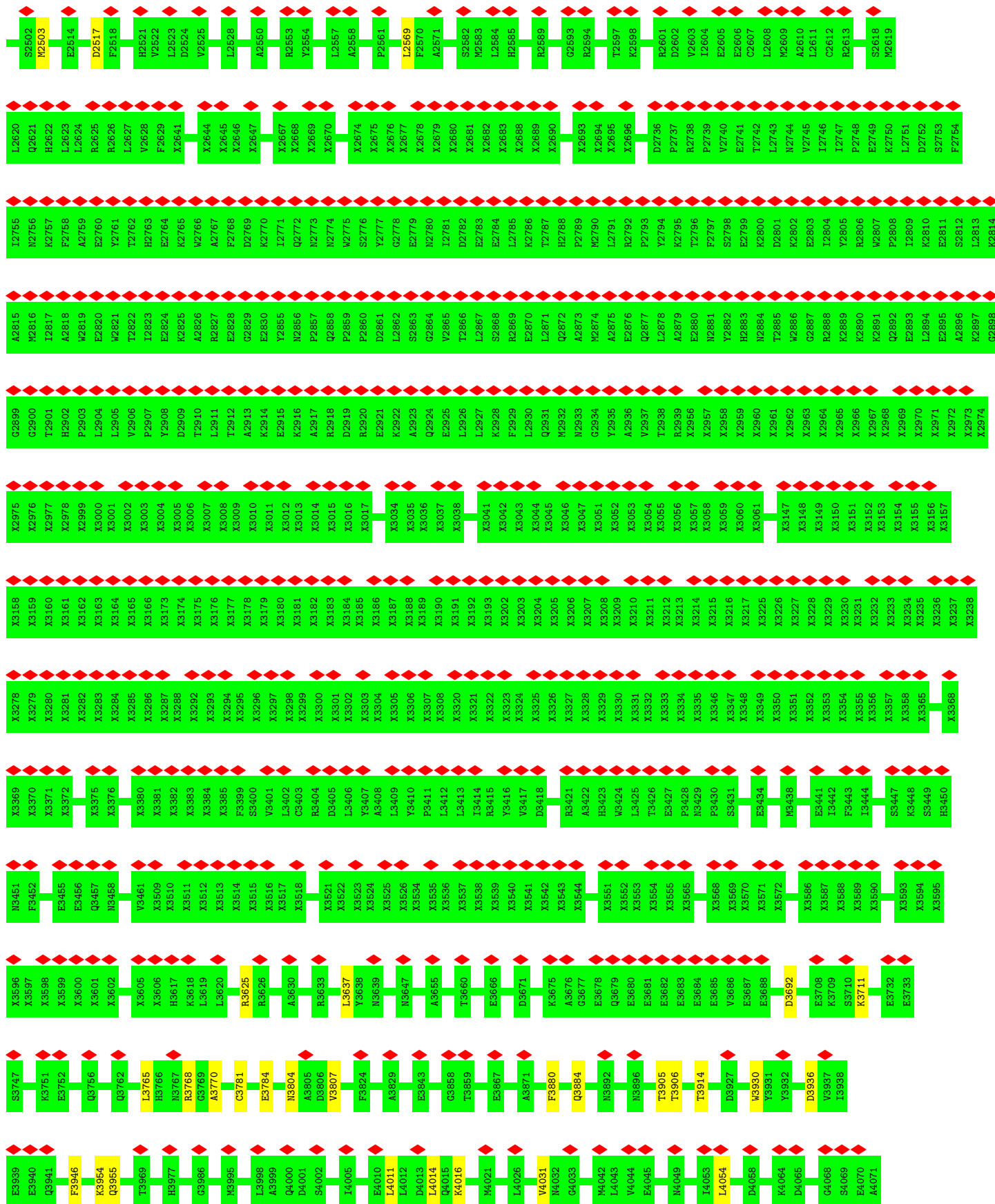

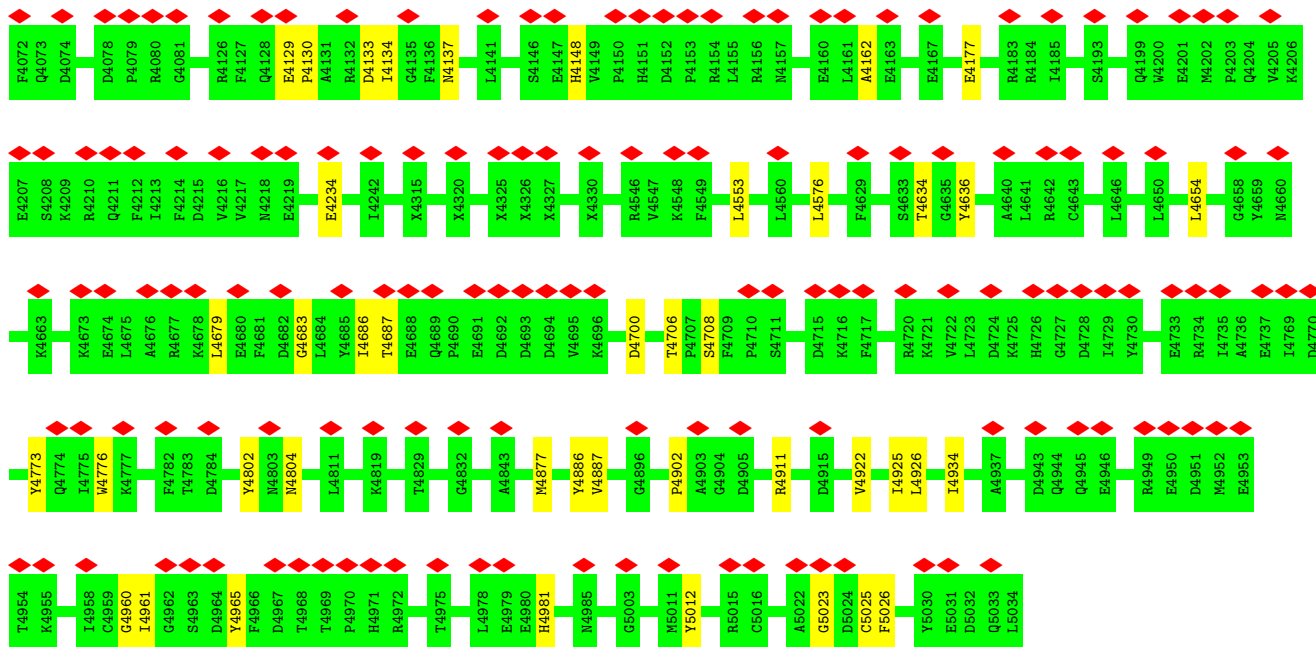

● Molecule 2: Ryanodine Receptor

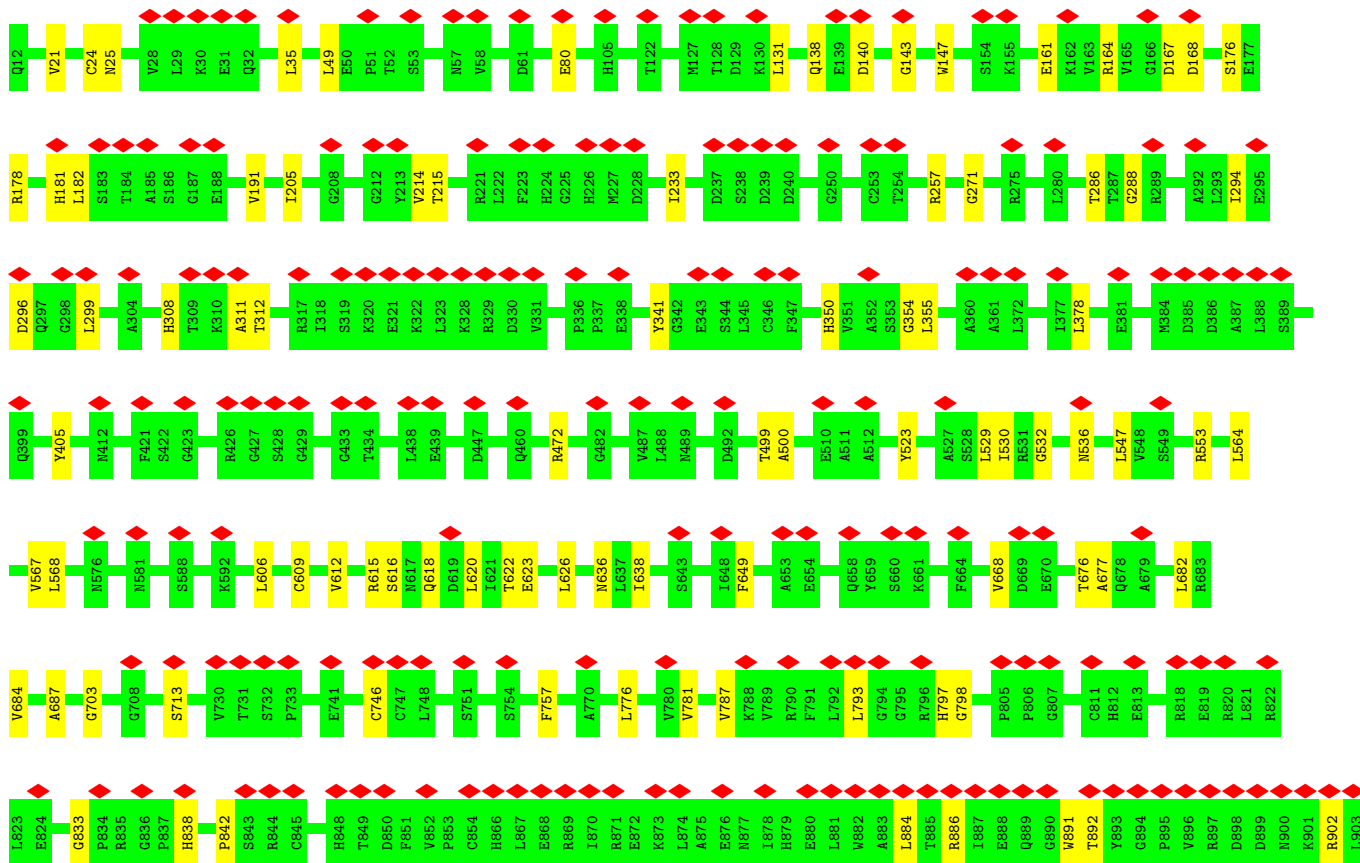
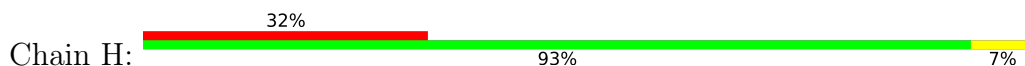

I2746	L2608	L2475	L2287	E2097	G1824	L1639	A1523	D1154	T1091	G964	H904
I2747	M2609	Q2476	Q2292	V2103	V1831	H1640	T1524	L1155	K1032	Y965	P905
P2748	A2610	I2477	A2304	W2104	S1834	P1642	G1525	T1156	R1033	K966	C906
E2749	C2611	S2494	G2305	R2105	F1837	E1643	L1526	E1157	S1034	P967	L907
K2750	R2612	V2495	C2306	L2125	Q1838	E1644	M1527	M1158	N1035	A968	V908
L2751	R2613	P2497	K2317	Q1828	I1854	I1650	T1530	T1163	R1036	P969	D909
S2752	S2618	D2498	P2320	Y2143	D1857	L1651	R1290	M1170	D1037	L970	F910
S2753	L2620	S2502	D2321	Q2148	Q1862	E1652	G1533	S1171	S1038	D971	H911
F2754	Q2621	M2503	L2322	S2148	K1865	M1677	M1537	D1172	C1040	S973	S912
N2755	L2623	E2514	D2334	G2161	M1866	N1678	T1538	D1173	Q1041	H974	L913
K2756	R2624	D2517	F2335	R2163	I1867	C1686	F1539	S1173	Q1042	V975	P914
A2757	R2625	F2518	L2336	R2164	E1924	L1695	L1548	G1174	V1043	R976	E915
E2760	R2626	H2521	P2362	S2165	E1924	D1700	M1545	F1179	R1044	L977	P916
Y2761	L2627	V2522	E2383	L2166	L1927	G1705	L1548	R1180	T1045	T978	R918
H2763	F2629	L2523	A2384	L2166	L1928	Q1713	A1551	D1181	L1046	T979	N919
E2764	X2641	D2524	H2418	G2172	L1949	D1713	V1554	G1187	L1047	A980	Y920
K2765	X2644	V2525	A2388	Q2174	R1955	I1735	V1554	C1192	Y1049	T982	N921
W2766	X2645	L2528	L2378	E2175	R1964	I1741	T1454	S1193	G1050	T983	Q923
A2767	X2646	A2550	A2379	L2178	E1964	T1742	P1455	L1194	Y1051	M924	M924
F2768	X2647	A2550	T2380	M2179	E1964	I1745	D1456	G1195	N1052	S925	S925
D2769	X2667	R2553	E2382	G2184	Q1974	A1744	Q1569	H1201	I1053	R987	G926
I2771	X2668	Y2554	E2383	R2200	R1975	I1745	K1570	S1209	E1054	A989	E927
Q2772	X2669	L2557	A2384	A2201	D1976	H1777	L1572	S1210	R1073	E990	T928
N2773	X2670	A2558	H2418	L2202	D1976	H1777	I1572	L1211	F1075	M991	L929
W2774	X2674	A2558	A2429	G2203	L1981	H1777	I1572	A1215	A1082	H993	K930
N2775	X2675	P2561	L2433	E2206	M1982	F1783	K1586	C1217	R1087	N994	L932
S2776	X2676	L2569	L2433	E2210	K1983	A1785	A1588	G1218	R1087	V995	L933
Y2777	X2677	F2570	H2442	E2210	F1985	A1786	A1588	L1219	E1093	W996	A934
G2778	X2678	A2571	L2444	Y2239	T1986	P1788	R1594	Q1220	A1094	A997	L935
E2779	X2679	S2582	L2444	L2243	M1987	E1794	M1597	E1221	V1095	R998	G936
N2780	X2680	M2583	Q2449	Q2246	T1988	A1795	Q1598	A1227	G1098	R1000	C937
I2781	X2681	L2584	R2454	Q2246	A1989	L1799	R1614	M1230	G1098	V1001	H938
D2782	X2682	L2584	R2454	G2267	E1991	L1805	V1615	K1240	D1112	A1002	G940
E2783	X2683	H2585	A2456	M2266	T1992	E1806	E1616	A1247	S1006	S1006	A942
E2784	X2688	R2589	A2456	Q2269	A1993	A1807	T1617	A1247	V1010	V1010	D943
K2786	X2689	R2589	L2458	Q2270	R1994	L1808	R1618	E1251	D1118	V1010	E944
T2787	X2690	G2593	R2459	G2270	R1995	R1809	R1619	H1252	E1119	Q1011	K945
H2788	X2693	R2594	S2460	T2272	T1996	D1810	A1620	P1253	D1012	D1012	A946
P2789	X2694	R2594	L2461	T2272	K1811	K1811	G1621	Y1255	I1013	I1013	E947
M2790	X2695	T2597	V2462	D2275	R1814	R1814	G1623	Q1130	P1014	P1014	D948
L2791	X2696	K2598	D2465	A2278	G1817	G1817	R1624	S1136	A1015	A1015	N949
R2792	D2736	R2601	I2470	A2278	E1818	E1818	L1624	E1137	R1016	R1016	L950
P2793	P2737	D2602	L2471	M2284	G1818	G1818	A1627	L1138	R1020	R1020	K951
Y2794	R2738	V2603	S2472		E1818	E1818	Q1628	L1138	L1021	L1021	K952
K2795	P2739	L2604	L2473		G1823	G1823	C1630	S1145	L1021	L1021	T953
T2796	F2739	E2605	P2474		L1624	L1624	Q1631	V1148	Y1024	Y1024	K954
F2797	V2740	E2606			A1627	A1627	Q1631	V1149	R1025	R1025	L955
S2798	E2741	C2607			Q1628	Q1628	Q1630	V1149	L1026	L1026	P956
E2799	T2742				C1630	C1630	Q1631	G1159	L1027	L1027	K957
K2800	L2743				Q1631	Q1631	Q1631	G1159	D1028	D1028	T958
D2801	N2744				E1632	E1632	E1632	G1159	E1029	E1029	Y959
K2802	N2745				E1632	E1632	E1632	G1159	A1030	A1030	M960
E2803					E1632	E1632	E1632	G1159			S962
I2804					E1632	E1632	E1632	G1159			N963

L4646	L4650	L4654	G4658	Y4659	M4660	K4663	K4673	E4674	L4675	A4676	R4677	L4678	L4679	E4680	F4681	D4682	C4683	L4684	Y4685	L4686	L4687	E4688	Q4689	F4690	E4691	D4692	D4693	D4694	V4695	K4696	D4700	T4706	F4707	S4708	F4709	P4710	S4711	D4715	K4716	F4717	R4720	S4633	T4634	Y4636	A4640	L4641	R4642	C4643	D4728										
D4058	K4064	D4065	G4068	S4069	E4070	F4071	A4072	Q4073	D4074	D4078	P4079	R4080	G4081	R4126	F4127	Q4128	P4129	A4130	A4131	R4132	D4133	A4134	G4135	F4136	N4137	L4141	S4146	E4147	H4148	V4149	P4150	H4151	D4152	P4153	R4154	L4155	R4156	N4157	E4160	L4161	A4162	E4163	E4167	E4177	R4183	R4184	L4185												
S4193	Q4199	W4200	M4201	M4202	P4203	Q4204	V4205	K4206	E4207	S4208	K4209	R4210	Q4211	F4212	L4213	F4214	D4215	V4216	V4217	M4218	E4219	E4234	L4242	X4315	X4320	X4325	X4326	X4327	X4330	R4546	V4547	K4548	F4549	L4553	L4560	L4576	F4629	S4633	T4634	Y4636	A4640	L4641	R4642	C4643															
E3687	E3688	D3692	K3693	Y3694	Y3695	Y3696	Y3697	Y3698	Y3699	K3701	E3752	Q3756	Q3762	L3765	H3766	N3767	R3768	G3769	A3770	Q3623	R3624	R3625	R3626	A3630	R3633	L3637	T3638	N3639	N3647	A3655	T3660	E3666	D3671	K3675	A3676	G3677	E3678	Q3679	E3680	E3681	E3682	E3683	E3684	E3685	V3686														
E3441	I3442	F3443	I3444	S3447	K3448	S3449	H3450	N3451	F3452	E3455	E3456	Q3457	N3458	V3461	X3509	X3510	X3511	X3512	X3513	X3514	X3515	X3516	X3517	X3518	X3521	X3522	X3523	X3524	X3525	X3526	X3534	X3535	X3536	X3537	X3538	X3539	X3540	X3541	X3542	X3543	X3544	X3551	X3552	X3553	X3554	X3555	X3556	X3566	X3569	X3570	X3571	X3572	H3438						
X3353	X3354	X3355	X3356	X3357	X3358	X3359	X3368	X3369	X3370	X3371	X3372	X3375	X3376	X3380	X3381	X3382	X3383	X3384	X3385	F3389	S3400	V3401	L3402	C3403	R3404	D3405	L3406	Y3407	A3408	Y3410	F3411	L3412	L3413	L3414	R3415	V3417	D3418	R3421	A3422	H3423	W3424	L3425	T3426	E3427	P3428	N3429	F3430	S3431	E3434	H3438									
X3230	X3231	X3232	X3233	X3234	X3235	X3236	X3237	X3238	X3278	X3279	X3280	X3281	X3282	X3283	X3284	X3285	X3286	X3287	X3288	X3292	X3293	X3294	X3295	X3296	X3297	X3298	X3299	X3300	X3301	X3302	X3303	X3304	X3305	X3306	X3307	X3308	X3320	X3321	X3322	X3323	X3324	X3325	X3326	X3327	X3328	X3329	X3330	X3331	X3332	X3333	X3334	X3335	X3346	X3347	X3348	X3349	X3350	X3351	X3352
X3149	X3150	X3151	X3152	X3153	X3154	X3155	X3156	X3157	X3158	X3159	X3160	X3161	X3162	X3163	X3164	X3165	X3166	X3173	X3174	X3175	X3176	X3177	X3178	X3179	X3180	X3181	X3182	X3183	X3184	X3185	X3186	X3187	X3188	X3189	X3190	X3191	X3192	X3193	X3203	X3204	X3205	X3206	X3207	X3208	X3209	X3210	X3211	X3212	X3213	X3214	X3215	X3216	X3217	X3225	X3226	X3227	X3228	X3229	
X2966	X2967	X2968	X2969	X2970	X2971	X2972	X2973	X2974	X2975	X2976	X2977	X2978	X2979	X2980	X3000	X3001	X3002	X3003	X3004	X3005	X3006	X3007	X3008	X3009	X3010	X3011	X3012	X3013	X3014	X3015	X3016	X3017	X3034	X3035	X3036	X3037	X3038	X3041	X3042	X3043	X3044	X3045	X3046	X3047	X3051	X3052	X3053	X3054	X3055	X3056	X3057	X3058	X3059	X3060	X3061	X3147	X3148		
K2890	K2891	Q2892	E2893	L2894	E2895	A2896	K2897	G2898	G2899	G2900	T2901	H2902	P2903	L2904	L2905	V2906	P2907	Y2908	D2909	T2910	L2911	T2912	A2913	K2914	E2915	K2916	A2917	R2918	D2919	R2920	E2921	K2922	A2923	Q2924	E2925	L2926	L2927	K2928	F2929	L2930	Q2931	M2932	N2933	G2934	Y2935	A2936	V2937	T2938	R2939	X2956	X2957	X2958	X2959	X2960	X2961	X2962	X2963	X2964	X2965
R2806	W2807	P2808	L2809	R2810	E2811	S2812	L2813	R2814	A2815	R2816	L2817	A2818	W2819	E2820	W2821	T2822	L2823	E2824	K2825	A2826	R2827	E2828	G2829	E2830	Y2835	R2856	P2857	Q2858	R2859	P2860	D2861	L2862	S2863	G2864	V2865	L2866	L2867	S2868	R2869	E2870	L2871	Q2872	A2873	A2874	E2875	E2876	Q2877	L2878	A2879	E2880	N2881	Y2882	H2883	N2884	T2885	W2886	Q2887	R2888	

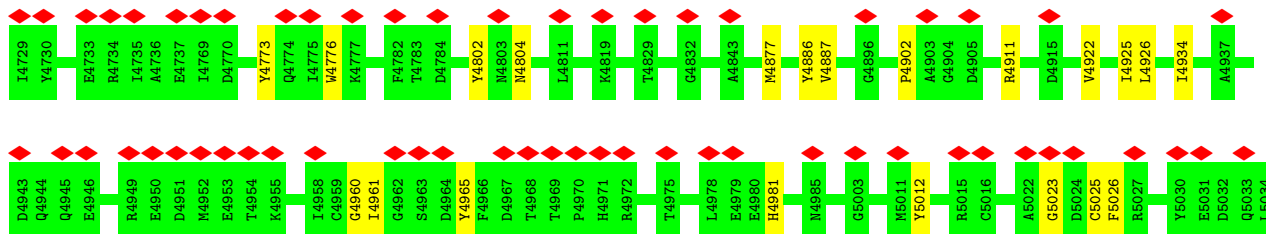

• Molecule 2: Ryanodine Receptor

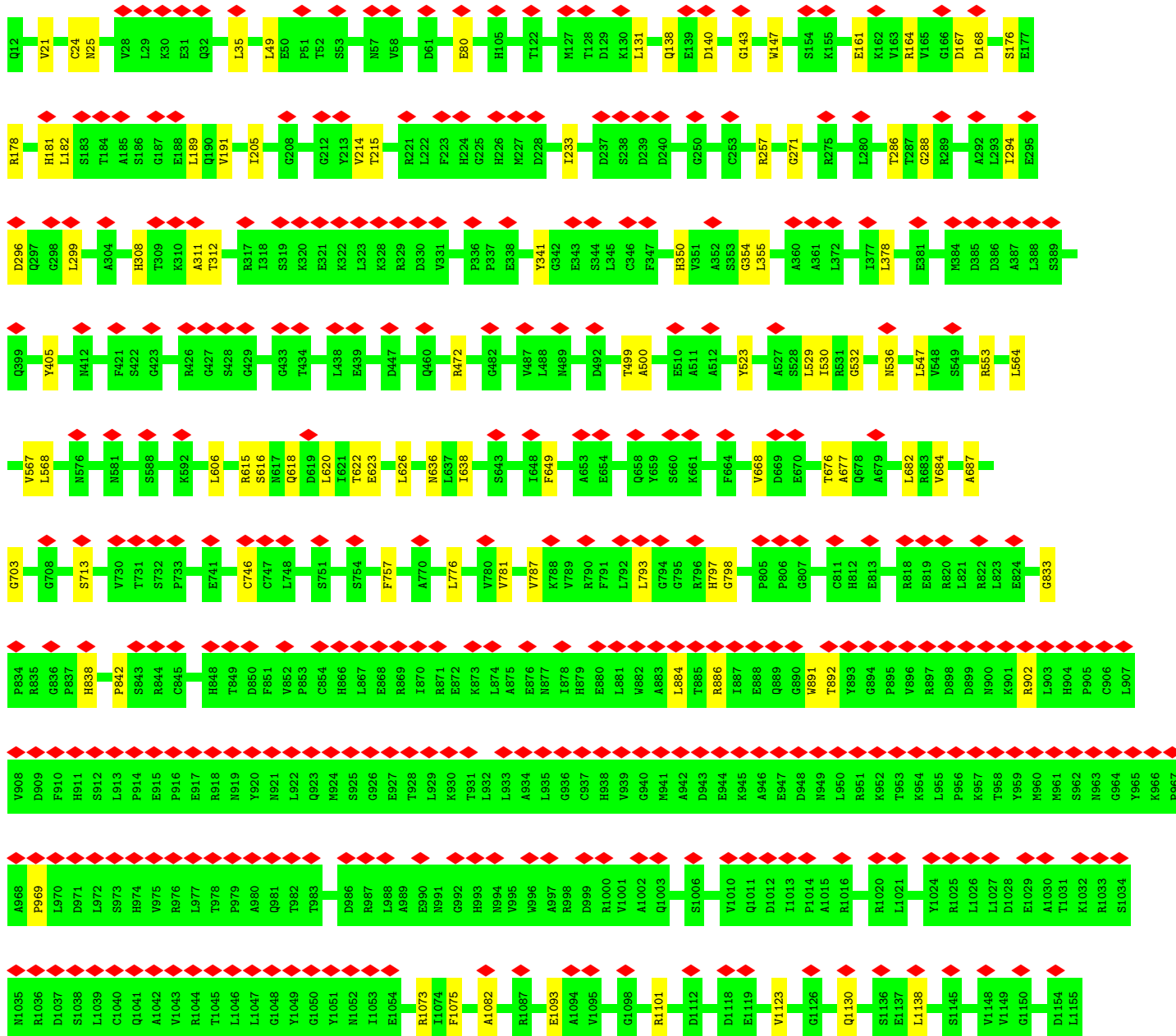
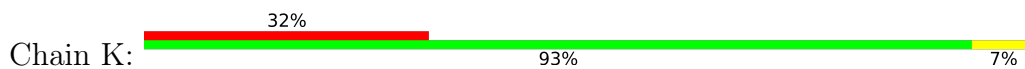

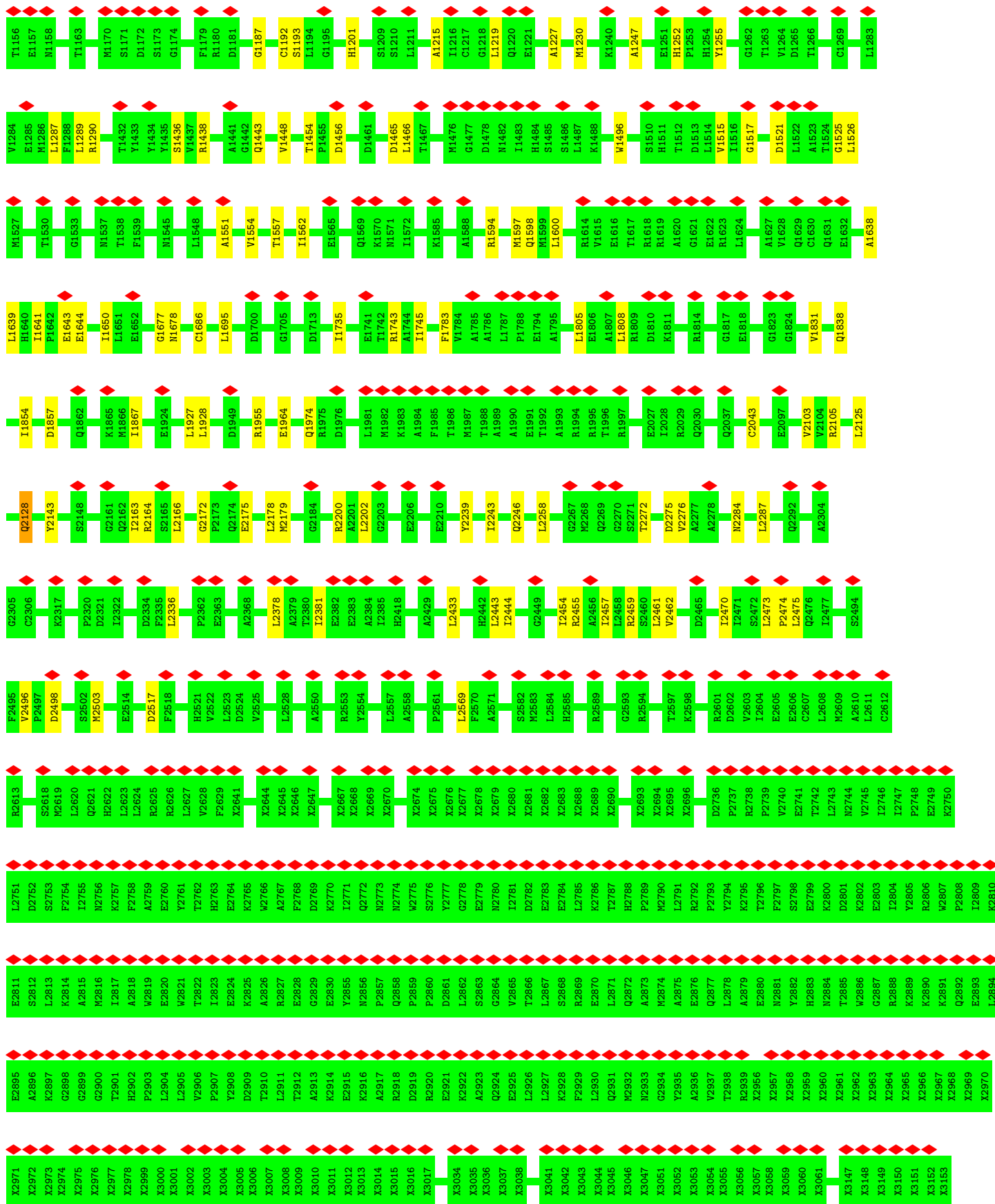

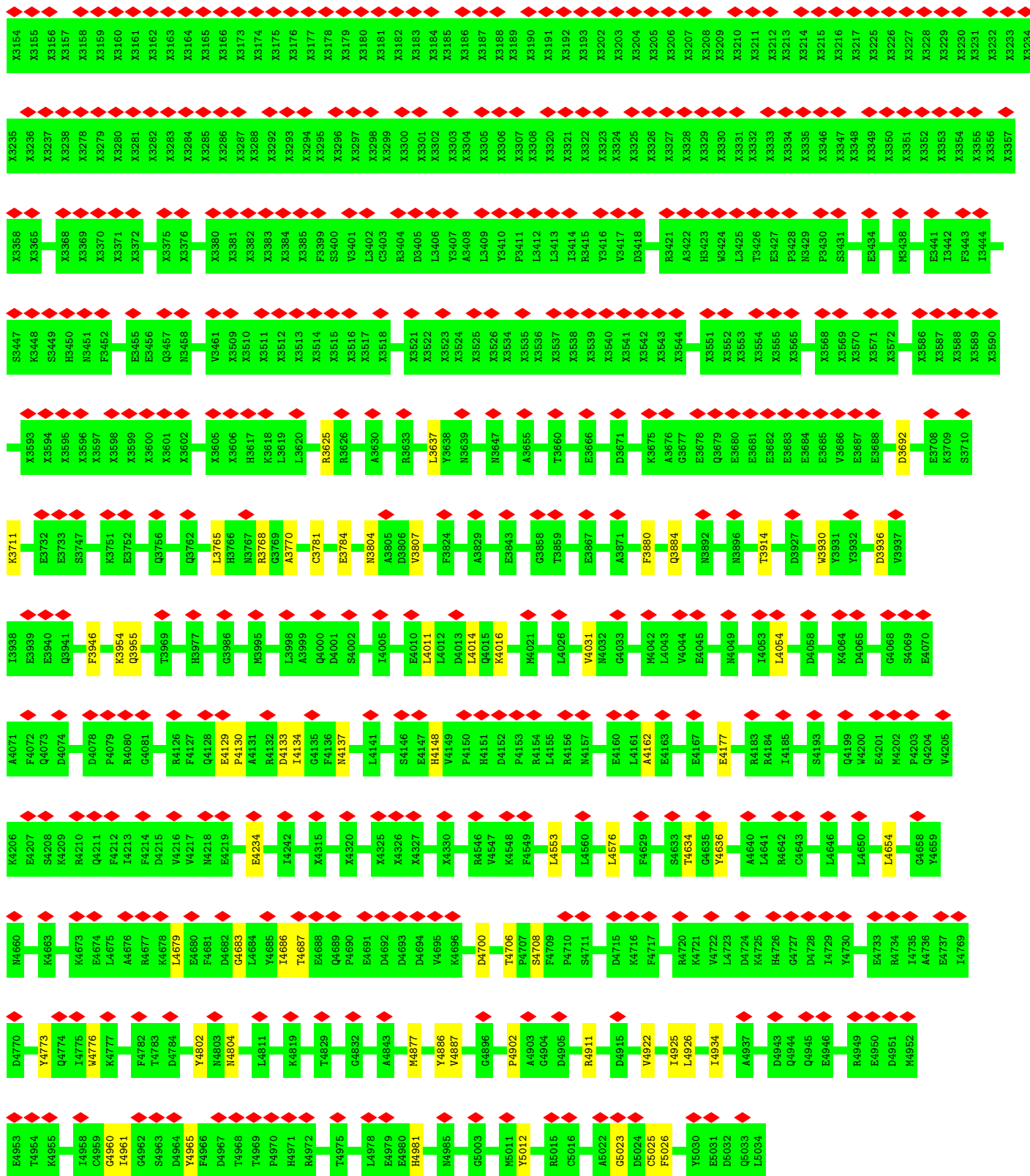

• Molecule 3: Calmodulin-1

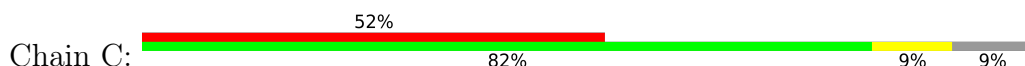

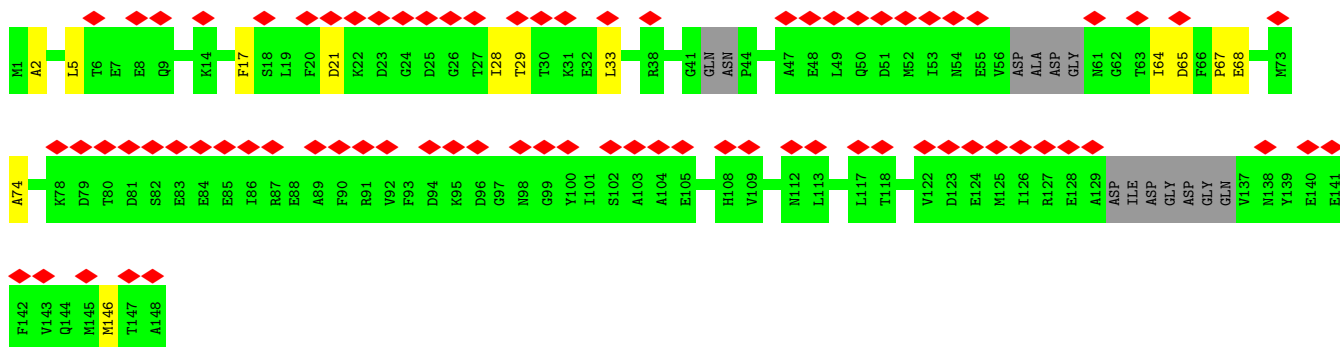

• Molecule 3: Calmodulin-1

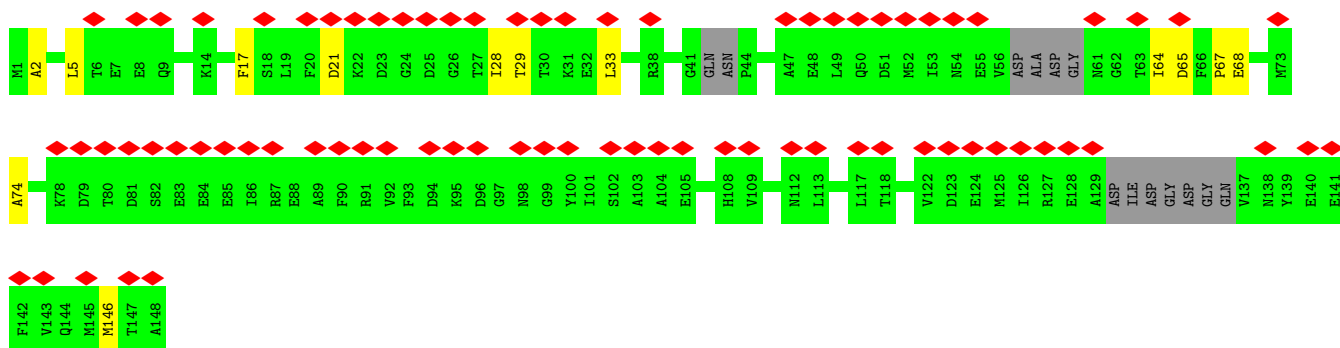
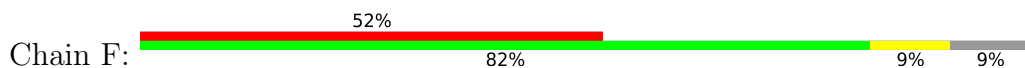

• Molecule 3: Calmodulin-1

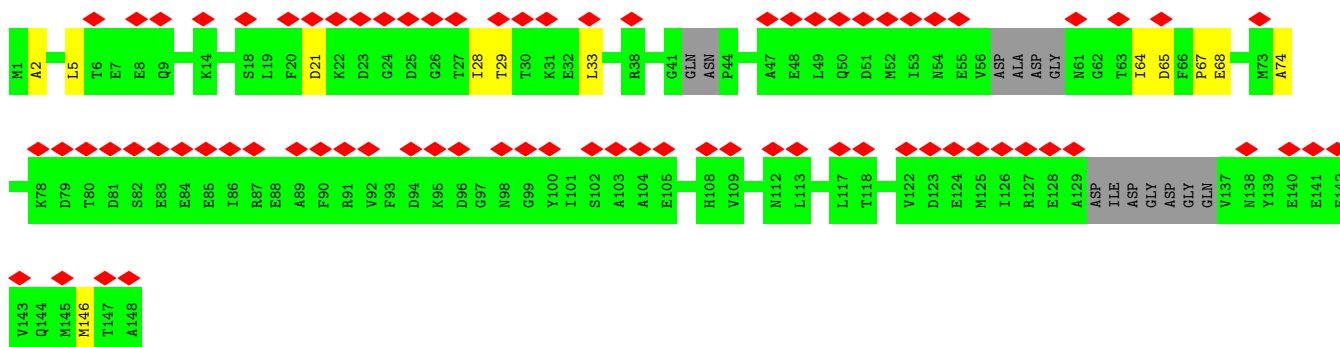
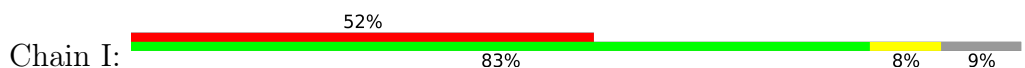

• Molecule 3: Calmodulin-1

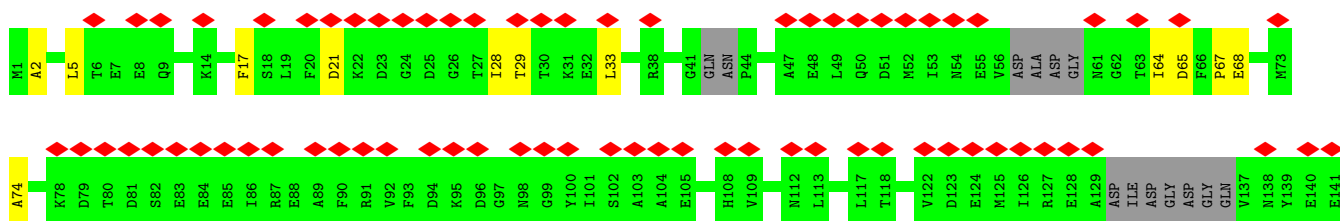
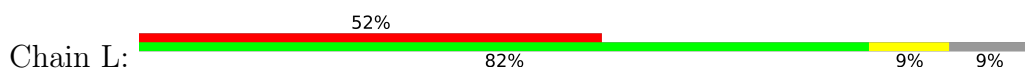

F142	V143	Q144	M145	M146	T147	A148
------	------	------	------	------	------	------

4 Experimental information

Property	Value	Source
EM reconstruction method	SINGLE PARTICLE	Depositor
Imposed symmetry	POINT, Not provided	
Number of particles used	25122	Depositor
Resolution determination method	FSC 0.143 CUT-OFF	Depositor
CTF correction method	NONE	Depositor
Microscope	FEI TITAN KRIOS	Depositor
Voltage (kV)	300	Depositor
Electron dose ($e^-/\text{\AA}^2$)	50	Depositor
Minimum defocus (nm)	Not provided	
Maximum defocus (nm)	Not provided	
Magnification	Not provided	
Image detector	FEI FALCON III (4k x 4k)	Depositor
Maximum map value	0.173	Depositor
Minimum map value	-0.136	Depositor
Average map value	-0.000	Depositor
Map value standard deviation	0.004	Depositor
Recommended contour level	0.022	Depositor
Map size (\AA)	523.2, 523.2, 523.2	wwPDB
Map dimensions	480, 480, 480	wwPDB
Map angles ($^\circ$)	90.0, 90.0, 90.0	wwPDB
Pixel spacing (\AA)	1.09, 1.09, 1.09	Depositor

5 Model quality [i](#)

5.1 Standard geometry [i](#)

Bond lengths and bond angles in the following residue types are not validated in this section:
ZN

The Z score for a bond length (or angle) is the number of standard deviations the observed value is removed from the expected value. A bond length (or angle) with $|Z| > 5$ is considered an outlier worth inspection. RMSZ is the root-mean-square of all Z scores of the bond lengths (or angles).

Mol	Chain	Bond lengths		Bond angles	
		RMSZ	# Z >5	RMSZ	# Z >5
1	A	0.25	0/743	0.42	0/1014
1	D	0.25	0/743	0.42	0/1014
1	G	0.25	0/743	0.42	0/1014
1	J	0.25	0/743	0.42	0/1014
2	B	0.23	0/25353	0.38	0/34606
2	E	0.23	0/25353	0.38	0/34606
2	H	0.23	0/25353	0.38	0/34606
2	K	0.23	0/25353	0.38	0/34606
3	C	0.24	0/772	0.36	0/1059
3	F	0.24	0/772	0.36	0/1059
3	I	0.24	0/772	0.36	0/1059
3	L	0.24	0/772	0.36	0/1059
All	All	0.23	0/107472	0.38	0/146716

There are no bond length outliers.

There are no bond angle outliers.

There are no chirality outliers.

There are no planarity outliers.

5.2 Too-close contacts [i](#)

In the following table, the Non-H and H(model) columns list the number of non-hydrogen atoms and hydrogen atoms in the chain respectively. The H(added) column lists the number of hydrogen atoms added and optimized by MolProbity. The Clashes column lists the number of clashes within the asymmetric unit, whereas Symm-Clashes lists symmetry-related clashes.

Mol	Chain	Non-H	H(model)	H(added)	Clashes	Symm-Clashes
1	A	727	0	651	8	0

Continued on next page...

Continued from previous page...

Mol	Chain	Non-H	H(model)	H(added)	Clashes	Symm-Clashes
1	D	727	0	651	8	0
1	G	727	0	651	8	0
1	J	727	0	651	8	0
2	B	26597	0	22867	156	0
2	E	26597	0	22867	153	0
2	H	26597	0	22867	157	0
2	K	26597	0	22867	157	0
3	C	768	0	486	9	0
3	F	768	0	486	9	0
3	I	768	0	486	8	0
3	L	768	0	486	9	0
4	B	1	0	0	0	0
4	E	1	0	0	0	0
4	H	1	0	0	0	0
4	K	1	0	0	0	0
All	All	112372	0	96016	654	0

The all-atom clashscore is defined as the number of clashes found per 1000 atoms (including hydrogen atoms). The all-atom clashscore for this structure is 3.

All (654) close contacts within the same asymmetric unit are listed below, sorted by their clash magnitude.

Atom-1	Atom-2	Interatomic distance (Å)	Clash overlap (Å)
2:E:886:ARG:HB2	2:E:891:TRP:HB2	1.73	0.71
2:B:886:ARG:HB2	2:B:891:TRP:HB2	1.73	0.71
2:H:886:ARG:HB2	2:H:891:TRP:HB2	1.73	0.71
2:K:886:ARG:HB2	2:K:891:TRP:HB2	1.73	0.71
2:E:4706:THR:HG21	2:E:4773:TYR:HB2	1.74	0.70
2:H:4706:THR:HG21	2:H:4773:TYR:HB2	1.74	0.69
2:K:1101:ARG:HB2	2:K:1193:SER:HB2	1.74	0.69
2:H:1101:ARG:HB2	2:H:1193:SER:HB2	1.74	0.69
2:K:4706:THR:HG21	2:K:4773:TYR:HB2	1.74	0.69
2:B:4706:THR:HG21	2:B:4773:TYR:HB2	1.74	0.69
2:B:1101:ARG:HB2	2:B:1193:SER:HB2	1.74	0.68
2:B:1082:ALA:HB1	2:B:1187:GLY:HA3	1.76	0.68
2:E:1082:ALA:HB1	2:E:1187:GLY:HA3	1.76	0.68
2:E:1101:ARG:HB2	2:E:1193:SER:HB2	1.74	0.67
2:H:1082:ALA:HB1	2:H:1187:GLY:HA3	1.76	0.67
2:K:1082:ALA:HB1	2:K:1187:GLY:HA3	1.76	0.66
2:E:3781:CYS:HB2	2:E:3784:GLU:HB3	1.78	0.66
2:B:3781:CYS:HB2	2:B:3784:GLU:HB3	1.78	0.65

Continued on next page...

Continued from previous page...

Atom-1	Atom-2	Interatomic distance (Å)	Clash overlap (Å)
2:K:4960:GLY:HA3	2:K:5023:GLY:H	1.61	0.65
2:K:3781:CYS:HB2	2:K:3784:GLU:HB3	1.78	0.65
2:E:4960:GLY:HA3	2:E:5023:GLY:H	1.61	0.65
2:H:4960:GLY:HA3	2:H:5023:GLY:H	1.61	0.65
2:B:4960:GLY:HA3	2:B:5023:GLY:H	1.61	0.65
2:E:4902:PRO:HB3	2:E:4911:ARG:HG2	1.79	0.64
2:H:3781:CYS:HB2	2:H:3784:GLU:HB3	1.78	0.64
2:K:4902:PRO:HB3	2:K:4911:ARG:HG2	1.79	0.64
2:B:4902:PRO:HB3	2:B:4911:ARG:HG2	1.79	0.64
2:B:833:GLY:HA3	2:B:838:HIS:HD2	1.63	0.64
2:E:833:GLY:HA3	2:E:838:HIS:HD2	1.63	0.63
2:H:4902:PRO:HB3	2:H:4911:ARG:HG2	1.79	0.63
2:K:833:GLY:HA3	2:K:838:HIS:HD2	1.63	0.63
2:H:833:GLY:HA3	2:H:838:HIS:HD2	1.63	0.62
2:K:294:ILE:HG23	2:K:296:ASP:H	1.67	0.60
2:B:294:ILE:HG23	2:B:296:ASP:H	1.67	0.60
2:E:176:SER:HB2	2:E:178:ARG:HH21	1.67	0.60
2:E:2496:VAL:HG12	2:E:2498:ASP:H	1.67	0.60
2:H:2496:VAL:HG12	2:H:2498:ASP:H	1.67	0.60
2:E:294:ILE:HG23	2:E:296:ASP:H	1.67	0.60
2:B:176:SER:HB2	2:B:178:ARG:HH21	1.67	0.60
2:H:294:ILE:HG23	2:H:296:ASP:H	1.67	0.59
2:K:2496:VAL:HG12	2:K:2498:ASP:H	1.67	0.59
2:E:793:LEU:HD12	2:E:797:HIS:HB2	1.84	0.59
2:H:793:LEU:HD12	2:H:797:HIS:HB2	1.84	0.59
2:H:176:SER:HB2	2:H:178:ARG:HH21	1.67	0.59
2:K:176:SER:HB2	2:K:178:ARG:HH21	1.67	0.59
2:B:793:LEU:HD12	2:B:797:HIS:HB2	1.84	0.58
2:B:1974:GLN:HG2	2:B:3637:LEU:HB3	1.86	0.58
2:B:2496:VAL:HG12	2:B:2498:ASP:H	1.67	0.58
2:E:1974:GLN:HG2	2:E:3637:LEU:HB3	1.86	0.58
2:E:3946:PHE:HE2	2:E:4011:LEU:HD21	1.69	0.58
2:K:523:TYR:OH	2:K:553:ARG:NH1	2.37	0.58
2:B:3946:PHE:HE2	2:B:4011:LEU:HD21	1.69	0.57
2:H:523:TYR:OH	2:H:553:ARG:NH1	2.37	0.57
2:K:793:LEU:HD12	2:K:797:HIS:HB2	1.84	0.57
2:B:523:TYR:OH	2:B:553:ARG:NH1	2.37	0.57
2:E:523:TYR:OH	2:E:553:ARG:NH1	2.37	0.57
2:B:568:LEU:HD13	2:B:606:LEU:HD21	1.87	0.57
2:H:568:LEU:HD13	2:H:606:LEU:HD21	1.87	0.57
2:K:3765:LEU:HB3	2:K:3770:ALA:HB3	1.86	0.57

Continued on next page...

Continued from previous page...

Atom-1	Atom-2	Interatomic distance (Å)	Clash overlap (Å)
2:K:1521:ASP:HB3	2:K:1525:GLY:HA3	1.87	0.57
2:B:1521:ASP:HB3	2:B:1525:GLY:HA3	1.87	0.57
2:E:568:LEU:HD13	2:E:606:LEU:HD21	1.87	0.57
2:H:3946:PHE:HE2	2:H:4011:LEU:HD21	1.69	0.57
2:B:24:CYS:SG	2:B:25:ASN:N	2.78	0.57
2:B:4922:VAL:HA	2:B:4926:LEU:HB3	1.87	0.57
2:H:1521:ASP:HB3	2:H:1525:GLY:HA3	1.87	0.57
2:B:4934:ILE:HG21	2:E:4925:ILE:HG23	1.87	0.56
2:H:3765:LEU:HB3	2:H:3770:ALA:HB3	1.86	0.56
2:K:568:LEU:HD13	2:K:606:LEU:HD21	1.87	0.56
2:K:3946:PHE:HE2	2:K:4011:LEU:HD21	1.69	0.56
2:E:4934:ILE:HG21	2:H:4925:ILE:HG23	1.87	0.56
2:H:1974:GLN:HG2	2:H:3637:LEU:HB3	1.86	0.56
2:K:24:CYS:SG	2:K:25:ASN:N	2.78	0.56
2:K:2470:ILE:HG21	2:K:2503:MET:HG3	1.88	0.56
2:K:4922:VAL:HA	2:K:4926:LEU:HB3	1.87	0.56
1:D:88:PRO:HB3	2:E:623:GLU:HG2	1.88	0.56
2:E:24:CYS:SG	2:E:25:ASN:N	2.78	0.56
2:K:1974:GLN:HG2	2:K:3637:LEU:HB3	1.86	0.56
2:E:2164:ARG:NH2	2:E:2202:LEU:O	2.39	0.56
2:H:4922:VAL:HA	2:H:4926:LEU:HB3	1.87	0.56
2:E:4922:VAL:HA	2:E:4926:LEU:HB3	1.87	0.56
2:K:3692:ASP:OD2	2:K:3768:ARG:NH2	2.39	0.56
2:B:2164:ARG:NH2	2:B:2202:LEU:O	2.39	0.56
2:E:233:ILE:O	2:E:257:ARG:NH1	2.39	0.56
1:A:88:PRO:HB3	2:B:623:GLU:HG2	1.88	0.56
1:G:88:PRO:HB3	2:H:623:GLU:HG2	1.88	0.56
2:H:3692:ASP:OD2	2:H:3768:ARG:NH2	2.39	0.56
2:K:2164:ARG:NH2	2:K:2202:LEU:O	2.39	0.56
2:B:2470:ILE:HG21	2:B:2503:MET:HG3	1.88	0.56
2:E:2470:ILE:HG21	2:E:2503:MET:HG3	1.88	0.56
2:H:233:ILE:O	2:H:257:ARG:NH1	2.39	0.56
2:H:4576:LEU:HA	2:K:4877:MET:HG2	1.88	0.56
2:K:233:ILE:O	2:K:257:ARG:NH1	2.39	0.56
2:H:2470:ILE:HG21	2:H:2503:MET:HG3	1.88	0.56
2:B:3765:LEU:HB3	2:B:3770:ALA:HB3	1.86	0.56
2:B:4877:MET:HG2	2:K:4576:LEU:HA	1.88	0.56
2:E:3692:ASP:OD2	2:E:3768:ARG:NH2	2.39	0.56
2:H:4934:ILE:HG21	2:K:4925:ILE:HG23	1.87	0.56
2:E:1215:ALA:HA	2:E:1219:LEU:HB2	1.88	0.55
2:E:3765:LEU:HB3	2:E:3770:ALA:HB3	1.86	0.55

Continued on next page...

Continued from previous page...

Atom-1	Atom-2	Interatomic distance (Å)	Clash overlap (Å)
2:H:24:CYS:SG	2:H:25:ASN:N	2.78	0.55
2:B:233:ILE:O	2:B:257:ARG:NH1	2.39	0.55
2:B:618:GLN:OE1	2:B:1678:ASN:ND2	2.39	0.55
2:E:1521:ASP:HB3	2:E:1525:GLY:HA3	1.87	0.55
2:K:618:GLN:OE1	2:K:1678:ASN:ND2	2.39	0.55
2:K:1215:ALA:HA	2:K:1219:LEU:HB2	1.88	0.55
2:B:1215:ALA:HA	2:B:1219:LEU:HB2	1.88	0.55
2:H:1215:ALA:HA	2:H:1219:LEU:HB2	1.88	0.55
2:K:4706:THR:HG22	2:K:4708:SER:H	1.71	0.55
2:B:3692:ASP:OD2	2:B:3768:ARG:NH2	2.39	0.55
2:B:4925:ILE:HG23	2:K:4934:ILE:HG21	1.87	0.55
2:H:2164:ARG:NH2	2:H:2202:LEU:O	2.39	0.55
2:B:4961:ILE:HD11	2:B:4965:TYR:HB2	1.89	0.55
2:E:2443:LEU:HD12	2:E:2444:ILE:HG13	1.89	0.55
2:K:4961:ILE:HD11	2:K:4965:TYR:HB2	1.89	0.55
2:B:842:PRO:HD3	2:B:1073:ARG:HG2	1.89	0.55
2:E:4961:ILE:HD11	2:E:4965:TYR:HB2	1.89	0.54
2:E:5025:CYS:SG	2:E:5026:PHE:N	2.80	0.54
2:H:618:GLN:OE1	2:H:1678:ASN:ND2	2.39	0.54
1:J:88:PRO:HB3	2:K:623:GLU:HG2	1.88	0.54
2:K:842:PRO:HD3	2:K:1073:ARG:HG2	1.89	0.54
2:B:1928:LEU:O	2:B:2105:ARG:NH2	2.41	0.54
2:B:4576:LEU:HA	2:E:4877:MET:HG2	1.88	0.54
2:E:618:GLN:OE1	2:E:1678:ASN:ND2	2.39	0.54
2:B:4706:THR:HG22	2:B:4708:SER:H	1.71	0.54
2:E:842:PRO:HD3	2:E:1073:ARG:HG2	1.89	0.54
2:E:4706:THR:HG22	2:E:4708:SER:H	1.71	0.54
2:H:1928:LEU:O	2:H:2105:ARG:NH2	2.41	0.54
2:H:4961:ILE:HD11	2:H:4965:TYR:HB2	1.89	0.54
2:K:1928:LEU:O	2:K:2105:ARG:NH2	2.41	0.54
2:E:4576:LEU:HA	2:H:4877:MET:HG2	1.88	0.54
2:H:5025:CYS:SG	2:H:5026:PHE:N	2.80	0.54
2:B:2443:LEU:HD12	2:B:2444:ILE:HG13	1.89	0.54
2:B:5025:CYS:SG	2:B:5026:PHE:N	2.80	0.54
2:H:4706:THR:HG22	2:H:4708:SER:H	1.71	0.54
2:K:5025:CYS:SG	2:K:5026:PHE:N	2.80	0.54
2:E:793:LEU:H	2:E:798:GLY:HA3	1.73	0.53
2:B:3711:LYS:NZ	2:B:3784:GLU:OE2	2.39	0.53
2:E:1928:LEU:O	2:E:2105:ARG:NH2	2.41	0.53
2:H:622:THR:HG23	2:H:626:LEU:HD22	1.90	0.53
2:H:842:PRO:HD3	2:H:1073:ARG:HG2	1.89	0.53

Continued on next page...

Continued from previous page...

Atom-1	Atom-2	Interatomic distance (Å)	Clash overlap (Å)
1:J:74:LEU:HD22	1:J:101:VAL:HG21	1.91	0.53
2:B:793:LEU:H	2:B:798:GLY:HA3	1.73	0.53
1:G:74:LEU:HD22	1:G:101:VAL:HG21	1.91	0.53
2:K:2443:LEU:HD12	2:K:2444:ILE:HG13	1.89	0.53
2:K:472:ARG:NH1	2:K:532:GLY:O	2.42	0.53
2:K:547:LEU:HD22	2:K:564:LEU:HD13	1.91	0.53
2:E:622:THR:HG23	2:E:626:LEU:HD22	1.90	0.53
2:H:638:ILE:HD13	2:H:703:GLY:HA2	1.91	0.53
3:L:29:THR:O	3:L:33:LEU:N	2.40	0.53
2:B:472:ARG:NH1	2:B:532:GLY:O	2.42	0.52
2:B:547:LEU:HD22	2:B:564:LEU:HD13	1.91	0.52
2:B:2336:LEU:HB2	2:B:2433:LEU:HD11	1.91	0.52
2:H:1466:LEU:HD23	2:H:1496:TRP:HE3	1.74	0.52
2:K:1466:LEU:HD23	2:K:1496:TRP:HE3	1.74	0.52
1:A:74:LEU:HD22	1:A:101:VAL:HG21	1.91	0.52
2:E:638:ILE:HD13	2:E:703:GLY:HA2	1.91	0.52
2:H:472:ARG:NH1	2:H:532:GLY:O	2.42	0.52
2:K:1955:ARG:NH1	2:K:2043:CYS:SG	2.82	0.52
2:B:1436:SER:HA	2:B:1517:GLY:HA2	1.92	0.52
1:D:35:LYS:HD3	1:D:38:SER:HB2	1.91	0.52
2:H:793:LEU:H	2:H:798:GLY:HA3	1.73	0.52
2:K:793:LEU:H	2:K:798:GLY:HA3	1.73	0.52
2:K:1594:ARG:NH1	2:K:1643:GLU:OE2	2.42	0.52
1:A:35:LYS:HD3	1:A:38:SER:HB2	1.91	0.52
2:B:622:THR:HG23	2:B:626:LEU:HD22	1.90	0.52
2:B:1594:ARG:NH1	2:B:1643:GLU:OE2	2.42	0.52
1:D:74:LEU:HD22	1:D:101:VAL:HG21	1.91	0.52
2:H:2336:LEU:HB2	2:H:2433:LEU:HD11	1.91	0.52
2:H:4133:ASP:O	2:H:4137:ASN:ND2	2.41	0.52
2:B:4054:LEU:HD13	2:B:4162:ALA:HB2	1.92	0.52
2:E:1955:ARG:NH1	2:E:2043:CYS:SG	2.82	0.52
2:H:1594:ARG:NH1	2:H:1643:GLU:OE2	2.42	0.52
2:H:1955:ARG:NH1	2:H:2043:CYS:SG	2.82	0.52
2:B:1955:ARG:NH1	2:B:2043:CYS:SG	2.82	0.52
2:E:1594:ARG:NH1	2:E:1643:GLU:OE2	2.42	0.52
2:H:2443:LEU:HD12	2:H:2444:ILE:HG13	1.89	0.52
2:K:2166:LEU:HG	2:K:2178:LEU:HD22	1.92	0.52
2:B:168:ASP:OD1	2:B:168:ASP:N	2.43	0.52
2:E:4054:LEU:HD13	2:E:4162:ALA:HB2	1.92	0.52
2:H:4054:LEU:HD13	2:H:4162:ALA:HB2	1.92	0.52
2:K:1436:SER:HA	2:K:1517:GLY:HA2	1.92	0.52

Continued on next page...

Continued from previous page...

Atom-1	Atom-2	Interatomic distance (Å)	Clash overlap (Å)
2:K:622:THR:HG23	2:K:626:LEU:HD22	1.90	0.52
2:E:472:ARG:NH1	2:E:532:GLY:O	2.42	0.52
2:E:547:LEU:HD22	2:E:564:LEU:HD13	1.91	0.52
2:H:547:LEU:HD22	2:H:564:LEU:HD13	1.91	0.52
2:B:638:ILE:HD13	2:B:703:GLY:HA2	1.91	0.52
2:B:4133:ASP:O	2:B:4137:ASN:ND2	2.41	0.52
2:E:2336:LEU:HB2	2:E:2433:LEU:HD11	1.91	0.52
1:J:35:LYS:HD3	1:J:38:SER:HB2	1.91	0.51
2:B:1466:LEU:HD23	2:B:1496:TRP:HE3	1.74	0.51
2:E:1466:LEU:HD23	2:E:1496:TRP:HE3	1.74	0.51
2:H:1436:SER:HA	2:H:1517:GLY:HA2	1.92	0.51
2:K:4133:ASP:O	2:K:4137:ASN:ND2	2.41	0.51
2:H:2166:LEU:HG	2:H:2178:LEU:HD22	1.92	0.51
2:K:2336:LEU:HB2	2:K:2433:LEU:HD11	1.91	0.51
1:G:35:LYS:HD3	1:G:38:SER:HB2	1.91	0.51
3:I:29:THR:O	3:I:33:LEU:N	2.40	0.51
2:K:168:ASP:OD1	2:K:168:ASP:N	2.43	0.51
2:K:3711:LYS:NZ	2:K:3784:GLU:OE2	2.39	0.51
2:E:4177:GLU:CB	2:E:4981:HIS:HE1	2.23	0.51
2:K:638:ILE:HD13	2:K:703:GLY:HA2	1.91	0.51
3:F:29:THR:O	3:F:33:LEU:N	2.40	0.51
2:B:2166:LEU:HG	2:B:2178:LEU:HD22	1.92	0.51
2:H:4177:GLU:CB	2:H:4981:HIS:HE1	2.24	0.51
2:E:1438:ARG:HG2	2:E:1515:VAL:HG12	1.93	0.51
2:K:1289:LEU:HD12	2:K:1562:ILE:HD11	1.93	0.51
2:K:4054:LEU:HD13	2:K:4162:ALA:HB2	1.92	0.51
2:E:4133:ASP:O	2:E:4137:ASN:ND2	2.41	0.51
2:K:1438:ARG:HG2	2:K:1515:VAL:HG12	1.93	0.51
2:B:1289:LEU:HD12	2:B:1562:ILE:HD11	1.93	0.50
2:H:168:ASP:OD1	2:H:168:ASP:N	2.43	0.50
2:B:1597:MET:SD	2:B:1597:MET:N	2.85	0.50
2:E:1436:SER:HA	2:E:1517:GLY:HA2	1.92	0.50
2:E:3711:LYS:NZ	2:E:3784:GLU:OE2	2.39	0.50
3:C:29:THR:O	3:C:33:LEU:N	2.40	0.50
2:E:1831:VAL:HB	2:E:1838:GLN:HG3	1.94	0.50
2:H:1438:ARG:HG2	2:H:1515:VAL:HG12	1.93	0.50
2:K:1597:MET:SD	2:K:1597:MET:N	2.85	0.50
2:B:308:HIS:CD2	2:B:311:ALA:H	2.30	0.50
2:B:2473:LEU:HD12	2:B:2474:PRO:HD2	1.94	0.50
2:E:308:HIS:CD2	2:E:311:ALA:H	2.30	0.50
2:H:1831:VAL:HB	2:H:1838:GLN:HG3	1.94	0.50

Continued on next page...

Continued from previous page...

Atom-1	Atom-2	Interatomic distance (Å)	Clash overlap (Å)
2:K:308:HIS:CD2	2:K:311:ALA:H	2.30	0.50
2:B:1438:ARG:HG2	2:B:1515:VAL:HG12	1.93	0.50
2:E:2166:LEU:HG	2:E:2178:LEU:HD22	1.92	0.50
2:H:1597:MET:SD	2:H:1597:MET:N	2.85	0.50
2:K:3884:GLN:OE1	2:K:3955:GLN:NE2	2.45	0.50
2:E:161:GLU:OE2	2:E:164:ARG:NH2	2.45	0.50
2:E:2473:LEU:HD12	2:E:2474:PRO:HD2	1.94	0.50
2:H:308:HIS:CD2	2:H:311:ALA:H	2.30	0.50
2:H:2200:ARG:NH2	2:H:2246:GLN:OE1	2.45	0.50
2:K:1831:VAL:HB	2:K:1838:GLN:HG3	1.94	0.50
2:K:4679:LEU:HD12	2:K:4683:GLY:HA2	1.94	0.50
2:B:3884:GLN:OE1	2:B:3955:GLN:NE2	2.45	0.50
2:E:1597:MET:SD	2:E:1597:MET:N	2.85	0.50
2:H:1289:LEU:HD12	2:H:1562:ILE:HD11	1.93	0.50
2:H:4679:LEU:HD12	2:H:4683:GLY:HA2	1.94	0.50
2:B:1743:ARG:NH1	2:B:1964:GLU:OE2	2.44	0.50
2:K:161:GLU:OE2	2:K:164:ARG:NH2	2.45	0.50
2:H:4686:ILE:HG22	2:H:4687:THR:HG23	1.94	0.49
2:E:1289:LEU:HD12	2:E:1562:ILE:HD11	1.93	0.49
2:H:3884:GLN:OE1	2:H:3955:GLN:NE2	2.45	0.49
2:K:2200:ARG:NH2	2:K:2246:GLN:OE1	2.45	0.49
2:K:4686:ILE:HG22	2:K:4687:THR:HG23	1.94	0.49
2:E:3884:GLN:OE1	2:E:3955:GLN:NE2	2.45	0.49
2:B:1735:ILE:HG22	2:B:2143:TYR:HB3	1.95	0.49
2:B:1831:VAL:HB	2:B:1838:GLN:HG3	1.94	0.49
2:K:1695:LEU:HD11	2:K:1808:LEU:HD11	1.95	0.49
2:E:2200:ARG:NH2	2:E:2246:GLN:OE1	2.45	0.49
1:G:90:VAL:HG23	1:G:91:ILE:HG12	1.95	0.49
2:H:1695:LEU:HD11	2:H:1808:LEU:HD11	1.95	0.49
2:H:2473:LEU:HD12	2:H:2474:PRO:HD2	1.94	0.49
2:B:161:GLU:OE2	2:B:164:ARG:NH2	2.45	0.49
2:B:1290:ARG:HG3	2:B:1551:ALA:HB2	1.95	0.49
2:E:1695:LEU:HD11	2:E:1808:LEU:HD11	1.95	0.49
2:H:1743:ARG:NH1	2:H:1964:GLU:OE2	2.44	0.49
2:B:4679:LEU:HD12	2:B:4683:GLY:HA2	1.94	0.49
2:E:4679:LEU:HD12	2:E:4683:GLY:HA2	1.94	0.49
2:H:649:PHE:HB3	2:H:776:LEU:HD13	1.95	0.49
1:A:90:VAL:HG23	1:A:91:ILE:HG12	1.95	0.48
2:B:649:PHE:HB3	2:B:776:LEU:HD13	1.95	0.48
2:K:2473:LEU:HD12	2:K:2474:PRO:HD2	1.94	0.48
2:B:1075:PHE:HB2	2:B:1192:CYS:HB3	1.95	0.48

Continued on next page...

Continued from previous page...

Atom-1	Atom-2	Interatomic distance (Å)	Clash overlap (Å)
2:E:2517:ASP:HA	2:E:2569:LEU:HD21	1.95	0.48
2:K:649:PHE:HB3	2:K:776:LEU:HD13	1.95	0.48
2:K:1290:ARG:HG3	2:K:1551:ALA:HB2	1.95	0.48
2:K:1735:ILE:HG22	2:K:2143:TYR:HB3	1.95	0.48
2:K:2163:ILE:HD11	2:K:2179:MET:HG3	1.95	0.48
2:B:2200:ARG:NH2	2:B:2246:GLN:OE1	2.45	0.48
2:E:350:HIS:HB3	2:E:354:GLY:H	1.79	0.48
2:E:1075:PHE:HB2	2:E:1192:CYS:HB3	1.95	0.48
2:E:1735:ILE:HG22	2:E:2143:TYR:HB3	1.95	0.48
2:H:2517:ASP:HA	2:H:2569:LEU:HD21	1.95	0.48
2:B:1093:GLU:HB3	2:B:1201:HIS:HB3	1.95	0.48
2:B:1695:LEU:HD11	2:B:1808:LEU:HD11	1.95	0.48
2:B:2103:VAL:HG11	2:B:2125:LEU:HD13	1.95	0.48
2:B:4686:ILE:HG22	2:B:4687:THR:HG23	1.94	0.48
2:E:4686:ILE:HG22	2:E:4687:THR:HG23	1.94	0.48
2:H:3711:LYS:NZ	2:H:3784:GLU:OE2	2.39	0.48
2:B:4802:TYR:CE2	2:B:4804:ASN:HB2	2.49	0.48
2:E:649:PHE:HB3	2:E:776:LEU:HD13	1.95	0.48
2:H:884:LEU:HD11	2:H:969:PRO:HA	1.95	0.48
2:B:2163:ILE:HD11	2:B:2179:MET:HG3	1.95	0.48
1:D:90:VAL:HG23	1:D:91:ILE:HG12	1.95	0.48
2:H:1735:ILE:HG22	2:H:2143:TYR:HB3	1.95	0.48
2:K:4802:TYR:CE2	2:K:4804:ASN:HB2	2.49	0.48
2:B:4234:GLU:OE2	2:B:5012:TYR:OH	2.30	0.48
2:E:2163:ILE:HD11	2:E:2179:MET:HG3	1.95	0.48
2:H:1093:GLU:HB3	2:H:1201:HIS:HB3	1.95	0.48
2:H:2103:VAL:HG11	2:H:2125:LEU:HD13	1.95	0.48
2:B:530:ILE:HG21	2:B:567:VAL:HG12	1.96	0.48
1:D:4:ILE:HD13	1:D:65:GLN:HG2	1.96	0.48
2:K:2517:ASP:HA	2:K:2569:LEU:HD21	1.95	0.48
1:D:78:PRO:HG3	1:D:96:THR:HA	1.96	0.48
2:H:350:HIS:HB3	2:H:354:GLY:H	1.79	0.48
2:K:350:HIS:HB3	2:K:354:GLY:H	1.79	0.48
2:K:530:ILE:HG21	2:K:567:VAL:HG12	1.96	0.48
1:A:78:PRO:HG3	1:A:96:THR:HA	1.96	0.47
2:E:1454:THR:HG22	2:E:1456:ASP:H	1.79	0.47
2:H:161:GLU:OE2	2:H:164:ARG:NH2	2.45	0.47
2:H:1290:ARG:HG3	2:H:1551:ALA:HB2	1.95	0.47
2:H:3834:CYS:HG	2:H:3917:TYR:HH	1.60	0.47
1:J:90:VAL:HG23	1:J:91:ILE:HG12	1.95	0.47
2:B:1643:GLU:HG3	2:B:1644:GLU:HG3	1.96	0.47

Continued on next page...

Continued from previous page...

Atom-1	Atom-2	Interatomic distance (Å)	Clash overlap (Å)
2:K:1454:THR:HG22	2:K:1456:ASP:H	1.79	0.47
2:K:3880:PHE:HE1	2:K:3914:THR:HG23	1.79	0.47
2:B:2517:ASP:HA	2:B:2569:LEU:HD21	1.95	0.47
2:E:168:ASP:N	2:E:168:ASP:OD1	2.43	0.47
2:E:2103:VAL:HG11	2:E:2125:LEU:HD13	1.95	0.47
2:K:2103:VAL:HG11	2:K:2125:LEU:HD13	1.95	0.47
2:B:350:HIS:HB3	2:B:354:GLY:H	1.79	0.47
2:B:1454:THR:HG22	2:B:1456:ASP:H	1.79	0.47
2:B:4886:TYR:HD2	2:B:4887:VAL:HG13	1.80	0.47
2:E:3880:PHE:HE1	2:E:3914:THR:HG23	1.79	0.47
2:H:530:ILE:HG21	2:H:567:VAL:HG12	1.96	0.47
1:J:78:PRO:HG3	1:J:96:THR:HA	1.96	0.47
2:B:884:LEU:HD11	2:B:969:PRO:HA	1.95	0.47
2:E:1290:ARG:HG3	2:E:1551:ALA:HB2	1.95	0.47
2:H:676:THR:OG1	2:H:677:ALA:N	2.46	0.47
2:H:3880:PHE:HE1	2:H:3914:THR:HG23	1.79	0.47
2:K:884:LEU:HD11	2:K:969:PRO:HA	1.95	0.47
1:A:4:ILE:HD13	1:A:65:GLN:HG2	1.96	0.47
2:B:3880:PHE:HE1	2:B:3914:THR:HG23	1.79	0.47
2:K:676:THR:OG1	2:K:677:ALA:N	2.46	0.47
2:E:530:ILE:HG21	2:E:567:VAL:HG12	1.96	0.47
2:E:676:THR:OG1	2:E:677:ALA:N	2.46	0.47
2:E:884:LEU:HD11	2:E:969:PRO:HA	1.95	0.47
2:E:1093:GLU:HB3	2:E:1201:HIS:HB3	1.95	0.47
1:G:78:PRO:HG3	1:G:96:THR:HA	1.96	0.47
2:H:2163:ILE:HD11	2:H:2179:MET:HG3	1.95	0.47
2:H:4802:TYR:CE2	2:H:4804:ASN:HB2	2.49	0.47
2:K:1075:PHE:HB2	2:K:1192:CYS:HB3	1.95	0.47
2:K:1093:GLU:HB3	2:K:1201:HIS:HB3	1.95	0.47
2:K:1643:GLU:HG3	2:K:1644:GLU:HG3	1.96	0.47
2:K:4234:GLU:OE2	2:K:5012:TYR:OH	2.30	0.47
2:K:4886:TYR:HD2	2:K:4887:VAL:HG13	1.80	0.47
2:B:2239:TYR:OH	3:C:68:GLU:OE2	2.33	0.47
2:E:746:CYS:HA	2:E:757:PHE:HA	1.97	0.47
2:E:2454:ILE:HA	2:E:2457:ILE:HD12	1.96	0.47
2:H:616:SER:O	2:H:620:LEU:HD13	2.15	0.47
2:H:1075:PHE:HB2	2:H:1192:CYS:HB3	1.95	0.47
2:H:4886:TYR:HD2	2:H:4887:VAL:HG13	1.80	0.47
2:E:4802:TYR:CE2	2:E:4804:ASN:HB2	2.49	0.47
2:K:616:SER:O	2:K:620:LEU:HD13	2.15	0.47
2:K:2454:ILE:HA	2:K:2457:ILE:HD12	1.96	0.47

Continued on next page...

Continued from previous page...

Atom-1	Atom-2	Interatomic distance (Å)	Clash overlap (Å)
2:H:1454:THR:HG22	2:H:1456:ASP:H	1.79	0.47
2:H:2454:ILE:HA	2:H:2457:ILE:HD12	1.96	0.47
2:B:529:LEU:O	2:B:536:ASN:ND2	2.48	0.46
2:E:1643:GLU:HG3	2:E:1644:GLU:HG3	1.96	0.46
2:H:1443:GLN:HA	2:H:1557:THR:HG21	1.97	0.46
1:J:4:ILE:HD13	1:J:65:GLN:HG2	1.96	0.46
2:E:1641:ILE:HG22	2:E:1643:GLU:HG2	1.98	0.46
2:H:529:LEU:O	2:H:536:ASN:ND2	2.48	0.46
1:J:74:LEU:HD13	1:J:101:VAL:HB	1.97	0.46
2:K:1743:ARG:NH1	2:K:1964:GLU:OE2	2.44	0.46
2:E:616:SER:O	2:E:620:LEU:HD13	2.15	0.46
2:E:1130:GLN:HG3	2:E:1138:LEU:HA	1.98	0.46
2:E:2461:LEU:HD12	2:E:2462:VAL:HG23	1.97	0.46
2:E:4886:TYR:HD2	2:E:4887:VAL:HG13	1.80	0.46
2:B:746:CYS:HA	2:B:757:PHE:HA	1.97	0.46
2:H:1641:ILE:HG22	2:H:1643:GLU:HG2	1.98	0.46
2:K:529:LEU:O	2:K:536:ASN:ND2	2.48	0.46
2:B:616:SER:O	2:B:620:LEU:HD13	2.15	0.46
2:B:2128:GLN:HE21	2:B:2128:GLN:HA	1.80	0.46
2:B:2461:LEU:HD12	2:B:2462:VAL:HG23	1.97	0.46
2:E:892:THR:N	2:E:902:ARG:O	2.48	0.46
2:H:1643:GLU:HG3	2:H:1644:GLU:HG3	1.96	0.46
2:H:2461:LEU:HD12	2:H:2462:VAL:HG23	1.97	0.46
2:B:215:THR:OG1	2:B:271:GLY:O	2.34	0.46
1:G:4:ILE:HD13	1:G:65:GLN:HG2	1.96	0.46
2:K:1130:GLN:HG3	2:K:1138:LEU:HA	1.98	0.46
2:B:1443:GLN:HA	2:B:1557:THR:HG21	1.97	0.46
2:E:529:LEU:O	2:E:536:ASN:ND2	2.48	0.46
2:K:746:CYS:HA	2:K:757:PHE:HA	1.97	0.46
2:B:2454:ILE:HA	2:B:2457:ILE:HD12	1.96	0.46
1:D:74:LEU:HD13	1:D:101:VAL:HB	1.97	0.46
2:E:2128:GLN:HE21	2:E:2128:GLN:HA	1.80	0.46
2:E:3804:ASN:HB2	2:E:3807:VAL:HG12	1.98	0.46
2:E:4234:GLU:OE2	2:E:5012:TYR:OH	2.30	0.46
2:E:4553:LEU:HD11	2:E:4654:LEU:HD23	1.98	0.46
2:B:1641:ILE:HG22	2:B:1643:GLU:HG2	1.98	0.46
2:E:2475:LEU:HD23	2:E:2475:LEU:H	1.81	0.46
2:H:2475:LEU:H	2:H:2475:LEU:HD23	1.81	0.46
2:K:1252:HIS:CE1	2:K:1255:TYR:HD2	2.34	0.46
3:C:65:ASP:OD2	3:C:67:PRO:HD2	2.17	0.45
2:E:215:THR:OG1	2:E:271:GLY:O	2.34	0.45

Continued on next page...

Continued from previous page...

Atom-1	Atom-2	Interatomic distance (Å)	Clash overlap (Å)
2:E:1743:ARG:NH1	2:E:1964:GLU:OE2	2.44	0.45
2:K:215:THR:OG1	2:K:271:GLY:O	2.34	0.45
2:K:4177:GLU:CB	2:K:4981:HIS:HE1	2.30	0.45
2:B:3804:ASN:HB2	2:B:3807:VAL:HG12	1.98	0.45
2:K:668:VAL:HG11	2:K:682:LEU:HD21	1.99	0.45
2:K:2475:LEU:H	2:K:2475:LEU:HD23	1.81	0.45
2:B:668:VAL:HG11	2:B:682:LEU:HD21	1.99	0.45
2:B:892:THR:N	2:B:902:ARG:O	2.48	0.45
2:B:1130:GLN:HG3	2:B:1138:LEU:HA	1.98	0.45
2:B:2381:ILE:HD13	2:B:2470:ILE:HG13	1.99	0.45
2:E:2381:ILE:HD13	2:E:2470:ILE:HG13	1.99	0.45
2:H:2239:TYR:OH	3:I:68:GLU:OE2	2.33	0.45
2:K:2461:LEU:HD12	2:K:2462:VAL:HG23	1.97	0.45
2:E:1443:GLN:HA	2:E:1557:THR:HG21	1.97	0.45
1:G:74:LEU:HD13	1:G:101:VAL:HB	1.97	0.45
2:H:892:THR:N	2:H:902:ARG:O	2.48	0.45
2:K:1443:GLN:HA	2:K:1557:THR:HG21	1.97	0.45
2:E:167:ASP:OD1	2:E:167:ASP:N	2.50	0.45
2:E:499:THR:HG22	2:E:500:ALA:H	1.81	0.45
2:E:2378:LEU:HD12	2:E:2381:ILE:HD11	1.98	0.45
2:H:167:ASP:OD1	2:H:167:ASP:N	2.50	0.45
2:H:1130:GLN:HG3	2:H:1138:LEU:HA	1.98	0.45
2:K:1641:ILE:HG22	2:K:1643:GLU:HG2	1.98	0.45
1:A:74:LEU:HD13	1:A:101:VAL:HB	1.97	0.45
3:F:65:ASP:OD2	3:F:67:PRO:HD2	2.17	0.45
2:H:2128:GLN:HA	2:H:2128:GLN:HE21	1.80	0.45
3:I:65:ASP:OD2	3:I:67:PRO:HD2	2.17	0.45
2:K:1805:LEU:HD13	2:K:1854:ILE:HD12	1.99	0.45
2:H:215:THR:OG1	2:H:271:GLY:O	2.34	0.45
2:K:2128:GLN:HE21	2:K:2128:GLN:HA	1.80	0.45
2:K:2239:TYR:OH	3:L:68:GLU:OE2	2.33	0.45
2:B:1805:LEU:HD13	2:B:1854:ILE:HD12	1.99	0.45
2:H:668:VAL:HG11	2:H:682:LEU:HD21	1.99	0.45
2:B:2284:ASN:ND2	2:B:2287:LEU:HD13	2.32	0.45
2:E:1805:LEU:HD13	2:E:1854:ILE:HD12	1.99	0.45
2:H:257:ARG:HA	2:H:286:THR:HG21	1.99	0.45
2:H:2378:LEU:HD12	2:H:2381:ILE:HD11	1.98	0.45
2:K:167:ASP:N	2:K:167:ASP:OD1	2.50	0.45
2:K:257:ARG:HA	2:K:286:THR:HG21	1.99	0.45
3:L:65:ASP:OD2	3:L:67:PRO:HD2	2.17	0.45
2:B:2475:LEU:HD23	2:B:2475:LEU:H	1.81	0.45

Continued on next page...

Continued from previous page...

Atom-1	Atom-2	Interatomic distance (Å)	Clash overlap (Å)
2:E:668:VAL:HG11	2:E:682:LEU:HD21	1.99	0.45
2:H:2284:ASN:ND2	2:H:2287:LEU:HD13	2.32	0.45
2:H:3954:LYS:HA	2:H:4014:LEU:HD13	1.99	0.45
2:K:3804:ASN:HB2	2:K:3807:VAL:HG12	1.98	0.45
2:B:676:THR:OG1	2:B:677:ALA:N	2.46	0.44
2:B:2378:LEU:HD12	2:B:2381:ILE:HD11	1.98	0.44
2:B:4553:LEU:HD11	2:B:4654:LEU:HD23	1.98	0.44
2:H:499:THR:HG22	2:H:500:ALA:H	1.81	0.44
2:H:4234:GLU:OE2	2:H:5012:TYR:OH	2.30	0.44
2:B:1252:HIS:CE1	2:B:1255:TYR:HD2	2.34	0.44
2:E:1252:HIS:CE1	2:E:1255:TYR:HD2	2.34	0.44
2:H:1805:LEU:HD13	2:H:1854:ILE:HD12	1.99	0.44
2:H:4553:LEU:HD11	2:H:4654:LEU:HD23	1.98	0.44
2:K:1639:LEU:HD21	2:K:1650:ILE:HD13	1.99	0.44
2:K:2381:ILE:HD13	2:K:2470:ILE:HG13	1.99	0.44
2:H:746:CYS:HA	2:H:757:PHE:HA	1.97	0.44
2:B:499:THR:HG22	2:B:500:ALA:H	1.81	0.44
2:H:1252:HIS:CE1	2:H:1255:TYR:HD2	2.34	0.44
2:H:2381:ILE:HD13	2:H:2470:ILE:HG13	1.99	0.44
2:K:4553:LEU:HD11	2:K:4654:LEU:HD23	1.98	0.44
2:E:2284:ASN:ND2	2:E:2287:LEU:HD13	2.32	0.44
2:H:138:GLN:HG2	2:H:140:ASP:H	1.83	0.44
2:H:1287:LEU:HD13	2:H:1289:LEU:HG	1.99	0.44
2:K:138:GLN:HG2	2:K:140:ASP:H	1.83	0.44
2:K:355:LEU:HB3	2:K:378:LEU:HB3	2.00	0.44
2:K:2284:ASN:ND2	2:K:2287:LEU:HD13	2.32	0.44
2:K:2378:LEU:HD12	2:K:2381:ILE:HD11	1.98	0.44
2:B:355:LEU:HB3	2:B:378:LEU:HB3	2.00	0.44
2:B:1287:LEU:HD13	2:B:1289:LEU:HG	1.99	0.44
2:E:3954:LYS:HA	2:E:4014:LEU:HD13	1.99	0.44
2:H:2172:GLY:H	2:H:2175:GLU:HB2	1.83	0.44
2:B:3954:LYS:HA	2:B:4014:LEU:HD13	1.99	0.44
2:E:214:VAL:HG22	2:E:341:TYR:CZ	2.53	0.44
3:I:21:ASP:HB2	3:I:28:ILE:HD11	2.00	0.44
2:K:892:THR:N	2:K:902:ARG:O	2.48	0.44
2:K:2172:GLY:H	2:K:2175:GLU:HB2	1.83	0.44
2:B:35:LEU:HD13	2:B:49:LEU:HD13	2.00	0.44
2:B:308:HIS:H	2:B:312:THR:HG21	1.83	0.44
2:E:2239:TYR:OH	3:F:68:GLU:OE2	2.33	0.44
2:E:2272:THR:HG23	2:E:2275:ASP:H	1.83	0.44
2:H:214:VAL:HG22	2:H:341:TYR:CZ	2.53	0.44

Continued on next page...

Continued from previous page...

Atom-1	Atom-2	Interatomic distance (Å)	Clash overlap (Å)
2:H:1639:LEU:HD21	2:H:1650:ILE:HD13	1.99	0.44
2:K:1227:ALA:HB1	2:K:1230:MET:HB2	2.00	0.44
2:B:682:LEU:HD13	2:B:787:VAL:HG11	1.99	0.43
2:B:2172:GLY:H	2:B:2175:GLU:HB2	1.83	0.43
2:B:2457:ILE:HG23	2:E:131:LEU:HD23	2.00	0.43
2:H:308:HIS:H	2:H:312:THR:HG21	1.83	0.43
2:H:1227:ALA:HB1	2:H:1230:MET:HB2	2.00	0.43
2:K:2272:THR:HG23	2:K:2275:ASP:H	1.83	0.43
2:B:138:GLN:HG2	2:B:140:ASP:H	1.83	0.43
2:E:35:LEU:HD13	2:E:49:LEU:HD13	2.00	0.43
2:E:682:LEU:HD13	2:E:787:VAL:HG11	1.99	0.43
2:K:499:THR:HG22	2:K:500:ALA:H	1.81	0.43
2:K:1287:LEU:HD13	2:K:1289:LEU:HG	1.99	0.43
2:B:257:ARG:HA	2:B:286:THR:HG21	1.99	0.43
2:E:257:ARG:HA	2:E:286:THR:HG21	1.99	0.43
2:E:1227:ALA:HB1	2:E:1230:MET:HB2	2.00	0.43
2:E:1287:LEU:HD13	2:E:1289:LEU:HG	1.99	0.43
3:F:21:ASP:HB2	3:F:28:ILE:HD11	2.00	0.43
2:H:35:LEU:HD13	2:H:49:LEU:HD13	2.00	0.43
2:E:2172:GLY:H	2:E:2175:GLU:HB2	1.83	0.43
2:H:355:LEU:HB3	2:H:378:LEU:HB3	2.00	0.43
2:H:3804:ASN:HB2	2:H:3807:VAL:HG12	1.98	0.43
2:K:214:VAL:HG22	2:K:341:TYR:CZ	2.53	0.43
2:K:308:HIS:H	2:K:312:THR:HG21	1.83	0.43
2:H:615:ARG:NH2	2:H:1677:GLY:O	2.52	0.43
2:H:1448:VAL:HG22	2:H:1554:VAL:HG23	2.01	0.43
2:H:2457:ILE:HG23	2:K:131:LEU:HD23	2.00	0.43
2:K:3954:LYS:HA	2:K:4014:LEU:HD13	1.99	0.43
2:B:615:ARG:NH2	2:B:1677:GLY:O	2.52	0.43
2:B:1639:LEU:HD21	2:B:1650:ILE:HD13	1.99	0.43
2:E:1639:LEU:HD21	2:E:1650:ILE:HD13	1.99	0.43
2:K:35:LEU:HD13	2:K:49:LEU:HD13	2.00	0.43
2:B:1227:ALA:HB1	2:B:1230:MET:HB2	2.00	0.43
2:B:214:VAL:HG22	2:B:341:TYR:CZ	2.53	0.43
2:B:804:PRO:HA	2:B:805:PRO:HD3	1.96	0.43
2:B:2272:THR:HG23	2:B:2275:ASP:H	1.83	0.43
2:E:138:GLN:HG2	2:E:140:ASP:H	1.83	0.43
2:E:615:ARG:NH2	2:E:1677:GLY:O	2.52	0.43
2:E:1448:VAL:HG22	2:E:1554:VAL:HG23	2.01	0.43
2:E:2457:ILE:HG23	2:H:131:LEU:HD23	2.00	0.43
2:H:2272:THR:HG23	2:H:2275:ASP:H	1.83	0.43

Continued on next page...

Continued from previous page...

Atom-1	Atom-2	Interatomic distance (Å)	Clash overlap (Å)
2:K:21:VAL:HB	2:K:205:ILE:HD11	2.01	0.43
2:B:1867:ILE:HG22	2:B:1927:LEU:HD23	2.01	0.43
2:E:355:LEU:HB3	2:E:378:LEU:HB3	2.00	0.43
2:B:4016:LYS:HA	2:B:4134:ILE:HD13	2.01	0.42
2:H:21:VAL:HB	2:H:205:ILE:HD11	2.01	0.42
2:K:615:ARG:NH2	2:K:1677:GLY:O	2.52	0.42
2:K:682:LEU:HD13	2:K:787:VAL:HG11	1.99	0.42
2:E:21:VAL:HB	2:E:205:ILE:HD11	2.01	0.42
2:H:682:LEU:HD13	2:H:787:VAL:HG11	1.99	0.42
2:K:4016:LYS:HA	2:K:4134:ILE:HD13	2.01	0.42
3:C:21:ASP:HB2	3:C:28:ILE:HD11	2.00	0.42
2:E:308:HIS:H	2:E:312:THR:HG21	1.83	0.42
2:E:1867:ILE:HG22	2:E:1927:LEU:HD23	2.01	0.42
2:E:4016:LYS:HA	2:E:4134:ILE:HD13	2.01	0.42
3:F:5:LEU:HD21	3:F:74:ALA:HA	2.01	0.42
2:H:942:ALA:N	2:H:1050:GLY:O	2.48	0.42
2:H:1867:ILE:HG22	2:H:1927:LEU:HD23	2.01	0.42
2:H:3625:ARG:HH11	3:I:146:MET:HA	1.85	0.42
2:K:1247:ALA:HA	2:K:1598:GLN:HA	2.01	0.42
2:K:1745:ILE:HD12	2:K:1745:ILE:HA	1.96	0.42
3:L:21:ASP:HB2	3:L:28:ILE:HD11	2.00	0.42
2:B:1247:ALA:HA	2:B:1598:GLN:HA	2.01	0.42
2:B:3625:ARG:HH11	3:C:146:MET:HA	1.85	0.42
3:I:5:LEU:HD21	3:I:74:ALA:HA	2.01	0.42
3:L:33:LEU:HD22	3:L:64:ILE:HG12	2.02	0.42
2:B:131:LEU:HD23	2:K:2457:ILE:HG23	2.00	0.42
2:B:1448:VAL:HG22	2:B:1554:VAL:HG23	2.01	0.42
3:I:33:LEU:HD22	3:I:64:ILE:HG12	2.02	0.42
2:K:1448:VAL:HG22	2:K:1554:VAL:HG23	2.01	0.42
2:K:4634:THR:HG22	2:K:4636:TYR:H	1.85	0.42
2:B:4129:GLU:HB3	2:B:4130:PRO:HD3	2.02	0.42
2:H:49:LEU:HD11	2:H:191:VAL:HG13	2.02	0.42
2:B:21:VAL:HB	2:B:205:ILE:HD11	2.01	0.42
2:B:942:ALA:N	2:B:1050:GLY:O	2.48	0.42
2:B:4634:THR:HG22	2:B:4636:TYR:H	1.85	0.42
2:H:3930:TRP:CD1	2:K:80:GLU:HG3	2.55	0.42
3:C:5:LEU:HD21	3:C:74:ALA:HA	2.01	0.42
2:K:3625:ARG:HH11	3:L:146:MET:HA	1.85	0.42
2:E:49:LEU:HD11	2:E:191:VAL:HG13	2.02	0.42
1:J:35:LYS:HD2	2:K:636:ASN:HD21	1.85	0.42
2:K:1867:ILE:HG22	2:K:1927:LEU:HD23	2.01	0.42

Continued on next page...

Continued from previous page...

Atom-1	Atom-2	Interatomic distance (Å)	Clash overlap (Å)
2:B:299:LEU:HD23	2:B:299:LEU:H	1.85	0.42
2:B:1465:ASP:OD1	2:B:1465:ASP:N	2.53	0.42
3:C:33:LEU:HD22	3:C:64:ILE:HG12	2.02	0.42
2:E:1247:ALA:HA	2:E:1598:GLN:HA	2.01	0.42
2:E:1526:LEU:HD23	2:E:1526:LEU:H	1.85	0.42
2:E:4129:GLU:HB3	2:E:4130:PRO:HD3	2.02	0.42
2:H:1686:CYS:HB3	2:H:1783:PHE:HZ	1.85	0.42
2:H:4016:LYS:HA	2:H:4134:ILE:HD13	2.01	0.42
2:K:1686:CYS:HB3	2:K:1783:PHE:HZ	1.85	0.42
3:L:5:LEU:HD21	3:L:74:ALA:HA	2.01	0.42
2:B:80:GLU:HG3	2:K:3930:TRP:CD1	2.55	0.41
2:E:181:HIS:ND1	2:E:182:LEU:O	2.53	0.41
1:G:35:LYS:HD2	2:H:636:ASN:HD21	1.85	0.41
2:K:4031:VAL:HG13	2:K:4148:HIS:HA	2.02	0.41
2:B:3930:TRP:CD1	2:E:80:GLU:HG3	2.55	0.41
1:D:35:LYS:HD2	2:E:636:ASN:HD21	1.85	0.41
2:E:1686:CYS:HB3	2:E:1783:PHE:HZ	1.85	0.41
2:E:3625:ARG:HH11	3:F:146:MET:HA	1.85	0.41
2:H:4031:VAL:HG13	2:H:4148:HIS:HA	2.02	0.41
2:B:1857:ASP:N	2:B:1857:ASP:OD1	2.53	0.41
2:E:35:LEU:HD11	2:E:189:LEU:HD13	2.02	0.41
2:E:2243:ILE:HA	3:F:2:ALA:HB3	2.03	0.41
2:E:3936:ASP:OD1	2:E:3936:ASP:N	2.53	0.41
3:F:33:LEU:HD22	3:F:64:ILE:HG12	2.02	0.41
2:H:4634:THR:HG22	2:H:4636:TYR:H	1.85	0.41
2:K:49:LEU:HD11	2:K:191:VAL:HG13	2.02	0.41
2:K:1526:LEU:HD23	2:K:1526:LEU:H	1.85	0.41
2:B:1686:CYS:HB3	2:B:1783:PHE:HZ	1.85	0.41
2:B:2243:ILE:HA	3:C:2:ALA:HB3	2.03	0.41
2:B:2455:ARG:HE	2:B:2459:ARG:HH22	1.68	0.41
2:E:2455:ARG:HE	2:E:2459:ARG:HH22	1.68	0.41
2:H:684:VAL:HG22	2:H:781:VAL:HG23	2.02	0.41
2:H:1745:ILE:HD12	2:H:1745:ILE:HA	1.96	0.41
2:K:181:HIS:ND1	2:K:182:LEU:O	2.53	0.41
2:K:1465:ASP:OD1	2:K:1465:ASP:N	2.53	0.41
2:E:684:VAL:HG22	2:E:781:VAL:HG23	2.02	0.41
2:E:3930:TRP:CD1	2:H:80:GLU:HG3	2.55	0.41
2:H:1247:ALA:HA	2:H:1598:GLN:HA	2.01	0.41
2:H:1465:ASP:OD1	2:H:1465:ASP:N	2.53	0.41
2:H:1526:LEU:HD23	2:H:1526:LEU:H	1.85	0.41
2:K:4129:GLU:HB3	2:K:4130:PRO:HD3	2.02	0.41

Continued on next page...

Continued from previous page...

Atom-1	Atom-2	Interatomic distance (Å)	Clash overlap (Å)
2:B:4031:VAL:HG13	2:B:4148:HIS:HA	2.02	0.41
2:B:4700:ASP:HA	2:B:4776:TRP:HE1	1.86	0.41
2:E:4700:ASP:HA	2:E:4776:TRP:HE1	1.86	0.41
2:B:1526:LEU:H	2:B:1526:LEU:HD23	1.85	0.41
2:E:1465:ASP:N	2:E:1465:ASP:OD1	2.53	0.41
2:K:1600:LEU:HD23	2:K:1600:LEU:HA	1.96	0.41
2:K:2455:ARG:HE	2:K:2459:ARG:HH22	1.68	0.41
2:B:49:LEU:HD11	2:B:191:VAL:HG13	2.02	0.41
2:B:167:ASP:N	2:B:167:ASP:OD1	2.50	0.41
2:B:687:ALA:HA	2:B:713:SER:HA	2.03	0.41
2:B:3936:ASP:N	2:B:3936:ASP:OD1	2.53	0.41
2:E:143:GLY:HA2	2:E:147:TRP:HE1	1.86	0.41
2:E:1857:ASP:N	2:E:1857:ASP:OD1	2.53	0.41
2:H:143:GLY:HA2	2:H:147:TRP:HE1	1.86	0.41
2:H:687:ALA:HA	2:H:713:SER:HA	2.03	0.41
2:H:4129:GLU:HB3	2:H:4130:PRO:HD3	2.02	0.41
2:K:299:LEU:HD23	2:K:299:LEU:H	1.85	0.41
2:H:1857:ASP:OD1	2:H:1857:ASP:N	2.53	0.41
2:K:2258:LEU:HD13	2:K:2276:VAL:HG13	2.03	0.41
3:L:17:PHE:CE1	3:L:28:ILE:HD12	2.57	0.41
1:A:35:LYS:HD2	2:B:636:ASN:HD21	1.85	0.40
2:B:35:LEU:HD11	2:B:189:LEU:HD13	2.02	0.40
2:B:1101:ARG:HB3	2:B:1123:VAL:HG21	2.04	0.40
2:E:663:TYR:HD1	2:E:747:CYS:HB3	1.86	0.40
2:H:1499:ASP:OD1	2:H:1499:ASP:N	2.55	0.40
2:K:143:GLY:HA2	2:K:147:TRP:HE1	1.86	0.40
2:K:638:ILE:HD12	2:K:1638:ALA:HB3	2.03	0.40
2:K:684:VAL:HG22	2:K:781:VAL:HG23	2.02	0.40
2:K:1101:ARG:HB3	2:K:1123:VAL:HG21	2.04	0.40
2:K:1857:ASP:OD1	2:K:1857:ASP:N	2.53	0.40
2:K:4700:ASP:HA	2:K:4776:TRP:HE1	1.86	0.40
2:B:638:ILE:HD12	2:B:1638:ALA:HB3	2.03	0.40
2:B:663:TYR:HD1	2:B:747:CYS:HB3	1.86	0.40
2:E:687:ALA:HA	2:E:713:SER:HA	2.03	0.40
2:E:4634:THR:HG22	2:E:4636:TYR:H	1.85	0.40
2:H:288:GLY:HA3	2:H:405:TYR:CZ	2.56	0.40
2:H:299:LEU:HD23	2:H:299:LEU:H	1.85	0.40
2:H:609:CYS:HB3	2:H:612:VAL:O	2.22	0.40
2:K:35:LEU:HD11	2:K:189:LEU:HD13	2.02	0.40
2:B:143:GLY:HA2	2:B:147:TRP:HE1	1.86	0.40
2:B:684:VAL:HG22	2:B:781:VAL:HG23	2.02	0.40

Continued on next page...

Continued from previous page...

Atom-1	Atom-2	Interatomic distance (Å)	Clash overlap (Å)
2:E:3905:THR:HG23	2:E:3906:THR:HG23	2.04	0.40
2:H:181:HIS:ND1	2:H:182:LEU:O	2.53	0.40
2:H:1777:HIS:HB3	2:H:1799:LEU:HD13	2.04	0.40
2:H:1834:SER:HB2	2:H:1837:PHE:HD1	1.87	0.40
2:H:2455:ARG:HE	2:H:2459:ARG:HH22	1.68	0.40
2:K:288:GLY:HA3	2:K:405:TYR:CZ	2.56	0.40
2:K:2284:ASN:HD21	2:K:2287:LEU:HD13	1.87	0.40
2:B:2258:LEU:HD13	2:B:2276:VAL:HG13	2.03	0.40
2:H:2243:ILE:HA	3:I:2:ALA:HB3	2.03	0.40
2:H:3622:LYS:C	2:H:3624:ARG:H	2.25	0.40
2:K:687:ALA:HA	2:K:713:SER:HA	2.03	0.40
2:K:3936:ASP:N	2:K:3936:ASP:OD1	2.53	0.40
2:B:288:GLY:HA3	2:B:405:TYR:CZ	2.56	0.40
2:B:336:PRO:HA	2:B:337:PRO:HD3	1.89	0.40
3:C:17:PHE:CE1	3:C:28:ILE:HD12	2.57	0.40
2:E:609:CYS:HB3	2:E:612:VAL:O	2.22	0.40
2:E:2258:LEU:HD13	2:E:2276:VAL:HG13	2.03	0.40
2:E:4031:VAL:HG13	2:E:4148:HIS:HA	2.02	0.40
3:F:17:PHE:CE1	3:F:28:ILE:HD12	2.57	0.40
2:H:4700:ASP:HA	2:H:4776:TRP:HE1	1.86	0.40
2:K:2243:ILE:HA	3:L:2:ALA:HB3	2.03	0.40

There are no symmetry-related clashes.

5.3 Torsion angles [\(i\)](#)

5.3.1 Protein backbone [\(i\)](#)

In the following table, the Percentiles column shows the percent Ramachandran outliers of the chain as a percentile score with respect to all PDB entries followed by that with respect to all EM entries.

The Analysed column shows the number of residues for which the backbone conformation was analysed, and the total number of residues.

Mol	Chain	Analysed	Favoured	Allowed	Outliers	Percentiles	
1	A	104/107 (97%)	98 (94%)	6 (6%)	0	100	100
1	D	104/107 (97%)	98 (94%)	6 (6%)	0	100	100
1	G	104/107 (97%)	98 (94%)	6 (6%)	0	100	100
1	J	104/107 (97%)	98 (94%)	6 (6%)	0	100	100

Continued on next page...

Continued from previous page...

Mol	Chain	Analysed	Favoured	Allowed	Outliers	Percentiles	
2	B	3396/3816 (89%)	3335 (98%)	61 (2%)	0	100	100
2	E	3396/3816 (89%)	3335 (98%)	61 (2%)	0	100	100
2	H	3396/3816 (89%)	3335 (98%)	61 (2%)	0	100	100
2	K	3396/3816 (89%)	3335 (98%)	61 (2%)	0	100	100
3	C	127/148 (86%)	124 (98%)	3 (2%)	0	100	100
3	F	127/148 (86%)	124 (98%)	3 (2%)	0	100	100
3	I	127/148 (86%)	124 (98%)	3 (2%)	0	100	100
3	L	127/148 (86%)	124 (98%)	3 (2%)	0	100	100
All	All	14508/16284 (89%)	14228 (98%)	280 (2%)	0	100	100

There are no Ramachandran outliers to report.

5.3.2 Protein sidechains [i](#)

In the following table, the Percentiles column shows the percent sidechain outliers of the chain as a percentile score with respect to all PDB entries followed by that with respect to all EM entries.

The Analysed column shows the number of residues for which the sidechain conformation was analysed, and the total number of residues.

Mol	Chain	Analysed	Rotameric	Outliers	Percentiles	
1	A	66/88 (75%)	66 (100%)	0	100	100
1	D	66/88 (75%)	66 (100%)	0	100	100
1	G	66/88 (75%)	66 (100%)	0	100	100
1	J	66/88 (75%)	66 (100%)	0	100	100
2	B	2222/3025 (74%)	2221 (100%)	1 (0%)	100	100
2	E	2222/3025 (74%)	2221 (100%)	1 (0%)	100	100
2	H	2222/3025 (74%)	2221 (100%)	1 (0%)	100	100
2	K	2222/3025 (74%)	2221 (100%)	1 (0%)	100	100
3	C	29/126 (23%)	29 (100%)	0	100	100
3	F	29/126 (23%)	29 (100%)	0	100	100
3	I	29/126 (23%)	29 (100%)	0	100	100
3	L	29/126 (23%)	29 (100%)	0	100	100
All	All	9268/12956 (72%)	9264 (100%)	4 (0%)	100	100

All (4) residues with a non-rotameric sidechain are listed below:

Mol	Chain	Res	Type
2	B	2128	GLN
2	E	2128	GLN
2	H	2128	GLN
2	K	2128	GLN

Sometimes sidechains can be flipped to improve hydrogen bonding and reduce clashes. All (16) such sidechains are listed below:

Mol	Chain	Res	Type
2	B	838	HIS
2	B	2128	GLN
2	B	3955	GLN
2	B	4976	HIS
2	E	838	HIS
2	E	2128	GLN
2	E	3955	GLN
2	E	4981	HIS
2	H	838	HIS
2	H	2128	GLN
2	H	3955	GLN
2	H	4981	HIS
2	K	838	HIS
2	K	2128	GLN
2	K	3955	GLN
2	K	4981	HIS

5.3.3 RNA [i](#)

There are no RNA molecules in this entry.

5.4 Non-standard residues in protein, DNA, RNA chains [i](#)

There are no non-standard protein/DNA/RNA residues in this entry.

5.5 Carbohydrates [i](#)

There are no monosaccharides in this entry.

5.6 Ligand geometry [i](#)

Of 4 ligands modelled in this entry, 4 are monoatomic - leaving 0 for Mogul analysis.

There are no bond length outliers.

There are no bond angle outliers.

There are no chirality outliers.

There are no torsion outliers.

There are no ring outliers.

No monomer is involved in short contacts.

5.7 Other polymers [i](#)

There are no such residues in this entry.

5.8 Polymer linkage issues [i](#)

The following chains have linkage breaks:

Mol	Chain	Number of breaks
2	B	56
2	E	56
2	H	56
2	K	56

All chain breaks are listed below:

Model	Chain	Residue-1	Atom-1	Residue-2	Atom-2	Distance (Å)
1	B	4331:UNK	C	4543:GLU	N	51.24
1	E	4331:UNK	C	4543:GLU	N	51.24
1	H	4331:UNK	C	4543:GLU	N	51.24
1	K	4331:UNK	C	4543:GLU	N	51.24
1	B	1054:GLU	C	1071:ARG	N	36.98
1	E	1054:GLU	C	1071:ARG	N	36.98
1	H	1054:GLU	C	1071:ARG	N	36.98
1	K	1054:GLU	C	1071:ARG	N	36.98
1	B	854:CYS	C	866:HIS	N	29.09
1	E	854:CYS	C	866:HIS	N	29.09
1	H	854:CYS	C	866:HIS	N	29.09
1	K	854:CYS	C	866:HIS	N	29.09
1	B	3606:UNK	C	3617:HIS	N	28.52

Continued on next page...

Continued from previous page...

Model	Chain	Residue-1	Atom-1	Residue-2	Atom-2	Distance (Å)
1	E	3606:UNK	C	3617:HIS	N	28.52
1	H	3606:UNK	C	3617:HIS	N	28.52
1	K	3606:UNK	C	3617:HIS	N	28.52
1	B	4245:GLN	C	4315:UNK	N	27.59
1	E	4245:GLN	C	4315:UNK	N	27.59
1	H	4245:GLN	C	4315:UNK	N	27.59
1	K	4245:GLN	C	4315:UNK	N	27.59
1	B	2700:UNK	C	2736:ASP	N	25.87
1	E	2700:UNK	C	2736:ASP	N	25.87
1	H	2700:UNK	C	2736:ASP	N	25.87
1	K	2700:UNK	C	2736:ASP	N	25.87
1	B	2830:GLU	C	2855:TYR	N	23.98
1	E	2830:GLU	C	2855:TYR	N	23.98
1	H	2830:GLU	C	2855:TYR	N	23.98
1	K	2830:GLU	C	2855:TYR	N	23.98
1	B	84:ASN	C	97:GLY	N	23.34
1	E	84:ASN	C	97:GLY	N	23.34
1	H	84:ASN	C	97:GLY	N	23.34
1	K	84:ASN	C	97:GLY	N	23.34
1	B	2939:ARG	C	2956:UNK	N	23.02
1	E	2939:ARG	C	2956:UNK	N	23.02
1	H	2939:ARG	C	2956:UNK	N	23.02
1	K	2939:ARG	C	2956:UNK	N	23.02
1	B	3555:UNK	C	3565:UNK	N	22.27
1	E	3555:UNK	C	3565:UNK	N	22.27
1	H	3555:UNK	C	3565:UNK	N	22.27
1	K	3555:UNK	C	3565:UNK	N	22.27
1	B	1299:GLN	C	1428:LEU	N	21.92
1	E	1299:GLN	C	1428:LEU	N	21.92
1	H	1299:GLN	C	1428:LEU	N	21.92
1	K	1299:GLN	C	1428:LEU	N	21.92
1	B	3574:UNK	C	3586:UNK	N	21.88
1	E	3574:UNK	C	3586:UNK	N	21.88
1	H	3574:UNK	C	3586:UNK	N	21.88
1	K	3574:UNK	C	3586:UNK	N	21.88
1	B	4737:GLU	C	4769:ILE	N	20.65
1	E	4737:GLU	C	4769:ILE	N	20.65
1	H	4737:GLU	C	4769:ILE	N	20.65
1	K	4737:GLU	C	4769:ILE	N	20.65
1	B	2385:ILE	C	2418:HIS	N	18.54
1	E	2385:ILE	C	2418:HIS	N	18.54
1	H	2385:ILE	C	2418:HIS	N	18.54

Continued on next page...

Continued from previous page...

Model	Chain	Residue-1	Atom-1	Residue-2	Atom-2	Distance (Å)
1	K	2385:ILE	C	2418:HIS	N	18.54
1	B	3358:UNK	C	3365:UNK	N	17.90
1	E	3358:UNK	C	3365:UNK	N	17.90
1	H	3358:UNK	C	3365:UNK	N	17.90
1	K	3358:UNK	C	3365:UNK	N	17.90
1	B	2046:GLN	C	2092:LEU	N	17.87
1	E	2046:GLN	C	2092:LEU	N	17.87
1	H	2046:GLN	C	2092:LEU	N	17.87
1	K	2046:GLN	C	2092:LEU	N	17.87
1	B	2653:UNK	C	2664:UNK	N	17.50
1	E	2653:UNK	C	2664:UNK	N	17.50
1	H	2653:UNK	C	2664:UNK	N	17.50
1	K	2653:UNK	C	2664:UNK	N	17.50
1	B	3193:UNK	C	3202:UNK	N	17.22
1	E	3193:UNK	C	3202:UNK	N	17.22
1	H	3193:UNK	C	3202:UNK	N	17.22
1	K	3193:UNK	C	3202:UNK	N	17.22
1	B	3733:GLU	C	3747:SER	N	15.80
1	E	3733:GLU	C	3747:SER	N	15.80
1	H	3733:GLU	C	3747:SER	N	15.80
1	K	3733:GLU	C	3747:SER	N	15.80
1	B	3385:UNK	C	3399:PHE	N	15.58
1	E	3385:UNK	C	3399:PHE	N	15.58
1	H	3385:UNK	C	3399:PHE	N	15.58
1	K	3385:UNK	C	3399:PHE	N	15.58
1	B	3062:UNK	C	3146:UNK	N	15.38
1	E	3062:UNK	C	3146:UNK	N	15.38
1	H	3062:UNK	C	3146:UNK	N	15.38
1	K	3062:UNK	C	3146:UNK	N	15.38
1	B	3238:UNK	C	3278:UNK	N	14.98
1	E	3238:UNK	C	3278:UNK	N	14.98
1	H	3238:UNK	C	3278:UNK	N	14.98
1	K	3238:UNK	C	3278:UNK	N	14.98
1	B	2978:UNK	C	2999:UNK	N	14.76
1	E	2978:UNK	C	2999:UNK	N	14.76
1	H	2978:UNK	C	2999:UNK	N	14.76
1	K	2978:UNK	C	2999:UNK	N	14.76
1	B	3461:VAL	C	3509:UNK	N	13.70
1	E	3461:VAL	C	3509:UNK	N	13.70
1	H	3461:VAL	C	3509:UNK	N	13.70
1	K	3461:VAL	C	3509:UNK	N	13.70
1	B	3018:UNK	C	3032:UNK	N	12.78

Continued on next page...

Continued from previous page...

Model	Chain	Residue-1	Atom-1	Residue-2	Atom-2	Distance (Å)
1	E	3018:UNK	C	3032:UNK	N	12.78
1	H	3018:UNK	C	3032:UNK	N	12.78
1	K	3018:UNK	C	3032:UNK	N	12.78
1	B	2014:LYS	C	2023:PRO	N	12.65
1	E	2014:LYS	C	2023:PRO	N	12.65
1	H	2014:LYS	C	2023:PRO	N	12.65
1	K	2014:LYS	C	2023:PRO	N	12.65
1	B	2683:UNK	C	2688:UNK	N	12.62
1	E	2683:UNK	C	2688:UNK	N	12.62
1	H	2683:UNK	C	2688:UNK	N	12.62
1	K	2683:UNK	C	2688:UNK	N	12.62
1	B	2571:ALA	C	2579:MET	N	12.58
1	E	2571:ALA	C	2579:MET	N	12.58
1	H	2571:ALA	C	2579:MET	N	12.58
1	K	2571:ALA	C	2579:MET	N	12.58
1	B	3166:UNK	C	3173:UNK	N	12.43
1	E	3166:UNK	C	3173:UNK	N	12.43
1	H	3166:UNK	C	3173:UNK	N	12.43
1	K	3166:UNK	C	3173:UNK	N	12.43
1	B	3308:UNK	C	3320:UNK	N	12.24
1	E	3308:UNK	C	3320:UNK	N	12.24
1	H	3308:UNK	C	3320:UNK	N	12.24
1	K	3308:UNK	C	3320:UNK	N	12.24
1	B	361:ALA	C	372:LEU	N	12.09
1	E	361:ALA	C	372:LEU	N	12.09
1	H	361:ALA	C	372:LEU	N	12.09
1	K	361:ALA	C	372:LEU	N	12.09
1	B	2629:PHE	C	2641:UNK	N	12.03
1	E	2629:PHE	C	2641:UNK	N	12.03
1	H	2629:PHE	C	2641:UNK	N	12.03
1	K	2629:PHE	C	2641:UNK	N	12.03
1	B	4090:LYS	C	4109:UNK	N	11.95
1	E	4090:LYS	C	4109:UNK	N	11.95
1	H	4090:LYS	C	4109:UNK	N	11.95
1	K	4090:LYS	C	4109:UNK	N	11.95
1	B	1750:PRO	C	1760:ARG	N	11.65
1	E	1750:PRO	C	1760:ARG	N	11.65
1	H	1750:PRO	C	1760:ARG	N	11.65
1	K	1750:PRO	C	1760:ARG	N	11.65
1	B	3544:UNK	C	3548:UNK	N	11.53
1	E	3544:UNK	C	3548:UNK	N	11.53
1	H	3544:UNK	C	3548:UNK	N	11.53

Continued on next page...

Continued from previous page...

Model	Chain	Residue-1	Atom-1	Residue-2	Atom-2	Distance (Å)
1	K	3544:UNK	C	3548:UNK	N	11.53
1	B	3217:UNK	C	3225:UNK	N	11.39
1	E	3217:UNK	C	3225:UNK	N	11.39
1	H	3217:UNK	C	3225:UNK	N	11.39
1	K	3217:UNK	C	3225:UNK	N	11.39
1	B	1501:VAL	C	1510:SER	N	11.35
1	E	1501:VAL	C	1510:SER	N	11.35
1	H	1501:VAL	C	1510:SER	N	11.35
1	K	1501:VAL	C	1510:SER	N	11.35
1	B	3047:UNK	C	3051:UNK	N	11.02
1	E	3047:UNK	C	3051:UNK	N	11.02
1	H	3047:UNK	C	3051:UNK	N	11.02
1	K	3047:UNK	C	3051:UNK	N	11.02
1	B	1788:PRO	C	1794:GLU	N	10.90
1	E	1788:PRO	C	1794:GLU	N	10.90
1	H	1788:PRO	C	1794:GLU	N	10.90
1	K	1788:PRO	C	1794:GLU	N	10.90
1	B	4114:UNK	C	4122:GLU	N	10.72
1	E	4114:UNK	C	4122:GLU	N	10.72
1	H	4114:UNK	C	4122:GLU	N	10.72
1	K	4114:UNK	C	4122:GLU	N	10.72
1	B	1871:VAL	C	1924:GLU	N	10.67
1	E	1871:VAL	C	1924:GLU	N	10.67
1	H	1871:VAL	C	1924:GLU	N	10.67
1	K	1871:VAL	C	1924:GLU	N	10.67
1	B	3335:UNK	C	3346:UNK	N	10.58
1	E	3335:UNK	C	3346:UNK	N	10.58
1	H	3335:UNK	C	3346:UNK	N	10.58
1	K	3335:UNK	C	3346:UNK	N	10.58
1	B	3288:UNK	C	3292:UNK	N	10.44
1	E	3288:UNK	C	3292:UNK	N	10.44
1	H	3288:UNK	C	3292:UNK	N	10.44
1	K	3288:UNK	C	3292:UNK	N	10.44
1	B	323:LEU	C	328:LYS	N	10.40
1	E	323:LEU	C	328:LYS	N	10.40
1	H	323:LEU	C	328:LYS	N	10.40
1	K	323:LEU	C	328:LYS	N	10.40
1	B	4585:PRO	C	4626:VAL	N	10.08
1	E	4585:PRO	C	4626:VAL	N	10.08
1	H	4585:PRO	C	4626:VAL	N	10.08
1	K	4585:PRO	C	4626:VAL	N	10.08
1	B	2535:ALA	C	2549:LEU	N	9.70

Continued on next page...

Continued from previous page...

Model	Chain	Residue-1	Atom-1	Residue-2	Atom-2	Distance (Å)
1	E	2535:ALA	C	2549:LEU	N	9.70
1	H	2535:ALA	C	2549:LEU	N	9.70
1	K	2535:ALA	C	2549:LEU	N	9.70
1	B	2478:PRO	C	2491:MET	N	9.63
1	E	2478:PRO	C	2491:MET	N	9.63
1	H	2478:PRO	C	2491:MET	N	9.63
1	K	2478:PRO	C	2491:MET	N	9.63
1	B	3526:UNK	C	3534:UNK	N	9.43
1	E	3526:UNK	C	3534:UNK	N	9.43
1	H	3526:UNK	C	3534:UNK	N	9.43
1	K	3526:UNK	C	3534:UNK	N	9.43
1	B	2263:GLY	C	2267:GLY	N	8.79
1	E	2263:GLY	C	2267:GLY	N	8.79
1	H	2263:GLY	C	2267:GLY	N	8.79
1	K	2263:GLY	C	2267:GLY	N	8.79
1	B	3861:ILE	C	3866:GLY	N	8.58
1	E	3861:ILE	C	3866:GLY	N	8.58
1	H	3861:ILE	C	3866:GLY	N	8.58
1	K	3861:ILE	C	3866:GLY	N	8.58
1	B	2216:LEU	C	2225:ARG	N	7.09
1	E	2216:LEU	C	2225:ARG	N	7.09
1	H	2216:LEU	C	2225:ARG	N	7.09
1	K	2216:LEU	C	2225:ARG	N	7.09
1	B	4219:GLU	C	4225:LYS	N	6.52
1	E	4219:GLU	C	4225:LYS	N	6.52
1	H	4219:GLU	C	4225:LYS	N	6.52
1	K	4219:GLU	C	4225:LYS	N	6.52
1	B	1275:ARG	C	1282:SER	N	6.22
1	E	1275:ARG	C	1282:SER	N	6.22
1	H	1275:ARG	C	1282:SER	N	6.22
1	K	1275:ARG	C	1282:SER	N	6.22
1	B	4863:LYS	C	4872:MET	N	5.66
1	E	4863:LYS	C	4872:MET	N	5.66
1	H	4863:LYS	C	4872:MET	N	5.66
1	K	4863:LYS	C	4872:MET	N	5.66
1	B	1478:ASP	C	1482:ASN	N	5.62
1	E	1478:ASP	C	1482:ASN	N	5.62
1	H	1478:ASP	C	1482:ASN	N	5.62
1	K	1478:ASP	C	1482:ASN	N	5.62
1	B	2527:PHE	C	2528:LEU	N	3.17
1	E	2527:PHE	C	2528:LEU	N	3.17
1	H	2527:PHE	C	2528:LEU	N	3.17

Continued on next page...

Continued from previous page...

Model	Chain	Residue-1	Atom-1	Residue-2	Atom-2	Distance (Å)
1	K	2527:PHE	C	2528:LEU	N	3.17

6 Map visualisation [i](#)

This section contains visualisations of the EMDB entry EMD-22016. These allow visual inspection of the internal detail of the map and identification of artifacts.

No raw map or half-maps were deposited for this entry and therefore no images, graphs, etc. pertaining to the raw map can be shown.

6.1 Orthogonal projections [i](#)

6.1.1 Primary map

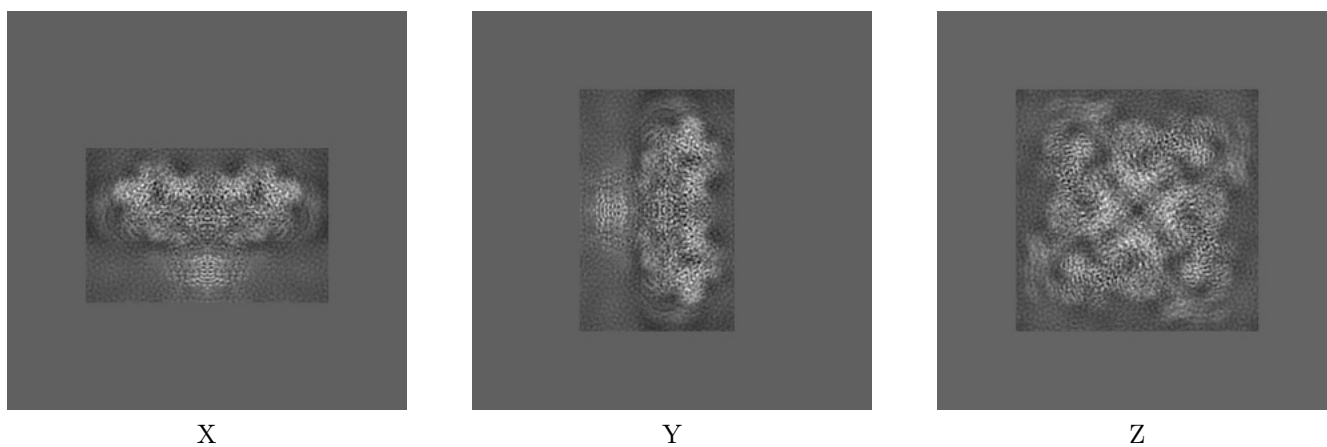

The images above show the map projected in three orthogonal directions.

6.2 Central slices [i](#)

6.2.1 Primary map

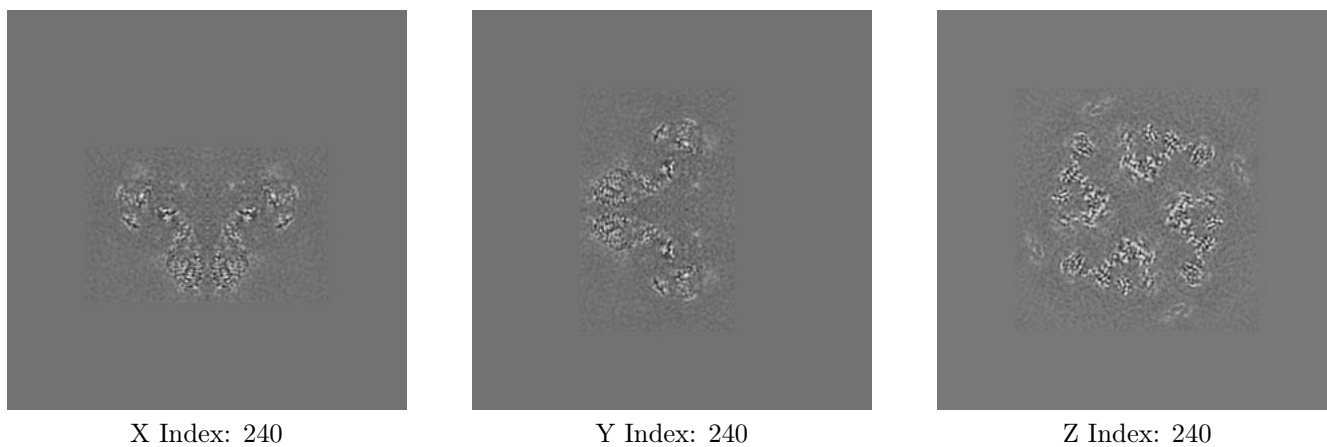

The images above show central slices of the map in three orthogonal directions.

6.3 Largest variance slices [i](#)

6.3.1 Primary map

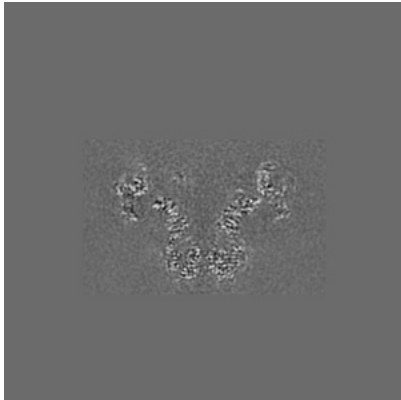

X Index: 236

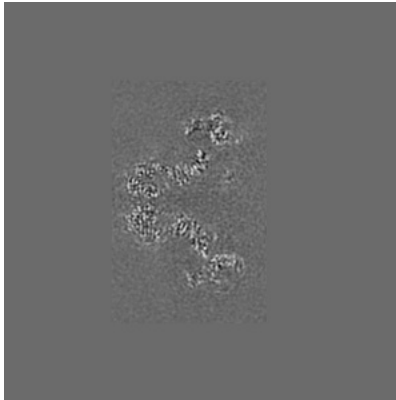

Y Index: 236

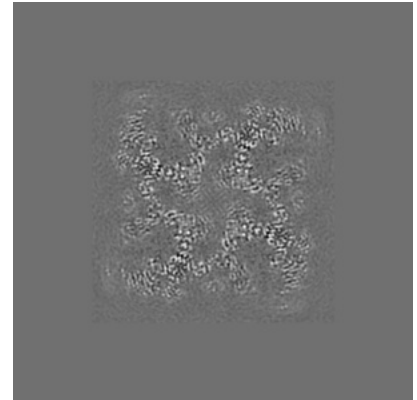

Z Index: 265

The images above show the largest variance slices of the map in three orthogonal directions.

6.4 Orthogonal standard-deviation projections (False-color) [i](#)

6.4.1 Primary map

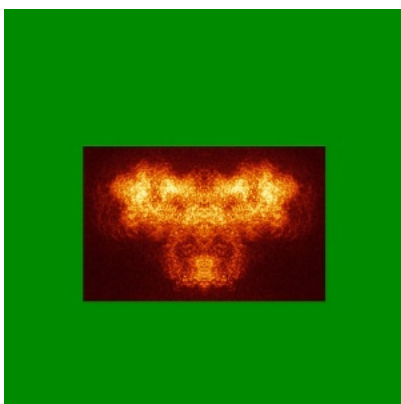

X

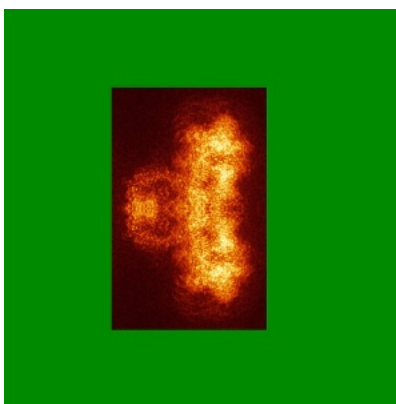

Y

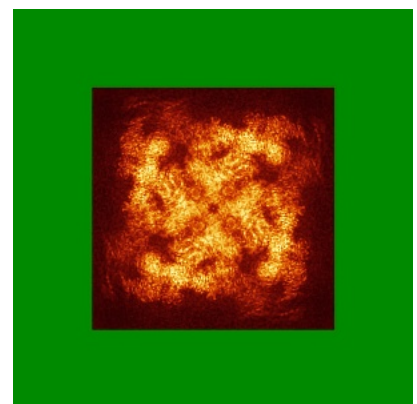

Z

The images above show the map standard deviation projections with false color in three orthogonal directions. Minimum values are shown in green, max in blue, and dark to light orange shades represent small to large values respectively.

6.5 Orthogonal surface views [i](#)

6.5.1 Primary map



The images above show the 3D surface view of the map at the recommended contour level 0.022. These images, in conjunction with the slice images, may facilitate assessment of whether an appropriate contour level has been provided.

6.6 Mask visualisation [i](#)

This section was not generated. No masks/segmentation were deposited.

7 Map analysis [i](#)

This section contains the results of statistical analysis of the map.

7.1 Map-value distribution [i](#)

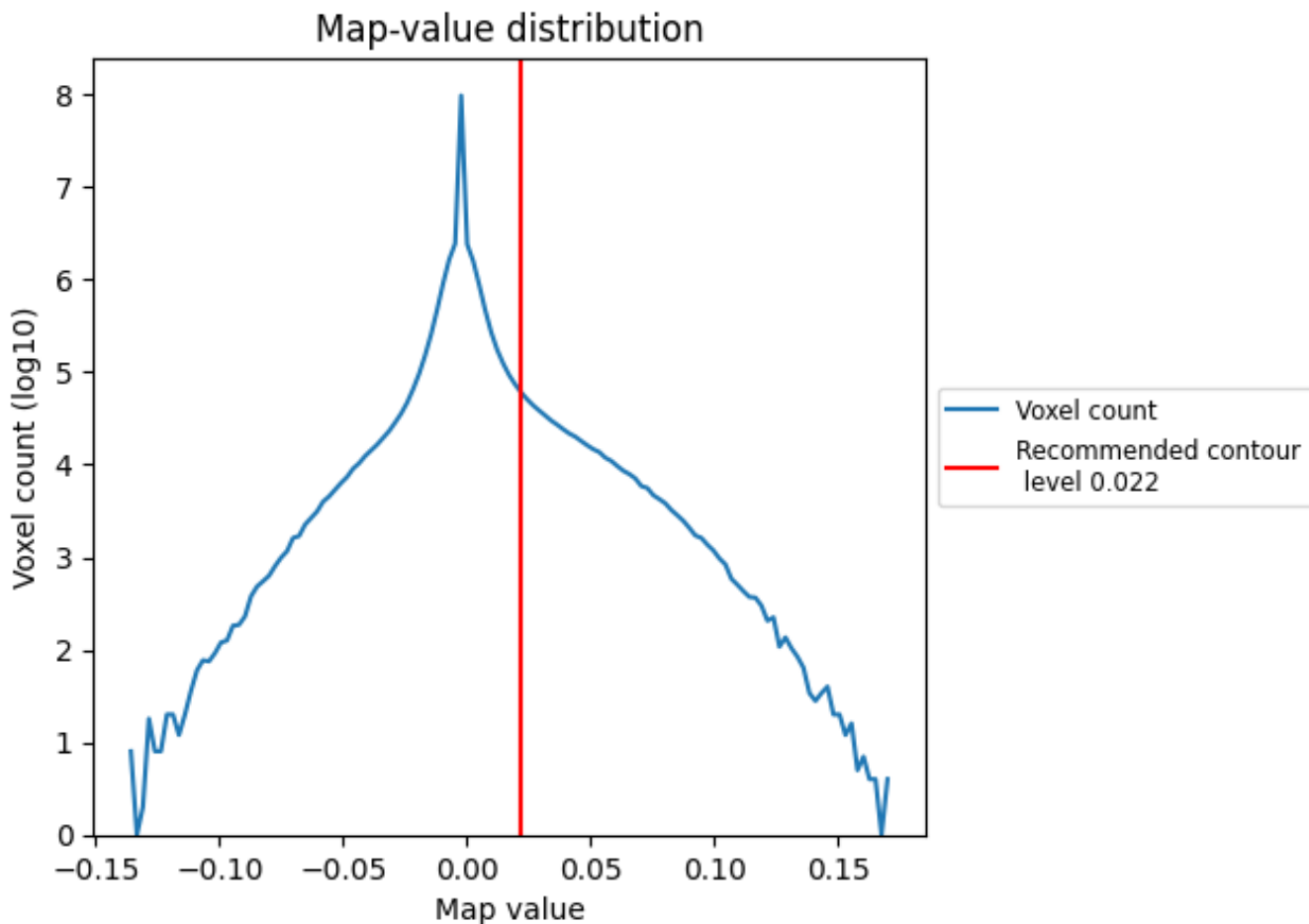

The map-value distribution is plotted in 128 intervals along the x-axis. The y-axis is logarithmic. A spike in this graph at zero usually indicates that the volume has been masked.

7.2 Volume estimate [i](#)

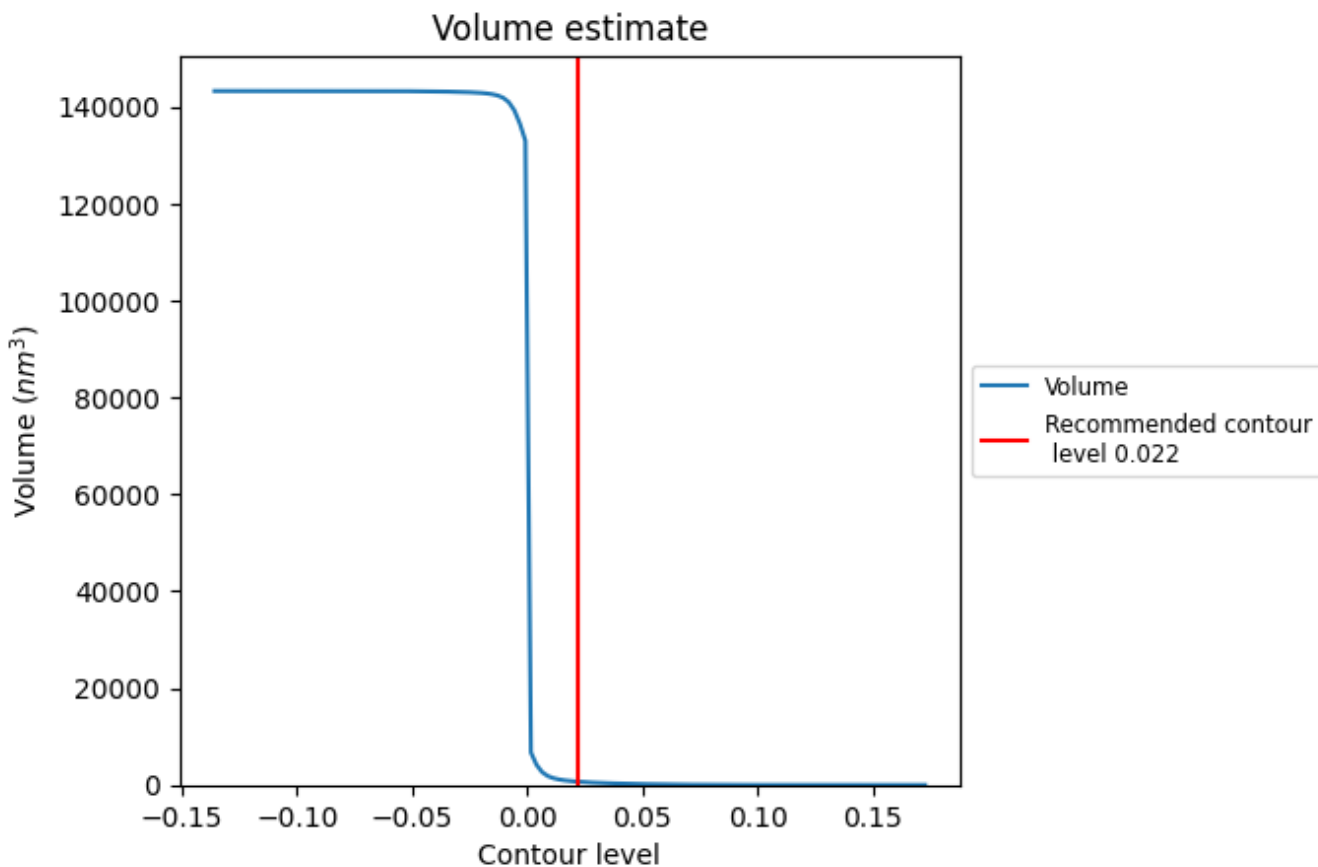

The volume at the recommended contour level is 672 nm³; this corresponds to an approximate mass of 607 kDa.

The volume estimate graph shows how the enclosed volume varies with the contour level. The recommended contour level is shown as a vertical line and the intersection between the line and the curve gives the volume of the enclosed surface at the given level.

7.3 Rotationally averaged power spectrum [\(i\)](#)

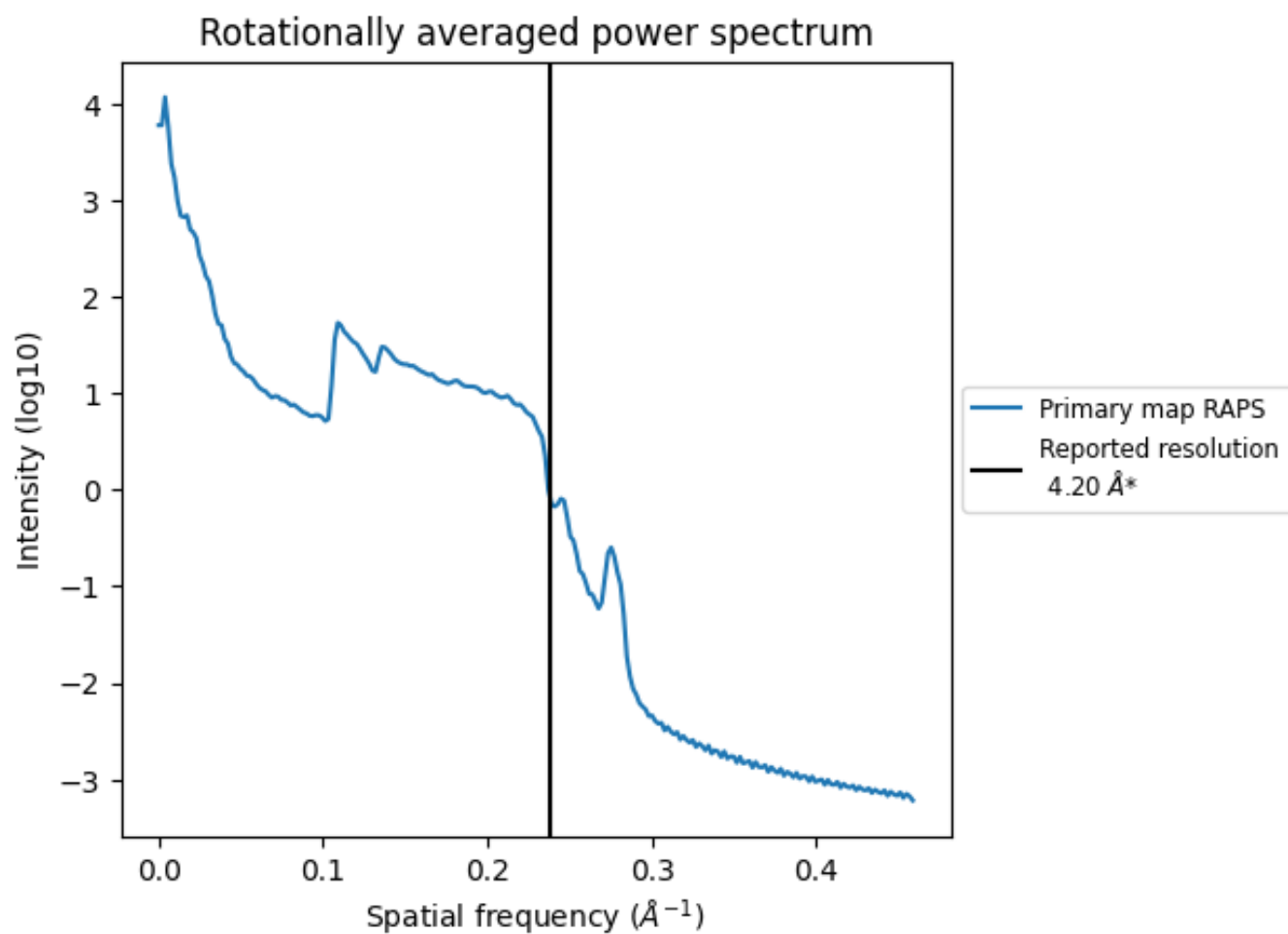

*Reported resolution corresponds to spatial frequency of 0.238\AA^{-1}

8 Fourier-Shell correlation

This section was not generated. No FSC curve or half-maps provided.

9 Map-model fit [i](#)

This section contains information regarding the fit between EMDB map EMD-22016 and PDB model 6X33. Per-residue inclusion information can be found in section 3 on page 6.

9.1 Map-model overlay [i](#)

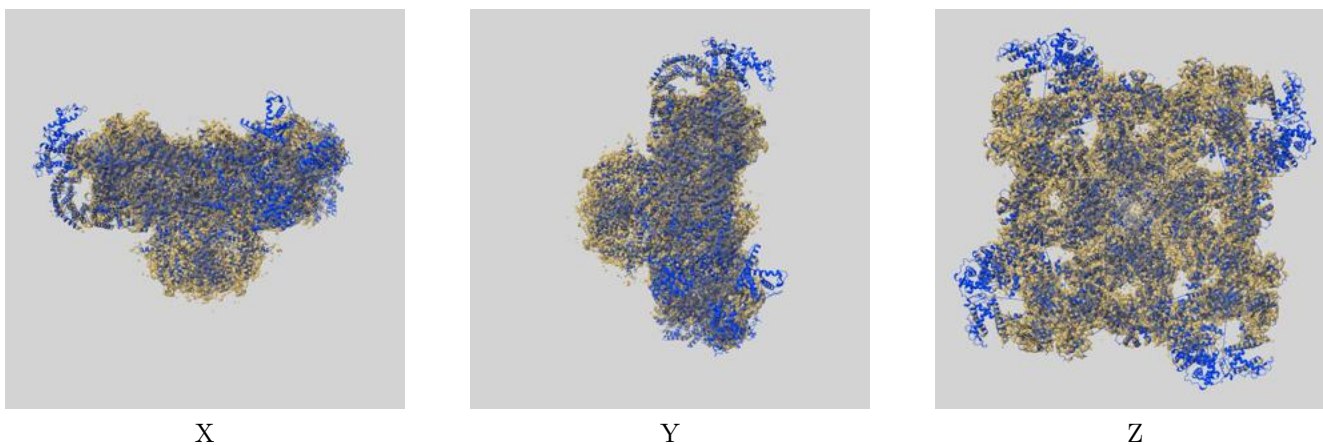

The images above show the 3D surface view of the map at the recommended contour level 0.022 at 50% transparency in yellow overlaid with a ribbon representation of the model coloured in blue. These images allow for the visual assessment of the quality of fit between the atomic model and the map.

9.2 Q-score mapped to coordinate model [i](#)

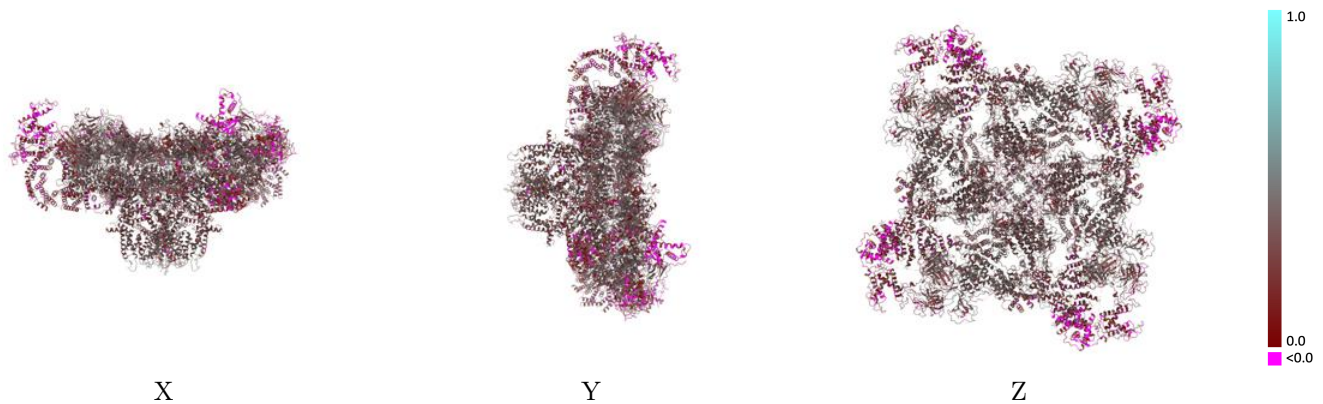

The images above show the model with each residue coloured according to its Q-score. This shows their resolvability in the map with higher Q-score values reflecting better resolvability. Please note: Q-score is calculating the resolvability of atoms, and thus high values are only expected at resolutions at which atoms can be resolved. Low Q-score values may therefore be expected for many entries.

9.3 Atom inclusion mapped to coordinate model [i](#)

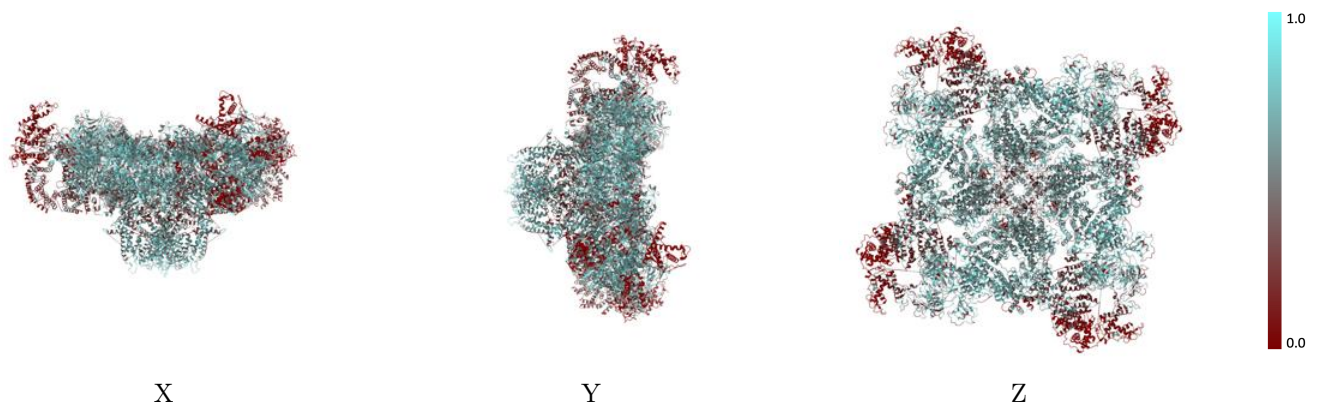

The images above show the model with each residue coloured according to its atom inclusion. This shows to what extent they are inside the map at the recommended contour level (0.022).



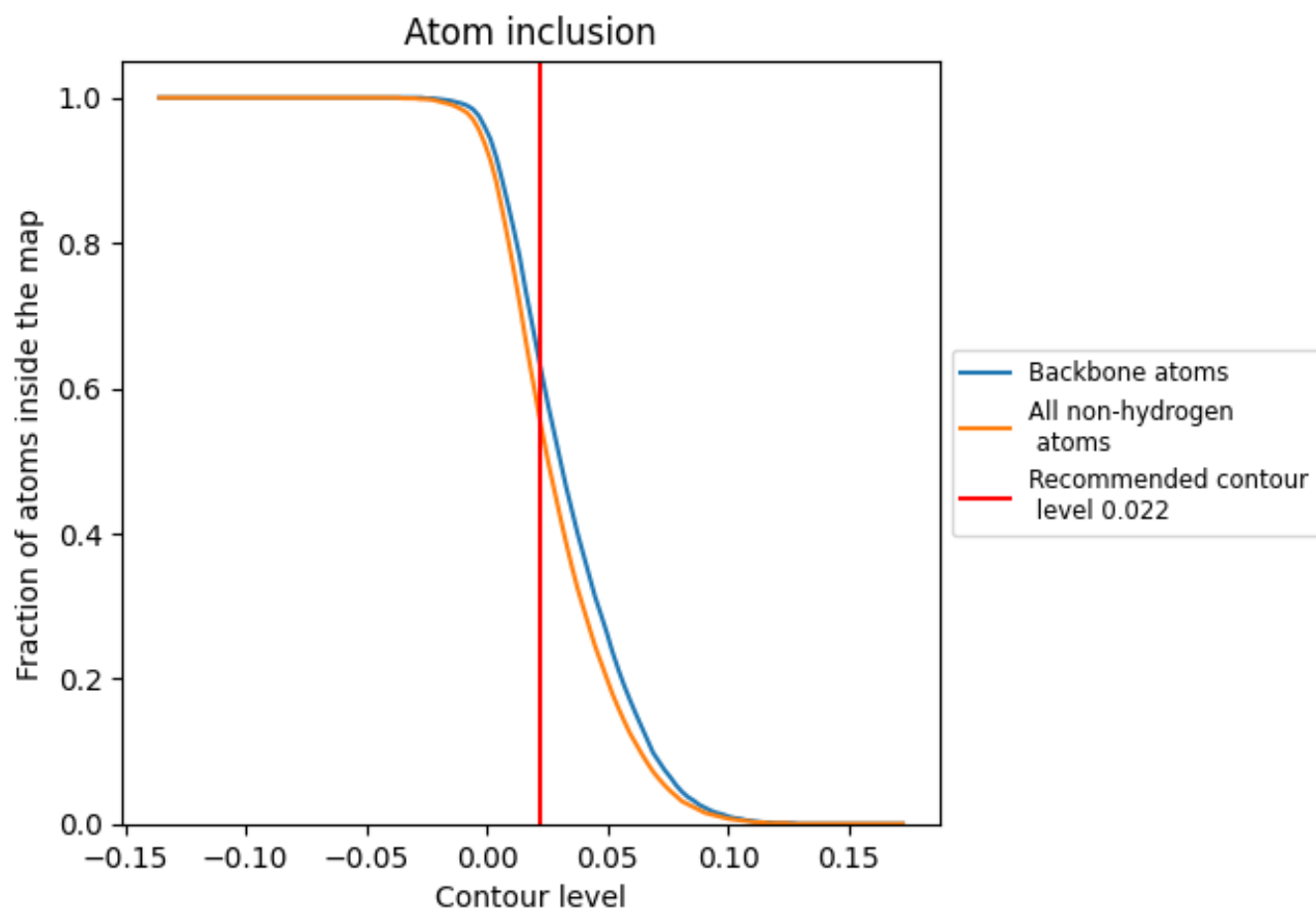























9.4 Atom inclusion [i](#)



At the recommended contour level, 63% of all backbone atoms, 56% of all non-hydrogen atoms, are inside the map.

9.5 Map-model fit summary [i](#)

The table lists the average atom inclusion at the recommended contour level (0.022) and Q-score for the entire model and for each chain.

Chain	Atom inclusion	Q-score
All	 0.5580	 0.3230
A	 0.6020	 0.3810
B	 0.5610	 0.3230
C	 0.4110	 0.2760
D	 0.6020	 0.3780
E	 0.5610	 0.3230
F	 0.4110	 0.2740
G	 0.6010	 0.3780
H	 0.5610	 0.3230
I	 0.4110	 0.2720
J	 0.6020	 0.3790
K	 0.5620	 0.3220
L	 0.4110	 0.2750

