



Full wwPDB X-ray Structure Validation Report ⓘ

Mar 26, 2019 – 02:20 PM EDT

PDB ID : 2YCW
Title : TURKEY BETA1 ADRENERGIC RECEPTOR WITH STABILISING MUTATIONS AND BOUND ANTAGONIST CARAZOLOL
Authors : Moukhametzianov, R.; Warne, T.; Edwards, P.C.; Serrano-Vega, M.J.; Leslie, A.G.W.; Tate, C.G.; Schertler, G.F.X.
Deposited on : 2011-03-17
Resolution : 3.00 Å(reported)

This is a Full wwPDB X-ray Structure Validation Report for a publicly released PDB entry.

We welcome your comments at validation@mail.wwpdb.org

A user guide is available at

<https://www.wwpdb.org/validation/2017/XrayValidationReportHelp>

with specific help available everywhere you see the ⓘ symbol.

The following versions of software and data (see [references ⓘ](#)) were used in the production of this report:

MolProbity : 4.02b-467
Mogul : 1.8.0 (224370), CSD as540be (2019)
Xtrriage (Phenix) : 1.13
EDS : rb-20031633
Percentile statistics : 20171227.v01 (using entries in the PDB archive December 27th 2017)
Refmac : 5.8.0158
CCP4 : 7.0 (Gargrove)
Ideal geometry (proteins) : Engh & Huber (2001)
Ideal geometry (DNA, RNA) : Parkinson et al. (1996)
Validation Pipeline (wwPDB-VP) : rb-20031633

1 Overall quality at a glance

The following experimental techniques were used to determine the structure:

X-RAY DIFFRACTION

The reported resolution of this entry is 3.00 Å.

Percentile scores (ranging between 0-100) for global validation metrics of the entry are shown in the following graphic. The table shows the number of entries on which the scores are based.

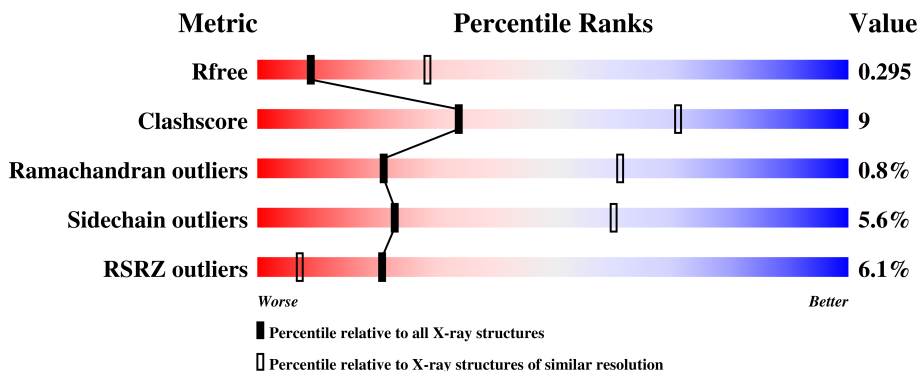

Metric	Whole archive (#Entries)	Similar resolution (#Entries, resolution range(Å))
R_{free}	111664	1851 (3.00-3.00)
Clashscore	122126	2167 (3.00-3.00)
Ramachandran outliers	120053	2101 (3.00-3.00)
Sidechain outliers	120020	2104 (3.00-3.00)
RSRZ outliers	108989	1751 (3.00-3.00)

The table below summarises the geometric issues observed across the polymeric chains and their fit to the electron density. The red, orange, yellow and green segments on the lower bar indicate the fraction of residues that contain outliers for ≥ 3 , 2, 1 and 0 types of geometric quality criteria. A grey segment represents the fraction of residues that are not modelled. The numeric value for each fraction is indicated below the corresponding segment, with a dot representing fractions $\leq 5\%$. The upper red bar (where present) indicates the fraction of residues that have poor fit to the electron density. The numeric value is given above the bar.

Mol	Chain	Length	Quality of chain
1	A	313	 4% 73% 20% • 5%
1	B	313	 8% 74% 19% • 5%

The following table lists non-polymeric compounds, carbohydrate monomers and non-standard residues in protein, DNA, RNA chains that are outliers for geometric or electron-density-fit criteria:

Mol	Type	Chain	Res	Chirality	Geometry	Clashes	Electron density
3	2CV	A	1360	-	-	-	X
3	2CV	B	1362	-	-	-	X

2 Entry composition [i](#)

There are 4 unique types of molecules in this entry. The entry contains 4882 atoms, of which 0 are hydrogens and 0 are deuteriums.

In the tables below, the ZeroOcc column contains the number of atoms modelled with zero occupancy, the AltConf column contains the number of residues with at least one atom in alternate conformation and the Trace column contains the number of residues modelled with at most 2 atoms.

- Molecule 1 is a protein called BETA-1 ADRENERGIC RECEPTOR.

Mol	Chain	Residues	Atoms					ZeroOcc	AltConf	Trace
			Total	C	N	O	S			
1	A	297	2369	1562	395	392	20	0	0	0
1	B	297	2369	1562	395	392	20	0	0	0

There are 92 discrepancies between the modelled and reference sequences:

Chain	Residue	Modelled	Actual	Comment	Reference
A	31	MET	-	expression tag	UNP P07700
A	32	GLY	-	expression tag	UNP P07700
A	68	SER	ARG	engineered mutation	UNP P07700
A	90	VAL	MET	engineered mutation	UNP P07700
A	116	LEU	CYS	engineered mutation	UNP P07700
A	227	ALA	TYR	engineered mutation	UNP P07700
A	?	-	CYS	deletion	UNP P07700
A	?	-	GLU	deletion	UNP P07700
A	?	-	GLY	deletion	UNP P07700
A	?	-	ARG	deletion	UNP P07700
A	?	-	PHE	deletion	UNP P07700
A	?	-	TYR	deletion	UNP P07700
A	?	-	GLY	deletion	UNP P07700
A	?	-	SER	deletion	UNP P07700
A	?	-	GLN	deletion	UNP P07700
A	?	-	GLU	deletion	UNP P07700
A	?	-	GLN	deletion	UNP P07700
A	?	-	PRO	deletion	UNP P07700
A	?	-	GLN	deletion	UNP P07700
A	?	-	PRO	deletion	UNP P07700
A	?	-	PRO	deletion	UNP P07700
A	?	-	PRO	deletion	UNP P07700
A	?	-	LEU	deletion	UNP P07700
A	?	-	PRO	deletion	UNP P07700
A	?	-	GLN	deletion	UNP P07700

Continued on next page...

Continued from previous page...

Chain	Residue	Modelled	Actual	Comment	Reference
A	?	-	HIS	deletion	UNP P07700
A	?	-	GLN	deletion	UNP P07700
A	?	-	PRO	deletion	UNP P07700
A	?	-	ILE	deletion	UNP P07700
A	?	-	LEU	deletion	UNP P07700
A	?	-	GLY	deletion	UNP P07700
A	?	-	ASN	deletion	UNP P07700
A	?	-	GLY	deletion	UNP P07700
A	?	-	ARG	deletion	UNP P07700
A	?	-	THR	deletion	UNP P07700
A	?	-	SER	deletion	UNP P07700
A	282	LEU	ALA	engineered mutation	UNP P07700
A	327	ALA	PHE	engineered mutation	UNP P07700
A	338	MET	PHE	engineered mutation	UNP P07700
A	358	ALA	CYS	engineered mutation	UNP P07700
A	368	HIS	-	expression tag	UNP P07700
A	369	HIS	-	expression tag	UNP P07700
A	370	HIS	-	expression tag	UNP P07700
A	371	HIS	-	expression tag	UNP P07700
A	372	HIS	-	expression tag	UNP P07700
A	373	HIS	-	expression tag	UNP P07700
B	31	MET	-	expression tag	UNP P07700
B	32	GLY	-	expression tag	UNP P07700
B	68	SER	ARG	engineered mutation	UNP P07700
B	90	VAL	MET	engineered mutation	UNP P07700
B	116	LEU	CYS	engineered mutation	UNP P07700
B	227	ALA	TYR	engineered mutation	UNP P07700
B	?	-	CYS	deletion	UNP P07700
B	?	-	GLU	deletion	UNP P07700
B	?	-	GLY	deletion	UNP P07700
B	?	-	ARG	deletion	UNP P07700
B	?	-	PHE	deletion	UNP P07700
B	?	-	TYR	deletion	UNP P07700
B	?	-	GLY	deletion	UNP P07700
B	?	-	SER	deletion	UNP P07700
B	?	-	GLN	deletion	UNP P07700
B	?	-	GLU	deletion	UNP P07700
B	?	-	GLN	deletion	UNP P07700
B	?	-	PRO	deletion	UNP P07700
B	?	-	GLN	deletion	UNP P07700
B	?	-	PRO	deletion	UNP P07700
B	?	-	PRO	deletion	UNP P07700

Continued on next page...

Continued from previous page...

Chain	Residue	Modelled	Actual	Comment	Reference
B	?	-	PRO	deletion	UNP P07700
B	?	-	LEU	deletion	UNP P07700
B	?	-	PRO	deletion	UNP P07700
B	?	-	GLN	deletion	UNP P07700
B	?	-	HIS	deletion	UNP P07700
B	?	-	GLN	deletion	UNP P07700
B	?	-	PRO	deletion	UNP P07700
B	?	-	ILE	deletion	UNP P07700
B	?	-	LEU	deletion	UNP P07700
B	?	-	GLY	deletion	UNP P07700
B	?	-	ASN	deletion	UNP P07700
B	?	-	GLY	deletion	UNP P07700
B	?	-	ARG	deletion	UNP P07700
B	?	-	THR	deletion	UNP P07700
B	?	-	SER	deletion	UNP P07700
B	282	LEU	ALA	engineered mutation	UNP P07700
B	327	ALA	PHE	engineered mutation	UNP P07700
B	338	MET	PHE	engineered mutation	UNP P07700
B	358	ALA	CYS	engineered mutation	UNP P07700
B	368	HIS	-	expression tag	UNP P07700
B	369	HIS	-	expression tag	UNP P07700
B	370	HIS	-	expression tag	UNP P07700
B	371	HIS	-	expression tag	UNP P07700
B	372	HIS	-	expression tag	UNP P07700
B	373	HIS	-	expression tag	UNP P07700

- Molecule 2 is (2S)-1-(9H-Carbazol-4-yloxy)-3-(isopropylamino)propan-2-ol (three-letter code: CAU) (formula: C₁₈H₂₂N₂O₂).

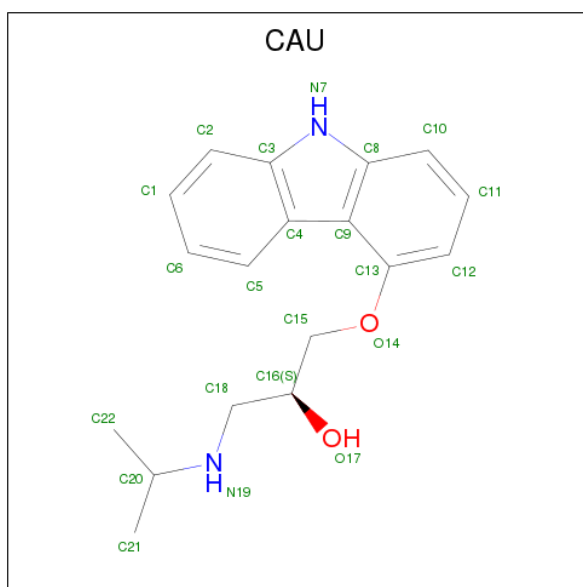

Mol	Chain	Residues	Atoms				ZeroOcc	AltConf
2	A	1	Total	C	N	O	0	0
			22	18	2	2		
2	B	1	Total	C	N	O	0	0
			22	18	2	2		

- Molecule 3 is HEGA-10 (three-letter code: 2CV) (formula: $C_{18}H_{37}NO_7$).

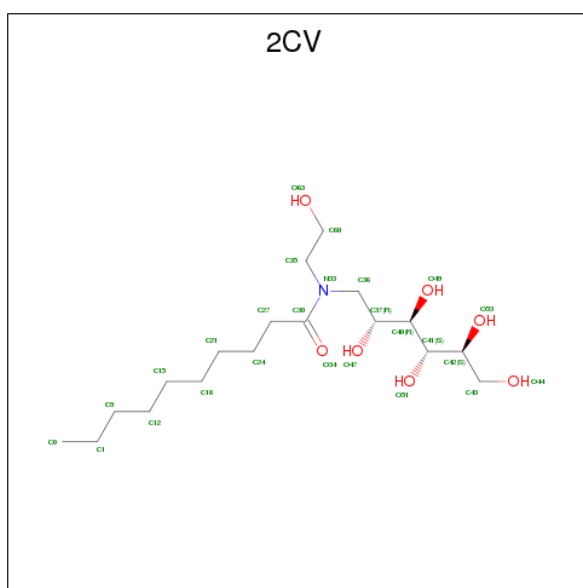

Mol	Chain	Residues	Atoms				ZeroOcc	AltConf
3	A	1	Total	C	N	O	0	0
			26	18	1	7		
3	A	1	Total	C	N	O	0	0
			26	18	1	7		

Continued on next page...

Continued from previous page...

Mol	Chain	Residues	Atoms	ZeroOcc	AltConf
3	B	1	Total C N O 26 18 1 7	0	0
3	B	1	Total C 10 10	0	0
3	B	1	Total C 10 10	0	0

- Molecule 4 is SODIUM ION (three-letter code: NA) (formula: Na).

Mol	Chain	Residues	Atoms	ZeroOcc	AltConf
4	B	1	Total Na 1 1	0	0
4	A	1	Total Na 1 1	0	0

3 Residue-property plots i

These plots are drawn for all protein, RNA and DNA chains in the entry. The first graphic for a chain summarises the proportions of the various outlier classes displayed in the second graphic. The second graphic shows the sequence view annotated by issues in geometry and electron density. Residues are color-coded according to the number of geometric quality criteria for which they contain at least one outlier: green = 0, yellow = 1, orange = 2 and red = 3 or more. A red dot above a residue indicates a poor fit to the electron density ($RSRZ > 2$). Stretches of 2 or more consecutive residues without any outlier are shown as a green connector. Residues present in the sample, but not in the model, are shown in grey.

• Molecule 1: BETA-1 ADRENERGIC RECEPTOR

Chain A: 

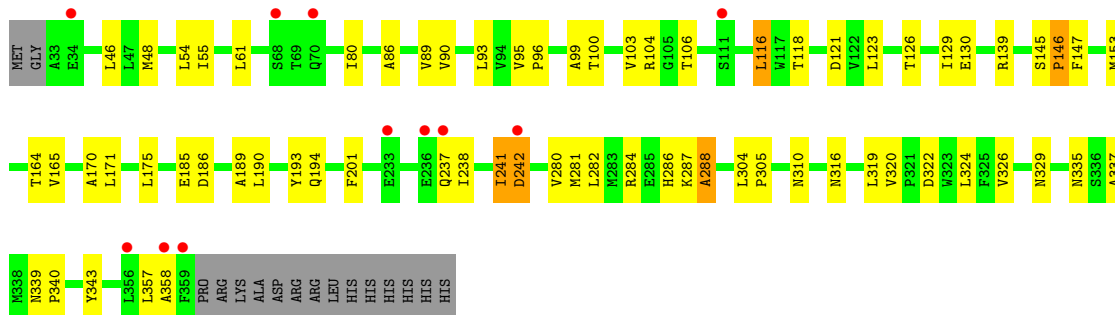

• Molecule 1: BETA-1 ADRENERGIC RECEPTOR

Chain B: 

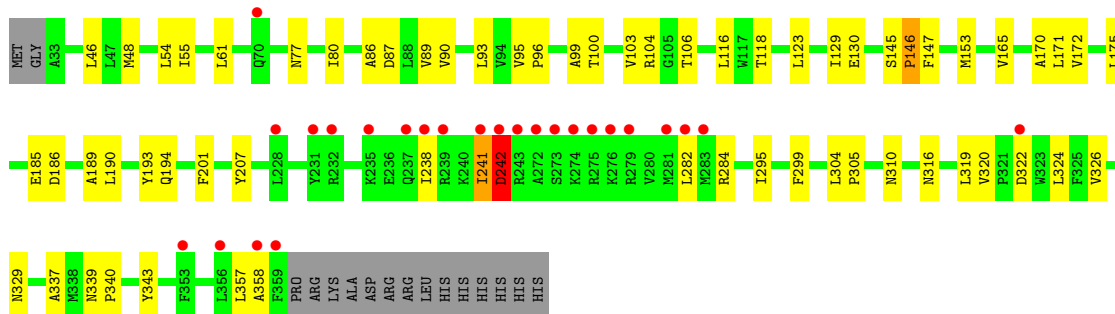

4 Data and refinement statistics i

Property	Value	Source
Space group	P 1 21 1	Depositor
Cell constants a, b, c, α , β , γ	89.40Å 57.06Å 109.54Å 90.00° 113.52° 90.00°	Depositor
Resolution (Å)	44.68 – 3.00 44.70 – 3.00	Depositor EDS
% Data completeness (in resolution range)	100.0 (44.68-3.00) 86.8 (44.70-3.00)	Depositor EDS
R_{merge}	0.10	Depositor
R_{sym}	(Not available)	Depositor
$\langle I/\sigma(I) \rangle$ ¹	1.85 (at 3.01Å)	Xtrriage
Refinement program	REFMAC 5.5.0109	Depositor
R, R_{free}	0.248 , 0.295 0.248 , 0.295	Depositor DCC
R_{free} test set	913 reflections (5.10%)	wwPDB-VP
Wilson B-factor (Å ²)	74.3	Xtrriage
Anisotropy	0.428	Xtrriage
Bulk solvent k_{sol} (e/Å ³), B_{sol} (Å ²)	0.33 , 53.4	EDS
L-test for twinning ²	$\langle L \rangle = 0.47$, $\langle L^2 \rangle = 0.30$	Xtrriage
Estimated twinning fraction	0.032 for h,-k,-h-l	Xtrriage
F_o, F_c correlation	0.91	EDS
Total number of atoms	4882	wwPDB-VP
Average B, all atoms (Å ²)	66.0	wwPDB-VP

Xtrriage's analysis on translational NCS is as follows: *The largest off-origin peak in the Patterson function is 7.26% of the height of the origin peak. No significant pseudotranslation is detected.*

¹Intensities estimated from amplitudes.

²Theoretical values of $\langle |L| \rangle$, $\langle L^2 \rangle$ for acentric reflections are 0.5, 0.333 respectively for untwinned datasets, and 0.375, 0.2 for perfectly twinned datasets.

5 Model quality [i](#)

5.1 Standard geometry [i](#)

Bond lengths and bond angles in the following residue types are not validated in this section: NA, 2CV, CAU

The Z score for a bond length (or angle) is the number of standard deviations the observed value is removed from the expected value. A bond length (or angle) with $|Z| > 5$ is considered an outlier worth inspection. RMSZ is the root-mean-square of all Z scores of the bond lengths (or angles).

Mol	Chain	Bond lengths		Bond angles	
		RMSZ	# Z >5	RMSZ	# Z >5
1	A	0.46	0/2425	0.57	0/3301
1	B	0.48	0/2425	0.58	0/3301
All	All	0.47	0/4850	0.57	0/6602

Chiral center outliers are detected by calculating the chiral volume of a chiral center and verifying if the center is modelled as a planar moiety or with the opposite hand. A planarity outlier is detected by checking planarity of atoms in a peptide group, atoms in a mainchain group or atoms of a sidechain that are expected to be planar.

Mol	Chain	#Chirality outliers	#Planarity outliers
1	A	0	1
1	B	0	1
All	All	0	2

There are no bond length outliers.

There are no bond angle outliers.

There are no chirality outliers.

All (2) planarity outliers are listed below:

Mol	Chain	Res	Type	Group
1	A	146	PRO	Peptide
1	B	146	PRO	Peptide

5.2 Too-close contacts [i](#)

In the following table, the Non-H and H(model) columns list the number of non-hydrogen atoms and hydrogen atoms in the chain respectively. The H(added) column lists the number of hydrogen atoms added and optimized by MolProbity. The Clashes column lists the number of clashes within the asymmetric unit, whereas Symm-Clashes lists symmetry related clashes.

Mol	Chain	Non-H	H(model)	H(added)	Clashes	Symm-Clashes
1	A	2369	0	2468	46	0
1	B	2369	0	2468	38	0
2	A	22	0	22	2	0
2	B	22	0	22	1	0
3	A	52	0	74	6	0
3	B	46	0	75	5	0
4	A	1	0	0	0	0
4	B	1	0	0	0	0
All	All	4882	0	5129	91	0

The all-atom clashscore is defined as the number of clashes found per 1000 atoms (including hydrogen atoms). The all-atom clashscore for this structure is 9.

All (91) close contacts within the same asymmetric unit are listed below, sorted by their clash magnitude.

Atom-1	Atom-2	Interatomic distance (Å)	Clash overlap (Å)
1:A:175:LEU:HD13	1:B:175:LEU:HD13	1.31	1.11
3:B:1360:2CV:H351	3:B:1360:2CV:O49	1.59	1.03
3:A:1361:2CV:H431	3:B:1362:2CV:H03C	1.41	1.01
1:B:171:LEU:HD12	1:B:175:LEU:HD12	1.48	0.95
1:A:171:LEU:HD12	1:A:175:LEU:HD12	1.47	0.94
1:B:241:ILE:HD11	1:B:282:LEU:HD12	1.51	0.92
1:A:89:VAL:HG13	1:A:93:LEU:HD12	1.67	0.76
1:A:171:LEU:HD12	1:A:175:LEU:CD1	2.16	0.74
1:B:171:LEU:HD12	1:B:175:LEU:CD1	2.18	0.73
1:A:287:LYS:O	1:A:288:ALA:CB	2.38	0.72
1:A:241:ILE:HG23	1:A:242:ASP:N	2.07	0.70
1:B:89:VAL:HG13	1:B:93:LEU:HD12	1.73	0.68
3:A:1361:2CV:H431	3:B:1362:2CV:C0	2.22	0.66
1:B:241:ILE:HG22	1:B:242:ASP:N	2.09	0.66
1:B:55:ILE:CG1	1:B:337:ALA:HB2	2.27	0.65
1:B:118:THR:HG21	1:B:201:PHE:CE1	2.32	0.65
1:B:55:ILE:HG13	1:B:337:ALA:HB2	1.81	0.63
1:A:55:ILE:CG1	1:A:337:ALA:HB2	2.29	0.61
1:A:118:THR:HG21	1:A:201:PHE:CE1	2.35	0.61
1:A:287:LYS:O	1:A:288:ALA:HB3	2.00	0.61
1:A:241:ILE:HG23	1:A:242:ASP:H	1.67	0.60
1:B:320:VAL:HG13	1:B:324:LEU:HD23	1.84	0.59
1:A:189:ALA:HB1	1:A:193:TYR:CZ	2.39	0.58
1:A:116:LEU:HD12	1:A:116:LEU:O	2.04	0.57
1:B:116:LEU:O	1:B:116:LEU:HD12	2.04	0.57
1:B:86:ALA:O	1:B:90:VAL:HG23	2.04	0.57

Continued on next page...

Continued from previous page...

Atom-1	Atom-2	Interatomic distance (Å)	Clash overlap (Å)
1:A:55:ILE:HG13	1:A:337:ALA:HB2	1.86	0.56
1:B:320:VAL:CG1	1:B:324:LEU:HD23	2.35	0.56
1:A:320:VAL:HG13	1:A:324:LEU:HD23	1.88	0.56
1:B:316:ASN:ND2	1:B:319:LEU:HD22	2.21	0.55
1:A:130:GLU:HB3	1:A:165:VAL:HG13	1.90	0.54
1:A:237:GLN:HE22	1:A:282:LEU:HD22	1.73	0.54
1:A:241:ILE:CG2	1:A:242:ASP:N	2.71	0.54
1:A:339:ASN:HB2	1:A:340:PRO:HD3	1.90	0.54
1:A:237:GLN:OE1	1:A:286:HIS:NE2	2.37	0.53
1:B:130:GLU:HB3	1:B:165:VAL:HG13	1.91	0.53
1:A:164:THR:HG23	3:B:1360:2CV:H431	1.91	0.53
1:A:118:THR:HG21	1:A:201:PHE:CD1	2.43	0.52
1:B:339:ASN:HB2	1:B:340:PRO:HD3	1.90	0.52
1:A:320:VAL:CG1	1:A:324:LEU:HD23	2.40	0.52
1:A:319:LEU:O	1:A:319:LEU:HD12	2.10	0.52
1:A:121:ASP:OD1	2:A:400:CAU:O17	2.20	0.51
1:B:103:VAL:HG12	1:B:104:ARG:N	2.25	0.51
1:B:95:VAL:O	1:B:99:ALA:N	2.36	0.51
1:A:310:ASN:HD21	2:A:400:CAU:C6	2.24	0.51
1:A:96:PRO:O	1:A:100:THR:HG23	2.11	0.51
1:B:55:ILE:HG12	1:B:337:ALA:HB2	1.93	0.51
1:A:55:ILE:HG12	1:A:337:ALA:HB2	1.92	0.50
1:A:316:ASN:ND2	1:A:319:LEU:HD22	2.26	0.50
1:B:118:THR:HG21	1:B:201:PHE:CD1	2.46	0.50
1:B:319:LEU:HD12	1:B:319:LEU:O	2.11	0.50
1:A:280:VAL:HG12	1:A:280:VAL:O	2.12	0.50
1:A:322:ASP:O	1:A:326:VAL:HG23	2.12	0.49
1:B:189:ALA:HB1	1:B:193:TYR:CZ	2.47	0.48
3:A:1360:2CV:H40	3:A:1360:2CV:H432	1.56	0.48
1:A:89:VAL:HG13	1:A:93:LEU:CD1	2.40	0.48
1:B:96:PRO:O	1:B:100:THR:HG23	2.14	0.48
3:B:1360:2CV:H272	3:B:1360:2CV:H361	1.65	0.47
1:A:103:VAL:HG12	1:A:104:ARG:N	2.29	0.47
1:B:129:ILE:HD13	1:B:299:PHE:CE1	2.50	0.47
1:B:80:ILE:HG23	1:B:343:TYR:OH	2.16	0.46
3:A:1361:2CV:H271	3:A:1361:2CV:O47	2.15	0.45
1:A:95:VAL:O	1:A:96:PRO:C	2.55	0.45
1:B:322:ASP:O	1:B:326:VAL:HG23	2.16	0.45
1:A:86:ALA:O	1:A:90:VAL:HG23	2.17	0.45
1:B:357:LEU:O	1:B:358:ALA:HB3	2.17	0.44
1:A:189:ALA:HB1	1:A:193:TYR:OH	2.16	0.44

Continued on next page...

Continued from previous page...

Atom-1	Atom-2	Interatomic distance (Å)	Clash overlap (Å)
1:B:310:ASN:HD21	2:B:400:CAU:C6	2.29	0.44
1:A:304:LEU:N	1:A:305:PRO:CD	2.80	0.44
1:A:238:ILE:HG13	1:A:241:ILE:HD12	1.99	0.44
1:B:304:LEU:N	1:B:305:PRO:CD	2.81	0.44
1:B:190:LEU:O	1:B:194:GLN:HG2	2.17	0.43
1:A:190:LEU:O	1:A:194:GLN:HG2	2.18	0.43
1:B:238:ILE:HG13	1:B:241:ILE:HD12	2.01	0.43
1:A:95:VAL:O	1:A:99:ALA:N	2.38	0.43
1:A:357:LEU:O	1:A:358:ALA:HB3	2.19	0.42
1:B:89:VAL:HG13	1:B:93:LEU:CD1	2.46	0.42
1:B:207:TYR:CD1	1:B:207:TYR:C	2.93	0.42
1:B:87:ASP:O	1:B:90:VAL:HB	2.20	0.42
1:B:46:LEU:HA	1:B:46:LEU:HD12	1.94	0.41
3:A:1360:2CV:H352	3:A:1360:2CV:H271	1.77	0.41
1:A:126:THR:O	1:A:129:ILE:HG22	2.21	0.41
1:B:295:ILE:CD1	1:B:339:ASN:OD1	2.68	0.41
3:A:1361:2CV:H362	3:A:1361:2CV:C24	2.51	0.41
1:A:139:ARG:NE	1:A:139:ARG:HA	2.36	0.41
1:A:80:ILE:HD12	1:A:343:TYR:OH	2.21	0.41
1:A:123:LEU:HD13	1:A:170:ALA:HA	2.03	0.41
1:B:77:ASN:HA	1:B:80:ILE:HB	2.03	0.40
1:A:80:ILE:HG23	1:A:343:TYR:OH	2.20	0.40
1:A:46:LEU:HD12	1:A:46:LEU:HA	1.91	0.40
1:B:123:LEU:HD13	1:B:170:ALA:HA	2.03	0.40

There are no symmetry-related clashes.

5.3 Torsion angles [i](#)

5.3.1 Protein backbone [i](#)

In the following table, the Percentiles column shows the percent Ramachandran outliers of the chain as a percentile score with respect to all X-ray entries followed by that with respect to entries of similar resolution.

The Analysed column shows the number of residues for which the backbone conformation was analysed, and the total number of residues.

Mol	Chain	Analysed	Favoured	Allowed	Outliers	Percentiles
1	A	295/313 (94%)	265 (90%)	27 (9%)	3 (1%)	17 56

Continued on next page...

Continued from previous page...

Mol	Chain	Analysed	Favoured	Allowed	Outliers	Percentiles	
1	B	295/313 (94%)	268 (91%)	25 (8%)	2 (1%)	24	64
All	All	590/626 (94%)	533 (90%)	52 (9%)	5 (1%)	21	61

All (5) Ramachandran outliers are listed below:

Mol	Chain	Res	Type
1	B	242	ASP
1	A	242	ASP
1	A	288	ALA
1	A	146	PRO
1	B	146	PRO

5.3.2 Protein sidechains [i](#)

In the following table, the Percentiles column shows the percent sidechain outliers of the chain as a percentile score with respect to all X-ray entries followed by that with respect to entries of similar resolution.

The Analysed column shows the number of residues for which the sidechain conformation was analysed, and the total number of residues.

Mol	Chain	Analysed	Rotameric	Outliers	Percentiles	
1	A	257/271 (95%)	242 (94%)	15 (6%)	22	59
1	B	257/271 (95%)	243 (95%)	14 (5%)	24	62
All	All	514/542 (95%)	485 (94%)	29 (6%)	23	60

All (29) residues with a non-rotameric sidechain are listed below:

Mol	Chain	Res	Type
1	A	48	MET
1	A	54	LEU
1	A	61	LEU
1	A	106	THR
1	A	116	LEU
1	A	145	SER
1	A	147	PHE
1	A	153	MET
1	A	185	GLU
1	A	186	ASP
1	A	241	ILE

Continued on next page...

Continued from previous page...

Mol	Chain	Res	Type
1	A	281	MET
1	A	284	ARG
1	A	329	ASN
1	A	335	ASN
1	B	48	MET
1	B	54	LEU
1	B	61	LEU
1	B	106	THR
1	B	145	SER
1	B	147	PHE
1	B	153	MET
1	B	172	VAL
1	B	185	GLU
1	B	186	ASP
1	B	241	ILE
1	B	242	ASP
1	B	284	ARG
1	B	329	ASN

Some sidechains can be flipped to improve hydrogen bonding and reduce clashes. All (2) such sidechains are listed below:

Mol	Chain	Res	Type
1	A	310	ASN
1	B	310	ASN

5.3.3 RNA [i](#)

There are no RNA molecules in this entry.

5.4 Non-standard residues in protein, DNA, RNA chains [i](#)

There are no non-standard protein/DNA/RNA residues in this entry.

5.5 Carbohydrates [i](#)

There are no carbohydrates in this entry.

5.6 Ligand geometry

Of 9 ligands modelled in this entry, 2 are monoatomic - leaving 7 for Mogul analysis.

In the following table, the Counts columns list the number of bonds (or angles) for which Mogul statistics could be retrieved, the number of bonds (or angles) that are observed in the model and the number of bonds (or angles) that are defined in the Chemical Component Dictionary. The Link column lists molecule types, if any, to which the group is linked. The Z score for a bond length (or angle) is the number of standard deviations the observed value is removed from the expected value. A bond length (or angle) with $|Z| > 2$ is considered an outlier worth inspection. RMSZ is the root-mean-square of all Z scores of the bond lengths (or angles).

Mol	Type	Chain	Res	Link	Bond lengths			Bond angles		
					Counts	RMSZ	# Z > 2	Counts	RMSZ	# Z > 2
3	2CV	A	1360	-	25,25,25	0.73	0	29,30,30	0.68	0
3	2CV	A	1361	-	25,25,25	0.63	0	29,30,30	0.56	0
2	CAU	A	400	-	22,24,24	1.04	0	31,33,33	1.10	2 (6%)
3	2CV	B	1360	-	25,25,25	0.86	2 (8%)	29,30,30	1.06	1 (3%)
3	2CV	B	1361	-	9,9,25	0.61	0	8,8,30	0.38	0
3	2CV	B	1362	-	9,9,25	0.58	0	8,8,30	0.39	0
2	CAU	B	400	-	22,24,24	1.11	1 (4%)	31,33,33	0.97	3 (9%)

In the following table, the Chirals column lists the number of chiral outliers, the number of chiral centers analysed, the number of these observed in the model and the number defined in the Chemical Component Dictionary. Similar counts are reported in the Torsion and Rings columns. '-' means no outliers of that kind were identified.

Mol	Type	Chain	Res	Link	Chirals	Torsions	Rings
3	2CV	A	1360	-	-	0/34/34/34	0/0/0/0
3	2CV	A	1361	-	-	0/34/34/34	0/0/0/0
2	CAU	A	400	-	-	0/10/10/10	0/3/3/3
3	2CV	B	1360	-	-	0/34/34/34	0/0/0/0
3	2CV	B	1361	-	-	0/7/7/34	0/0/0/0
3	2CV	B	1362	-	-	0/7/7/34	0/0/0/0
2	CAU	B	400	-	-	0/10/10/10	0/3/3/3

All (3) bond length outliers are listed below:

Mol	Chain	Res	Type	Atoms	Z	Observed(Å)	Ideal(Å)
2	B	400	CAU	C10-C8	-2.15	1.38	1.41
3	B	1360	2CV	C42-C41	2.11	1.57	1.53
3	B	1360	2CV	C36-C37	2.33	1.56	1.52

All (6) bond angle outliers are listed below:

Mol	Chain	Res	Type	Atoms	Z	Observed(°)	Ideal(°)
2	A	400	CAU	C18-N19-C20	-3.30	103.62	114.59
2	B	400	CAU	C18-N19-C20	-2.99	104.64	114.59
2	A	400	CAU	C12-C13-C9	-2.47	118.58	121.58
2	B	400	CAU	C12-C13-C9	-2.24	118.86	121.58
2	B	400	CAU	C5-C4-C3	2.34	121.28	118.17
3	B	1360	2CV	C35-N33-C36	3.50	120.48	116.35

There are no chirality outliers.

There are no torsion outliers.

There are no ring outliers.

6 monomers are involved in 12 short contacts:

Mol	Chain	Res	Type	Clashes	Symm-Clashes
3	A	1360	2CV	2	0
3	A	1361	2CV	4	0
2	A	400	CAU	2	0
3	B	1360	2CV	3	0
3	B	1362	2CV	2	0
2	B	400	CAU	1	0

5.7 Other polymers [i](#)

There are no such residues in this entry.

5.8 Polymer linkage issues [i](#)

There are no chain breaks in this entry.

6 Fit of model and data

6.1 Protein, DNA and RNA chains

In the following table, the column labelled ‘#RSRZ > 2’ contains the number (and percentage) of RSRZ outliers, followed by percent RSRZ outliers for the chain as percentile scores relative to all X-ray entries and entries of similar resolution. The OWAB column contains the minimum, median, 95th percentile and maximum values of the occupancy-weighted average B-factor per residue. The column labelled ‘Q < 0.9’ lists the number of (and percentage) of residues with an average occupancy less than 0.9.

Mol	Chain	Analysed	<RSRZ>	#RSRZ>2	OWAB(Å ²)	Q<0.9
1	A	297/313 (94%)	0.11	11 (3%) 41 17	34, 61, 102, 137	0
1	B	297/313 (94%)	0.23	25 (8%) 11 3	34, 61, 112, 138	0
All	All	594/626 (94%)	0.17	36 (6%) 21 7	34, 61, 105, 138	0

All (36) RSRZ outliers are listed below:

Mol	Chain	Res	Type	RSRZ
1	B	241	ILE	6.0
1	B	238	ILE	5.3
1	B	275	ARG	4.8
1	A	359	PHE	4.7
1	B	283	MET	4.6
1	B	274	LYS	4.6
1	B	242	ASP	4.4
1	B	272	ALA	3.8
1	B	281	MET	3.6
1	A	233	GLU	3.5
1	B	239	ARG	3.4
1	A	70	GLN	3.3
1	B	276	LYS	3.2
1	A	236	GLU	3.0
1	B	279	ARG	2.9
1	B	235	LYS	2.9
1	B	359	PHE	2.7
1	B	243	ARG	2.6
1	B	358	ALA	2.6
1	B	353	PHE	2.6
1	A	358	ALA	2.6
1	A	34	GLU	2.5
1	B	273	SER	2.5
1	B	282	LEU	2.4

Continued on next page...

Continued from previous page...

Mol	Chain	Res	Type	RSRZ
1	B	237	GLN	2.4
1	B	232	ARG	2.4
1	B	231	TYR	2.4
1	A	111	SER	2.3
1	A	237	GLN	2.3
1	A	356	LEU	2.3
1	B	70	GLN	2.3
1	A	242	ASP	2.3
1	B	322	ASP	2.1
1	A	68	SER	2.1
1	B	356	LEU	2.0
1	B	228	LEU	2.0

6.2 Non-standard residues in protein, DNA, RNA chains [i](#)

There are no non-standard protein/DNA/RNA residues in this entry.

6.3 Carbohydrates [i](#)

There are no carbohydrates in this entry.

6.4 Ligands [i](#)

In the following table, the Atoms column lists the number of modelled atoms in the group and the number defined in the chemical component dictionary. The B-factors column lists the minimum, median, 95th percentile and maximum values of B factors of atoms in the group. The column labelled 'Q< 0.9' lists the number of atoms with occupancy less than 0.9.

Mol	Type	Chain	Res	Atoms	RSCC	RSR	B-factors(Å ²)	Q<0.9
3	2CV	B	1362	10/26	0.75	0.43	75,77,77,77	0
4	NA	B	1363	1/1	0.76	0.35	67,67,67,67	0
3	2CV	A	1360	26/26	0.79	0.45	91,110,112,113	0
3	2CV	B	1360	26/26	0.82	0.26	67,78,84,85	0
3	2CV	B	1361	10/26	0.83	0.74	63,65,66,66	0
4	NA	A	1362	1/1	0.83	0.31	64,64,64,64	0
3	2CV	A	1361	26/26	0.88	0.22	62,78,81,82	0
2	CAU	B	400	22/22	0.94	0.26	48,50,51,52	0
2	CAU	A	400	22/22	0.97	0.24	48,53,54,54	0

6.5 Other polymers [i](#)

There are no such residues in this entry.