



Full wwPDB EM Validation Report ⓘ

Oct 30, 2024 – 12:12 PM JST

PDB ID : 8YH5
EMDB ID : EMD-39281
Title : A3R-Gi complex bound to i6A
Authors : Oshima, H.S.; Shihoya, W.; Nureki, O.
Deposited on : 2024-02-27
Resolution : 3.66 Å (reported)

This is a Full wwPDB EM Validation Report for a publicly released PDB entry.

We welcome your comments at validation@mail.wwpdb.org

A user guide is available at

<https://www.wwpdb.org/validation/2017/EMValidationReportHelp>

with specific help available everywhere you see the ⓘ symbol.

The types of validation reports are described at

<http://www.wwpdb.org/validation/2017/FAQs#types>.

The following versions of software and data (see [references ⓘ](#)) were used in the production of this report:

EMDB validation analysis : 0.0.1.dev113
Mogul : 1.8.5 (274361), CSD as541be (2020)
MolProbity : 4.02b-467
buster-report : 1.1.7 (2018)
Percentile statistics : 20231227.v01 (using entries in the PDB archive December 27th 2023)
MapQ : 1.9.13
Ideal geometry (proteins) : Engh & Huber (2001)
Ideal geometry (DNA, RNA) : Parkinson et al. (1996)
Validation Pipeline (wwPDB-VP) : 2.39

1 Overall quality at a glance

The following experimental techniques were used to determine the structure:
ELECTRON MICROSCOPY

The reported resolution of this entry is 3.66 Å.

Percentile scores (ranging between 0-100) for global validation metrics of the entry are shown in the following graphic. The table shows the number of entries on which the scores are based.

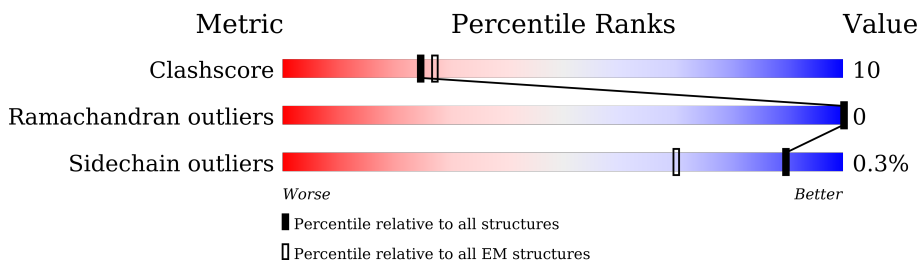

Metric	Whole archive (#Entries)	EM structures (#Entries)
Clashscore	210492	15764
Ramachandran outliers	207382	16835
Sidechain outliers	206894	16415

The table below summarises the geometric issues observed across the polymeric chains and their fit to the map. The red, orange, yellow and green segments of the bar indicate the fraction of residues that contain outliers for ≥ 3 , 2, 1 and 0 types of geometric quality criteria respectively. A grey segment represents the fraction of residues that are not modelled. The numeric value for each fraction is indicated below the corresponding segment, with a dot representing fractions $\leq 5\%$. The upper red bar (where present) indicates the fraction of residues that have poor fit to the EM map (all-atom inclusion $< 40\%$). The numeric value is given above the bar.

Mol	Chain	Length	Quality of chain
1	B	375	
2	A	433	
2	G	433	
3	S	260	
4	R	794	

2 Entry composition [i](#)

There are 5 unique types of molecules in this entry. The entry contains 8695 atoms, of which 0 are hydrogens and 0 are deuteriums.

In the tables below, the AltConf column contains the number of residues with at least one atom in alternate conformation and the Trace column contains the number of residues modelled with at most 2 atoms.

- Molecule 1 is a protein called Guanine nucleotide-binding protein G(I)/G(S)/G(T) subunit beta-1.

Mol	Chain	Residues	Atoms					AltConf	Trace
			Total	C	N	O	S		
1	B	336	2583	1593	465	504	21	0	0

There are 36 discrepancies between the modelled and reference sequences:

Chain	Residue	Modelled	Actual	Comment	Reference
B	-4	MET	-	initiating methionine	UNP P62871
B	-3	GLY	-	expression tag	UNP P62871
B	-2	SER	-	expression tag	UNP P62871
B	-1	LEU	-	expression tag	UNP P62871
B	0	LEU	-	expression tag	UNP P62871
B	1	GLN	-	expression tag	UNP P62871
B	341	GLY	-	expression tag	UNP P62871
B	342	ALA	-	expression tag	UNP P62871
B	343	SER	-	expression tag	UNP P62871
B	344	GLY	-	expression tag	UNP P62871
B	345	GLY	-	expression tag	UNP P62871
B	346	GLY	-	expression tag	UNP P62871
B	347	SER	-	expression tag	UNP P62871
B	348	GLY	-	expression tag	UNP P62871
B	349	GLY	-	expression tag	UNP P62871
B	350	ASN	-	expression tag	UNP P62871
B	351	SER	-	expression tag	UNP P62871
B	352	GLY	-	expression tag	UNP P62871
B	353	SER	-	expression tag	UNP P62871
B	354	SER	-	expression tag	UNP P62871
B	355	GLY	-	expression tag	UNP P62871
B	356	GLY	-	expression tag	UNP P62871
B	357	SER	-	expression tag	UNP P62871
B	358	SER	-	expression tag	UNP P62871
B	359	GLY	-	expression tag	UNP P62871
B	360	VAL	-	expression tag	UNP P62871
B	361	SER	-	expression tag	UNP P62871

Continued on next page...

Continued from previous page...

Chain	Residue	Modelled	Actual	Comment	Reference
B	362	GLY	-	expression tag	UNP P62871
B	363	TRP	-	expression tag	UNP P62871
B	364	ARG	-	expression tag	UNP P62871
B	365	LEU	-	expression tag	UNP P62871
B	366	PHE	-	expression tag	UNP P62871
B	367	LYS	-	expression tag	UNP P62871
B	368	LYS	-	expression tag	UNP P62871
B	369	ILE	-	expression tag	UNP P62871
B	370	SER	-	expression tag	UNP P62871

- Molecule 2 is a protein called Guanine nucleotide-binding protein G(I)/G(S)/G(O) subunit gamma-2, Guanine nucleotide-binding protein G(i) subunit alpha-1 chimera.

Mol	Chain	Residues	Atoms					AltConf	Trace
2	G	53	Total	C	N	O	S	0	0
			407	257	70	77	3		
2	A	211	Total	C	N	O	S	0	0
			1700	1082	286	320	12		

There are 20 discrepancies between the modelled and reference sequences:

Chain	Residue	Modelled	Actual	Comment	Reference
G	72	GLY	-	linker	UNP P59768
G	73	SER	-	linker	UNP P59768
G	74	ALA	-	linker	UNP P59768
G	75	GLY	-	linker	UNP P59768
G	76	SER	-	linker	UNP P59768
G	77	ALA	-	linker	UNP P59768
G	78	GLY	-	linker	UNP P59768
G	79	SER	-	linker	UNP P59768
G	80	ALA	-	linker	UNP P59768
G	81	MET	-	linker	UNP P59768
A	-7	GLY	-	linker	UNP P59768
A	-6	SER	-	linker	UNP P59768
A	-5	ALA	-	linker	UNP P59768
A	-4	GLY	-	linker	UNP P59768
A	-3	SER	-	linker	UNP P59768
A	-2	ALA	-	linker	UNP P59768
A	-1	GLY	-	linker	UNP P59768
A	0	SER	-	linker	UNP P59768
A	1	ALA	-	linker	UNP P59768
A	2	MET	-	linker	UNP P59768

- Molecule 3 is a protein called scfv16.

Mol	Chain	Residues	Atoms					AltConf	Trace
			Total	C	N	O	S		
3	S	232	1783	1131	295	347	10	0	0

- Molecule 4 is a protein called Hemagglutinin,Adenosine receptor A3,GFP chimera.

Mol	Chain	Residues	Atoms					AltConf	Trace
			Total	C	N	O	S		
4	R	271	2198	1486	341	351	20	0	0

There are 66 discrepancies between the modelled and reference sequences:

Chain	Residue	Modelled	Actual	Comment	Reference
R	-8	ASP	-	linker	UNP P03435
R	-7	TYR	-	linker	UNP P03435
R	-6	LYS	-	linker	UNP P03435
R	-5	ASP	-	linker	UNP P03435
R	-4	ASP	-	linker	UNP P03435
R	-3	ASP	-	linker	UNP P03435
R	-2	ASP	-	linker	UNP P03435
R	-1	ALA	-	linker	UNP P03435
R	0	MET	-	linker	UNP P03435
R	1	GLY	-	linker	UNP P03435
R	318	GLY	-	linker	UNP W5QED6
R	319	SER	-	linker	UNP W5QED6
R	320	GLY	-	linker	UNP W5QED6
R	321	GLY	-	linker	UNP W5QED6
R	322	GLY	-	linker	UNP W5QED6
R	323	GLY	-	linker	UNP W5QED6
R	324	SER	-	linker	UNP W5QED6
R	325	GLY	-	linker	UNP W5QED6
R	326	GLY	-	linker	UNP W5QED6
R	327	SER	-	linker	UNP W5QED6
R	328	SER	-	linker	UNP W5QED6
R	329	SER	-	linker	UNP W5QED6
R	330	GLY	-	linker	UNP W5QED6
R	331	GLY	-	linker	UNP W5QED6
R	490	GLY	-	linker	UNP W5QED6
R	491	GLY	-	linker	UNP W5QED6
R	492	SER	-	linker	UNP W5QED6
R	493	GLY	-	linker	UNP W5QED6
R	494	GLY	-	linker	UNP W5QED6

Continued on next page...

Continued from previous page...

Chain	Residue	Modelled	Actual	Comment	Reference
R	495	GLY	-	linker	UNP W5QED6
R	496	GLY	-	linker	UNP W5QED6
R	497	SER	-	linker	UNP W5QED6
R	498	GLY	-	linker	UNP W5QED6
R	499	GLY	-	linker	UNP W5QED6
R	500	SER	-	linker	UNP W5QED6
R	501	SER	-	linker	UNP W5QED6
R	502	SER	-	linker	UNP W5QED6
R	503	GLY	-	linker	UNP W5QED6
R	504	GLY	-	linker	UNP W5QED6
R	505	LEU	-	linker	UNP W5QED6
R	506	GLU	-	linker	UNP W5QED6
R	507	VAL	-	linker	UNP W5QED6
R	508	LEU	-	linker	UNP W5QED6
R	509	PHE	-	linker	UNP W5QED6
R	510	GLN	-	linker	UNP W5QED6
R	511	GLY	-	linker	UNP W5QED6
R	512	PRO	-	linker	UNP W5QED6
R	513	GLY	-	linker	UNP W5QED6
R	514	SER	-	linker	UNP W5QED6
R	515	ALA	-	linker	UNP W5QED6
R	516	ALA	-	linker	UNP W5QED6
R	517	ALA	-	linker	UNP W5QED6
R	518	ALA	-	linker	UNP W5QED6
R	757	SER	-	expression tag	UNP A0A5P9VSM6
R	758	GLY	-	expression tag	UNP A0A5P9VSM6
R	759	LEU	-	expression tag	UNP A0A5P9VSM6
R	760	ARG	-	expression tag	UNP A0A5P9VSM6
R	761	SER	-	expression tag	UNP A0A5P9VSM6
R	762	HIS	-	expression tag	UNP A0A5P9VSM6
R	763	HIS	-	expression tag	UNP A0A5P9VSM6
R	764	HIS	-	expression tag	UNP A0A5P9VSM6
R	765	HIS	-	expression tag	UNP A0A5P9VSM6
R	766	HIS	-	expression tag	UNP A0A5P9VSM6
R	767	HIS	-	expression tag	UNP A0A5P9VSM6
R	768	HIS	-	expression tag	UNP A0A5P9VSM6
R	769	HIS	-	expression tag	UNP A0A5P9VSM6

- Molecule 5 is N-(3-methylbut-2-en-1-yl)adenosine (three-letter code: ZIR) (formula: $C_{15}H_{21}N_5O_4$) (labeled as "Ligand of Interest" by depositor).

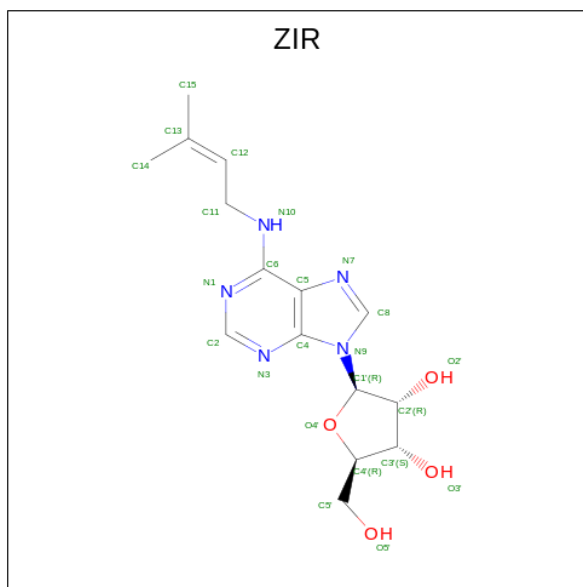

Mol	Chain	Residues	Atoms				AltConf
			Total	C	N	O	
5	R	1	24	15	5	4	0

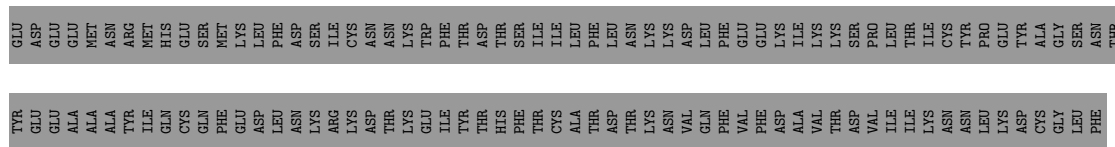

Molecule 2: Guanine nucleotide-binding protein G(I)/G(S)/G(O) subunit gamma-2, Guanine nucleotide-binding protein G(i) subunit alpha-1 chimera

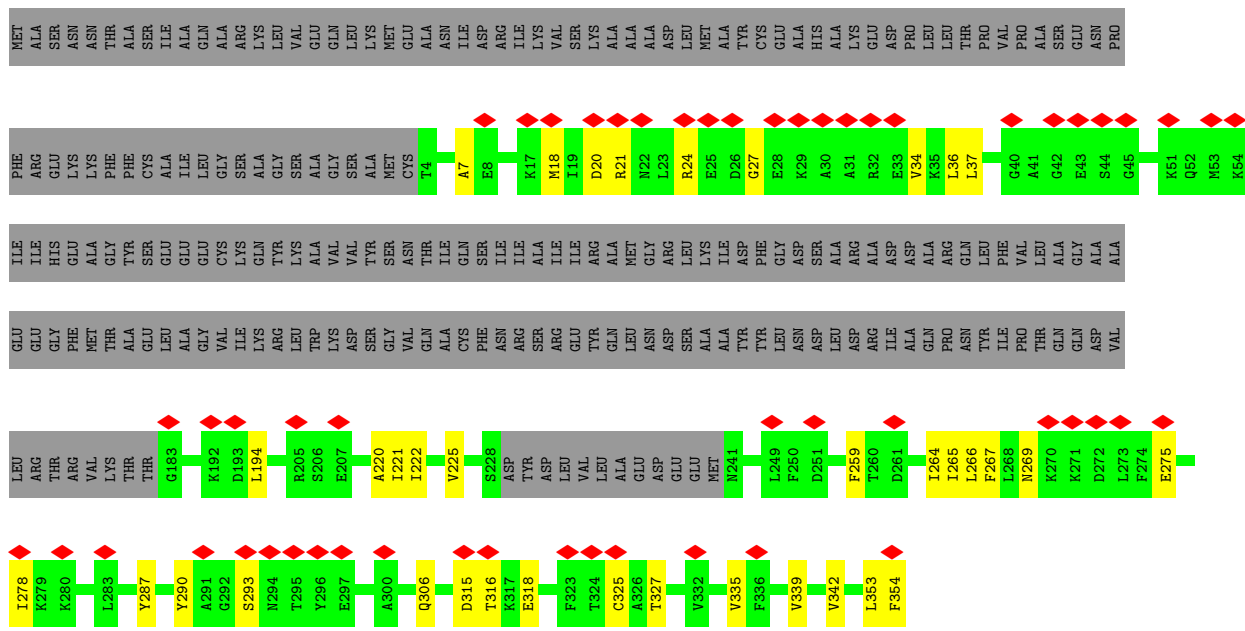
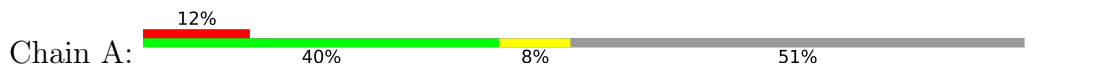

Molecule 3: scfv16

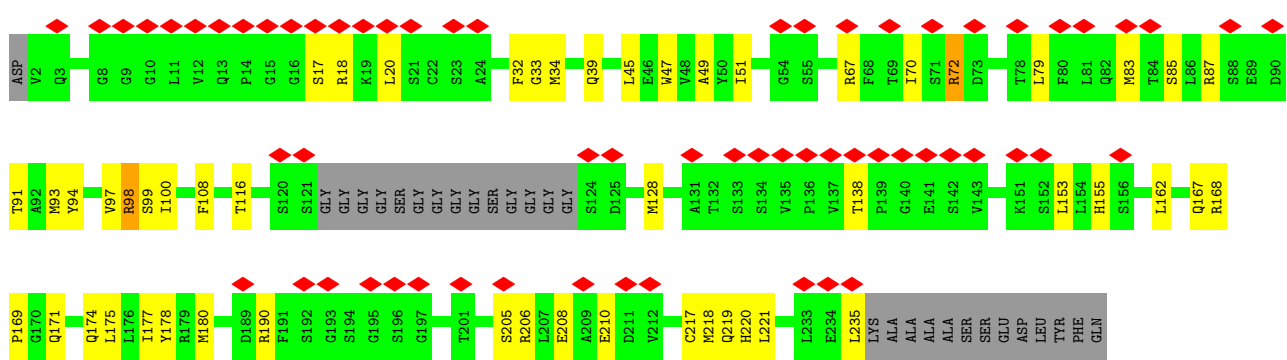

Molecule 4: Hemagglutinin, Adenosine receptor A3, GFP chimera

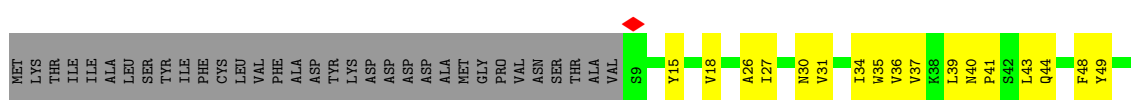

4 Experimental information

Property	Value	Source
EM reconstruction method	SINGLE PARTICLE	Depositor
Imposed symmetry	POINT, Not provided	
Number of particles used	141536	Depositor
Resolution determination method	FSC 0.143 CUT-OFF	Depositor
CTF correction method	PHASE FLIPPING AND AMPLITUDE CORRECTION	Depositor
Microscope	FEI TITAN KRIOS	Depositor
Voltage (kV)	300	Depositor
Electron dose ($e^-/\text{\AA}^2$)	50	Depositor
Minimum defocus (nm)	800	Depositor
Maximum defocus (nm)	1600	Depositor
Magnification	Not provided	
Image detector	GATAN K3 (6k x 4k)	Depositor
Maximum map value	37.662	Depositor
Minimum map value	-21.105	Depositor
Average map value	0.002	Depositor
Map value standard deviation	1.084	Depositor
Recommended contour level	5.07	Depositor
Map size (Å)	233.1, 233.1, 233.1	wwPDB
Map dimensions	210, 210, 210	wwPDB
Map angles (°)	90.0, 90.0, 90.0	wwPDB
Pixel spacing (Å)	1.11, 1.11, 1.11	Depositor

5 Model quality [i](#)

5.1 Standard geometry [i](#)

Bond lengths and bond angles in the following residue types are not validated in this section: ZIR

The Z score for a bond length (or angle) is the number of standard deviations the observed value is removed from the expected value. A bond length (or angle) with $|Z| > 5$ is considered an outlier worth inspection. RMSZ is the root-mean-square of all Z scores of the bond lengths (or angles).

Mol	Chain	Bond lengths		Bond angles	
		RMSZ	# Z >5	RMSZ	# Z >5
1	B	0.31	0/2630	0.56	0/3566
2	A	0.27	0/1728	0.47	0/2313
2	G	0.30	0/413	0.47	0/558
3	S	0.31	0/1827	0.54	0/2477
4	R	0.28	0/2254	0.47	0/3070
All	All	0.30	0/8852	0.51	0/11984

Chiral center outliers are detected by calculating the chiral volume of a chiral center and verifying if the center is modelled as a planar moiety or with the opposite hand. A planarity outlier is detected by checking planarity of atoms in a peptide group, atoms in a mainchain group or atoms of a sidechain that are expected to be planar.

Mol	Chain	#Chirality outliers	#Planarity outliers
1	B	0	2
3	S	0	3
4	R	0	1
All	All	0	6

There are no bond length outliers.

There are no bond angle outliers.

There are no chirality outliers.

All (6) planarity outliers are listed below:

Mol	Chain	Res	Type	Group
1	B	219	ARG	Sidechain
1	B	52	ARG	Sidechain
4	R	172	ARG	Sidechain
3	S	18	ARG	Sidechain
3	S	72	ARG	Sidechain

Continued on next page...

Continued from previous page...

Mol	Chain	Res	Type	Group
3	S	98	ARG	Sidechain

5.2 Too-close contacts [i](#)

In the following table, the Non-H and H(model) columns list the number of non-hydrogen atoms and hydrogen atoms in the chain respectively. The H(added) column lists the number of hydrogen atoms added and optimized by MolProbity. The Clashes column lists the number of clashes within the asymmetric unit, whereas Symm-Clashes lists symmetry-related clashes.

Mol	Chain	Non-H	H(model)	H(added)	Clashes	Symm-Clashes
1	B	2583	0	2486	63	0
2	A	1700	0	1700	25	0
2	G	407	0	418	8	0
3	S	1783	0	1717	37	0
4	R	2198	0	2328	56	0
5	R	24	0	21	5	0
All	All	8695	0	8670	181	0

The all-atom clashscore is defined as the number of clashes found per 1000 atoms (including hydrogen atoms). The all-atom clashscore for this structure is 10.

All (181) close contacts within the same asymmetric unit are listed below, sorted by their clash magnitude.

Atom-1	Atom-2	Interatomic distance (Å)	Clash overlap (Å)
1:B:52:ARG:HG2	1:B:335:PHE:CD1	1.87	1.08
1:B:52:ARG:HG2	1:B:335:PHE:CE1	2.05	0.92
3:S:169:PRO:O	3:S:171:GLN:NE2	2.25	0.70
4:R:151:MET:O	4:R:155:SER:N	2.25	0.70
2:A:18:MET:SD	2:A:21:ARG:NH2	2.65	0.69
4:R:172:ARG:NH1	4:R:174:ASP:OD1	2.25	0.69
1:B:160:SER:OG	1:B:187:VAL:O	2.11	0.69
4:R:119:ARG:NH2	4:R:122:THR:O	2.26	0.68
1:B:184:THR:OG1	1:B:205:ASP:OD2	2.10	0.67
4:R:37:VAL:O	4:R:44:GLN:NE2	2.27	0.67
1:B:267:ASP:OD1	1:B:268:ASN:N	2.30	0.65
3:S:93:MET:SD	3:S:116:THR:OG1	2.52	0.64
2:A:290:TYR:OH	2:A:293:SER:O	2.15	0.63
1:B:168:LEU:HD22	1:B:213:VAL:HG22	1.82	0.62
2:A:221:ILE:HD11	2:A:264:ILE:HG12	1.80	0.62
1:B:52:ARG:HG2	1:B:335:PHE:HD1	1.56	0.62

Continued on next page...

Continued from previous page...

Atom-1	Atom-2	Interatomic distance (Å)	Clash overlap (Å)
4:R:78:ILE:O	4:R:78:ILE:HG22	2.00	0.61
1:B:52:ARG:CG	1:B:335:PHE:CE1	2.81	0.61
1:B:254:ASP:HB2	1:B:261:LEU:HD21	1.82	0.61
4:R:54:LEU:HD21	4:R:277:ASN:ND2	2.15	0.61
3:S:67:ARG:NH2	3:S:85:SER:O	2.35	0.60
1:B:103:CYS:HB3	1:B:114:CYS:HA	1.84	0.60
4:R:79:HIS:ND1	4:R:161:THR:O	2.35	0.60
1:B:30:LEU:HD23	1:B:262:MET:HE1	1.84	0.59
2:A:20:ASP:OD2	2:A:24:ARG:NH1	2.36	0.58
2:A:36:LEU:HD23	2:A:220:ALA:O	2.03	0.58
4:R:18:VAL:HG12	4:R:268:LEU:HD22	1.85	0.58
3:S:33:GLY:O	3:S:99:SER:N	2.36	0.58
3:S:138:THR:HA	3:S:235:LEU:HD13	1.84	0.58
2:A:265:ILE:HG22	2:A:267:PHE:CE1	2.39	0.58
3:S:190:ARG:NH2	3:S:205:SER:O	2.36	0.57
1:B:249:THR:HG22	1:B:265:SER:HB2	1.86	0.57
4:R:107:ASP:OD2	4:R:111:ARG:NH2	2.37	0.57
4:R:35:TRP:O	4:R:39:LEU:HD13	2.04	0.57
4:R:66:MET:HB3	4:R:67:PRO:HD3	1.86	0.56
3:S:220:HIS:O	3:S:221:LEU:HB3	2.05	0.56
1:B:208:ALA:O	1:B:222:PHE:N	2.40	0.55
4:R:173:MET:SD	5:R:801:ZIR:H15	2.45	0.55
1:B:294:CYS:SG	1:B:315:VAL:HG21	2.46	0.55
3:S:97:VAL:HG11	3:S:108:PHE:HD1	1.71	0.55
1:B:49:ARG:HH21	2:G:61:PHE:HA	1.72	0.55
3:S:220:HIS:CE1	2:A:7:ALA:HB3	2.40	0.55
4:R:49:TYR:HD2	4:R:127:ILE:HG21	1.71	0.55
3:S:162:LEU:HD12	3:S:218:MET:O	2.07	0.54
1:B:211:TRP:HE1	1:B:218:CYS:HG	1.55	0.54
2:A:221:ILE:HG21	2:A:259:PHE:CE2	2.43	0.53
3:S:47:TRP:NE1	3:S:49:ALA:O	2.41	0.53
4:R:26:ALA:O	4:R:30:ASN:ND2	2.41	0.53
2:A:315:ASP:OD1	2:A:316:THR:N	2.42	0.53
3:S:168:ARG:NH2	3:S:210:GLU:O	2.42	0.53
2:G:52:THR:O	2:G:52:THR:HG23	2.08	0.52
3:S:51:ILE:HD13	3:S:72:ARG:HB2	1.92	0.52
1:B:225:HIS:CE1	1:B:245:SER:HG	2.26	0.52
1:B:14:LEU:O	1:B:18:ILE:HD12	2.10	0.51
4:R:109:TYR:HB2	4:R:195:ILE:HG23	1.92	0.51
1:B:158:VAL:HG21	1:B:192:LEU:HD21	1.91	0.51
1:B:55:LEU:HD12	2:A:27:GLY:HA3	1.93	0.51

Continued on next page...

Continued from previous page...

Atom-1	Atom-2	Interatomic distance (Å)	Clash overlap (Å)
1:B:155:ASN:OD1	1:B:172:GLU:N	2.44	0.51
4:R:286:LYS:O	4:R:289:LYS:N	2.44	0.50
3:S:174:GLN:NE2	3:S:175:LEU:O	2.45	0.50
1:B:168:LEU:HD13	1:B:213:VAL:CG2	2.41	0.50
4:R:237:LEU:CD1	4:R:280:VAL:HG21	2.42	0.50
4:R:43:LEU:HD22	4:R:48:PHE:CE2	2.47	0.50
4:R:109:TYR:OH	4:R:113:LYS:NZ	2.45	0.50
1:B:48:ARG:HE	1:B:340:ASN:HB3	1.77	0.49
1:B:160:SER:HB2	1:B:190:LEU:HD23	1.94	0.49
3:S:190:ARG:NH2	3:S:206:ARG:O	2.46	0.49
3:S:177:ILE:HG21	3:S:180:MET:O	2.13	0.48
4:R:80:PHE:CZ	4:R:84:LEU:HD22	2.48	0.48
1:B:64:GLY:HA2	1:B:105:TYR:CD2	2.47	0.48
3:S:39:GLN:OE1	3:S:167:GLN:NE2	2.46	0.48
3:S:91:THR:O	3:S:91:THR:HG23	2.13	0.48
4:R:150:ASN:O	4:R:172:ARG:HD2	2.13	0.48
1:B:160:SER:CB	1:B:190:LEU:HD23	2.44	0.48
1:B:102:THR:O	1:B:103:CYS:HB3	2.14	0.48
4:R:80:PHE:O	4:R:83:CYS:N	2.47	0.48
4:R:249:ASN:ND2	5:R:801:ZIR:H15A	2.29	0.48
1:B:67:SER:O	1:B:67:SER:OG	2.27	0.48
4:R:18:VAL:HG11	4:R:268:LEU:HD13	1.96	0.48
1:B:210:LEU:HB3	1:B:220:GLN:HB3	1.95	0.47
4:R:286:LYS:O	4:R:290:GLU:OE1	2.33	0.47
4:R:290:GLU:O	4:R:294:LEU:N	2.34	0.47
1:B:80:ILE:HD13	1:B:92:ALA:HA	1.97	0.47
4:R:114:LEU:O	4:R:115:THR:OG1	2.24	0.47
2:A:222:ILE:HG23	2:A:267:PHE:CE2	2.49	0.47
3:S:220:HIS:CE1	2:A:7:ALA:CB	2.98	0.47
1:B:152:LEU:HD21	1:B:192:LEU:HD22	1.97	0.47
3:S:34:MET:HB3	3:S:79:LEU:HD22	1.96	0.46
3:S:175:LEU:HD21	3:S:178:TYR:HB3	1.98	0.46
2:A:287:TYR:OH	2:A:306:GLN:NE2	2.49	0.46
4:R:56:LEU:O	4:R:59:ILE:HG22	2.15	0.46
1:B:247:ASP:O	1:B:247:ASP:OD1	2.34	0.46
1:B:123:ILE:HD12	1:B:171:ILE:HG23	1.97	0.46
1:B:227:SER:OG	1:B:228:ASP:N	2.48	0.46
1:B:195:ASP:O	1:B:196:THR:OG1	2.29	0.46
2:A:267:PHE:HB3	2:A:269:ASN:OD1	2.15	0.46
1:B:51:LEU:HD13	1:B:338:ILE:CD1	2.46	0.46
1:B:161:SER:OG	1:B:162:GLY:N	2.49	0.46

Continued on next page...

Continued from previous page...

Atom-1	Atom-2	Interatomic distance (Å)	Clash overlap (Å)
3:S:32:PHE:CE1	3:S:100:ILE:HB	2.51	0.45
3:S:83:MET:SD	3:S:83:MET:N	2.89	0.45
1:B:13:GLN:O	1:B:17:GLN:OE1	2.34	0.45
1:B:96:ARG:NH2	1:B:124:TYR:OH	2.49	0.45
2:A:275:GLU:HA	2:A:278:ILE:HD12	1.98	0.45
4:R:15:TYR:OH	4:R:267:ILE:HG21	2.17	0.45
4:R:27:ILE:O	4:R:31:VAL:HG23	2.16	0.45
2:A:354:PHE:OXT	4:R:286:LYS:NZ	2.49	0.45
4:R:80:PHE:CG	4:R:152:LYS:NZ	2.83	0.45
3:S:128:MET:HE3	3:S:153:LEU:HD11	1.98	0.45
3:S:162:LEU:HD11	3:S:217:CYS:HB2	1.99	0.45
2:A:225:VAL:HG12	2:A:266:LEU:HD11	1.99	0.45
2:G:31:SER:HA	2:G:34:ALA:HB2	1.98	0.45
3:S:32:PHE:CZ	3:S:98:ARG:NH1	2.85	0.44
3:S:51:ILE:HB	3:S:70:ILE:HG21	1.99	0.44
4:R:200:PHE:HA	4:R:203:ILE:HG22	1.99	0.44
3:S:97:VAL:HG11	3:S:108:PHE:CD1	2.51	0.44
3:S:128:MET:HE2	3:S:219:GLN:HG2	1.99	0.44
2:A:37:LEU:HB3	2:A:221:ILE:HG22	1.99	0.44
4:R:243:LEU:N	4:R:244:PRO:CD	2.81	0.44
1:B:14:LEU:O	1:B:18:ILE:CD1	2.66	0.44
1:B:152:LEU:HD23	1:B:196:THR:HB	2.00	0.44
2:G:46:LYS:HA	2:G:46:LYS:HE3	1.98	0.44
1:B:84:SER:O	2:G:61:PHE:HE1	2.00	0.44
2:A:339:VAL:HA	2:A:342:VAL:HG12	1.99	0.44
4:R:106:VAL:O	4:R:110:LEU:HD23	2.18	0.44
1:B:101:MET:N	1:B:101:MET:SD	2.91	0.44
3:S:190:ARG:CZ	3:S:208:GLU:OE1	2.66	0.44
4:R:40:ASN:HB3	4:R:43:LEU:HD12	1.99	0.44
3:S:39:GLN:HB2	3:S:45:LEU:HD23	1.99	0.43
2:A:353:LEU:HD13	4:R:231:LEU:HD21	2.00	0.43
1:B:250:CYS:O	1:B:264:TYR:N	2.49	0.43
4:R:280:VAL:O	4:R:280:VAL:HG12	2.17	0.43
2:A:318:GLU:N	2:A:318:GLU:OE1	2.51	0.43
3:S:34:MET:SD	3:S:98:ARG:HA	2.59	0.43
1:B:30:LEU:CD1	2:G:34:ALA:HB1	2.49	0.43
1:B:291:ASP:N	1:B:291:ASP:OD1	2.51	0.43
4:R:151:MET:O	4:R:155:SER:OG	2.35	0.43
1:B:190:LEU:C	1:B:190:LEU:HD12	2.39	0.43
1:B:135:VAL:O	1:B:135:VAL:HG13	2.18	0.43
2:A:34:VAL:HG21	2:A:194:LEU:HD21	1.99	0.43

Continued on next page...

Continued from previous page...

Atom-1	Atom-2	Interatomic distance (Å)	Clash overlap (Å)
2:A:335:VAL:O	2:A:339:VAL:HG22	2.19	0.43
1:B:220:GLN:HG2	1:B:222:PHE:CZ	2.54	0.43
3:S:33:GLY:N	3:S:99:SER:O	2.52	0.43
4:R:200:PHE:CE1	4:R:228:ALA:HB2	2.54	0.43
2:A:325:CYS:SG	2:A:327:THR:HG22	2.59	0.42
4:R:163:LEU:CD1	4:R:165:CYS:HA	2.49	0.42
1:B:61:MET:CE	1:B:328:ALA:HB3	2.49	0.42
1:B:233:CYS:HG	1:B:278:PHE:HD2	1.66	0.42
2:G:19:LEU:HA	2:G:22:GLU:HB3	2.01	0.42
4:R:91:LEU:HD11	4:R:171:MET:CE	2.49	0.42
1:B:211:TRP:NE1	1:B:218:CYS:SG	2.90	0.42
4:R:41:PRO:HA	4:R:44:GLN:OE1	2.19	0.42
4:R:271:HIS:CE1	5:R:801:ZIR:HO2'	2.38	0.42
4:R:173:MET:SD	5:R:801:ZIR:C15	3.08	0.41
1:B:59:TYR:O	1:B:317:CYS:HB3	2.20	0.41
1:B:232:ILE:HD11	1:B:241:PHE:CE2	2.55	0.41
1:B:81:ILE:HD13	1:B:91:HIS:HB2	2.02	0.41
1:B:225:HIS:CG	1:B:245:SER:HG	2.38	0.41
4:R:36:VAL:HG11	4:R:288:PHE:CD1	2.55	0.41
4:R:151:MET:SD	4:R:172:ARG:HG2	2.60	0.41
1:B:93:ILE:HG12	1:B:133:VAL:HG21	2.03	0.41
1:B:112:VAL:HG13	1:B:112:VAL:O	2.20	0.41
3:S:108:PHE:O	3:S:175:LEU:HD12	2.20	0.41
4:R:188:PRO:O	4:R:192:MET:HG3	2.20	0.41
4:R:173:MET:C	4:R:175:TYR:N	2.74	0.41
1:B:164:THR:HA	1:B:187:VAL:HG23	2.03	0.41
1:B:285:LEU:N	1:B:297:TRP:O	2.51	0.41
2:G:52:THR:O	2:G:52:THR:CG2	2.69	0.41
3:S:20:LEU:HD11	3:S:94:TYR:CD2	2.56	0.41
4:R:290:GLU:O	4:R:294:LEU:HG	2.21	0.41
1:B:63:TRP:CE2	1:B:321:THR:HG22	2.56	0.41
3:S:220:HIS:O	3:S:221:LEU:CB	2.68	0.41
4:R:27:ILE:HA	4:R:59:ILE:HD12	2.03	0.40
1:B:152:LEU:HD11	1:B:213:VAL:HG21	2.03	0.40
3:S:155:HIS:HD2	3:S:221:LEU:HD11	1.86	0.40
4:R:34:ILE:HD11	4:R:55:ALA:HB3	2.02	0.40
4:R:84:LEU:HD23	4:R:146:MET:SD	2.60	0.40
5:R:801:ZIR:N7	5:R:801:ZIR:C11	2.84	0.40
1:B:145:TYR:O	1:B:162:GLY:N	2.54	0.40
4:R:76:VAL:HG12	4:R:77:THR:N	2.37	0.40
4:R:245:LEU:HD13	4:R:267:ILE:N	2.36	0.40

Continued on next page...

Continued from previous page...

Atom-1	Atom-2	Interatomic distance (Å)	Clash overlap (Å)
2:A:353:LEU:CD1	4:R:231:LEU:HD21	2.51	0.40

There are no symmetry-related clashes.

5.3 Torsion angles [i](#)

5.3.1 Protein backbone [i](#)

In the following table, the Percentiles column shows the percent Ramachandran outliers of the chain as a percentile score with respect to all PDB entries followed by that with respect to all EM entries.

The Analysed column shows the number of residues for which the backbone conformation was analysed, and the total number of residues.

Mol	Chain	Analysed	Favoured	Allowed	Outliers	Percentiles	
1	B	334/375 (89%)	310 (93%)	24 (7%)	0	100	100
2	A	205/433 (47%)	195 (95%)	10 (5%)	0	100	100
2	G	51/433 (12%)	50 (98%)	1 (2%)	0	100	100
3	S	228/260 (88%)	209 (92%)	19 (8%)	0	100	100
4	R	267/794 (34%)	251 (94%)	16 (6%)	0	100	100
All	All	1085/2295 (47%)	1015 (94%)	70 (6%)	0	100	100

There are no Ramachandran outliers to report.

5.3.2 Protein sidechains [i](#)

In the following table, the Percentiles column shows the percent sidechain outliers of the chain as a percentile score with respect to all PDB entries followed by that with respect to all EM entries.

The Analysed column shows the number of residues for which the sidechain conformation was analysed, and the total number of residues.

Mol	Chain	Analysed	Rotameric	Outliers	Percentiles	
1	B	279/305 (92%)	278 (100%)	1 (0%)	89	93
2	A	187/366 (51%)	187 (100%)	0	100	100
2	G	43/366 (12%)	43 (100%)	0	100	100

Continued on next page...

Continued from previous page...

Mol	Chain	Analysed	Rotameric	Outliers	Percentiles	
3	S	197/209 (94%)	195 (99%)	2 (1%)	73	82
4	R	247/685 (36%)	247 (100%)	0	100	100
All	All	953/1931 (49%)	950 (100%)	3 (0%)	90	94

All (3) residues with a non-rotameric sidechain are listed below:

Mol	Chain	Res	Type
1	B	19	ARG
3	S	17	SER
3	S	87	ARG

Sometimes sidechains can be flipped to improve hydrogen bonding and reduce clashes. All (4) such sidechains are listed below:

Mol	Chain	Res	Type
1	B	75	GLN
2	A	213	HIS
2	A	306	GLN
2	A	331	ASN

5.3.3 RNA [i](#)

There are no RNA molecules in this entry.

5.4 Non-standard residues in protein, DNA, RNA chains [i](#)

There are no non-standard protein/DNA/RNA residues in this entry.

5.5 Carbohydrates [i](#)

There are no oligosaccharides in this entry.

5.6 Ligand geometry [i](#)

1 ligand is modelled in this entry.

In the following table, the Counts columns list the number of bonds (or angles) for which Mogul statistics could be retrieved, the number of bonds (or angles) that are observed in the model and the number of bonds (or angles) that are defined in the Chemical Component Dictionary. The

Link column lists molecule types, if any, to which the group is linked. The Z score for a bond length (or angle) is the number of standard deviations the observed value is removed from the expected value. A bond length (or angle) with $|Z| > 2$ is considered an outlier worth inspection. RMSZ is the root-mean-square of all Z scores of the bond lengths (or angles).

Mol	Type	Chain	Res	Link	Bond lengths			Bond angles		
					Counts	RMSZ	# Z > 2	Counts	RMSZ	# Z > 2
5	ZIR	R	801	-	22,26,26	0.68	0	22,37,37	0.61	0

In the following table, the Chirals column lists the number of chiral outliers, the number of chiral centers analysed, the number of these observed in the model and the number defined in the Chemical Component Dictionary. Similar counts are reported in the Torsion and Rings columns. '-' means no outliers of that kind were identified.

Mol	Type	Chain	Res	Link	Chirals	Torsions	Rings
5	ZIR	R	801	-	-	2/8/28/28	0/3/3/3

There are no bond length outliers.

There are no bond angle outliers.

There are no chirality outliers.

All (2) torsion outliers are listed below:

Mol	Chain	Res	Type	Atoms
5	R	801	ZIR	N1-C6-N10-C11
5	R	801	ZIR	C5-C6-N10-C11

There are no ring outliers.

1 monomer is involved in 5 short contacts:

Mol	Chain	Res	Type	Clashes	Symm-Clashes
5	R	801	ZIR	5	0

The following is a two-dimensional graphical depiction of Mogul quality analysis of bond lengths, bond angles, torsion angles, and ring geometry for all instances of the Ligand of Interest. In addition, ligands with molecular weight > 250 and outliers as shown on the validation Tables will also be included. For torsion angles, if less than 5% of the Mogul distribution of torsion angles is within 10 degrees of the torsion angle in question, then that torsion angle is considered an outlier. Any bond that is central to one or more torsion angles identified as an outlier by Mogul will be highlighted in the graph. For rings, the root-mean-square deviation (RMSD) between the ring in question and similar rings identified by Mogul is calculated over all ring torsion angles. If the average RMSD is greater than 60 degrees and the minimal RMSD between the ring in question and any Mogul-identified rings is also greater than 60 degrees, then that ring is considered an outlier. The outliers are highlighted in purple. The color gray indicates Mogul did not find sufficient

equivalents in the CSD to analyse the geometry.

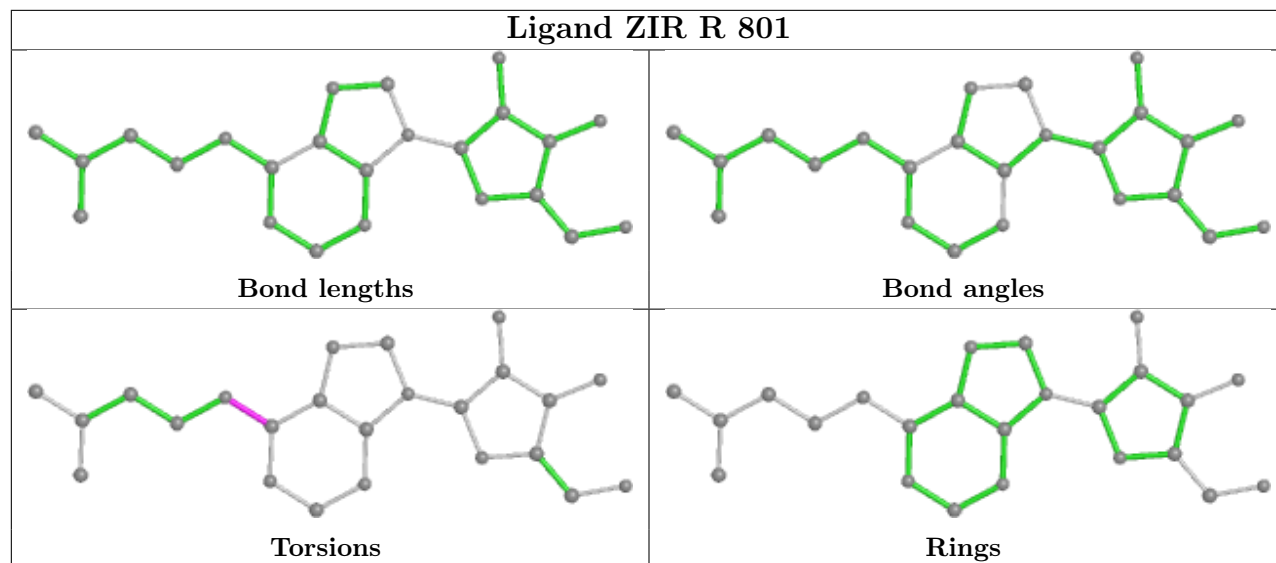

5.7 Other polymers [i](#)

There are no such residues in this entry.

5.8 Polymer linkage issues [i](#)

There are no chain breaks in this entry.

6 Map visualisation [i](#)

This section contains visualisations of the EMDB entry EMD-39281. These allow visual inspection of the internal detail of the map and identification of artifacts.

No raw map or half-maps were deposited for this entry and therefore no images, graphs, etc. pertaining to the raw map can be shown.

6.1 Orthogonal projections [i](#)

6.1.1 Primary map

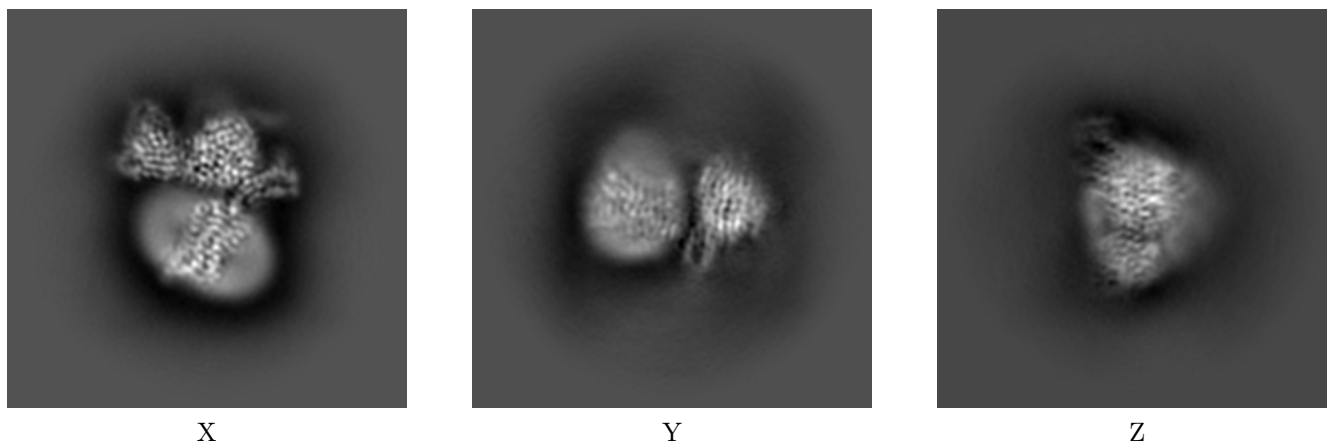

The images above show the map projected in three orthogonal directions.

6.2 Central slices [i](#)

6.2.1 Primary map

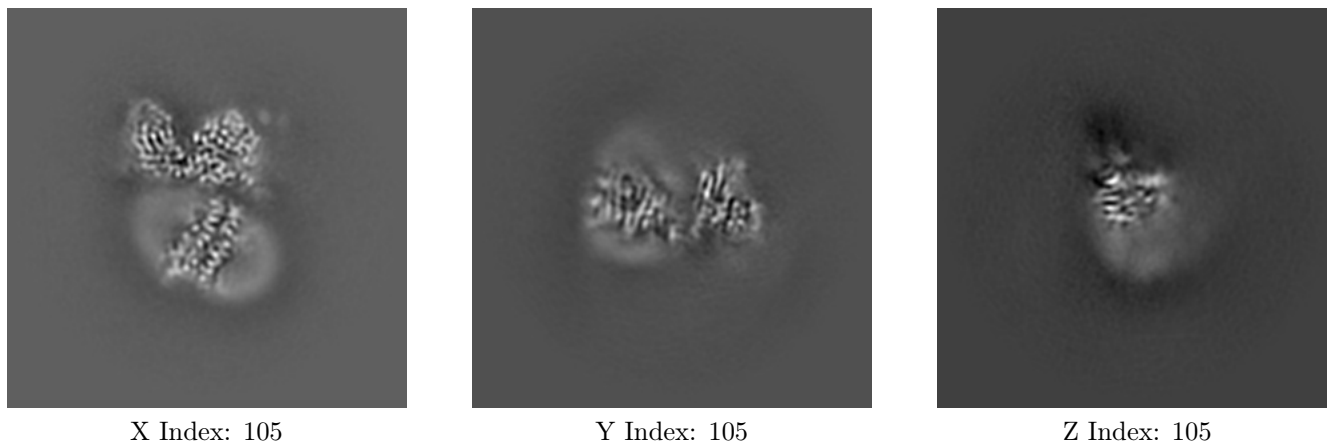

The images above show central slices of the map in three orthogonal directions.

6.3 Largest variance slices [i](#)

6.3.1 Primary map

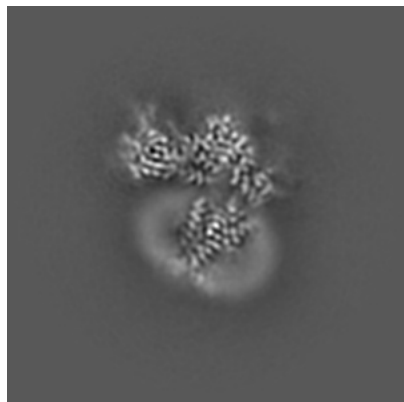

X Index: 97

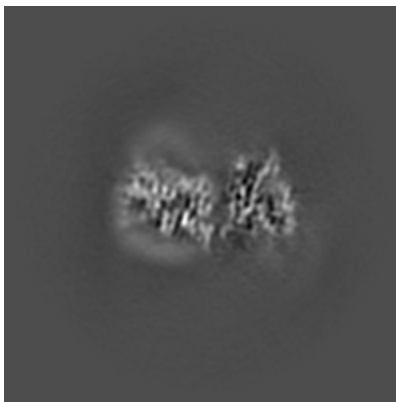

Y Index: 109

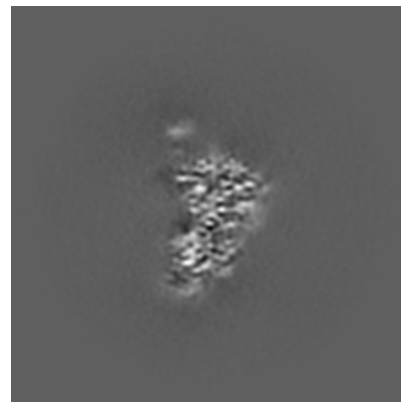

Z Index: 130

The images above show the largest variance slices of the map in three orthogonal directions.

6.4 Orthogonal standard-deviation projections (False-color) [i](#)

6.4.1 Primary map

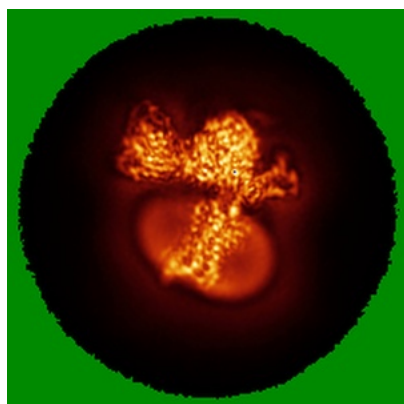

X

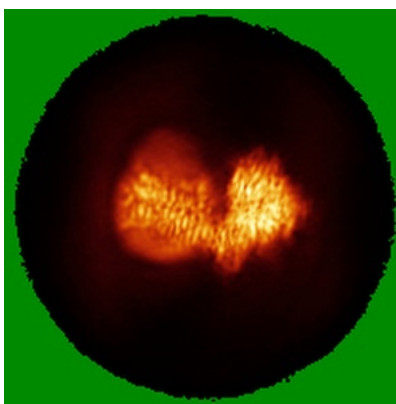

Y

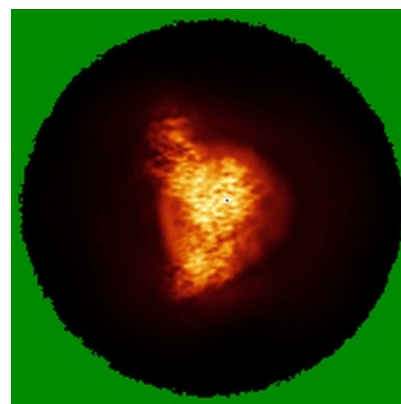

Z

The images above show the map standard deviation projections with false color in three orthogonal directions. Minimum values are shown in green, max in blue, and dark to light orange shades represent small to large values respectively.

6.5 Orthogonal surface views [i](#)

6.5.1 Primary map

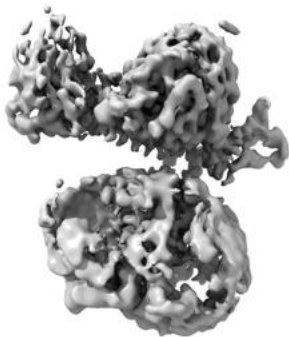

X

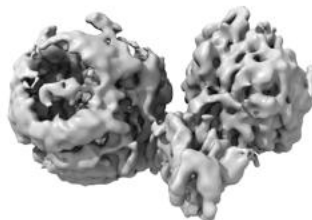

Y

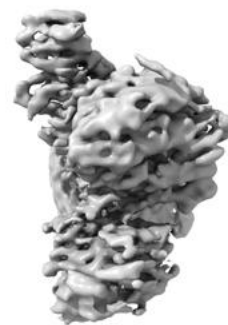

Z

The images above show the 3D surface view of the map at the recommended contour level 5.07. These images, in conjunction with the slice images, may facilitate assessment of whether an appropriate contour level has been provided.

6.6 Mask visualisation [i](#)

This section was not generated. No masks/segmentation were deposited.

7 Map analysis [i](#)

This section contains the results of statistical analysis of the map.

7.1 Map-value distribution [i](#)

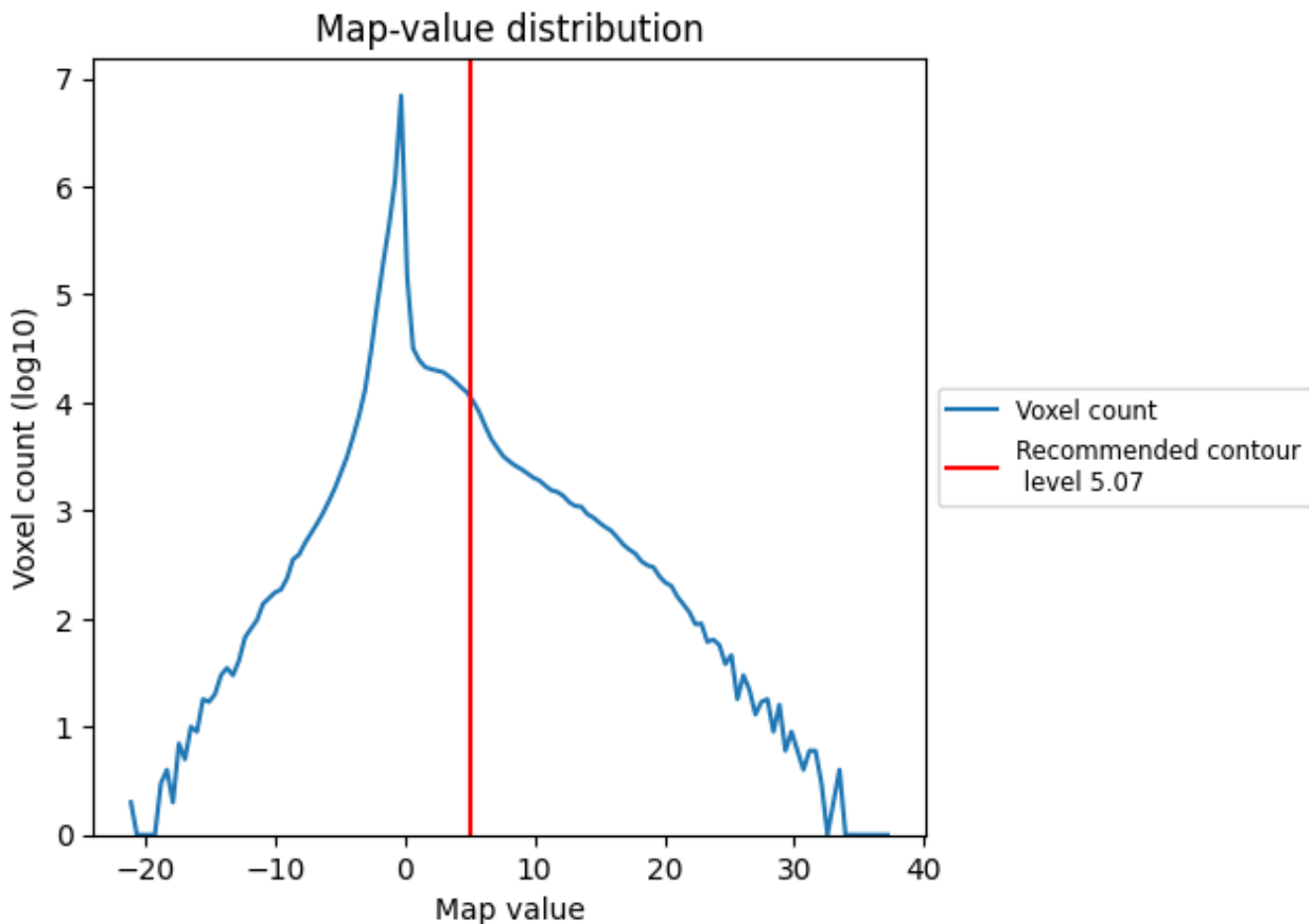

The map-value distribution is plotted in 128 intervals along the x-axis. The y-axis is logarithmic. A spike in this graph at zero usually indicates that the volume has been masked.

7.2 Volume estimate [i](#)

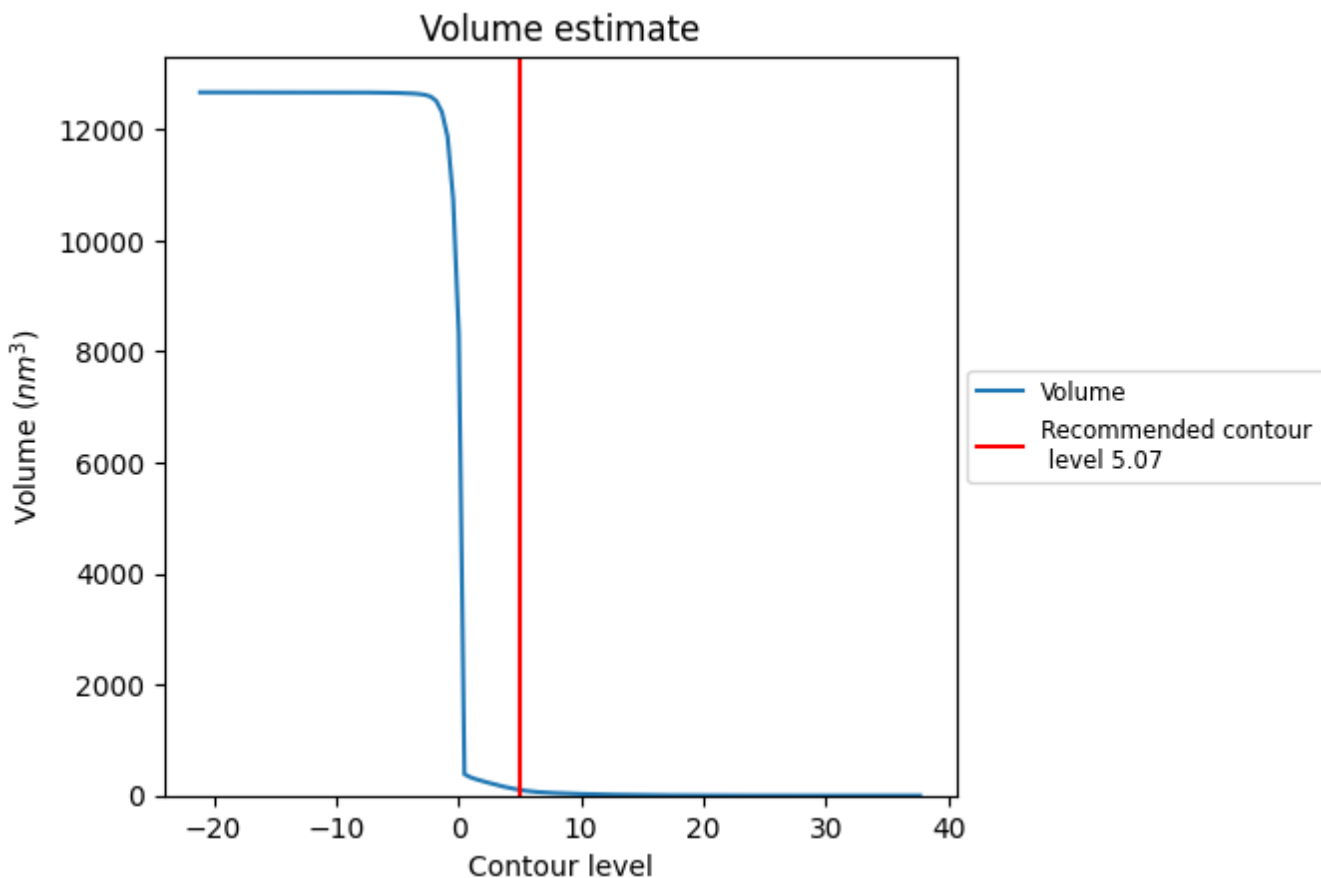

The volume at the recommended contour level is 100 nm³; this corresponds to an approximate mass of 90 kDa.

The volume estimate graph shows how the enclosed volume varies with the contour level. The recommended contour level is shown as a vertical line and the intersection between the line and the curve gives the volume of the enclosed surface at the given level.

7.3 Rotationally averaged power spectrum [i](#)

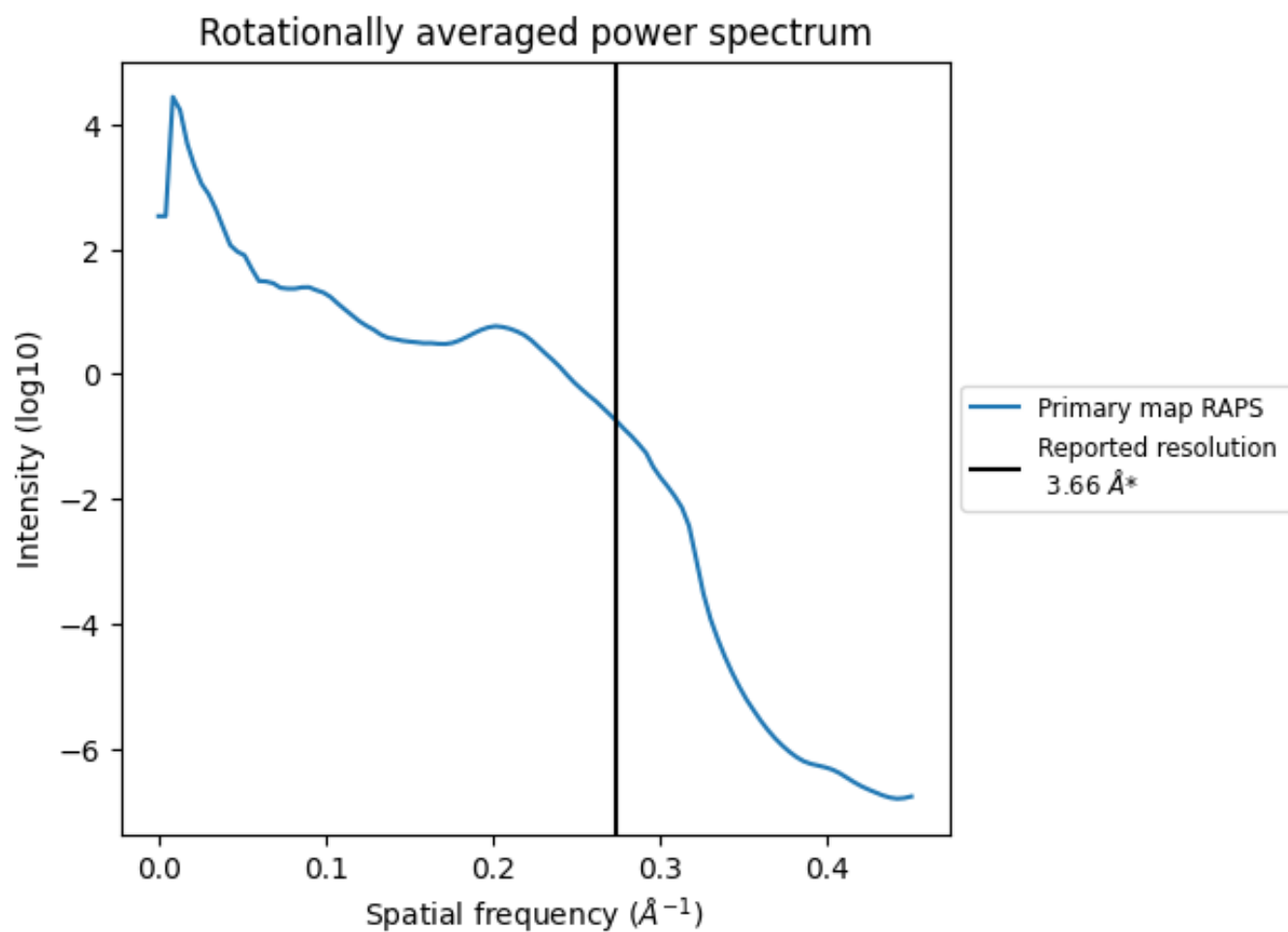

*Reported resolution corresponds to spatial frequency of 0.273\AA^{-1}

8 Fourier-Shell correlation

This section was not generated. No FSC curve or half-maps provided.

9 Map-model fit [i](#)

This section contains information regarding the fit between EMDB map EMD-39281 and PDB model 8YH5. Per-residue inclusion information can be found in section 3 on page 8.

9.1 Map-model overlay [i](#)

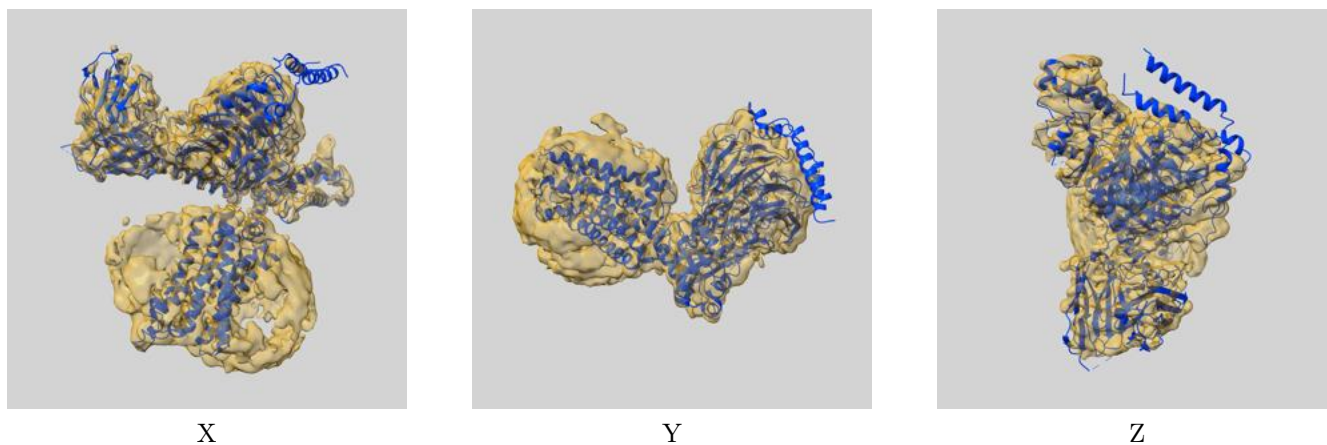

The images above show the 3D surface view of the map at the recommended contour level 5.07 at 50% transparency in yellow overlaid with a ribbon representation of the model coloured in blue. These images allow for the visual assessment of the quality of fit between the atomic model and the map.

9.2 Q-score mapped to coordinate model [i](#)

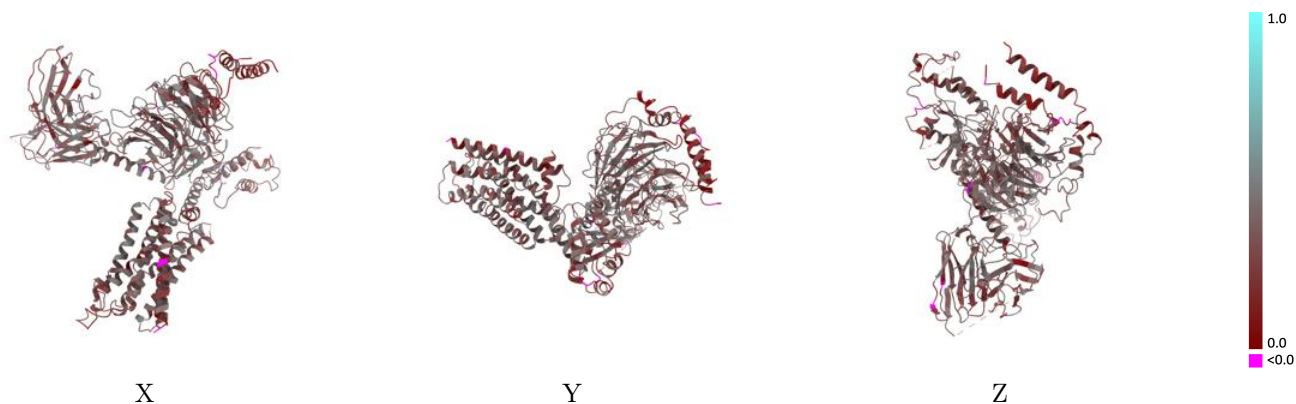

The images above show the model with each residue coloured according to its Q-score. This shows their resolvability in the map with higher Q-score values reflecting better resolvability. Please note: Q-score is calculating the resolvability of atoms, and thus high values are only expected at resolutions at which atoms can be resolved. Low Q-score values may therefore be expected for many entries.

9.3 Atom inclusion mapped to coordinate model [i](#)

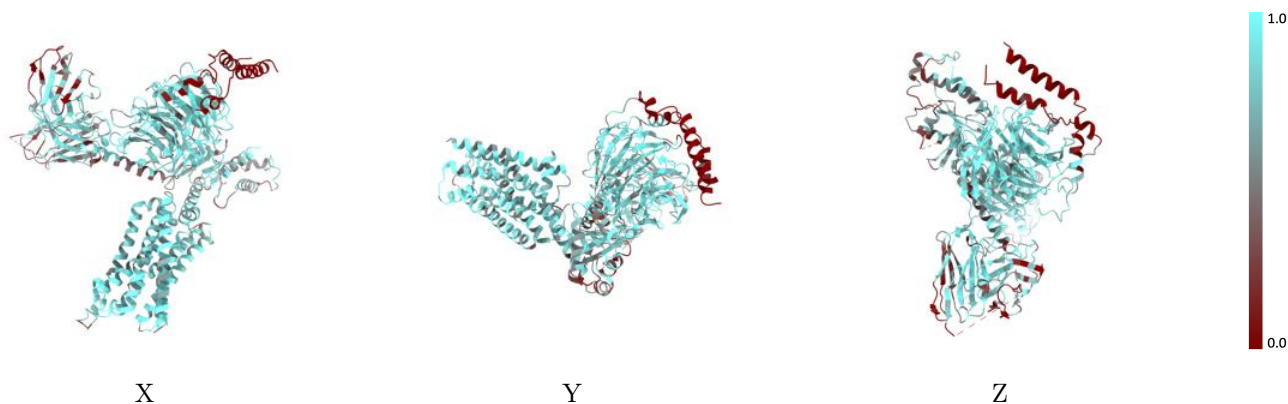

The images above show the model with each residue coloured according to its atom inclusion. This shows to what extent they are inside the map at the recommended contour level (5.07).



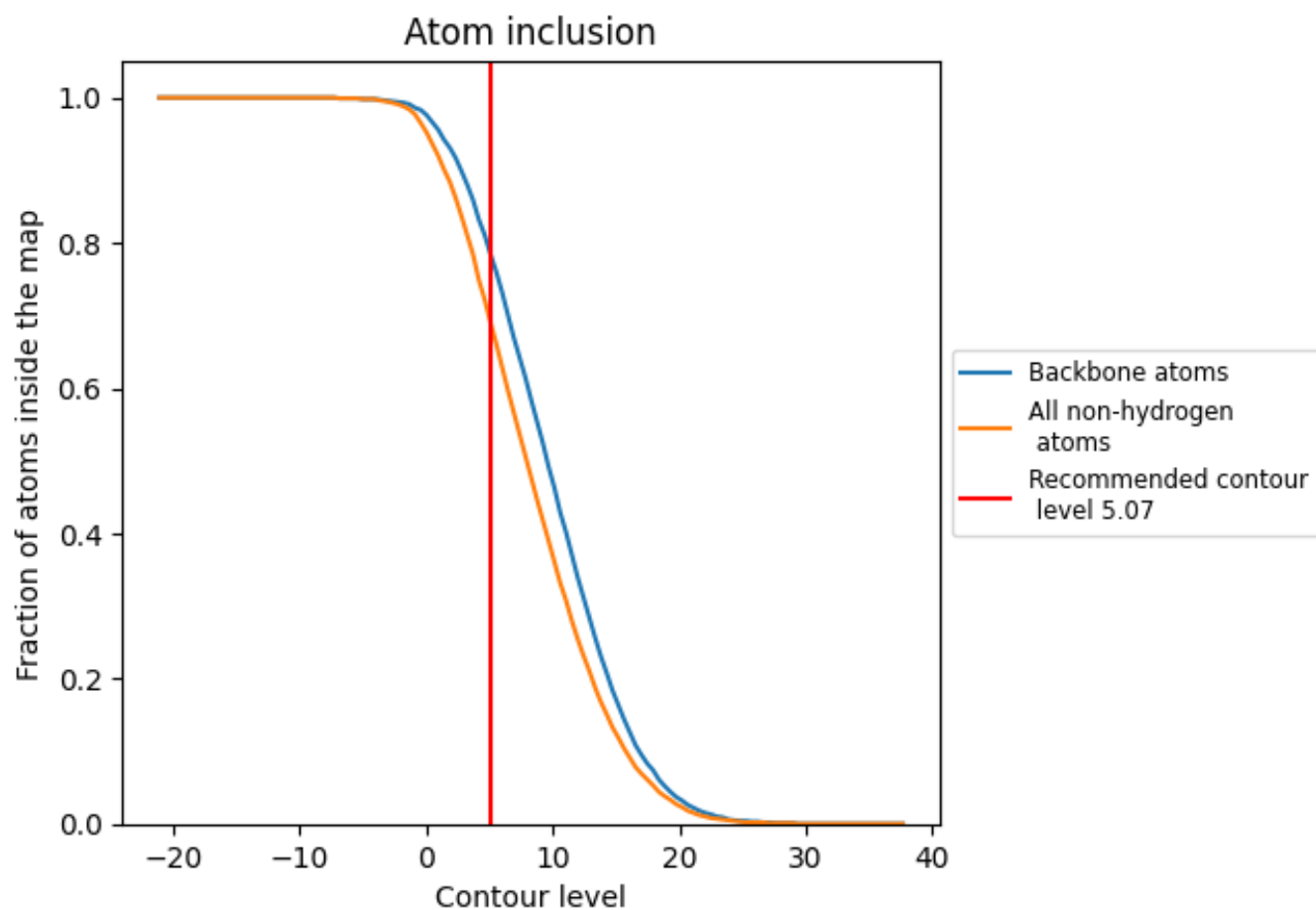









9.4 Atom inclusion [i](#)



At the recommended contour level, 78% of all backbone atoms, 69% of all non-hydrogen atoms, are inside the map.

9.5 Map-model fit summary

The table lists the average atom inclusion at the recommended contour level (5.07) and Q-score for the entire model and for each chain.

Chain	Atom inclusion	Q-score
All	 0.6900	 0.3260
A	 0.5980	 0.3310
B	 0.7490	 0.3350
G	 0.3530	 0.2330
R	 0.8020	 0.3280
S	 0.6300	 0.3300

