



wwPDB X-ray Structure Validation Summary Report ⓘ

Nov 9, 2020 – 07:32 PM GMT

PDB ID : 6ZGP
Title : Crystal structure of the quaternary ammonium Rieske monooxygenase CntA
in complex with inhibitor MMV12 (MMV020670)
Authors : Quareshy, M.; Shanmugam, M.; Bugg, T.D.H.; Cameron, A.; Chen, Y.
Deposited on : 2020-06-19
Resolution : 2.01 Å(reported)

This is a wwPDB X-ray Structure Validation Summary Report for a publicly released PDB entry.

We welcome your comments at validation@mail.wwpdb.org

A user guide is available at

<https://www.wwpdb.org/validation/2017/XrayValidationReportHelp>

with specific help available everywhere you see the ⓘ symbol.

The following versions of software and data (see [references ⓘ](#)) were used in the production of this report:

MolProbity : 4.02b-467
Mogul : 1.8.5 (274361), CSD as541be (2020)
Xtriage (Phenix) : 1.13
EDS : 2.14.6
buster-report : 1.1.7 (2018)
Percentile statistics : 20191225.v01 (using entries in the PDB archive December 25th 2019)
Refmac : 5.8.0158
CCP4 : 7.0.044 (Gargrove)
Ideal geometry (proteins) : Engh & Huber (2001)
Ideal geometry (DNA, RNA) : Parkinson et al. (1996)
Validation Pipeline (wwPDB-VP) : 2.14.6

1 Overall quality at a glance

The following experimental techniques were used to determine the structure:

X-RAY DIFFRACTION

The reported resolution of this entry is 2.01 Å.

Percentile scores (ranging between 0-100) for global validation metrics of the entry are shown in the following graphic. The table shows the number of entries on which the scores are based.

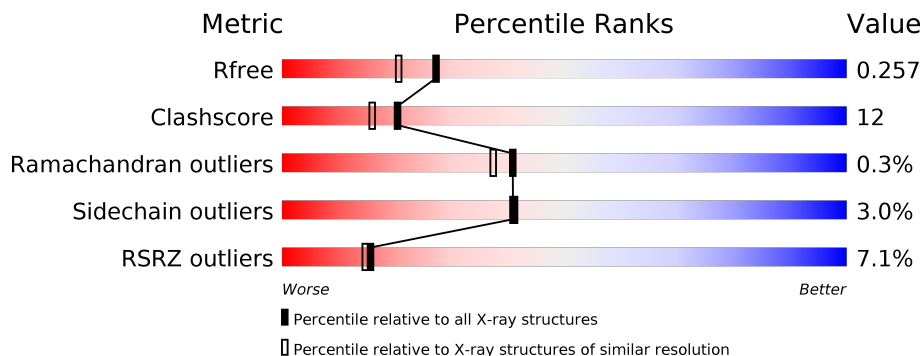

Metric	Whole archive (#Entries)	Similar resolution (#Entries, resolution range(Å))
R_{free}	130704	8085 (2.00-2.00)
Clashscore	141614	9178 (2.00-2.00)
Ramachandran outliers	138981	9054 (2.00-2.00)
Sidechain outliers	138945	9053 (2.00-2.00)
RSRZ outliers	127900	7900 (2.00-2.00)

The table below summarises the geometric issues observed across the polymeric chains and their fit to the electron density. The red, orange, yellow and green segments on the lower bar indicate the fraction of residues that contain outliers for ≥ 3 , 2, 1 and 0 types of geometric quality criteria respectively. A grey segment represents the fraction of residues that are not modelled. The numeric value for each fraction is indicated below the corresponding segment, with a dot representing fractions $\leq 5\%$. The upper red bar (where present) indicates the fraction of residues that have poor fit to the electron density. The numeric value is given above the bar.

Mol	Chain	Length	Quality of chain
1	A	391	
1	B	391	
1	C	391	
1	D	391	
1	E	391	
1	F	391	

Continued on next page...

Continued from previous page...

Mol	Chain	Length	Quality of chain
1	G	391	
1	H	391	
1	I	391	
1	J	391	
1	K	391	
1	L	391	

The following table lists non-polymeric compounds, carbohydrate monomers and non-standard residues in protein, DNA, RNA chains that are outliers for geometric or electron-density-fit criteria:

Mol	Type	Chain	Res	Chirality	Geometry	Clashes	Electron density
3	FES	L	402	-	-	X	-
4	QKQ	A	403	-	-	X	X
4	QKQ	B	403	-	-	X	-
4	QKQ	I	403	-	-	-	X
4	QKQ	K	403	-	-	X	-
4	QKQ	L	403	-	-	-	X
5	EPE	B	404	-	-	-	X
5	EPE	D	404	-	-	-	X
5	EPE	F	404	-	-	-	X
5	EPE	H	404	-	-	-	X
5	EPE	J	404	-	-	-	X
5	EPE	L	404	-	-	-	X

2 Entry composition i

There are 6 unique types of molecules in this entry. The entry contains 36907 atoms, of which 204 are hydrogens and 0 are deuteriums.

In the tables below, the ZeroOcc column contains the number of atoms modelled with zero occupancy, the AltConf column contains the number of residues with at least one atom in alternate conformation and the Trace column contains the number of residues modelled with at most 2 atoms.

- Molecule 1 is a protein called Carnitine monooxygenase oxygenase subunit.

Mol	Chain	Residues	Atoms					ZeroOcc	AltConf	Trace
			Total	C	N	O	S			
1	A	360	2917	1863	496	542	16	0	0	0
1	B	357	2895	1850	493	536	16	0	0	0
1	C	357	2897	1851	493	537	16	0	0	0
1	D	360	2917	1863	496	542	16	0	0	0
1	E	360	2917	1863	496	542	16	0	0	0
1	F	359	2911	1860	495	540	16	0	0	0
1	G	363	2945	1881	500	548	16	0	0	0
1	H	358	2904	1855	494	539	16	0	0	0
1	I	358	2903	1854	494	539	16	0	0	0
1	J	356	2887	1846	489	536	16	0	0	0
1	K	359	2910	1858	495	541	16	0	0	0
1	L	358	2904	1855	494	539	16	0	0	0

There are 240 discrepancies between the modelled and reference sequences:

Chain	Residue	Modelled	Actual	Comment	Reference
A	-19	MET	-	initiating methionine	UNP A0A059ZPP5
A	-18	GLY	-	expression tag	UNP A0A059ZPP5
A	-17	SER	-	expression tag	UNP A0A059ZPP5
A	-16	SER	-	expression tag	UNP A0A059ZPP5
A	-15	HIS	-	expression tag	UNP A0A059ZPP5

Continued on next page...

Continued from previous page...

Chain	Residue	Modelled	Actual	Comment	Reference
A	-14	HIS	-	expression tag	UNP A0A059ZPP5
A	-13	HIS	-	expression tag	UNP A0A059ZPP5
A	-12	HIS	-	expression tag	UNP A0A059ZPP5
A	-11	HIS	-	expression tag	UNP A0A059ZPP5
A	-10	HIS	-	expression tag	UNP A0A059ZPP5
A	-9	SER	-	expression tag	UNP A0A059ZPP5
A	-8	SER	-	expression tag	UNP A0A059ZPP5
A	-7	GLY	-	expression tag	UNP A0A059ZPP5
A	-6	LEU	-	expression tag	UNP A0A059ZPP5
A	-5	VAL	-	expression tag	UNP A0A059ZPP5
A	-4	PRO	-	expression tag	UNP A0A059ZPP5
A	-3	ARG	-	expression tag	UNP A0A059ZPP5
A	-2	GLY	-	expression tag	UNP A0A059ZPP5
A	-1	SER	-	expression tag	UNP A0A059ZPP5
A	0	HIS	-	expression tag	UNP A0A059ZPP5
B	-19	MET	-	initiating methionine	UNP A0A059ZPP5
B	-18	GLY	-	expression tag	UNP A0A059ZPP5
B	-17	SER	-	expression tag	UNP A0A059ZPP5
B	-16	SER	-	expression tag	UNP A0A059ZPP5
B	-15	HIS	-	expression tag	UNP A0A059ZPP5
B	-14	HIS	-	expression tag	UNP A0A059ZPP5
B	-13	HIS	-	expression tag	UNP A0A059ZPP5
B	-12	HIS	-	expression tag	UNP A0A059ZPP5
B	-11	HIS	-	expression tag	UNP A0A059ZPP5
B	-10	HIS	-	expression tag	UNP A0A059ZPP5
B	-9	SER	-	expression tag	UNP A0A059ZPP5
B	-8	SER	-	expression tag	UNP A0A059ZPP5
B	-7	GLY	-	expression tag	UNP A0A059ZPP5
B	-6	LEU	-	expression tag	UNP A0A059ZPP5
B	-5	VAL	-	expression tag	UNP A0A059ZPP5
B	-4	PRO	-	expression tag	UNP A0A059ZPP5
B	-3	ARG	-	expression tag	UNP A0A059ZPP5
B	-2	GLY	-	expression tag	UNP A0A059ZPP5
B	-1	SER	-	expression tag	UNP A0A059ZPP5
B	0	HIS	-	expression tag	UNP A0A059ZPP5
C	-19	MET	-	initiating methionine	UNP A0A059ZPP5
C	-18	GLY	-	expression tag	UNP A0A059ZPP5
C	-17	SER	-	expression tag	UNP A0A059ZPP5
C	-16	SER	-	expression tag	UNP A0A059ZPP5
C	-15	HIS	-	expression tag	UNP A0A059ZPP5
C	-14	HIS	-	expression tag	UNP A0A059ZPP5
C	-13	HIS	-	expression tag	UNP A0A059ZPP5

Continued on next page...

Continued from previous page...

Chain	Residue	Modelled	Actual	Comment	Reference
C	-12	HIS	-	expression tag	UNP A0A059ZPP5
C	-11	HIS	-	expression tag	UNP A0A059ZPP5
C	-10	HIS	-	expression tag	UNP A0A059ZPP5
C	-9	SER	-	expression tag	UNP A0A059ZPP5
C	-8	SER	-	expression tag	UNP A0A059ZPP5
C	-7	GLY	-	expression tag	UNP A0A059ZPP5
C	-6	LEU	-	expression tag	UNP A0A059ZPP5
C	-5	VAL	-	expression tag	UNP A0A059ZPP5
C	-4	PRO	-	expression tag	UNP A0A059ZPP5
C	-3	ARG	-	expression tag	UNP A0A059ZPP5
C	-2	GLY	-	expression tag	UNP A0A059ZPP5
C	-1	SER	-	expression tag	UNP A0A059ZPP5
C	0	HIS	-	expression tag	UNP A0A059ZPP5
D	-19	MET	-	initiating methionine	UNP A0A059ZPP5
D	-18	GLY	-	expression tag	UNP A0A059ZPP5
D	-17	SER	-	expression tag	UNP A0A059ZPP5
D	-16	SER	-	expression tag	UNP A0A059ZPP5
D	-15	HIS	-	expression tag	UNP A0A059ZPP5
D	-14	HIS	-	expression tag	UNP A0A059ZPP5
D	-13	HIS	-	expression tag	UNP A0A059ZPP5
D	-12	HIS	-	expression tag	UNP A0A059ZPP5
D	-11	HIS	-	expression tag	UNP A0A059ZPP5
D	-10	HIS	-	expression tag	UNP A0A059ZPP5
D	-9	SER	-	expression tag	UNP A0A059ZPP5
D	-8	SER	-	expression tag	UNP A0A059ZPP5
D	-7	GLY	-	expression tag	UNP A0A059ZPP5
D	-6	LEU	-	expression tag	UNP A0A059ZPP5
D	-5	VAL	-	expression tag	UNP A0A059ZPP5
D	-4	PRO	-	expression tag	UNP A0A059ZPP5
D	-3	ARG	-	expression tag	UNP A0A059ZPP5
D	-2	GLY	-	expression tag	UNP A0A059ZPP5
D	-1	SER	-	expression tag	UNP A0A059ZPP5
D	0	HIS	-	expression tag	UNP A0A059ZPP5
E	-19	MET	-	initiating methionine	UNP A0A059ZPP5
E	-18	GLY	-	expression tag	UNP A0A059ZPP5
E	-17	SER	-	expression tag	UNP A0A059ZPP5
E	-16	SER	-	expression tag	UNP A0A059ZPP5
E	-15	HIS	-	expression tag	UNP A0A059ZPP5
E	-14	HIS	-	expression tag	UNP A0A059ZPP5
E	-13	HIS	-	expression tag	UNP A0A059ZPP5
E	-12	HIS	-	expression tag	UNP A0A059ZPP5
E	-11	HIS	-	expression tag	UNP A0A059ZPP5

Continued on next page...

Continued from previous page...

Chain	Residue	Modelled	Actual	Comment	Reference
E	-10	HIS	-	expression tag	UNP A0A059ZPP5
E	-9	SER	-	expression tag	UNP A0A059ZPP5
E	-8	SER	-	expression tag	UNP A0A059ZPP5
E	-7	GLY	-	expression tag	UNP A0A059ZPP5
E	-6	LEU	-	expression tag	UNP A0A059ZPP5
E	-5	VAL	-	expression tag	UNP A0A059ZPP5
E	-4	PRO	-	expression tag	UNP A0A059ZPP5
E	-3	ARG	-	expression tag	UNP A0A059ZPP5
E	-2	GLY	-	expression tag	UNP A0A059ZPP5
E	-1	SER	-	expression tag	UNP A0A059ZPP5
E	0	HIS	-	expression tag	UNP A0A059ZPP5
F	-19	MET	-	initiating methionine	UNP A0A059ZPP5
F	-18	GLY	-	expression tag	UNP A0A059ZPP5
F	-17	SER	-	expression tag	UNP A0A059ZPP5
F	-16	SER	-	expression tag	UNP A0A059ZPP5
F	-15	HIS	-	expression tag	UNP A0A059ZPP5
F	-14	HIS	-	expression tag	UNP A0A059ZPP5
F	-13	HIS	-	expression tag	UNP A0A059ZPP5
F	-12	HIS	-	expression tag	UNP A0A059ZPP5
F	-11	HIS	-	expression tag	UNP A0A059ZPP5
F	-10	HIS	-	expression tag	UNP A0A059ZPP5
F	-9	SER	-	expression tag	UNP A0A059ZPP5
F	-8	SER	-	expression tag	UNP A0A059ZPP5
F	-7	GLY	-	expression tag	UNP A0A059ZPP5
F	-6	LEU	-	expression tag	UNP A0A059ZPP5
F	-5	VAL	-	expression tag	UNP A0A059ZPP5
F	-4	PRO	-	expression tag	UNP A0A059ZPP5
F	-3	ARG	-	expression tag	UNP A0A059ZPP5
F	-2	GLY	-	expression tag	UNP A0A059ZPP5
F	-1	SER	-	expression tag	UNP A0A059ZPP5
F	0	HIS	-	expression tag	UNP A0A059ZPP5
G	-19	MET	-	initiating methionine	UNP A0A059ZPP5
G	-18	GLY	-	expression tag	UNP A0A059ZPP5
G	-17	SER	-	expression tag	UNP A0A059ZPP5
G	-16	SER	-	expression tag	UNP A0A059ZPP5
G	-15	HIS	-	expression tag	UNP A0A059ZPP5
G	-14	HIS	-	expression tag	UNP A0A059ZPP5
G	-13	HIS	-	expression tag	UNP A0A059ZPP5
G	-12	HIS	-	expression tag	UNP A0A059ZPP5
G	-11	HIS	-	expression tag	UNP A0A059ZPP5
G	-10	HIS	-	expression tag	UNP A0A059ZPP5
G	-9	SER	-	expression tag	UNP A0A059ZPP5

Continued on next page...

Continued from previous page...

Chain	Residue	Modelled	Actual	Comment	Reference
G	-8	SER	-	expression tag	UNP A0A059ZPP5
G	-7	GLY	-	expression tag	UNP A0A059ZPP5
G	-6	LEU	-	expression tag	UNP A0A059ZPP5
G	-5	VAL	-	expression tag	UNP A0A059ZPP5
G	-4	PRO	-	expression tag	UNP A0A059ZPP5
G	-3	ARG	-	expression tag	UNP A0A059ZPP5
G	-2	GLY	-	expression tag	UNP A0A059ZPP5
G	-1	SER	-	expression tag	UNP A0A059ZPP5
G	0	HIS	-	expression tag	UNP A0A059ZPP5
H	-19	MET	-	initiating methionine	UNP A0A059ZPP5
H	-18	GLY	-	expression tag	UNP A0A059ZPP5
H	-17	SER	-	expression tag	UNP A0A059ZPP5
H	-16	SER	-	expression tag	UNP A0A059ZPP5
H	-15	HIS	-	expression tag	UNP A0A059ZPP5
H	-14	HIS	-	expression tag	UNP A0A059ZPP5
H	-13	HIS	-	expression tag	UNP A0A059ZPP5
H	-12	HIS	-	expression tag	UNP A0A059ZPP5
H	-11	HIS	-	expression tag	UNP A0A059ZPP5
H	-10	HIS	-	expression tag	UNP A0A059ZPP5
H	-9	SER	-	expression tag	UNP A0A059ZPP5
H	-8	SER	-	expression tag	UNP A0A059ZPP5
H	-7	GLY	-	expression tag	UNP A0A059ZPP5
H	-6	LEU	-	expression tag	UNP A0A059ZPP5
H	-5	VAL	-	expression tag	UNP A0A059ZPP5
H	-4	PRO	-	expression tag	UNP A0A059ZPP5
H	-3	ARG	-	expression tag	UNP A0A059ZPP5
H	-2	GLY	-	expression tag	UNP A0A059ZPP5
H	-1	SER	-	expression tag	UNP A0A059ZPP5
H	0	HIS	-	expression tag	UNP A0A059ZPP5
I	-19	MET	-	initiating methionine	UNP A0A059ZPP5
I	-18	GLY	-	expression tag	UNP A0A059ZPP5
I	-17	SER	-	expression tag	UNP A0A059ZPP5
I	-16	SER	-	expression tag	UNP A0A059ZPP5
I	-15	HIS	-	expression tag	UNP A0A059ZPP5
I	-14	HIS	-	expression tag	UNP A0A059ZPP5
I	-13	HIS	-	expression tag	UNP A0A059ZPP5
I	-12	HIS	-	expression tag	UNP A0A059ZPP5
I	-11	HIS	-	expression tag	UNP A0A059ZPP5
I	-10	HIS	-	expression tag	UNP A0A059ZPP5
I	-9	SER	-	expression tag	UNP A0A059ZPP5
I	-8	SER	-	expression tag	UNP A0A059ZPP5
I	-7	GLY	-	expression tag	UNP A0A059ZPP5

Continued on next page...

Continued from previous page...

Chain	Residue	Modelled	Actual	Comment	Reference
I	-6	LEU	-	expression tag	UNP A0A059ZPP5
I	-5	VAL	-	expression tag	UNP A0A059ZPP5
I	-4	PRO	-	expression tag	UNP A0A059ZPP5
I	-3	ARG	-	expression tag	UNP A0A059ZPP5
I	-2	GLY	-	expression tag	UNP A0A059ZPP5
I	-1	SER	-	expression tag	UNP A0A059ZPP5
I	0	HIS	-	expression tag	UNP A0A059ZPP5
J	-19	MET	-	initiating methionine	UNP A0A059ZPP5
J	-18	GLY	-	expression tag	UNP A0A059ZPP5
J	-17	SER	-	expression tag	UNP A0A059ZPP5
J	-16	SER	-	expression tag	UNP A0A059ZPP5
J	-15	HIS	-	expression tag	UNP A0A059ZPP5
J	-14	HIS	-	expression tag	UNP A0A059ZPP5
J	-13	HIS	-	expression tag	UNP A0A059ZPP5
J	-12	HIS	-	expression tag	UNP A0A059ZPP5
J	-11	HIS	-	expression tag	UNP A0A059ZPP5
J	-10	HIS	-	expression tag	UNP A0A059ZPP5
J	-9	SER	-	expression tag	UNP A0A059ZPP5
J	-8	SER	-	expression tag	UNP A0A059ZPP5
J	-7	GLY	-	expression tag	UNP A0A059ZPP5
J	-6	LEU	-	expression tag	UNP A0A059ZPP5
J	-5	VAL	-	expression tag	UNP A0A059ZPP5
J	-4	PRO	-	expression tag	UNP A0A059ZPP5
J	-3	ARG	-	expression tag	UNP A0A059ZPP5
J	-2	GLY	-	expression tag	UNP A0A059ZPP5
J	-1	SER	-	expression tag	UNP A0A059ZPP5
J	0	HIS	-	expression tag	UNP A0A059ZPP5
K	-19	MET	-	initiating methionine	UNP A0A059ZPP5
K	-18	GLY	-	expression tag	UNP A0A059ZPP5
K	-17	SER	-	expression tag	UNP A0A059ZPP5
K	-16	SER	-	expression tag	UNP A0A059ZPP5
K	-15	HIS	-	expression tag	UNP A0A059ZPP5
K	-14	HIS	-	expression tag	UNP A0A059ZPP5
K	-13	HIS	-	expression tag	UNP A0A059ZPP5
K	-12	HIS	-	expression tag	UNP A0A059ZPP5
K	-11	HIS	-	expression tag	UNP A0A059ZPP5
K	-10	HIS	-	expression tag	UNP A0A059ZPP5
K	-9	SER	-	expression tag	UNP A0A059ZPP5
K	-8	SER	-	expression tag	UNP A0A059ZPP5
K	-7	GLY	-	expression tag	UNP A0A059ZPP5
K	-6	LEU	-	expression tag	UNP A0A059ZPP5
K	-5	VAL	-	expression tag	UNP A0A059ZPP5

Continued on next page...

Continued from previous page...

Chain	Residue	Modelled	Actual	Comment	Reference
K	-4	PRO	-	expression tag	UNP A0A059ZPP5
K	-3	ARG	-	expression tag	UNP A0A059ZPP5
K	-2	GLY	-	expression tag	UNP A0A059ZPP5
K	-1	SER	-	expression tag	UNP A0A059ZPP5
K	0	HIS	-	expression tag	UNP A0A059ZPP5
L	-19	MET	-	initiating methionine	UNP A0A059ZPP5
L	-18	GLY	-	expression tag	UNP A0A059ZPP5
L	-17	SER	-	expression tag	UNP A0A059ZPP5
L	-16	SER	-	expression tag	UNP A0A059ZPP5
L	-15	HIS	-	expression tag	UNP A0A059ZPP5
L	-14	HIS	-	expression tag	UNP A0A059ZPP5
L	-13	HIS	-	expression tag	UNP A0A059ZPP5
L	-12	HIS	-	expression tag	UNP A0A059ZPP5
L	-11	HIS	-	expression tag	UNP A0A059ZPP5
L	-10	HIS	-	expression tag	UNP A0A059ZPP5
L	-9	SER	-	expression tag	UNP A0A059ZPP5
L	-8	SER	-	expression tag	UNP A0A059ZPP5
L	-7	GLY	-	expression tag	UNP A0A059ZPP5
L	-6	LEU	-	expression tag	UNP A0A059ZPP5
L	-5	VAL	-	expression tag	UNP A0A059ZPP5
L	-4	PRO	-	expression tag	UNP A0A059ZPP5
L	-3	ARG	-	expression tag	UNP A0A059ZPP5
L	-2	GLY	-	expression tag	UNP A0A059ZPP5
L	-1	SER	-	expression tag	UNP A0A059ZPP5
L	0	HIS	-	expression tag	UNP A0A059ZPP5

- Molecule 2 is FE (III) ION (three-letter code: FE) (formula: Fe) (labeled as "Ligand of Interest" by author).

Mol	Chain	Residues	Atoms	ZeroOcc	AltConf
2	G	1	Total Fe 1 1	0	0
2	J	1	Total Fe 1 1	0	0
2	D	1	Total Fe 1 1	0	0
2	K	1	Total Fe 1 1	0	0
2	E	1	Total Fe 1 1	0	0
2	H	1	Total Fe 1 1	0	0

Continued on next page...

Continued from previous page...

Mol	Chain	Residues	Atoms	ZeroOcc	AltConf
2	B	1	Total Fe 1 1	0	0
2	I	1	Total Fe 1 1	0	0
2	C	1	Total Fe 1 1	0	0
2	A	1	Total Fe 1 1	0	0
2	L	1	Total Fe 1 1	0	0
2	F	1	Total Fe 1 1	0	0

- Molecule 3 is FE2/S2 (INORGANIC) CLUSTER (three-letter code: FES) (formula: Fe₂S₂) (labeled as "Ligand of Interest" by author).

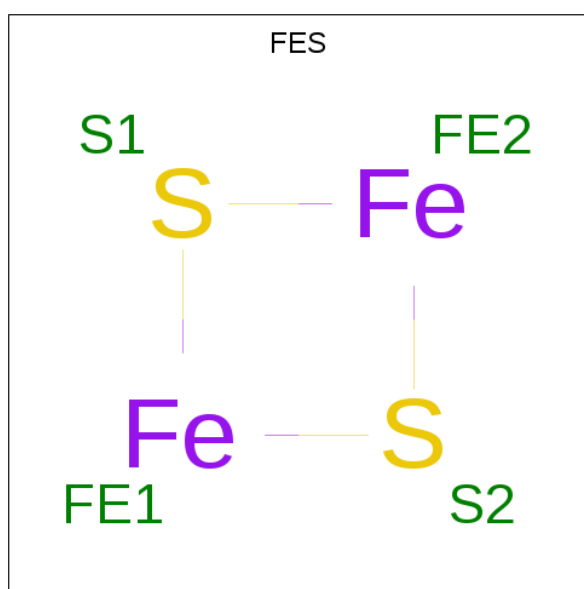

Mol	Chain	Residues	Atoms	ZeroOcc	AltConf
3	A	1	Total Fe S 4 2 2	0	0
3	B	1	Total Fe S 4 2 2	0	0
3	C	1	Total Fe S 4 2 2	0	0
3	D	1	Total Fe S 4 2 2	0	0
3	E	1	Total Fe S 4 2 2	0	0

Continued on next page...

Continued from previous page...

Mol	Chain	Residues	Atoms			ZeroOcc	AltConf
3	F	1	Total	Fe	S	0	0
			4	2	2		
3	G	1	Total	Fe	S	0	0
			4	2	2		
3	H	1	Total	Fe	S	0	0
			4	2	2		
3	I	1	Total	Fe	S	0	0
			4	2	2		
3	J	1	Total	Fe	S	0	0
			4	2	2		
3	K	1	Total	Fe	S	0	0
			4	2	2		
3	L	1	Total	Fe	S	0	0
			4	2	2		

- Molecule 4 is {N}-(3-imidazol-1-ylpropyl)-8-(4-methoxyphenyl)-1,6-naphthyridine-2-carboxamide (three-letter code: QKQ) (formula: C₂₂H₂₁N₅O₂) (labeled as "Ligand of Interest" by author).

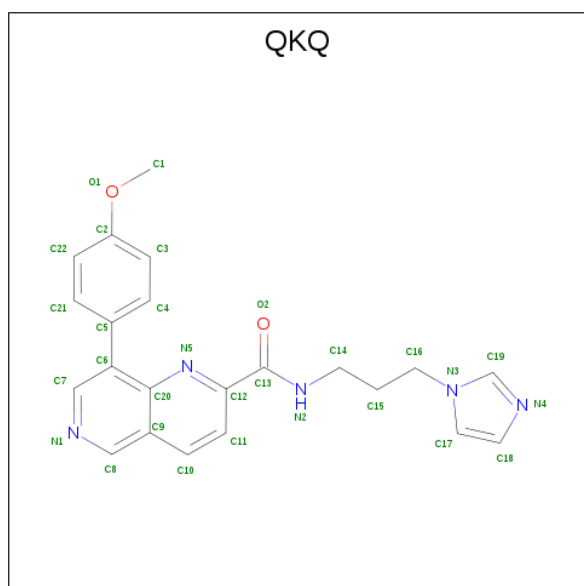

Mol	Chain	Residues	Atoms				ZeroOcc	AltConf
4	A	1	Total	C	N	O	0	0
			29	22	5	2		
4	B	1	Total	C	N	O	0	0
			29	22	5	2		
4	C	1	Total	C	N	O	0	0
			29	22	5	2		

Continued on next page...

Continued from previous page...

Mol	Chain	Residues	Atoms				ZeroOcc	AltConf
			Total	C	N	O		
4	D	1	Total 29	C 22	N 5	O 2	0	0
4	E	1	Total 29	C 22	N 5	O 2	0	0
4	F	1	Total 29	C 22	N 5	O 2	0	0
4	G	1	Total 29	C 22	N 5	O 2	0	0
4	H	1	Total 29	C 22	N 5	O 2	0	0
4	I	1	Total 29	C 22	N 5	O 2	0	0
4	J	1	Total 29	C 22	N 5	O 2	0	0
4	K	1	Total 29	C 22	N 5	O 2	0	0
4	L	1	Total 29	C 22	N 5	O 2	0	0

- Molecule 5 is 4-(2-HYDROXYETHYL)-1-PIPERAZINE ETHANESULFONIC ACID (three-letter code: EPE) (formula: C₈H₁₈N₂O₄S).

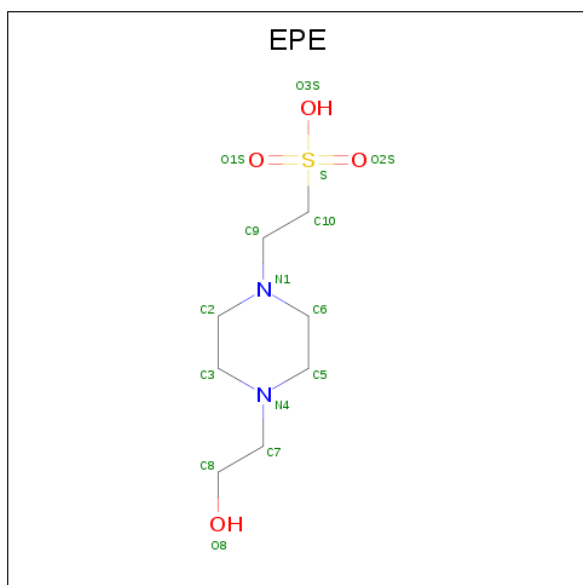

Mol	Chain	Residues	Atoms					ZeroOcc	AltConf	
			Total	C	H	N	O			S
5	A	1	Total 32	C 8	H 17	N 2	O 4	S 1	0	0
5	B	1	Total 32	C 8	H 17	N 2	O 4	S 1	0	0

Continued on next page...

Continued from previous page...

Mol	Chain	Residues	Atoms					ZeroOcc	AltConf	
5	C	1	Total	C	H	N	O	S	0	0
			32	8	17	2	4	1		
5	D	1	Total	C	H	N	O	S	0	0
			32	8	17	2	4	1		
5	E	1	Total	C	H	N	O	S	0	0
			32	8	17	2	4	1		
5	F	1	Total	C	H	N	O	S	0	0
			32	8	17	2	4	1		
5	G	1	Total	C	H	N	O	S	0	0
			32	8	17	2	4	1		
5	H	1	Total	C	H	N	O	S	0	0
			32	8	17	2	4	1		
5	I	1	Total	C	H	N	O	S	0	0
			32	8	17	2	4	1		
5	J	1	Total	C	H	N	O	S	0	0
			32	8	17	2	4	1		
5	K	1	Total	C	H	N	O	S	0	0
			32	8	17	2	4	1		
5	L	1	Total	C	H	N	O	S	0	0
			32	8	17	2	4	1		

- Molecule 6 is water.

Mol	Chain	Residues	Atoms		ZeroOcc	AltConf
6	A	75	Total	O	0	0
			75	75		
6	B	87	Total	O	0	0
			87	87		
6	C	51	Total	O	0	0
			51	51		
6	D	99	Total	O	0	0
			99	99		
6	E	103	Total	O	0	0
			103	103		
6	F	122	Total	O	0	0
			122	122		
6	G	147	Total	O	0	0
			147	147		
6	H	135	Total	O	0	0
			135	135		
6	I	113	Total	O	0	0
			113	113		

Continued on next page...

Continued from previous page...

Mol	Chain	Residues	Atoms		ZeroOcc	AltConf
6	J	105	Total 105	O 105	0	0
6	K	79	Total 79	O 79	0	0
6	L	92	Total 92	O 92	0	0

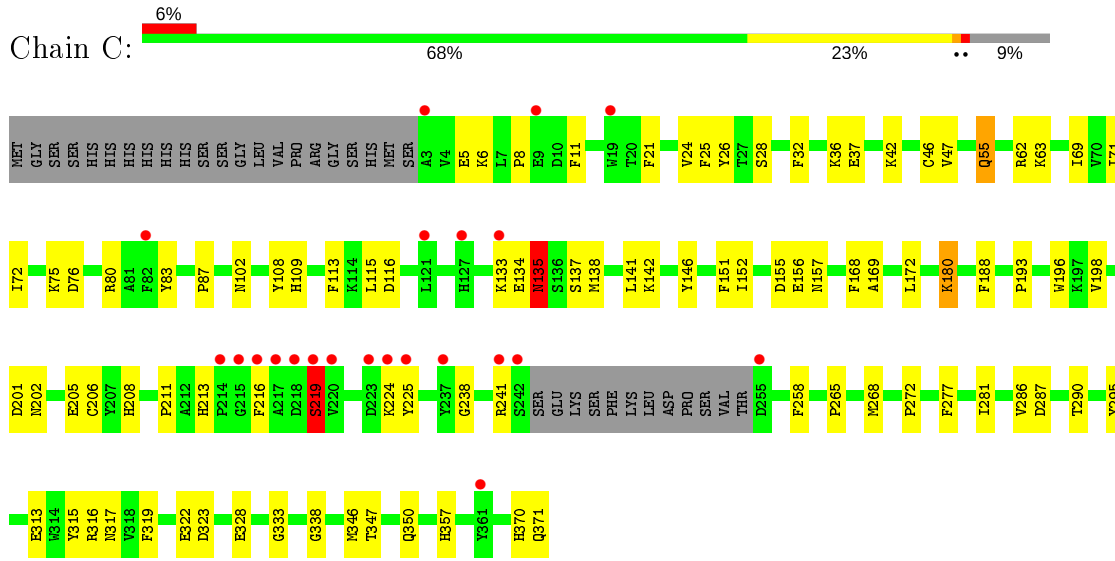

• Molecule 1: Carnitine monooxygenase oxygenase subunit

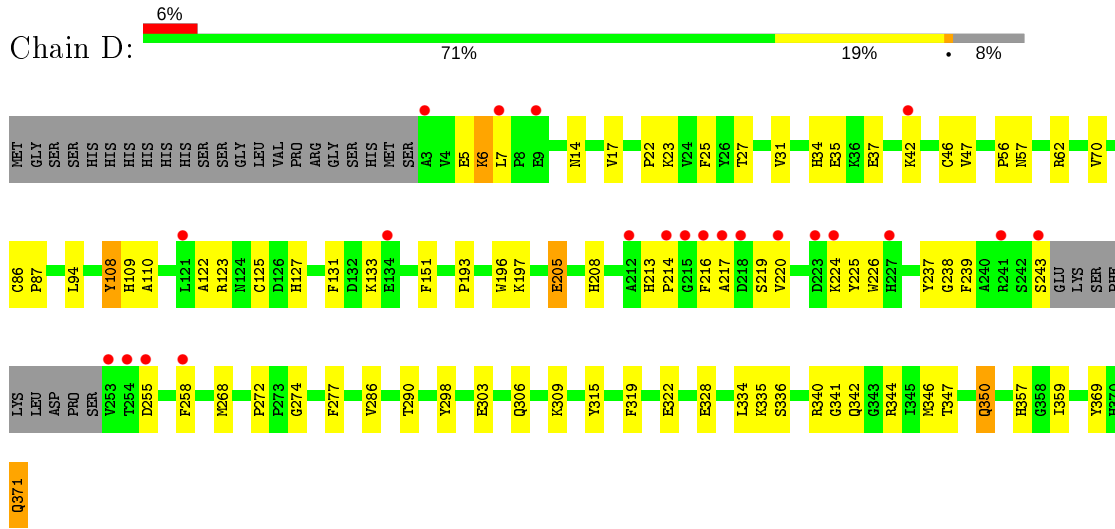

• Molecule 1: Carnitine monooxygenase oxygenase subunit

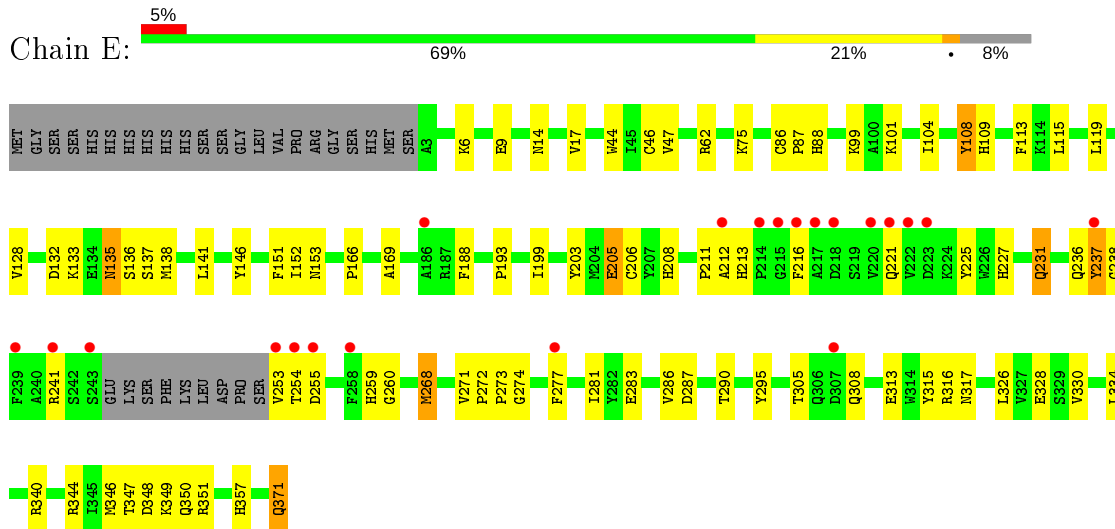

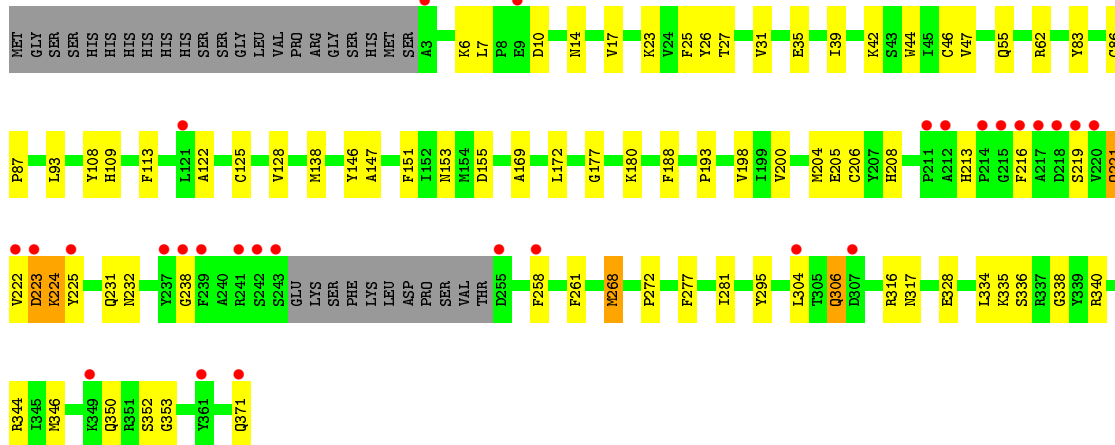

- Molecule 1: Carnitine monooxygenase oxygenase subunit

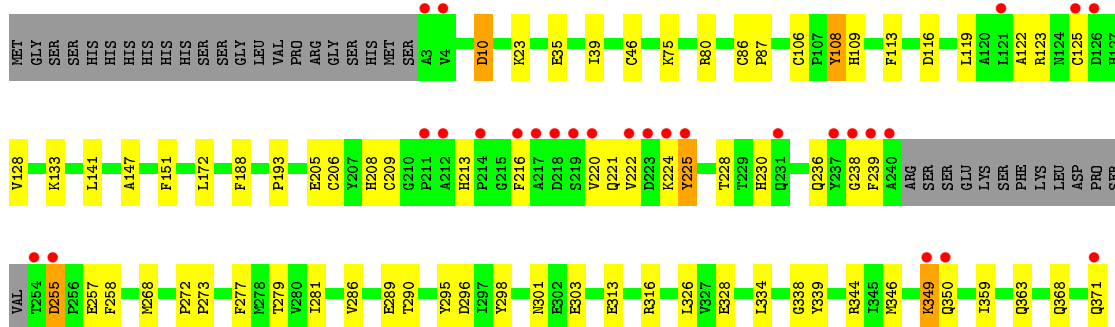

- Molecule 1: Carnitine monooxygenase oxygenase subunit

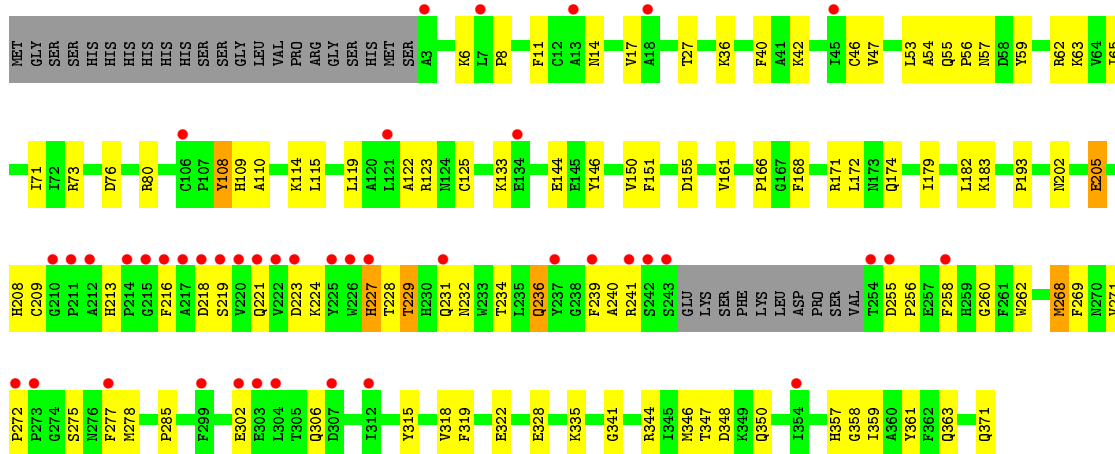

- Molecule 1: Carnitine monooxygenase oxygenase subunit

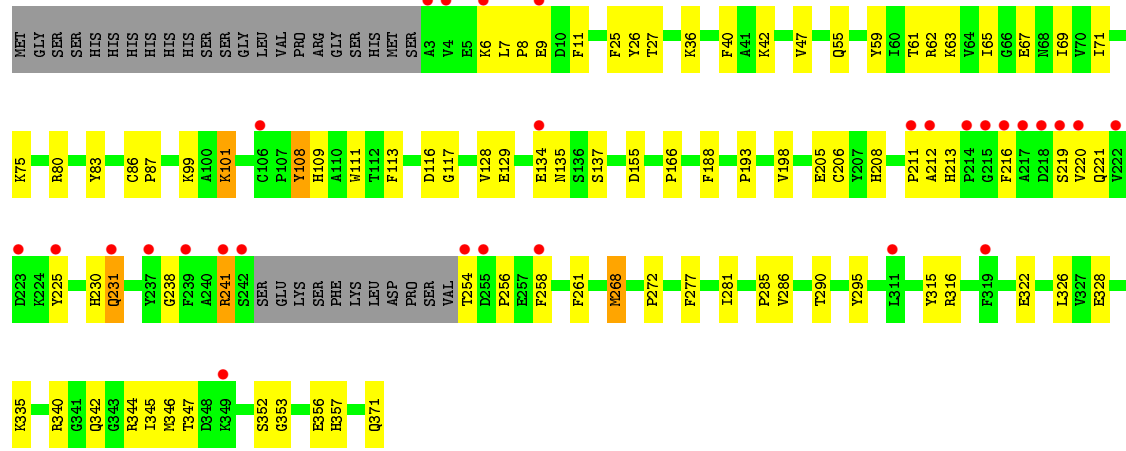

4 Data and refinement statistics

Property	Value	Source
Space group	P 1 21 1	Depositor
Cell constants a, b, c, α , β , γ	91.07Å 173.77Å 157.29Å 90.00° 90.15° 90.00°	Depositor
Resolution (Å)	80.66 – 2.01 80.66 – 2.01	Depositor EDS
% Data completeness (in resolution range)	99.4 (80.66-2.01) 99.7 (80.66-2.01)	Depositor EDS
R_{merge}	0.17	Depositor
R_{sym}	(Not available)	Depositor
$\langle I/\sigma(I) \rangle$ ¹	1.84 (at 2.02Å)	Xtriage
Refinement program	PHENIX 1.14_3260	Depositor
R, R_{free}	0.214 , 0.255 0.220 , 0.257	Depositor DCC
R_{free} test set	16283 reflections (5.04%)	wwPDB-VP
Wilson B-factor (Å ²)	30.1	Xtriage
Anisotropy	0.794	Xtriage
Bulk solvent k_{sol} (e/Å ³), B_{sol} (Å ²)	0.34 , 44.0	EDS
L-test for twinning ²	$\langle L \rangle = 0.49$, $\langle L^2 \rangle = 0.32$	Xtriage
Estimated twinning fraction	0.058 for h,-k,-l	Xtriage
F_o, F_c correlation	0.95	EDS
Total number of atoms	36907	wwPDB-VP
Average B, all atoms (Å ²)	51.0	wwPDB-VP

Xtriage's analysis on translational NCS is as follows: *The analyses of the Patterson function reveals a significant off-origin peak that is 58.28 % of the origin peak, indicating pseudo-translational symmetry. The chance of finding a peak of this or larger height randomly in a structure without pseudo-translational symmetry is equal to 2.0924e-05. The detected translational NCS is most likely also responsible for the elevated intensity ratio.*

¹Intensities estimated from amplitudes.

²Theoretical values of $\langle |L| \rangle$, $\langle L^2 \rangle$ for acentric reflections are 0.5, 0.333 respectively for untwinned datasets, and 0.375, 0.2 for perfectly twinned datasets.

5 Model quality

5.1 Standard geometry

Bond lengths and bond angles in the following residue types are not validated in this section: QKQ, EPE, FE, FES

The Z score for a bond length (or angle) is the number of standard deviations the observed value is removed from the expected value. A bond length (or angle) with $|Z| > 5$ is considered an outlier worth inspection. RMSZ is the root-mean-square of all Z scores of the bond lengths (or angles).

Mol	Chain	Bond lengths		Bond angles	
		RMSZ	# Z >5	RMSZ	# Z >5
1	A	0.46	0/3003	0.60	0/4080
1	B	0.45	0/2981	0.61	0/4048
1	C	0.43	0/2983	0.61	0/4052
1	D	0.46	0/3003	0.62	0/4080
1	E	0.44	0/3003	0.60	0/4080
1	F	0.47	0/2997	0.62	0/4072
1	G	0.47	0/3032	0.61	0/4117
1	H	0.48	0/2990	0.62	0/4062
1	I	0.50	0/2989	0.63	0/4060
1	J	0.47	0/2973	0.61	0/4040
1	K	0.44	0/2996	0.61	1/4070 (0.0%)
1	L	0.45	0/2990	0.60	0/4062
All	All	0.46	0/35940	0.61	1/48823 (0.0%)

There are no bond length outliers.

All (1) bond angle outliers are listed below:

Mol	Chain	Res	Type	Atoms	Z	Observed(°)	Ideal(°)
1	K	236	GLN	CB-CA-C	5.83	122.06	110.40

There are no chirality outliers.

There are no planarity outliers.

5.2 Too-close contacts

In the following table, the Non-H and H(model) columns list the number of non-hydrogen atoms and hydrogen atoms in the chain respectively. The H(added) column lists the number of hydrogen atoms added and optimized by MolProbity. The Clashes column lists the number of clashes within the asymmetric unit, whereas Symm-Clashes lists symmetry related clashes.

Mol	Chain	Non-H	H(model)	H(added)	Clashes	Symm-Clashes
1	A	2917	0	2759	74	0
1	B	2895	0	2740	91	0
1	C	2897	0	2738	79	0
1	D	2917	0	2759	64	0
1	E	2917	0	2759	89	0
1	F	2911	0	2754	76	0
1	G	2945	0	2783	68	0
1	H	2904	0	2745	52	0
1	I	2903	0	2743	62	0
1	J	2887	0	2727	64	0
1	K	2910	0	2750	98	0
1	L	2904	0	2745	75	0
2	A	1	0	0	0	0
2	B	1	0	0	0	0
2	C	1	0	0	0	0
2	D	1	0	0	0	0
2	E	1	0	0	0	0
2	F	1	0	0	0	0
2	G	1	0	0	0	0
2	H	1	0	0	0	0
2	I	1	0	0	0	0
2	J	1	0	0	0	0
2	K	1	0	0	0	0
2	L	1	0	0	0	0
3	A	4	0	0	1	0
3	B	4	0	0	0	0
3	C	4	0	0	0	0
3	D	4	0	0	0	0
3	E	4	0	0	0	0
3	F	4	0	0	0	0
3	G	4	0	0	0	0
3	H	4	0	0	0	0
3	I	4	0	0	0	0
3	J	4	0	0	0	0
3	K	4	0	0	0	0
3	L	4	0	0	2	0
4	A	29	0	0	15	0
4	B	29	0	0	13	0
4	C	29	0	0	6	0
4	D	29	0	0	6	0
4	E	29	0	0	7	0
4	F	29	0	0	8	0
4	G	29	0	0	6	0

Continued on next page...

Continued from previous page...

Mol	Chain	Non-H	H(model)	H(added)	Clashes	Symm-Clashes
4	H	29	0	0	3	0
4	I	29	0	0	2	0
4	J	29	0	0	3	0
4	K	29	0	0	16	0
4	L	29	0	0	5	0
5	A	15	17	18	0	0
5	B	15	17	18	1	0
5	C	15	17	17	0	0
5	D	15	17	18	0	0
5	E	15	17	17	1	0
5	F	15	17	17	2	0
5	G	15	17	18	1	0
5	H	15	17	18	0	0
5	I	15	17	18	1	0
5	J	15	17	18	0	0
5	K	15	17	17	0	0
5	L	15	17	18	2	0
6	A	75	0	0	3	0
6	B	87	0	0	3	0
6	C	51	0	0	4	0
6	D	99	0	0	2	0
6	E	103	0	0	3	0
6	F	122	0	0	7	0
6	G	147	0	0	6	0
6	H	135	0	0	6	0
6	I	113	0	0	1	0
6	J	105	0	0	0	0
6	K	79	0	0	4	0
6	L	92	0	0	0	0
All	All	36703	204	33214	851	0

The all-atom clashscore is defined as the number of clashes found per 1000 atoms (including hydrogen atoms). The all-atom clashscore for this structure is 12.

The worst 5 of 851 close contacts within the same asymmetric unit are listed below, sorted by their clash magnitude.

Atom-1	Atom-2	Interatomic distance (Å)	Clash overlap (Å)
1:A:315:TYR:HE1	4:A:403:QKQ:C1	1.44	1.28
1:A:315:TYR:CE1	4:A:403:QKQ:C1	2.21	1.21
1:A:216:PHE:CZ	4:A:403:QKQ:C16	2.34	1.10
1:L:6:LYS:HE2	1:L:371:GLN:OXT	1.51	1.09

Continued on next page...

Continued from previous page...

Atom-1	Atom-2	Interatomic distance (Å)	Clash overlap (Å)
1:J:109:HIS:CD2	1:K:208:HIS:HB3	1.97	0.99

There are no symmetry-related clashes.

5.3 Torsion angles [i](#)

5.3.1 Protein backbone [i](#)

In the following table, the Percentiles column shows the percent Ramachandran outliers of the chain as a percentile score with respect to all X-ray entries followed by that with respect to entries of similar resolution.

The Analysed column shows the number of residues for which the backbone conformation was analysed, and the total number of residues.

Mol	Chain	Analysed	Favoured	Allowed	Outliers	Percentiles	
1	A	356/391 (91%)	336 (94%)	19 (5%)	1 (0%)	41	37
1	B	353/391 (90%)	333 (94%)	19 (5%)	1 (0%)	41	37
1	C	353/391 (90%)	334 (95%)	16 (4%)	3 (1%)	19	13
1	D	356/391 (91%)	335 (94%)	18 (5%)	3 (1%)	19	13
1	E	356/391 (91%)	337 (95%)	19 (5%)	0	100	100
1	F	355/391 (91%)	336 (95%)	19 (5%)	0	100	100
1	G	359/391 (92%)	345 (96%)	13 (4%)	1 (0%)	41	37
1	H	354/391 (90%)	337 (95%)	17 (5%)	0	100	100
1	I	354/391 (90%)	339 (96%)	15 (4%)	0	100	100
1	J	352/391 (90%)	335 (95%)	17 (5%)	0	100	100
1	K	355/391 (91%)	335 (94%)	18 (5%)	2 (1%)	25	19
1	L	354/391 (90%)	334 (94%)	20 (6%)	0	100	100
All	All	4257/4692 (91%)	4036 (95%)	210 (5%)	11 (0%)	41	37

5 of 11 Ramachandran outliers are listed below:

Mol	Chain	Res	Type
1	A	241	ARG
1	B	135	ASN
1	D	341	GLY
1	K	341	GLY

Continued on next page...

Continued from previous page...

Mol	Chain	Res	Type
1	C	133	LYS

5.3.2 Protein sidechains [i](#)

In the following table, the Percentiles column shows the percent sidechain outliers of the chain as a percentile score with respect to all X-ray entries followed by that with respect to entries of similar resolution.

The Analysed column shows the number of residues for which the sidechain conformation was analysed, and the total number of residues.

Mol	Chain	Analysed	Rotameric	Outliers	Percentiles	
1	A	314/342 (92%)	306 (98%)	8 (2%)	47	49
1	B	311/342 (91%)	302 (97%)	9 (3%)	42	43
1	C	311/342 (91%)	302 (97%)	9 (3%)	42	43
1	D	314/342 (92%)	304 (97%)	10 (3%)	39	38
1	E	314/342 (92%)	303 (96%)	11 (4%)	36	35
1	F	313/342 (92%)	307 (98%)	6 (2%)	57	61
1	G	317/342 (93%)	310 (98%)	7 (2%)	52	55
1	H	312/342 (91%)	301 (96%)	11 (4%)	36	35
1	I	312/342 (91%)	300 (96%)	12 (4%)	33	31
1	J	310/342 (91%)	299 (96%)	11 (4%)	36	35
1	K	313/342 (92%)	304 (97%)	9 (3%)	42	43
1	L	312/342 (91%)	304 (97%)	8 (3%)	46	48
All	All	3753/4104 (91%)	3642 (97%)	111 (3%)	41	41

5 of 111 residues with a non-rotameric sidechain are listed below:

Mol	Chain	Res	Type
1	F	231	GLN
1	H	108	TYR
1	K	268	MET
1	F	268	MET
1	G	242	SER

Some sidechains can be flipped to improve hydrogen bonding and reduce clashes. 5 of 25 such sidechains are listed below:

Mol	Chain	Res	Type
1	G	306	GLN
1	I	306	GLN
1	L	231	GLN
1	H	157	ASN
1	J	221	GLN

5.3.3 RNA [i](#)

There are no RNA molecules in this entry.

5.4 Non-standard residues in protein, DNA, RNA chains [i](#)

There are no non-standard protein/DNA/RNA residues in this entry.

5.5 Carbohydrates [i](#)

There are no monosaccharides in this entry.

5.6 Ligand geometry [i](#)

Of 48 ligands modelled in this entry, 12 are monoatomic - leaving 36 for Mogul analysis.

In the following table, the Counts columns list the number of bonds (or angles) for which Mogul statistics could be retrieved, the number of bonds (or angles) that are observed in the model and the number of bonds (or angles) that are defined in the Chemical Component Dictionary. The Link column lists molecule types, if any, to which the group is linked. The Z score for a bond length (or angle) is the number of standard deviations the observed value is removed from the expected value. A bond length (or angle) with $|Z| > 2$ is considered an outlier worth inspection. RMSZ is the root-mean-square of all Z scores of the bond lengths (or angles).

Mol	Type	Chain	Res	Link	Bond lengths			Bond angles		
					Counts	RMSZ	# $ Z > 2$	Counts	RMSZ	# $ Z > 2$
4	QKQ	G	403	2	30,32,32	0.88	2 (6%)	40,43,43	0.97	2 (5%)
3	FES	K	402	1	0,4,4	0.00	-	-		
4	QKQ	A	403	2	30,32,32	1.01	1 (3%)	40,43,43	1.41	6 (15%)
3	FES	D	402	1	0,4,4	0.00	-	-		
4	QKQ	E	403	2	30,32,32	0.62	0	40,43,43	0.98	1 (2%)
5	EPE	A	404	-	15,15,15	1.00	1 (6%)	18,20,20	1.81	5 (27%)
3	FES	H	402	1	0,4,4	0.00	-	-		
5	EPE	B	404	-	15,15,15	1.17	1 (6%)	18,20,20	1.71	6 (33%)

Mol	Type	Chain	Res	Link	Bond lengths			Bond angles		
					Counts	RMSZ	# Z > 2	Counts	RMSZ	# Z > 2
5	EPE	E	404	-	15,15,15	1.21	1 (6%)	18,20,20	2.15	5 (27%)
4	QKQ	H	403	2	30,32,32	0.42	0	40,43,43	0.96	2 (5%)
4	QKQ	L	403	2	30,32,32	0.76	1 (3%)	40,43,43	1.09	4 (10%)
4	QKQ	C	403	2	30,32,32	0.63	0	40,43,43	0.96	3 (7%)
4	QKQ	D	403	2	30,32,32	0.49	0	40,43,43	0.84	2 (5%)
3	FES	G	402	1	0,4,4	0.00	-	-	-	-
3	FES	I	402	1	0,4,4	0.00	-	-	-	-
3	FES	B	402	1	0,4,4	0.00	-	-	-	-
3	FES	L	402	1	0,4,4	0.00	-	-	-	-
5	EPE	G	404	-	15,15,15	1.27	1 (6%)	18,20,20	2.02	5 (27%)
5	EPE	C	404	-	15,15,15	1.35	1 (6%)	18,20,20	1.81	4 (22%)
4	QKQ	K	403	2	30,32,32	0.74	1 (3%)	40,43,43	1.44	5 (12%)
4	QKQ	F	403	2	30,32,32	0.69	1 (3%)	40,43,43	1.45	3 (7%)
4	QKQ	I	403	2	30,32,32	0.58	0	40,43,43	1.29	3 (7%)
4	QKQ	B	403	2	30,32,32	0.67	1 (3%)	40,43,43	0.99	2 (5%)
5	EPE	L	404	-	15,15,15	1.05	1 (6%)	18,20,20	1.86	4 (22%)
3	FES	F	402	1	0,4,4	0.00	-	-	-	-
5	EPE	H	404	-	15,15,15	1.39	1 (6%)	18,20,20	2.06	4 (22%)
3	FES	J	402	1	0,4,4	0.00	-	-	-	-
3	FES	E	402	1	0,4,4	0.00	-	-	-	-
4	QKQ	J	403	2	30,32,32	0.67	1 (3%)	40,43,43	0.75	1 (2%)
3	FES	A	402	1	0,4,4	0.00	-	-	-	-
5	EPE	I	404	-	15,15,15	1.03	1 (6%)	18,20,20	1.81	6 (33%)
5	EPE	K	404	-	15,15,15	1.29	1 (6%)	18,20,20	1.63	3 (16%)
5	EPE	J	404	-	15,15,15	1.24	1 (6%)	18,20,20	1.81	5 (27%)
5	EPE	D	404	-	15,15,15	1.19	1 (6%)	18,20,20	1.56	4 (22%)
5	EPE	F	404	-	15,15,15	1.23	1 (6%)	18,20,20	2.16	6 (33%)
3	FES	C	402	1	0,4,4	0.00	-	-	-	-

In the following table, the Chirals column lists the number of chiral outliers, the number of chiral centers analysed, the number of these observed in the model and the number defined in the Chemical Component Dictionary. Similar counts are reported in the Torsion and Rings columns. '-' means no outliers of that kind were identified.

Mol	Type	Chain	Res	Link	Chirals	Torsions	Rings
3	FES	G	402	1	-	-	0/1/1/1
3	FES	K	402	1	-	-	0/1/1/1
4	QKQ	A	403	2	-	8/17/17/17	0/4/4/4

Continued on next page...

Continued from previous page...

Mol	Type	Chain	Res	Link	Chirals	Torsions	Rings
3	FES	D	402	1	-	-	0/1/1/1
3	FES	I	402	1	-	-	0/1/1/1
5	EPE	A	404	-	-	2/9/19/19	0/1/1/1
3	FES	H	402	1	-	-	0/1/1/1
5	EPE	B	404	-	-	2/9/19/19	0/1/1/1
5	EPE	E	404	-	-	3/9/19/19	0/1/1/1
4	QKQ	H	403	2	-	1/17/17/17	0/4/4/4
4	QKQ	L	403	2	-	0/17/17/17	0/4/4/4
4	QKQ	C	403	2	-	3/17/17/17	0/4/4/4
4	QKQ	D	403	2	-	4/17/17/17	0/4/4/4
4	QKQ	G	403	2	-	3/17/17/17	0/4/4/4
4	QKQ	E	403	2	-	5/17/17/17	0/4/4/4
3	FES	B	402	1	-	-	0/1/1/1
3	FES	L	402	1	-	-	0/1/1/1
5	EPE	G	404	-	-	3/9/19/19	0/1/1/1
5	EPE	C	404	-	-	1/9/19/19	0/1/1/1
4	QKQ	K	403	2	-	5/17/17/17	0/4/4/4
4	QKQ	F	403	2	-	3/17/17/17	0/4/4/4
4	QKQ	I	403	2	-	4/17/17/17	0/4/4/4
4	QKQ	B	403	2	-	5/17/17/17	0/4/4/4
5	EPE	L	404	-	-	2/9/19/19	0/1/1/1
3	FES	F	402	1	-	-	0/1/1/1
5	EPE	H	404	-	-	1/9/19/19	0/1/1/1
3	FES	J	402	1	-	-	0/1/1/1
3	FES	E	402	1	-	-	0/1/1/1
4	QKQ	J	403	2	-	0/17/17/17	0/4/4/4
3	FES	A	402	1	-	-	0/1/1/1
5	EPE	I	404	-	-	2/9/19/19	0/1/1/1
5	EPE	K	404	-	-	3/9/19/19	0/1/1/1
5	EPE	J	404	-	-	2/9/19/19	0/1/1/1
5	EPE	D	404	-	-	2/9/19/19	0/1/1/1
5	EPE	F	404	-	-	2/9/19/19	0/1/1/1
3	FES	C	402	1	-	-	0/1/1/1

The worst 5 of 20 bond length outliers are listed below:

Mol	Chain	Res	Type	Atoms	Z	Observed(Å)	Ideal(Å)
5	H	404	EPE	C10-S	5.06	1.84	1.77

Continued on next page...

Continued from previous page...

Mol	Chain	Res	Type	Atoms	Z	Observed(Å)	Ideal(Å)
5	C	404	EPE	C10-S	4.79	1.84	1.77
5	K	404	EPE	C10-S	4.66	1.84	1.77
5	F	404	EPE	C10-S	4.43	1.83	1.77
5	G	404	EPE	C10-S	4.42	1.83	1.77

The worst 5 of 91 bond angle outliers are listed below:

Mol	Chain	Res	Type	Atoms	Z	Observed(°)	Ideal(°)
5	H	404	EPE	O2S-S-C10	6.67	114.95	106.92
5	E	404	EPE	O1S-S-C10	6.51	114.75	106.92
5	G	404	EPE	O1S-S-C10	6.02	114.17	106.92
4	F	403	QKQ	C5-C6-C20	-5.45	114.92	122.20
5	F	404	EPE	O2S-S-C10	5.29	113.28	106.92

There are no chirality outliers.

5 of 66 torsion outliers are listed below:

Mol	Chain	Res	Type	Atoms
4	G	403	QKQ	C14-C15-C16-N3
5	B	404	EPE	S-C10-C9-N1
5	E	404	EPE	S-C10-C9-N1
4	D	403	QKQ	C14-C15-C16-N3
4	A	403	QKQ	C12-C13-N2-C14

There are no ring outliers.

20 monomers are involved in 101 short contacts:

Mol	Chain	Res	Type	Clashes	Symm-Clashes
4	G	403	QKQ	6	0
4	A	403	QKQ	15	0
4	E	403	QKQ	7	0
5	B	404	EPE	1	0
5	E	404	EPE	1	0
4	H	403	QKQ	3	0
4	L	403	QKQ	5	0
4	C	403	QKQ	6	0
4	D	403	QKQ	6	0
3	L	402	FES	2	0
5	G	404	EPE	1	0
4	K	403	QKQ	16	0
4	F	403	QKQ	8	0

Continued on next page...

Continued from previous page...

Mol	Chain	Res	Type	Clashes	Symm-Clashes
4	I	403	QKQ	2	0
4	B	403	QKQ	13	0
5	L	404	EPE	2	0
4	J	403	QKQ	3	0
3	A	402	FES	1	0
5	I	404	EPE	1	0
5	F	404	EPE	2	0

The following is a two-dimensional graphical depiction of Mogul quality analysis of bond lengths, bond angles, torsion angles, and ring geometry for all instances of the Ligand of Interest. In addition, ligands with molecular weight > 250 and outliers as shown on the validation Tables will also be included. For torsion angles, if less than 5% of the Mogul distribution of torsion angles is within 10 degrees of the torsion angle in question, then that torsion angle is considered an outlier. Any bond that is central to one or more torsion angles identified as an outlier by Mogul will be highlighted in the graph. For rings, the root-mean-square deviation (RMSD) between the ring in question and similar rings identified by Mogul is calculated over all ring torsion angles. If the average RMSD is greater than 60 degrees and the minimal RMSD between the ring in question and any Mogul-identified rings is also greater than 60 degrees, then that ring is considered an outlier. The outliers are highlighted in purple. The color gray indicates Mogul did not find sufficient equivalents in the CSD to analyse the geometry.

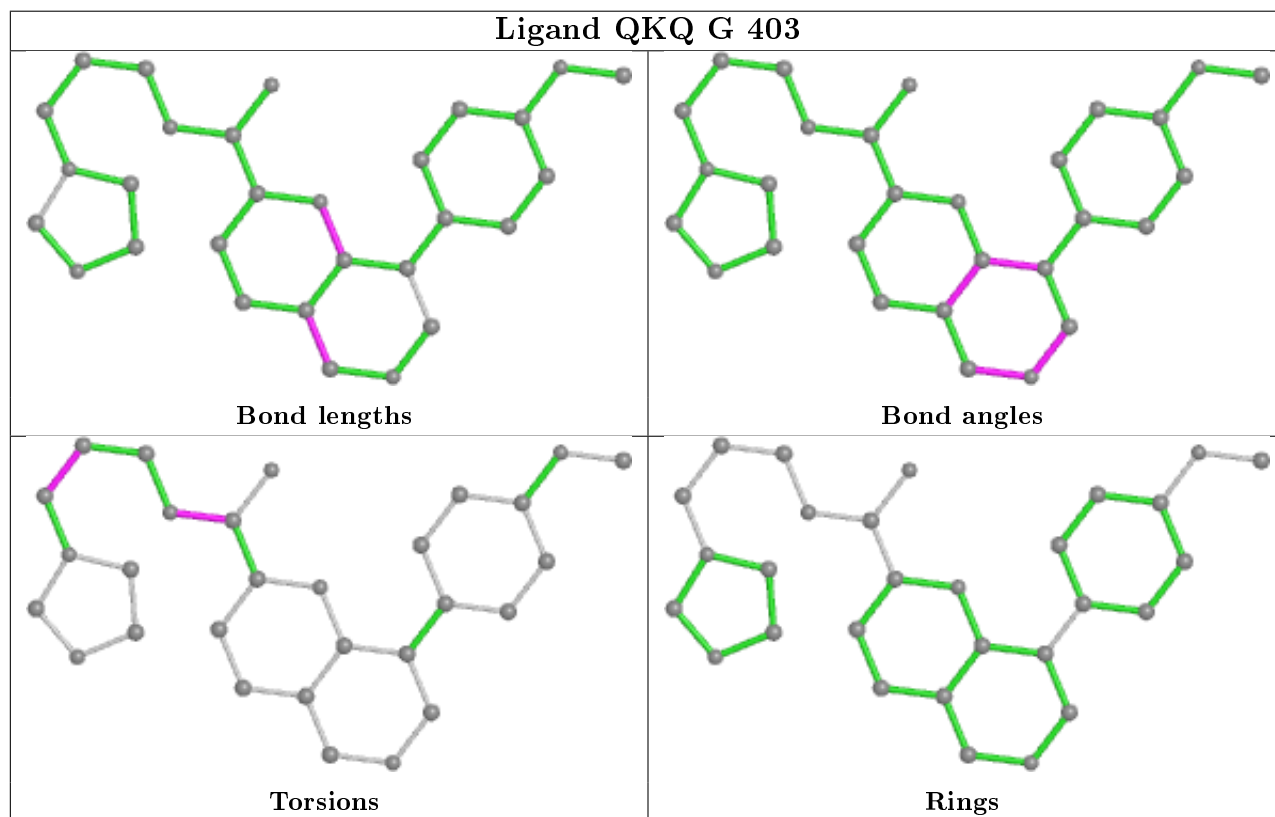

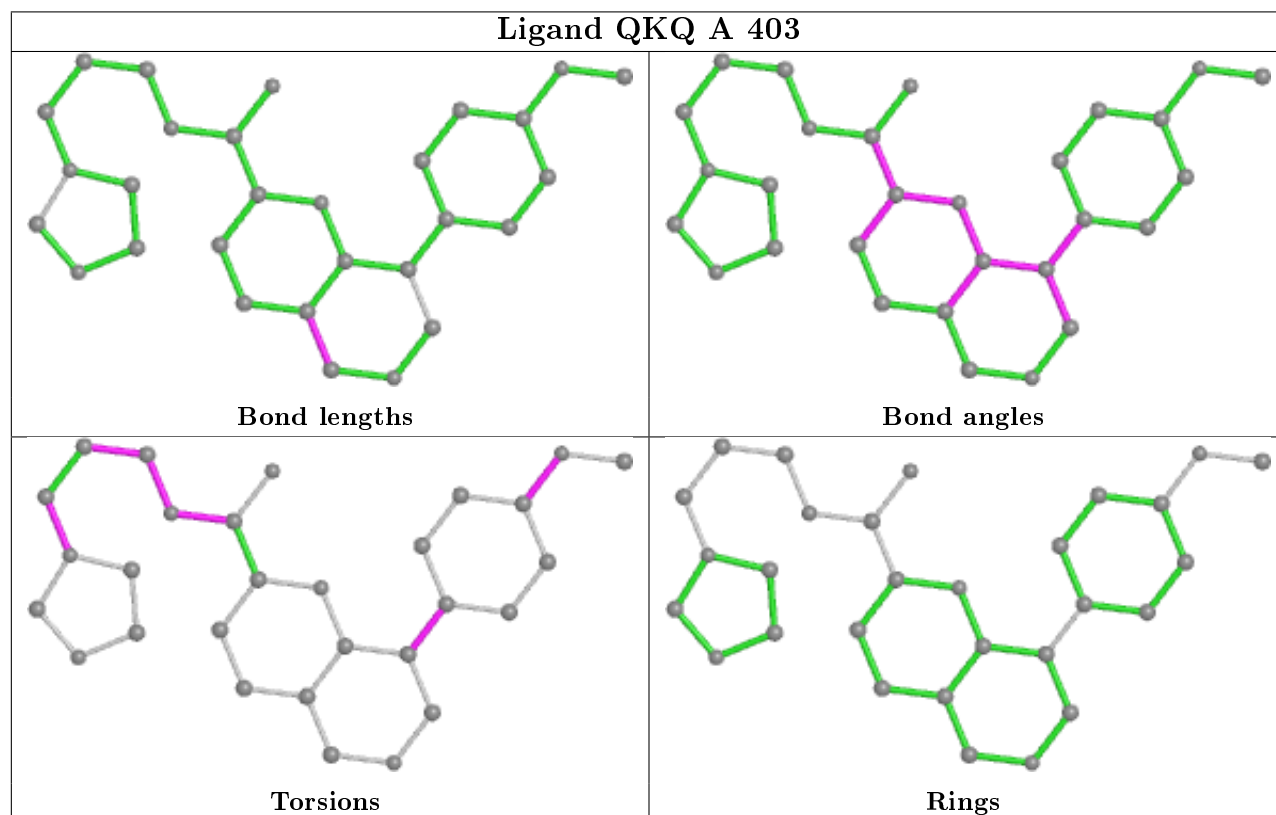
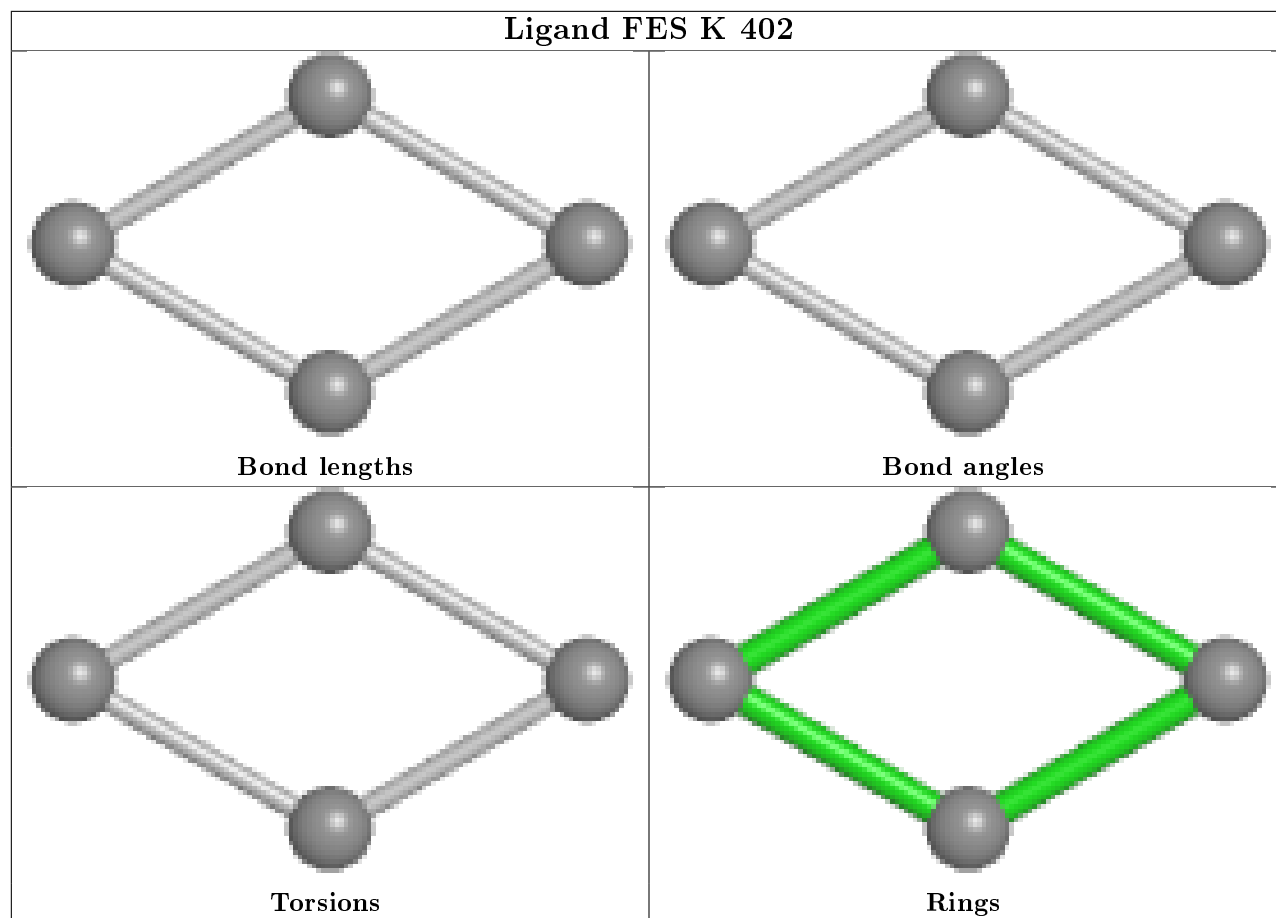

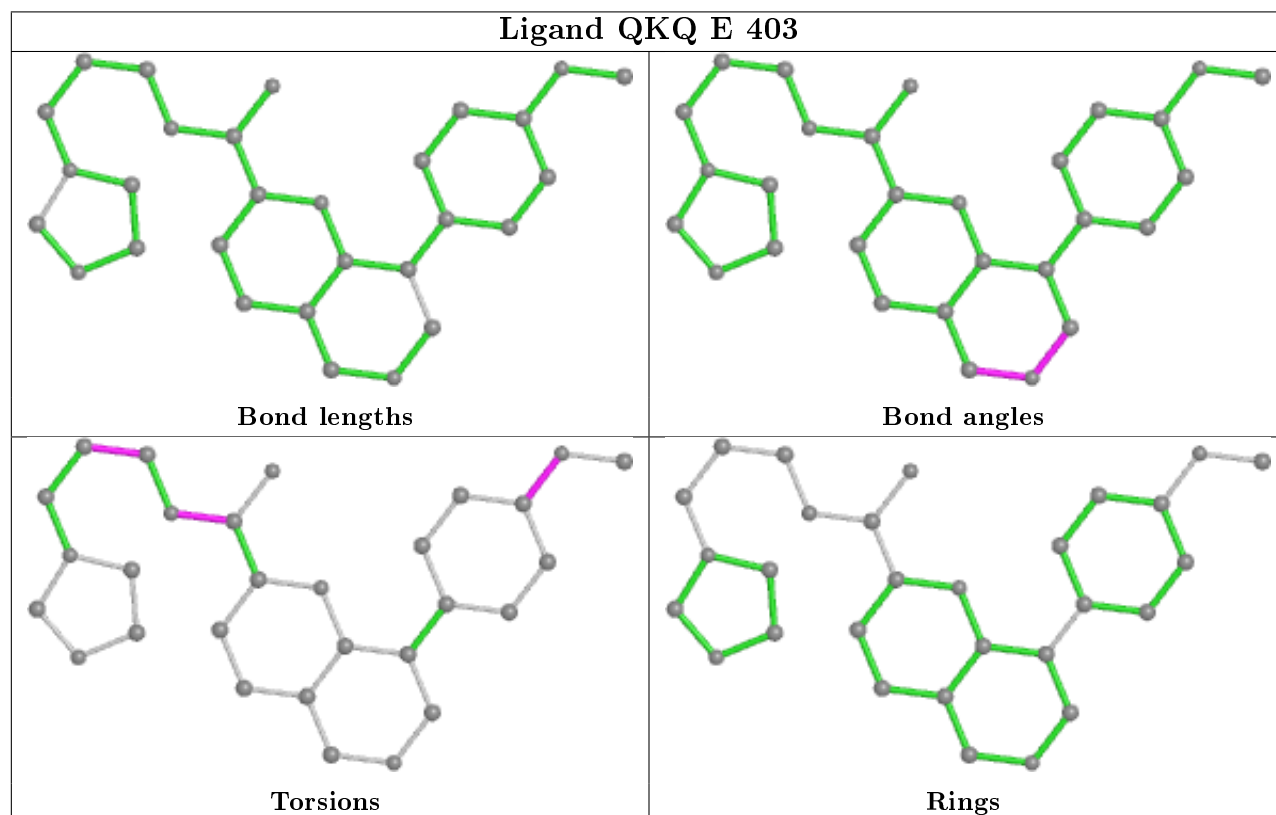
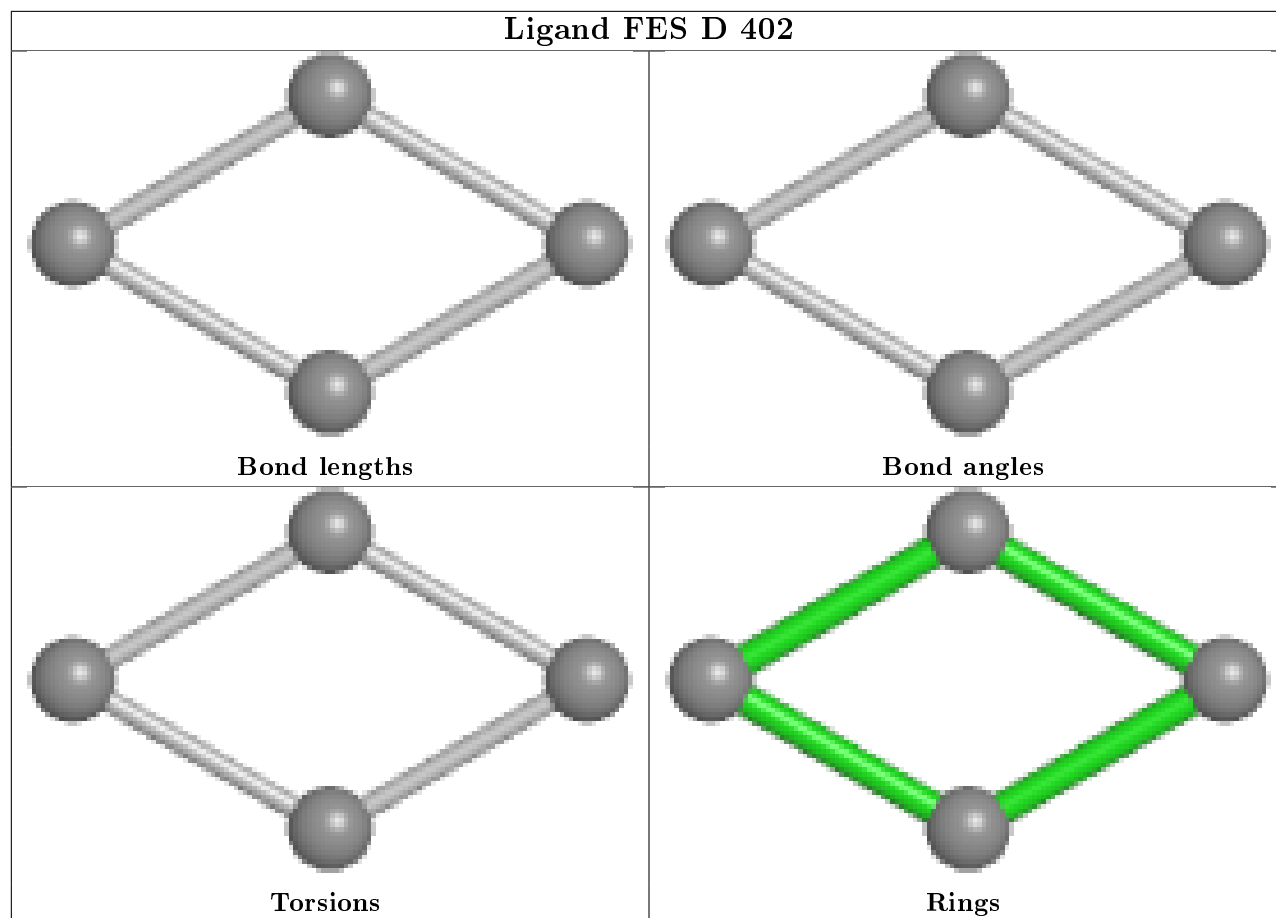

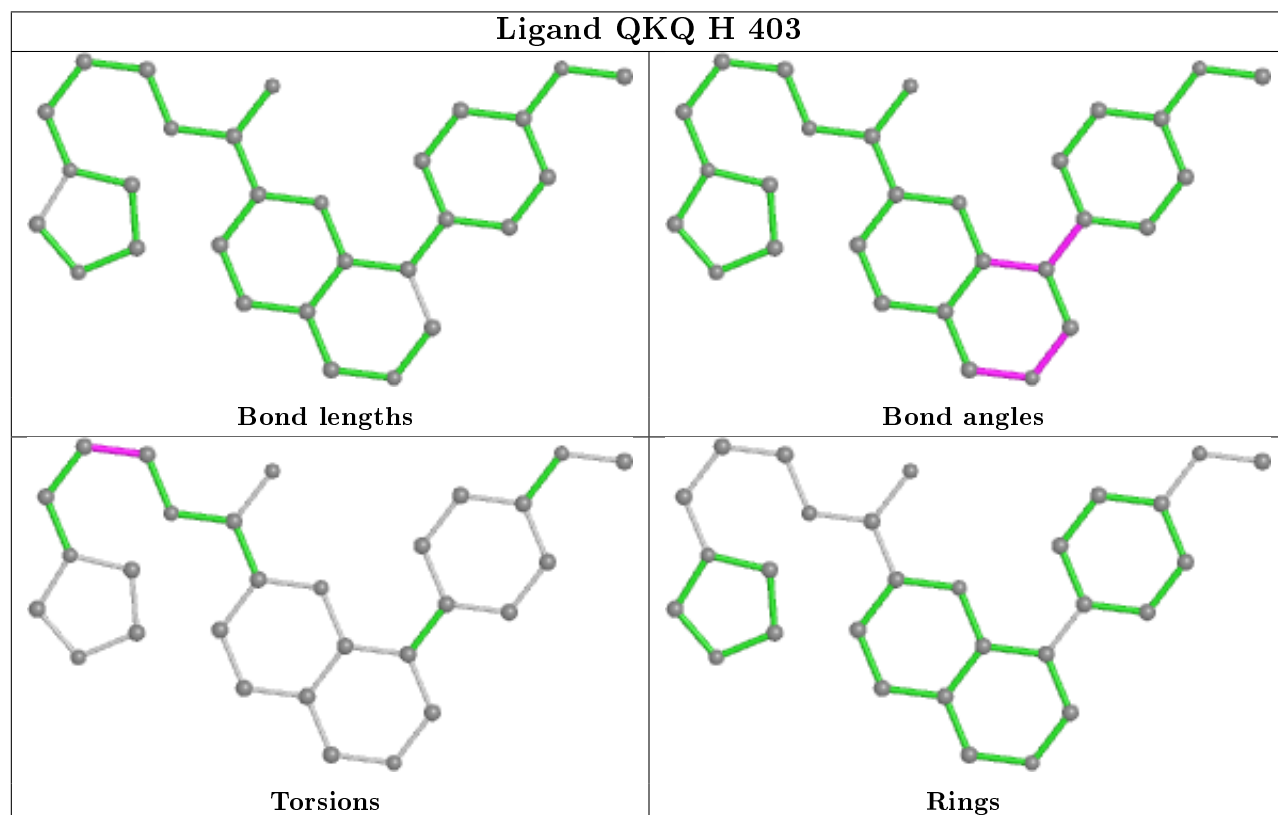
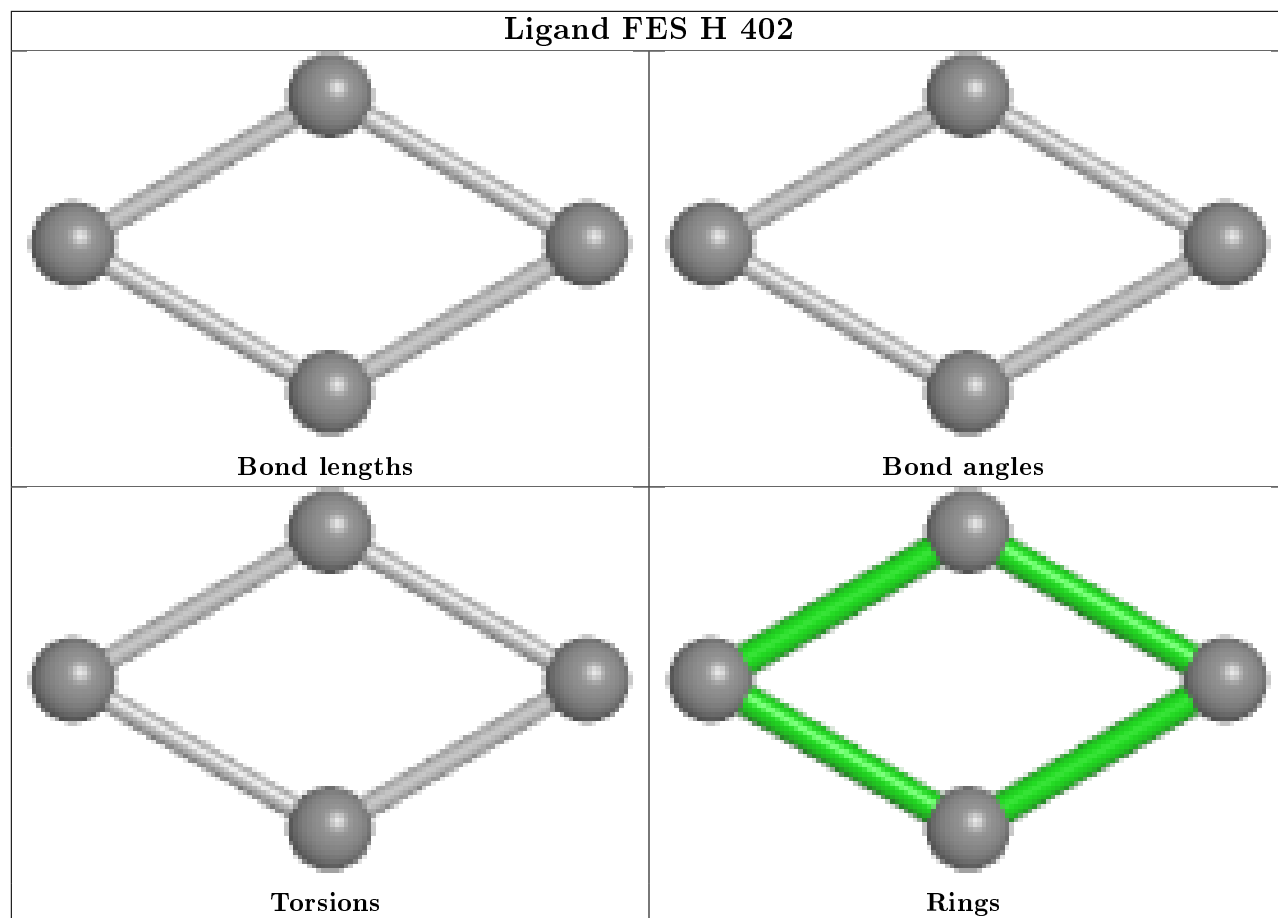

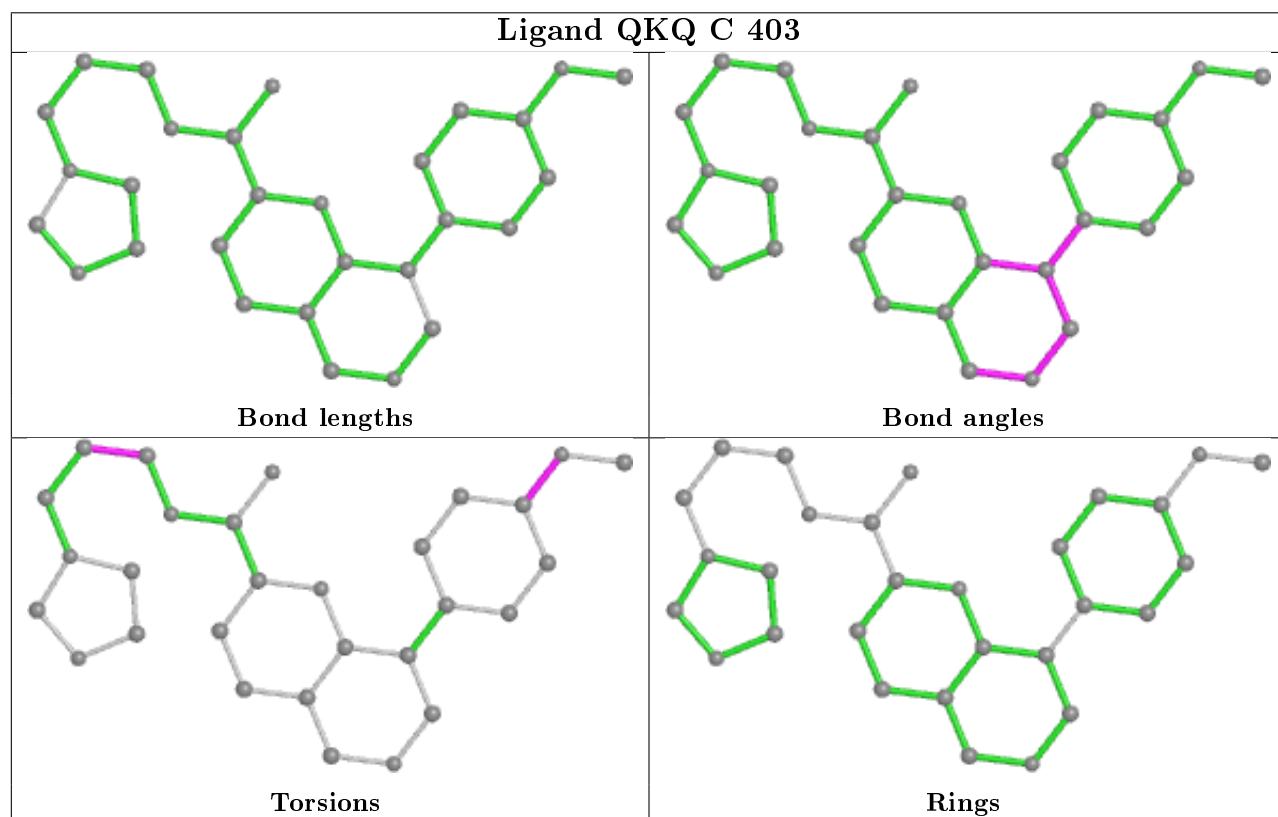
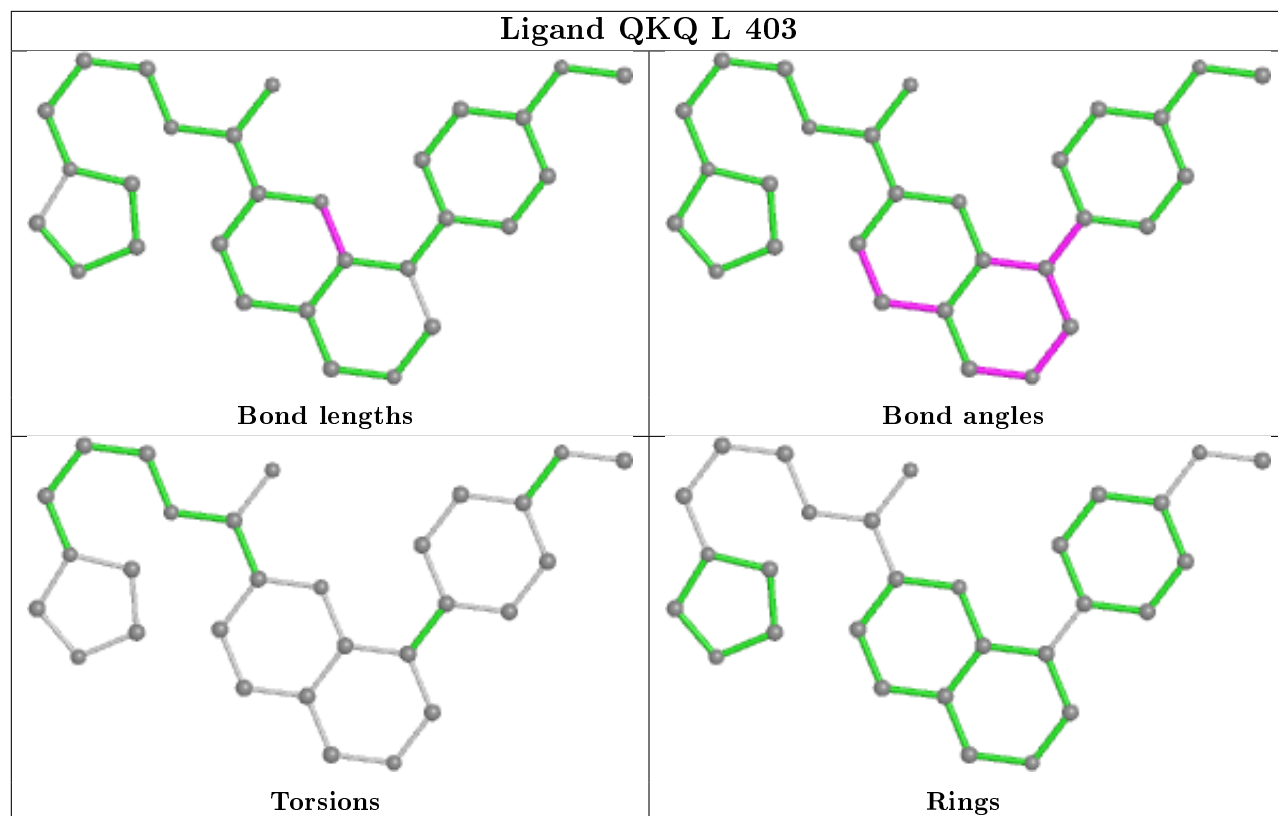

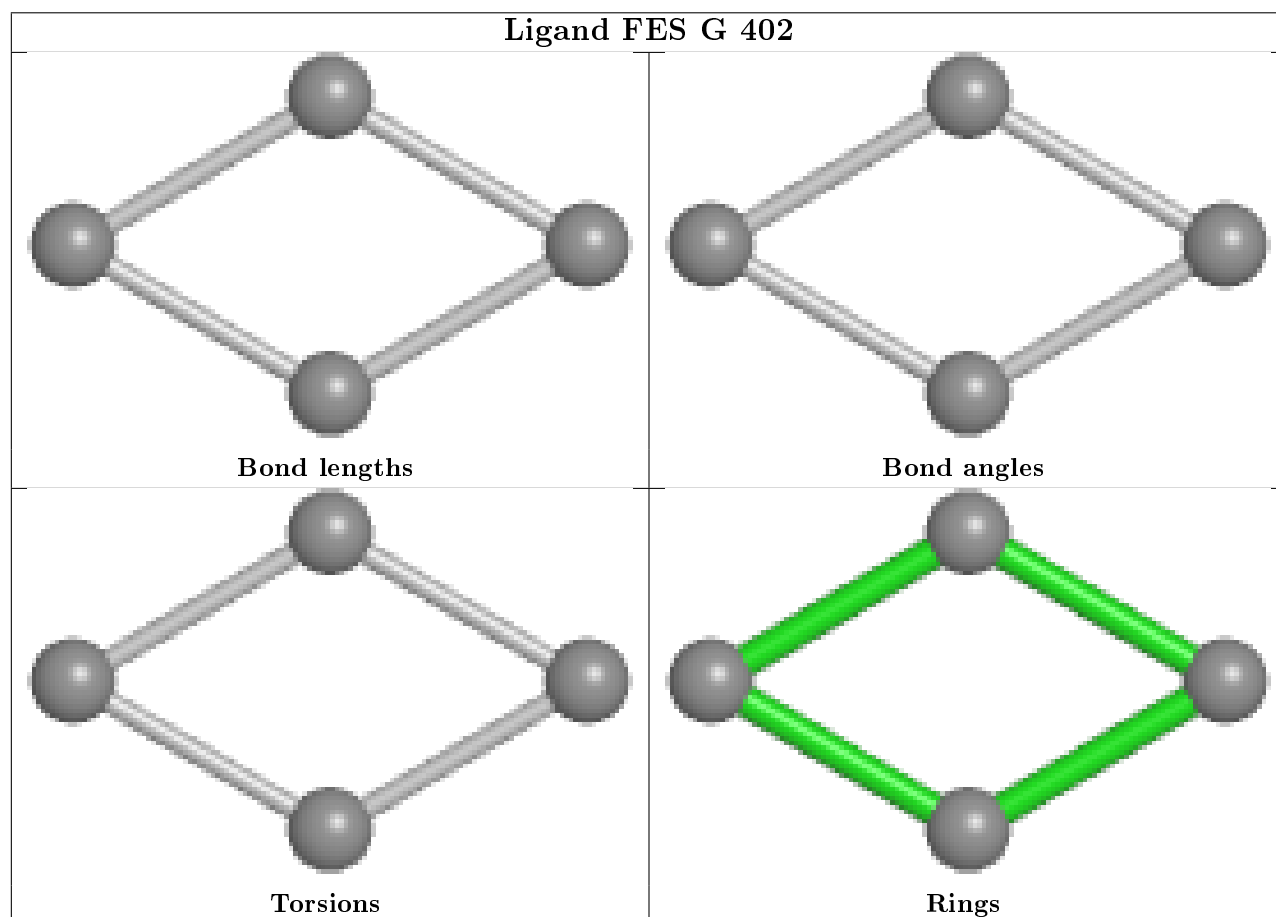
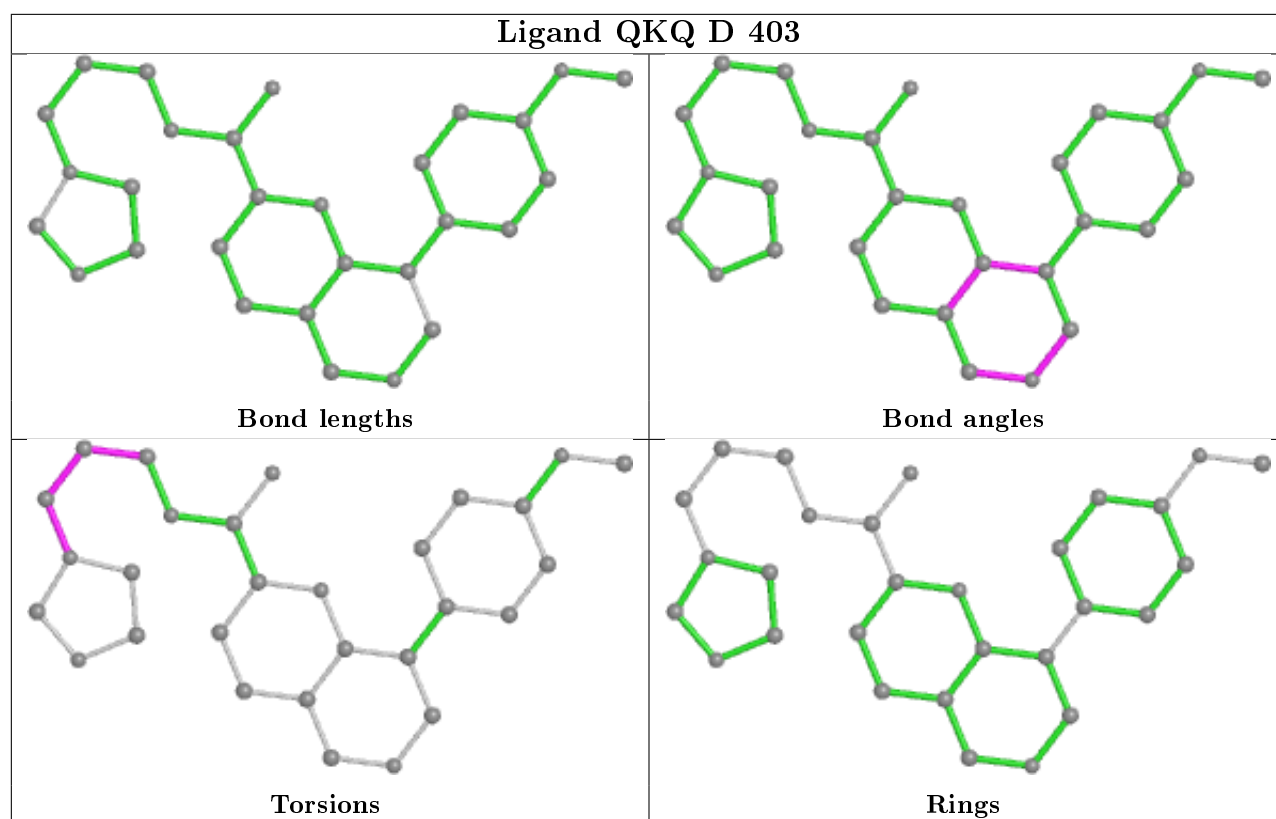

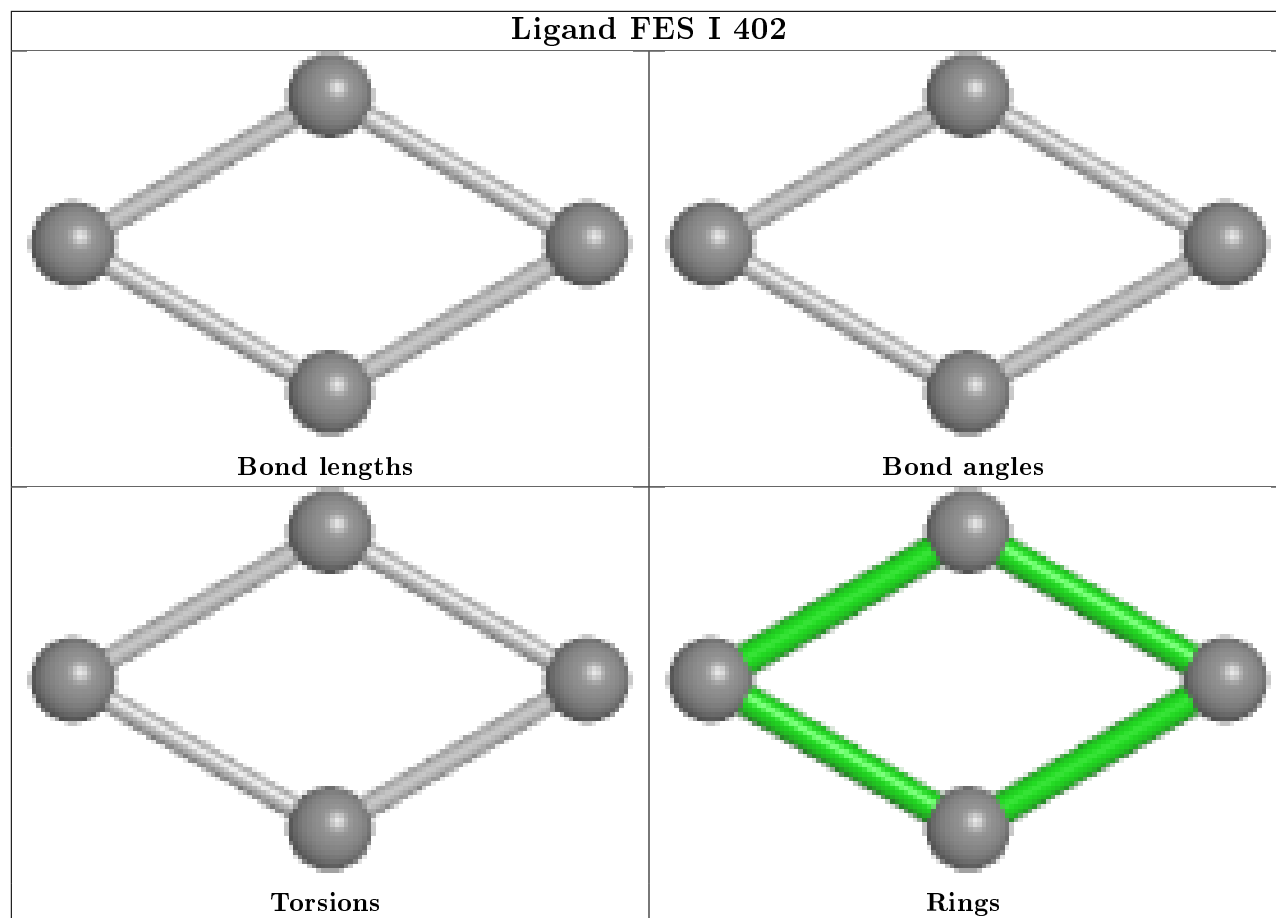

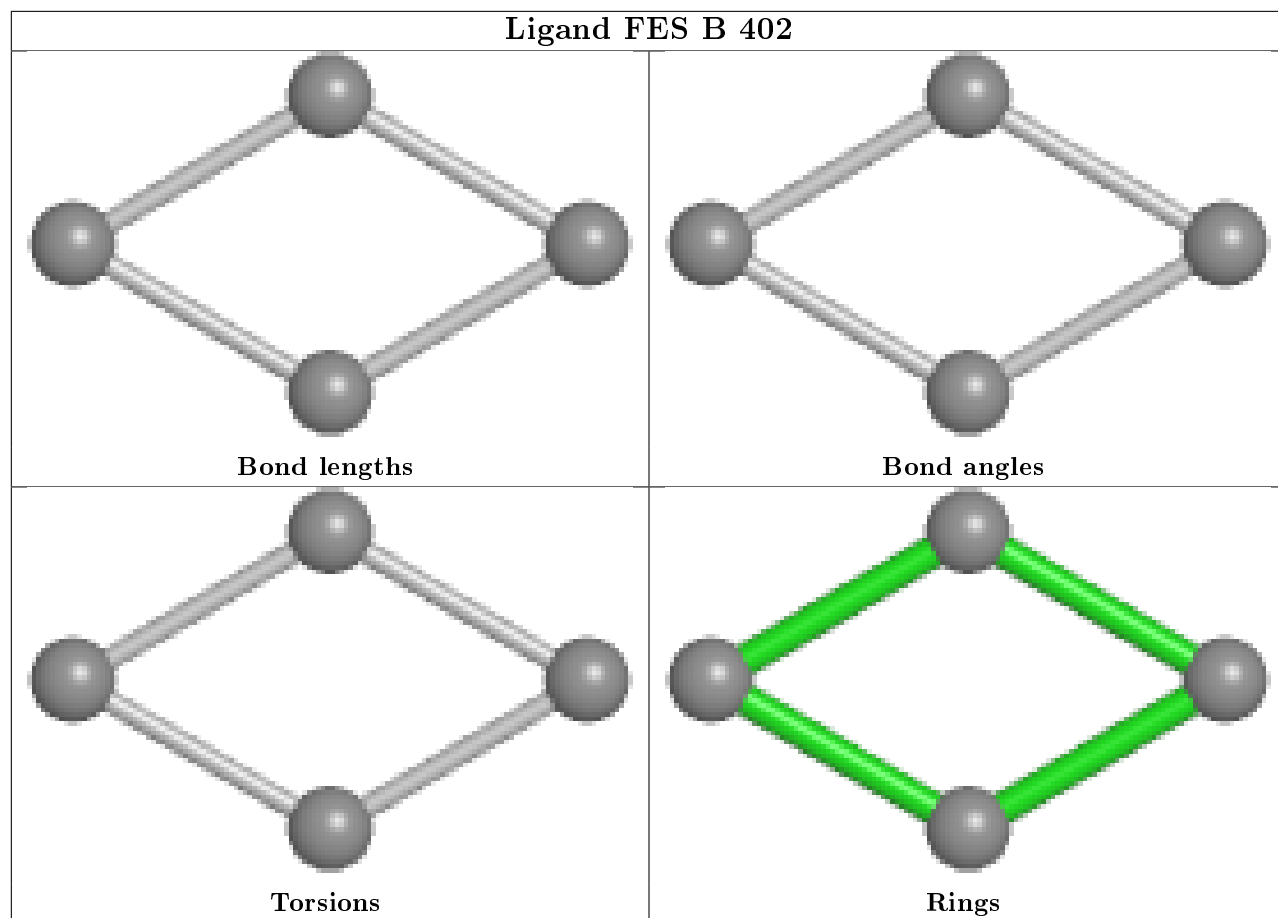

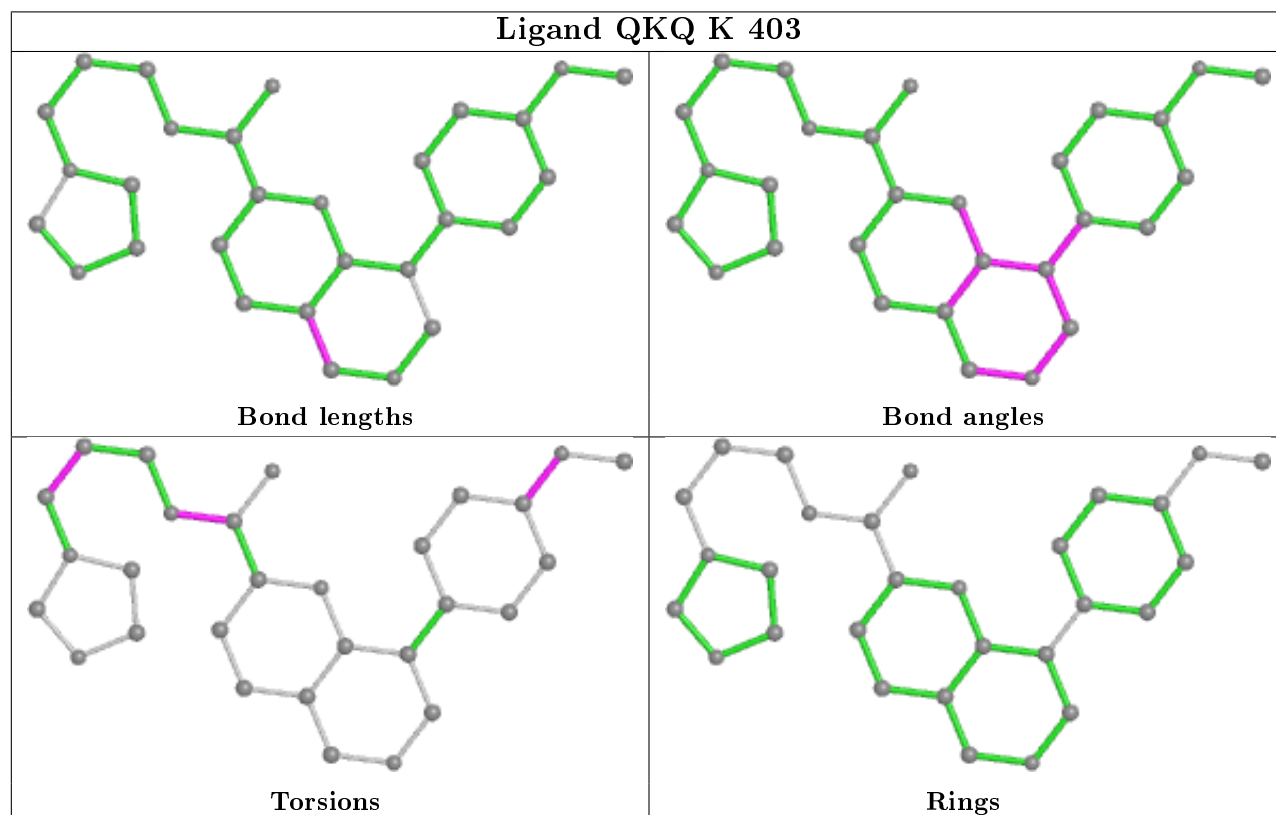
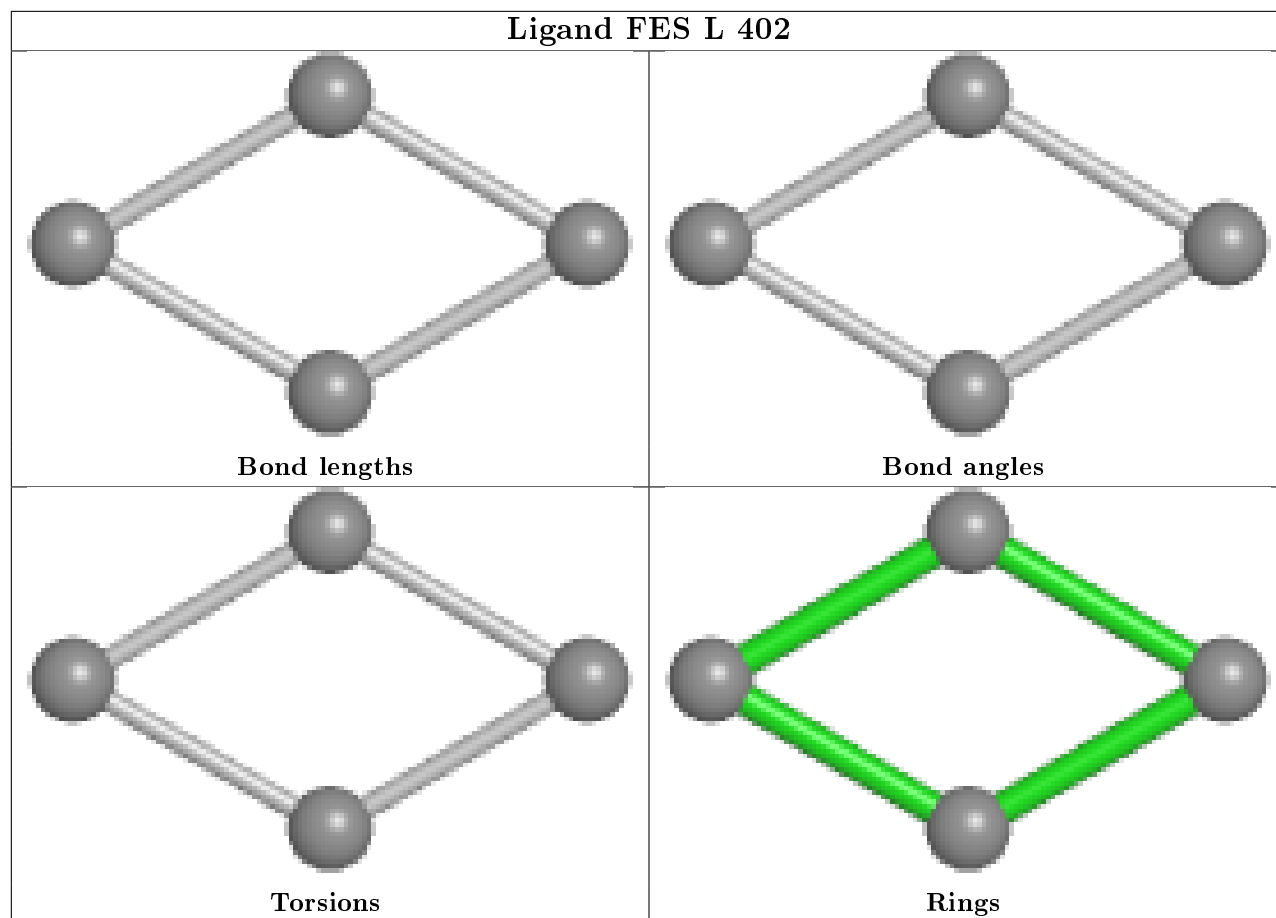

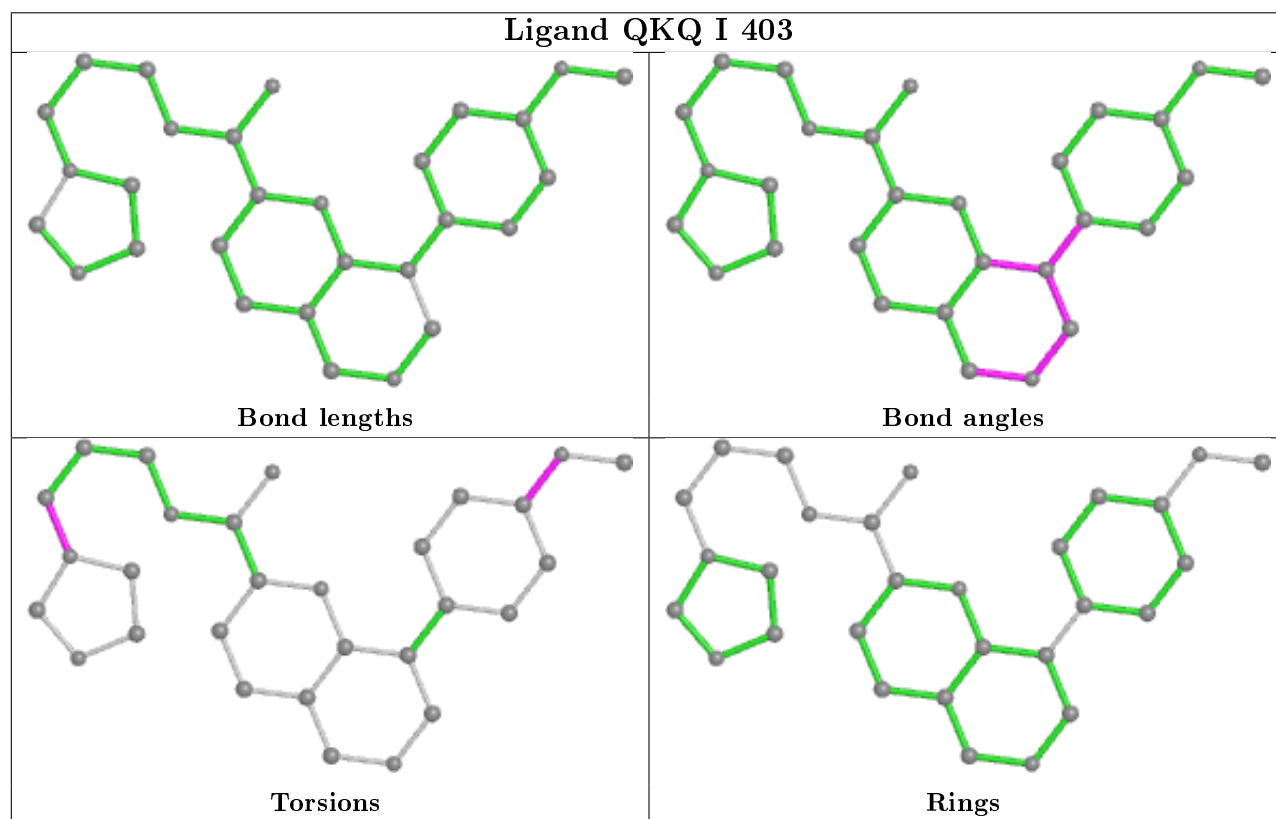
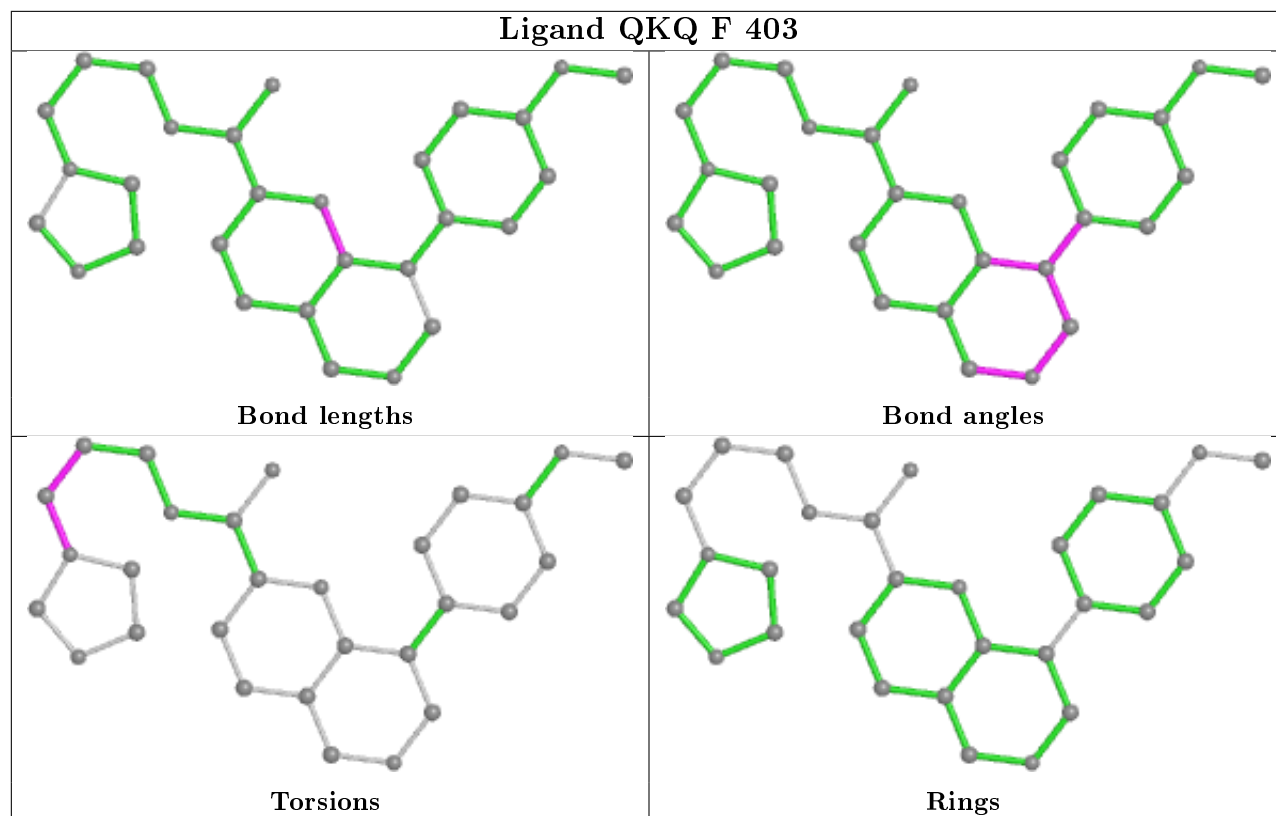

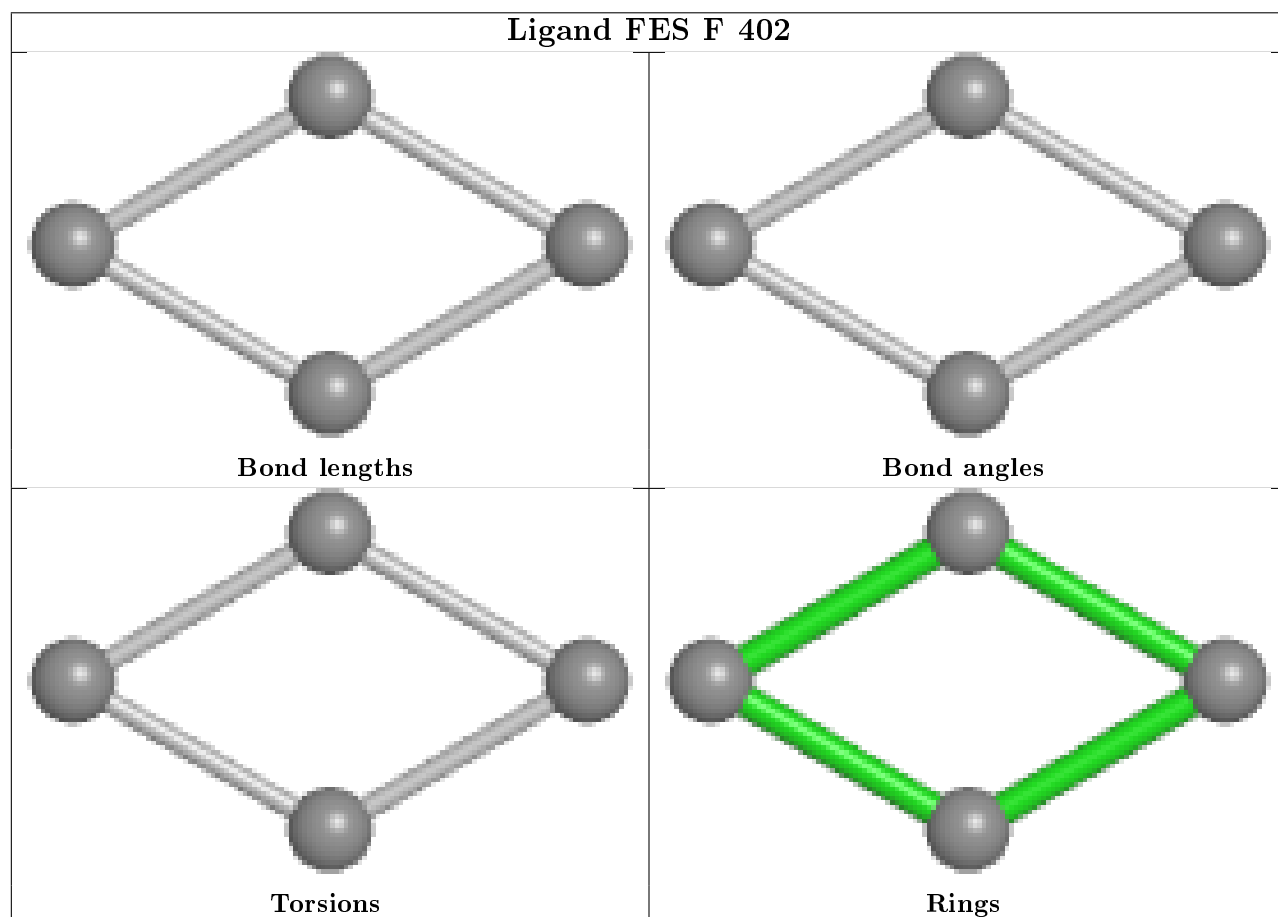
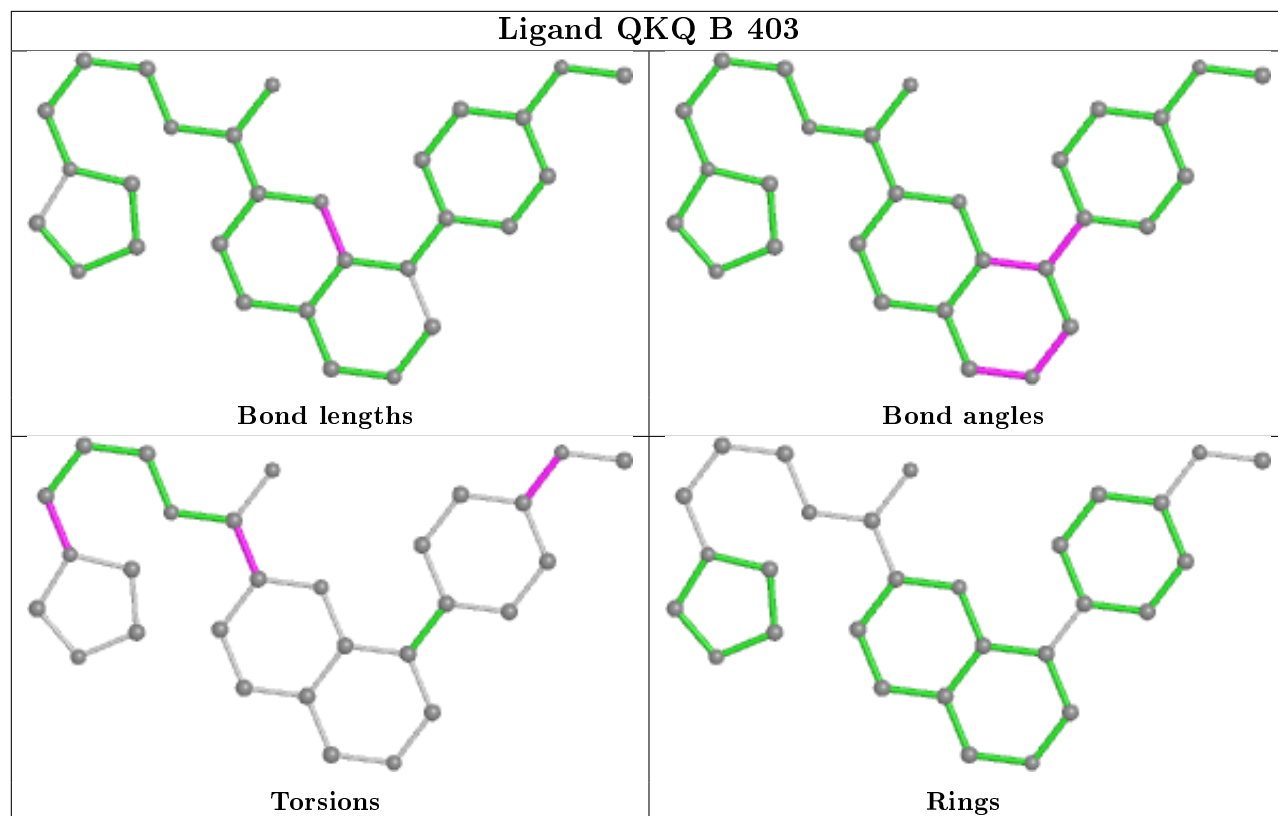

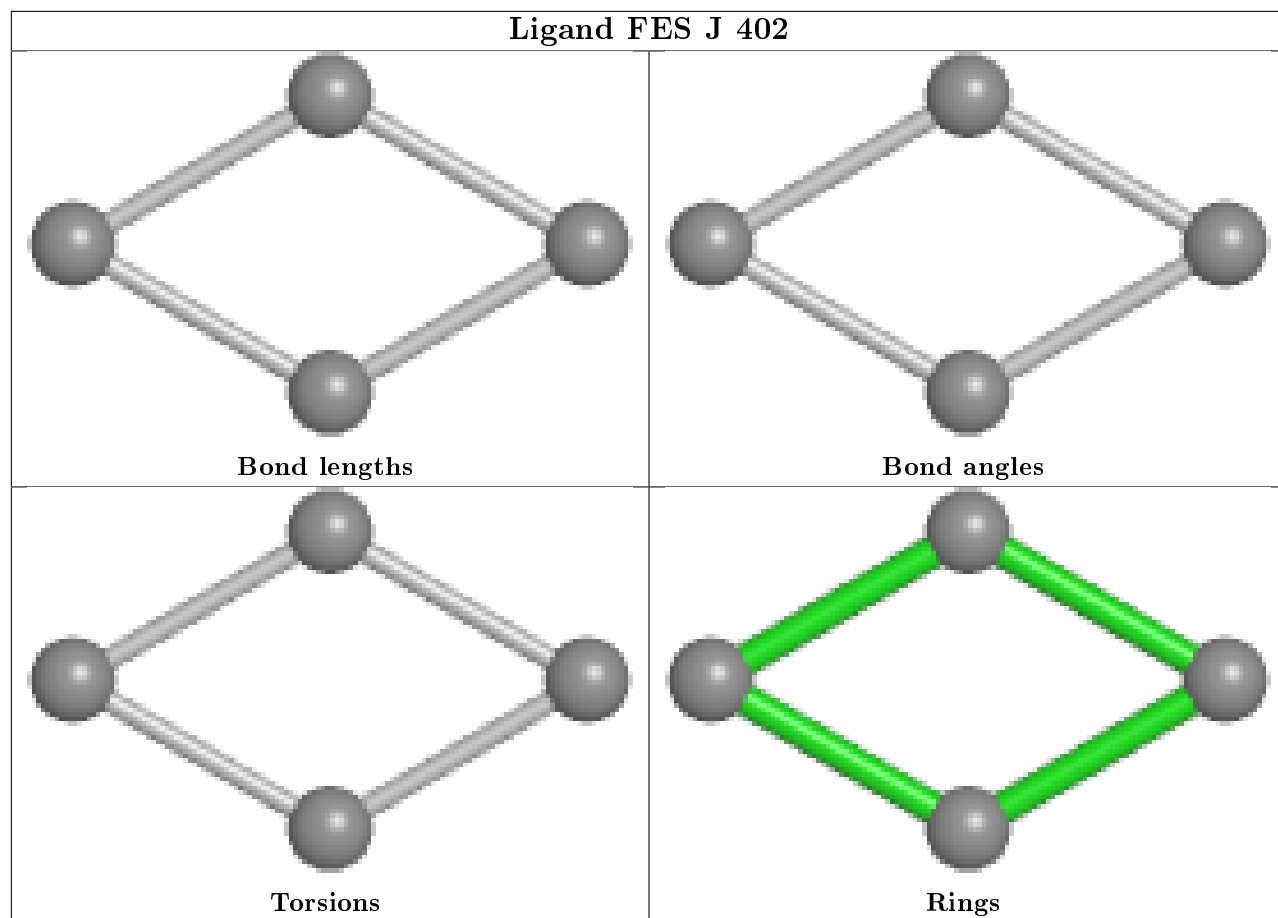

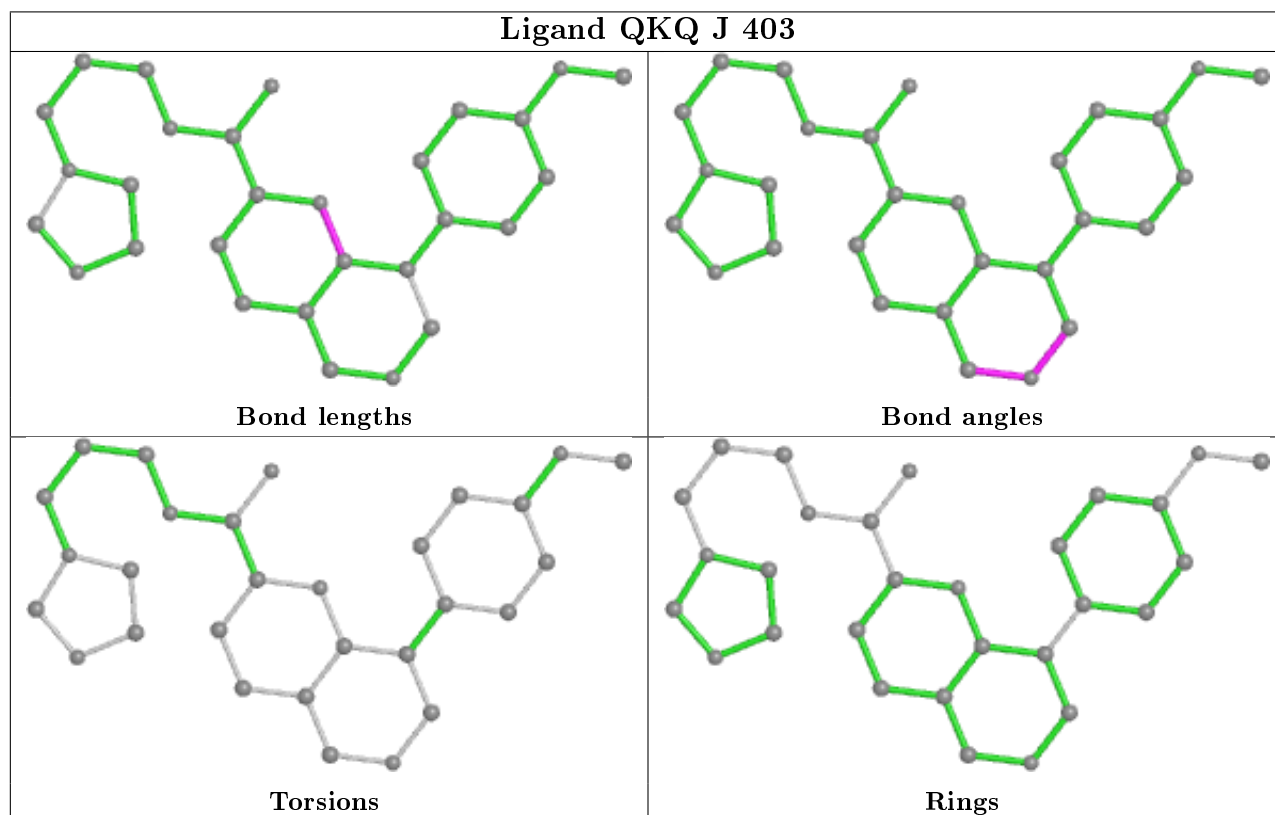
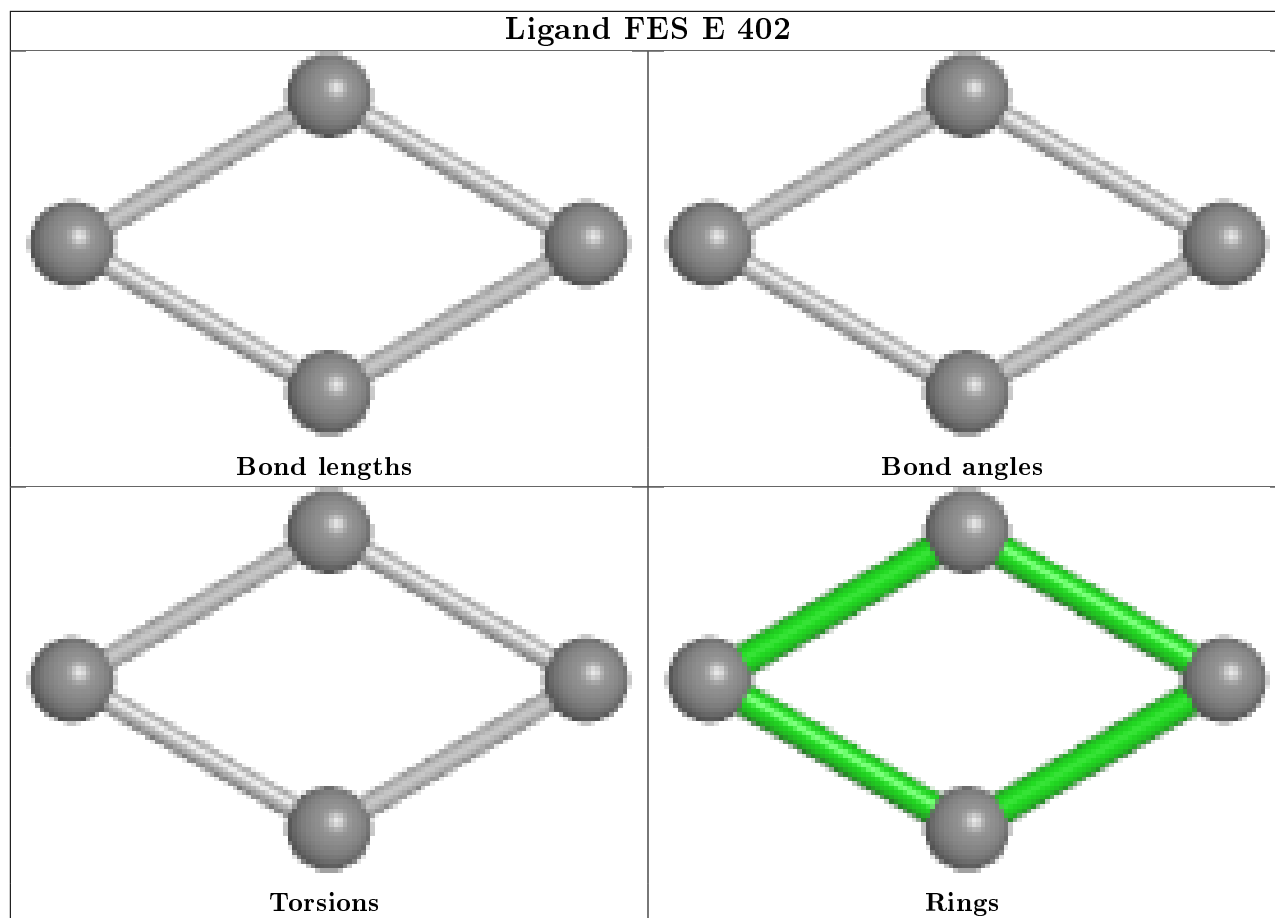

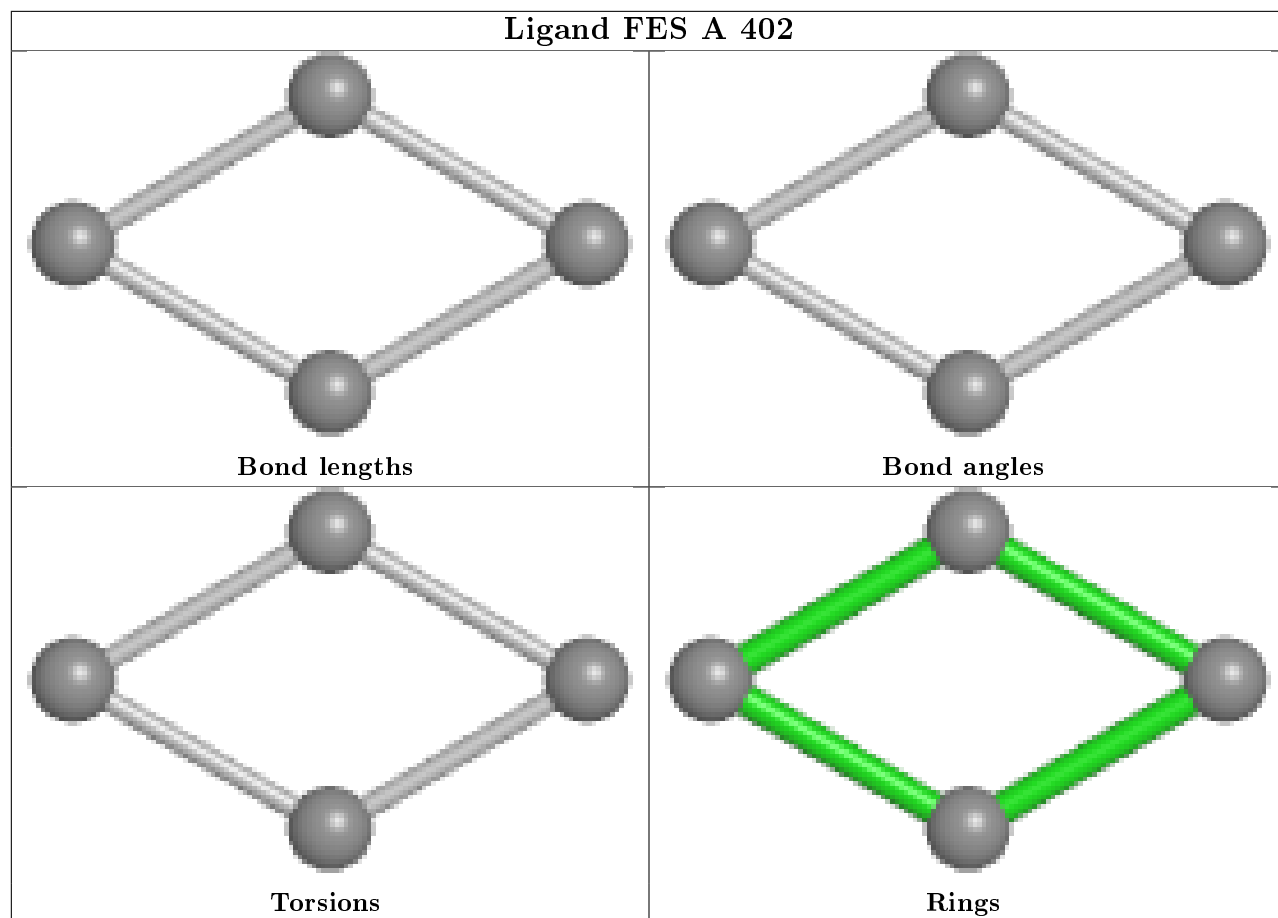

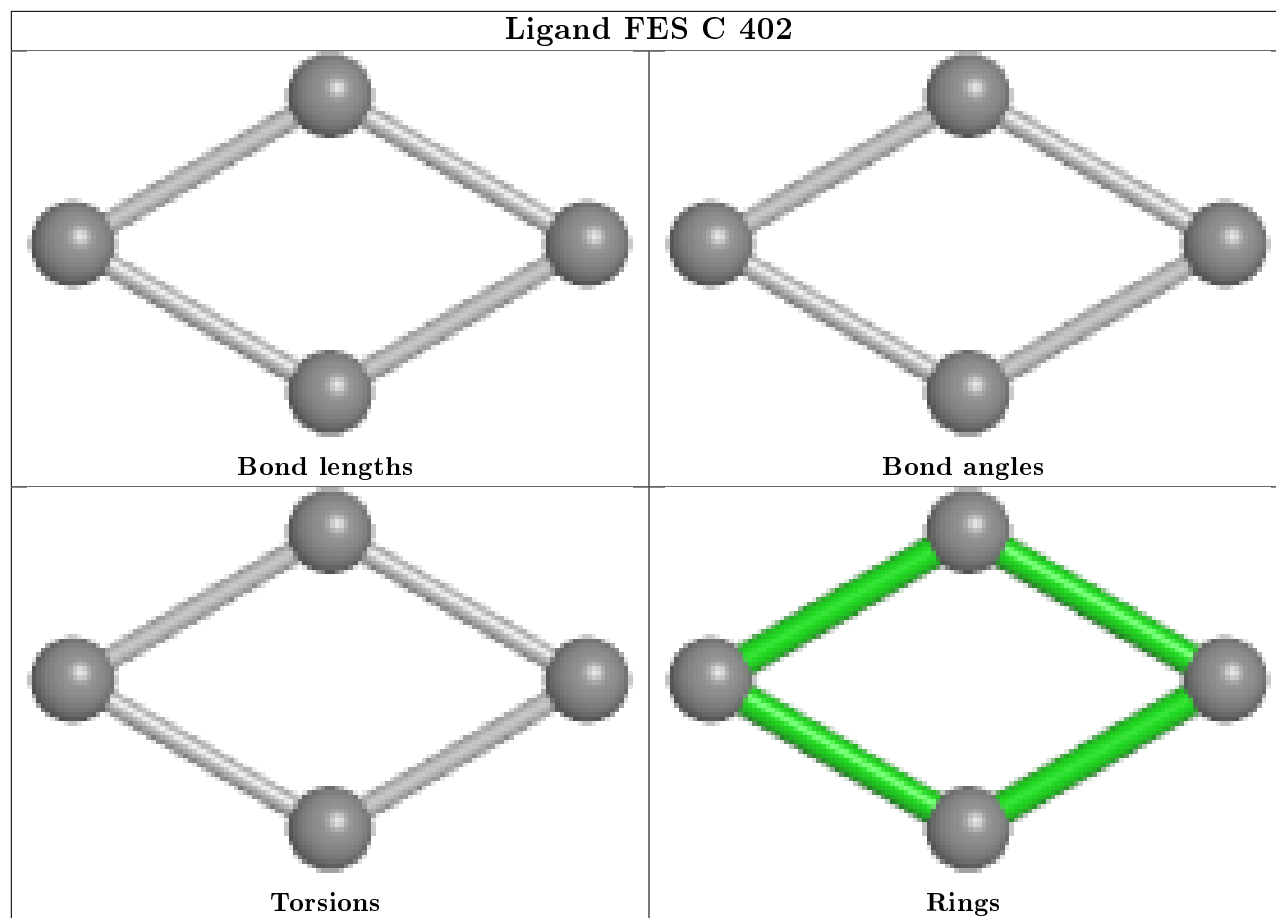

5.7 Other polymers [i](#)

There are no such residues in this entry.

5.8 Polymer linkage issues [i](#)

There are no chain breaks in this entry.

6 Fit of model and data [i](#)

6.1 Protein, DNA and RNA chains [i](#)

In the following table, the column labelled ‘#RSRZ> 2’ contains the number (and percentage) of RSRZ outliers, followed by percent RSRZ outliers for the chain as percentile scores relative to all X-ray entries and entries of similar resolution. The OWAB column contains the minimum, median, 95th percentile and maximum values of the occupancy-weighted average B-factor per residue. The column labelled ‘Q< 0.9’ lists the number of (and percentage) of residues with an average occupancy less than 0.9.

Mol	Chain	Analysed	<RSRZ>	#RSRZ>2	OWAB(Å ²)	Q<0.9
1	A	360/391 (92%)	0.71	30 (8%) 11 10	29, 52, 103, 176	0
1	B	357/391 (91%)	0.58	29 (8%) 12 11	29, 48, 93, 153	0
1	C	357/391 (91%)	0.61	22 (6%) 20 19	34, 52, 94, 150	0
1	D	360/391 (92%)	0.51	22 (6%) 21 20	27, 45, 99, 154	0
1	E	360/391 (92%)	0.48	21 (5%) 23 22	31, 46, 102, 158	0
1	F	359/391 (91%)	0.46	16 (4%) 33 32	25, 39, 83, 138	0
1	G	363/391 (92%)	0.45	20 (5%) 25 24	24, 39, 81, 156	0
1	H	358/391 (91%)	0.42	17 (4%) 31 30	24, 39, 88, 142	0
1	I	358/391 (91%)	0.55	28 (7%) 13 12	23, 41, 85, 156	0
1	J	356/391 (91%)	0.51	27 (7%) 13 13	25, 42, 84, 130	0
1	K	359/391 (91%)	0.86	43 (11%) 4 3	31, 55, 108, 164	0
1	L	358/391 (91%)	0.52	29 (8%) 12 11	29, 45, 90, 150	0
All	All	4305/4692 (91%)	0.56	304 (7%) 16 15	23, 45, 95, 176	0

The worst 5 of 304 RSRZ outliers are listed below:

Mol	Chain	Res	Type	RSRZ
1	D	253	VAL	16.9
1	A	253	VAL	15.1
1	E	254	THR	12.5
1	A	215	GLY	11.1
1	C	242	SER	10.9

6.2 Non-standard residues in protein, DNA, RNA chains [i](#)

There are no non-standard protein/DNA/RNA residues in this entry.

6.3 Carbohydrates [i](#)

There are no monosaccharides in this entry.

6.4 Ligands [i](#)

In the following table, the Atoms column lists the number of modelled atoms in the group and the number defined in the chemical component dictionary. The B-factors column lists the minimum, median, 95th percentile and maximum values of B factors of atoms in the group. The column labelled 'Q< 0.9' lists the number of atoms with occupancy less than 0.9.

Mol	Type	Chain	Res	Atoms	RSCC	RSR	B-factors(Å ²)	Q<0.9
4	QKQ	A	403	29/29	0.55	0.41	70,78,91,91	0
4	QKQ	I	403	29/29	0.56	0.47	56,69,83,85	0
4	QKQ	D	403	29/29	0.57	0.39	64,70,87,88	0
4	QKQ	B	403	29/29	0.57	0.39	68,71,87,88	0
4	QKQ	L	403	29/29	0.62	0.50	60,67,83,84	0
5	EPE	G	404	15/15	0.63	0.39	43,59,76,79	0
4	QKQ	F	403	29/29	0.64	0.37	57,64,84,86	0
4	QKQ	H	403	29/29	0.64	0.30	57,65,85,86	0
5	EPE	D	404	15/15	0.65	0.47	48,60,77,79	0
4	QKQ	K	403	29/29	0.66	0.36	57,69,85,86	0
4	QKQ	C	403	29/29	0.67	0.32	66,74,90,91	0
5	EPE	J	404	15/15	0.69	0.46	47,59,74,78	0
4	QKQ	E	403	29/29	0.71	0.40	63,70,84,84	0
5	EPE	F	404	15/15	0.71	0.45	49,59,76,77	0
5	EPE	K	404	15/15	0.72	0.35	47,60,74,78	0
5	EPE	B	404	15/15	0.72	0.43	46,61,75,78	0
5	EPE	L	404	15/15	0.73	0.47	46,59,80,82	0
4	QKQ	J	403	29/29	0.73	0.32	61,67,86,87	0
4	QKQ	G	403	29/29	0.76	0.32	55,63,82,83	0
5	EPE	I	404	15/15	0.76	0.37	45,61,77,81	0
5	EPE	H	404	15/15	0.76	0.43	48,59,75,79	0
5	EPE	C	404	15/15	0.77	0.38	47,58,73,79	0
3	FES	H	402	4/4	0.77	0.33	45,76,79,124	0
5	EPE	E	404	15/15	0.79	0.25	47,58,73,78	0
5	EPE	A	404	15/15	0.80	0.29	48,59,73,75	0
3	FES	L	402	4/4	0.80	0.28	39,81,83,137	0
2	FE	F	401	1/1	0.83	0.07	49,49,49,49	0
3	FES	F	402	4/4	0.83	0.16	34,35,36,37	0
3	FES	D	402	4/4	0.85	0.14	33,38,40,60	0
3	FES	J	402	4/4	0.87	0.17	42,53,57,73	0
2	FE	I	401	1/1	0.88	0.09	61,61,61,61	0
3	FES	A	402	4/4	0.89	0.22	33,52,80,81	0

Continued on next page...

Continued from previous page...

Mol	Type	Chain	Res	Atoms	RSCC	RSR	B-factors(\AA^2)	Q<0.9
2	FE	D	401	1/1	0.90	0.10	63,63,63,63	0
3	FES	G	402	4/4	0.90	0.15	34,43,44,63	0
2	FE	B	401	1/1	0.90	0.15	63,63,63,63	0
2	FE	K	401	1/1	0.90	0.06	63,63,63,63	0
2	FE	E	401	1/1	0.91	0.07	55,55,55,55	0
2	FE	H	401	1/1	0.92	0.07	56,56,56,56	0
3	FES	K	402	4/4	0.92	0.17	37,43,45,54	0
3	FES	E	402	4/4	0.92	0.14	33,34,36,39	0
2	FE	A	401	1/1	0.93	0.07	81,81,81,81	0
2	FE	C	401	1/1	0.93	0.05	64,64,64,64	0
3	FES	I	402	4/4	0.93	0.15	36,37,37,54	0
3	FES	C	402	4/4	0.93	0.12	48,49,53,61	0
2	FE	L	401	1/1	0.94	0.09	56,56,56,56	0
3	FES	B	402	4/4	0.95	0.09	38,43,44,47	0
2	FE	J	401	1/1	0.96	0.08	72,72,72,72	0
2	FE	G	401	1/1	0.97	0.04	55,55,55,55	0

The following is a graphical depiction of the model fit to experimental electron density of all instances of the Ligand of Interest. In addition, ligands with molecular weight > 250 and outliers as shown on the geometry validation Tables will also be included. Each fit is shown from different orientation to approximate a three-dimensional view.

Electron density around QKQ A 403:

$2mF_o-DF_c$ (at 0.7 rmsd) in gray
 mF_o-DF_c (at 3 rmsd) in purple (negative)
and green (positive)

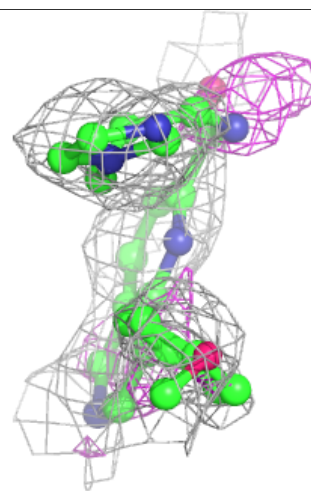
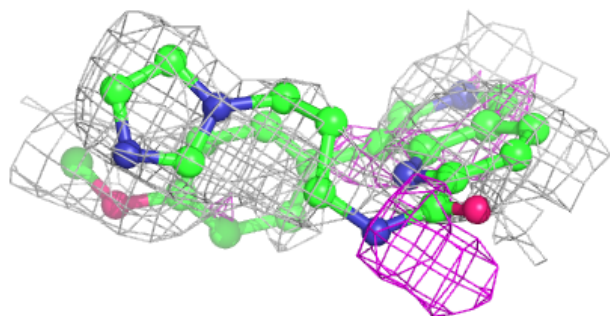
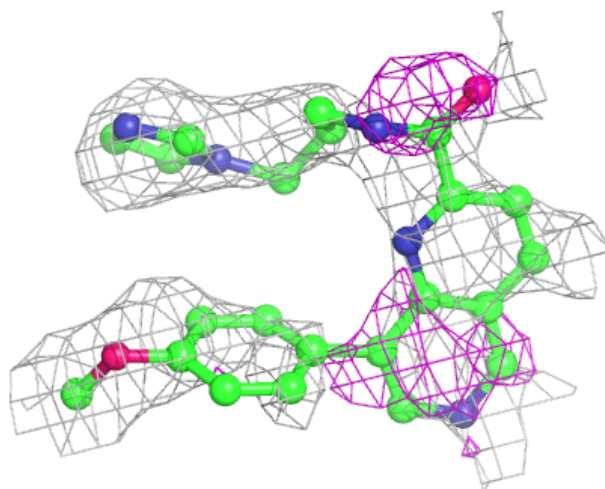

Electron density around QKQ I 403:

$2mF_o-DF_c$ (at 0.7 rmsd) in gray
 mF_o-DF_c (at 3 rmsd) in purple (negative)
and green (positive)

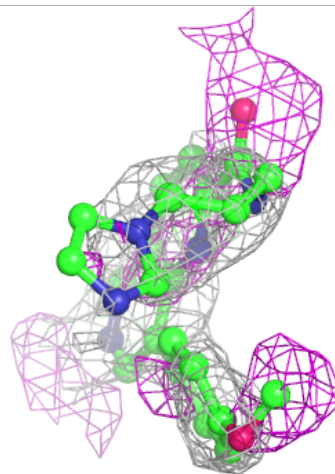
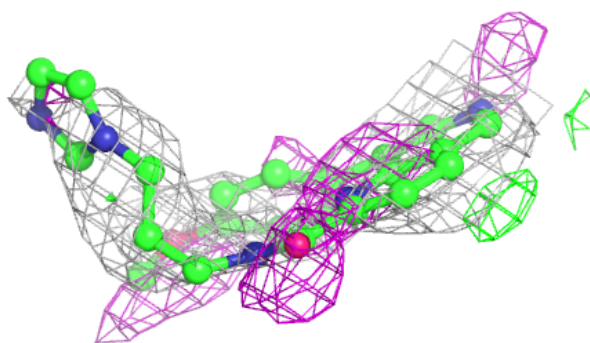
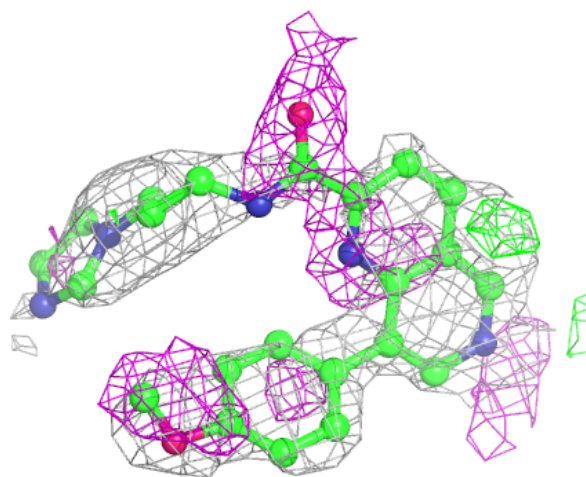

Electron density around QKQ D 403:

$2mF_o-DF_c$ (at 0.7 rmsd) in gray
 mF_o-DF_c (at 3 rmsd) in purple (negative)
and green (positive)

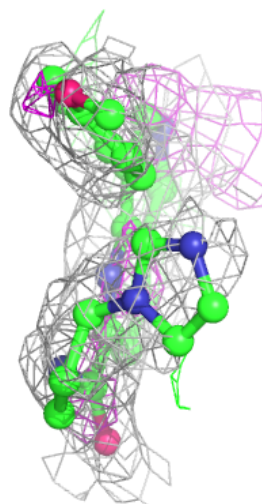
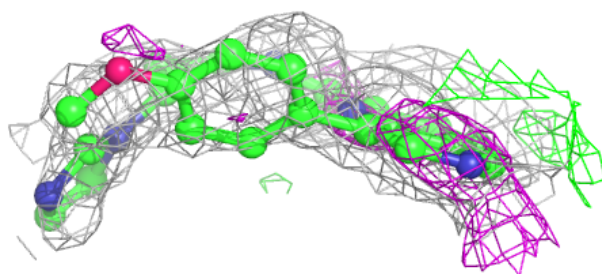
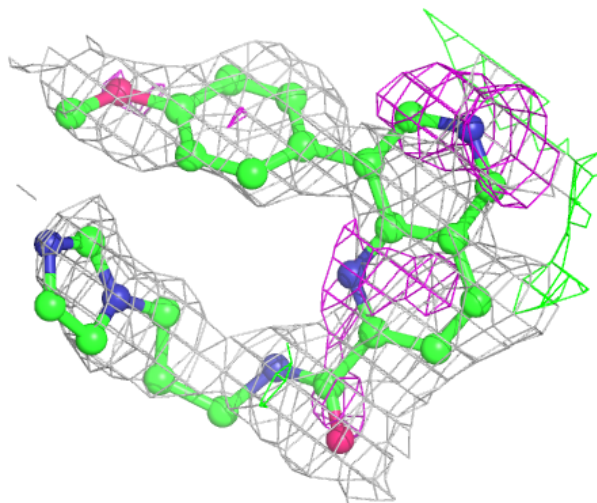

Electron density around QKQ B 403:

$2mF_o-DF_c$ (at 0.7 rmsd) in gray
 mF_o-DF_c (at 3 rmsd) in purple (negative)
and green (positive)

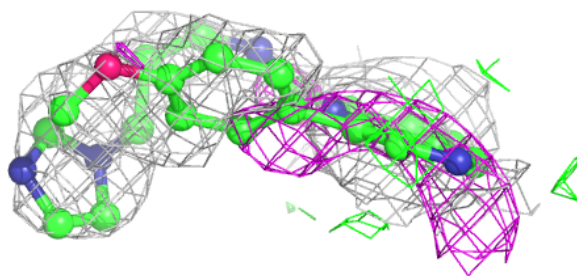
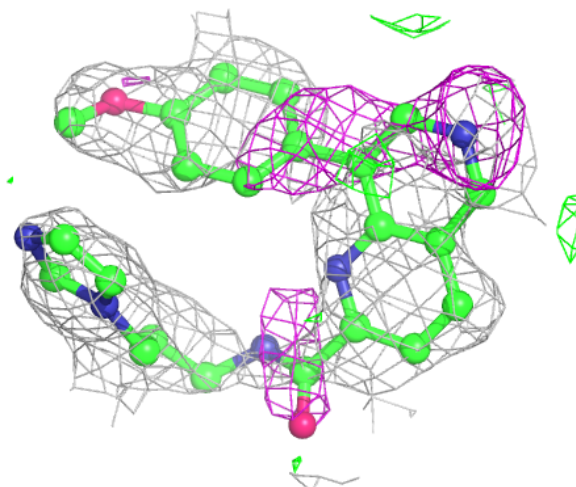

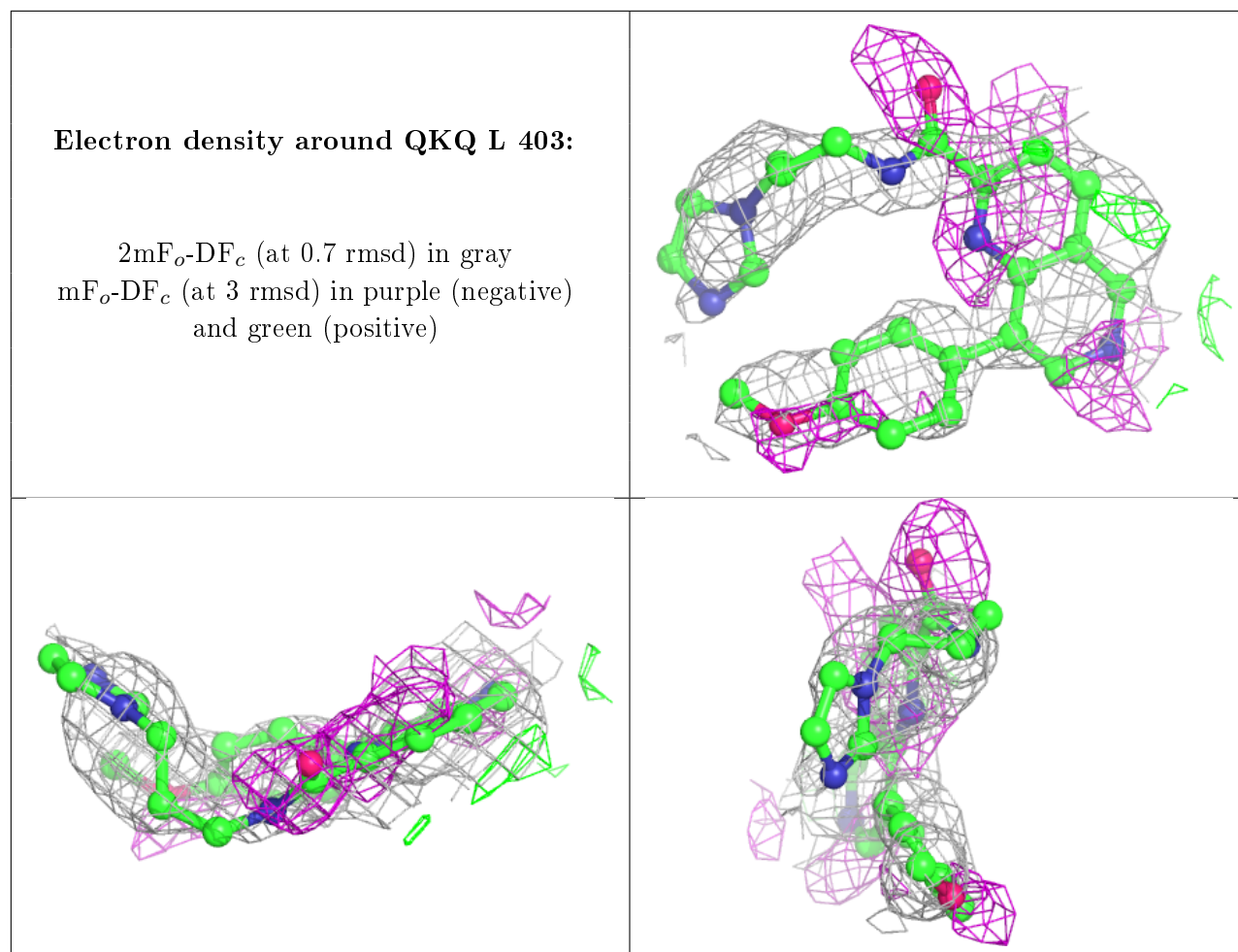

Electron density around QKQ F 403:

$2mF_o-DF_c$ (at 0.7 rmsd) in gray
 mF_o-DF_c (at 3 rmsd) in purple (negative)
and green (positive)

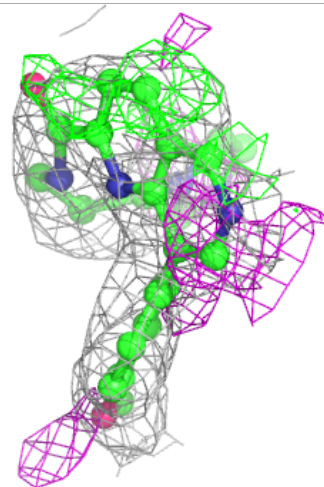
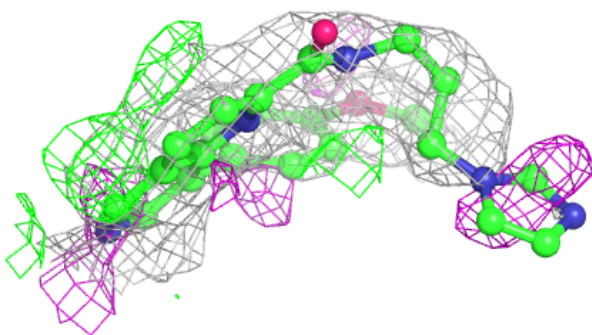
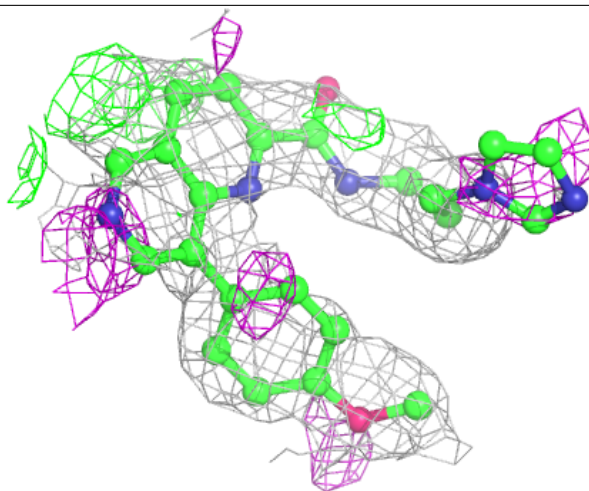

Electron density around QKQ H 403:

$2mF_o-DF_c$ (at 0.7 rmsd) in gray
 mF_o-DF_c (at 3 rmsd) in purple (negative)
and green (positive)

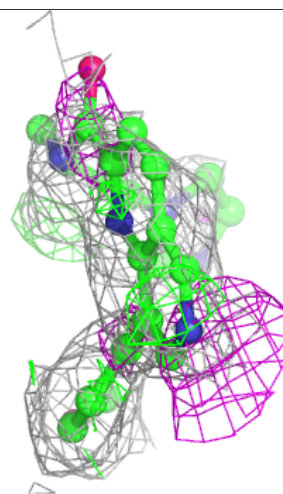
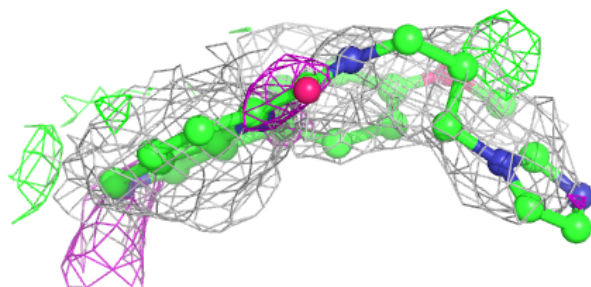
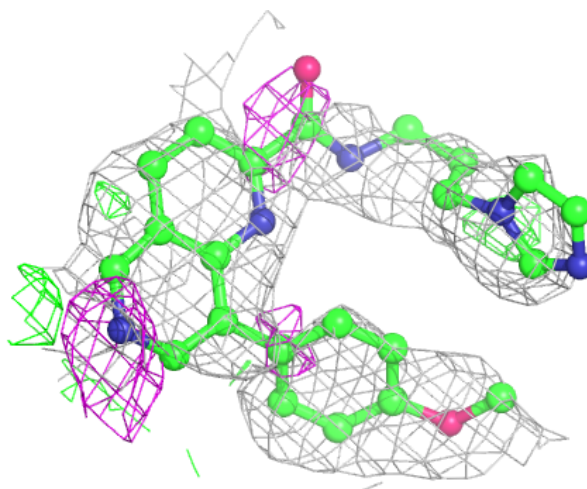

Electron density around QKQ K 403:

$2mF_o-DF_c$ (at 0.7 rmsd) in gray
 mF_o-DF_c (at 3 rmsd) in purple (negative)
and green (positive)

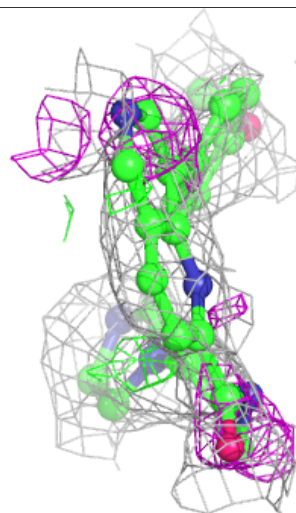
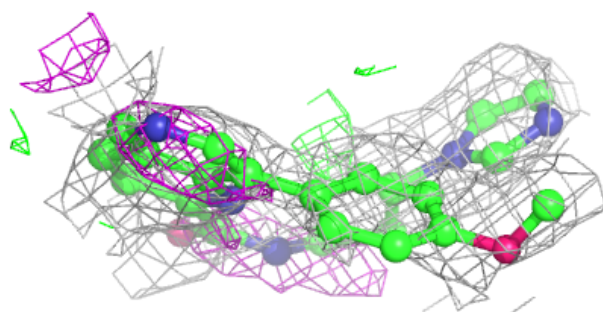
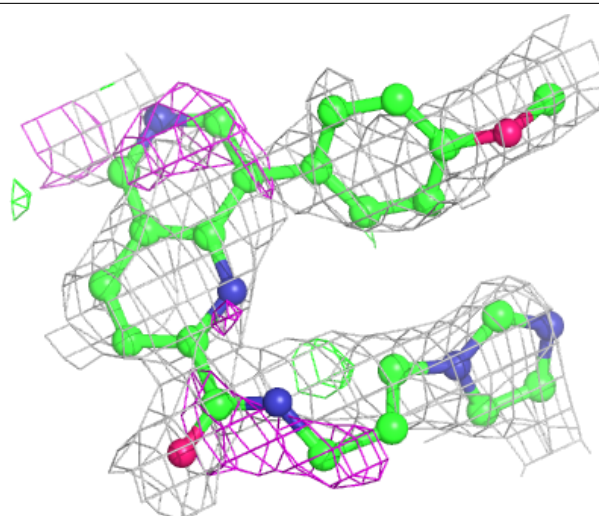

Electron density around QKQ C 403:

$2mF_o-DF_c$ (at 0.7 rmsd) in gray
 mF_o-DF_c (at 3 rmsd) in purple (negative)
and green (positive)

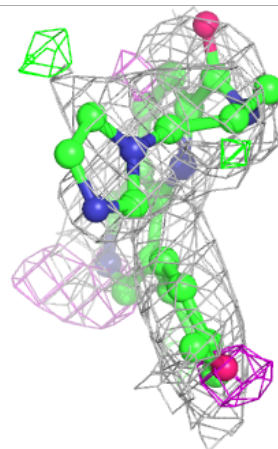
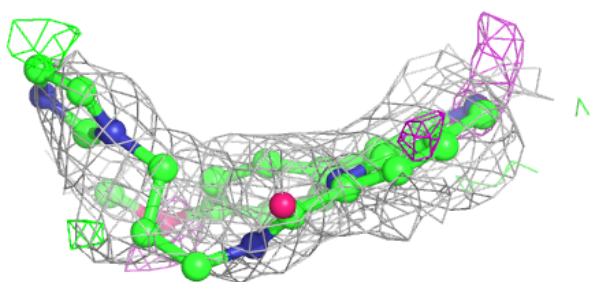
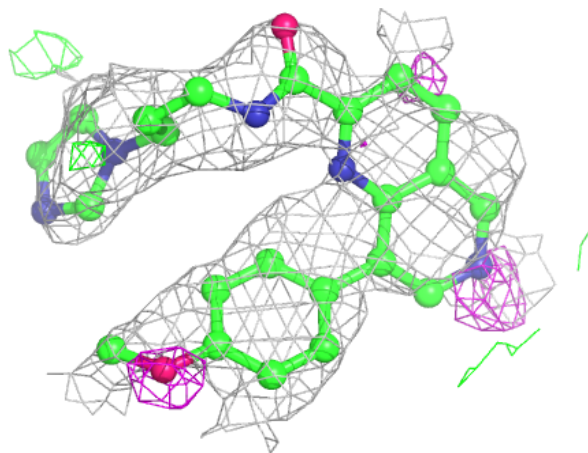

Electron density around QKQ E 403:

$2mF_o-DF_c$ (at 0.7 rmsd) in gray
 mF_o-DF_c (at 3 rmsd) in purple (negative)
and green (positive)

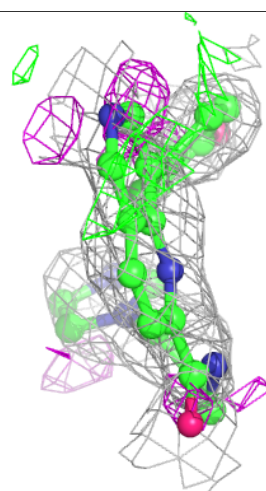
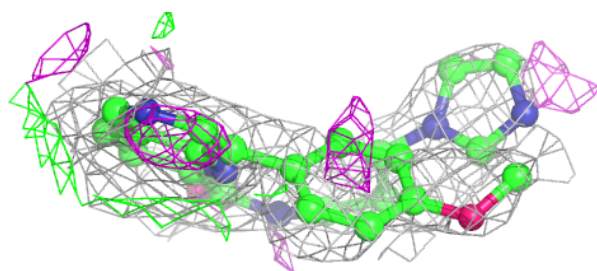
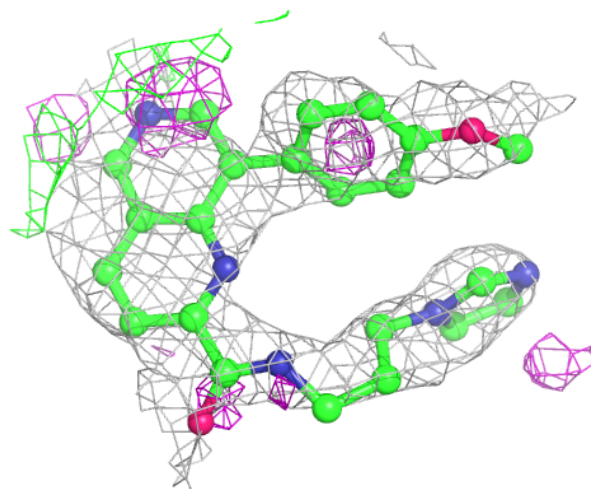

Electron density around QKQ J 403:

$2mF_o-DF_c$ (at 0.7 rmsd) in gray
 mF_o-DF_c (at 3 rmsd) in purple (negative)
and green (positive)

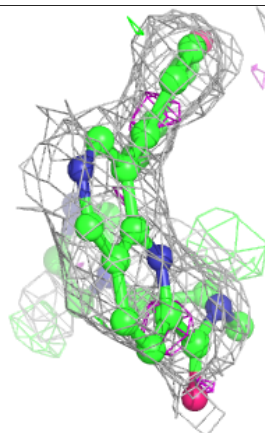
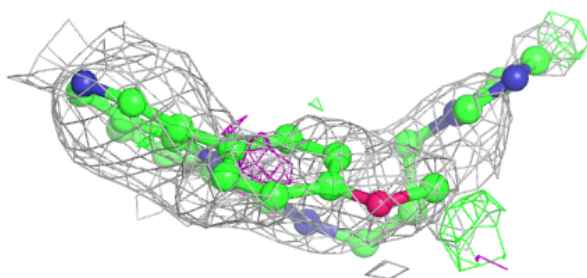
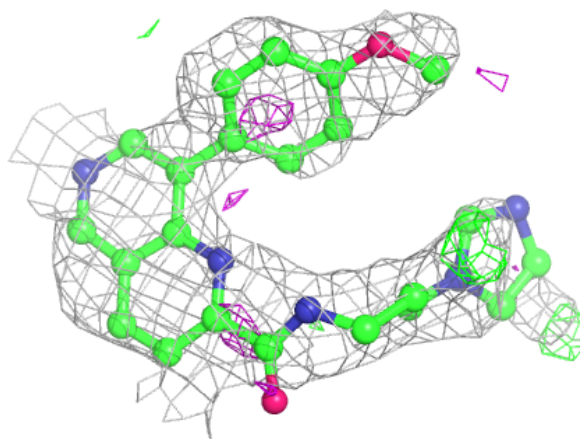

Electron density around QKQ G 403:

$2mF_o-DF_c$ (at 0.7 rmsd) in gray
 mF_o-DF_c (at 3 rmsd) in purple (negative)
and green (positive)

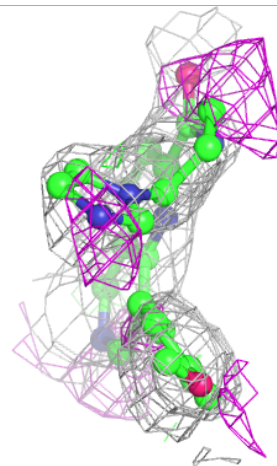
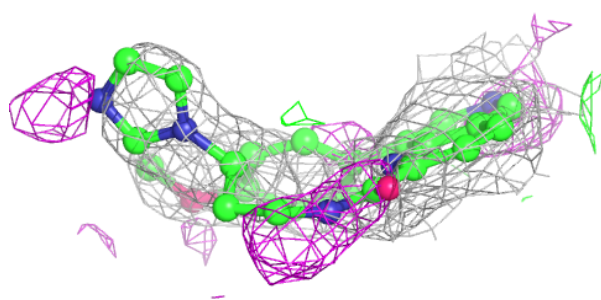
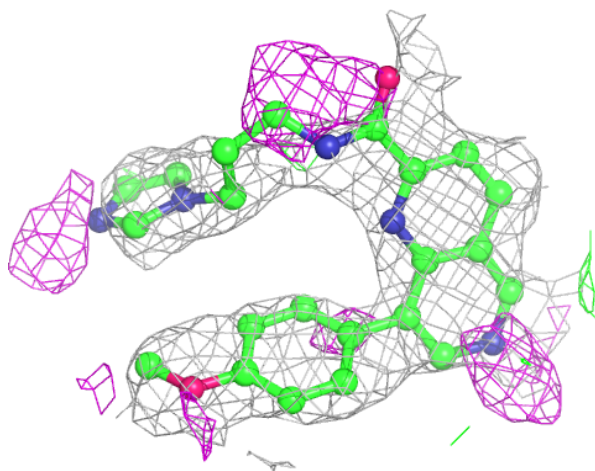

Electron density around FES H 402:

$2mF_o-DF_c$ (at 0.7 rmsd) in gray
 mF_o-DF_c (at 3 rmsd) in purple (negative)
and green (positive)

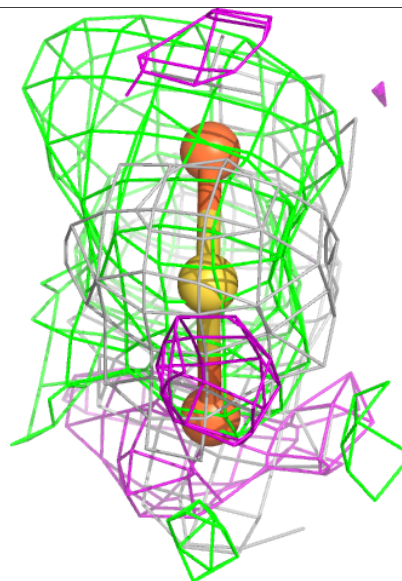
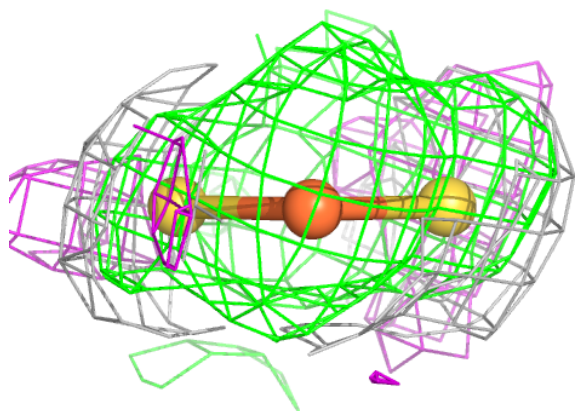
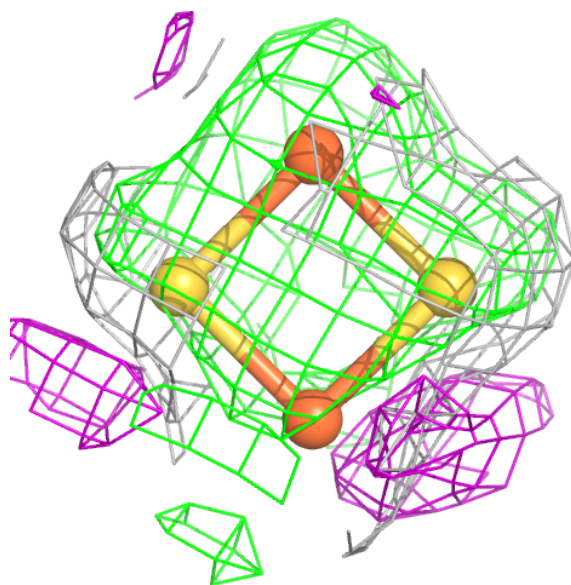

Electron density around FES L 402:

$2mF_o-DF_c$ (at 0.7 rmsd) in gray
 mF_o-DF_c (at 3 rmsd) in purple (negative)
and green (positive)

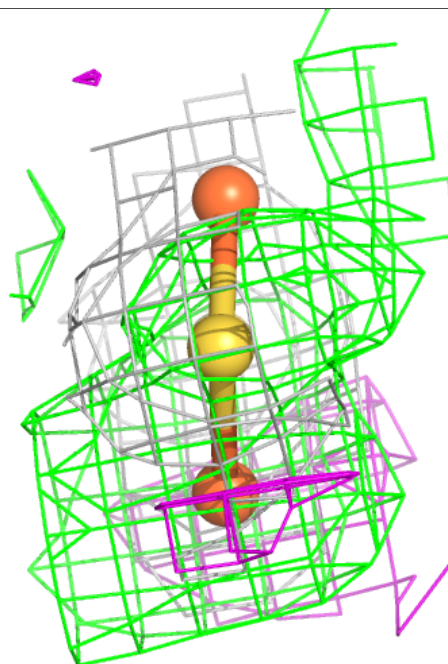
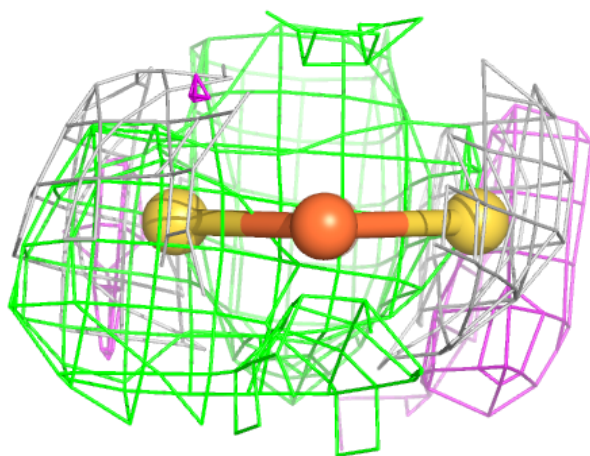
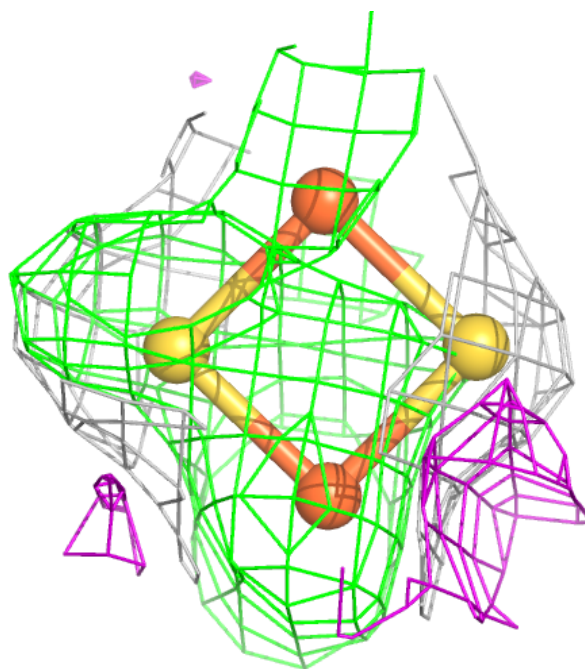

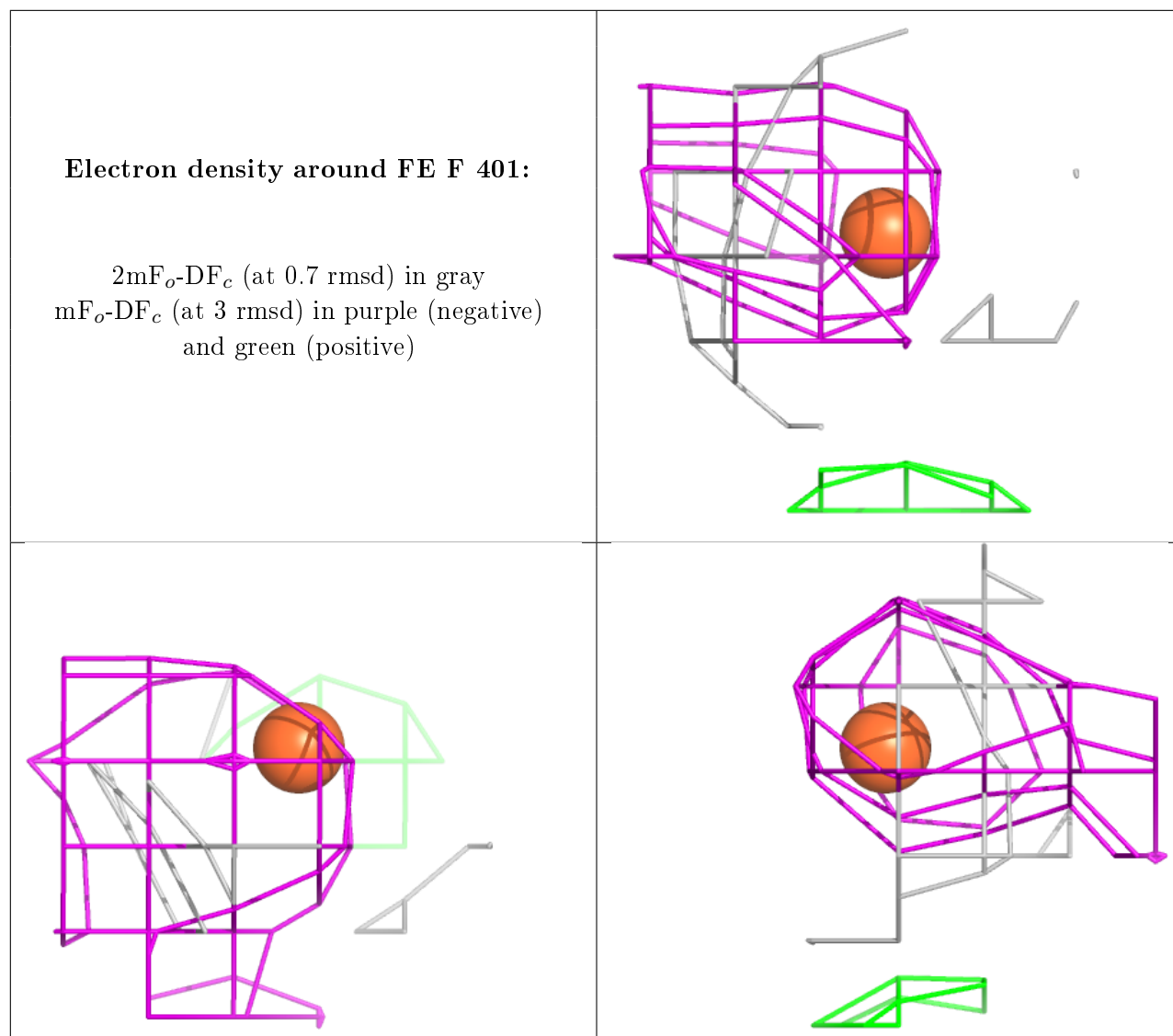

Electron density around FES F 402:

$2mF_o-DF_c$ (at 0.7 rmsd) in gray
 mF_o-DF_c (at 3 rmsd) in purple (negative)
and green (positive)

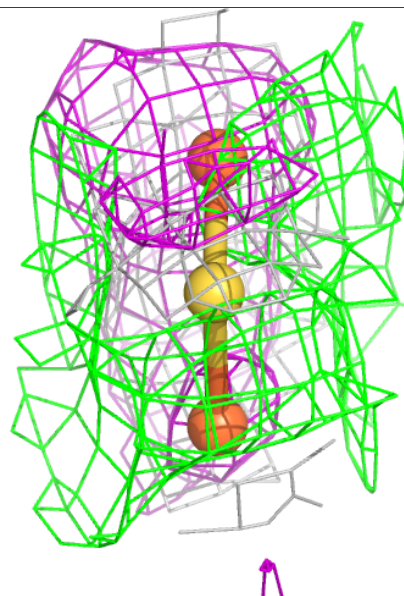
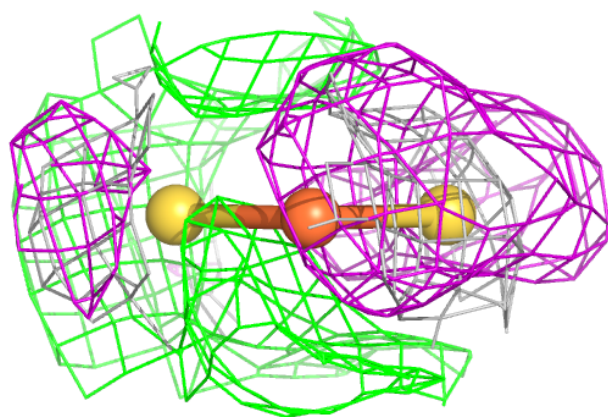
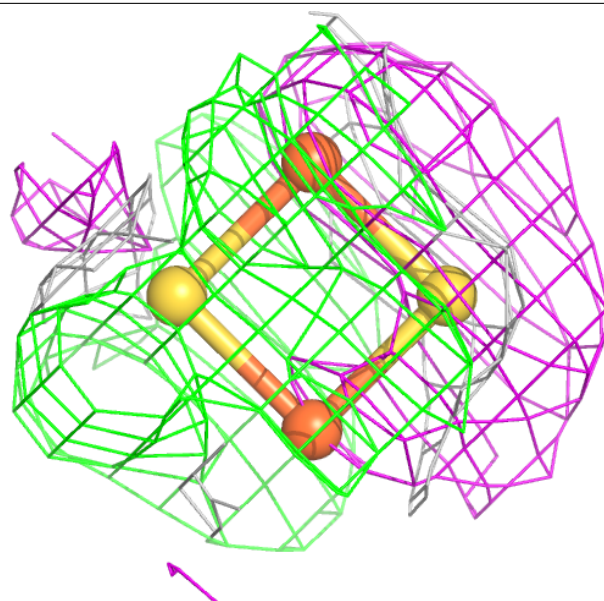

Electron density around FES D 402:

$2mF_o-DF_c$ (at 0.7 rmsd) in gray
 mF_o-DF_c (at 3 rmsd) in purple (negative)
and green (positive)

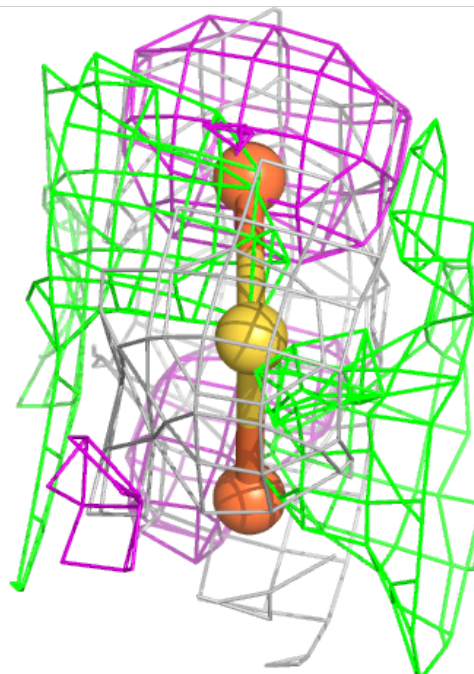
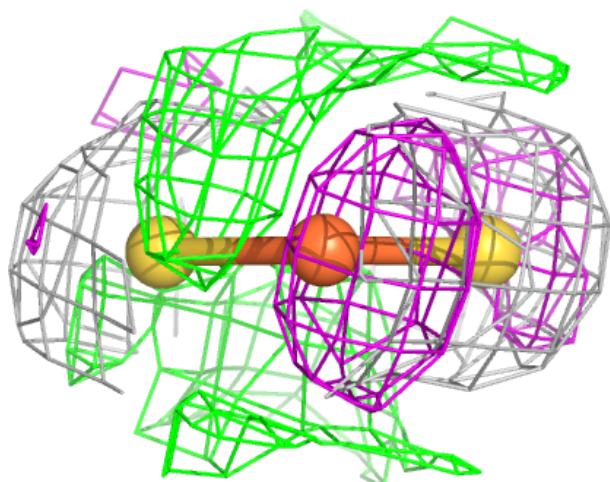
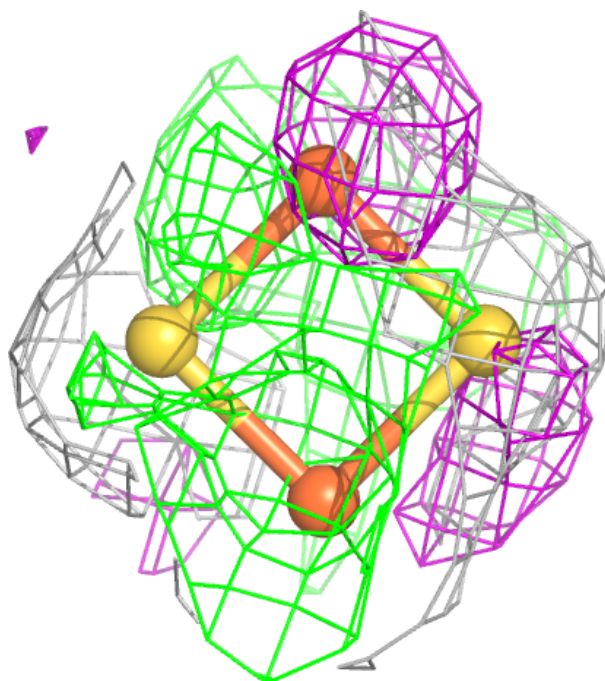

Electron density around FES J 402:

$2mF_o-DF_c$ (at 0.7 rmsd) in gray
 mF_o-DF_c (at 3 rmsd) in purple (negative)
and green (positive)

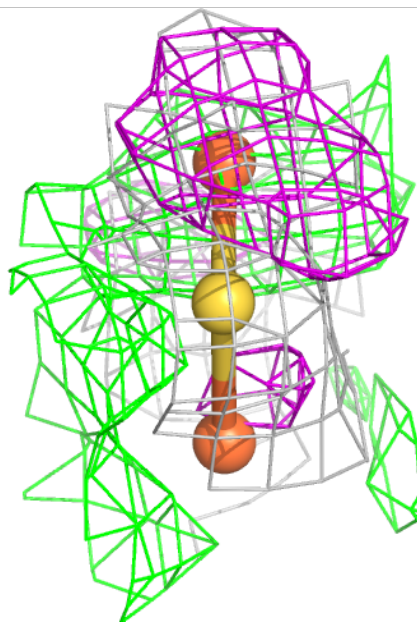
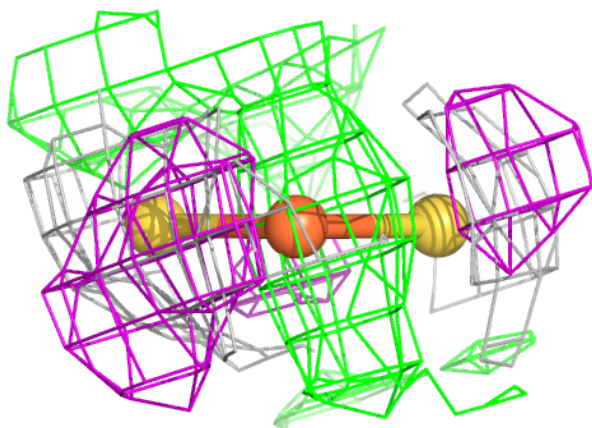
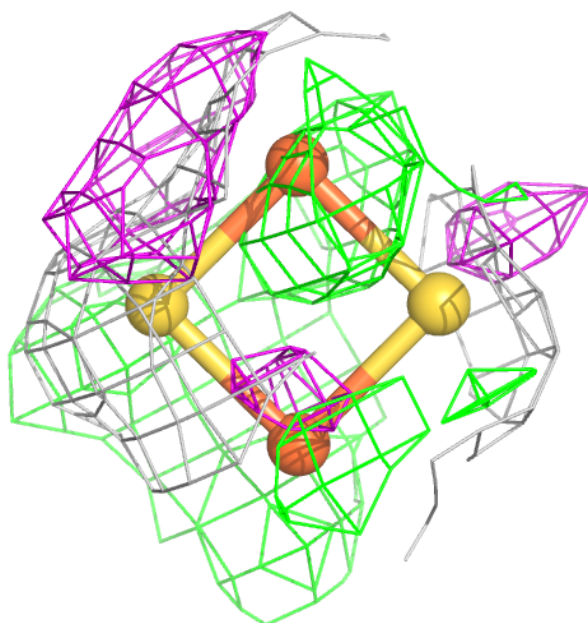

Electron density around FE I 401:

$2mF_o-DF_c$ (at 0.7 rmsd) in gray
 mF_o-DF_c (at 3 rmsd) in purple (negative)
and green (positive)

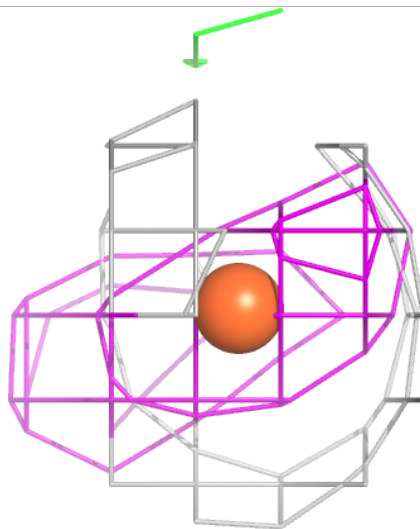
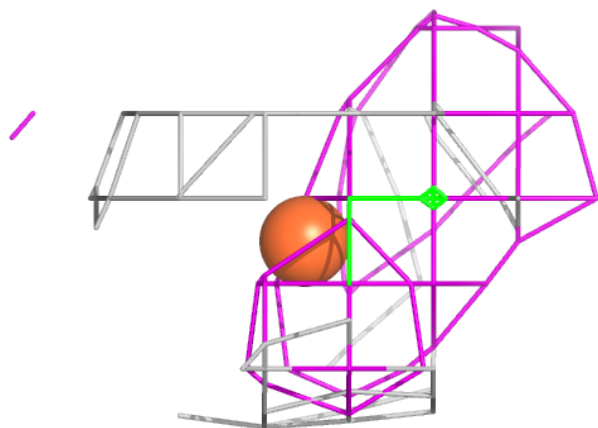
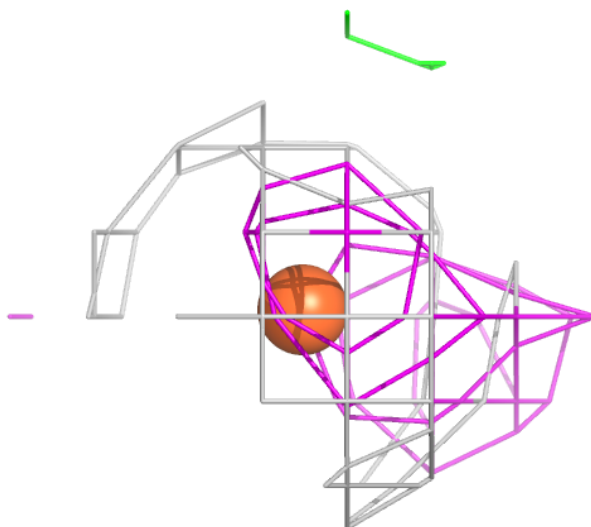

Electron density around FES A 402:

$2mF_o-DF_c$ (at 0.7 rmsd) in gray
 mF_o-DF_c (at 3 rmsd) in purple (negative)
and green (positive)

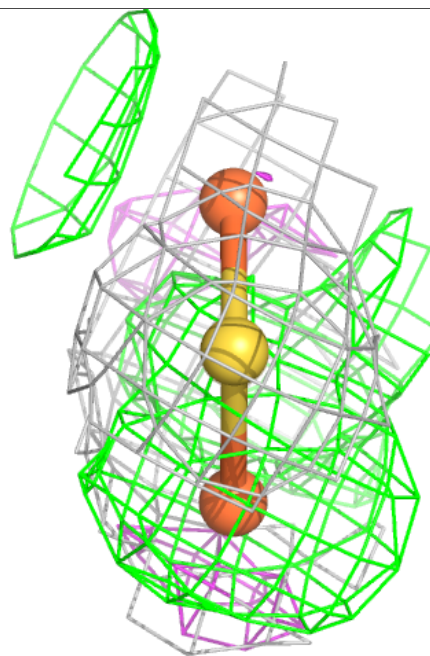
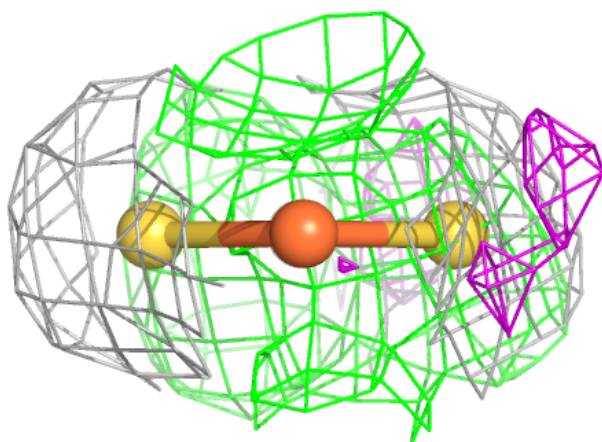
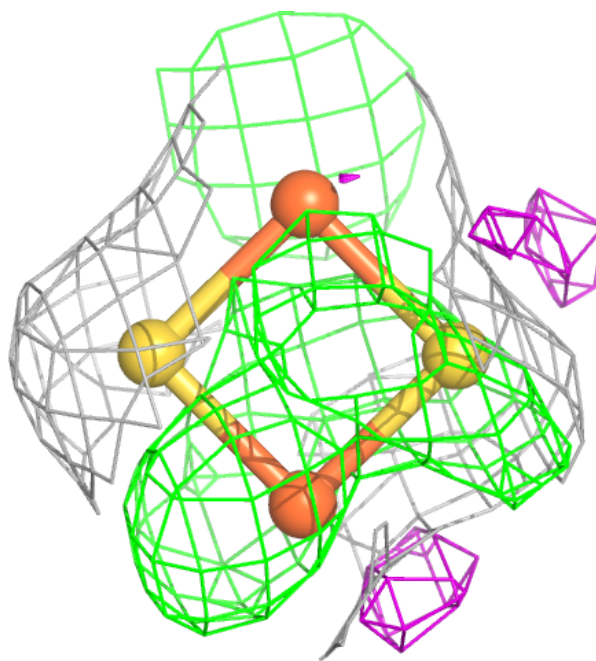

Electron density around FE D 401:

$2mF_o-DF_c$ (at 0.7 rmsd) in gray
 mF_o-DF_c (at 3 rmsd) in purple (negative)
and green (positive)

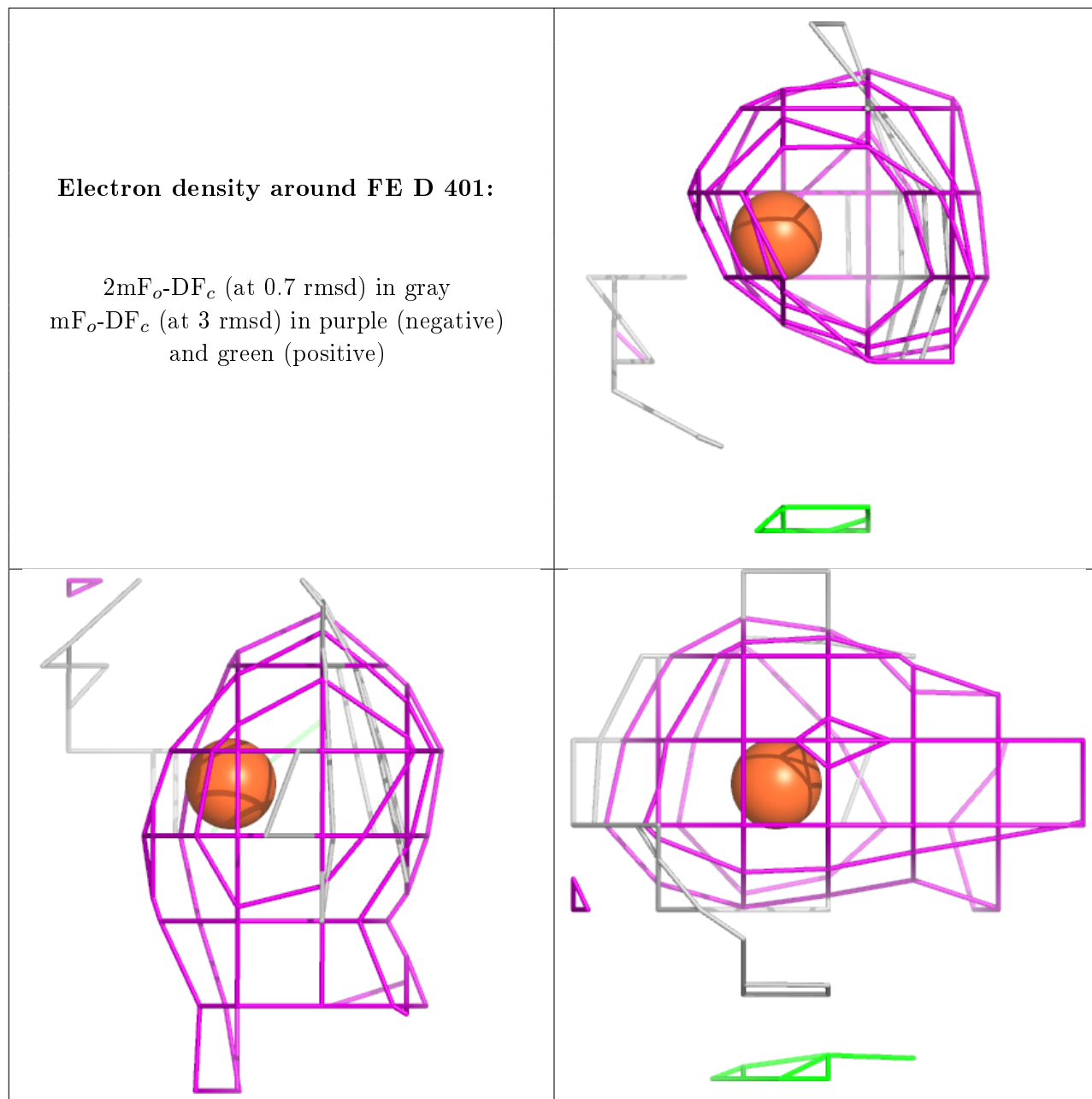

Electron density around FES G 402:

$2mF_o-DF_c$ (at 0.7 rmsd) in gray
 mF_o-DF_c (at 3 rmsd) in purple (negative)
and green (positive)

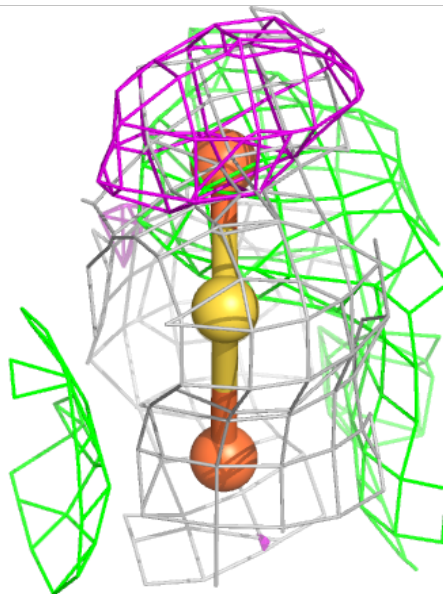
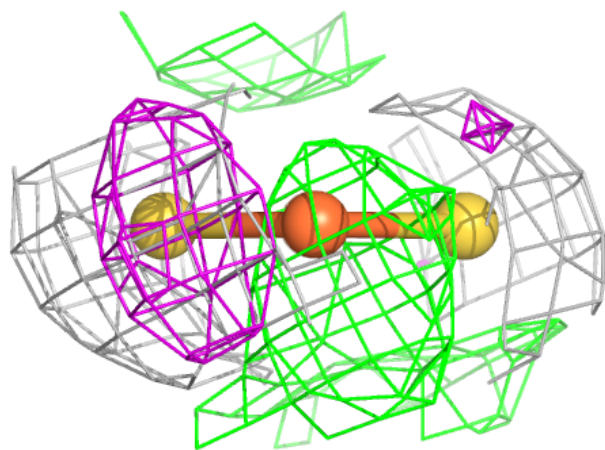
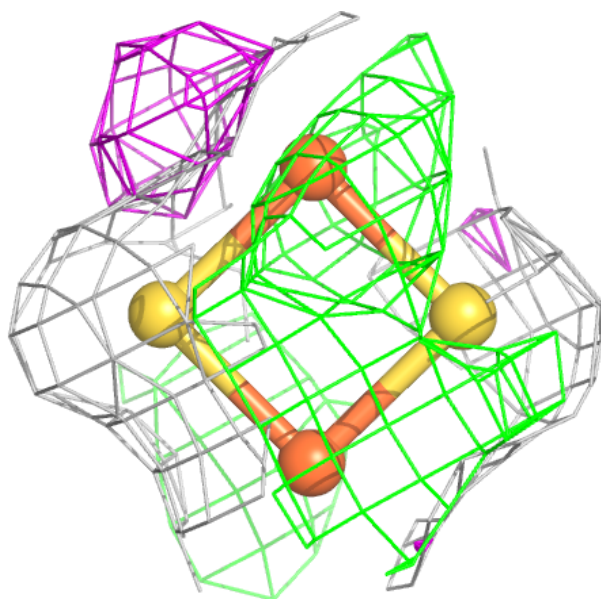

Electron density around FE B 401:

$2mF_o-DF_c$ (at 0.7 rmsd) in gray
 mF_o-DF_c (at 3 rmsd) in purple (negative)
and green (positive)

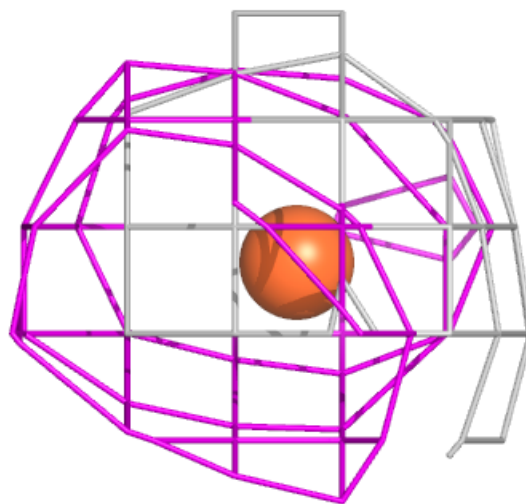
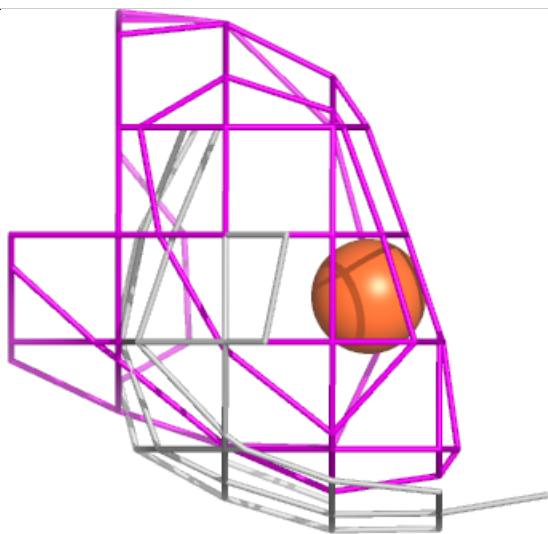
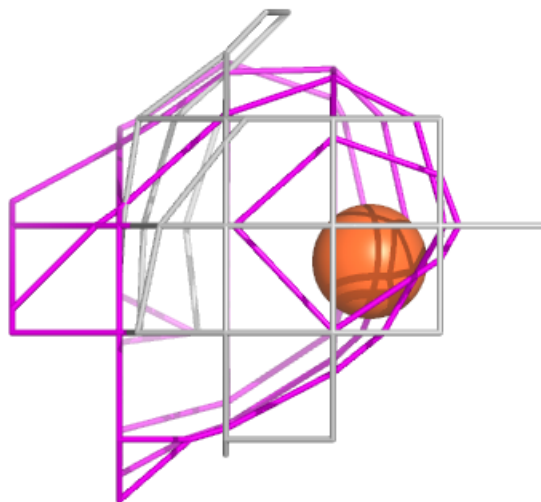

Electron density around FE K 401:

$2mF_o-DF_c$ (at 0.7 rmsd) in gray
 mF_o-DF_c (at 3 rmsd) in purple (negative)
and green (positive)

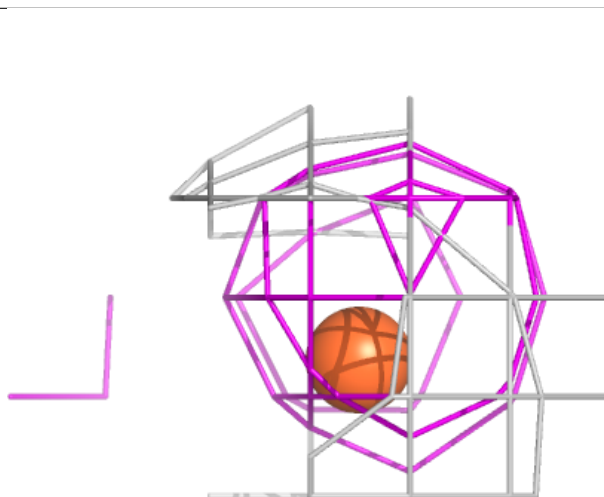
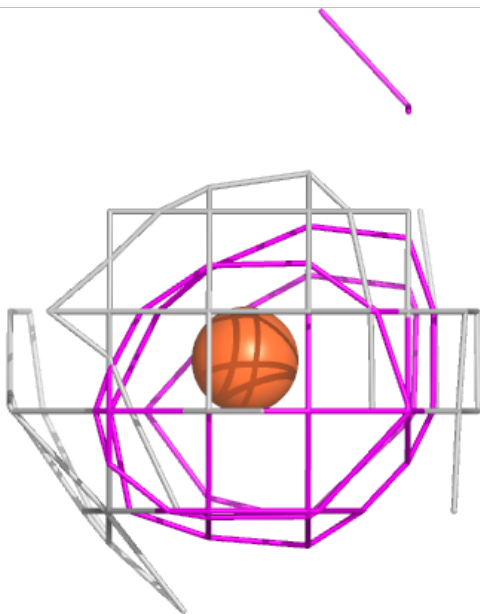
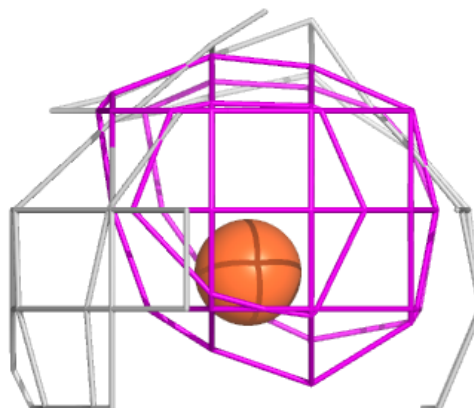

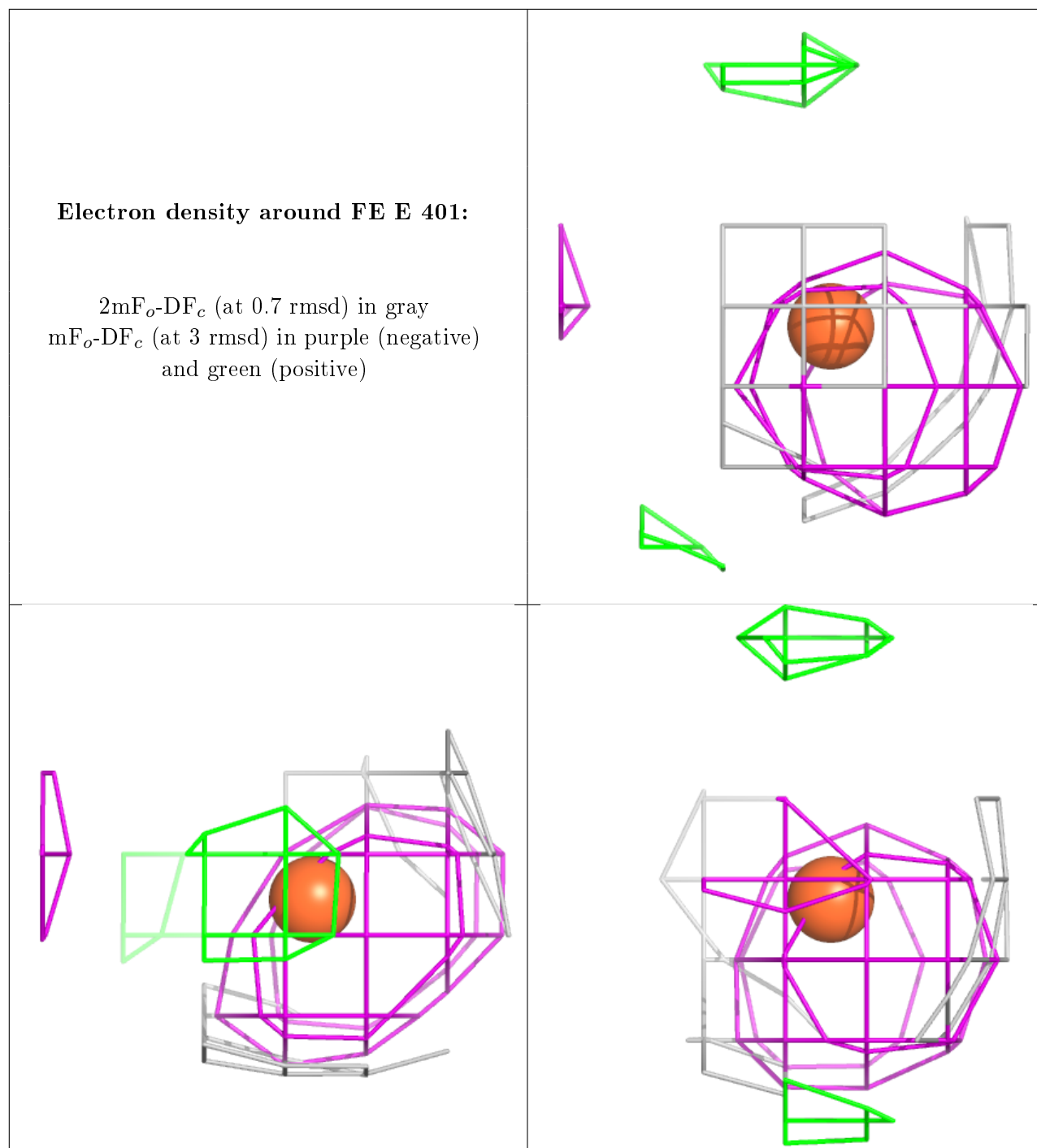

Electron density around FE H 401:

$2mF_o-DF_c$ (at 0.7 rmsd) in gray
 mF_o-DF_c (at 3 rmsd) in purple (negative)
and green (positive)

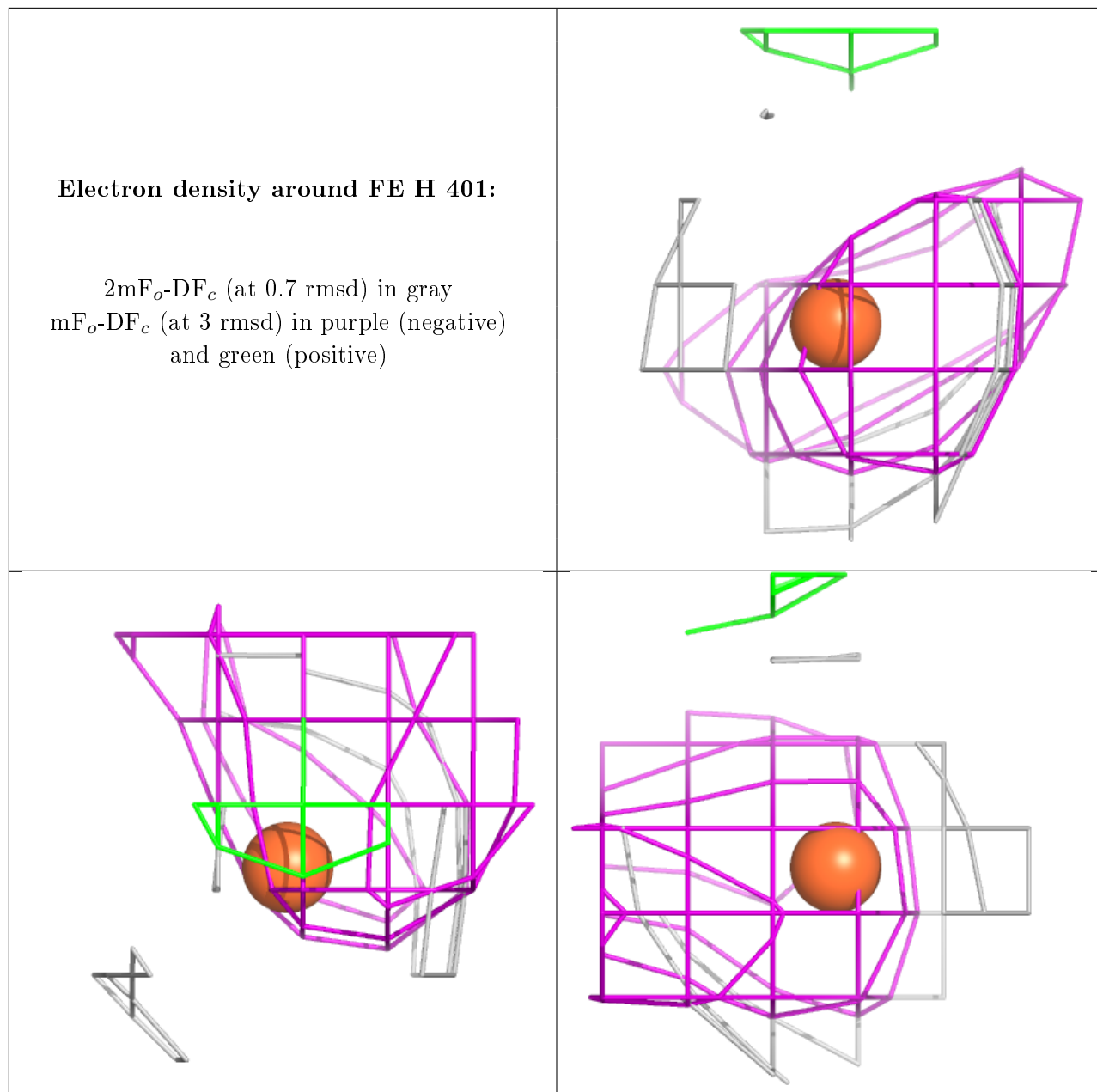

Electron density around FES K 402:

$2mF_o-DF_c$ (at 0.7 rmsd) in gray
 mF_o-DF_c (at 3 rmsd) in purple (negative)
and green (positive)

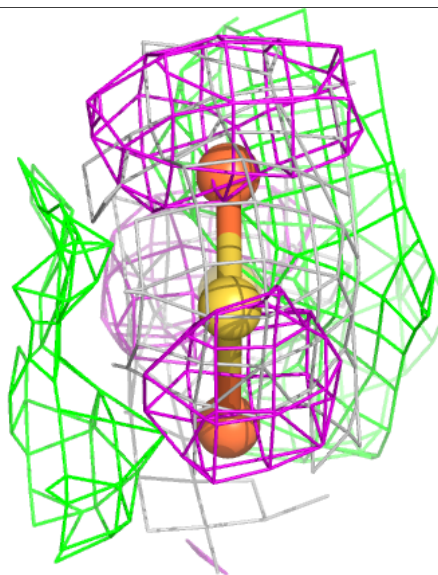
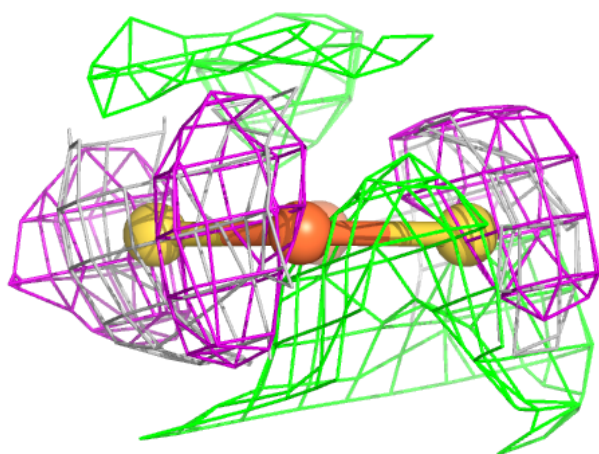
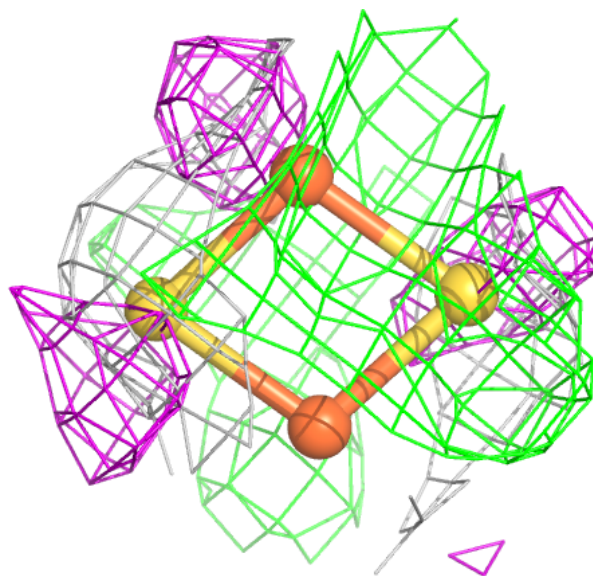

Electron density around FES E 402:

$2mF_o-DF_c$ (at 0.7 rmsd) in gray
 mF_o-DF_c (at 3 rmsd) in purple (negative)
and green (positive)

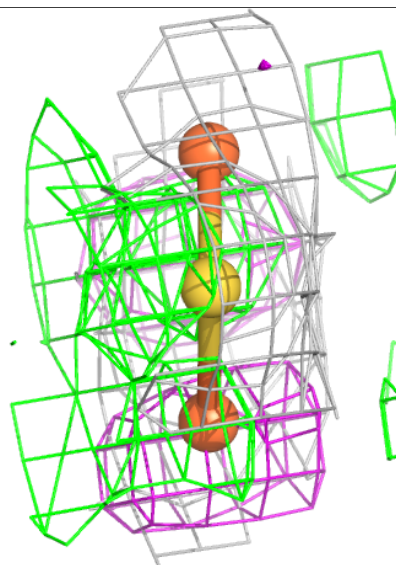
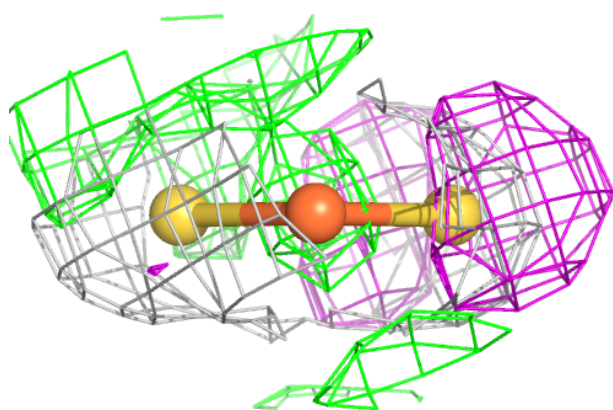
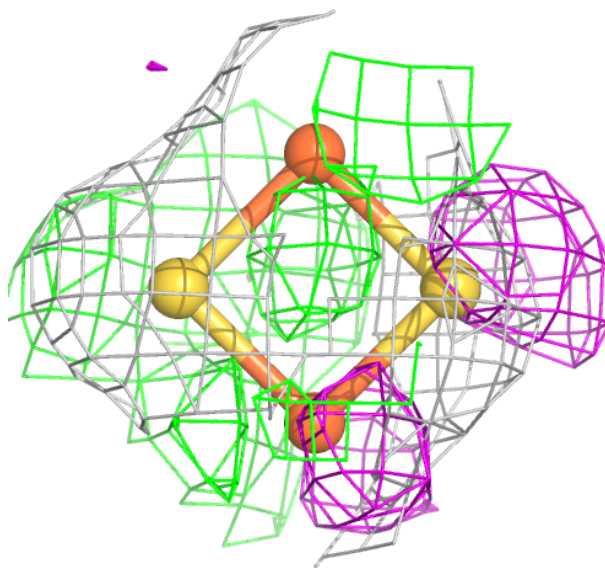

Electron density around FE A 401:

$2mF_o-DF_c$ (at 0.7 rmsd) in gray
 mF_o-DF_c (at 3 rmsd) in purple (negative)
and green (positive)

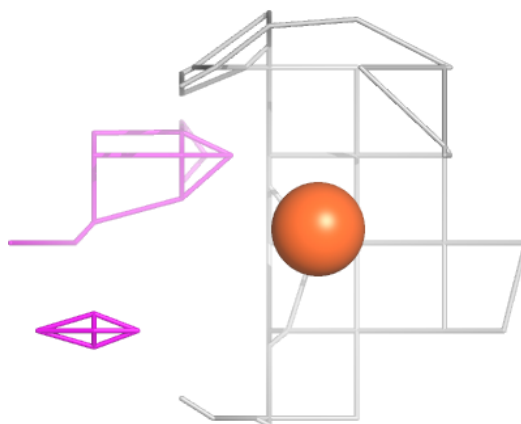
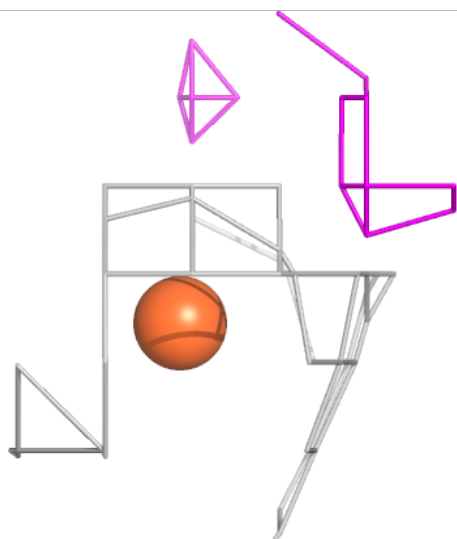
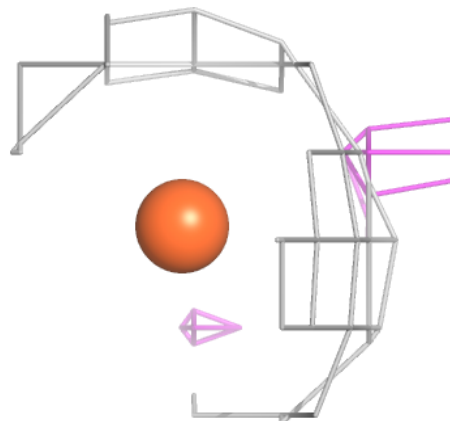

Electron density around FE C 401:

$2mF_o-DF_c$ (at 0.7 rmsd) in gray
 mF_o-DF_c (at 3 rmsd) in purple (negative)
and green (positive)

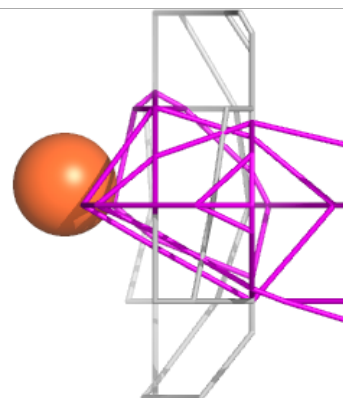
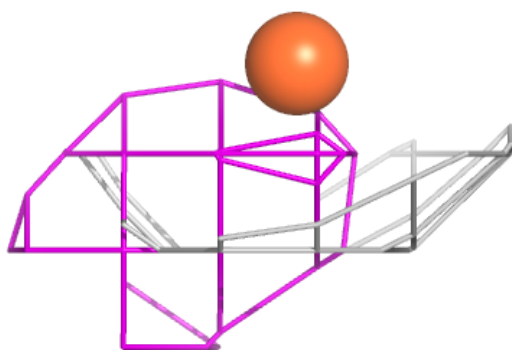
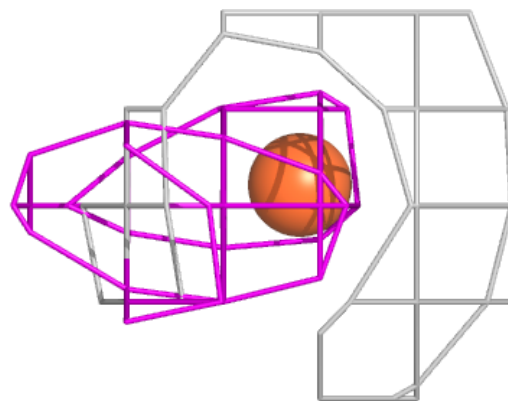

Electron density around FES I 402:

$2mF_o-DF_c$ (at 0.7 rmsd) in gray
 mF_o-DF_c (at 3 rmsd) in purple (negative)
and green (positive)

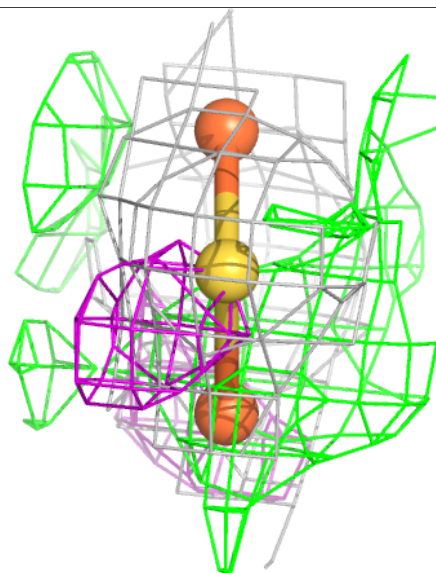
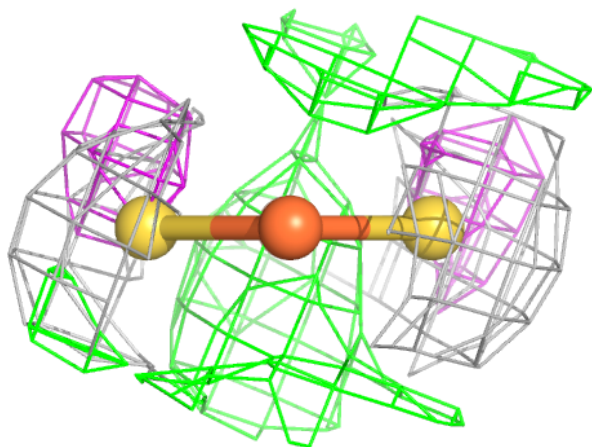
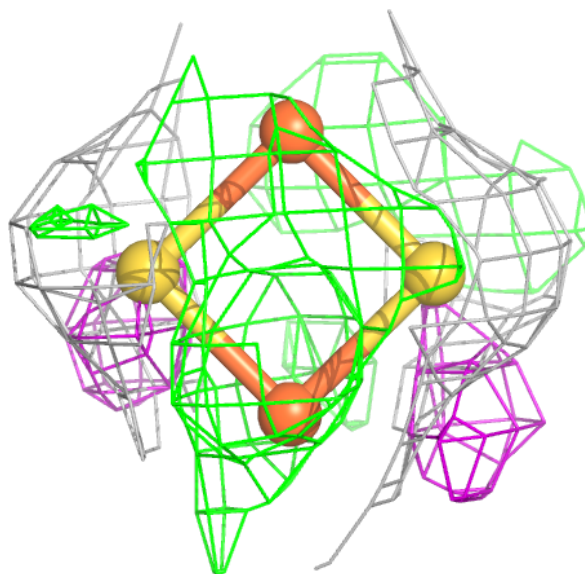

Electron density around FES C 402:

$2mF_o-DF_c$ (at 0.7 rmsd) in gray
 mF_o-DF_c (at 3 rmsd) in purple (negative)
and green (positive)

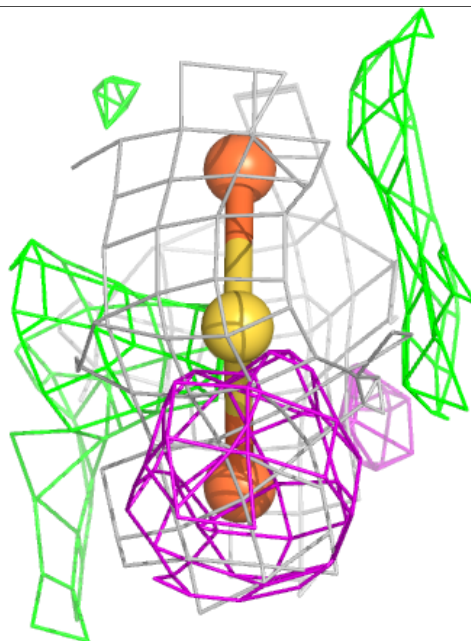
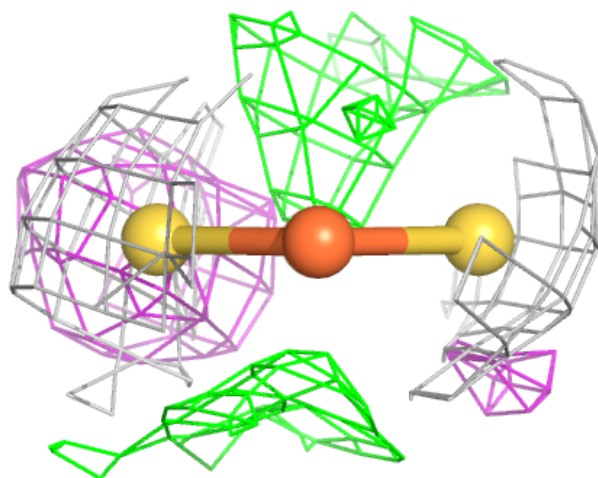
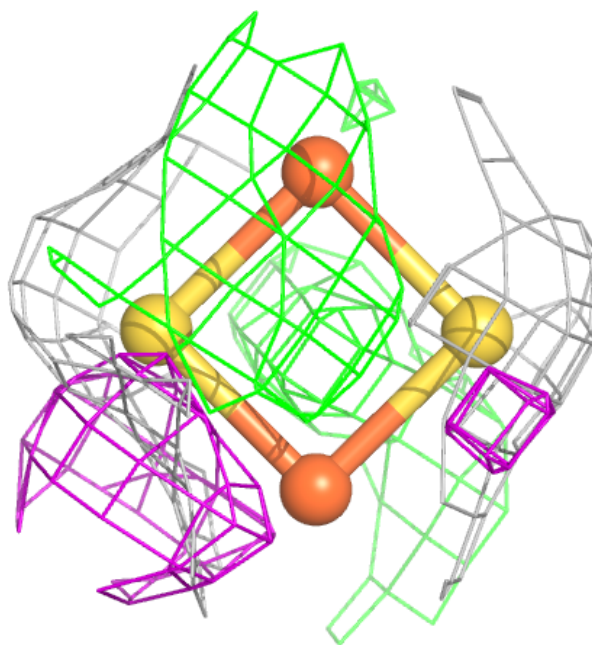

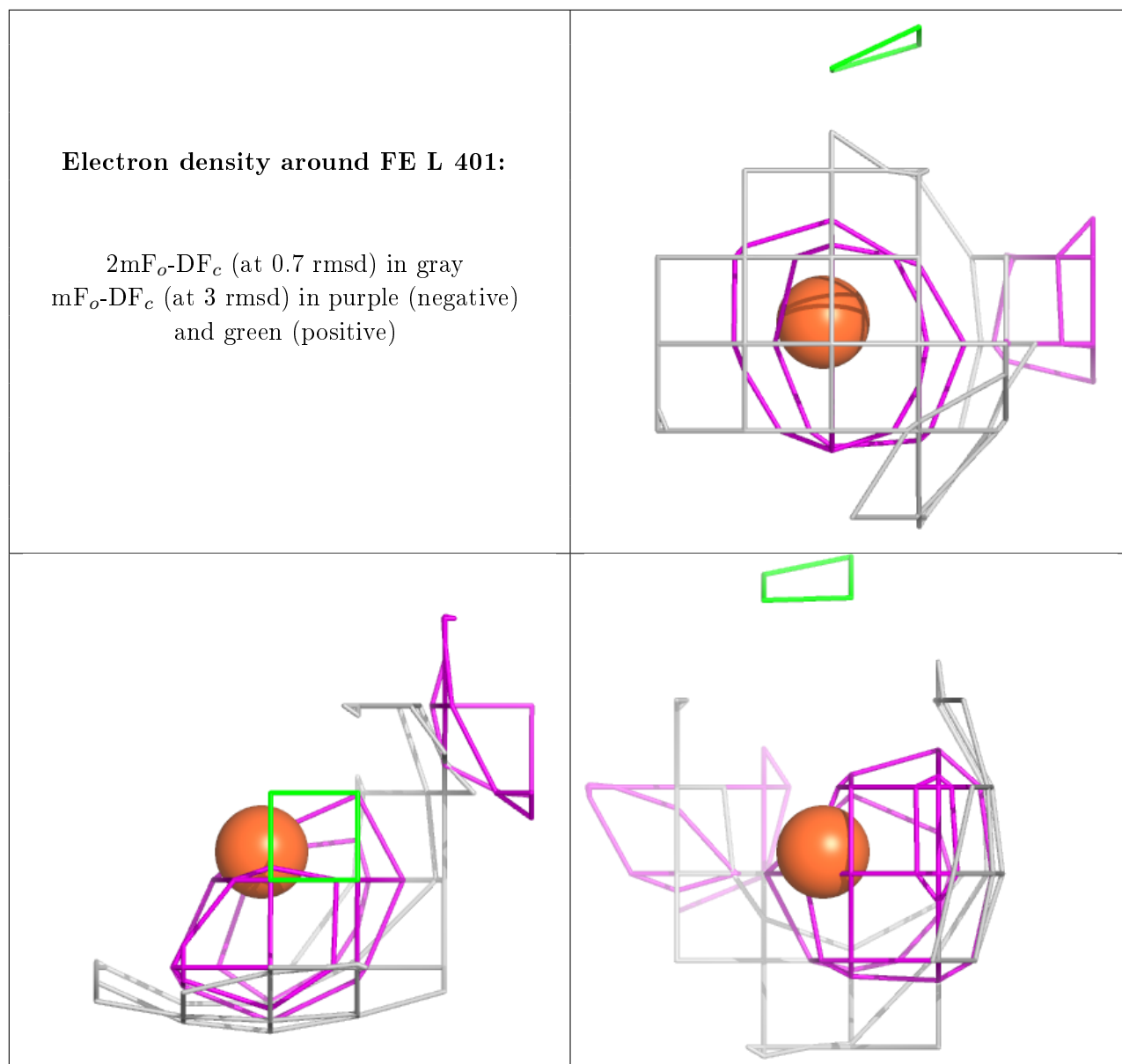

Electron density around FES B 402:

$2mF_o-DF_c$ (at 0.7 rmsd) in gray
 mF_o-DF_c (at 3 rmsd) in purple (negative)
and green (positive)

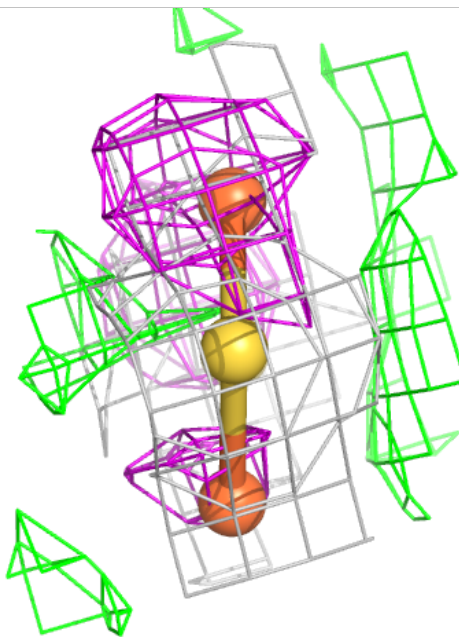
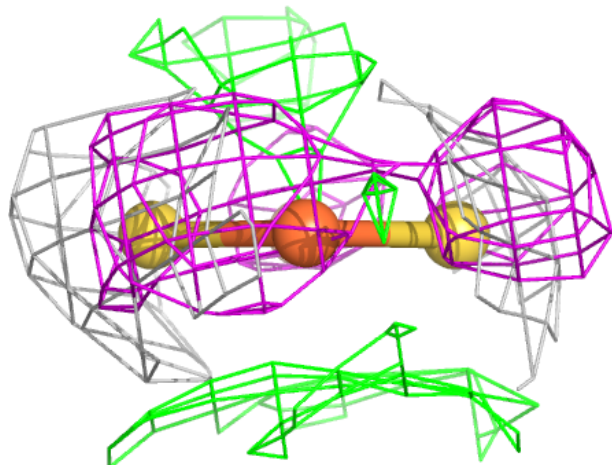
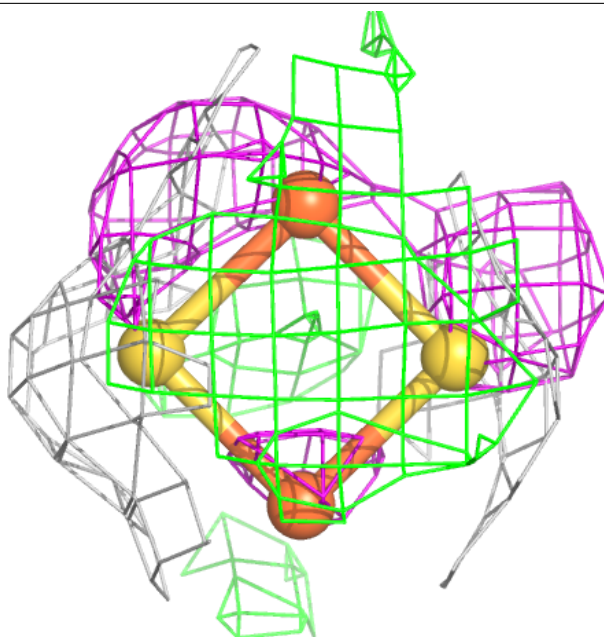

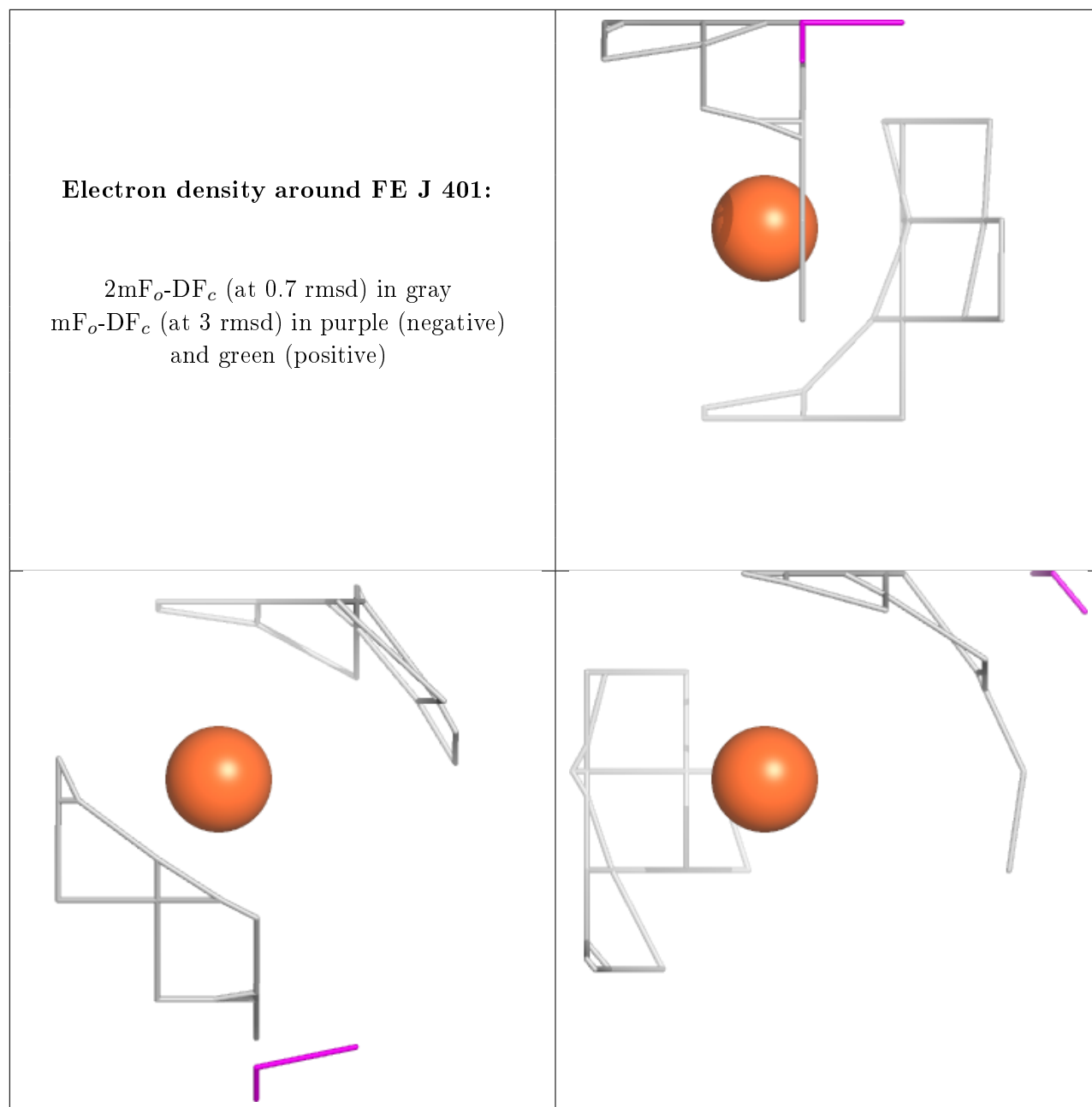

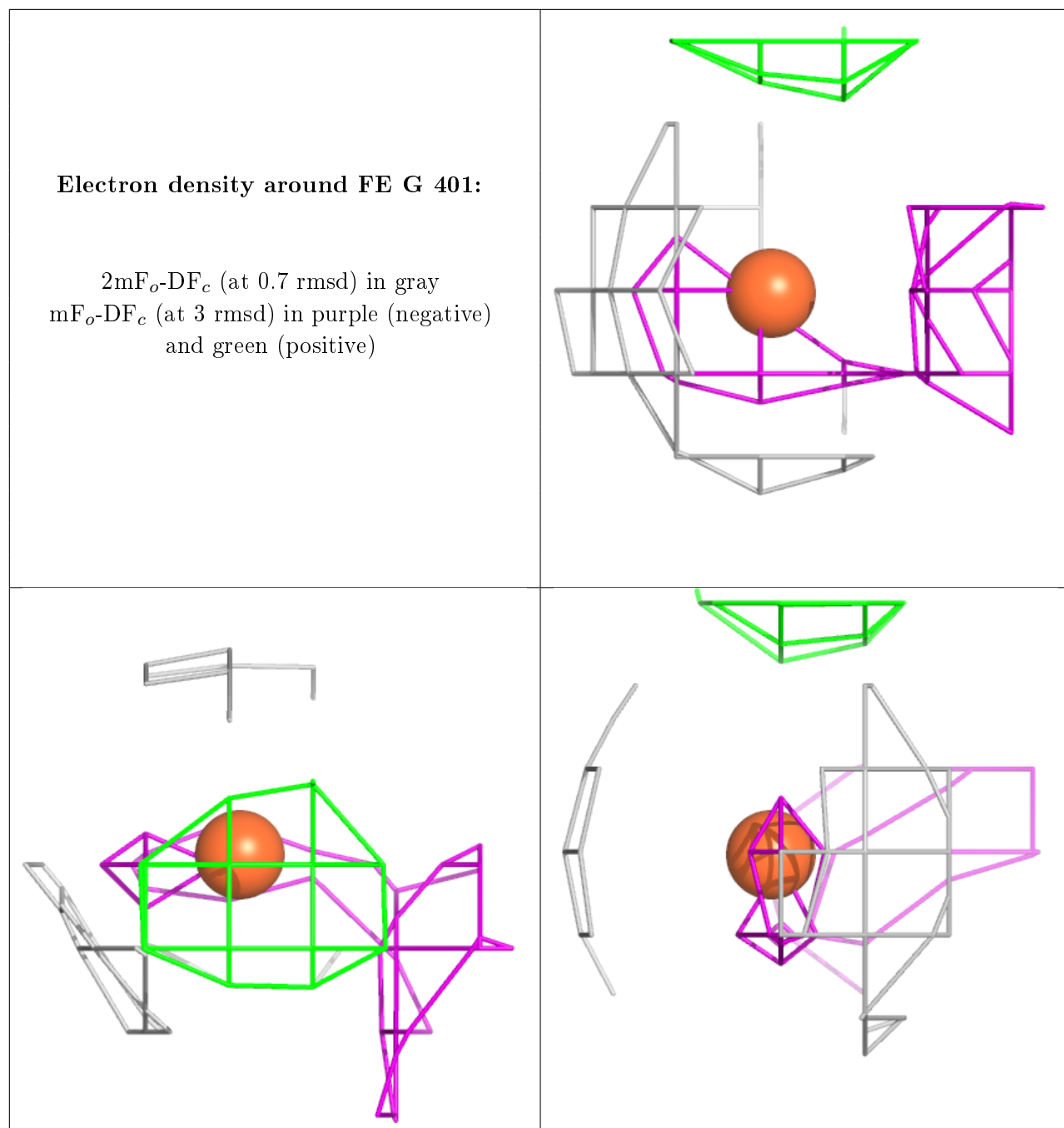

6.5 Other polymers [i](#)

There are no such residues in this entry.