



Full wwPDB X-ray Structure Validation Report ⓘ

Jun 25, 2024 – 01:11 AM EDT

PDB ID : 6ZQ4
Title : Crystal structure of Chaetomium thermophilum Glycerol Kinase in complex with substrate in P1 space group
Authors : Wilk, P.; Wator, E.; Grudnik, P.
Deposited on : 2020-07-09
Resolution : 2.02 Å(reported)

This is a Full wwPDB X-ray Structure Validation Report for a publicly released PDB entry.

We welcome your comments at validation@mail.wwpdb.org

A user guide is available at

<https://www.wwpdb.org/validation/2017/XrayValidationReportHelp>

with specific help available everywhere you see the ⓘ symbol.

The types of validation reports are described at

<http://www.wwpdb.org/validation/2017/FAQs#types>.

The following versions of software and data (see [references ⓘ](#)) were used in the production of this report:

MolProbity : 4.02b-467
Mogul : 2022.3.0, CSD as543be (2022)
Xtriage (Phenix) : 1.20.1
EDS : 2.37.1
Percentile statistics : 20191225.v01 (using entries in the PDB archive December 25th 2019)
Refmac : 5.8.0158
CCP4 : 7.0.044 (Gargrove)
Ideal geometry (proteins) : Engh & Huber (2001)
Ideal geometry (DNA, RNA) : Parkinson et al. (1996)
Validation Pipeline (wwPDB-VP) : 2.37.1

1 Overall quality at a glance

The following experimental techniques were used to determine the structure:

X-RAY DIFFRACTION

The reported resolution of this entry is 2.02 Å.

Percentile scores (ranging between 0-100) for global validation metrics of the entry are shown in the following graphic. The table shows the number of entries on which the scores are based.

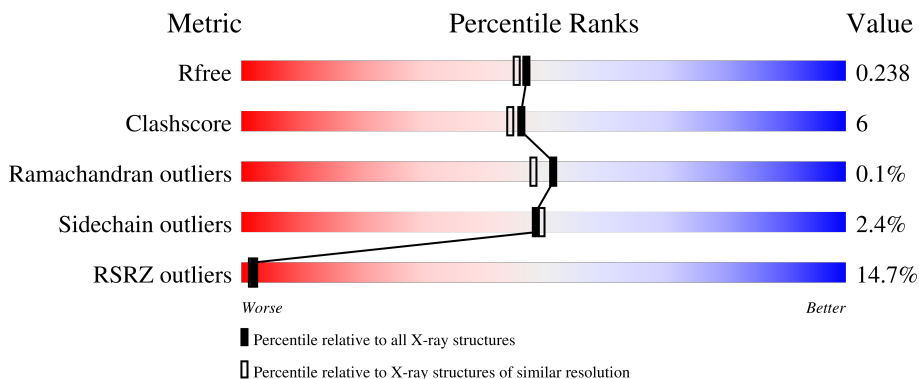

Metric	Whole archive (#Entries)	Similar resolution (#Entries, resolution range(Å))
R_{free}	130704	10434 (2.04-2.00)
Clashscore	141614	11643 (2.04-2.00)
Ramachandran outliers	138981	11493 (2.04-2.00)
Sidechain outliers	138945	11492 (2.04-2.00)
RSRZ outliers	127900	10220 (2.04-2.00)

The table below summarises the geometric issues observed across the polymeric chains and their fit to the electron density. The red, orange, yellow and green segments of the lower bar indicate the fraction of residues that contain outliers for ≥ 3 , 2, 1 and 0 types of geometric quality criteria respectively. A grey segment represents the fraction of residues that are not modelled. The numeric value for each fraction is indicated below the corresponding segment, with a dot representing fractions $\leq 5\%$. The upper red bar (where present) indicates the fraction of residues that have poor fit to the electron density. The numeric value is given above the bar.

Mol	Chain	Length	Quality of chain
1	A	526	
1	B	526	
1	C	526	
1	D	526	
1	E	526	

Continued on next page...

Continued from previous page...

Mol	Chain	Length	Quality of chain
1	F	526	
1	G	526	
1	H	526	

The following table lists non-polymeric compounds, carbohydrate monomers and non-standard residues in protein, DNA, RNA chains that are outliers for geometric or electron-density-fit criteria:

Mol	Type	Chain	Res	Chirality	Geometry	Clashes	Electron density
2	PO4	A	601	-	-	X	-

2 Entry composition i

There are 4 unique types of molecules in this entry. The entry contains 63968 atoms, of which 30941 are hydrogens and 0 are deuteriums.

In the tables below, the ZeroOcc column contains the number of atoms modelled with zero occupancy, the AltConf column contains the number of residues with at least one atom in alternate conformation and the Trace column contains the number of residues modelled with at most 2 atoms.

- Molecule 1 is a protein called Glycerol kinase-like protein.

Mol	Chain	Residues	Atoms						ZeroOcc	AltConf	Trace
			Total	C	H	N	O	S			
1	A	510	7817	2485	3890	681	745	16	0	4	0
1	B	510	7773	2472	3868	677	740	16	0	1	0
1	C	509	7748	2466	3854	673	739	16	0	0	0
1	D	509	7745	2465	3852	673	739	16	0	0	0
1	E	511	7762	2470	3860	675	741	16	0	0	0
1	F	512	7776	2474	3866	677	743	16	0	0	0
1	G	512	7777	2474	3867	677	743	16	0	0	0
1	H	511	7762	2470	3860	675	741	16	0	0	0

There are 16 discrepancies between the modelled and reference sequences:

Chain	Residue	Modelled	Actual	Comment	Reference
A	65	GLY	-	expression tag	UNP G0SAG9
A	66	SER	-	expression tag	UNP G0SAG9
B	65	GLY	-	expression tag	UNP G0SAG9
B	66	SER	-	expression tag	UNP G0SAG9
C	65	GLY	-	expression tag	UNP G0SAG9
C	66	SER	-	expression tag	UNP G0SAG9
D	65	GLY	-	expression tag	UNP G0SAG9
D	66	SER	-	expression tag	UNP G0SAG9
E	65	GLY	-	expression tag	UNP G0SAG9
E	66	SER	-	expression tag	UNP G0SAG9
F	65	GLY	-	expression tag	UNP G0SAG9
F	66	SER	-	expression tag	UNP G0SAG9
G	65	GLY	-	expression tag	UNP G0SAG9

Continued on next page...

Continued from previous page...

Chain	Residue	Modelled	Actual	Comment	Reference
G	66	SER	-	expression tag	UNP G0SAG9
H	65	GLY	-	expression tag	UNP G0SAG9
H	66	SER	-	expression tag	UNP G0SAG9

- Molecule 2 is PHOSPHATE ION (three-letter code: PO4) (formula: O₄P).

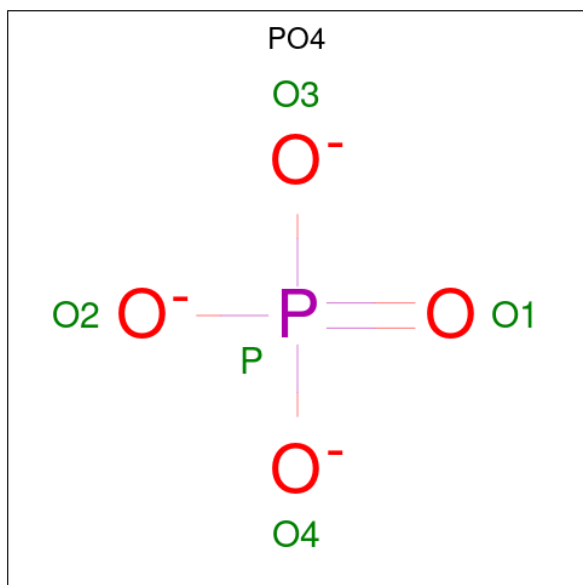

Mol	Chain	Residues	Atoms	ZeroOcc	AltConf
2	A	1	Total O P 5 4 1	0	0
2	B	1	Total O P 5 4 1	0	0
2	C	1	Total O P 5 4 1	0	0
2	D	1	Total O P 5 4 1	0	0
2	E	1	Total O P 5 4 1	0	0
2	F	1	Total O P 5 4 1	0	0

- Molecule 3 is GLYCEROL (three-letter code: GOL) (formula: C₃H₈O₃).



Mol	Chain	Residues	Atoms			ZeroOcc	AltConf	
3	A	1	Total	C	H	O	0	0
			9	3	3	3		
3	B	1	Total	C	H	O	0	0
			9	3	3	3		
3	C	1	Total	C	H	O	0	0
			9	3	3	3		
3	D	1	Total	C	H	O	0	0
			9	3	3	3		
3	E	1	Total	C	H	O	0	0
			9	3	3	3		
3	F	1	Total	C	H	O	0	0
			9	3	3	3		
3	G	1	Total	C	H	O	0	0
			9	3	3	3		
3	H	1	Total	C	H	O	0	0
			9	3	3	3		

- Molecule 4 is water.

Mol	Chain	Residues	Atoms		ZeroOcc	AltConf
4	A	192	Total	O	0	0
			192	192		
4	B	276	Total	O	0	0
			276	276		
4	C	243	Total	O	0	0
			243	243		
4	D	208	Total	O	0	0
			208	208		

Continued on next page...

Continued from previous page...

Mol	Chain	Residues	Atoms		ZeroOcc	AltConf
4	E	220	Total 220	O 220	0	0
4	F	234	Total 234	O 234	0	0
4	G	186	Total 186	O 186	0	0
4	H	147	Total 147	O 147	0	0

3 Residue-property plots [i](#)

These plots are drawn for all protein, RNA, DNA and oligosaccharide chains in the entry. The first graphic for a chain summarises the proportions of the various outlier classes displayed in the second graphic. The second graphic shows the sequence view annotated by issues in geometry and electron density. Residues are color-coded according to the number of geometric quality criteria for which they contain at least one outlier: green = 0, yellow = 1, orange = 2 and red = 3 or more. A red dot above a residue indicates a poor fit to the electron density ($RSRZ > 2$). Stretches of 2 or more consecutive residues without any outlier are shown as a green connector. Residues present in the sample, but not in the model, are shown in grey.

• Molecule 1: Glycerol kinase-like protein

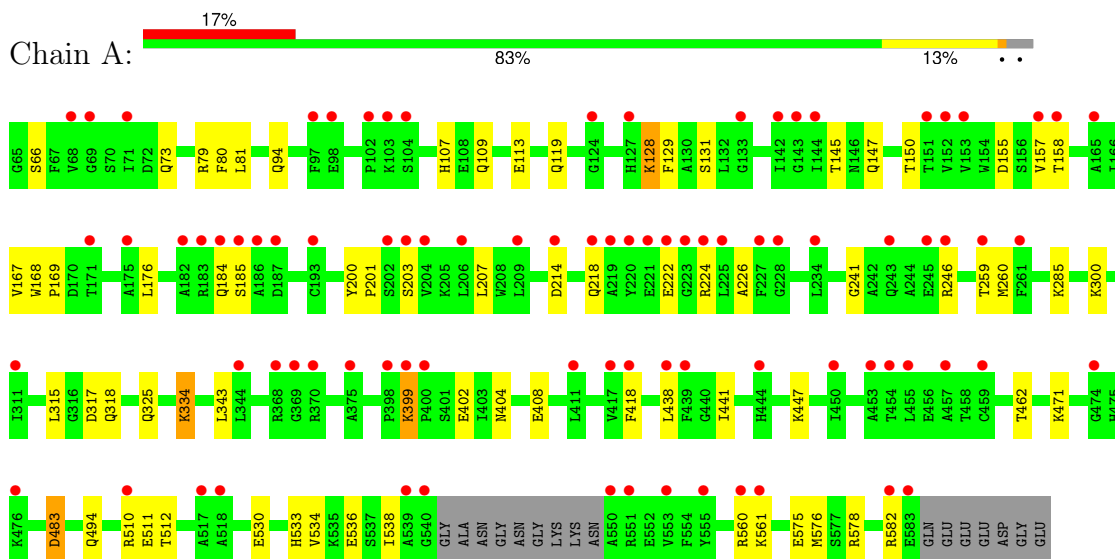

• Molecule 1: Glycerol kinase-like protein

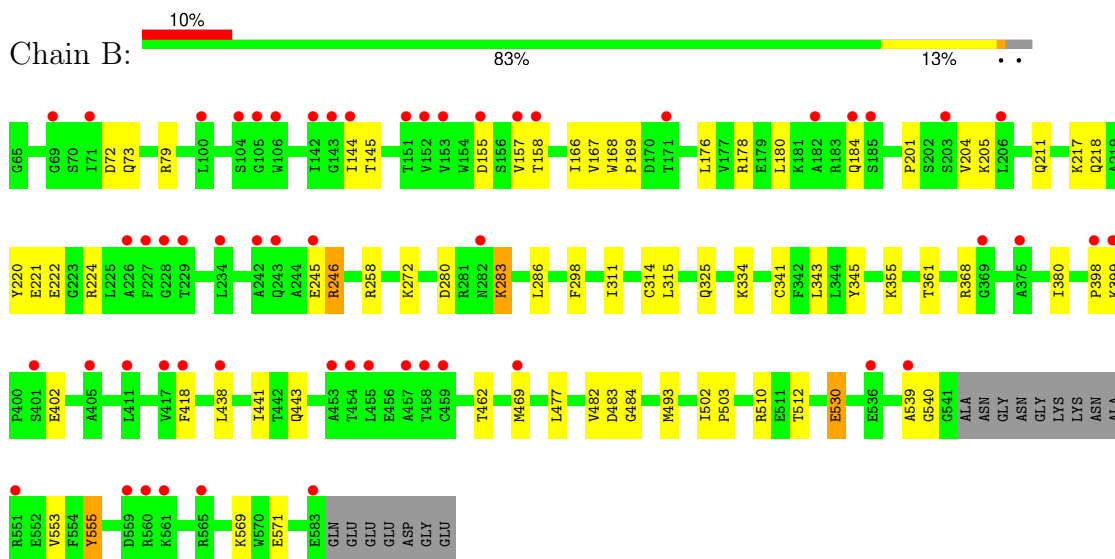

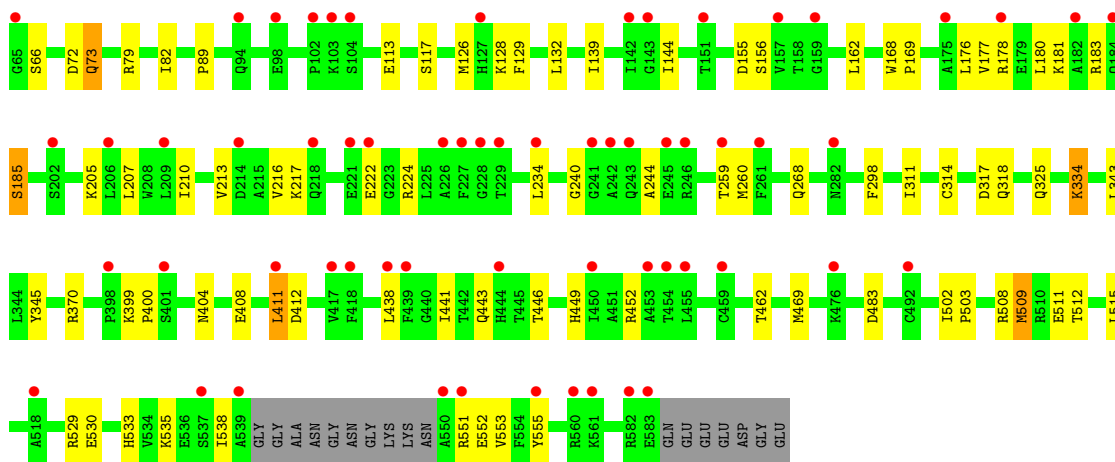
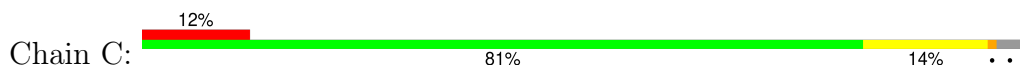

• Molecule 1: Glycerol kinase-like protein

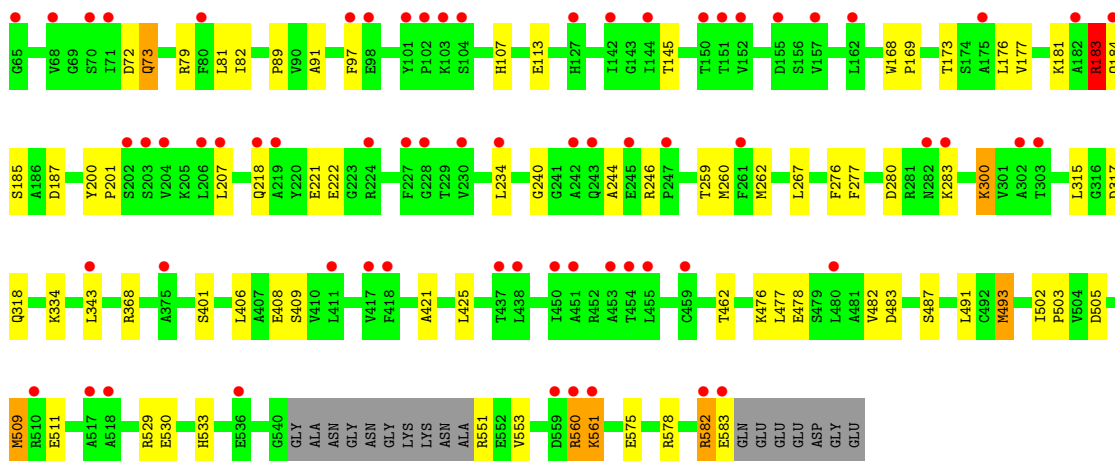
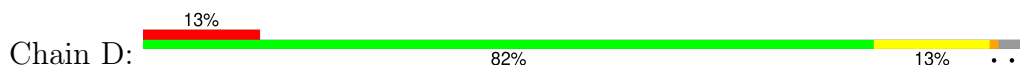

• Molecule 1: Glycerol kinase-like protein

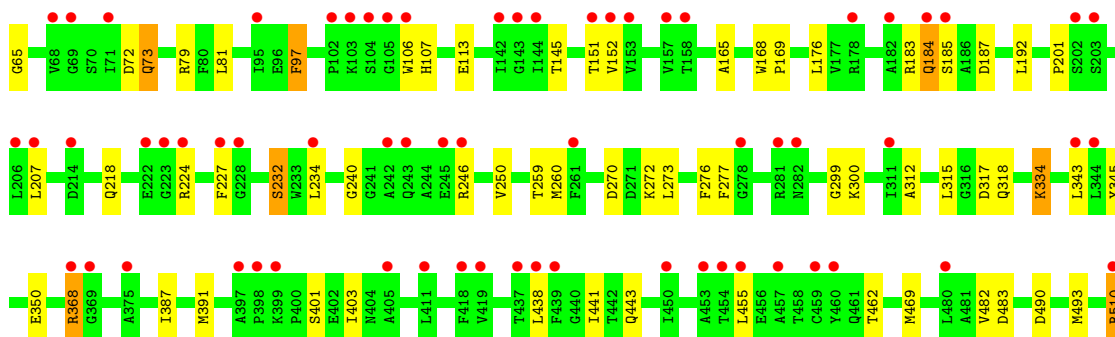
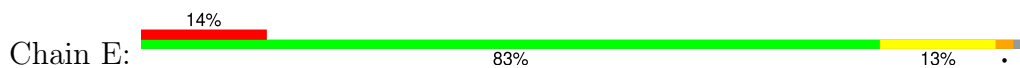

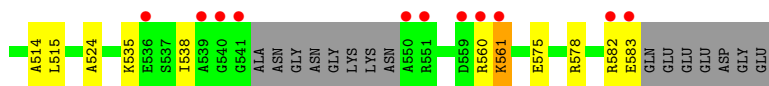

• Molecule 1: Glycerol kinase-like protein

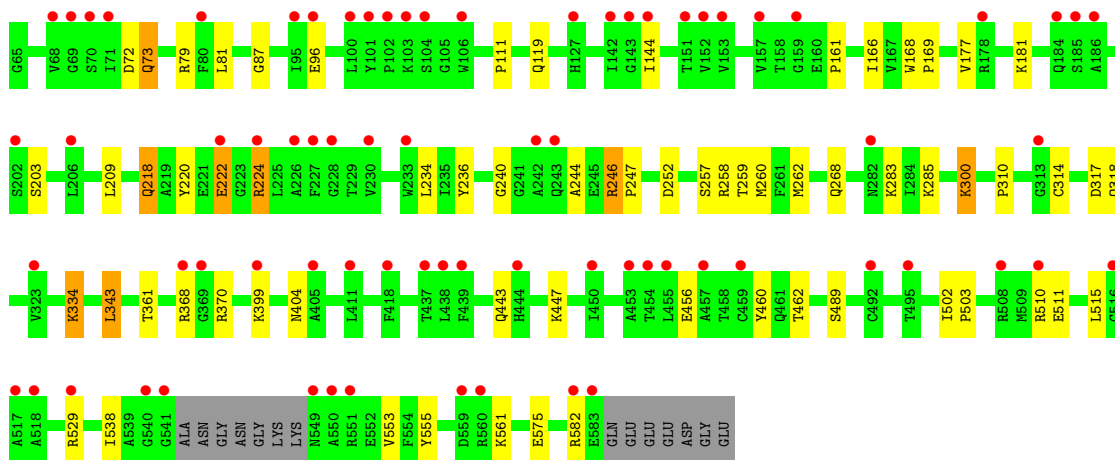
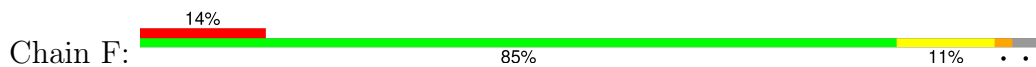

• Molecule 1: Glycerol kinase-like protein

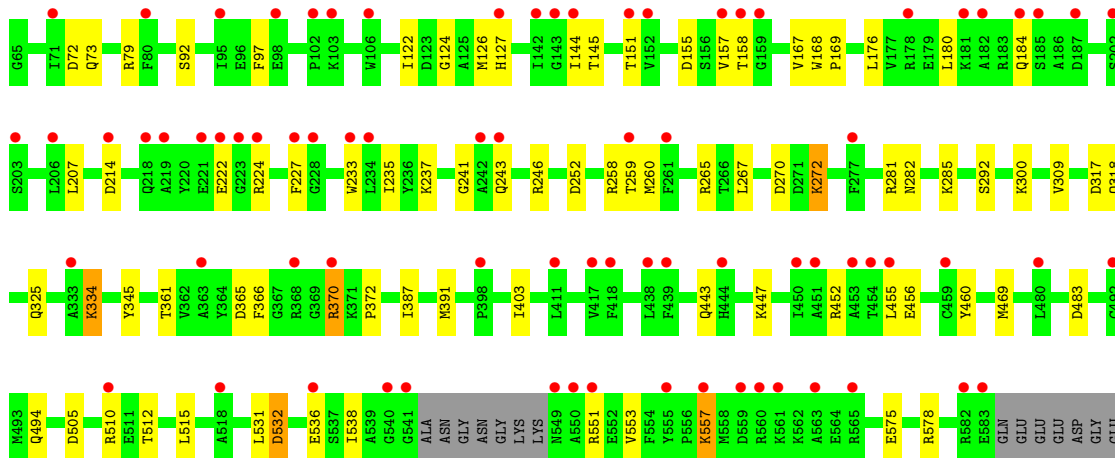
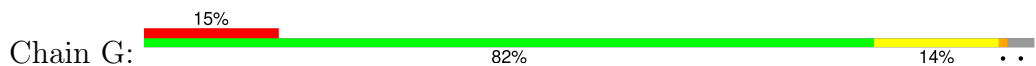

• Molecule 1: Glycerol kinase-like protein

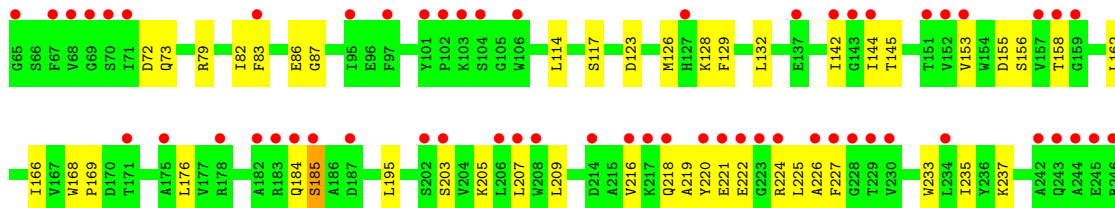
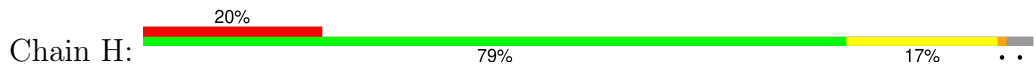

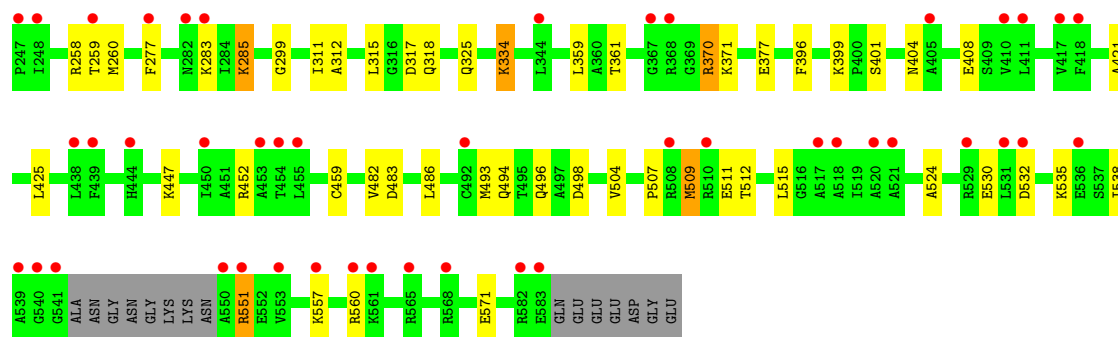

4 Data and refinement statistics

Property	Value	Source
Space group	P 1	Depositor
Cell constants a, b, c, α , β , γ	61.38Å 112.82Å 179.54Å 85.77° 90.04° 85.45°	Depositor
Resolution (Å)	23.01 – 2.02 23.01 – 2.02	Depositor EDS
% Data completeness (in resolution range)	97.3 (23.01-2.02) 97.4 (23.01-2.02)	Depositor EDS
R_{merge}	0.22	Depositor
R_{sym}	(Not available)	Depositor
$\langle I/\sigma(I) \rangle$ ¹	0.96 (at 2.01Å)	Xtrriage
Refinement program	PHENIX 1.17.1_3660	Depositor
R, R_{free}	0.205 , 0.240 0.206 , 0.238	Depositor DCC
R_{free} test set	3228 reflections (1.05%)	wwPDB-VP
Wilson B-factor (Å ²)	36.8	Xtrriage
Anisotropy	0.218	Xtrriage
Bulk solvent k_{sol} (e/Å ³), B_{sol} (Å ²)	0.42 , 55.2	EDS
L-test for twinning ²	$\langle L \rangle = 0.46$, $\langle L^2 \rangle = 0.29$	Xtrriage
Estimated twinning fraction	No twinning to report.	Xtrriage
F_o, F_c correlation	0.95	EDS
Total number of atoms	63968	wwPDB-VP
Average B, all atoms (Å ²)	57.0	wwPDB-VP

Xtrriage's analysis on translational NCS is as follows: *The largest off-origin peak in the Patterson function is 5.81% of the height of the origin peak. No significant pseudotranslation is detected.*

¹Intensities estimated from amplitudes.

²Theoretical values of $\langle |L| \rangle$, $\langle L^2 \rangle$ for acentric reflections are 0.5, 0.333 respectively for untwinned datasets, and 0.375, 0.2 for perfectly twinned datasets.

5 Model quality i

5.1 Standard geometry i

Bond lengths and bond angles in the following residue types are not validated in this section: GOL, PO4

The Z score for a bond length (or angle) is the number of standard deviations the observed value is removed from the expected value. A bond length (or angle) with $|Z| > 5$ is considered an outlier worth inspection. RMSZ is the root-mean-square of all Z scores of the bond lengths (or angles).

Mol	Chain	Bond lengths		Bond angles	
		RMSZ	# Z >5	RMSZ	# Z >5
1	A	0.49	3/4018 (0.1%)	0.76	7/5445 (0.1%)
1	B	0.56	10/3990 (0.3%)	0.61	3/5407 (0.1%)
1	C	0.41	2/3976 (0.1%)	0.63	6/5390 (0.1%)
1	D	0.38	2/3975 (0.1%)	0.56	5/5388 (0.1%)
1	E	0.48	4/3984 (0.1%)	0.62	9/5400 (0.2%)
1	F	0.51	5/3992 (0.1%)	0.65	12/5411 (0.2%)
1	G	0.40	2/3992 (0.1%)	0.60	3/5411 (0.1%)
1	H	0.40	2/3984 (0.1%)	0.59	5/5400 (0.1%)
All	All	0.46	30/31911 (0.1%)	0.63	50/43252 (0.1%)

Chiral center outliers are detected by calculating the chiral volume of a chiral center and verifying if the center is modelled as a planar moiety or with the opposite hand. A planarity outlier is detected by checking planarity of atoms in a peptide group, atoms in a mainchain group or atoms of a sidechain that are expected to be planar.

Mol	Chain	#Chirality outliers	#Planarity outliers
1	B	0	2
1	E	0	1
All	All	0	3

All (30) bond length outliers are listed below:

Mol	Chain	Res	Type	Atoms	Z	Observed(Å)	Ideal(Å)
1	B	399	LYS	CE-NZ	-14.32	1.13	1.49
1	A	399	LYS	CE-NZ	-11.96	1.19	1.49
1	E	300	LYS	CD-CE	-11.53	1.22	1.51
1	D	246	ARG	C-N	10.58	1.54	1.34
1	A	582	ARG	CZ-NH1	10.35	1.46	1.33
1	B	246	ARG	C-N	9.98	1.53	1.34
1	F	246	ARG	C-N	9.93	1.53	1.34
1	A	246	ARG	C-N	9.92	1.53	1.34

Continued on next page...

Continued from previous page...

Mol	Chain	Res	Type	Atoms	Z	Observed(Å)	Ideal(Å)
1	C	551	ARG	CG-CD	-9.81	1.27	1.51
1	F	222	GLU	CB-CG	9.50	1.70	1.52
1	B	286	LEU	C-N	9.27	1.51	1.34
1	H	371	LYS	C-N	9.26	1.51	1.34
1	G	285	LYS	CB-CG	-9.03	1.28	1.52
1	F	222	GLU	CD-OE2	8.71	1.35	1.25
1	E	300	LYS	CE-NZ	-8.47	1.27	1.49
1	E	510	ARG	CG-CD	8.32	1.72	1.51
1	B	399	LYS	CD-CE	-8.28	1.30	1.51
1	F	96	GLU	CG-CD	7.27	1.62	1.51
1	C	551	ARG	CZ-NH1	6.84	1.42	1.33
1	B	283	LYS	CB-CG	-6.80	1.34	1.52
1	F	300	LYS	CB-CG	-6.54	1.34	1.52
1	B	555	TYR	CE1-CZ	-6.36	1.30	1.38
1	G	285	LYS	CG-CD	-6.29	1.31	1.52
1	B	283	LYS	CD-CE	6.03	1.66	1.51
1	H	285	LYS	C-N	5.87	1.47	1.34
1	B	530	GLU	CD-OE2	-5.61	1.19	1.25
1	D	183	ARG	CB-CG	-5.50	1.37	1.52
1	B	555	TYR	CG-CD2	-5.49	1.32	1.39
1	B	555	TYR	CG-CD1	-5.31	1.32	1.39
1	E	510	ARG	CB-CG	5.09	1.66	1.52

All (50) bond angle outliers are listed below:

Mol	Chain	Res	Type	Atoms	Z	Observed(°)	Ideal(°)
1	A	582	ARG	NE-CZ-NH1	24.70	132.65	120.30
1	A	582	ARG	NE-CZ-NH2	-18.43	111.09	120.30
1	C	411	LEU	CB-CG-CD1	13.55	134.04	111.00
1	C	411	LEU	CB-CG-CD2	-10.97	92.36	111.00
1	A	399	LYS	CA-CB-CG	10.54	136.60	113.40
1	F	222	GLU	OE1-CD-OE2	10.13	135.46	123.30
1	C	551	ARG	NE-CZ-NH1	9.62	125.11	120.30
1	A	510	ARG	CA-CB-CG	9.38	134.04	113.40
1	F	582	ARG	NE-CZ-NH2	-9.12	115.74	120.30
1	G	272	LYS	CD-CE-NZ	-8.92	91.18	111.70
1	G	285	LYS	CG-CD-CE	8.50	137.39	111.90
1	E	510	ARG	CB-CG-CD	8.22	132.98	111.60
1	F	218	GLN	CA-CB-CG	7.93	130.85	113.40
1	B	399	LYS	CD-CE-NZ	7.85	129.76	111.70
1	B	272	LYS	CA-CB-CG	-7.67	96.52	113.40
1	F	510	ARG	NE-CZ-NH1	-7.37	116.61	120.30

Continued on next page...

Continued from previous page...

Mol	Chain	Res	Type	Atoms	Z	Observed(°)	Ideal(°)
1	D	183	ARG	NE-CZ-NH1	-7.34	116.63	120.30
1	F	582	ARG	CB-CG-CD	-7.26	92.72	111.60
1	A	399	LYS	CB-CG-CD	-7.20	92.87	111.60
1	H	128	LYS	CB-CG-CD	7.05	129.93	111.60
1	C	551	ARG	NE-CZ-NH2	-6.96	116.82	120.30
1	E	224	ARG	NE-CZ-NH2	-6.96	116.82	120.30
1	H	509	MET	CA-CB-CG	-6.71	101.90	113.30
1	E	510	ARG	NE-CZ-NH2	6.62	123.61	120.30
1	F	222	GLU	CG-CD-OE2	-6.52	105.27	118.30
1	F	582	ARG	CA-CB-CG	6.40	127.48	113.40
1	C	411	LEU	CA-CB-CG	-6.28	100.85	115.30
1	D	183	ARG	NE-CZ-NH2	6.04	123.32	120.30
1	A	582	ARG	CG-CD-NE	5.99	124.38	111.80
1	D	561	LYS	CD-CE-NZ	5.97	125.44	111.70
1	B	272	LYS	CG-CD-CE	5.91	129.64	111.90
1	F	582	ARG	NE-CZ-NH1	5.90	123.25	120.30
1	E	187	ASP	CB-CG-OD2	-5.76	113.12	118.30
1	E	561	LYS	CD-CE-NZ	5.71	124.84	111.70
1	F	224	ARG	CD-NE-CZ	5.66	131.53	123.60
1	E	300	LYS	CB-CG-CD	5.54	126.01	111.60
1	A	128	LYS	CD-CE-NZ	-5.52	98.99	111.70
1	E	510	ARG	CA-CB-CG	5.45	125.39	113.40
1	D	300	LYS	CD-CE-NZ	5.43	124.18	111.70
1	E	561	LYS	CB-CG-CD	5.39	125.62	111.60
1	F	285	LYS	CD-CE-NZ	-5.39	99.30	111.70
1	F	399	LYS	CA-CB-CG	5.24	124.93	113.40
1	H	260	MET	N-CA-CB	5.20	119.96	110.60
1	H	401	SER	N-CA-CB	5.19	118.28	110.50
1	F	222	GLU	CB-CG-CD	5.18	128.19	114.20
1	H	285	LYS	CA-CB-CG	5.13	124.68	113.40
1	E	561	LYS	CG-CD-CE	-5.08	96.66	111.90
1	C	185	SER	N-CA-CB	5.08	118.12	110.50
1	G	97	PHE	CB-CG-CD2	-5.07	117.25	120.80
1	D	561	LYS	CA-CB-CG	5.01	124.42	113.40

There are no chirality outliers.

All (3) planarity outliers are listed below:

Mol	Chain	Res	Type	Group
1	B	539	ALA	Peptide
1	B	540	GLY	Peptide
1	E	510	ARG	Sidechain

5.2 Too-close contacts [i](#)

In the following table, the Non-H and H(model) columns list the number of non-hydrogen atoms and hydrogen atoms in the chain respectively. The H(added) column lists the number of hydrogen atoms added and optimized by MolProbity. The Clashes column lists the number of clashes within the asymmetric unit, whereas Symm-Clashes lists symmetry-related clashes.

Mol	Chain	Non-H	H(model)	H(added)	Clashes	Symm-Clashes
1	A	3927	3890	3881	40	0
1	B	3905	3868	3868	42	1
1	C	3894	3854	3854	55	0
1	D	3893	3852	3852	51	0
1	E	3902	3860	3860	49	0
1	F	3910	3866	3866	43	0
1	G	3910	3867	3866	45	1
1	H	3902	3860	3860	74	0
2	A	5	0	0	2	0
2	B	5	0	0	0	0
2	C	5	0	0	0	0
2	D	5	0	0	1	0
2	E	5	0	0	0	0
2	F	5	0	0	0	0
3	A	6	3	8	0	0
3	B	6	3	8	0	0
3	C	6	3	8	0	0
3	D	6	3	8	0	0
3	E	6	3	8	0	0
3	F	6	3	8	0	0
3	G	6	3	8	0	0
3	H	6	3	8	0	0
4	A	192	0	0	7	0
4	B	276	0	0	6	0
4	C	243	0	0	9	0
4	D	208	0	0	6	0
4	E	220	0	0	10	0
4	F	234	0	0	7	0
4	G	186	0	0	4	0
4	H	147	0	0	7	0
All	All	33027	30941	30971	395	1

The all-atom clashscore is defined as the number of clashes found per 1000 atoms (including hydrogen atoms). The all-atom clashscore for this structure is 6.

All (395) close contacts within the same asymmetric unit are listed below, sorted by their clash magnitude.

Atom-1	Atom-2	Interatomic distance (Å)	Clash overlap (Å)
1:H:482:VAL:HG11	1:H:493:MET:HE1	1.27	1.12
1:B:221:GLU:OE1	1:B:283:LYS:NZ	1.94	1.01
1:D:183:ARG:NH2	1:D:276:PHE:O	1.95	0.98
1:B:221:GLU:HA	1:B:283:LYS:HE2	1.49	0.95
1:A:119:GLN:OE1	4:A:701:HOH:O	1.86	0.93
1:D:583:GLU:OE2	4:D:701:HOH:O	1.93	0.86
1:C:509:MET:HE1	1:C:511:GLU:HB2	1.58	0.86
1:H:216:VAL:HG13	1:H:225:LEU:HD11	1.60	0.83
1:B:571:GLU:OE2	4:B:701:HOH:O	2.01	0.79
1:E:107:HIS:ND1	4:E:704:HOH:O	2.15	0.79
1:A:536:GLU:OE2	4:A:702:HOH:O	2.01	0.79
1:H:216:VAL:HG13	1:H:225:LEU:CD1	2.14	0.78
1:D:509:MET:HE1	1:D:511:GLU:HB2	1.66	0.77
1:E:207:LEU:HD13	1:E:277:PHE:O	1.86	0.75
1:E:490:ASP:OD2	4:E:701:HOH:O	2.05	0.75
1:D:184:GLN:O	1:D:185:SER:OG	2.05	0.75
1:B:258:ARG:HH11	1:B:361:THR:HG21	1.51	0.74
1:C:370:ARG:NH1	4:C:703:HOH:O	2.18	0.74
1:H:226:ALA:HA	1:H:285:LYS:HB2	1.69	0.74
1:G:447:LYS:NZ	4:G:703:HOH:O	2.20	0.74
1:F:575:GLU:OE1	4:F:701:HOH:O	2.04	0.74
1:A:113:GLU:OE2	4:A:703:HOH:O	2.06	0.73
1:C:399:LYS:HE2	1:C:400:PRO:HD2	1.70	0.73
1:F:258:ARG:HH11	1:F:361:THR:HG21	1.53	0.73
1:F:236:TYR:O	1:F:240:GLY:O	2.06	0.73
1:H:493:MET:CE	1:H:504:VAL:HG11	2.19	0.72
1:E:65:GLY:N	4:E:706:HOH:O	2.22	0.72
1:E:232:SER:OG	1:E:250:VAL:O	2.06	0.72
1:C:483:ASP:OD1	4:C:701:HOH:O	2.08	0.71
1:D:551:ARG:NH1	4:D:704:HOH:O	2.23	0.71
1:E:246:ARG:HH22	1:E:299:GLY:HA2	1.56	0.70
1:G:258:ARG:HH11	1:G:361:THR:HG21	1.56	0.70
1:B:280:ASP:HB3	1:B:283:LYS:HB2	1.74	0.70
1:F:443:GLN:NE2	4:F:702:HOH:O	2.25	0.70
1:G:258:ARG:NH1	1:G:361:THR:HG21	2.06	0.69
1:C:240:GLY:O	1:C:244:ALA:HB2	1.92	0.69
1:B:155:ASP:OD2	1:B:224:ARG:NH1	2.26	0.69
1:B:280:ASP:OD1	4:B:702:HOH:O	2.10	0.69
1:H:86:GLU:OE2	4:H:702:HOH:O	2.10	0.69
1:H:83:PHE:HE1	1:H:509:MET:CE	2.05	0.69
1:E:246:ARG:NH2	1:E:299:GLY:HA2	2.09	0.68
1:B:482:VAL:HG21	1:B:493:MET:SD	2.33	0.68

Continued on next page...

Continued from previous page...

Atom-1	Atom-2	Interatomic distance (Å)	Clash overlap (Å)
1:H:299:GLY:O	4:H:701:HOH:O	2.10	0.68
1:E:106:TRP:O	4:E:703:HOH:O	2.12	0.68
1:B:258:ARG:NH1	1:B:361:THR:HG21	2.09	0.67
1:F:222:GLU:CB	1:F:224:ARG:NH1	2.57	0.67
1:E:350:GLU:OE2	4:E:702:HOH:O	2.12	0.67
1:H:482:VAL:CG1	1:H:493:MET:HE1	2.17	0.67
1:B:343:LEU:HD21	1:B:462:THR:HG23	1.76	0.67
1:H:532:ASP:OD2	4:H:703:HOH:O	2.12	0.66
1:B:477:LEU:HG	1:B:502:ILE:HD13	1.77	0.66
1:A:483:ASP:OD1	4:A:704:HOH:O	2.13	0.65
1:C:132:LEU:HD22	1:H:132:LEU:HD22	1.78	0.65
1:G:483:ASP:OD1	4:G:701:HOH:O	2.14	0.65
1:C:268:GLN:NE2	4:C:706:HOH:O	2.29	0.65
1:C:412:ASP:OD1	4:C:702:HOH:O	2.14	0.65
1:D:343:LEU:HD21	1:D:462:THR:HG23	1.79	0.65
1:H:258:ARG:HH11	1:H:361:THR:HG21	1.62	0.65
1:F:515:LEU:HD21	1:F:538:ILE:HD12	1.78	0.64
1:G:222:GLU:OE1	1:G:224:ARG:NH1	2.30	0.64
1:F:258:ARG:NH1	1:F:361:THR:HG21	2.13	0.64
1:E:240:GLY:O	4:E:705:HOH:O	2.16	0.63
1:D:107:HIS:ND1	4:D:709:HOH:O	2.30	0.63
1:A:200:TYR:CD1	2:A:601:PO4:O2	2.52	0.63
1:C:155:ASP:HB2	1:C:162:LEU:HD21	1.81	0.62
1:H:399:LYS:NZ	4:H:712:HOH:O	2.33	0.62
1:H:123:ASP:OD1	4:H:704:HOH:O	2.16	0.61
1:A:200:TYR:CG	2:A:601:PO4:O2	2.54	0.61
1:F:222:GLU:HB2	1:F:224:ARG:NH1	2.15	0.61
1:G:270:ASP:OD1	1:G:272:LYS:HB2	2.01	0.61
1:G:214:ASP:N	4:G:707:HOH:O	2.32	0.61
1:E:183:ARG:NH2	1:E:276:PHE:O	2.34	0.61
1:H:498:ASP:O	1:H:560:ARG:NH1	2.33	0.60
1:C:538:ILE:O	1:C:538:ILE:HG22	2.00	0.60
1:H:258:ARG:NH1	1:H:361:THR:HG21	2.17	0.59
1:B:325:GLN:HG2	1:B:512:THR:HG21	1.82	0.59
1:D:582:ARG:NH2	4:D:713:HOH:O	2.34	0.59
1:H:509:MET:SD	1:H:511:GLU:N	2.75	0.59
1:C:72:ASP:HB3	1:C:79:ARG:HG2	1.85	0.59
1:F:218:GLN:NE2	1:F:222:GLU:OE2	2.36	0.58
1:A:438:LEU:HD23	1:A:441:ILE:HD11	1.86	0.58
1:G:443:GLN:OE1	4:G:702:HOH:O	2.16	0.58
1:B:438:LEU:HD23	1:B:441:ILE:HD11	1.85	0.58

Continued on next page...

Continued from previous page...

Atom-1	Atom-2	Interatomic distance (Å)	Clash overlap (Å)
1:C:438:LEU:HD23	1:C:441:ILE:HD11	1.86	0.58
1:G:259:THR:O	1:G:260:MET:HB2	2.02	0.58
1:A:575:GLU:O	1:A:578:ARG:HG2	2.04	0.58
1:C:132:LEU:CD2	1:H:132:LEU:HD22	2.33	0.58
1:F:72:ASP:HB3	1:F:79:ARG:HG2	1.87	0.57
1:H:184:GLN:O	1:H:185:SER:HB2	2.04	0.57
1:E:515:LEU:HD21	1:E:538:ILE:HD13	1.87	0.57
1:E:535:LYS:NZ	4:E:712:HOH:O	2.30	0.57
1:A:214:ASP:O	1:A:218:GLN:HB2	2.05	0.57
1:B:398:PRO:HD2	1:B:402:GLU:OE1	2.05	0.57
1:H:482:VAL:HG21	1:H:493:MET:CE	2.35	0.56
1:C:259:THR:O	1:C:260:MET:HB2	2.04	0.56
1:H:571:GLU:OE2	4:H:705:HOH:O	2.17	0.56
1:D:575:GLU:O	1:D:578:ARG:HG2	2.06	0.56
1:H:494:GLN:HG2	1:H:557:LYS:HZ1	1.71	0.56
1:B:502:ILE:HG13	1:B:503:PRO:HD2	1.87	0.56
1:E:443:GLN:NE2	4:E:711:HOH:O	2.29	0.56
1:A:81:LEU:HD21	1:A:511:GLU:HG3	1.88	0.56
1:H:493:MET:HE3	1:H:504:VAL:HG11	1.87	0.56
1:B:355:LYS:NZ	4:B:708:HOH:O	2.34	0.55
1:H:482:VAL:HG21	1:H:493:MET:HE2	1.87	0.55
1:D:176:LEU:HD23	1:D:176:LEU:O	2.07	0.55
1:E:259:THR:O	1:E:260:MET:HB2	2.07	0.55
1:E:482:VAL:HG21	1:E:493:MET:SD	2.47	0.55
1:A:447:LYS:NZ	4:A:714:HOH:O	2.39	0.55
1:E:575:GLU:O	1:E:578:ARG:HG2	2.07	0.55
1:C:515:LEU:HD21	1:C:538:ILE:HD13	1.89	0.55
1:D:82:ILE:HD12	1:D:91:ALA:HB3	1.89	0.55
1:A:343:LEU:HD21	1:A:462:THR:HG23	1.88	0.54
1:C:89:PRO:HD3	1:C:509:MET:HE3	1.89	0.54
1:D:81:LEU:HD23	1:D:89:PRO:HB3	1.89	0.54
1:G:532:ASP:O	1:G:536:GLU:HG2	2.07	0.54
1:A:128:LYS:O	1:A:129:PHE:C	2.44	0.54
1:B:184:GLN:HA	1:B:184:GLN:OE1	2.07	0.54
1:A:530:GLU:HG2	1:A:533:HIS:H	1.73	0.54
1:C:213:VAL:HB	1:C:216:VAL:HG22	1.89	0.54
1:D:72:ASP:HB3	1:D:79:ARG:HG2	1.90	0.54
1:H:155:ASP:CG	1:H:158:THR:HG23	2.28	0.54
1:C:535:LYS:CE	4:C:742:HOH:O	2.55	0.54
1:E:184:GLN:O	1:E:185:SER:HB2	2.08	0.54
1:B:484:GLY:HA2	1:B:510:ARG:HH12	1.73	0.54

Continued on next page...

Continued from previous page...

Atom-1	Atom-2	Interatomic distance (Å)	Clash overlap (Å)
1:E:151:THR:HG23	1:E:227:PHE:CE1	2.42	0.54
1:H:219:ALA:O	1:H:224:ARG:N	2.40	0.54
1:B:246:ARG:O	1:B:246:ARG:HG2	2.08	0.53
1:F:259:THR:O	1:F:260:MET:HB2	2.09	0.53
1:C:177:VAL:HG12	1:C:181:LYS:HD2	1.90	0.53
1:C:529:ARG:HH21	1:C:529:ARG:HG3	1.74	0.53
1:A:317:ASP:OD1	1:A:318:GLN:N	2.41	0.53
1:C:535:LYS:HE3	4:C:742:HOH:O	2.08	0.53
1:E:192:LEU:HD11	1:E:272:LYS:HD3	1.91	0.53
1:E:343:LEU:HD21	1:E:462:THR:HG23	1.90	0.53
1:B:443:GLN:OE1	4:B:703:HOH:O	2.18	0.52
1:C:210:ILE:O	1:C:217:LYS:HD2	2.09	0.52
1:E:73:GLN:HG3	1:E:234:LEU:HD11	1.91	0.52
1:F:529:ARG:HD3	1:G:370:ARG:HH21	1.74	0.52
1:H:221:GLU:HA	1:H:283:LYS:HD3	1.91	0.52
1:A:471:LYS:NZ	4:A:718:HOH:O	2.42	0.52
1:D:207:LEU:HD13	1:D:277:PHE:O	2.09	0.52
1:F:87:GLY:HA3	1:F:538:ILE:HD13	1.92	0.52
1:F:447:LYS:NZ	4:F:711:HOH:O	2.42	0.52
1:C:399:LYS:HG2	1:C:400:PRO:HD2	1.92	0.52
1:F:244:ALA:O	1:F:247:PRO:HD3	2.10	0.52
1:H:166:ILE:HD11	1:H:209:LEU:HD21	1.92	0.52
1:D:187:ASP:O	4:D:702:HOH:O	2.18	0.52
1:F:502:ILE:HG13	1:F:503:PRO:HD2	1.91	0.52
1:H:325:GLN:HG2	1:H:512:THR:HG21	1.92	0.52
1:A:222:GLU:OE2	1:A:224:ARG:NE	2.34	0.51
1:E:72:ASP:HB3	1:E:79:ARG:CG	2.40	0.51
1:H:168:TRP:CG	1:H:169:PRO:HD3	2.46	0.51
1:G:575:GLU:O	1:G:578:ARG:HG2	2.11	0.51
1:D:406:LEU:HA	1:D:409:SER:OG	2.11	0.51
1:G:243:GLN:HG3	1:G:243:GLN:O	2.11	0.51
1:G:505:ASP:OD1	1:G:553:VAL:HG22	2.10	0.51
1:H:176:LEU:HD21	1:H:207:LEU:HD22	1.92	0.51
1:B:72:ASP:HB3	1:B:79:ARG:HG2	1.93	0.51
1:C:502:ILE:HG13	1:C:503:PRO:HD2	1.93	0.51
1:D:200:TYR:CD1	2:D:601:PO4:O1	2.63	0.51
1:D:280:ASP:HB3	1:D:283:LYS:HB2	1.93	0.51
1:C:508:ARG:NE	1:C:552:GLU:OE1	2.44	0.50
1:A:80:PHE:C	1:A:81:LEU:HD12	2.31	0.50
1:A:150:THR:HG23	1:A:167:VAL:HA	1.92	0.50
1:E:438:LEU:HD23	1:E:441:ILE:HD11	1.94	0.50

Continued on next page...

Continued from previous page...

Atom-1	Atom-2	Interatomic distance (Å)	Clash overlap (Å)
1:G:370:ARG:HH11	1:G:370:ARG:HG2	1.76	0.50
1:C:168:TRP:CG	1:C:169:PRO:HD3	2.47	0.50
1:E:582:ARG:O	1:E:583:GLU:CD	2.50	0.50
1:G:155:ASP:OD1	1:G:157:VAL:HG12	2.12	0.50
1:B:176:LEU:HD23	1:B:180:LEU:HG	1.93	0.49
1:A:155:ASP:OD1	1:A:157:VAL:N	2.44	0.49
1:B:221:GLU:HA	1:B:283:LYS:CE	2.33	0.49
1:E:183:ARG:HG2	1:E:184:GLN:O	2.13	0.49
1:H:155:ASP:HB2	1:H:162:LEU:HD21	1.95	0.49
1:H:494:GLN:HG2	1:H:557:LYS:NZ	2.28	0.49
1:C:180:LEU:O	1:C:183:ARG:HB2	2.13	0.49
1:D:502:ILE:HG13	1:D:503:PRO:HD2	1.95	0.49
1:F:168:TRP:CG	1:F:169:PRO:HD3	2.48	0.49
1:C:128:LYS:HD2	1:C:128:LYS:O	2.13	0.49
1:E:168:TRP:CG	1:E:169:PRO:HD3	2.48	0.48
1:D:145:THR:OG1	1:D:317:ASP:HA	2.14	0.48
1:D:240:GLY:O	1:D:244:ALA:HB2	2.14	0.48
1:A:168:TRP:CG	1:A:169:PRO:HD3	2.49	0.48
1:C:404:ASN:ND2	4:C:717:HOH:O	2.47	0.48
1:E:318:GLN:OE1	1:E:334:LYS:NZ	2.46	0.48
1:F:79:ARG:NE	4:F:713:HOH:O	2.43	0.48
1:G:168:TRP:CG	1:G:169:PRO:HD3	2.49	0.48
1:D:81:LEU:HD21	1:D:511:GLU:HG3	1.95	0.48
1:D:184:GLN:HG2	1:D:185:SER:N	2.27	0.48
1:A:530:GLU:O	1:A:534:VAL:HG23	2.14	0.48
1:H:207:LEU:HD12	1:H:277:PHE:O	2.14	0.48
1:A:155:ASP:HB3	1:A:158:THR:OG1	2.14	0.48
1:G:575:GLU:OE2	1:G:578:ARG:HD3	2.13	0.48
1:B:176:LEU:HD23	1:B:176:LEU:O	2.14	0.47
1:G:325:GLN:HG2	1:G:512:THR:HG21	1.96	0.47
1:C:222:GLU:OE2	1:C:224:ARG:NH1	2.47	0.47
1:E:151:THR:HG23	1:E:227:PHE:HE1	1.79	0.47
1:E:201:PRO:HB3	1:E:260:MET:HG3	1.96	0.47
1:F:268:GLN:NE2	4:F:707:HOH:O	2.34	0.47
1:H:515:LEU:HD21	1:H:538:ILE:HD12	1.97	0.47
1:B:168:TRP:CG	1:B:169:PRO:HD3	2.49	0.47
1:D:168:TRP:CG	1:D:169:PRO:HD3	2.50	0.47
1:F:81:LEU:HD21	1:F:511:GLU:HG3	1.96	0.47
1:D:201:PRO:HB3	1:D:260:MET:HG3	1.96	0.47
1:E:81:LEU:HD13	1:E:514:ALA:CB	2.44	0.47
1:H:220:TYR:O	1:H:283:LYS:HG2	2.14	0.47

Continued on next page...

Continued from previous page...

Atom-1	Atom-2	Interatomic distance (Å)	Clash overlap (Å)
1:A:184:GLN:O	1:A:185:SER:HB2	2.15	0.47
1:D:221:GLU:OE1	1:D:283:LYS:NZ	2.47	0.47
1:F:81:LEU:CD2	1:F:511:GLU:HG3	2.44	0.47
1:A:399:LYS:HB2	1:A:402:GLU:HG3	1.96	0.47
1:E:176:LEU:O	1:E:176:LEU:HD23	2.15	0.47
1:G:265:ARG:HG3	1:G:265:ARG:HH11	1.80	0.47
1:H:203:SER:HB3	1:H:259:THR:O	2.15	0.47
1:C:408:GLU:OE2	4:C:704:HOH:O	2.20	0.46
1:C:552:GLU:OE1	4:C:705:HOH:O	2.21	0.46
1:E:270:ASP:HB3	1:E:273:LEU:HD12	1.96	0.46
1:G:300:LYS:HB3	1:G:309:VAL:O	2.15	0.46
1:D:477:LEU:HG	1:D:502:ILE:HD13	1.96	0.46
1:B:166:ILE:HG22	1:B:205:LYS:HE3	1.97	0.46
1:G:391:MET:HG3	1:G:403:ILE:HG13	1.97	0.46
1:H:72:ASP:HB3	1:H:79:ARG:HG2	1.97	0.46
1:A:404:ASN:O	1:A:408:GLU:HG3	2.16	0.46
1:C:82:ILE:HD11	1:C:126:MET:SD	2.55	0.46
1:C:176:LEU:CD2	1:C:180:LEU:HD11	2.46	0.46
1:H:129:PHE:HA	1:H:132:LEU:HD12	1.98	0.46
1:D:145:THR:HA	1:D:315:LEU:O	2.15	0.46
1:B:201:PRO:O	1:B:204:VAL:HG22	2.16	0.46
1:A:107:HIS:CD2	1:A:167:VAL:HG21	2.51	0.46
1:F:222:GLU:OE1	1:F:224:ARG:NH1	2.47	0.46
1:G:233:TRP:CH2	1:G:237:LYS:HE2	2.51	0.46
1:H:493:MET:HE2	1:H:504:VAL:HG11	1.98	0.46
1:C:325:GLN:HG2	1:C:512:THR:HG21	1.98	0.46
1:A:109:GLN:HG3	1:A:167:VAL:CG2	2.47	0.45
1:D:262:MET:HE1	1:D:267:LEU:HD22	1.98	0.45
1:D:173:THR:O	1:D:177:VAL:HG23	2.15	0.45
1:H:114:LEU:O	1:H:117:SER:OG	2.34	0.45
1:H:318:GLN:OE1	1:H:334:LYS:NZ	2.47	0.45
1:A:534:VAL:O	1:A:538:ILE:HG12	2.16	0.45
1:D:529:ARG:HB2	1:D:530:GLU:OE2	2.16	0.45
1:F:529:ARG:HD3	1:G:370:ARG:NH2	2.31	0.45
1:B:502:ILE:HG13	1:B:503:PRO:CD	2.46	0.45
1:F:73:GLN:HG3	1:F:234:LEU:HD11	1.98	0.45
1:A:226:ALA:HA	1:A:285:LYS:HB2	1.99	0.45
1:B:218:GLN:NE2	1:B:222:GLU:OE1	2.46	0.45
1:B:220:TYR:CZ	1:B:283:LYS:HD3	2.51	0.45
1:F:119:GLN:NE2	4:F:721:HOH:O	2.48	0.45
1:H:145:THR:HA	1:H:315:LEU:O	2.16	0.45

Continued on next page...

Continued from previous page...

Atom-1	Atom-2	Interatomic distance (Å)	Clash overlap (Å)
1:E:176:LEU:HD21	1:E:207:LEU:HD23	1.98	0.45
1:E:368:ARG:N	4:E:719:HOH:O	2.42	0.45
1:G:176:LEU:HD21	1:G:207:LEU:HD23	1.98	0.45
1:B:569:LYS:HD2	1:B:569:LYS:HA	1.85	0.45
1:C:168:TRP:HA	1:C:205:LYS:HE2	1.99	0.45
1:G:167:VAL:HG12	1:G:169:PRO:HD3	1.97	0.45
1:H:483:ASP:OD1	4:H:706:HOH:O	2.20	0.45
1:H:551:ARG:HH11	1:H:551:ARG:HB3	1.80	0.45
1:D:487:SER:HA	1:D:493:MET:SD	2.56	0.45
1:H:225:LEU:O	1:H:285:LYS:HB2	2.17	0.45
1:G:317:ASP:OD1	1:G:318:GLN:N	2.50	0.45
1:H:233:TRP:CH2	1:H:237:LYS:HE2	2.52	0.45
1:D:89:PRO:HD3	1:D:509:MET:HE3	1.98	0.44
1:D:530:GLU:HG2	1:D:533:HIS:H	1.82	0.44
1:H:83:PHE:CE1	1:H:509:MET:CE	2.93	0.44
1:H:216:VAL:HG13	1:H:225:LEU:HD13	1.97	0.44
1:A:79:ARG:HD3	1:A:94:GLN:OE1	2.17	0.44
1:D:408:GLU:HG3	1:D:491:LEU:HD22	1.99	0.44
1:F:300:LYS:HB3	1:F:310:PRO:HA	1.98	0.44
1:H:87:GLY:HA3	1:H:538:ILE:HD13	1.98	0.44
1:H:153:VAL:HG21	1:H:209:LEU:HD13	1.99	0.44
1:B:553:VAL:HG11	1:B:555:TYR:CZ	2.52	0.44
1:E:207:LEU:CD1	1:E:277:PHE:O	2.62	0.44
1:C:176:LEU:HD23	1:C:180:LEU:CD1	2.47	0.44
1:D:218:GLN:O	1:D:222:GLU:HB2	2.18	0.44
1:A:318:GLN:OE1	1:A:334:LYS:NZ	2.48	0.44
1:E:97:PHE:HB2	1:E:113:GLU:CG	2.48	0.44
1:E:345:TYR:HB2	1:E:469:MET:SD	2.58	0.44
1:E:145:THR:OG1	1:E:317:ASP:HA	2.18	0.44
1:E:312:ALA:HB1	1:E:524:ALA:HB3	1.99	0.44
1:A:145:THR:HA	1:A:315:LEU:O	2.18	0.44
1:A:494:GLN:NE2	4:A:717:HOH:O	2.42	0.43
1:B:510:ARG:NH2	4:B:734:HOH:O	2.52	0.43
1:D:97:PHE:HB2	1:D:113:GLU:HG3	2.00	0.43
1:D:177:VAL:HG12	1:D:181:LYS:HD2	1.99	0.43
1:D:560:ARG:HA	1:D:560:ARG:NE	2.33	0.43
1:C:144:ILE:O	1:C:314:CYS:HA	2.18	0.43
1:D:73:GLN:HG3	1:D:234:LEU:HD11	2.00	0.43
1:G:151:THR:HG23	1:G:227:PHE:CE1	2.53	0.43
1:B:155:ASP:HB3	1:B:158:THR:OG1	2.19	0.43
1:B:298:PHE:HB2	1:B:311:ILE:O	2.18	0.43

Continued on next page...

Continued from previous page...

Atom-1	Atom-2	Interatomic distance (Å)	Clash overlap (Å)
1:G:144:ILE:HD12	1:G:235:ILE:HG13	2.00	0.43
1:B:211:GLN:OE1	4:B:704:HOH:O	2.21	0.43
1:C:113:GLU:O	1:C:117:SER:HB2	2.18	0.43
1:G:124:GLY:O	1:G:127:HIS:HB2	2.18	0.43
1:G:494:GLN:NE2	1:G:557:LYS:HG2	2.32	0.43
1:E:152:VAL:HG22	1:E:165:ALA:HB2	2.00	0.43
1:C:126:MET:HE1	1:C:129:PHE:CD2	2.53	0.43
1:D:478:GLU:OE2	4:D:703:HOH:O	2.21	0.43
1:F:502:ILE:HG13	1:F:503:PRO:CD	2.48	0.43
1:C:126:MET:HE1	1:C:139:ILE:HD11	2.01	0.43
1:F:222:GLU:HB3	1:F:224:ARG:NH1	2.32	0.43
1:E:97:PHE:CD1	1:E:97:PHE:C	2.92	0.43
1:F:166:ILE:HD11	1:F:209:LEU:HD21	2.00	0.43
1:F:317:ASP:OD1	1:F:318:GLN:N	2.51	0.43
1:H:82:ILE:HD11	1:H:126:MET:SD	2.58	0.43
1:H:144:ILE:HD12	1:H:235:ILE:HG12	2.01	0.43
1:B:345:TYR:HB2	1:B:469:MET:SD	2.59	0.43
1:E:145:THR:HA	1:E:315:LEU:O	2.19	0.43
1:C:178:ARG:HG2	1:C:178:ARG:HH11	1.84	0.42
1:C:318:GLN:OE1	1:C:334:LYS:NZ	2.47	0.42
1:F:257:SER:HA	1:F:262:MET:HE2	2.01	0.42
1:H:145:THR:OG1	1:H:317:ASP:HA	2.18	0.42
1:A:145:THR:OG1	1:A:317:ASP:HA	2.18	0.42
1:F:456:GLU:HB3	1:F:460:TYR:CE2	2.55	0.42
1:B:341:CYS:HB2	1:B:380:ILE:HB	2.02	0.42
1:F:111:PRO:HG2	1:F:161:PRO:HB3	2.01	0.42
1:G:267:LEU:HD11	1:G:372:PRO:HG2	2.00	0.42
1:H:218:GLN:O	1:H:222:GLU:HB2	2.19	0.42
1:E:72:ASP:HB3	1:E:79:ARG:HG2	2.01	0.42
1:E:387:ILE:HD11	1:E:455:LEU:CD2	2.49	0.42
1:E:391:MET:HG3	1:E:403:ILE:HG13	2.00	0.42
1:G:176:LEU:O	1:G:180:LEU:HG	2.19	0.42
1:C:446:THR:H	1:C:449:HIS:HD2	1.68	0.42
1:G:345:TYR:HB2	1:G:469:MET:SD	2.60	0.42
1:A:201:PRO:HB3	1:A:260:MET:HG3	2.02	0.42
1:C:317:ASP:OD1	1:C:318:GLN:N	2.53	0.42
1:C:343:LEU:HD21	1:C:462:THR:HG23	2.01	0.42
1:E:443:GLN:NE2	4:E:732:HOH:O	2.52	0.42
1:F:370:ARG:NH1	4:F:725:HOH:O	2.53	0.42
1:G:122:ILE:O	1:G:126:MET:HG2	2.20	0.42
1:B:167:VAL:HG12	1:B:169:PRO:HD3	2.01	0.42

Continued on next page...

Continued from previous page...

Atom-1	Atom-2	Interatomic distance (Å)	Clash overlap (Å)
1:D:482:VAL:HG11	1:D:493:MET:CE	2.50	0.42
1:D:482:VAL:HG11	1:D:493:MET:HE1	2.00	0.42
1:F:318:GLN:OE1	1:F:334:LYS:NZ	2.46	0.42
1:F:220:TYR:O	1:F:283:LYS:HG2	2.18	0.42
1:G:292:SER:N	1:G:365:ASP:O	2.52	0.42
1:H:219:ALA:HB3	1:H:225:LEU:HD13	2.02	0.42
1:D:259:THR:O	1:D:260:MET:HB2	2.19	0.42
1:H:370:ARG:HA	1:H:370:ARG:HD2	1.67	0.42
1:H:486:LEU:HD23	1:H:486:LEU:HA	1.86	0.42
1:C:156:SER:HB2	1:C:224:ARG:O	2.20	0.41
1:C:530:GLU:HG2	1:C:533:HIS:H	1.84	0.41
1:D:259:THR:O	1:D:260:MET:CB	2.68	0.41
1:G:72:ASP:HB3	1:G:79:ARG:HG2	2.02	0.41
1:H:142:ILE:HD11	1:H:311:ILE:HG12	2.00	0.41
1:H:396:PHE:HA	1:H:447:LYS:HE2	2.01	0.41
1:H:482:VAL:O	1:H:507:PRO:HD2	2.19	0.41
1:A:176:LEU:HD21	1:A:207:LEU:HD23	2.03	0.41
1:D:505:ASP:OD1	1:D:553:VAL:HG22	2.20	0.41
1:F:177:VAL:HG12	1:F:181:LYS:HD2	2.02	0.41
1:G:157:VAL:HG13	1:G:158:THR:HG23	2.02	0.41
1:H:195:LEU:HD23	1:H:359:LEU:HB3	2.02	0.41
1:H:222:GLU:OE1	1:H:224:ARG:HD2	2.19	0.41
1:H:312:ALA:HB1	1:H:524:ALA:HB3	2.02	0.41
1:A:325:GLN:HG2	1:A:512:THR:HG21	2.02	0.41
1:G:387:ILE:HD11	1:G:455:LEU:HD23	2.02	0.41
1:H:535:LYS:HE3	1:H:535:LYS:HB3	1.78	0.41
1:C:178:ARG:HG2	1:C:178:ARG:NH1	2.34	0.41
1:E:259:THR:O	1:E:260:MET:CB	2.69	0.41
1:F:259:THR:O	1:F:260:MET:CB	2.68	0.41
1:A:203:SER:HB3	1:A:259:THR:O	2.21	0.41
1:C:345:TYR:HB2	1:C:469:MET:SD	2.60	0.41
1:F:144:ILE:O	1:F:314:CYS:HA	2.21	0.41
1:G:145:THR:OG1	1:G:317:ASP:HA	2.20	0.41
1:H:207:LEU:CD1	1:H:277:PHE:O	2.69	0.41
1:H:216:VAL:HG12	1:H:225:LEU:HD22	2.03	0.41
1:B:145:THR:HA	1:B:315:LEU:O	2.20	0.41
1:D:200:TYR:HB2	1:D:201:PRO:HD3	2.02	0.41
1:D:317:ASP:OD1	1:D:318:GLN:N	2.53	0.41
1:H:459:CYS:HA	1:H:496:GLN:OE1	2.21	0.41
1:F:203:SER:HB3	1:F:259:THR:O	2.20	0.41
1:B:144:ILE:O	1:B:314:CYS:HA	2.21	0.41

Continued on next page...

Continued from previous page...

Atom-1	Atom-2	Interatomic distance (Å)	Clash overlap (Å)
1:G:72:ASP:HB3	1:G:79:ARG:CG	2.51	0.41
1:H:220:TYR:O	1:H:283:LYS:CG	2.68	0.41
1:H:404:ASN:O	1:H:408:GLU:HG3	2.21	0.41
1:C:176:LEU:HD21	1:C:207:LEU:HD23	2.03	0.41
1:C:553:VAL:HG11	1:C:555:TYR:CZ	2.55	0.41
1:D:421:ALA:HB2	1:D:425:LEU:HG	2.02	0.41
1:D:476:LYS:HB3	1:D:476:LYS:HE3	1.81	0.41
1:F:553:VAL:HG11	1:F:555:TYR:CZ	2.56	0.41
1:H:421:ALA:HB2	1:H:425:LEU:HG	2.02	0.41
1:C:298:PHE:HB2	1:C:311:ILE:O	2.20	0.41
1:D:240:GLY:O	1:D:244:ALA:CB	2.69	0.41
1:B:157:VAL:HG23	1:B:158:THR:N	2.36	0.40
1:C:73:GLN:HG3	1:C:234:LEU:HD11	2.02	0.40
1:C:259:THR:O	1:C:260:MET:CB	2.69	0.40
1:F:343:LEU:HD21	1:F:462:THR:HG23	2.03	0.40
1:G:515:LEU:HD21	1:G:538:ILE:HD13	2.04	0.40
1:F:404:ASN:HD21	1:F:489:SER:HB2	1.86	0.40
1:G:334:LYS:C	1:G:334:LYS:HD2	2.41	0.40
1:G:366:PHE:CE2	1:G:531:LEU:HD21	2.57	0.40
1:H:166:ILE:HG22	1:H:205:LYS:HE3	2.02	0.40
1:H:258:ARG:NH1	1:H:377:GLU:OE1	2.50	0.40
1:E:582:ARG:HH21	1:E:582:ARG:HD3	1.64	0.40
1:G:456:GLU:HB3	1:G:460:TYR:CE2	2.57	0.40
1:H:156:SER:HB2	1:H:285:LYS:HG3	2.03	0.40

All (1) symmetry-related close contacts are listed below. The label for Atom-2 includes the symmetry operator and encoded unit-cell translations to be applied.

Atom-1	Atom-2	Interatomic distance (Å)	Clash overlap (Å)
1:B:280:ASP:OD2	1:G:184:GLN:NE2[1_455]	2.03	0.17

5.3 Torsion angles [i](#)

5.3.1 Protein backbone [i](#)

In the following table, the Percentiles column shows the percent Ramachandran outliers of the chain as a percentile score with respect to all X-ray entries followed by that with respect to entries of similar resolution.

The Analysed column shows the number of residues for which the backbone conformation was

analysed, and the total number of residues.

Mol	Chain	Analysed	Favoured	Allowed	Outliers	Percentiles	
1	A	510/526 (97%)	495 (97%)	14 (3%)	1 (0%)	47	43
1	B	507/526 (96%)	493 (97%)	13 (3%)	1 (0%)	47	43
1	C	505/526 (96%)	490 (97%)	15 (3%)	0	100	100
1	D	505/526 (96%)	492 (97%)	13 (3%)	0	100	100
1	E	507/526 (96%)	495 (98%)	12 (2%)	0	100	100
1	F	508/526 (97%)	495 (97%)	13 (3%)	0	100	100
1	G	508/526 (97%)	492 (97%)	15 (3%)	1 (0%)	47	43
1	H	507/526 (96%)	490 (97%)	17 (3%)	0	100	100
All	All	4057/4208 (96%)	3942 (97%)	112 (3%)	3 (0%)	51	48

All (3) Ramachandran outliers are listed below:

Mol	Chain	Res	Type
1	A	241	GLY
1	G	241	GLY
1	B	245	GLU

5.3.2 Protein sidechains [i](#)

In the following table, the Percentiles column shows the percent sidechain outliers of the chain as a percentile score with respect to all X-ray entries followed by that with respect to entries of similar resolution.

The Analysed column shows the number of residues for which the sidechain conformation was analysed, and the total number of residues.

Mol	Chain	Analysed	Rotameric	Outliers	Percentiles	
1	A	413/420 (98%)	403 (98%)	10 (2%)	49	49
1	B	410/420 (98%)	402 (98%)	8 (2%)	55	57
1	C	409/420 (97%)	401 (98%)	8 (2%)	55	57
1	D	409/420 (97%)	397 (97%)	12 (3%)	42	41
1	E	409/420 (97%)	398 (97%)	11 (3%)	44	44
1	F	410/420 (98%)	403 (98%)	7 (2%)	60	63
1	G	410/420 (98%)	397 (97%)	13 (3%)	39	37
1	H	409/420 (97%)	401 (98%)	8 (2%)	55	57

Continued on next page...

Continued from previous page...

Mol	Chain	Analysed	Rotameric	Outliers	Percentiles
All	All	3279/3360 (98%)	3202 (98%)	77 (2%)	49 51

All (77) residues with a non-rotameric sidechain are listed below:

Mol	Chain	Res	Type
1	A	66	SER
1	A	73	GLN
1	A	131	SER
1	A	147	GLN
1	A	300	LYS
1	A	334	LYS
1	A	418	PHE
1	A	483	ASP
1	A	560	ARG
1	A	561	LYS
1	B	73	GLN
1	B	178	ARG
1	B	217	LYS
1	B	334	LYS
1	B	368	ARG
1	B	418	PHE
1	B	483	ASP
1	B	530	GLU
1	C	66	SER
1	C	73	GLN
1	C	185	SER
1	C	334	LYS
1	C	411	LEU
1	C	443	GLN
1	C	452	ARG
1	C	509	MET
1	D	73	GLN
1	D	183	ARG
1	D	300	LYS
1	D	334	LYS
1	D	368	ARG
1	D	401	SER
1	D	483	ASP
1	D	493	MET
1	D	509	MET
1	D	560	ARG
1	D	561	LYS

Continued on next page...

Continued from previous page...

Mol	Chain	Res	Type
1	D	582	ARG
1	E	73	GLN
1	E	97	PHE
1	E	184	GLN
1	E	218	GLN
1	E	232	SER
1	E	334	LYS
1	E	368	ARG
1	E	401	SER
1	E	483	ASP
1	E	560	ARG
1	E	561	LYS
1	F	73	GLN
1	F	246	ARG
1	F	252	ASP
1	F	334	LYS
1	F	343	LEU
1	F	368	ARG
1	F	561	LYS
1	G	73	GLN
1	G	92	SER
1	G	246	ARG
1	G	252	ASP
1	G	281	ARG
1	G	282	ASN
1	G	334	LYS
1	G	370	ARG
1	G	452	ARG
1	G	510	ARG
1	G	532	ASP
1	G	551	ARG
1	G	557	LYS
1	H	73	GLN
1	H	185	SER
1	H	227	PHE
1	H	334	LYS
1	H	370	ARG
1	H	452	ARG
1	H	530	GLU
1	H	551	ARG

Sometimes sidechains can be flipped to improve hydrogen bonding and reduce clashes. All (1) such sidechains are listed below:

Mol	Chain	Res	Type
1	A	461	GLN

5.3.3 RNA [i](#)

There are no RNA molecules in this entry.

5.4 Non-standard residues in protein, DNA, RNA chains [i](#)

There are no non-standard protein/DNA/RNA residues in this entry.

5.5 Carbohydrates [i](#)

There are no monosaccharides in this entry.

5.6 Ligand geometry [i](#)

14 ligands are modelled in this entry.

In the following table, the Counts columns list the number of bonds (or angles) for which Mogul statistics could be retrieved, the number of bonds (or angles) that are observed in the model and the number of bonds (or angles) that are defined in the Chemical Component Dictionary. The Link column lists molecule types, if any, to which the group is linked. The Z score for a bond length (or angle) is the number of standard deviations the observed value is removed from the expected value. A bond length (or angle) with $|Z| > 2$ is considered an outlier worth inspection. RMSZ is the root-mean-square of all Z scores of the bond lengths (or angles).

Mol	Type	Chain	Res	Link	Bond lengths			Bond angles		
					Counts	RMSZ	$\# Z > 2$	Counts	RMSZ	$\# Z > 2$
3	GOL	E	602	-	5,5,5	0.26	0	5,5,5	0.30	0
2	PO4	B	601	-	4,4,4	1.85	1 (25%)	6,6,6	0.71	0
3	GOL	H	601	-	5,5,5	0.97	0	5,5,5	1.18	1 (20%)
3	GOL	G	601	-	5,5,5	0.93	0	5,5,5	1.12	1 (20%)
3	GOL	F	602	-	5,5,5	0.81	0	5,5,5	1.18	1 (20%)
2	PO4	E	601	-	4,4,4	1.46	1 (25%)	6,6,6	0.79	0
2	PO4	A	601	-	4,4,4	1.63	1 (25%)	6,6,6	0.50	0
2	PO4	F	601	-	4,4,4	1.94	1 (25%)	6,6,6	0.43	0
3	GOL	A	602	-	5,5,5	0.89	0	5,5,5	1.16	1 (20%)
3	GOL	B	602	-	5,5,5	0.70	0	5,5,5	1.15	1 (20%)
3	GOL	C	602	-	5,5,5	0.80	0	5,5,5	1.15	1 (20%)

Mol	Type	Chain	Res	Link	Bond lengths			Bond angles		
					Counts	RMSZ	# Z > 2	Counts	RMSZ	# Z > 2
2	PO4	D	601	-	4,4,4	0.95	0	6,6,6	0.61	0
2	PO4	C	601	-	4,4,4	0.99	0	6,6,6	0.56	0
3	GOL	D	602	-	5,5,5	0.66	0	5,5,5	1.15	1 (20%)

In the following table, the Chirals column lists the number of chiral outliers, the number of chiral centers analysed, the number of these observed in the model and the number defined in the Chemical Component Dictionary. Similar counts are reported in the Torsion and Rings columns. '-' means no outliers of that kind were identified.

Mol	Type	Chain	Res	Link	Chirals	Torsions	Rings
3	GOL	E	602	-	-	0/4/4/4	-
3	GOL	H	601	-	-	3/4/4/4	-
3	GOL	G	601	-	-	0/4/4/4	-
3	GOL	F	602	-	-	0/4/4/4	-
3	GOL	C	602	-	-	0/4/4/4	-
3	GOL	B	602	-	-	0/4/4/4	-
3	GOL	A	602	-	-	0/4/4/4	-
3	GOL	D	602	-	-	1/4/4/4	-

All (4) bond length outliers are listed below:

Mol	Chain	Res	Type	Atoms	Z	Observed(Å)	Ideal(Å)
2	B	601	PO4	P-O4	-3.29	1.45	1.54
2	F	601	PO4	P-O3	-2.46	1.47	1.54
2	A	601	PO4	P-O2	-2.11	1.48	1.54
2	E	601	PO4	P-O2	-2.05	1.48	1.54

All (7) bond angle outliers are listed below:

Mol	Chain	Res	Type	Atoms	Z	Observed(°)	Ideal(°)
3	D	602	GOL	C3-C2-C1	-2.28	103.42	111.80
3	H	601	GOL	C3-C2-C1	-2.27	103.47	111.80
3	F	602	GOL	C3-C2-C1	-2.24	103.59	111.80
3	B	602	GOL	C3-C2-C1	-2.22	103.67	111.80
3	A	602	GOL	C3-C2-C1	-2.21	103.68	111.80
3	C	602	GOL	C3-C2-C1	-2.18	103.80	111.80
3	G	601	GOL	C3-C2-C1	-2.09	104.15	111.80

There are no chirality outliers.

All (4) torsion outliers are listed below:

Mol	Chain	Res	Type	Atoms
3	H	601	GOL	O1-C1-C2-C3
3	H	601	GOL	O1-C1-C2-O2
3	H	601	GOL	O2-C2-C3-O3
3	D	602	GOL	O2-C2-C3-O3

There are no ring outliers.

2 monomers are involved in 3 short contacts:

Mol	Chain	Res	Type	Clashes	Symm-Clashes
2	A	601	PO4	2	0
2	D	601	PO4	1	0

5.7 Other polymers [i](#)

There are no such residues in this entry.

5.8 Polymer linkage issues [i](#)

There are no chain breaks in this entry.

6 Fit of model and data

6.1 Protein, DNA and RNA chains

In the following table, the column labelled ‘#RSRZ > 2’ contains the number (and percentage) of RSRZ outliers, followed by percent RSRZ outliers for the chain as percentile scores relative to all X-ray entries and entries of similar resolution. The OWAB column contains the minimum, median, 95th percentile and maximum values of the occupancy-weighted average B-factor per residue. The column labelled ‘Q < 0.9’ lists the number of (and percentage) of residues with an average occupancy less than 0.9.

Mol	Chain	Analysed	<RSRZ>	#RSRZ>2	OWAB(Å ²)	Q<0.9
1	A	510/526 (96%)	0.74	87 (17%) 1 1	27, 46, 79, 110	0
1	B	510/526 (96%)	0.49	55 (10%) 5 5	23, 41, 77, 103	0
1	C	509/526 (96%)	0.64	61 (11%) 4 4	27, 46, 79, 138	0
1	D	509/526 (96%)	0.65	67 (13%) 3 2	23, 45, 82, 122	0
1	E	511/526 (97%)	0.70	76 (14%) 2 2	24, 46, 87, 121	0
1	F	512/526 (97%)	0.67	73 (14%) 2 2	26, 44, 81, 155	0
1	G	512/526 (97%)	0.80	77 (15%) 2 2	29, 51, 85, 149	0
1	H	511/526 (97%)	0.95	103 (20%) 1 0	30, 54, 95, 174	0
All	All	4084/4208 (97%)	0.71	599 (14%) 2 2	23, 47, 84, 174	0

All (599) RSRZ outliers are listed below:

Mol	Chain	Res	Type	RSRZ
1	G	541	GLY	12.9
1	H	184	GLN	9.7
1	F	549	ASN	8.3
1	E	550	ALA	8.3
1	A	550	ALA	8.2
1	G	550	ALA	7.7
1	D	459	CYS	7.5
1	F	550	ALA	7.2
1	H	550	ALA	6.8
1	G	157	VAL	6.8
1	G	549	ASN	6.8
1	H	540	GLY	6.5
1	B	469	MET	6.2
1	C	184	GLN	6.2
1	C	182	ALA	6.1
1	C	550	ALA	6.0

Continued on next page...

Continued from previous page...

Mol	Chain	Res	Type	RSRZ
1	D	243	GLN	5.9
1	E	583	GLU	5.8
1	H	541	GLY	5.7
1	C	411	LEU	5.5
1	H	438	LEU	5.3
1	H	157	VAL	5.3
1	H	583	GLU	5.3
1	G	182	ALA	5.2
1	D	182	ALA	5.2
1	H	218	GLN	5.2
1	D	184	GLN	5.1
1	H	102	PRO	5.1
1	H	246	ARG	5.0
1	E	243	GLN	4.9
1	F	583	GLU	4.8
1	G	583	GLU	4.8
1	A	540	GLY	4.8
1	H	182	ALA	4.8
1	C	178	ARG	4.8
1	E	184	GLN	4.8
1	A	127	HIS	4.7
1	E	246	ARG	4.7
1	H	243	GLN	4.7
1	G	227	PHE	4.7
1	D	227	PHE	4.6
1	A	142	ILE	4.6
1	A	184	GLN	4.6
1	F	157	VAL	4.6
1	F	69	GLY	4.6
1	D	242	ALA	4.5
1	E	157	VAL	4.4
1	C	242	ALA	4.4
1	A	551	ARG	4.4
1	A	243	GLN	4.4
1	G	455	LEU	4.4
1	F	541	GLY	4.4
1	A	157	VAL	4.4
1	B	227	PHE	4.4
1	G	551	ARG	4.3
1	B	152	VAL	4.3
1	B	243	GLN	4.3
1	A	561	LYS	4.3

Continued on next page...

Continued from previous page...

Mol	Chain	Res	Type	RSRZ
1	C	453	ALA	4.3
1	E	561	LYS	4.3
1	C	246	ARG	4.3
1	A	152	VAL	4.3
1	H	151	THR	4.3
1	H	206	LEU	4.2
1	F	242	ALA	4.2
1	H	153	VAL	4.2
1	E	142	ILE	4.2
1	H	245	GLU	4.2
1	E	227	PHE	4.2
1	E	282	ASN	4.2
1	F	582	ARG	4.2
1	G	243	GLN	4.2
1	F	227	PHE	4.1
1	H	517	ALA	4.1
1	C	438	LEU	4.1
1	D	283	LYS	4.1
1	G	561	LYS	4.1
1	C	476	LYS	4.1
1	A	206	LEU	4.1
1	G	438	LEU	4.1
1	D	206	LEU	4.0
1	H	455	LEU	4.0
1	G	158	THR	4.0
1	D	282	ASN	4.0
1	F	151	THR	4.0
1	A	438	LEU	4.0
1	H	227	PHE	4.0
1	C	222	GLU	3.9
1	A	223	GLY	3.9
1	F	438	LEU	3.9
1	A	182	ALA	3.9
1	E	182	ALA	3.9
1	G	418	PHE	3.9
1	F	228	GLY	3.9
1	A	539	ALA	3.9
1	E	418	PHE	3.9
1	H	178	ARG	3.9
1	D	152	VAL	3.9
1	B	228	GLY	3.9
1	D	103	LYS	3.9

Continued on next page...

Continued from previous page...

Mol	Chain	Res	Type	RSRZ
1	E	510	ARG	3.9
1	H	242	ALA	3.8
1	E	245	GLU	3.8
1	H	282	ASN	3.8
1	G	184	GLN	3.8
1	H	175	ALA	3.8
1	E	152	VAL	3.8
1	F	517	ALA	3.8
1	H	518	ALA	3.8
1	H	453	ALA	3.8
1	E	144	ILE	3.8
1	H	234	LEU	3.8
1	D	157	VAL	3.8
1	C	261	PHE	3.8
1	A	583	GLU	3.8
1	A	218	GLN	3.8
1	F	243	GLN	3.8
1	D	245	GLU	3.7
1	E	242	ALA	3.7
1	G	454	THR	3.7
1	F	540	GLY	3.7
1	H	222	GLU	3.7
1	G	224	ARG	3.7
1	E	438	LEU	3.7
1	D	438	LEU	3.7
1	E	228	GLY	3.7
1	G	159	GLY	3.7
1	H	223	GLY	3.6
1	H	220	TYR	3.6
1	B	184	GLN	3.6
1	G	218	GLN	3.6
1	A	368	ARG	3.6
1	C	417	VAL	3.6
1	B	282	ASN	3.6
1	D	203	SER	3.6
1	H	418	PHE	3.6
1	H	244	ALA	3.6
1	G	127	HIS	3.5
1	G	206	LEU	3.5
1	H	411	LEU	3.5
1	F	143	GLY	3.5
1	G	181	LYS	3.5

Continued on next page...

Continued from previous page...

Mol	Chain	Res	Type	RSRZ
1	H	152	VAL	3.5
1	C	418	PHE	3.5
1	H	71	ILE	3.5
1	B	583	GLU	3.5
1	A	518	ALA	3.5
1	D	151	THR	3.5
1	A	411	LEU	3.5
1	H	202	SER	3.5
1	F	560	ARG	3.5
1	F	282	ASN	3.5
1	G	151	THR	3.4
1	F	418	PHE	3.4
1	H	104	SER	3.4
1	H	228	GLY	3.4
1	A	102	PRO	3.4
1	C	282	ASN	3.4
1	D	583	GLU	3.4
1	G	536	GLU	3.4
1	H	69	GLY	3.4
1	H	561	LYS	3.4
1	H	221	GLU	3.4
1	A	214	ASP	3.4
1	C	583	GLU	3.4
1	F	152	VAL	3.4
1	C	65	GLY	3.4
1	E	103	LYS	3.4
1	B	453	ALA	3.4
1	B	206	LEU	3.4
1	H	143	GLY	3.4
1	A	224	ARG	3.4
1	H	368	ARG	3.4
1	B	455	LEU	3.4
1	A	510	ARG	3.3
1	G	582	ARG	3.3
1	A	453	ALA	3.3
1	F	142	ILE	3.3
1	G	142	ILE	3.3
1	F	455	LEU	3.3
1	H	582	ARG	3.3
1	C	454	THR	3.3
1	D	228	GLY	3.3
1	H	106	TRP	3.3

Continued on next page...

Continued from previous page...

Mol	Chain	Res	Type	RSRZ
1	F	222	GLU	3.3
1	G	417	VAL	3.3
1	C	218	GLN	3.3
1	D	453	ALA	3.3
1	D	418	PHE	3.3
1	H	224	ARG	3.3
1	F	100	LEU	3.3
1	A	221	GLU	3.3
1	F	102	PRO	3.3
1	D	510	ARG	3.3
1	E	398	PRO	3.3
1	C	450	ILE	3.2
1	F	453	ALA	3.2
1	E	104	SER	3.2
1	B	418	PHE	3.2
1	C	227	PHE	3.2
1	D	455	LEU	3.2
1	D	518	ALA	3.2
1	H	226	ALA	3.2
1	B	203	SER	3.2
1	D	162	LEU	3.2
1	G	185	SER	3.2
1	F	104	SER	3.2
1	E	368	ARG	3.1
1	H	536	GLU	3.1
1	G	202	SER	3.1
1	G	152	VAL	3.1
1	G	518	ALA	3.1
1	E	223	GLY	3.1
1	B	234	LEU	3.1
1	B	438	LEU	3.1
1	E	153	VAL	3.1
1	F	184	GLN	3.1
1	G	261	PHE	3.1
1	G	259	THR	3.0
1	F	459	CYS	3.0
1	E	539	ALA	3.0
1	G	242	ALA	3.0
1	A	454	THR	3.0
1	D	454	THR	3.0
1	E	278	GLY	3.0
1	H	65	GLY	3.0

Continued on next page...

Continued from previous page...

Mol	Chain	Res	Type	RSRZ
1	A	227	PHE	3.0
1	A	553	VAL	3.0
1	E	95	ILE	3.0
1	C	551	ARG	3.0
1	F	368	ARG	3.0
1	C	259	THR	3.0
1	A	222	GLU	3.0
1	F	444	HIS	3.0
1	B	182	ALA	3.0
1	F	399	LYS	3.0
1	H	103	LYS	3.0
1	D	80	PHE	3.0
1	A	171	THR	3.0
1	E	454	THR	3.0
1	E	551	ARG	3.0
1	H	159	GLY	3.0
1	C	398	PRO	3.0
1	C	455	LEU	3.0
1	A	151	THR	2.9
1	A	158	THR	2.9
1	D	303	THR	2.9
1	G	492	CYS	2.9
1	B	242	ALA	2.9
1	E	234	LEU	2.9
1	H	217	LYS	2.9
1	H	454	THR	2.9
1	G	71	ILE	2.9
1	A	560	ARG	2.9
1	C	234	LEU	2.9
1	G	143	GLY	2.9
1	B	151	THR	2.9
1	D	71	ILE	2.9
1	C	243	GLN	2.9
1	D	561	LYS	2.9
1	F	551	ARG	2.9
1	D	480	LEU	2.9
1	E	224	ARG	2.9
1	F	71	ILE	2.9
1	G	559	ASP	2.9
1	H	214	ASP	2.9
1	E	375	ALA	2.9
1	A	455	LEU	2.9

Continued on next page...

Continued from previous page...

Mol	Chain	Res	Type	RSRZ
1	A	68	VAL	2.9
1	F	450	ILE	2.9
1	A	261	PHE	2.9
1	H	557	LYS	2.9
1	F	508	ARG	2.9
1	C	202	SER	2.9
1	F	95	ILE	2.8
1	H	83	PHE	2.8
1	H	277	PHE	2.8
1	E	559	ASP	2.8
1	A	400	PRO	2.8
1	G	510	ARG	2.8
1	H	68	VAL	2.8
1	D	560	ARG	2.8
1	H	565	ARG	2.8
1	B	399	LYS	2.8
1	B	559	ASP	2.8
1	D	302	ALA	2.8
1	D	104	SER	2.8
1	F	454	THR	2.8
1	H	171	THR	2.8
1	A	187	ASP	2.8
1	F	153	VAL	2.8
1	E	106	TRP	2.8
1	H	144	ILE	2.8
1	A	399	LYS	2.8
1	E	582	ARG	2.8
1	E	202	SER	2.8
1	G	453	ALA	2.7
1	H	203	SER	2.7
1	F	206	LEU	2.7
1	A	417	VAL	2.7
1	B	454	THR	2.7
1	E	560	ARG	2.7
1	E	459	CYS	2.7
1	G	98	GLU	2.7
1	E	343	LEU	2.7
1	C	228	GLY	2.7
1	A	71	ILE	2.7
1	B	104	SER	2.7
1	D	202	SER	2.7
1	E	203	SER	2.7

Continued on next page...

Continued from previous page...

Mol	Chain	Res	Type	RSRZ
1	H	521	ALA	2.7
1	F	411	LEU	2.7
1	G	459	CYS	2.7
1	G	555	TYR	2.7
1	E	158	THR	2.7
1	A	450	ILE	2.7
1	E	281	ARG	2.7
1	A	457	ALA	2.7
1	C	539	ALA	2.7
1	F	101	TYR	2.7
1	F	68	VAL	2.7
1	F	144	ILE	2.7
1	A	418	PHE	2.7
1	G	234	LEU	2.7
1	A	245	GLU	2.6
1	C	127	HIS	2.6
1	E	214	ASP	2.6
1	D	536	GLU	2.6
1	F	202	SER	2.6
1	C	157	VAL	2.6
1	C	214	ASP	2.6
1	D	218	GLN	2.6
1	G	398	PRO	2.6
1	A	459	CYS	2.6
1	F	96	GLU	2.6
1	G	451	ALA	2.6
1	C	561	LYS	2.6
1	H	439	PHE	2.6
1	B	458	THR	2.6
1	E	151	THR	2.6
1	B	185	SER	2.6
1	G	95	ILE	2.6
1	E	261	PHE	2.6
1	D	559	ASP	2.6
1	H	216	VAL	2.6
1	E	453	ALA	2.6
1	F	518	ALA	2.6
1	A	104	SER	2.6
1	C	104	SER	2.6
1	D	450	ILE	2.6
1	G	187	ASP	2.6
1	D	207	LEU	2.6

Continued on next page...

Continued from previous page...

Mol	Chain	Res	Type	RSRZ
1	C	401	SER	2.6
1	D	70	SER	2.6
1	A	133	GLY	2.6
1	D	261	PHE	2.6
1	C	206	LEU	2.6
1	D	582	ARG	2.5
1	A	185	SER	2.5
1	E	397	ALA	2.5
1	F	70	SER	2.5
1	H	405	ALA	2.5
1	B	561	LYS	2.5
1	E	411	LEU	2.5
1	A	153	VAL	2.5
1	D	417	VAL	2.5
1	E	143	GLY	2.5
1	A	103	LYS	2.5
1	B	398	PRO	2.5
1	E	439	PHE	2.5
1	G	222	GLU	2.5
1	D	224	ARG	2.5
1	H	158	THR	2.5
1	E	460	TYR	2.5
1	B	142	ILE	2.5
1	H	137	GLU	2.5
1	G	80	PHE	2.5
1	A	183	ARG	2.5
1	D	343	LEU	2.5
1	G	411	LEU	2.5
1	A	398	PRO	2.5
1	E	71	ILE	2.5
1	F	178	ARG	2.5
1	B	539	ALA	2.5
1	F	457	ALA	2.5
1	H	208	TRP	2.5
1	D	127	HIS	2.5
1	H	70	SER	2.5
1	E	450	ILE	2.5
1	F	516	GLY	2.5
1	D	451	ALA	2.5
1	A	209	LEU	2.4
1	B	411	LEU	2.4
1	F	437	THR	2.4

Continued on next page...

Continued from previous page...

Mol	Chain	Res	Type	RSRZ
1	B	560	ARG	2.4
1	G	178	ARG	2.4
1	B	459	CYS	2.4
1	E	369	GLY	2.4
1	D	101	TYR	2.4
1	C	142	ILE	2.4
1	H	539	ALA	2.4
1	C	221	GLU	2.4
1	F	559	ASP	2.4
1	H	532	ASP	2.4
1	A	474	GLY	2.4
1	B	143	GLY	2.4
1	B	106	TRP	2.4
1	B	144	ILE	2.4
1	F	492	CYS	2.4
1	H	142	ILE	2.4
1	B	155	ASP	2.4
1	G	203	SER	2.4
1	A	228	GLY	2.4
1	B	417	VAL	2.4
1	D	230	VAL	2.4
1	B	375	ALA	2.4
1	H	101	TYR	2.4
1	A	225	LEU	2.4
1	A	344	LEU	2.4
1	C	241	GLY	2.4
1	E	540	GLY	2.4
1	G	228	GLY	2.4
1	G	480	LEU	2.4
1	H	529	ARG	2.4
1	F	127	HIS	2.4
1	G	444	HIS	2.4
1	B	401	SER	2.4
1	F	369	GLY	2.4
1	B	100	LEU	2.4
1	G	214	ASP	2.4
1	C	143	GLY	2.4
1	H	95	ILE	2.4
1	D	155	ASP	2.4
1	A	234	LEU	2.3
1	E	206	LEU	2.3
1	H	492	CYS	2.3

Continued on next page...

Continued from previous page...

Mol	Chain	Res	Type	RSRZ
1	A	476	LYS	2.3
1	A	246	ARG	2.3
1	F	510	ARG	2.3
1	G	102	PRO	2.3
1	A	143	GLY	2.3
1	E	222	GLU	2.3
1	B	551	ARG	2.3
1	E	480	LEU	2.3
1	H	560	ARG	2.3
1	A	204	VAL	2.3
1	F	230	VAL	2.3
1	G	221	GLU	2.3
1	H	187	ASP	2.3
1	B	158	THR	2.3
1	B	71	ILE	2.3
1	H	510	ARG	2.3
1	A	69	GLY	2.3
1	A	203	SER	2.3
1	H	230	VAL	2.3
1	C	226	ALA	2.3
1	C	459	CYS	2.3
1	G	563	ALA	2.3
1	H	183	ARG	2.3
1	B	245	GLU	2.3
1	E	102	PRO	2.3
1	C	555	TYR	2.3
1	H	283	LYS	2.3
1	D	97	PHE	2.3
1	B	226	ALA	2.3
1	H	417	VAL	2.3
1	H	444	HIS	2.3
1	G	144	ILE	2.3
1	A	582	ARG	2.3
1	E	207	LEU	2.3
1	A	175	ALA	2.3
1	B	536	GLU	2.3
1	E	437	THR	2.3
1	H	553	VAL	2.3
1	B	105	GLY	2.3
1	E	185	SER	2.3
1	D	144	ILE	2.3
1	B	405	ALA	2.2

Continued on next page...

Continued from previous page...

Mol	Chain	Res	Type	RSRZ
1	E	457	ALA	2.2
1	H	410	VAL	2.2
1	H	127	HIS	2.2
1	E	69	GLY	2.2
1	H	367	GLY	2.2
1	A	193	CYS	2.2
1	G	103	LYS	2.2
1	A	144	ILE	2.2
1	D	142	ILE	2.2
1	E	311	ILE	2.2
1	A	165	ALA	2.2
1	A	186	ALA	2.2
1	A	219	ALA	2.2
1	H	229	THR	2.2
1	A	439	PHE	2.2
1	C	98	GLU	2.2
1	B	157	VAL	2.2
1	D	204	VAL	2.2
1	B	69	GLY	2.2
1	E	399	LYS	2.2
1	A	517	ALA	2.2
1	B	565	ARG	2.2
1	C	518	ALA	2.2
1	C	560	ARG	2.2
1	F	224	ARG	2.2
1	C	103	LYS	2.2
1	B	153	VAL	2.2
1	E	419	VAL	2.2
1	A	375	ALA	2.2
1	B	457	ALA	2.2
1	D	517	ALA	2.2
1	F	186	ALA	2.2
1	F	226	ALA	2.2
1	G	106	TRP	2.2
1	F	159	GLY	2.2
1	H	531	LEU	2.2
1	C	537	SER	2.2
1	C	245	GLU	2.2
1	F	80	PHE	2.2
1	E	178	ARG	2.2
1	C	151	THR	2.2
1	D	234	LEU	2.2

Continued on next page...

Continued from previous page...

Mol	Chain	Res	Type	RSRZ
1	G	560	ARG	2.2
1	C	439	PHE	2.2
1	A	202	SER	2.2
1	G	370	ARG	2.2
1	H	247	PRO	2.2
1	G	450	ILE	2.1
1	H	450	ILE	2.1
1	E	455	LEU	2.1
1	F	106	TRP	2.1
1	A	98	GLU	2.1
1	F	323	VAL	2.1
1	G	223	GLY	2.1
1	B	229	THR	2.1
1	D	150	THR	2.1
1	D	411	LEU	2.1
1	E	344	LEU	2.1
1	A	97	PHE	2.1
1	F	529	ARG	2.1
1	G	368	ARG	2.1
1	H	97	PHE	2.1
1	H	551	ARG	2.1
1	D	175	ALA	2.1
1	C	102	PRO	2.1
1	D	247	PRO	2.1
1	F	103	LYS	2.1
1	C	582	ARG	2.1
1	F	233	TRP	2.1
1	H	185	SER	2.1
1	A	220	TYR	2.1
1	D	219	ALA	2.1
1	A	370[A]	ARG	2.1
1	C	444	HIS	2.1
1	H	508	ARG	2.1
1	A	311	ILE	2.1
1	H	207	LEU	2.1
1	E	68	VAL	2.1
1	G	557	LYS	2.1
1	G	277	PHE	2.1
1	G	439	PHE	2.1
1	H	520	ALA	2.1
1	C	94	GLN	2.1
1	C	492	CYS	2.1

Continued on next page...

Continued from previous page...

Mol	Chain	Res	Type	RSRZ
1	D	98	GLU	2.1
1	C	175	ALA	2.1
1	H	568	ARG	2.1
1	F	439	PHE	2.1
1	D	65	GLY	2.1
1	G	540	GLY	2.1
1	G	565	ARG	2.0
1	H	248	ILE	2.0
1	D	375	ALA	2.0
1	G	363	ALA	2.0
1	H	67	PHE	2.0
1	A	555	TYR	2.0
1	B	369	GLY	2.0
1	F	313	GLY	2.0
1	F	185	SER	2.0
1	C	209	LEU	2.0
1	A	259	THR	2.0
1	C	229	THR	2.0
1	E	405	ALA	2.0
1	F	495	THR	2.0
1	G	219	ALA	2.0
1	G	333	ALA	2.0
1	A	124	GLY	2.0
1	A	369	GLY	2.0
1	E	541	GLY	2.0
1	D	102	PRO	2.0
1	A	444	HIS	2.0
1	G	233	TRP	2.0
1	E	536	GLU	2.0
1	B	171	THR	2.0
1	D	437	THR	2.0
1	F	405	ALA	2.0
1	H	259	THR	2.0
1	H	344	LEU	2.0
1	C	159	GLY	2.0
1	D	68	VAL	2.0
1	E	105	GLY	2.0

6.2 Non-standard residues in protein, DNA, RNA chains

There are no non-standard protein/DNA/RNA residues in this entry.

6.3 Carbohydrates [i](#)

There are no monosaccharides in this entry.

6.4 Ligands [i](#)

In the following table, the Atoms column lists the number of modelled atoms in the group and the number defined in the chemical component dictionary. The B-factors column lists the minimum, median, 95th percentile and maximum values of B factors of atoms in the group. The column labelled 'Q< 0.9' lists the number of atoms with occupancy less than 0.9.

Mol	Type	Chain	Res	Atoms	RSCC	RSR	B-factors(Å ²)	Q<0.9
2	PO4	E	601	5/5	0.76	0.22	56,60,67,67	5
2	PO4	A	601	5/5	0.79	0.23	57,60,66,68	5
2	PO4	B	601	5/5	0.80	0.27	55,57,65,66	5
2	PO4	D	601	5/5	0.82	0.24	53,56,65,69	5
2	PO4	C	601	5/5	0.82	0.29	54,59,64,68	5
2	PO4	F	601	5/5	0.85	0.21	47,51,58,58	5
3	GOL	H	601	6/6	0.95	0.13	32,37,45,45	0
3	GOL	G	601	6/6	0.96	0.10	32,34,40,41	0
3	GOL	A	602	6/6	0.96	0.11	30,34,41,41	0
3	GOL	D	602	6/6	0.97	0.09	24,29,34,34	0
3	GOL	B	602	6/6	0.97	0.08	22,26,31,31	0
3	GOL	C	602	6/6	0.97	0.10	23,26,31,33	0
3	GOL	E	602	6/6	0.98	0.09	32,33,42,46	0
3	GOL	F	602	6/6	0.98	0.07	30,31,39,39	0

6.5 Other polymers [i](#)

There are no such residues in this entry.